

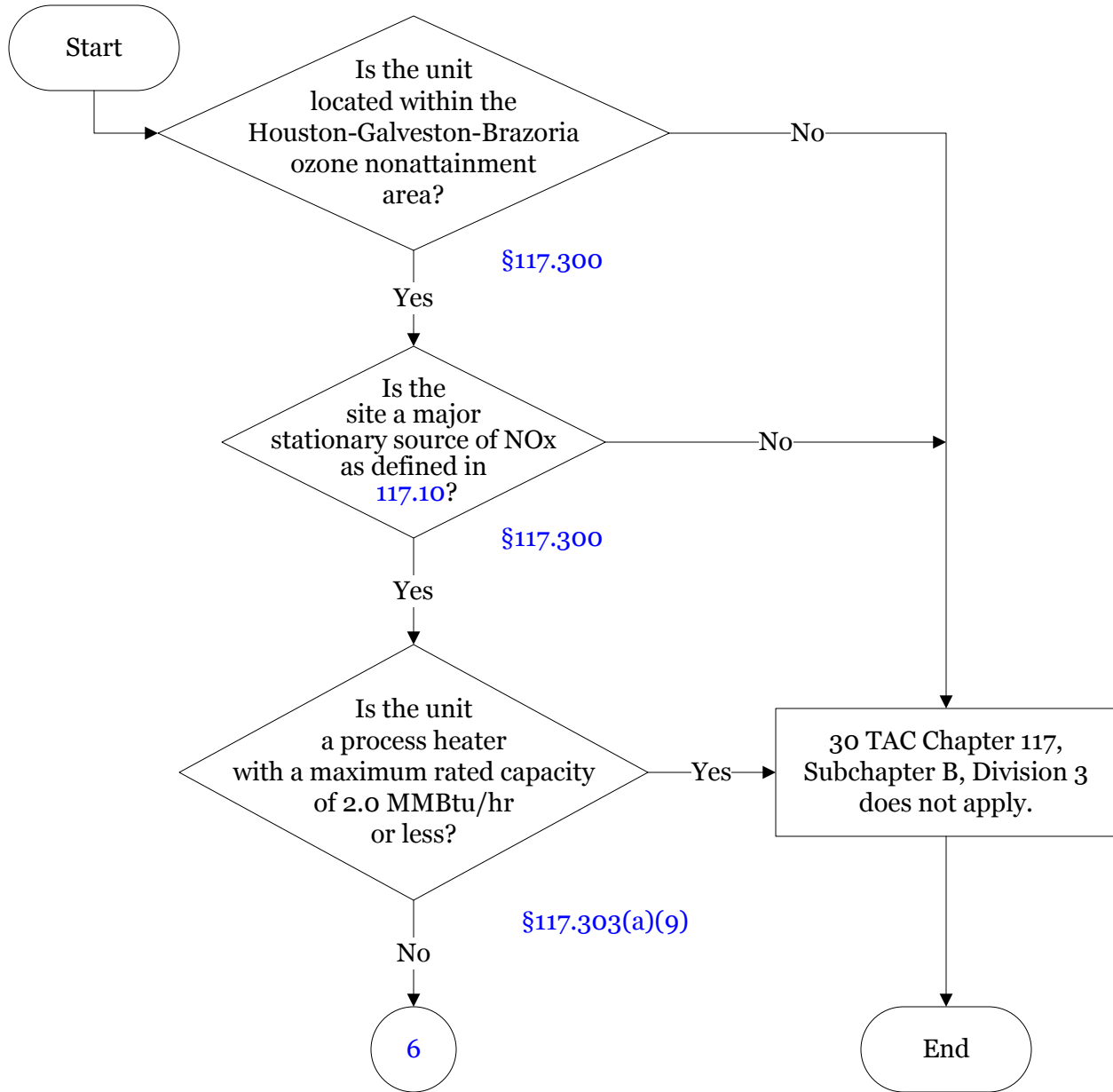

Below is a flowchart describing 30 TAC Ch. 117, Subch. B, Div. 3: Process Heaters. It will likely not be accessible using a screen reader. For the text of the statute/rule, please go to [30 TAC Chapter 117, Subchapter B, Division 3: Process Heaters](#) (1 of 25)

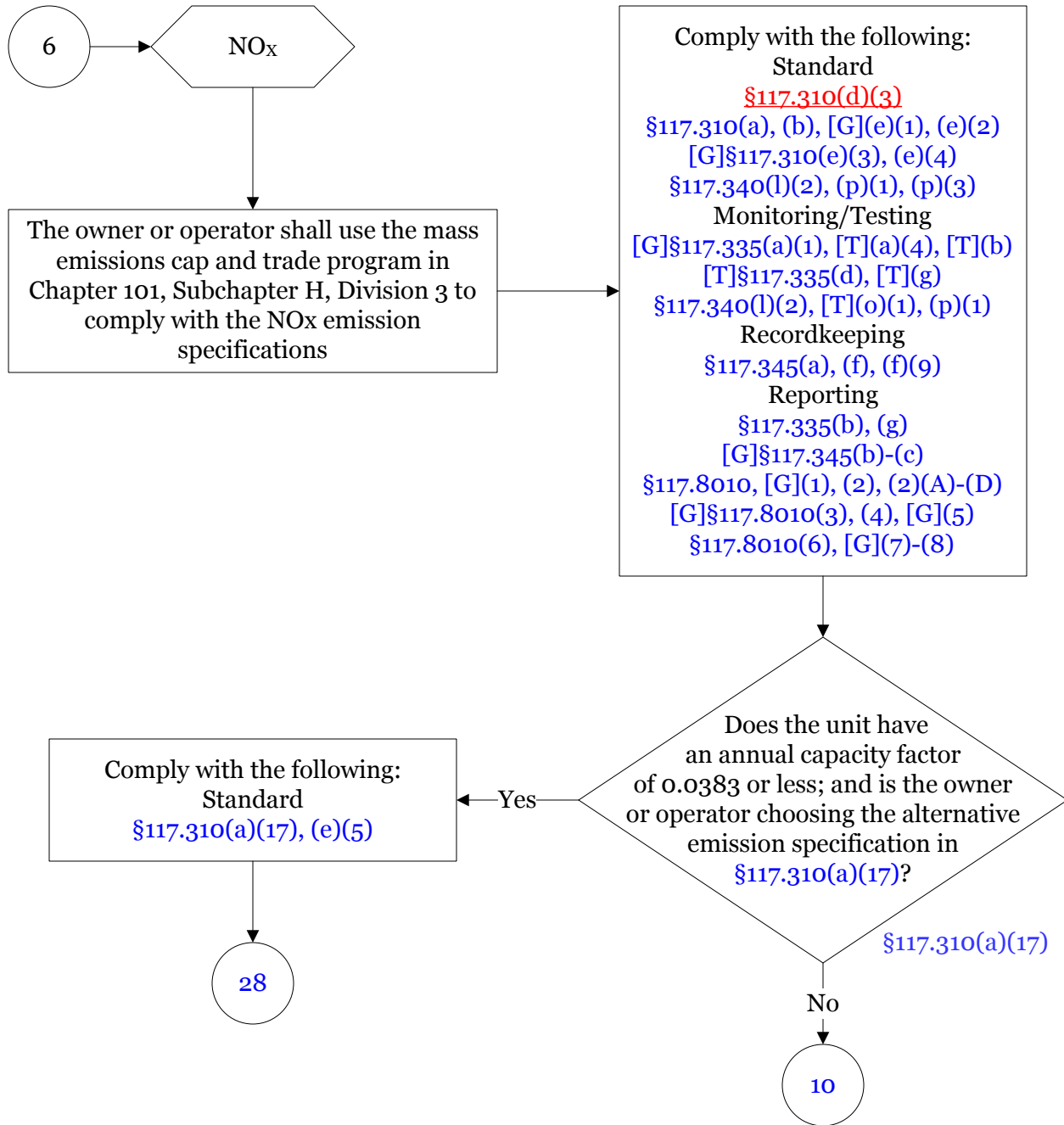

**30 TAC Chapter 117, Subchapter B, Combustion Control at Major ICI,
Division 3, Houston-Galveston-Brazoria Ozone Nonattainment Area:
Process Heaters
(2 of 25)**



**30 TAC Chapter 117, Subchapter B, Combustion Control at Major ICI,
Division 3, Houston-Galveston-Brazoria Ozone Nonattainment Area:
Process Heaters
(3 of 25)**

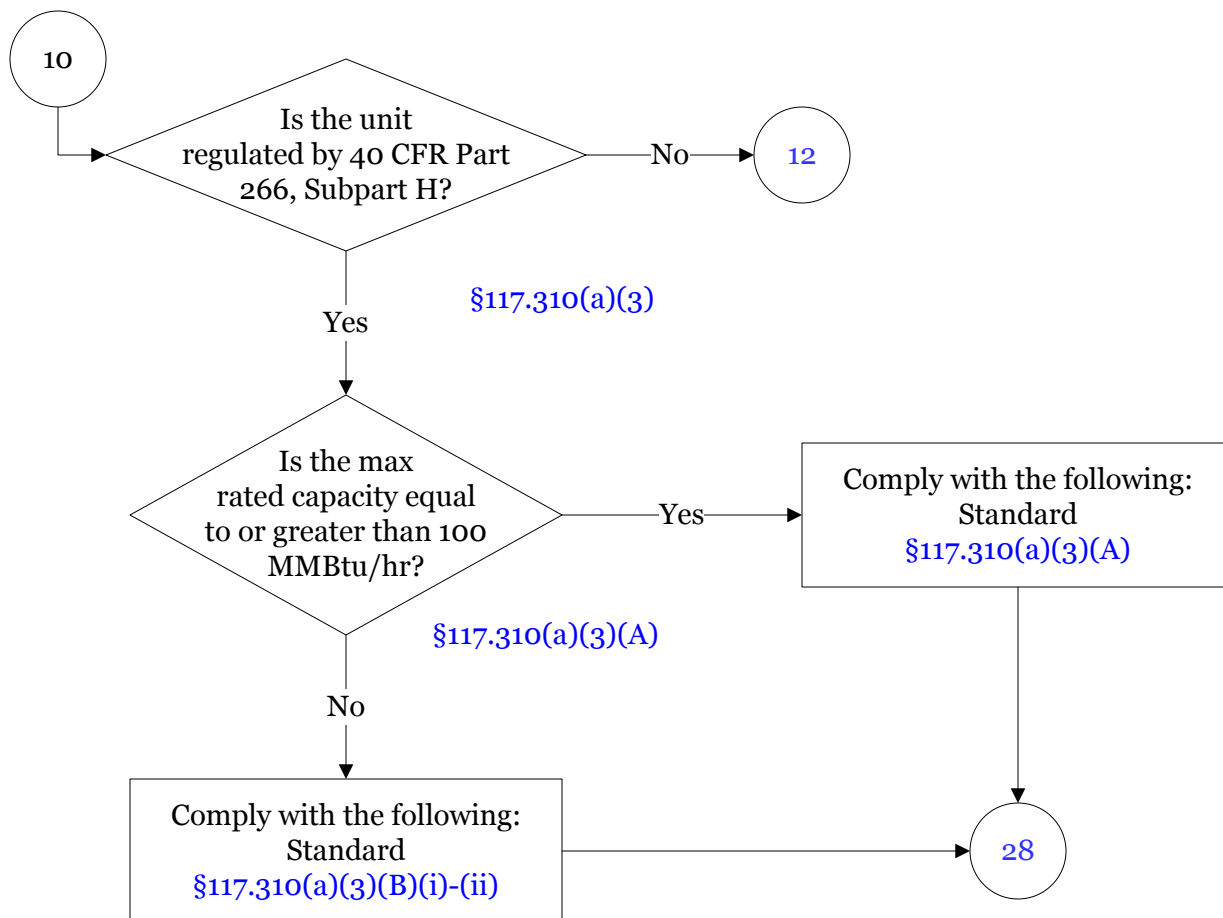

**30 TAC Chapter 117, Subchapter B, Combustion Control at Major ICI,
Division 3, Houston-Galveston-Brazoria Ozone Nonattainment Area:
Process Heaters
(4 of 25)**

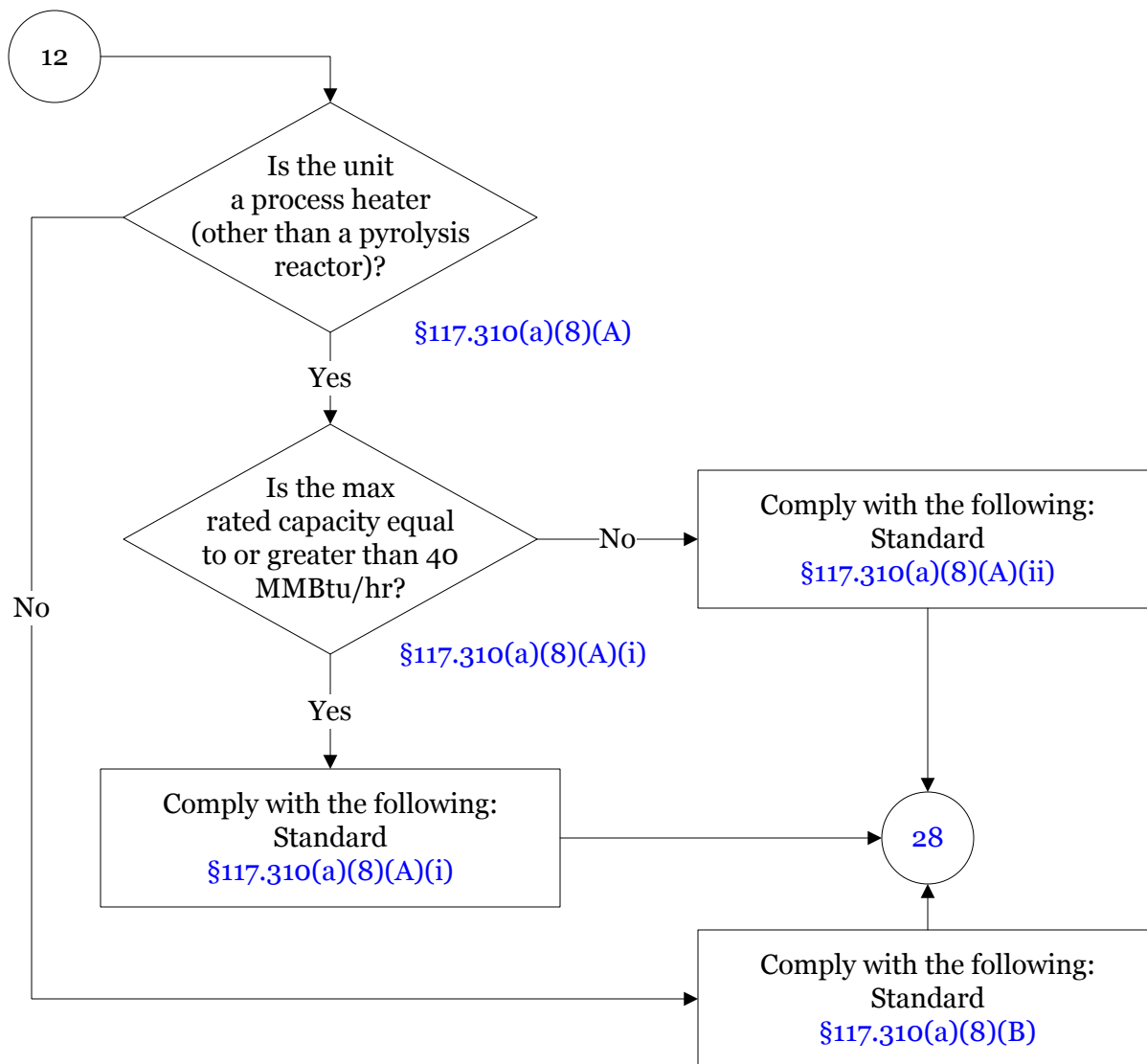

**30 TAC Chapter 117, Subchapter B, Combustion Control at Major ICI,
Division 3, Houston-Galveston-Brazoria Ozone Nonattainment Area:
Process Heaters
(5 of 25)**

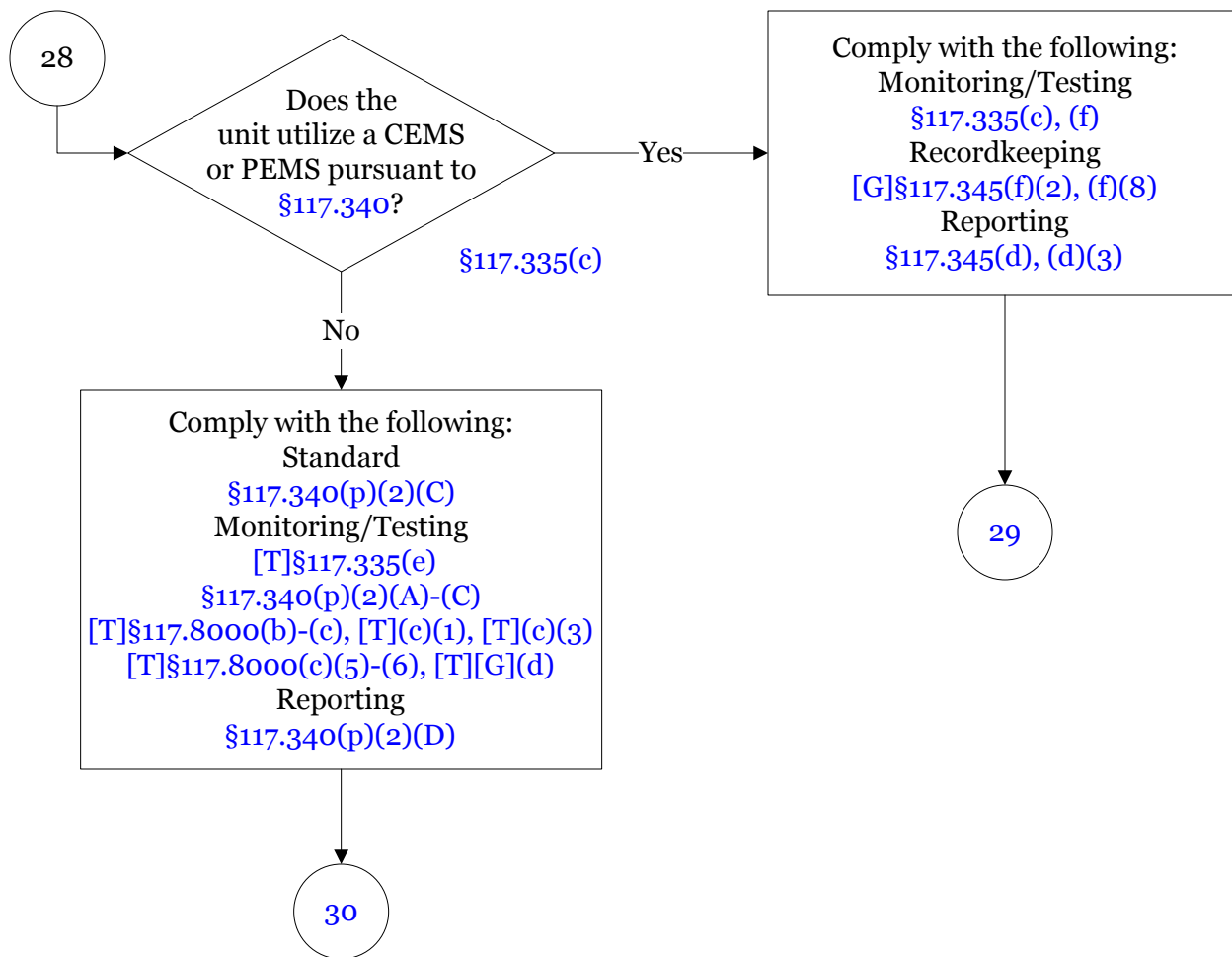

**30 TAC Chapter 117, Subchapter B, Combustion Control at Major ICI,
Division 3, Houston-Galveston-Brazoria Ozone Nonattainment Area:
Process Heaters
(6 of 25)**

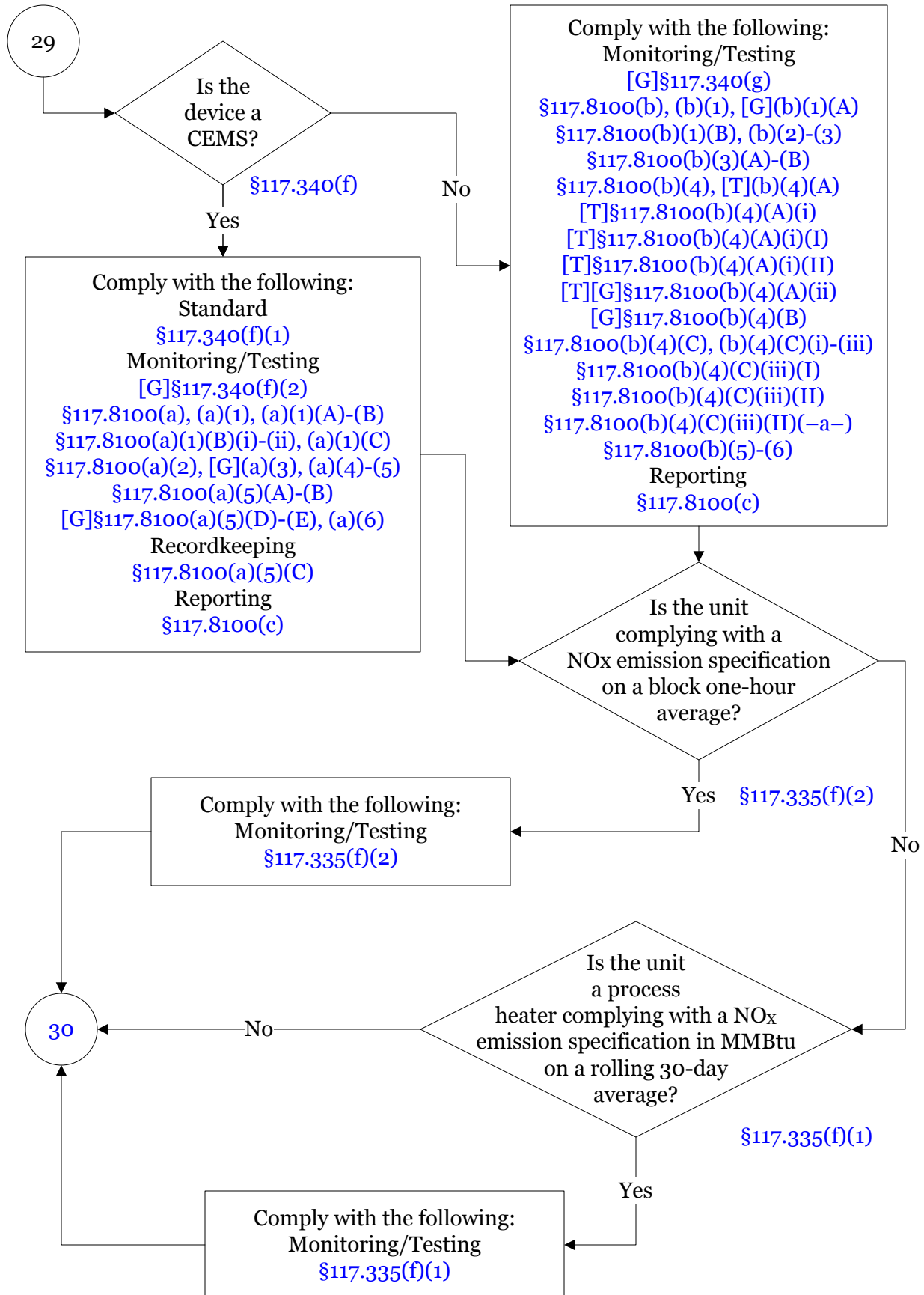

**30 TAC Chapter 117, Subchapter B, Combustion Control at Major ICI,
Division 3, Houston-Galveston-Brazoria Ozone Nonattainment Area:
Process Heaters
(7 of 25)**

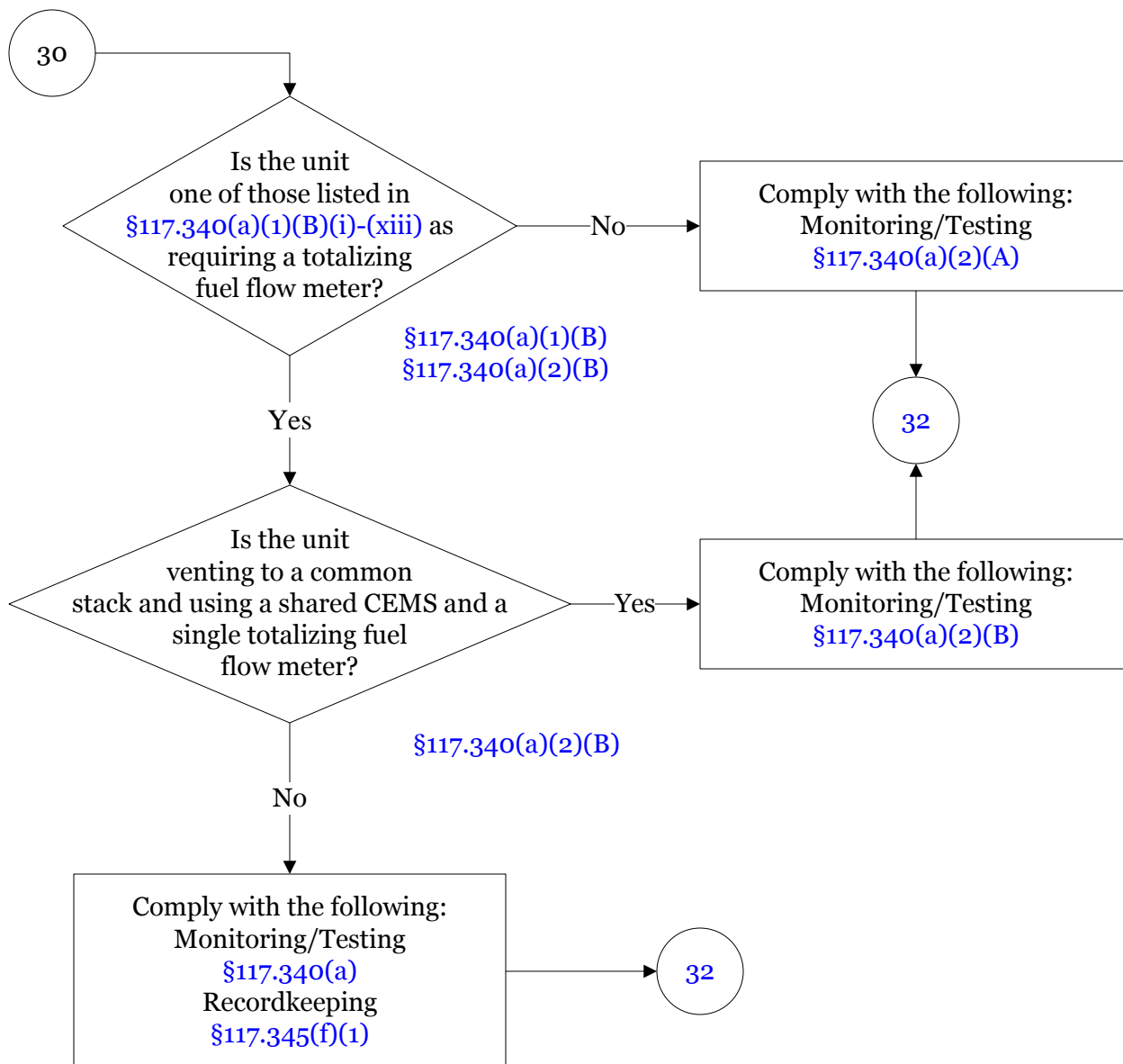

**30 TAC Chapter 117, Subchapter B, Combustion Control at Major ICI,
Division 3, Houston-Galveston-Brazoria Ozone Nonattainment Area:
Process Heaters
(8 of 25)**

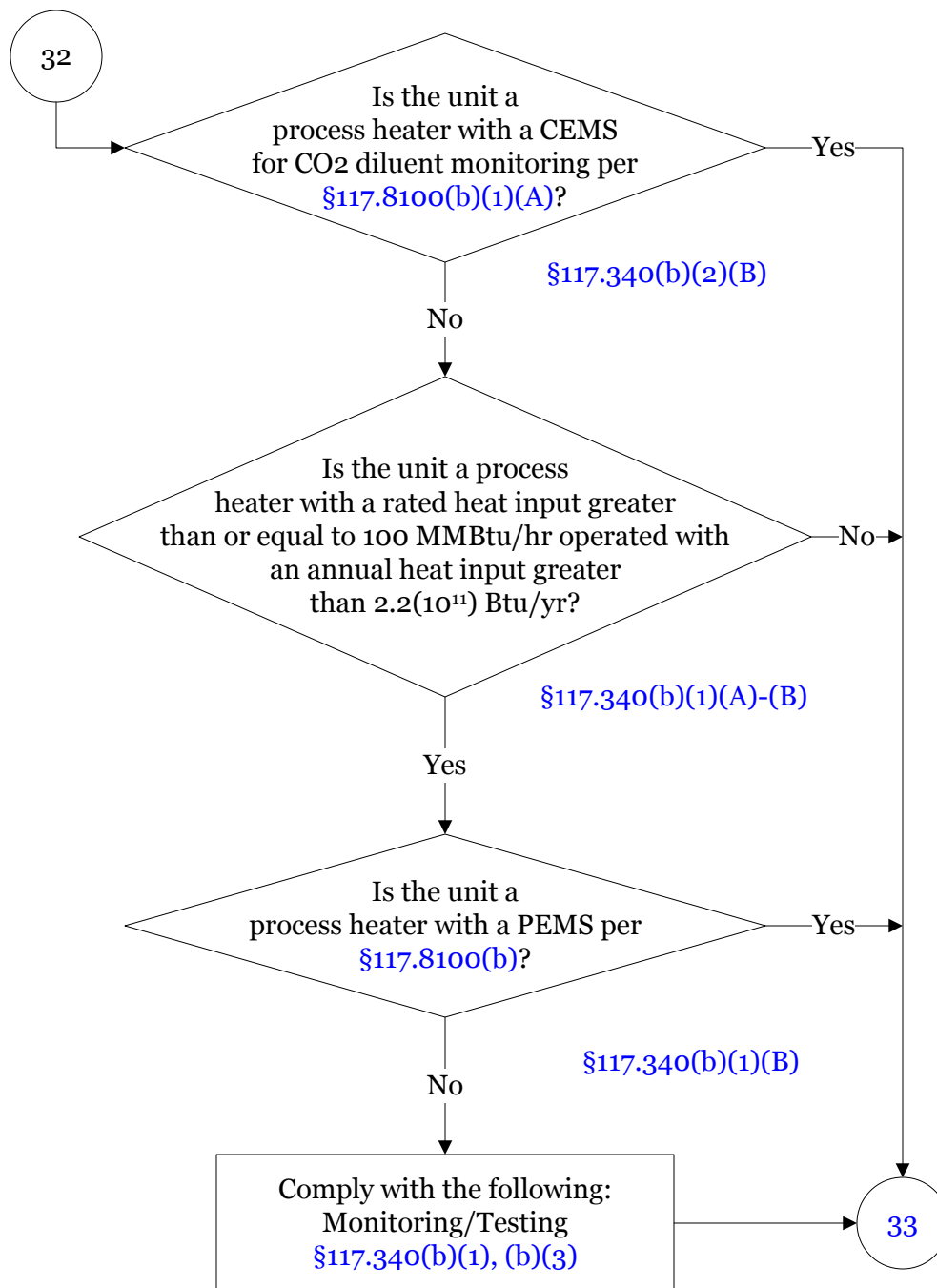

**30 TAC Chapter 117, Subchapter B, Combustion Control at Major ICI,
Division 3, Houston-Galveston-Brazoria Ozone Nonattainment Area:
Process Heaters
(9 of 25)**

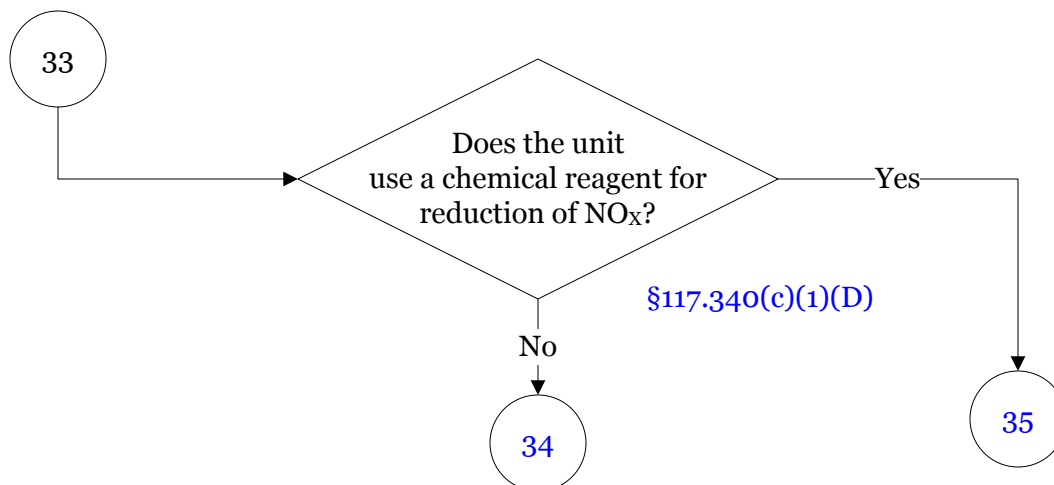

**30 TAC Chapter 117, Subchapter B, Combustion Control at Major ICI,
Division 3, Houston-Galveston-Brazoria Ozone Nonattainment Area:
Process Heaters
(10 of 25)**

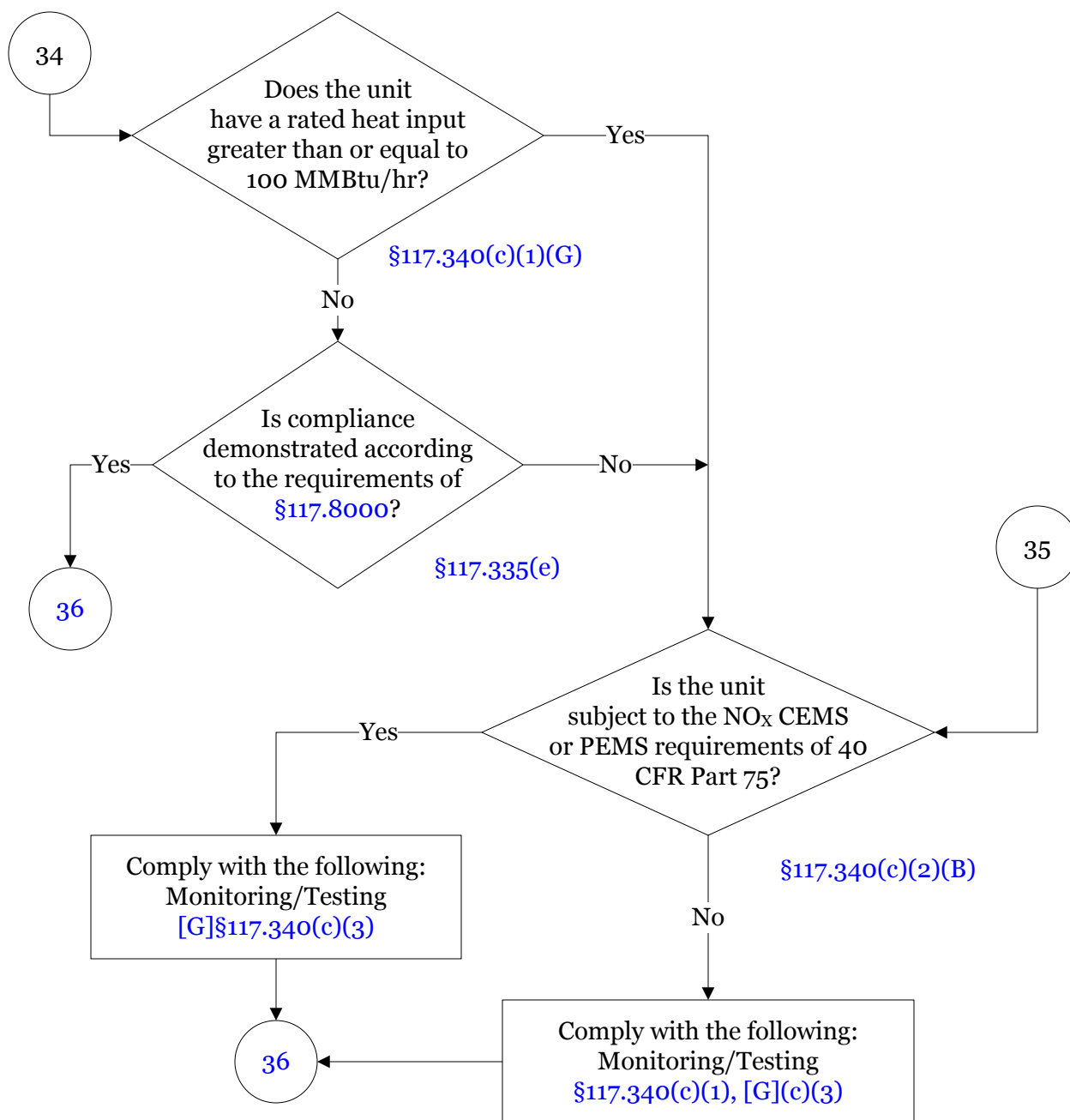

**30 TAC Chapter 117, Subchapter B, Combustion Control at Major ICI,
Division 3, Houston-Galveston-Brazoria Ozone Nonattainment Area:
Process Heaters
(11 of 25)**

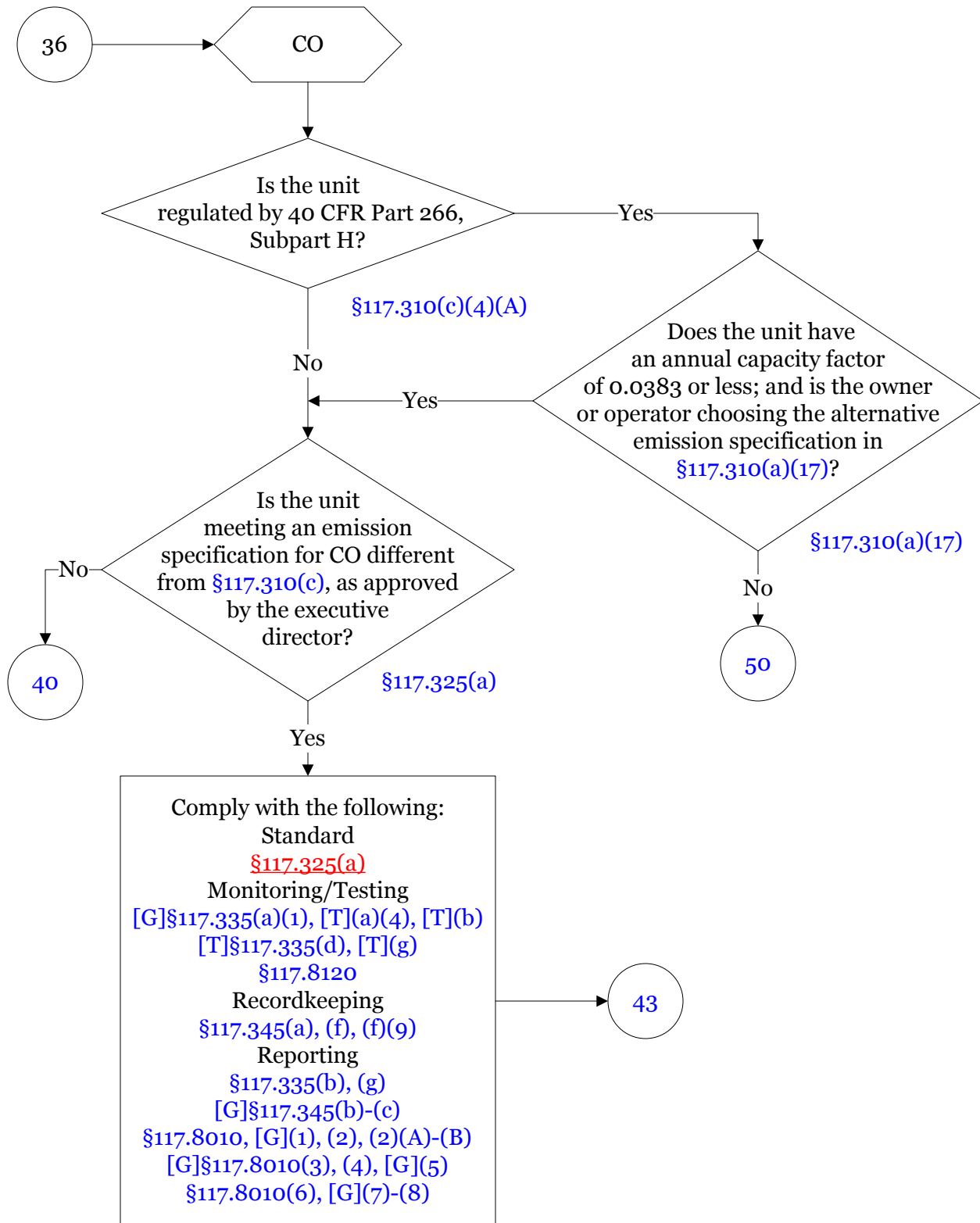

**30 TAC Chapter 117, Subchapter B, Combustion Control at Major ICI,
Division 3, Houston-Galveston-Brazoria Ozone Nonattainment Area:
Process Heaters
(12 of 25)**

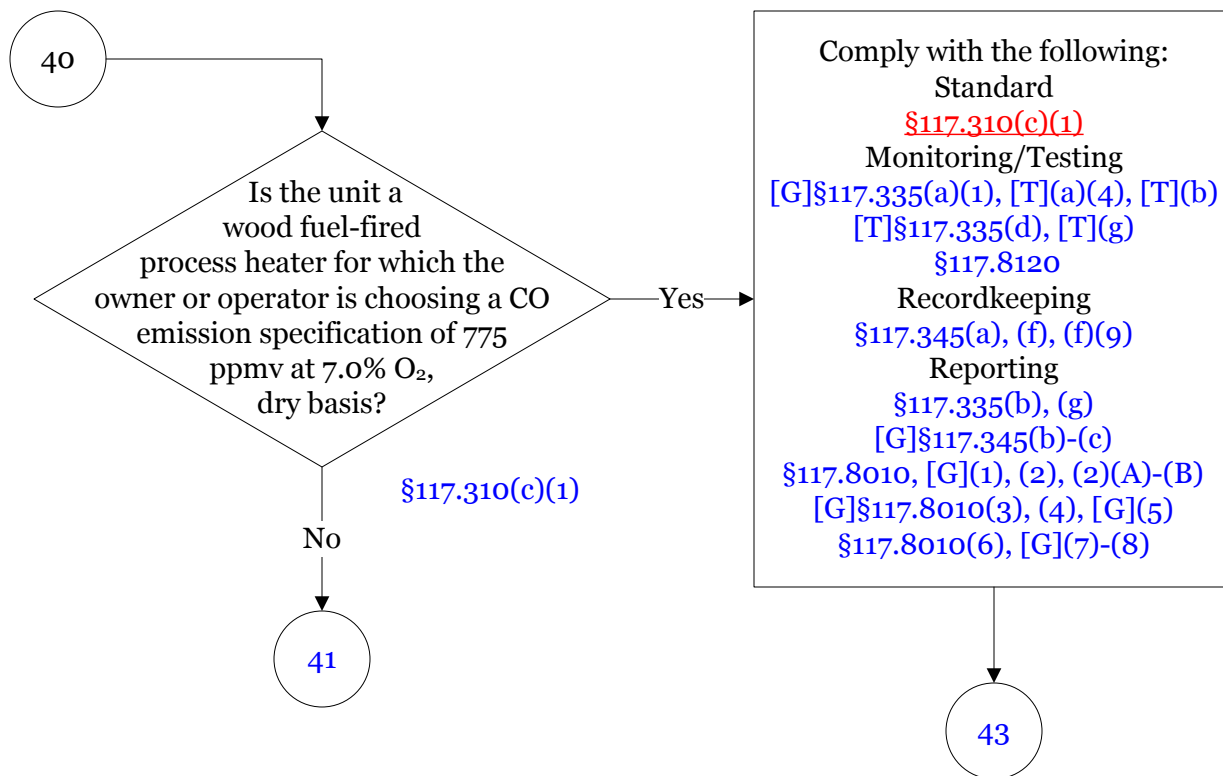

**30 TAC Chapter 117, Subchapter B, Combustion Control at Major ICI,
Division 3, Houston-Galveston-Brazoria Ozone Nonattainment Area:
Process Heaters
(13 of 25)**

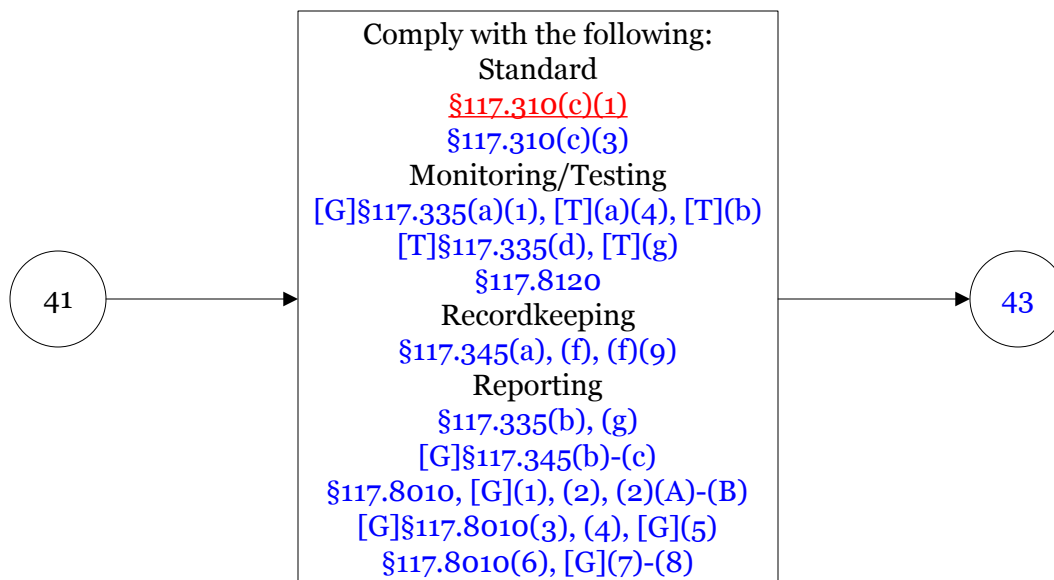

**30 TAC Chapter 117, Subchapter B, Combustion Control at Major ICI,
Division 3, Houston-Galveston-Brazoria Ozone Nonattainment Area:
Process Heaters
(14 of 25)**

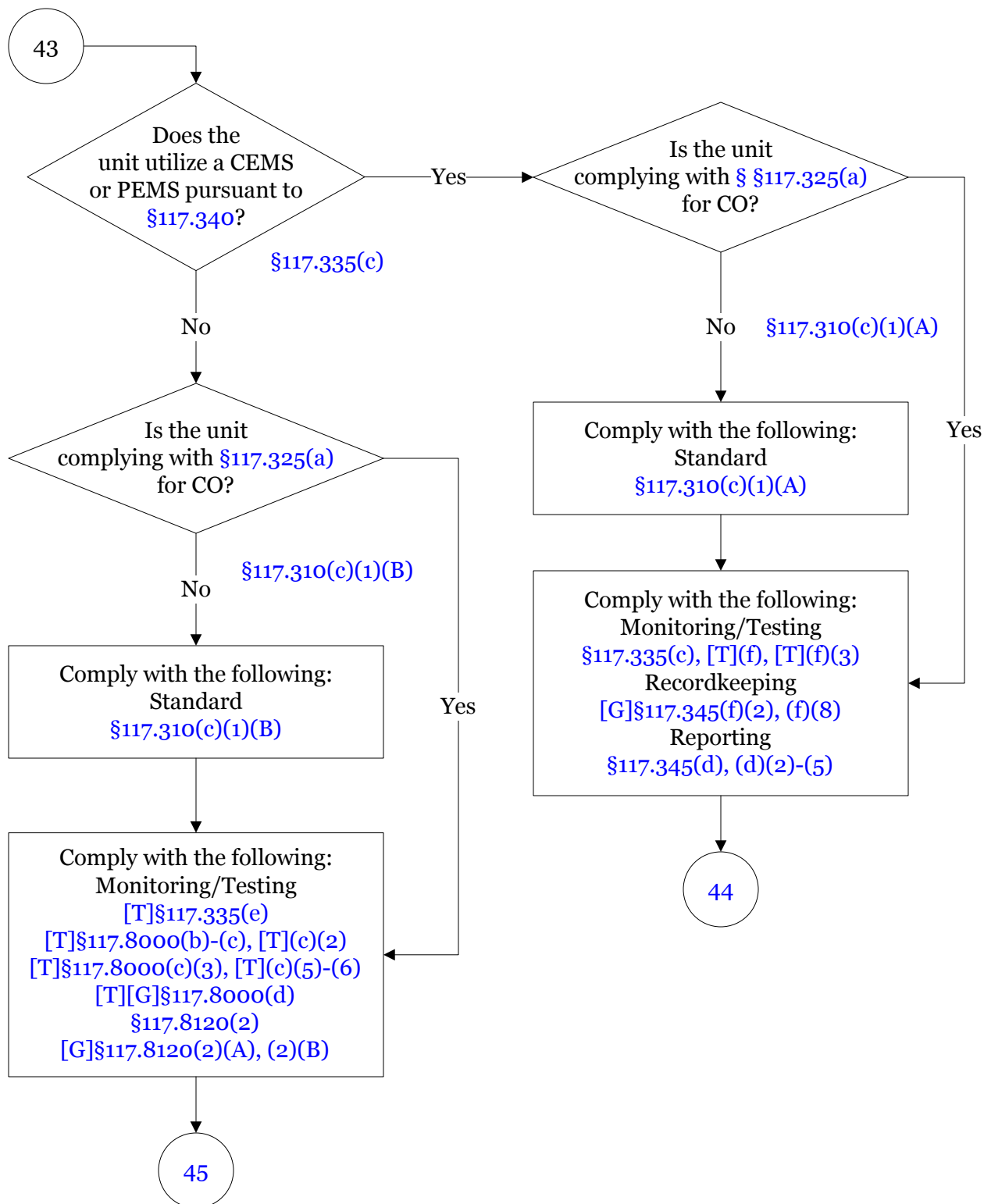

**30 TAC Chapter 117, Subchapter B, Combustion Control at Major ICI,
Division 3, Houston-Galveston-Brazoria Ozone Nonattainment Area:
Process Heaters
(15 of 25)**

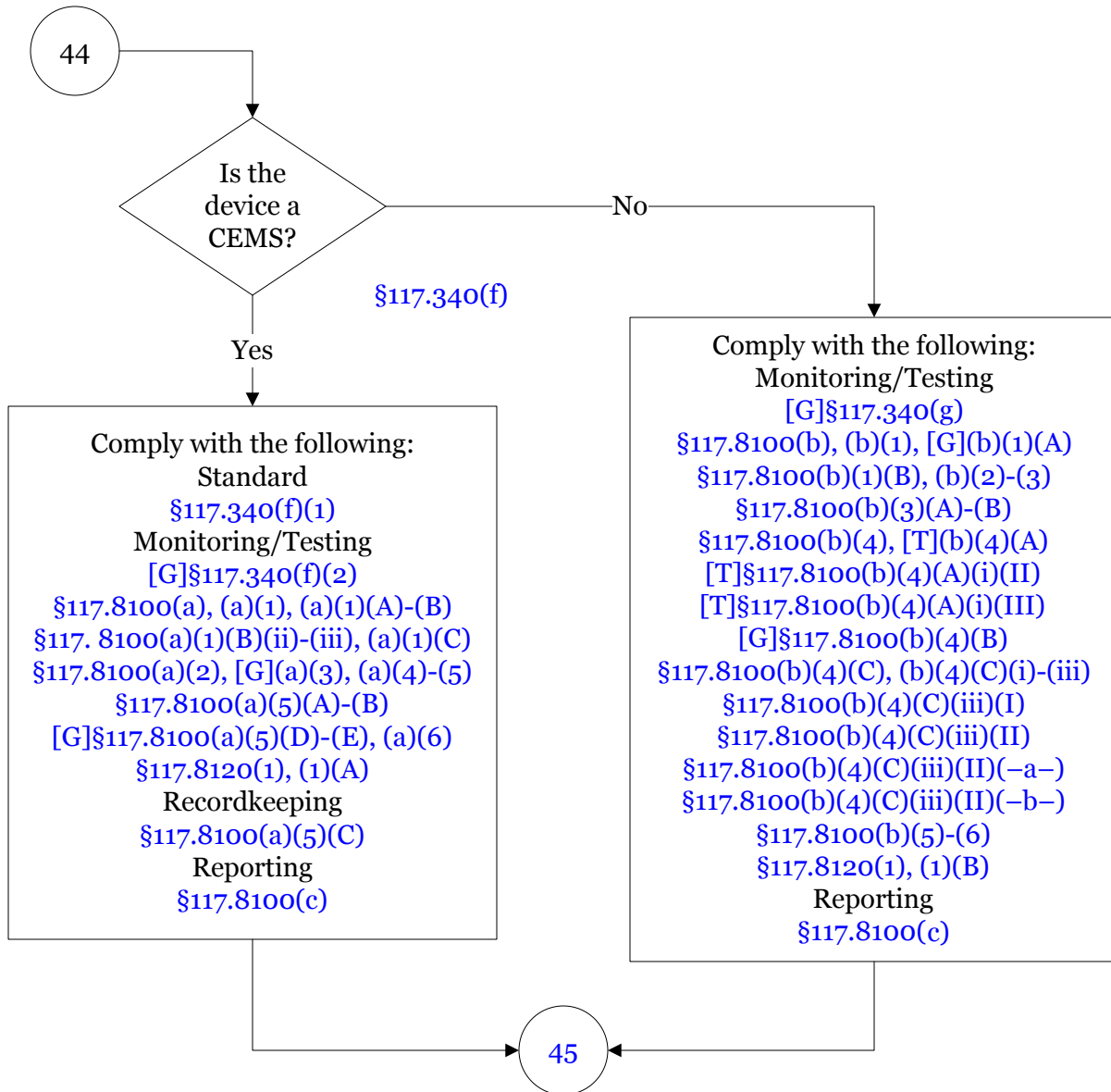

**30 TAC Chapter 117, Subchapter B, Combustion Control at Major ICI,
Division 3, Houston-Galveston-Brazoria Ozone Nonattainment Area:
Process Heaters
(16 of 25)**

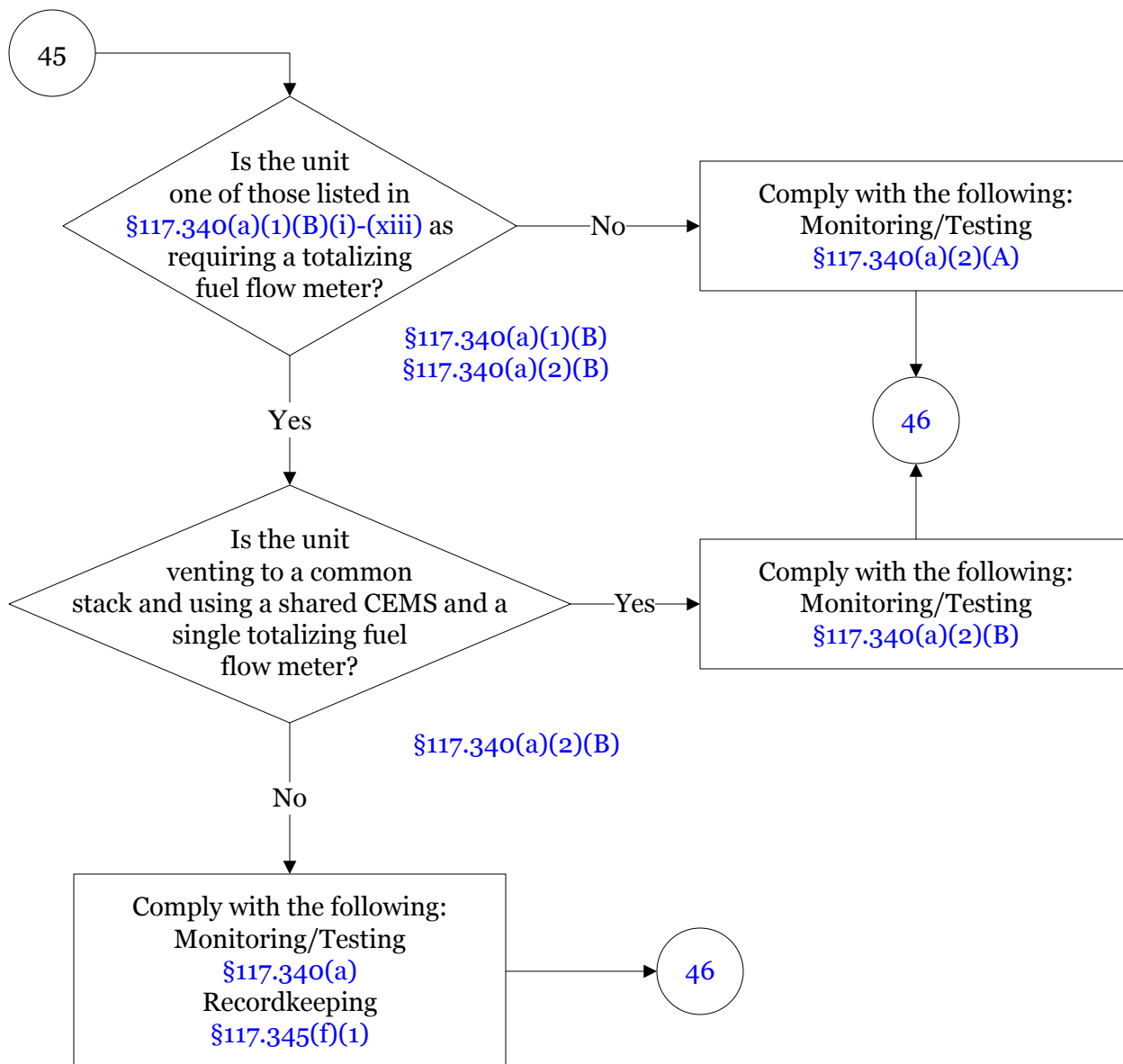

**30 TAC Chapter 117, Subchapter B, Combustion Control at Major ICI,
Division 3, Houston-Galveston-Brazoria Ozone Nonattainment Area:
Process Heaters
(17 of 25)**

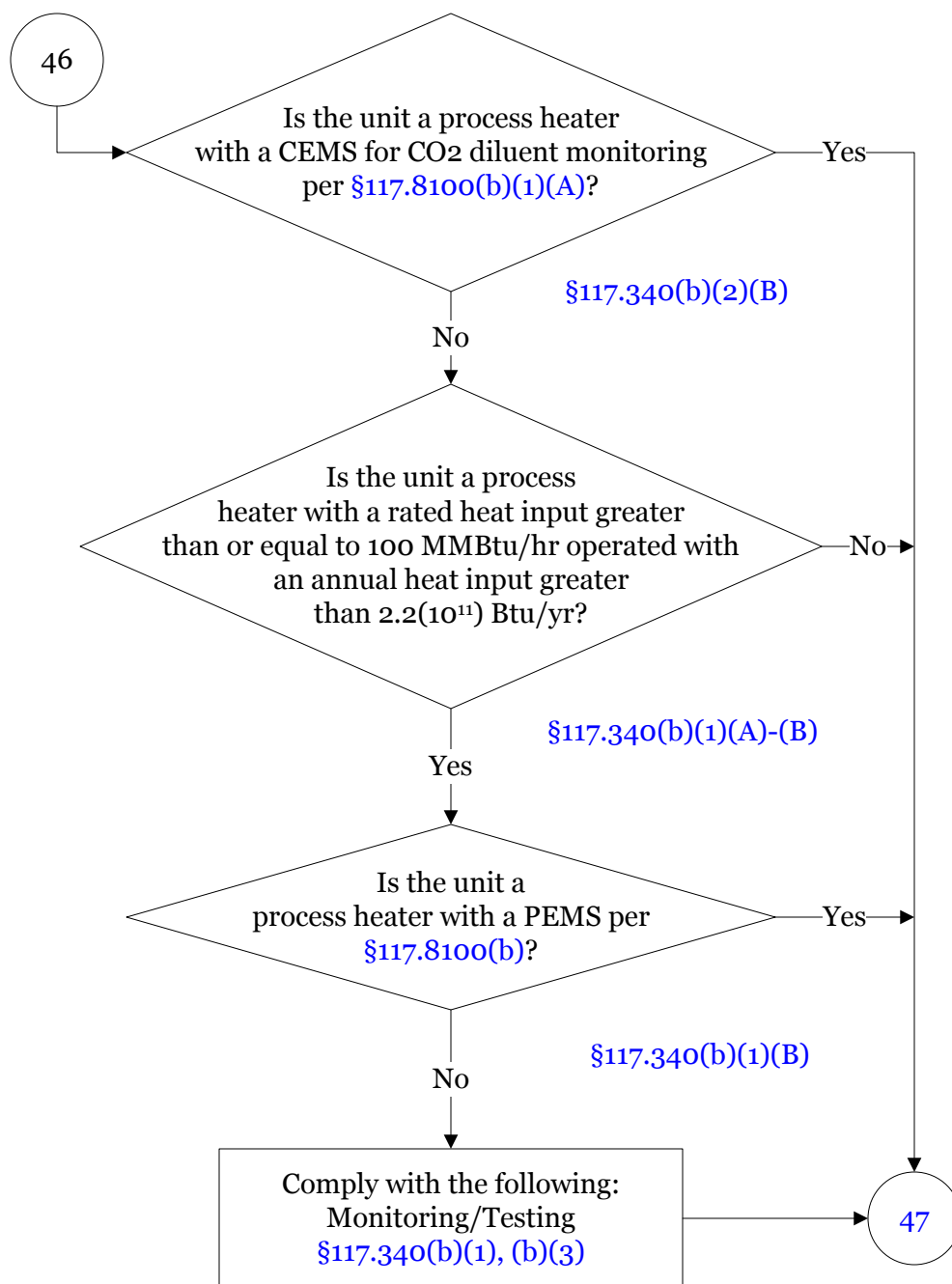

**30 TAC Chapter 117, Subchapter B, Combustion Control at Major ICI,
Division 3, Houston-Galveston-Brazoria Ozone Nonattainment Area:
Process Heaters
(18 of 25)**

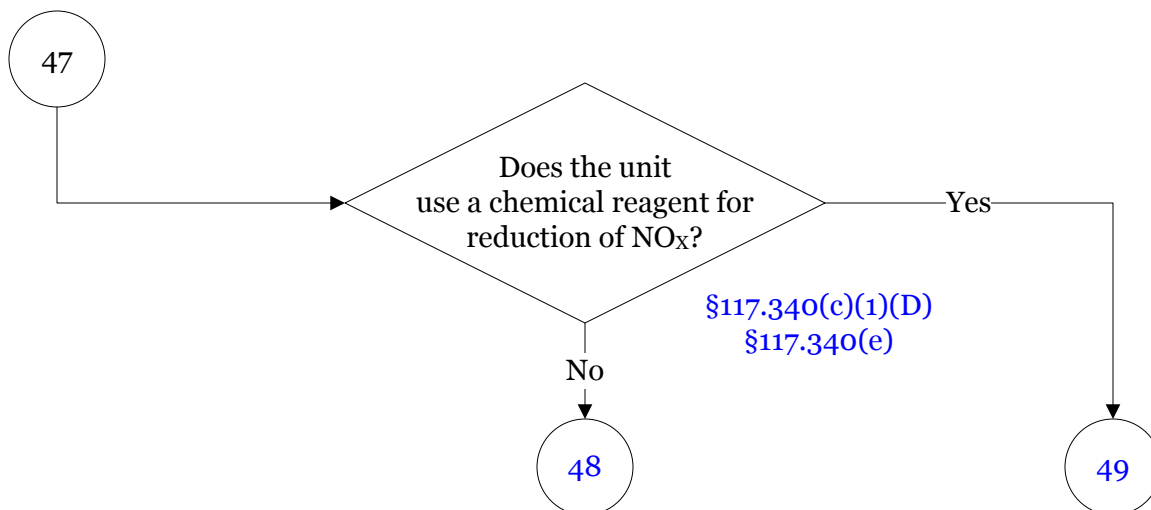

**30 TAC Chapter 117, Subchapter B, Combustion Control at Major ICI,
Division 3, Houston-Galveston-Brazoria Ozone Nonattainment Area:
Process Heaters
(19 of 25)**

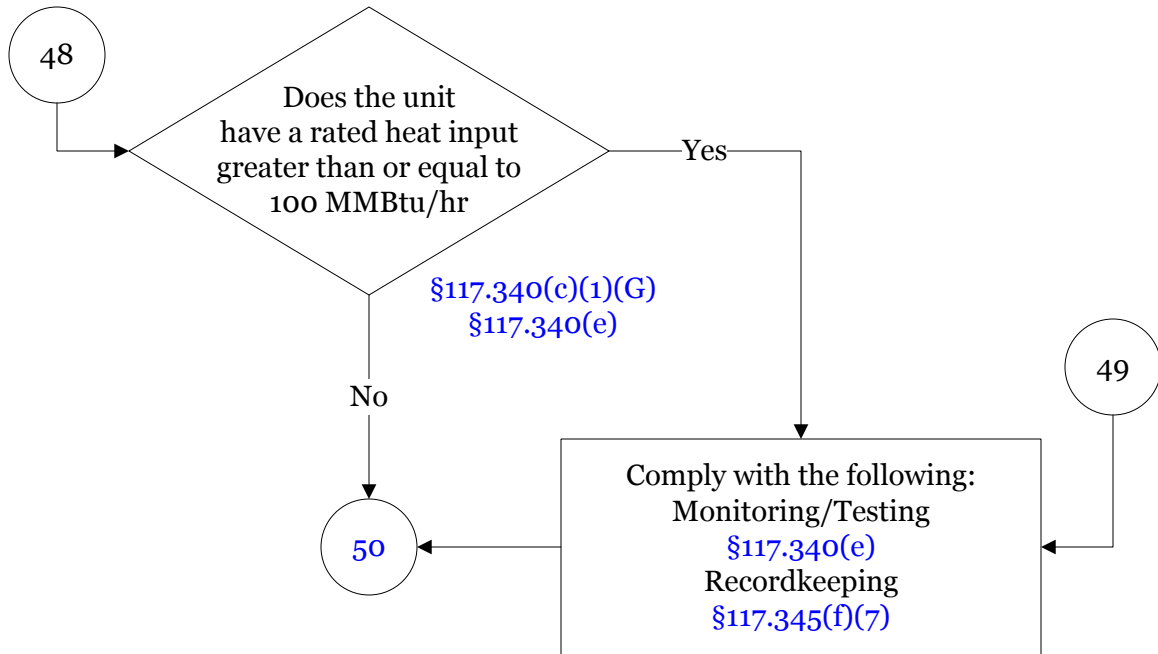

**30 TAC Chapter 117, Subchapter B, Combustion Control at Major ICI,
Division 3, Houston-Galveston-Brazoria Ozone Nonattainment Area:
Process Heaters
(20 of 25)**

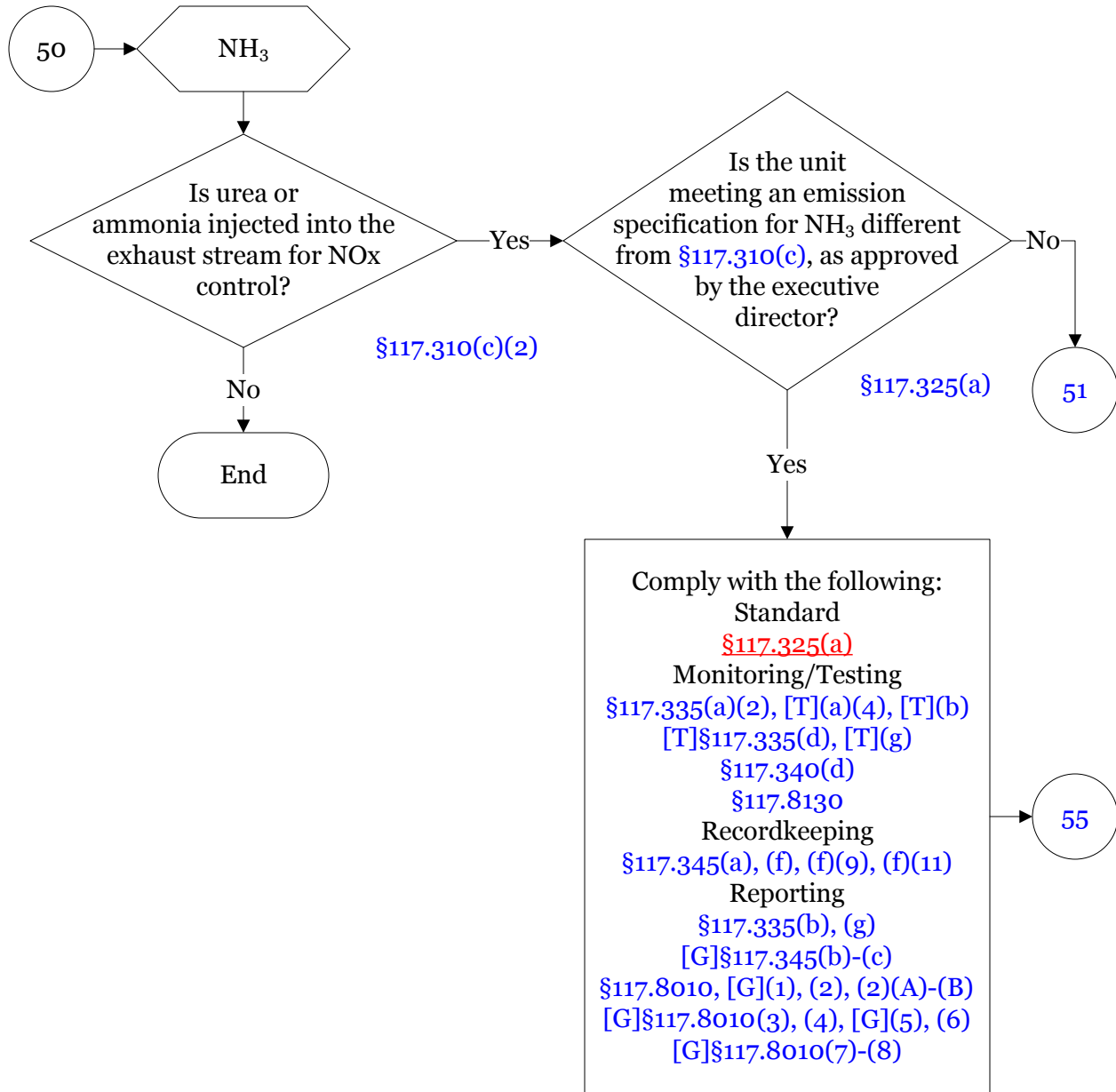

**30 TAC Chapter 117, Subchapter B, Combustion Control at Major ICI,
Division 3, Houston-Galveston-Brazoria Ozone Nonattainment Area:
Process Heaters
(21 of 25)**

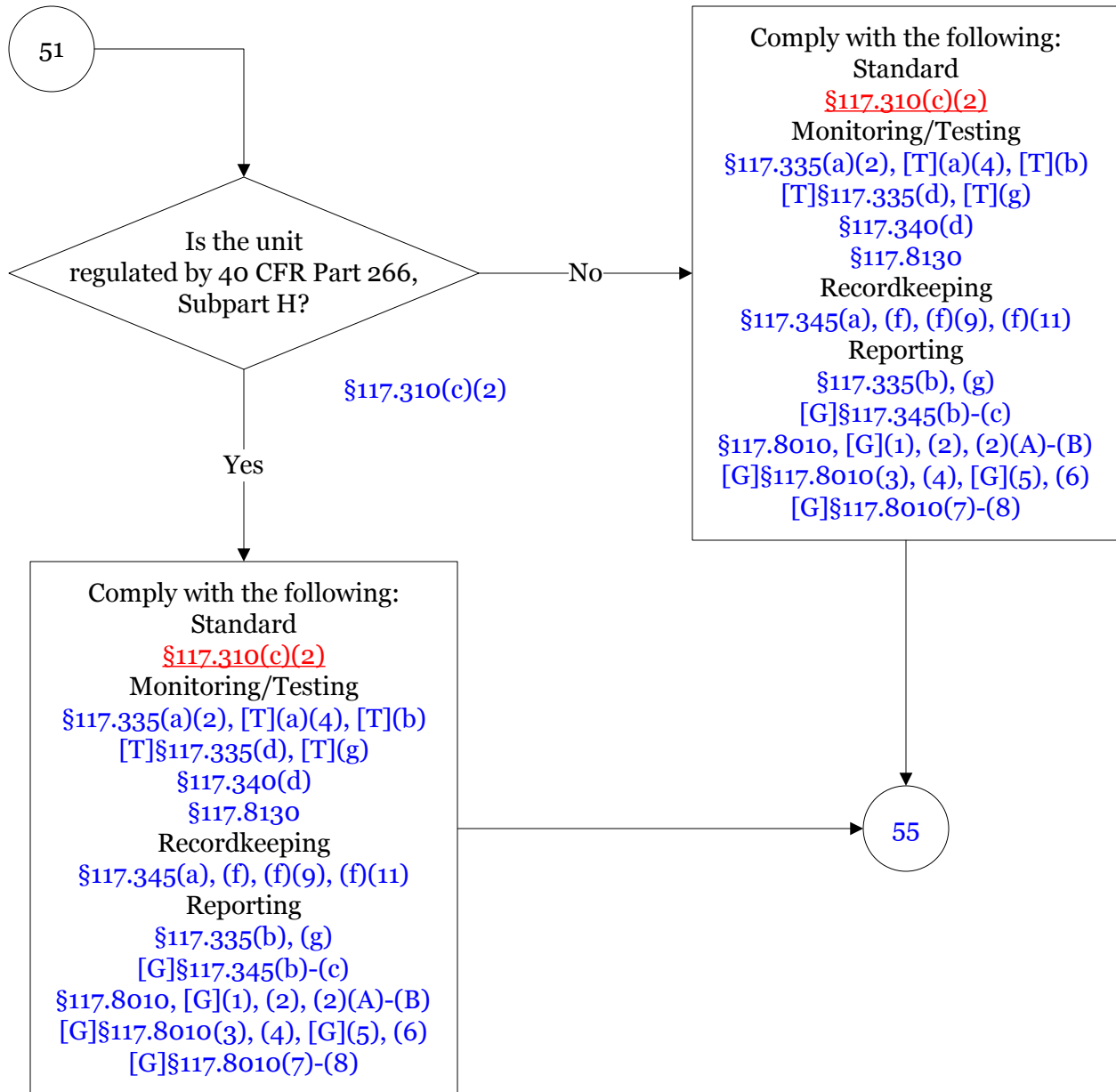

**30 TAC Chapter 117, Subchapter B, Combustion Control at Major ICI,
Division 3, Houston-Galveston-Brazoria Ozone Nonattainment Area:
Process Heaters
(22 of 25)**

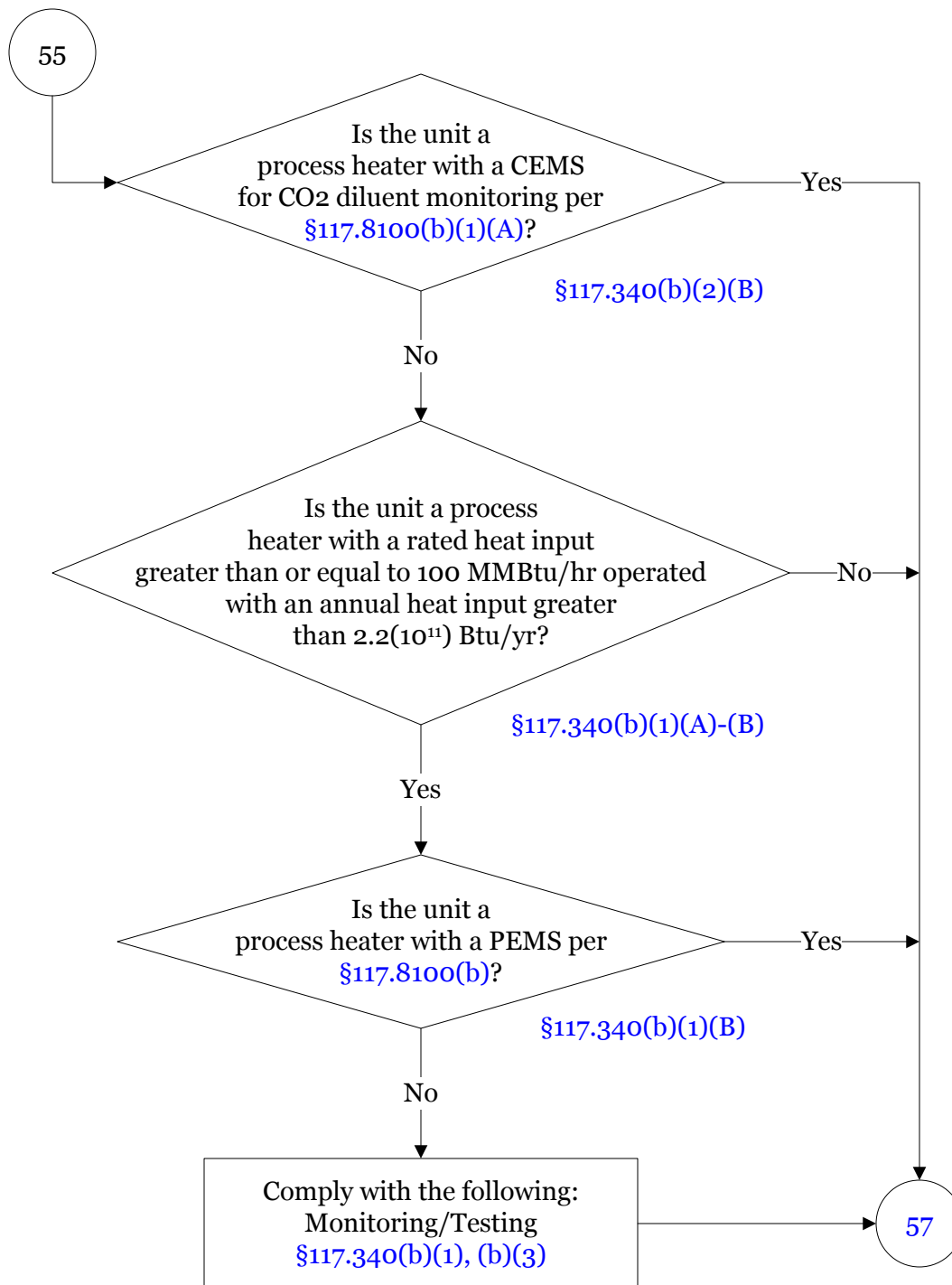

**30 TAC Chapter 117, Subchapter B, Combustion Control at Major ICI,
Division 3, Houston-Galveston-Brazoria Ozone Nonattainment Area:
Process Heaters
(23 of 25)**

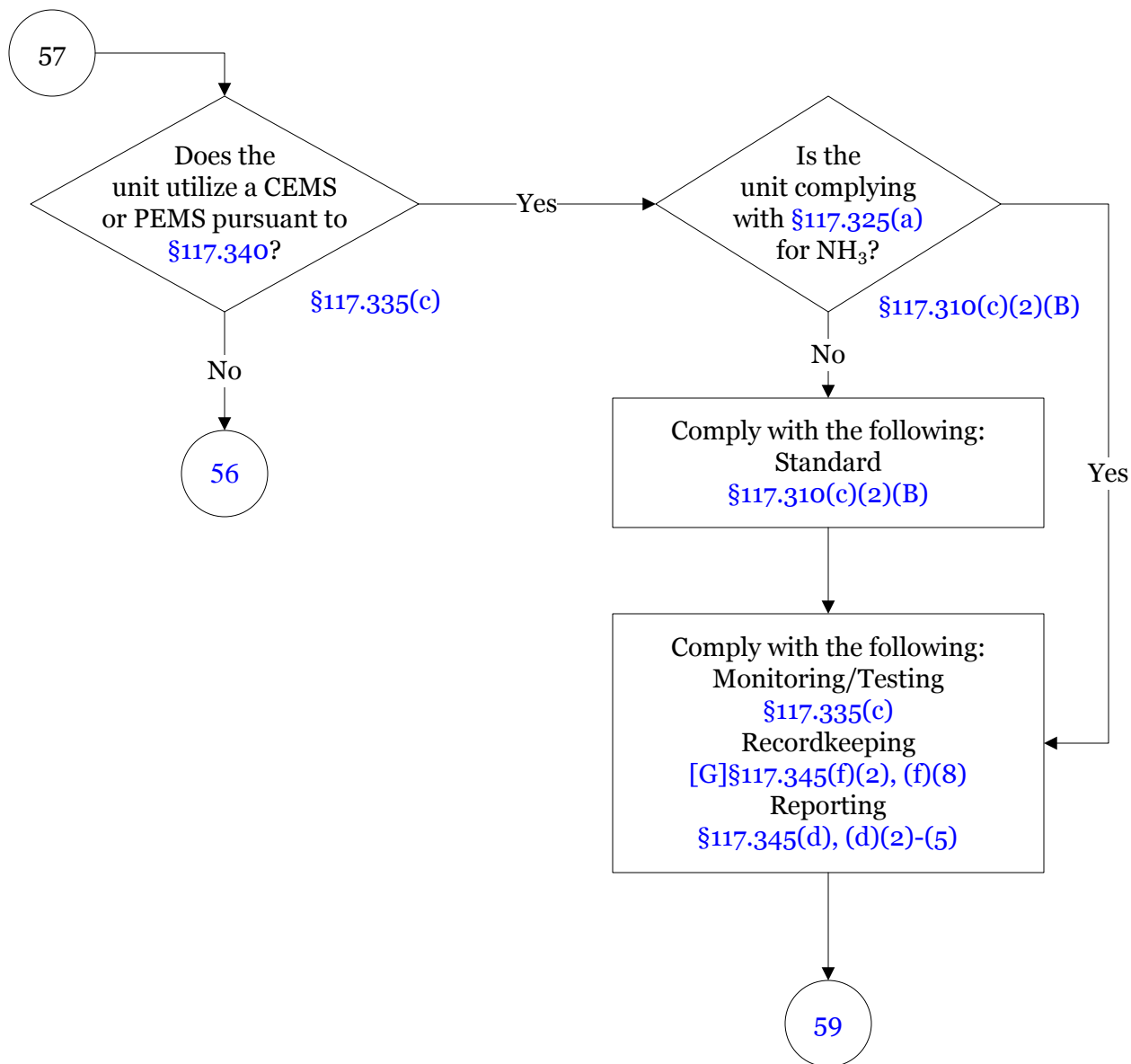

**30 TAC Chapter 117, Subchapter B, Combustion Control at Major ICI,
Division 3, Houston-Galveston-Brazoria Ozone Nonattainment Area:
Process Heaters
(24 of 25)**

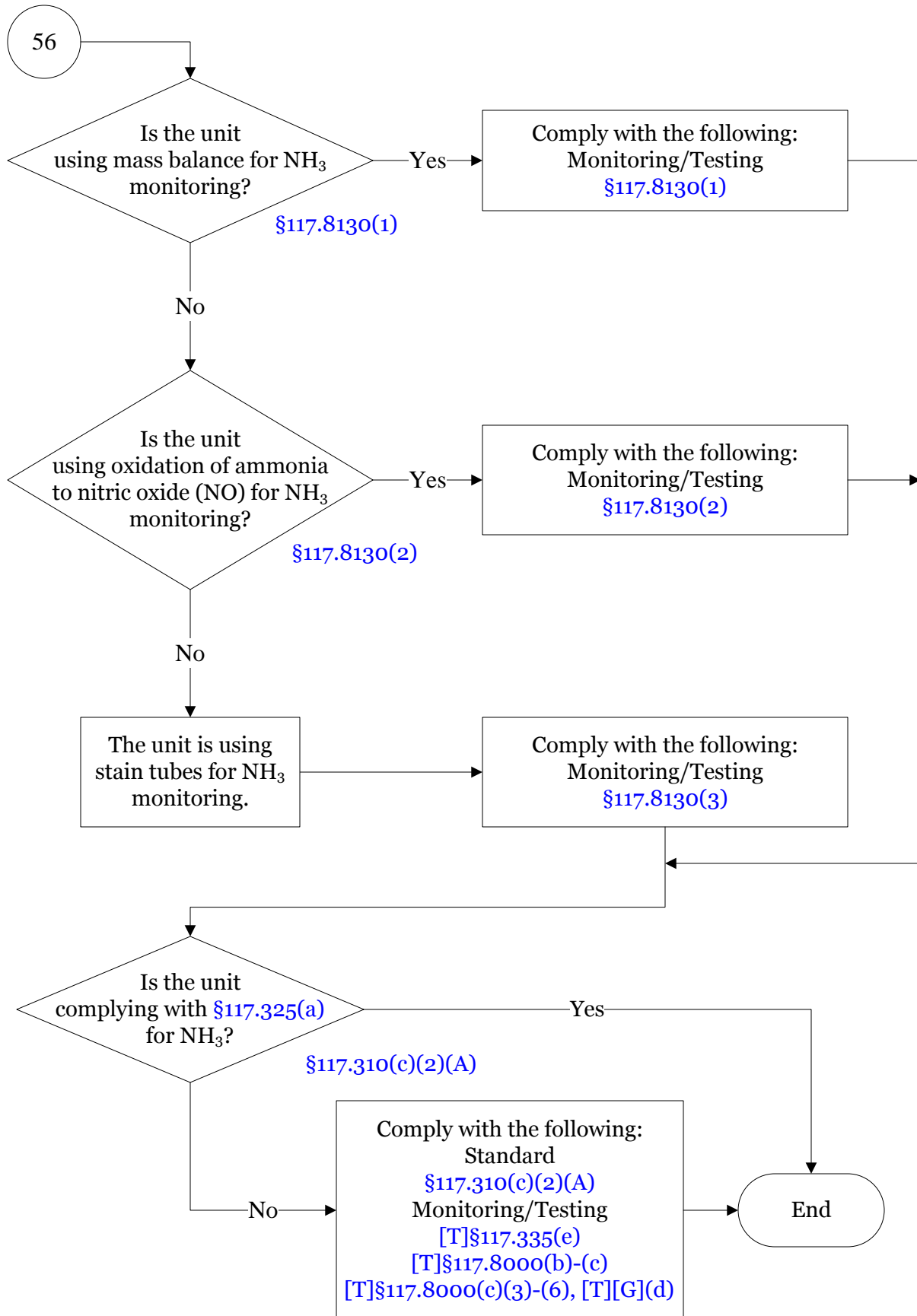

**30 TAC Chapter 117, Subchapter B, Combustion Control at Major ICI,
Division 3, Houston-Galveston-Brazoria Ozone Nonattainment Area:
Process Heaters
(25 of 25)**

