

Texas Commission on Environmental Quality

Title V Existing

5

Site Information (Regulated Entity)

What is the name of the permit area to be authorized?	LEON CREEK PLANT
Does the site have a physical address?	Yes
Physical Address	
Number and Street	7718 QUINTANA RD
City	SAN ANTONIO
State	TX
ZIP	78211
County	BEXAR
Latitude (N) (##.#####)	29.351111
Longitude (W) (-###.#####)	98.575555
Primary SIC Code	4911
Secondary SIC Code	
Primary NAICS Code	221112
Secondary NAICS Code	
Regulated Entity Site Information	
What is the Regulated Entity's Number (RN)?	RN100217439
What is the name of the Regulated Entity (RE)?	CITY PUBLIC SERVICE LEON CREEK PLANT
Does the RE site have a physical address?	Yes
Physical Address	
Number and Street	7718 QUINTANA RD
City	SAN ANTONIO
State	TX
ZIP	78211
County	BEXAR
Latitude (N) (##.#####)	29.350277
Longitude (W) (-###.#####)	-98.574444
Facility NAICS Code	
What is the primary business of this entity?	POWER GENERTION/ELECTRICITY

Customer (Applicant) Information

How is this applicant associated with this site?	Owner Operator
What is the applicant's Customer Number (CN)?	CN600129019
Type of Customer	City Government
Full legal name of the applicant:	
Legal Name	City Public Service Board
Texas SOS Filing Number	
Federal Tax ID	746002071
State Franchise Tax ID	
State Sales Tax ID	

Local Tax ID	
DUNS Number	7936073
Number of Employees	501+
Independently Owned and Operated?	Yes

Responsible Official Contact

Person TCEQ should contact for questions about this application:

Organization Name	CITY PUBLIC SERVICE BOARD
Prefix	MR
First	GREGG
Middle	
Last	TIEKEN
Suffix	
Credentials	
Title	DIRECTOR ENVIRONMENTAL PLANNING AND COMPLIANCE

Enter new address or copy one from list:

Mailing Address	
Address Type	Domestic
Mailing Address (include Suite or Bldg. here, if applicable)	500 MCCULLOUGH AVE
Routing (such as Mail Code, Dept., or Attn:)	
City	SAN ANTONIO
State	TX
ZIP	78215
Phone (###-###-####)	2103532158
Extension	
Alternate Phone (###-###-####)	
Fax (###-###-####)	2103534271
E-mail	grticken@cpsenergy.com

Designated Representative Contact

Person TCEQ should contact for questions about this application:

Select existing DR contact or enter a new contact.	GREGG TIEKEN(CITY PUBLIC SER...)
Organization Name	CITY PUBLIC SERVICE BOARD
Prefix	MR
First	GREGG
Middle	
Last	TIEKEN
Suffix	
Credentials	
Title	DIRECTOR ENVIRONMENTAL PLANNING AND COMPLIANCE

Enter new address or copy one from list:

Mailing Address	
Address Type	Domestic

Mailing Address (include Suite or Bldg. here, if applicable)	500 MCCULLOUGH AVE
Routing (such as Mail Code, Dept., or Attn:)	
City	SAN ANTONIO
State	TX
Zip	78215
Phone (###-###-####)	2103532158
Extension	
Alternate Phone (###-###-####)	
Fax (###-###-####)	2103534271
E-mail	grtieken@cpsenergy.com

Alternate Designated Representative Contact

Person TCEQ should contact for questions about this application:

Select existing ADR contact or enter a new contact.

New Contact

Organization Name

City Public Service Board

Prefix

MS

First

Melissa

Middle

Last

Clyde

Suffix

Credentials

Title

Senior Manager, Environmental & Sustainability Services

Enter new address or copy one from list:

Responsible Official Contact Address

Mailing Address

Address Type

Domestic

Mailing Address (include Suite or Bldg. here, if applicable)

PO BOX 1771

Routing (such as Mail Code, Dept., or Attn:)

MD RT0601

City

SAN ANTONIO

State

TX

Zip

78296

Phone (###-###-####)

2103533302

Extension

Alternate Phone (###-###-####)

Fax (###-###-####)

E-mail

maclcyde@cpsenergy.com

Technical Contact

Person TCEQ should contact for questions about this application:

Select existing TC contact or enter a new contact.

New Contact

Organization Name

CITY PUBLIC SERVICE BOARD

Prefix

MS

First

Julie

Middle

Last	Ybarra
Suffix	
Credentials	
Title	Environmental Analyst
Enter new address or copy one from list:	
Mailing Address	
Address Type	Domestic
Mailing Address (include Suite or Bldg. here, if applicable)	PO BOX 1771
Routing (such as Mail Code, Dept., or Attn:)	MD RT0601
City	SAN ANTONIO
State	TX
ZIP	78296
Phone (###-###-####)	2103533627
Extension	
Alternate Phone (###-###-####)	
Fax (###-###-####)	
E-mail	jaybarra@cpsenergy.com

Title V General Information - Existing

1) Permit Type:	SOP
2) Permit Latitude Coordinate:	29 Deg 21 Min 4 Sec
3) Permit Longitude Coordinate:	98 Deg 34 Min 32 Sec
4) Is this submittal a new application or an update to an existing application?	New Application
4.1. What type of permitting action are you applying for?	Renewal
4.1.1. Are there any permits that should be voided upon issuance of this permit application through permit conversion?	No
4.1.2. Are there any permits that should be voided upon issuance of this permit application through permit consolidation?	No
5) Does this application include Acid Rain Program or Cross-State Air Pollution Rule requirements?	Yes
5.1. Who will electronically sign the Acid Rain Program or Cross-State Air Pollution Rule portion of this application?	Alternate Designated Representative

Title V Attachments Existing

Attach OP-1 (Site Information Summary)

Attach OP-2 (Application for Permit Revision/Renewal)

Attach OP-ACPS (Application Compliance Plan and Schedule)

Attach OP-REQ1 (Application Area-Wide Applicability Determinations and General Information)

Attach OP-REQ2 (Negative Applicable Requirement Determinations)

Attach OP-REQ3 (Applicable Requirements Summary)

Attach OP-PBRSUP (Permits by Rule Supplemental Table)

Attach OP-SUMR (Individual Unit Summary for Revisions)

Attach OP-MON (Monitoring Requirements)

Attach OP-UA (Unit Attribute) Forms

If applicable, attach OP-AR1 (Acid Rain Permit Application)

Attach OP-CRO2 (Change of Responsible Official Information)

Attach OP-DEL (Delegation of Responsible Official)

Attach any other necessary information needed to complete the permit.

[File Properties]

File Name	Leon Creek Title V Application 4-16-2026.pdf
Hash	47B059B8B8005CC78C89F8A37B6FA7225FA9B65C13F1D014DD8B7EDD2B26BFA9
MIME-Type	application/pdf

An additional space to attach any other necessary information needed to complete the permit.

Expedite Title V

1) Per Texas Health and Safety Code, Section 382.05155, does the applicant want to expedite the processing of this application?

No

Certification

I certify that I am the Responsible Official for this application and that, based on information and belief formed after reasonable inquiry, the statements and information on this form are true, accurate, and complete.

1. I am Melissa Clyde, the owner of the STEERS account ER019375.
2. I have the authority to sign this data on behalf of the applicant named above.
3. I have personally examined the foregoing and am familiar with its content and the content of any attachments, and based upon my personal knowledge and/or inquiry of any individual responsible for information contained herein, that this information is true, accurate, and complete.
4. I further certify that I have not violated any term in my TCEQ STEERS participation agreement and that I have no reason to believe that the confidentiality or use of my password has been compromised at any time.
5. I understand that use of my password constitutes an electronic signature legally equivalent to my written signature.
6. I also understand that the attestations of fact contained herein pertain to the implementation, oversight and enforcement of a state and/or federal environmental program and must be true and complete to the best of my knowledge.
7. I am aware that criminal penalties may be imposed for statements or omissions that I know or have reason to believe are untrue or misleading.
8. I am knowingly and intentionally signing Title V Existing 5.
9. My signature indicates that I am in agreement with the information on this form, and authorize its submittal to the TCEC

OWNER OPERATOR Signature: Melissa Clyde OWNER OPERATOR

Account Number:	ER019375
Signature IP Address:	170.85.103.83
Signature Date:	2026-04-16
Signature Hash:	AA37A16C8AB1694E9BBA20CD56F044A23F5092DE6E75F481481C98C787D8B2F3
Form Hash Code at time of Signature:	9FA9560C2922724A15D32C75F442D958CF3D87CB0344F3B110B331EC9415D3A7

Certification

I certify that I am the Alternate Designated Representative for this application and am authorized to make this submission on behalf of the owners and operators of the source or units for which the submission is made. I certify under penalty of law that I have personally examined, and am familiar with, the statements and information submitted in this document and all its attachments. Based on my inquiry of those individuals with primary responsibility for obtaining the information, I certify that the statements are to the best of my knowledge and belief true, accurate, and complete. I am aware that there are significant penalties for submitting false statements and information or omitting required statements and information, including the possibility of fine or imprisonment.

1. I am Melissa Clyde, the owner of the STEERS account ER019375.
2. I have the authority to sign this data on behalf of the applicant named above.
3. I have personally examined the foregoing and am familiar with its content and the content of any attachments, and based upon my personal knowledge and/or inquiry of any individual responsible for information contained herein, that this information is true, accurate, and complete.
4. I further certify that I have not violated any term in my TCEQ STEERS participation agreement and that I have no reason to believe that the confidentiality or use of my password has been compromised at any time.
5. I understand that use of my password constitutes an electronic signature legally equivalent to my written signature.
6. I also understand that the attestations of fact contained herein pertain to the implementation, oversight and enforcement of a state and/or federal environmental program and must be true and complete to the best of my knowledge.
7. I am aware that criminal penalties may be imposed for statements or omissions that I know or have reason to believe are untrue or misleading.
8. I am knowingly and intentionally signing Title V Existing 5.
9. My signature indicates that I am in agreement with the information on this form, and authorize its submittal to the TCEC

OWNER OPERATOR Signature: Melissa Clyde OWNER OPERATOR

Account Number:	ER019375
Signature IP Address:	170.85.103.83
Signature Date:	2026-04-16
Signature Hash:	AA37A16C8AB1694E9BBA20CD56F044A23F5092DE6E75F481481C98C787D8B2F3
Form Hash Code at time of Signature:	9FA9560C2922724A15D32C75F442D958CF3D87CB0344F3B110B331EC9415D3A7

Submission

Reference Number:	The application reference number is 914100
Submitted by:	The application was submitted by ER019375/Melissa Clyde
Submitted Timestamp:	The application was submitted on 2026-04-16 at 09:39:47 CDT
Submitted From:	The application was submitted from IP address 170.85.103.83
Confirmation Number:	The confirmation number is 762776
Steers Version:	The STEERS version is 6.94
Permit Number:	The permit number is 5

Additional Information

Application Creator: This account was created by Marc Olivier



April 16, 2026

Air Permits Initial Review Team (APIRT), MC-161
Texas Commission on Environmental Quality
(TCEQ)
P.O. Box 13087
Austin, Texas 78711-3087

Re: Title V Federal Operating Permit Renewal/Revision
Application Site Operating Permit (SOP) No.: O5
City Public Service Board
Leon Creek Plant
San Antonio, Bexar County, Texas
TCEQ Customer / Regulated Entity Nos.: CN600129019 / RN100217439
TCEQ Account No.: BG-0059-Q

Attn: APIRT

The City Public Service Board (CPS Energy) submits the enclosed request to renew and revise Title V Site Operating Permit (SOP) No. O5 for the Leon Creek Plant. The permit is set to expire October 21, 2026, and this application is being submitted within the time frame to be considered a timely application in accordance with 30 TAC §122.241. This application includes the following permit revision requests and updates:

1. Incorporation of the off-permit authorized equipment:
 - a. Unit ID TK-DSL3 - The off-permit change application approved February 17, 2025 (Project 37700).
2. Form OP-UA3 for the new diesel tank (Unit ID TK-DSL3).
3. Updates due to Bexar County's "serious" nonattainment status update effective January 1, 2025.
 - a. OP-REQ1 (APD-ID303v1, Revised 09/24) is completed "as written," which is consistent with the permit application requirements in 30 TAC §122.132.
 - b. Form OP-REQ3 to reflect changes in applicable requirements of 30 TAC Chapter 117.
 - c. OP-UA1 covers 30 TAC Chapter 117, Subchapter C, Division 2, since the current OP-UA11 does not cover this regulation as of the submittal of this application.





In accordance with the requirements in 30 TAC, Chapter 122, this application package includes the following documents and forms:

Attachment 1: Figures

- Area Map
- Plot Plan
- Process Flow Diagram

Attachment 2: Administrative and Certification Forms

- OP-1 - Site Information Summary
- OP-2 - Application for Permit Revision/Renewal
- OP-CRO1 - Certification by Responsible Official
- OP-DEL - Delegation of Responsible Official Information
- OP-SUMR - Individual Unit Summary for Revisions
- OP-ACPS - Application Compliance Plan and Schedule

Attachment 3: Applicability Identification Forms

- OP-REQ1 - Application Area-Wide Applicability Determinations and General Information
- OP-REQ2 - Negative Applicable/Superseded Requirement Determinations
- OP-REQ3 - Applicable Requirements Summary
- OP-PBRSUP - Permits By Rule Supplemental Table

Attachment 4: Unit Attribute Forms

- OP-UA1 - Miscellaneous and Generic Unit Attributes
- OP-UA3 - Storage Tank Vessel Attributes

Attachment 5: Major NSR Summary Table

- NSR Permit 53284/PSDTX1027

Attachment 6: Acid Rain Permit Application and Certificate of Representation

- OP-AR1 - Acid Rain Permit Application
- Copy of Acid Rain Certificate of Representation





Should you have any questions or require additional information, please contact me at (210) 353-3627 or jaybarra@cpsenergy.com.

Sincerely,

A handwritten signature in black ink that reads "Julie Ybarra". The signature is written in a cursive style with a large, looped "J" and "Y".

Julie Ybarra
Environmental Analyst, Environmental Services

Enclosures

cc: EPA Region 6 via e-mail to R6AirPermitsTX@epa.gov
Health Program Manager - Air Quality, San Antonio Metropolitan Health District, 2509 Kennedy
Circle, Bldg. 125, San Antonio, TX 78235-5160



ATTACHMENT 1 – FIGURES

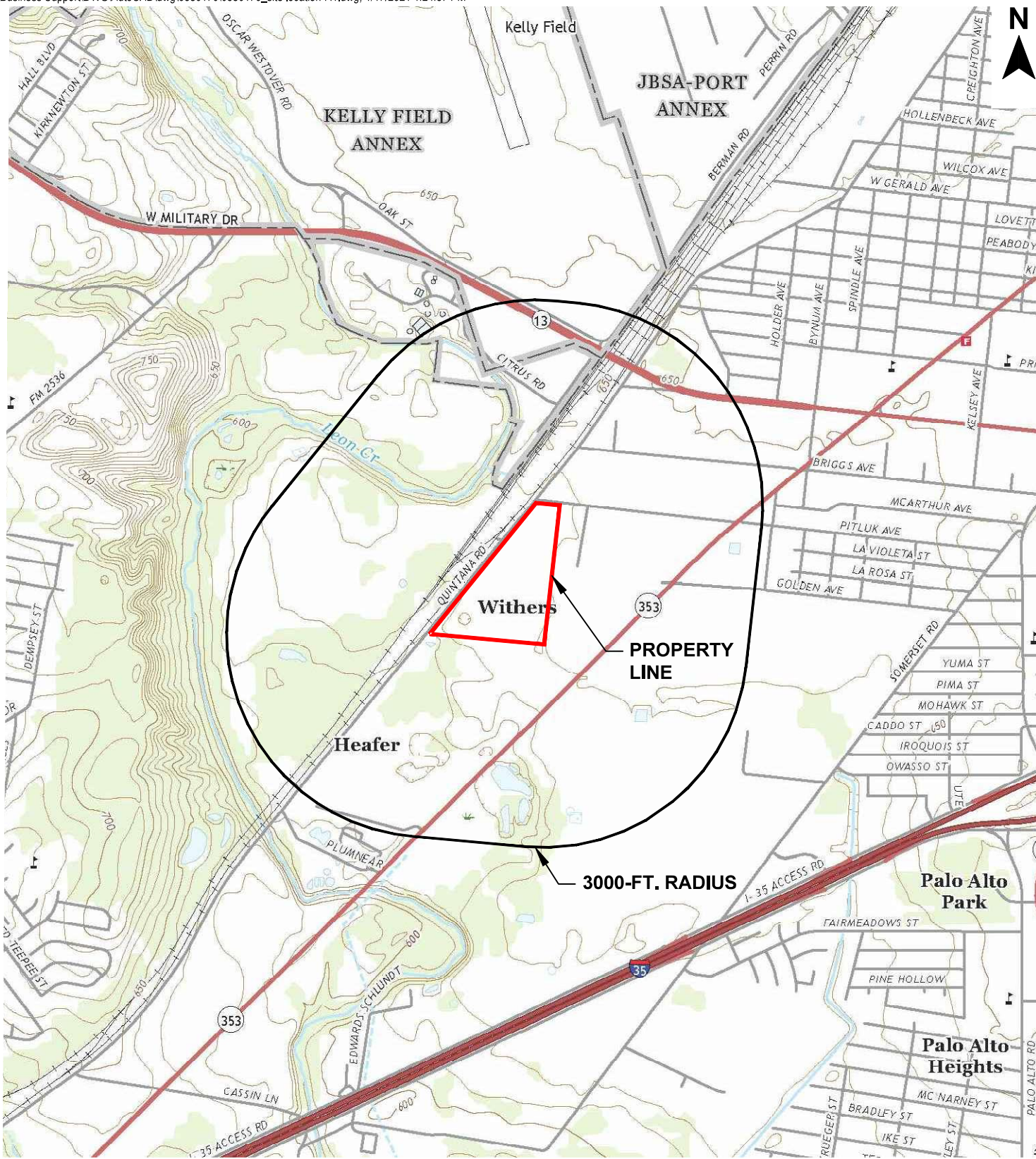

SOURCE: USGS TOPOGRAPHIC QUADRANGLE, 7.5-MINUTE SERIES, TERRELL WELLS, TEXAS, 2019.

Figure 2-1
AREA MAP
Leon Creek Plant
San Antonio, Texas

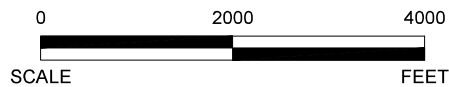

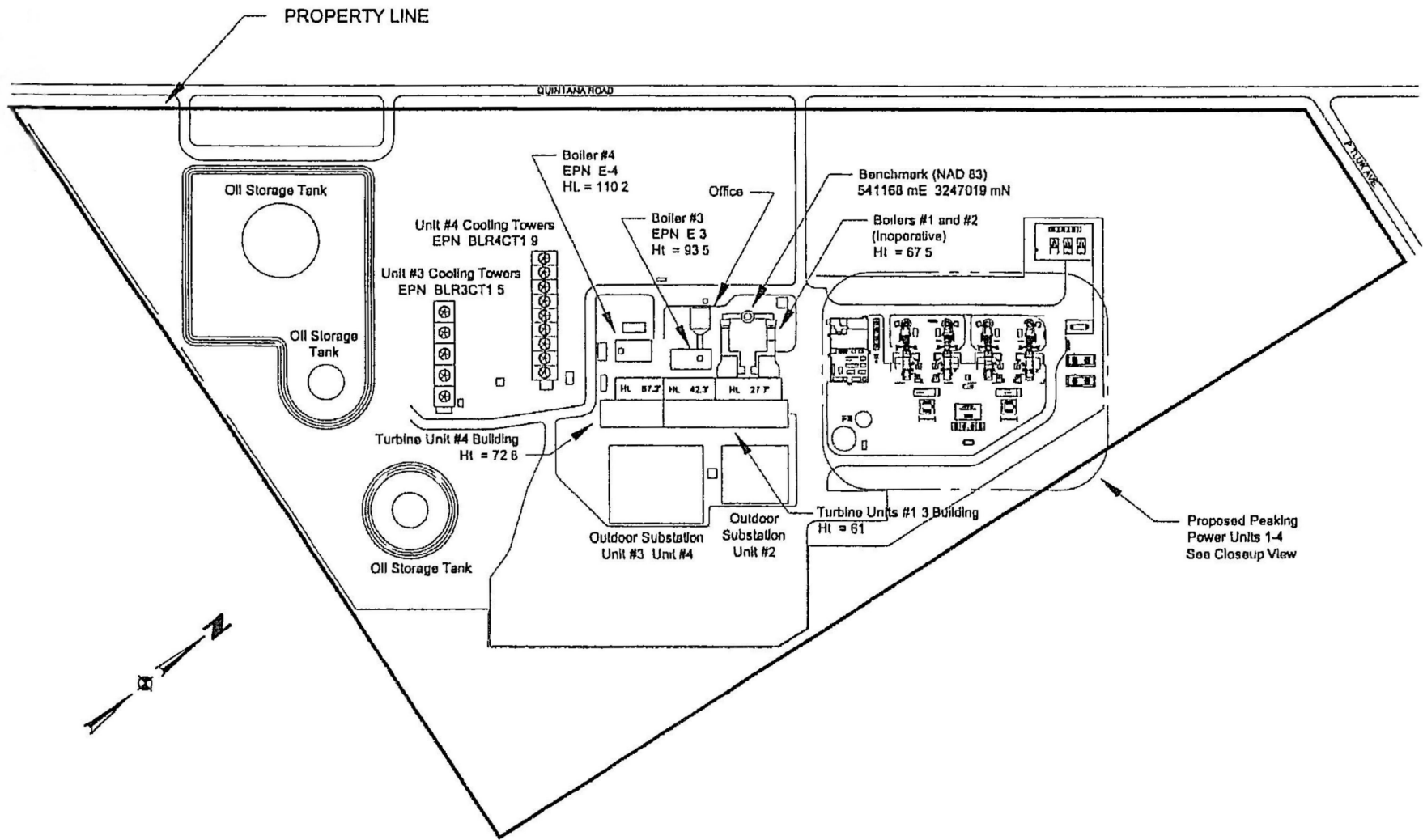
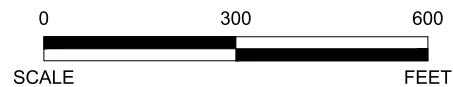

Figure 3-1
PLOT PLAN
 Leon Creek Plant
 San Antonio, Texas

Source: Revision 1 Application for Air Quality Permit
 City Public Service Leon Creek Plant
 Zephyr Environmental March 12, 2003



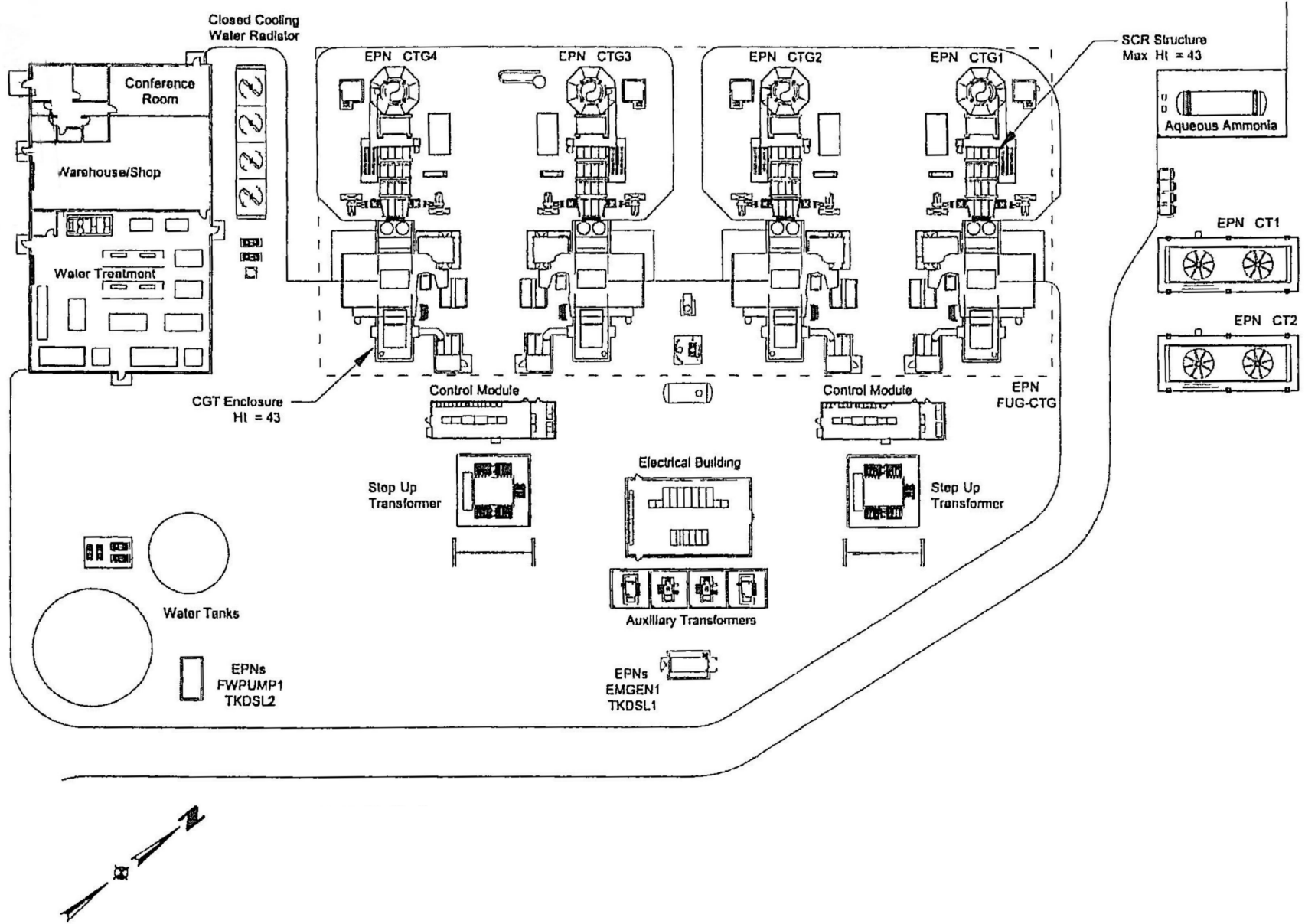
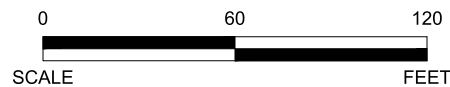

Figure 3-2
PLOT PLAN
 Leon Creek Plant
 San Antonio, Texas



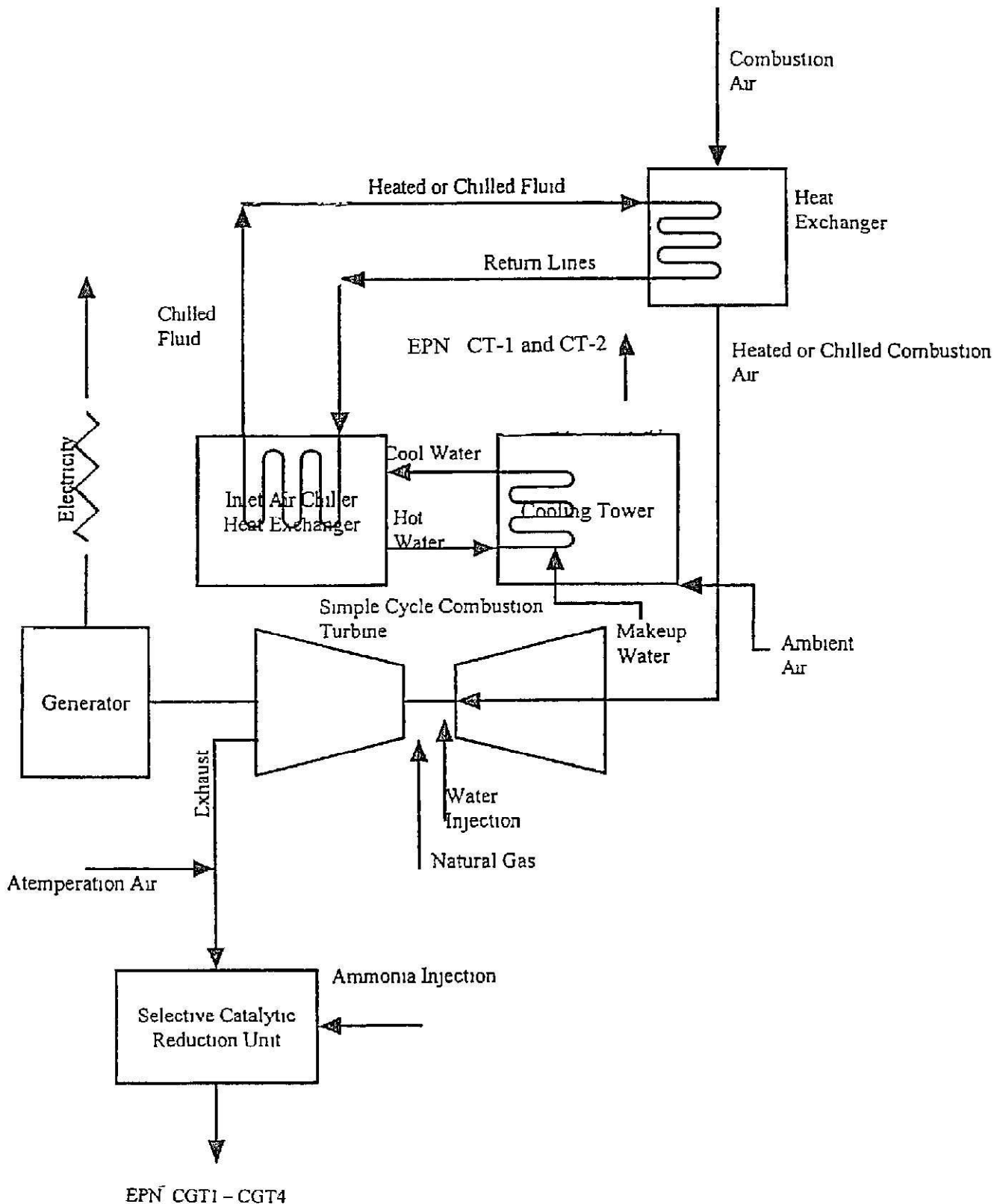

Figure 4-1
PROCESS FLOW DIAGRAM
 Leon Creek Plant
 San Antonio, Texas

ATTACHMENT 2 – ADMINISTRATIVE AND CERTIFICATION FORMS

**Federal Operating Permit Program
Site Information Summary
Form OP-1 (Page 1)
Texas Commission on Environmental Quality**

Please print or type all information. Direct any questions regarding this application form to the Air Permits Division at (512) 239-1250 or to the Texas Commission on Environmental Quality, Office of Air, Air-Permits Division (MC 163), P.O. Box 13087, Austin, Texas 78711-3087.

I. Company Identifying Information
A. Company Name: CPS Energy (City Public Service Board)
B. Customer Reference Number (CN): CN600129019
C. Submittal Date (mm/dd/yyyy): 04/16/2026
II. Site Information
A. Site Name: Leon Creek Plant
B. Regulated Entity Reference Number (RN): RN100217439
C. Indicate affected state(s) required to review permit application: <i>(Check the appropriate box[es].)</i>
<input type="checkbox"/> AR <input type="checkbox"/> CO <input type="checkbox"/> KS <input type="checkbox"/> LA <input type="checkbox"/> NM <input type="checkbox"/> OK <input checked="" type="checkbox"/> N/A
D. Indicate all pollutants for which the site is a major source based on the site's potential to emit: <i>(Check the appropriate box[es].)</i>
<input checked="" type="checkbox"/> VOC <input checked="" type="checkbox"/> NO _x <input type="checkbox"/> SO ₂ <input checked="" type="checkbox"/> PM ₁₀ <input checked="" type="checkbox"/> CO <input type="checkbox"/> Pb <input type="checkbox"/> HAPS
Other:
E. Is the site a non-major source subject to the Federal Operating Permit Program? <input type="checkbox"/> Yes <input checked="" type="checkbox"/> No
F. Is the site within a local program area jurisdiction? <input type="checkbox"/> Yes <input checked="" type="checkbox"/> No
G. Will emissions averaging be used to comply with any Subpart of 40 CFR Part 63? <input type="checkbox"/> Yes <input checked="" type="checkbox"/> No
H. Indicate the 40 CFR Part 63 Subpart(s) that will use emissions averaging:
III. Permit Type
A. Type of Permit Requested: <i>(Select only one response)</i>
<input checked="" type="checkbox"/> Site Operating Permit (SOP) <input type="checkbox"/> Temporary Operating Permit (TOP) <input type="checkbox"/> General Operating Permit (GOP)

**Federal Operating Permit Program
Site Information Summary
Form OP-1 (Page 2)
Texas Commission on Environmental Quality**

IV. Initial Application Information <i>(Complete for Initial Issuance Applications Only.)</i>	
A. Is this submittal an abbreviated or a full application?	<input type="checkbox"/> Abbreviated <input type="checkbox"/> Full
B. If this is a full application, is the submittal a follow-up to an abbreviated application?	<input type="checkbox"/> Yes <input type="checkbox"/> No
C. If this is an abbreviated application, is this an early submittal for a combined SOP and Acid Rain permit?	<input type="checkbox"/> Yes <input type="checkbox"/> No
D. Has an electronic copy of this application been submitted (or is being submitted) to EPA? (Refer to the form instructions for additional information.)	<input type="checkbox"/> Yes <input type="checkbox"/> No
E. Has the required Public Involvement Plan been included with this application?	<input type="checkbox"/> Yes <input type="checkbox"/> No
V. Confidential Information	
A. Is confidential information submitted in conjunction with this application?	<input type="checkbox"/> Yes <input checked="" type="checkbox"/> No
VI. Responsible Official (RO) Identifying Information	
RO Name Prefix: (<input checked="" type="checkbox"/> Mr. <input type="checkbox"/> Mrs. <input type="checkbox"/> Ms. <input type="checkbox"/> Dr.)	
RO Full Name: Gregg Tieken	
RO Title: Director of Environmental Planning & Compliance	
Employer Name: CPS Energy (City Public Service Board)	
Mailing Address: PO Box 1771	
City: San Antonio	
State: TX	
ZIP Code: 78296	
Territory:	
Country:	
Foreign Postal Code:	
Internal Mail Code: MD RT0601	
Telephone No.: (210) 353-2158	
Fax No.:	
Email: grticken@cpsenergy.com	

**Federal Operating Permit Program
Site Information Summary
Form OP-1 (Page 3)
Texas Commission on Environmental Quality**

VII. Technical Contact Identifying Information <i>(Complete if different from RO.)</i>
Technical Contact Name Prefix: (<input type="checkbox"/> Mr. <input type="checkbox"/> Mrs. <input checked="" type="checkbox"/> Ms. <input type="checkbox"/> Dr.)
Technical Contact Full Name: Julie Ybarra
Technical Contact Title: Environmental Analyst
Employer Name: CPS Energy (City Public Service Board)
Mailing Address: PO Box 1771
City: San Antonio
State: TX
ZIP Code: 78296
Territory:
Country:
Foreign Postal Code:
Internal Mail Code: MD RT0601
Telephone No.: (210) 353-3627
Fax No.:
Email: jaybarra@cpsenergy.com
VIII. Reference Only Requirements <i>(For reference only.)</i>
A. State Senator: Judith Zaffirini
B. State Representative: John Lujan
C. Has the applicant paid emissions fees for the most recent agency fiscal year (Sept. 1 - August 31)? <input checked="" type="checkbox"/> Yes <input type="checkbox"/> No <input type="checkbox"/> N/A
D. Is the site subject to bilingual notice requirements pursuant to 30 TAC § 122.322? <input checked="" type="checkbox"/> Yes <input type="checkbox"/> No
E. Indicate the alternate language(s) in which public notice is required: Spanish

**Federal Operating Permit Program
Site Information Summary
Form OP-1 (Page 4)
Texas Commission on Environmental Quality**

IX. Off-Site Permit Request <i>(Optional for applicants requesting to hold the FOP and records at an off-site location.)</i>
A. Office/Facility Name:
B. Physical Address:
City:
State:
ZIP Code:
Territory:
Country:
Foreign Postal Code:
C. Physical Location:
D. Contact Name Prefix: (<input type="checkbox"/> Mr. <input type="checkbox"/> Mrs. <input type="checkbox"/> Ms. <input type="checkbox"/> Dr.)
Contact Full Name:
E. Telephone No.:
X. Application Area Information
A. Area Name: Leon Creek Plant
B. Physical Address: 7718 Quintana Road
City: San Antonio
State: Texas
ZIP Code: 78211
C. Physical Location:
D. Nearest City: San Antonio
E. State: Texas
F. ZIP Code: 78211

**Federal Operating Permit Program
Site Information Summary
Form OP-1 (Page 5)
Texas Commission on Environmental Quality**

X. Application Area Information (continued)
G. Latitude (nearest second): 29° 21' 4"
H. Longitude (nearest second): -98° 34' 32"
I. Are there any emission units that were not in compliance with the applicable requirements identified in the application at the time of application submittal? <input type="checkbox"/> Yes <input checked="" type="checkbox"/> No
J. Indicate the estimated number of emission units in the application area: 10
K. Are there any emission units in the application area subject to the Acid Rain Program? <input checked="" type="checkbox"/> Yes <input type="checkbox"/> No
L. Affected Source Plant Code (or ORIS/Facility Code): 3609
XI. Public Notice <i>(Complete this section for SOP Applications and Acid Rain Permit Applications only.)</i>
A. Name of a public place to view application and draft permit: San Antonio Central Library
B. Physical Address: 600 Soledad St
City: San Antonio
ZIP Code: 78205
C. Contact Person (Someone who will answer questions from the public during the public notice period):
Contact Name Prefix: (<input type="checkbox"/> Mr. <input type="checkbox"/> Mrs. <input checked="" type="checkbox"/> Ms. <input type="checkbox"/> Dr.):
Contact Person Full Name: Julie Ybarra
Contact Mailing Address: PO Box 1771
City: San Antonio
State: TX
ZIP Code: 78296
Territory:
Country:
Foreign Postal Code:
Internal Mail Code: MD RT0601
Telephone No.: (210) 353-3627

**Federal Operating Permit Program
Site Information Summary
Form OP-1 (Page 6)
Texas Commission on Environmental Quality**

XII. Delinquent Fees and Penalties
Notice: This form will not be processed until all delinquent fees and/or penalties owed to TCEQ or the Office of Attorney General on behalf of TCEQ are paid in accordance with the "Delinquent Fee and Penalty Protocol."
Complete Sections XIII and XIV for Acid Rain Permit and CSAPR applications only. Please include a copy of the Certificate of Representation submitted to EPA.
XIII. Designated Representative (DR) Identifying Information
DR Name Prefix: (<input checked="" type="checkbox"/> Mr. <input type="checkbox"/> Mrs. <input type="checkbox"/> Ms. <input type="checkbox"/> Dr.)
DR Full Name: Gregg Tieken
DR Title: Director of Environmental Planning & Compliance
Employer Name: CPS Energy (City Public Service Board)
Mailing Address: PO Box 1771
City: San Antonio
State: TX
ZIP Code: 78296
Territory:
Country:
Foreign Postal Code:
Internal Mail Code: MD RT0601
Telephone No.: (210) 353-2158
Fax No.:
Email: grticken@cpsenergy.com

**Federal Operating Permit Program
Site Information Summary
Form OP-1 (Page 7)
Texas Commission on Environmental Quality**

Complete Sections XIII and XIV for Acid Rain Permit and CSAPR applications only. Please include a copy of the Certificate of Representation submitted to EPA.

XIV. Alternate Designated Representative (ADR) Identifying Information

ADR Name Prefix: (Mr. Mrs. Ms. Dr.)

ADR Full Name: Melissa Clyde

ADR Title: Senior Manager, Environmental & Sustainability Services

Employer Name: CPS Energy (City Public Service Board)

Mailing Address: PO Box 1771

City: San Antonio

State: TX

ZIP Code: 78296

Territory:

Country:

Foreign Postal Code:

Internal Mail Code: MD RT0601

Telephone No.:

Fax No.:

Email: maclyde@cpsenergy.com

**Federal Operating Permit Program
 Application for Permit Revision/Renewal
 Form OP-2-Table 1
 Texas Commission on Environmental Quality**

Date: 04/16/2026	
Permit No.: O5	
Regulated Entity No.: RN100217439	
Company Name: CPS Energy (City Public Service Board)	
For Submissions to EPA	
Has an electronic copy of this application been submitted (or is being submitted) to EPA? <input checked="" type="checkbox"/> YES <input type="checkbox"/> NO	
I. Application Type	
Indicate the type of application:	
<input checked="" type="checkbox"/> Renewal	
<input type="checkbox"/> Streamlined Revision (Must include provisional terms and conditions as explained in the instructions.)	
<input type="checkbox"/> Significant Revision	
<input type="checkbox"/> Revision Requesting Prior Approval	
<input type="checkbox"/> Administrative Revision	
<input type="checkbox"/> Response to Reopening	
II. Qualification Statement	
For SOP Revisions Only <input checked="" type="checkbox"/> YES <input type="checkbox"/> NO	
For GOP Revisions Only <input type="checkbox"/> YES <input type="checkbox"/> NO	

**Federal Operating Permit Program
Application for Permit Revision/Renewal
Form OP-2-Table 1 (continued)
Texas Commission on Environmental Quality**

III. Major Source Pollutants (Complete this section if the permit revision is due to a change at the site or change in regulations.)

Indicate all pollutants for which the site is a major source based on the site's potential to emit:
(Check the appropriate box[es].)

VOC NO_x SO₂ PM₁₀ CO Pb HAP

Other:

IV. Reference Only Requirements (For reference only)

Has the applicant paid emissions fees for the most recent agency fiscal year (September 1 - August 31)? YES NO N/A

V. Delinquent Fees and Penalties

Notice: This form will not be processed until all delinquent fees and/or penalties owed to the TCEQ or the Office of the Attorney General on behalf of the TCEQ are paid in accordance with the Delinquent Fee and penalty protocol.

**Federal Operating Permit Program
Application for Permit Revision/Renewal
Form OP-2-Table 2
Texas Commission on Environmental Quality**

Date: 04/16/2026
Permit No.: O5
Regulated Entity No.: RN100217439
Company Name: CPS Energy (City Public Service Board)

Using the table below, provide a description of the revision.

Revision No.	Revision Code	New Unit	Unit/Group	Process	NSR Authorization	Description of Change and Provisional Terms and Conditions
			ID No.	Applicable Form		
1	MS-C	YES	TK-DSL3	OP-UA3	PBR 106.472/09/04/2000	Add to Title V for 30 TAC Chapter 115, Storage of VOCs.
2	SIG-E	YES	TK-DSL3	OP-UA3	PBR 106.472/09/04/2000	Add permit shield for NSPS Subpart Kb.
3	SIG-E	YES	TK-DSL3	OP-UA3	PBR 106.472/09/04/2000	Add permit shield for NSPS Subpart Kc.
4	MS-C	NO	GRPCGT	OP-UA1	53284, PSDTX1027	Addition of 30 TAC Chapter 117, Subchapter C, Division 2 applicable requirements.

**Federal Operating Permit Program
Application for Permit Revision/Renewal
Form OP-2-Table 3
Texas Commission on Environmental Quality**

Date: 04/16/2026	
Permit No.: O5	
Regulated Entity No.: RN100217439	
Company Name: CPS Energy (City Public Service Board)	
I. Significant Revision <i>(Complete this section if you are submitting a significant revision application or a renewal application that includes a significant revision.)</i>	
A. Is the site subject to bilingual requirements pursuant to 30 TAC § 122.322?	<input checked="" type="checkbox"/> YES <input type="checkbox"/> NO
B. Indicate the alternate language(s) in which public notice is required: Spanish	
C. Will, there be a change in air pollutant emissions as a result of the significant revision?	<input type="checkbox"/> YES <input checked="" type="checkbox"/> NO

**Texas Commission on Environmental Quality
Form OP-ACPS
Application Compliance Plan and Schedule**

Date: 04/16/2026	Regulated Entity No.: RN100217439	Permit No.: O5
Company Name: CPS Energy (City Public Service Board)		Area Name: Leon Creek Plant

- Part 1 of this form must be submitted with all initial FOP applications and renewal applications.
- The Responsible Official must use Form OP-CRO1 (Certification by Responsible Official) to certify information contained in this form in accordance with 30 TAC § 122.132(d)(8).

Part 1

A. Compliance Plan — Future Activity Committal Statement	
<p>The <i>Responsible Official</i> commits, utilizing reasonable effort, to the following: As the responsible official it is my intent that all emission units shall continue to be in compliance with all applicable requirements they are currently in compliance with, and all emission units shall be in compliance by the compliance dates with any applicable requirements that become effective during the permit term.</p>	
B. Compliance Certification - Statement for Units in Compliance* (Indicate response by entering an "X" in the appropriate column)	
1. With the exception of those emission units listed in the Compliance Schedule section of this form (Part 2, below), and based, at minimum, on the compliance method specified in the associated applicable requirements, are all emission units addressed in this application in compliance with all their respective applicable requirements as identified in this application?	<input checked="" type="checkbox"/> YES <input type="checkbox"/> NO
2. Are there any non-compliance situations addressed in the Compliance Schedule Section of this form (Part 2)?	<input type="checkbox"/> YES <input checked="" type="checkbox"/> NO
3. If the response to Item B.2, above, is "Yes," indicate the total number of Part 2 attachments included in this submittal. <i>(For reference only)</i>	
<p>* For Site Operating Permits (SOPs), the complete application should be consulted for applicable requirements and their corresponding emission units when assessing compliance status. For General Operating Permits (GOPs), the application documentation, particularly Form OP-REQ1 should be consulted as well as the requirements contained in the appropriate General Permits portion of 30 TAC Chapter 122.</p> <p>Compliance should be assessed based, at a minimum, on the required monitoring, testing, record keeping, and/or reporting requirements, as appropriate, associated with the applicable requirement in question.</p>	

Form OP-CRO1
Certification by Responsible Official
Federal Operating Permit Program
Texas Commission on Environmental Quality

All initial issuance, revision, renewal, and reopening permit application submittals requiring certification must be addressed using this form. Updates to site operating permit (SOP) and temporary operating permit (TOP) applications, other than public notice verification materials, must be certified prior to authorization of public notice or start of public announcement. Updates to general operating permit (GOP) applications must be certified prior to receiving an authorization to operate under a GOP.

I. Identifying Information
RN: RN100217439
CN: CN600129019
Account No.: BG-0059-Q
Permit No.: O5
Project No.: TBA
Area Name: Leon Creek Plant
Company Name: CPS Energy (City Public Service Board)
II. Certification Type <i>(Please mark appropriate box)</i>
<input type="checkbox"/> Responsible Official <input checked="" type="checkbox"/> Duly Authorized Representative
III. Submittal Type <i>(Please mark appropriate box) (Only one response can be accepted per form)</i>
<input type="checkbox"/> SOP/TOP Initial Permit Application <input checked="" type="checkbox"/> Permit Revision, Renewal, or Reopening
<input type="checkbox"/> GOP Initial Permit Application <input type="checkbox"/> Update to Permit Application
<input type="checkbox"/> Other: _____

Form OP-CRO1
Certification by Responsible Official
Federal Operating Permit Program
Texas Commission on Environmental Quality

All initial issuance, revision, and renewal permit application submittals requiring certification must be accompanied by this form. Updates to acid rain or CSAPR (other than public notice verification materials) must be certified prior to authorization of public notice for the draft permit.

IV. Certification of Truth			
This certification does not extend to information which is designated by TCEQ as information for reference only.			
I, <u>Melissa Clyde</u>		certify that I am the <u>DAR</u>	
<i>(Certifier Name printed or typed)</i>		<i>(RO or DAR)</i>	
and that, based on information and belief formed after reasonable inquiry, the statements and information dated during the time period or on the specific date(s) below, are true, accurate, and complete: <i>Note: Enter Either a Time Period or Specific Date(s) for each certification. This section must be completed. The certification is not valid without documentation date(s).</i>			
Time Period: From _____		to _____	
<i>(Start Date)</i>		<i>(End Date)</i>	
Specific Dates: <u>04/16/2026</u>			
<i>(Date 1)</i>	<i>(Date 2)</i>	<i>(Date 3)</i>	<i>(Date 4)</i>
<i>(Date 5)</i>		<i>(Date 6)</i>	
Signature: <u>Melissa Clyde</u>		Signature Date: <u>4/16/24</u>	
Title: <u>Manager, Air Permitting & Compliance</u>			

Form OP-CRO1
Certification by Responsible Official
Federal Operating Permit Program
Texas Commission on Environmental Quality

All initial issuance, revision, and renewal permit application submittals requiring certification must be accompanied by this form. Updates to acid rain or CSAPR (other than public notice verification materials) must be certified prior to authorization of public notice for the draft permit.

I. Identifying Information	
RN: RN100217439	
CN: CN600129019	
Account No.: BG-0059-Q	
Permit No.: O5	
Project No.: TBA	
Area Name: Leon Creek Plant	
Company Name: CPS Energy (City Public Service Board)	
II. Certification Type <i>(Please mark appropriate box)</i>	
<input type="checkbox"/> Designated Representative	<input checked="" type="checkbox"/> Alternate Designated Representative
III. Requirement and Submittal Type <i>(Please mark the appropriate boxes for each row)</i>	
Requirement: <input checked="" type="checkbox"/> Acid Rain Permit	<input type="checkbox"/> CSAPR
Submittal Type: <input type="checkbox"/> Initial Permit Application	<input type="checkbox"/> Update to Permit Application
<input checked="" type="checkbox"/> Permit Revision or Renewal	<input type="checkbox"/> Other:

Form OP-CRO1
Certification by Responsible Official
Federal Operating Permit Program
Texas Commission on Environmental Quality

IV. Certification of Truth

I, Melissa Clyde certify that I am the ADR

(Certifier Name printed or typed)

(DR or ADR)

am authorized to make this submission on behalf of the owners and operators of the source or units for which the submission is made. I certify under penalty of law that I have personally examined, and am familiar with, the statements and information submitted in this document and all its attachments. Based on my inquiry of those individuals with primary responsibility for obtaining the information, I certify that the statements are to the best of my knowledge and belief true, accurate, and complete. I am aware that there are significant penalties for submitting false statements and information or omitting required statements and information, including the possibility of fine or imprisonment. The above certification is for the statements and information dated during the time period or on the specific date(s) below:

Note: Enter Either a Time Period or Specific Date(s) for each certification. This section must be completed. The certification is not valid without documentation date(s).

Time Period: From _____ to _____

(Start Date)

(End Date)

Specific Dates: 04/16/2026

(Date 1)

(Date 2)

(Date 3)

(Date 4)

(Date 5)

(Date 6)

Signature: Melissa Clyde

Signature Date: 4/16/26

Title: Manager, Air Permitting & Compliance

Form OP-DEL
Delegation of Responsible Official Information
Federal Operating Permit Program
Texas Commission on Environmental Quality

I. Identifying Information
Account Number: BG-0059-Q
Regulated Entity Number: RN100217439
Customer Reference Number: CN600129019
Permit Number: O5
Area Name: Leon Creek Plant
Company Name: CPS Energy (City Public Service Board)
II. Duly Authorized Representative Information
Action Type: <input type="checkbox"/> New DAR Identification <input checked="" type="checkbox"/> Administrative Information Change
Conventional Title: <input type="checkbox"/> Mr. <input type="checkbox"/> Mrs. <input checked="" type="checkbox"/> Ms. <input type="checkbox"/> Dr.
Name (Driver License/STEERS): Melissa Clyde
Title: Senior Manager, Environmental & Sustainability Services
Delegation Effective Date: 04/16/2026
Telephone Number: 210-353-3302
Fax Number:
Company Name: CPS Energy (City Public Service Board)
Mailing Address: PO Box 1771 MD RT0601
City: San Antonio
State: TX
ZIP Code: 78296
Email Address: maclcyde@cpsenergy.com

Form OP-DEL
Delegation of Responsible Official Information
Federal Operating Permit Program
Texas Commission on Environmental Quality

III. Certification of Truth, Accuracy, and Completeness

I, Melissa Clyde

(Name printed or typed: RO for New DAR Identification; RO or DAR for Administrative Information Change)

Certify that, based on information and belief formed after reasonable inquiry, the statements, and information stated above are true, accurate, and complete. (RO signature required for New DAR Identification only; DAR signature required for any Action Type)

Responsible Official Signature: _____

Date: _____

Duly Authorized Representative Signature: Melissa Clyde

(Name(s) printed or typed) Melissa Clyde

Date: 4/16/2026

IV. Removal of Duly Authorized Representative(s)

The following should be removed as Duly Authorized Representative(s):

(Name(s) printed or typed)

Effective Date: _____

Responsible Official Signature: _____

Date: _____

**Texas Commission on Environmental Quality
Federal Operating Permit Program
Individual Unit Summary for Revisions
Form OP-SUMR**

[Table 1](#)

Date	Permit No.	Regulated Entity No.
04/16/2026	O5	RN100217439

Unit/Process AI	Unit/Process Revision No.	Unit/Process ID No.	Unit/Process Applicable Form	Unit/Process Name/ Description	Unit/Process CAM	Preconstruction Authorizations 30 TAC Chapter 116/ 30 TAC Chapter 106	Preconstruction Authorizations Title I
A	1	TK-DSL3	OP-UA3	Diesel Storage Tank		PBR 106.472/09/04/2000	
A	2	TK-DSL3	OP-UA3	Diesel Storage Tank		PBR 106.472/09/04/2000	
A	3	TK-DSL3	OP-UA3	Diesel Storage Tank		PBR 106.472/09/04/2000	
	4	GRPCGT	OP-UA1	Peaking Power Unit 1, Peaking Power Unit 2, Peaking Power Unit 3, Peaking Power Unit 4		53284	PSDTX1027

ATTACHMENT 3 – APPLICABILITY IDENTIFICATION FORMS

Permit By Rule Supplemental Table (Page 1)
Table A: Registered Permits by Rule (30 TAC Chapter 106) for the Application Area
Texas Commission on Environmental Quality

Date	Permit Number	Regulated Entity Number
04/16/2026	O5	RN100217439

Unit ID No.	Registration No.	PBR No.	Registration Date
NA	NA	NA	NA

Permit By Rule Supplemental Table (Page 2)
Table B: Claimed (not registered) Permits by Rule (30 TAC Chapter 106) for the Application Area
Texas Commission on Environmental Quality

Date	Permit Number	Regulated Entity Number
04/16/2026	O5	RN100217439

Unit ID No.	PBR No.	Version No./Date
W-1	STDEX051	07/20/1992
W-2	STDEX051	07/20/1992
W-3	STDEX051	07/20/1992
W-4	STDEX051	07/20/1992
W-5	106.532	09/04/2000
W-6	106.532	09/04/2000
W-13	STDEX051	07/20/1992
W-14	STDEX051	07/20/1992
W-18	106.472	09/04/2000
W-19	106.472	09/04/2000
W-20	106.472	09/04/2000
W-21	106.472	09/04/2000
W-24	106.473	09/04/2000

Permit By Rule Supplemental Table (Page 2)
Table B: Claimed (not registered) Permits by Rule (30 TAC Chapter 106) for the Application Area
Texas Commission on Environmental Quality

Date	Permit Number	Regulated Entity Number
04/16/2026	O5	RN100217439

Unit ID No.	PBR No.	Version No./Date
W-25	106.472	09/04/2000
W-26	106.472	09/04/2000
W-27	106.472	09/04/2000
W-28	106.472	09/04/2000
W-29	106.472	09/04/2000
W-30	106.472	09/04/2000
W-31	106.472	09/04/2000
W-32	106.472	09/04/2000
W-33	106.472	09/04/2000
W-34	106.472	09/04/2000
W-35	106.472	09/04/2000
W-36	106.472	09/04/2000
W-37	106.472	09/04/2000

Permit By Rule Supplemental Table (Page 2)
Table B: Claimed (not registered) Permits by Rule (30 TAC Chapter 106) for the Application Area
Texas Commission on Environmental Quality

Date	Permit Number	Regulated Entity Number
04/16/2026	O5	RN100217439

Unit ID No.	PBR No.	Version No./Date
W-38	106.472	09/04/2000
W-39	106.472	09/04/2000
W-40	106.472	09/04/2000
W-41	106.472	09/04/2000
W-42	106.472	09/04/2000
W-43	106.472	09/04/2000
W-44	106.472	09/04/2000
WSCT-1	106.371	09/04/2000
EMGEN2	STDEX 005	09/17/1973
EMGEN3	106.511	09/04/2000
FWPUMP2	STDEX 005	06/07/1996
FACMSS	106.263	11/01/2001
MachShop	106.265	09/04/2000
FUEL1	106.412	09/04/2000
PIPEMSS	106.355	11/01/2001
TK-DSL3	106.472	09/04/2000

Permit By Rule Supplemental Table (Page 3)
Table C: Claimed (not registered) Permits by Rule (30 TAC Chapter 106) for Insignificant Sources for the Application Area
Texas Commission on Environmental Quality

Date	Permit Number	Regulated Entity Number
04/16/2026	O5	RN100217439

PBR No.	Version No./Date
106.102	09/04/2000
106.242	09/04/2000
106.244	09/04/2000
106.316	09/04/2000
106.317	09/04/2000
STDEX 003	09/13/1993
STDEX 003	11/05/1986

Permit By Rule Supplemental Table (Page 4)
Table D: Monitoring Requirements for registered and claimed PBRs for the Application Area
Texas Commission on Environmental Quality

Date	Permit Number	Regulated Entity Number
04/16/2026	O5	RN100217439

Unit ID No.	PBR No.	Version No./Date Or Registration No.	Monitoring Requirement
W-1	STDEX051	07/20/1992	Maintain documentation that the material stored is a lube oil/additive, fuel, polymer, detergent, or an organic liquid with a boiling point ≥ 300 °F.
W-2	STDEX051	07/20/1992	Maintain documentation that the material stored is a lube oil/additive, fuel, polymer, detergent, or an organic liquid with a boiling point ≥ 300 °F.
W-3	STDEX051	07/20/1992	Maintain documentation that the material stored is a lube oil/additive, fuel, polymer, detergent, or an organic liquid with a boiling point ≥ 300 °F.
W-4	STDEX051	07/20/1992	Maintain documentation that the material stored is a lube oil/additive, fuel, polymer, detergent, or an organic liquid with a boiling point ≥ 300 °F.
W-5	106.532	09/04/2000	Maintain records which document that the sum of the partial pressure of all species of VOC in the oil water separator is less than 1.5 psia
W-6	106.532	09/04/2000	Maintain records which document that the sum of the partial pressure of all species of VOC in the oil water separator is less than 1.5 psia
W-13	STDEX051	07/20/1992	Maintain documentation that the material stored is a lube oil/additive, fuel, polymer, detergent, or an organic liquid with a boiling point ≥ 300 °F.
W-14	STDEX051	07/20/1992	Maintain documentation that the material stored is a lube oil/additive, fuel, polymer, detergent, or an organic liquid with a boiling point ≥ 300 °F.
W-18	106.472	09/04/2000	Maintain documentation that the material stored is a lube oil/additive, fuel, polymer, detergent, or an organic liquid with a boiling point ≥ 300 °F.

Permit By Rule Supplemental Table (Page 4)
Table D: Monitoring Requirements for registered and claimed PBRs for the Application Area
Texas Commission on Environmental Quality

Date	Permit Number	Regulated Entity Number
04/16/2026	O5	RN100217439

Unit ID No.	PBR No.	Version No./Date Or Registration No.	Monitoring Requirement
W-19	106.472	09/04/2000	Maintain documentation that the material stored is a lube oil/additive, fuel, polymer, detergent, or an organic liquid with a boiling point ≥ 300 °F.
W-20	106.472	09/04/2000	Maintain documentation that the material stored is a lube oil/additive, fuel, polymer, detergent, or an organic liquid with a boiling point ≥ 300 °F.
W-21	106.472	09/04/2000	Maintain documentation that the material stored is a lube oil/additive, fuel, polymer, detergent, or an organic liquid with a boiling point ≥ 300 °F.
W-24	106.473	09/04/2000	Maintain documentation that the material stored is a lube oil/additive, fuel, polymer, detergent, or an organic liquid with a boiling point ≥ 300 °F.
W-25	106.472	09/04/2000	Maintain documentation that the material stored is a lube oil/additive, fuel, polymer, detergent, or an organic liquid with a boiling point ≥ 300 °F.
W-26	106.472	09/04/2000	Maintain documentation that the material stored is a lube oil/additive, fuel, polymer, detergent, or an organic liquid with a boiling point ≥ 300 °F.
W-27	106.472	09/04/2000	Maintain documentation that the material stored is a lube oil/additive, fuel, polymer, detergent, or an organic liquid with a boiling point ≥ 300 °F.
W-28	106.472	09/04/2000	Maintain documentation that the material stored is a lube oil/additive, fuel, polymer, detergent, or an organic liquid with a boiling point ≥ 300 °F.
W-29	106.472	09/04/2000	Maintain documentation that the material stored is a lube oil/additive, fuel, polymer, detergent, or an organic liquid with a boiling point ≥ 300 °F.
W-30	106.472	09/04/2000	Maintain documentation that the material stored is a lube oil/additive, fuel, polymer, detergent, or an organic liquid with a boiling point ≥ 300 °F.

Permit By Rule Supplemental Table (Page 4)
Table D: Monitoring Requirements for registered and claimed PBRs for the Application Area
Texas Commission on Environmental Quality

Date	Permit Number	Regulated Entity Number
04/16/2026	O5	RN100217439

Unit ID No.	PBR No.	Version No./Date Or Registration No.	Monitoring Requirement
W-31	106.472	09/04/2000	Maintain documentation that the material stored is a lube oil/additive, fuel, polymer, detergent, or an organic liquid with a boiling point \geq 300 °F.
W-32	106.472	09/04/2000	Maintain documentation that the material stored is a lube oil/additive, fuel, polymer, detergent, or an organic liquid with a boiling point \geq 300 °F.
W-33	106.472	09/04/2000	Maintain documentation that the material stored is a lube oil/additive, fuel, polymer, detergent, or an organic liquid with a boiling point \geq 300 °F.
W-34	106.472	09/04/2000	Maintain documentation that the material stored is a lube oil/additive, fuel, polymer, detergent, or an organic liquid with a boiling point \geq 300 °F.
W-35	106.472	09/04/2000	Maintain documentation that the material stored is a lube oil/additive, fuel, polymer, detergent, or an organic liquid with a boiling point \geq 300 °F.
W-36	106.472	09/04/2000	Maintain documentation that the material stored is a lube oil/additive, fuel, polymer, detergent, or an organic liquid with a boiling point \geq 300 °F.
W-37	106.472	09/04/2000	Maintain documentation that the material stored is a lube oil/additive, fuel, polymer, detergent, or an organic liquid with a boiling point \geq 300 °F.
W-38	106.472	09/04/2000	Maintain documentation that the material stored is a lube oil/additive, fuel, polymer, detergent, or an organic liquid with a boiling point \geq 300 °F.
W-39	106.472	09/04/2000	Maintain documentation that the material stored is a lube oil/additive, fuel, polymer, detergent, or an organic liquid with a boiling point \geq 300 °F.
W-40	106.472	09/04/2000	Maintain documentation that the material stored is a lube oil/additive, fuel, polymer, detergent, or an organic liquid with a boiling point \geq 300 °F.

Permit By Rule Supplemental Table (Page 4)
Table D: Monitoring Requirements for registered and claimed PBRs for the Application Area
Texas Commission on Environmental Quality

Date	Permit Number	Regulated Entity Number
04/16/2026	O5	RN100217439

Unit ID No.	PBR No.	Version No./Date Or Registration No.	Monitoring Requirement
W-41	106.472	09/04/2000	Maintain documentation that the material stored is a lube oil/additive, fuel, polymer, detergent, or an organic liquid with a boiling point ≥ 300 °F.
W-42	106.472	09/04/2000	Maintain documentation that the material stored is a lube oil/additive, fuel, polymer, detergent, or an organic liquid with a boiling point ≥ 300 °F.
W-43	106.472	09/04/2000	Maintain documentation that the material stored is a lube oil/additive, fuel, polymer, detergent, or an organic liquid with a boiling point ≥ 300 °F.
W-44	106.472	09/04/2000	Maintain documentation that the material stored is a lube oil/additive, fuel, polymer, detergent, or an organic liquid with a boiling point ≥ 300 °F.
WSCT-1	106.371	09/04/2000	Maintain records of hours of operation and quarterly visible emissions observations.
EMGEN2	STDEX 005	09/17/1973	Maintain engine run time log and maintenance records.
EMGEN3	106.511	09/04/2000	Maintain engine run time log and maintenance records.
FWPUMP2	STDEX 005	06/07/1996	Maintain engine run time log and maintenance records.
FACMSS	106.263	11/01/2001	Maintain records of date, time, duration and emissions from MSS.
MachShop	106.265	09/04/2000	Use only manually operated equipment.
FUEL1	106.412	09/04/2000	Maintain purchase records of liquid fuel deliveries to equipment.
PIPEMSS	106.355	11/01/2001	Maintain records of date, time, duration and emissions from MSS.
FACWELD	106.227	09/04/2000	Maintain records of welding rod SDS and purchase records.

Application Area-Wide Applicability Determinations and General Information
Form OP-REQ1 (Page 1)
Federal Operating Permit Program
Texas Commission on Environmental Quality

Date	Permit No.	Regulated Entity No.
04/16/2026	O5	RN100217439

For SOP applications, answer ALL questions unless otherwise directed.

◆ For GOP applications, answer ONLY these questions unless otherwise directed.

I. Title 30 TAC Chapter 111 - Control of Air Pollution from Visible Emissions and Particulate Matter		
A. Visible Emissions		
◆	1. The application area includes stationary vents constructed on or before January 31, 1972.	<input checked="" type="checkbox"/> Yes <input type="checkbox"/> No
◆	2. The application area includes stationary vents constructed after January 31, 1972. <i>If the responses to Questions I.A.1 and I.A.2 are both "No," go to Question I.A.6. If the response to Question I.A.1 is "No" and the response to Question I.A.2 is "Yes," go to Question I.A.4.</i>	<input checked="" type="checkbox"/> Yes <input type="checkbox"/> No
◆	3. The application area is opting to comply with the requirements for stationary vents constructed after January 31, 1972 for vents in the application area constructed on or before January 31, 1972.	<input checked="" type="checkbox"/> Yes <input type="checkbox"/> No
◆	4. All stationary vents are addressed on a unit specific basis.	<input type="checkbox"/> Yes <input checked="" type="checkbox"/> No
◆	5. Test Method 9 (40 CFR Part 60, Appendix A, Method 9 - Visual Determination of the Opacity of Emissions from Stationary Sources) is used to determine opacity of emissions in the application area.	<input checked="" type="checkbox"/> Yes <input type="checkbox"/> No
◆	6. The application area includes structures subject to 30 TAC § 111.111(a)(7)(A).	<input checked="" type="checkbox"/> Yes <input type="checkbox"/> No
◆	7. The application area includes sources, other than those specified in 30 TAC § 111.111(a)(1), (4), or (7), subject to 30 TAC § 111.111(a)(8)(A).	<input checked="" type="checkbox"/> Yes <input type="checkbox"/> No
◆	8. Emissions from units in the application area include contributions from uncombined water.	<input checked="" type="checkbox"/> Yes <input type="checkbox"/> No
◆	9. The application area is located in the City of El Paso, including Fort Bliss Military Reservation, and includes solid fuel heating devices subject to 30 TAC § 111.111(c).	<input type="checkbox"/> Yes <input checked="" type="checkbox"/> No <input type="checkbox"/> N/A

Application Area-Wide Applicability Determinations and General Information
Form OP-REQ1 (Page 2)
Federal Operating Permit Program
Texas Commission on Environmental Quality

Date	Permit No.	Regulated Entity No.
04/16/2026	O5	RN100217439

For SOP applications, answer ALL questions unless otherwise directed.

◆ For GOP applications, answer ONLY these questions unless otherwise directed.

I. Title 30 TAC Chapter 111 - Control of Air Pollution from Visible Emissions and Particulate Matter (continued)		
B. Materials Handling, Construction, Roads, Streets, Alleys, and Parking Lots		
1. Items a - d determine applicability of any of these requirements based on geographical location.		
◆	a. The application area is located within the city of El Paso.	<input type="checkbox"/> Yes <input checked="" type="checkbox"/> No
◆	b. The application area is located within the Fort Bliss Military Reservation, except areas specified in 30 TAC § 111.141.	<input type="checkbox"/> Yes <input checked="" type="checkbox"/> No
◆	c. The application area is located in the portion of Harris County inside the loop formed by Beltway 8.	<input type="checkbox"/> Yes <input checked="" type="checkbox"/> No
◆	d. The application area is located in the area of Nueces County outlined in Group II state implementation plan (SIP) for inhalable particulate matter adopted by the TCEQ on May 13, 1988.	<input type="checkbox"/> Yes <input checked="" type="checkbox"/> No
<i>If there is any "Yes" response to Questions I.B.1.a - d, answer Questions I.B.2.a - d. If all responses to Questions I.B.1.a-d are "No," go to Section I.C.</i>		
2. Items a - d determine the specific applicability of these requirements.		
◆	a. The application area is subject to 30 TAC § 111.143.	<input type="checkbox"/> Yes <input type="checkbox"/> No
◆	b. The application area is subject to 30 TAC § 111.145.	<input type="checkbox"/> Yes <input type="checkbox"/> No
◆	c. The application area is subject to 30 TAC § 111.147.	<input type="checkbox"/> Yes <input type="checkbox"/> No
◆	d. The application area is subject to 30 TAC § 111.149.	<input type="checkbox"/> Yes <input type="checkbox"/> No
C. Emissions Limits on Nonagricultural Processes		
◆	1. The application area includes a nonagricultural process subject to 30 TAC § 111.151.	<input checked="" type="checkbox"/> Yes <input type="checkbox"/> No
	2. The application area includes a vent from a nonagricultural process that is subject to additional monitoring requirements. <i>If the response to Question I.C.2 is "No," go to Question I.C.4.</i>	<input type="checkbox"/> Yes <input checked="" type="checkbox"/> No
	3. All vents from nonagricultural process in the application area are subject to additional monitoring requirements.	<input type="checkbox"/> Yes <input type="checkbox"/> No

Application Area-Wide Applicability Determinations and General Information
Form OP-REQ1 (Page 3)
Federal Operating Permit Program
Texas Commission on Environmental Quality

Date	Permit No.	Regulated Entity No.
04/16/2026	O5	RN100217439

For SOP applications, answer ALL questions unless otherwise directed.

◆ For GOP applications, answer ONLY these questions unless otherwise directed.

I. Title 30 TAC Chapter 111 - Control of Air Pollution from Visible Emissions and Particulate Matter (continued)		
C. Emissions Limits on Nonagricultural Processes (continued)		
4.	The application area includes oil or gas fuel-fired steam generators subject to 30 TAC §§ 111.153(a) and 111.153(c).	<input type="checkbox"/> Yes <input checked="" type="checkbox"/> No
5.	The application area includes oil or gas fuel-fired steam generators that are subject to additional monitoring requirements. <i>If the response to Question I.C.5 is "No," go to Question I.C.7.</i>	<input type="checkbox"/> Yes <input checked="" type="checkbox"/> No
6.	All oil or gas fuel-fired steam generators in the application area are subject to additional monitoring requirements.	<input type="checkbox"/> Yes <input type="checkbox"/> No
7.	The application area includes solid fossil fuel-fired steam generators subject to 30 TAC §§ 111.153(a) and 111.153(b).	<input type="checkbox"/> Yes <input checked="" type="checkbox"/> No
8.	The application area includes solid fossil fuel-fired steam generators that are subject to additional monitoring requirements. <i>If the response to Question I.C.8 is "No," go to Section I.D.</i>	<input type="checkbox"/> Yes <input checked="" type="checkbox"/> No
9.	All solid fossil fuel-fired steam generators in the application area are subject to additional monitoring requirements.	<input type="checkbox"/> Yes <input type="checkbox"/> No
D. Emissions Limits on Agricultural Processes		
1.	The application area includes agricultural processes subject to 30 TAC § 111.171.	<input type="checkbox"/> Yes <input checked="" type="checkbox"/> No
E. Outdoor Burning		
◆ 1.	Outdoor burning is conducted in the application area. <i>If the response to Question I.E.1 is "No," go to Section II.</i>	<input checked="" type="checkbox"/> Yes <input type="checkbox"/> No
◆ 2.	Fire training is conducted in the application area and subject to the exception provided in 30 TAC § 111.205.	<input checked="" type="checkbox"/> Yes <input type="checkbox"/> No
◆ 3.	Fires for recreation, ceremony, cooking, and warmth are used in the application area and subject to the exception provided in 30 TAC § 111.207.	<input checked="" type="checkbox"/> Yes <input type="checkbox"/> No
◆ 4.	Disposal fires are used in the application area and subject to the exception provided in 30 TAC § 111.209.	<input checked="" type="checkbox"/> Yes <input type="checkbox"/> No

Application Area-Wide Applicability Determinations and General Information
Form OP-REQ1 (Page 4)
Federal Operating Permit Program
Texas Commission on Environmental Quality

Date	Permit No.	Regulated Entity No.
04/16/2026	O5	RN100217439

For SOP applications, answer ALL questions unless otherwise directed.

◆ For GOP applications, answer ONLY these questions unless otherwise directed.

I. Title 30 TAC Chapter 111 - Control of Air Pollution from Visible Emissions and Particulate Matter (continued)		
E. Outdoor Burning (continued)		
◆	5. Prescribed burning is used in the application area and subject to the exception provided in 30 TAC § 111.211.	<input checked="" type="checkbox"/> Yes <input type="checkbox"/> No
◆	6. Hydrocarbon burning is used in the application area and subject to the exception provided in 30 TAC § 111.213.	<input checked="" type="checkbox"/> Yes <input type="checkbox"/> No
◆	7. The application area has received the TCEQ Executive Director approval of otherwise prohibited outdoor burning according to 30 TAC § 111.215.	<input checked="" type="checkbox"/> Yes <input type="checkbox"/> No
II. Title 30 TAC Chapter 112 - Control of Air Pollution from Sulfur Compounds		
A. Temporary Fuel Shortage Plan Requirements		
	1. The application area includes units that are potentially subject to the temporary fuel shortage plan requirements of 30 TAC §§ 112.15 - 112.18.	<input type="checkbox"/> Yes <input checked="" type="checkbox"/> No
III. Title 30 TAC Chapter 115 - Control of Air Pollution from Volatile Organic Compounds		
A. Applicability		
◆	1. The application area is located in the Houston/Galveston/Brazoria area, Beaumont/Port Arthur area, Dallas/Fort Worth area, El Paso area, or a covered attainment county as defined by 30 TAC § 115.10. <i>See instructions for inclusive counties. If the response to Question III.A.1 is "No," go to Section IV.</i>	<input checked="" type="checkbox"/> Yes <input type="checkbox"/> No
B. Storage of Volatile Organic Compounds		
◆	1. The application area includes storage tanks, reservoirs, or other containers capable of maintaining working pressure sufficient at all times to prevent any VOC vapor or gas loss to the atmosphere.	<input checked="" type="checkbox"/> Yes <input type="checkbox"/> No

Application Area-Wide Applicability Determinations and General Information
Form OP-REQ1 (Page 5)
Federal Operating Permit Program
Texas Commission on Environmental Quality

Date	Permit No.	Regulated Entity No.
04/16/2026	O5	RN100217439

For SOP applications, answer ALL questions unless otherwise directed.

◆ For GOP applications, answer ONLY these questions unless otherwise directed.

III. Title 30 TAC Chapter 115 - Control of Air Pollution from Volatile Organic Compounds (continued)		
C. Industrial Wastewater		
1.	The application area includes affected VOC wastewater streams of an affected source category, as defined in 30 TAC § 115.140. <i>If the response to Question III.C.1 is "No" or "N/A," go to Section III.D.</i>	<input type="checkbox"/> Yes <input checked="" type="checkbox"/> No <input type="checkbox"/> N/A
2.	The application area is located at a petroleum refinery in the Beaumont/Port Arthur or Houston/Galveston/Brazoria area. <i>If the response to Question III.C.2 is "Yes" and the refinery is in the Beaumont/Port Arthur area, go to Section III.D.</i>	<input type="checkbox"/> Yes <input type="checkbox"/> No
3.	The application area is complying with the provisions of 40 CFR Part 63, Subpart G, as an alternative to complying with this division (relating to Industrial Wastewater). <i>If the response to Question III.C.3 is "Yes," go to Section III.D.</i>	<input type="checkbox"/> Yes <input type="checkbox"/> No
4.	The application area is located at a plant with an annual VOC loading in wastewater, as determined in accordance with 30 TAC § 115.148, less than or equal to 10 Mg (11.03 tons). <i>If the response to Question III.C.4 is "Yes," go to Section III.D.</i>	<input type="checkbox"/> Yes <input type="checkbox"/> No
5.	The application area includes wastewater drains, junction boxes, lift stations, or weirs that are subject to the control requirements of 30 TAC § 115.142(1).	<input type="checkbox"/> Yes <input type="checkbox"/> No
6.	The application area includes wastewater drains, junction boxes, lift stations, or weirs that handle streams chosen for exemption under 30 TAC § 115.147(2).	<input type="checkbox"/> Yes <input type="checkbox"/> No
7.	The application area includes wastewater drains, junction boxes, lift stations, or weirs that have an executive director approved exemption under 30 TAC § 115.147(4).	<input type="checkbox"/> Yes <input type="checkbox"/> No
D. Loading and Unloading of VOCs		
◆ 1.	The application area includes VOC loading operations.	<input type="checkbox"/> Yes <input checked="" type="checkbox"/> No
◆ 2.	The application area includes VOC transport vessel unloading operations. <i>For GOP applications, if the responses to Questions III.D.1 - D.2 are "No," go to Section III.E.</i>	<input checked="" type="checkbox"/> Yes <input type="checkbox"/> No

Application Area-Wide Applicability Determinations and General Information
Form OP-REQ1 (Page 6)
Federal Operating Permit Program
Texas Commission on Environmental Quality

Date	Permit No.	Regulated Entity No.
04/16/2026	O5	RN100217439

For SOP applications, answer ALL questions unless otherwise directed.

◆ For GOP applications, answer ONLY these questions unless otherwise directed.

III. Title 30 TAC Chapter 115 - Control of Air Pollution from Volatile Organic Compounds (continued)		
D. Loading and Unloading of VOCs (continued)		
◆	3. Transfer operations at motor vehicle fuel dispensing facilities are the only VOC transfer operations conducted in the application area.	<input type="checkbox"/> Yes <input checked="" type="checkbox"/> No
E. Filling of Gasoline Storage Vessels (Stage I) for Motor Vehicle Fuel Dispensing Facilities		
◆	1. The application area includes one or more motor vehicle fuel dispensing facilities and gasoline is transferred from a tank-truck tank into a stationary storage container. <i>If the response to Question III.E.1 is "No," go to Section III.F.</i>	<input type="checkbox"/> YES <input checked="" type="checkbox"/> No
◆	2. Transfers to stationary storage containers used exclusively for the fueling of agricultural implements are the only transfer operations conducted at facilities in the application area.	<input type="checkbox"/> YES <input type="checkbox"/> No
◆	3. All transfers at facilities in the application area are made into stationary storage containers with internal floating roofs, external floating roofs, or their equivalent. <i>If the response to Question III.E.2 and/or E.3 is "Yes," go to Section III.F.</i>	<input type="checkbox"/> Yes <input type="checkbox"/> No
◆	4. The application area is located in a covered attainment county as defined in 30 TAC § 115.10. <i>If the response to Question III.E.4 is "No," go to Question III.E.9.</i>	<input type="checkbox"/> Yes <input type="checkbox"/> No
◆	5. Stationary gasoline storage containers with a nominal capacity less than or equal to 1,000 gallons are located at the facility.	<input type="checkbox"/> Yes <input type="checkbox"/> No
◆	6. Stationary gasoline storage containers with a nominal capacity greater than 1,000 gallons are located at the facility.	<input type="checkbox"/> Yes <input type="checkbox"/> No
◆	7. At facilities located in a covered attainment county other than Bastrop, Bexar, Caldwell, Comal, Guadalupe, Hays, Travis, Williamson, or Wilson County, transfers are made to stationary storage tanks greater than 1000 gallons located at a facility which has dispensed less than 100,000 gallons of gasoline in a calendar month after October 31, 2014. <i>If the response to Question III.E.7 is "Yes," go to Section III.F.</i>	<input type="checkbox"/> Yes <input type="checkbox"/> No

Application Area-Wide Applicability Determinations and General Information
Form OP-REQ1 (Page 7)
Federal Operating Permit Program
Texas Commission on Environmental Quality

Date	Permit No.	Regulated Entity No.
04/16/2026	O5	RN100217439

For SOP applications, answer ALL questions unless otherwise directed.

◆ For GOP applications, answer ONLY these questions unless otherwise directed.

III. Title 30 TAC Chapter 115 - Control of Air Pollution from Volatile Organic Compounds (continued)		
E. Filling of Gasoline Storage Vessels (Stage I) for Motor Vehicle Fuel Dispensing Facilities (continued)		
◆	8. At facilities located in Bastrop, Bexar, Caldwell, Comal, Guadalupe, Hays, Travis, Williamson, or Wilson County, transfers are made to stationary storage tanks greater than 1000 gallons located at a facility which has dispensed no more than 25,000 gallons of gasoline in a calendar month after December 31, 2004. <i>If the response to Question III.E.8 is "Yes," go to Section III.F.</i>	<input type="checkbox"/> Yes <input type="checkbox"/> No
◆	9. Transfers are made to stationary storage tanks located at a motor vehicle fuel dispensing facility which has dispensed no more than 10,000 gallons of gasoline in any calendar month after January 1, 1991 and for which construction began prior to November 15, 1992.	<input type="checkbox"/> Yes <input type="checkbox"/> No
◆	10. Transfers are made to stationary storage tanks located at a motor vehicle fuel dispensing facility which has dispensed more than 10,000 gallons of gasoline in any calendar month after January 1, 1991 and for which construction began prior to November 15, 1992.	<input type="checkbox"/> Yes <input type="checkbox"/> No
◆	11. Transfers are made to stationary storage tanks located at a motor vehicle fuel dispensing facility which commenced construction on or after November 15, 1992.	<input type="checkbox"/> Yes <input type="checkbox"/> No
◆	12. At facilities located in Ellis, Johnson, Kaufman, Parker, or Rockwall County, transfers are made to stationary storage tanks located at a facility which has dispensed at least 10,000 gallons of gasoline but less than 125,000 gallons of gasoline in a calendar month after April 30, 2005.	<input type="checkbox"/> Yes <input type="checkbox"/> No
F. Control of VOC Leaks from Transport Vessels (Complete this section for GOP applications for GOPs 511, 512, 513 and 514 only)		
◆	1. Tank-truck tanks are filled with, or emptied of, gasoline at a facility that is subject to 30 TAC § 115.214(a)(1)(C) or 115.224(2) within the application area.	<input type="checkbox"/> Yes <input type="checkbox"/> No <input type="checkbox"/> N/A

Application Area-Wide Applicability Determinations and General Information
Form OP-REQ1 (Page 8)
Federal Operating Permit Program
Texas Commission on Environmental Quality

Date	Permit No.	Regulated Entity No.
04/16/2026	O5	RN100217439

For SOP applications, answer ALL questions unless otherwise directed.

◆ For GOP applications, answer ONLY these questions unless otherwise directed.

III. Title 30 TAC Chapter 115 - Control of Air Pollution from Volatile Organic Compounds (continued)		
F. Control of VOC Leaks from Transport Vessels (Complete this section for GOP applications for GOPs 511, 512, 513 and 514 only) (continued)		
◆ 2.	Tank-truck tanks are filled with non-gasoline VOCs having a TVP greater than or equal to 0.5 psia under actual storage conditions at a facility subject to 30 TAC § 115.214(a)(1)(C) within the application area.	<input type="checkbox"/> Yes <input type="checkbox"/> No <input type="checkbox"/> N/A
◆ 3.	Tank-truck tanks are filled with, or emptied of, gasoline at a facility that is subject to 30 TAC § 115.214(b)(1)(C) or 115.224(2) within the application area.	<input type="checkbox"/> Yes <input type="checkbox"/> No <input type="checkbox"/> N/A
G. Control of Vehicle Refueling Emissions (Stage II) at Motor Vehicle Fuel Dispensing Facilities		
◆ 1.	The application area includes one or more motor vehicle fuel dispensing facilities and gasoline is transferred from a stationary storage container into motor vehicle fuel tanks. <i>If the response to Question III.G.1 is "No" or "N/A," go to Section III.H.</i>	<input type="checkbox"/> Yes <input type="checkbox"/> No <input checked="" type="checkbox"/> N/A
◆ 2.	The application area includes facilities that began construction on or after November 15, 1992 and prior to May 16, 2012.	<input type="checkbox"/> Yes <input type="checkbox"/> No
◆ 3.	The application area includes facilities that began construction prior to November 15, 1992. <i>If the responses to Questions III.G.2 and III.G.3 are both "No," go to Section III.H.</i>	<input type="checkbox"/> Yes <input type="checkbox"/> No
◆ 4.	The application area includes only facilities that have a monthly throughput of less than 10,000 gallons of gasoline.	<input type="checkbox"/> Yes <input type="checkbox"/> No
◆ 5.	The decommissioning of all Stage II vapor recovery control equipment located in the application area has been completed and the decommissioning notice submitted.	<input type="checkbox"/> Yes <input type="checkbox"/> No <input type="checkbox"/> N/A

Application Area-Wide Applicability Determinations and General Information
Form OP-REQ1 (Page 9)
Federal Operating Permit Program
Texas Commission on Environmental Quality

Date	Permit No.	Regulated Entity No.
04/16/2026	O5	RN100217439

For SOP applications, answer ALL questions unless otherwise directed.

◆ For GOP applications, answer ONLY these questions unless otherwise directed.

III. Title 30 TAC Chapter 115 - Control of Air Pollution from Volatile Organic Compounds (continued)		
H. Control of Reid Vapor Pressure (RVP) of Gasoline		
◆	1. The application area includes stationary tanks, reservoirs, or other containers holding gasoline that may ultimately be used in a motor vehicle in El Paso County. <i>If the response to Question III.H.1 is "No" or "N/A," go to Section III.I.</i>	<input type="checkbox"/> Yes <input type="checkbox"/> No <input checked="" type="checkbox"/> N/A
◆	2. The application area includes stationary tanks, reservoirs, or other containers holding gasoline that will be used exclusively for the fueling of agricultural implements.	<input type="checkbox"/> Yes <input type="checkbox"/> No
◆	3. The application area includes a motor vehicle fuel dispensing facility.	<input type="checkbox"/> Yes <input type="checkbox"/> No
◆	4. The application area includes stationary tanks, reservoirs, or other containers holding gasoline and having a nominal capacity of 500 gallons or less.	<input type="checkbox"/> Yes <input type="checkbox"/> No
I. Process Unit Turnaround and Vacuum-Producing Systems in Petroleum Refineries		
	1. The application area is located at a petroleum refinery.	<input type="checkbox"/> Yes <input checked="" type="checkbox"/> No
J. Surface Coating Processes (Complete this section for GOP applications only.)		
◆	1. Surface coating operations (other than those performed on equipment located on-site and in-place) that meet the exemption specified in 30 TAC § 115.427(3)(A) or 115.427(7) are performed in the application area.	<input type="checkbox"/> Yes <input type="checkbox"/> No <input type="checkbox"/> N/A

Application Area-Wide Applicability Determinations and General Information
Form OP-REQ1 (Page 10)
Federal Operating Permit Program
Texas Commission on Environmental Quality

Date	Permit No.	Regulated Entity No.
04/16/2026	O5	RN100217439

For SOP applications, answer ALL questions unless otherwise directed.

◆ For GOP applications, answer ONLY these questions unless otherwise directed.

III. Title 30 TAC Chapter 115 - Control of Air Pollution from Volatile Organic Compounds (continued)		
K. Cutback Asphalt		
1.	Conventional cutback asphalt containing VOC solvents for the paving of roadways, driveways, or parking lots, is used or specified for use in the application area by a state, municipal, or county agency. <i>If the response to Question III.K.1 is "N/A," go to Section III.L.</i>	<input type="checkbox"/> Yes <input type="checkbox"/> No <input checked="" type="checkbox"/> N/A
2.	The use, application, sale, or offering for sale of conventional cutback asphalt containing VOC solvents for the paving of roadways, driveways, or parking lots occurs in the application area.	<input type="checkbox"/> Yes <input type="checkbox"/> No <input type="checkbox"/> N/A
3.	Asphalt emulsion is used or produced within the application area.	<input type="checkbox"/> Yes <input type="checkbox"/> No
4.	The application area is using an alternate control requirement as specified in 30 TAC § 115.513. <i>If the response to Question III.K.4 is "No," go to Section III.L.</i>	<input type="checkbox"/> Yes <input type="checkbox"/> No
5.	The application area uses, applies, sells, or offers for sale asphalt concrete, made with cutback asphalt, that meets the exemption specified in 30 TAC § 115.517(1).	<input type="checkbox"/> Yes <input type="checkbox"/> No
6.	The application area uses, applies, sells, or offers for sale cutback asphalt that is used solely as a penetrating prime coat.	<input type="checkbox"/> Yes <input type="checkbox"/> No
7.	The applicant using cutback asphalt is a state, municipal, or county agency.	<input type="checkbox"/> Yes <input type="checkbox"/> No
L. Degassing of Storage Tanks, Transport Vessels and Marine Vessels		
◆ 1.	The application area includes degassing operations for stationary, marine, and/or transport vessels. <i>If the response to Question III.L.1 is "No" or "N/A," go to Section III.M.</i>	<input type="checkbox"/> Yes <input type="checkbox"/> No <input checked="" type="checkbox"/> N/A
◆ 2.	Degassing of only ocean-going, self-propelled VOC marine vessels is performed in the application area. <i>If the response to Question III.L.2 is "Yes," go to Section III.M.</i>	<input type="checkbox"/> Yes <input type="checkbox"/> No <input type="checkbox"/> N/A

Application Area-Wide Applicability Determinations and General Information
Form OP-REQ1 (Page 11)
Federal Operating Permit Program
Texas Commission on Environmental Quality

Date	Permit No.	Regulated Entity No.
04/16/2026	O5	RN100217439

For SOP applications, answer ALL questions unless otherwise directed.

◆ For GOP applications, answer ONLY these questions unless otherwise directed.

III. Title 30 TAC Chapter 115 - Control of Air Pollution from Volatile Organic Compounds (continued)		
L. Degassing of Storage Tanks, Transport Vessels and Marine Vessels (continued)		
◆ 3.	Degassing of stationary VOC storage vessels with a nominal storage capacity of 1,000,000 gallons or more and a vapor space partial pressure greater than or equal to 0.5 psia of VOC is performed in the application area.	<input type="checkbox"/> Yes <input type="checkbox"/> No <input type="checkbox"/> N/A
◆ 4.	Degassing of stationary VOC storage vessels with a nominal storage capacity of 250,000 gallons or more, or a nominal storage capacity of 75,000 gallons and storing materials with a true vapor pressure greater than 2.6 psia, and a vapor space partial pressure greater than or equal to 0.5 psia of VOC is performed in the application area.	<input type="checkbox"/> Yes <input type="checkbox"/> No <input type="checkbox"/> N/A
◆ 5.	Degassing of VOC transport vessels with a nominal storage capacity of 8,000 gallons or more and a vapor space partial pressure greater than or equal to 0.5 psia of VOC is performed in the application area.	<input type="checkbox"/> Yes <input type="checkbox"/> No
◆ 6.	Degassing of VOC marine vessels with a nominal storage capacity of 10,000 barrels (420,000 gallons) or more and a vapor space partial pressure greater than or equal to 0.5 psia of VOC is performed in the application area.	<input type="checkbox"/> Yes <input type="checkbox"/> No <input type="checkbox"/> N/A
◆ 7.	Degassing of VOC marine vessels with a nominal storage capacity of 10,000 barrels (420,000 gallons) and a vapor space partial pressure \geq 0.5 psia that have sustained damage as specified in 30 TAC § 115.547(5) is performed in the application area.	<input type="checkbox"/> Yes <input type="checkbox"/> No <input type="checkbox"/> N/A
M. Petroleum Dry Cleaning Systems		
1.	The application area contains one or more petroleum dry cleaning facilities that use petroleum-based solvents.	<input type="checkbox"/> Yes <input type="checkbox"/> No <input checked="" type="checkbox"/> N/A

Application Area-Wide Applicability Determinations and General Information
Form OP-REQ1 (Page 12)
Federal Operating Permit Program
Texas Commission on Environmental Quality

Date	Permit No.	Regulated Entity No.
04/16/2026	O5	RN100217439

For SOP applications, answer ALL questions unless otherwise directed.

◆ For GOP applications, answer ONLY these questions unless otherwise directed.

III. Title 30 TAC Chapter 115 - Control of Air Pollution from Volatile Organic Compounds (continued)		
N. Vent Gas Control (Highly Reactive Volatile Organic Compounds (HRVOC))		
1.	The application area includes one or more vent gas streams containing HRVOC.	<input type="checkbox"/> Yes <input type="checkbox"/> No <input checked="" type="checkbox"/> N/A
2.	The application area includes one or more flares that emit or have the potential to emit HRVOC. <i>If the responses to Questions III.N.1 and III.N.2 are both "No" or "N/A," go to Section III.O. If the response to Question III.N.1 is "Yes," continue with Question III.N.3.</i>	<input type="checkbox"/> Yes <input type="checkbox"/> No <input checked="" type="checkbox"/> N/A
3.	All vent streams in the application area that are routed to a flare contain less than 5.0% HRVOC by weight at all times.	<input type="checkbox"/> Yes <input type="checkbox"/> No
4.	All vent streams in the application area that are not routed to a flare contain less than 100 ppmv HRVOC at all times. <i>If the responses to Questions III.N.3 and III.N.4 are both "Yes," go to Section III.O.</i>	<input type="checkbox"/> Yes <input type="checkbox"/> No
5.	The application area contains pressure relief valves that are not controlled by a flare.	<input type="checkbox"/> Yes <input type="checkbox"/> No
6.	The application area has at least one vent stream which has no potential to emit HRVOC.	<input type="checkbox"/> Yes <input type="checkbox"/> No
7.	The application area has vent streams from a source described in 30 TAC § 115.727(c)(3)(A) - (H).	<input type="checkbox"/> Yes <input type="checkbox"/> No
O. Cooling Tower Heat Exchange Systems (HRVOC)		
1.	The application area includes one or more cooling tower heat exchange systems that emit or have the potential to emit HRVOC.	<input type="checkbox"/> Yes <input type="checkbox"/> No <input checked="" type="checkbox"/> N/A

Application Area-Wide Applicability Determinations and General Information
Form OP-REQ1 (Page 13)
Federal Operating Permit Program
Texas Commission on Environmental Quality

Date	Permit No.	Regulated Entity No.
04/16/2026	O5	RN100217439

For SOP applications, answer ALL questions unless otherwise directed.

◆ For GOP applications, answer ONLY these questions unless otherwise directed.

IV. Title 30 TAC Chapter 117 - Control of Air Pollution from Nitrogen Compounds		
A. Applicability		
◆	<p>1. The application area is located in the Houston/Galveston/Brazoria, Beaumont/Port Arthur, or Dallas/Fort Worth Eight-Hour area. <i>For SOP applications, if the response to Question IV.A.1 is "Yes," complete Sections IV.B - IV.F and IV.H.</i> <i>For GOP applications for GOPs 511, 512, 513, or 514, if the response to Question IV.A.1 is "Yes," go to Section IV.F.</i> <i>For GOP applications for GOP 517, if the response to Question IV.A.1 is "Yes," complete Sections IV.C and IV.F.</i> <i>For GOP applications, if the response to Question IV.A.1 is "No," go to Section VI.</i></p>	<input type="checkbox"/> Yes <input checked="" type="checkbox"/> No
	<p>2. The application area is located in Bexar, Comal, Ellis, Hays, or McLennan County and includes a cement kiln. <i>If the response to Question IV.A.2 is "Yes," go to Question IV.H.1.</i></p>	<input type="checkbox"/> Yes <input checked="" type="checkbox"/> No
	<p>3. The application area includes a utility electric generator in an east or central Texas county. <i>See instructions for a list of counties included.</i> <i>If the response to Question IV.A.3 is "Yes," go to Question IV.G.1.</i> <i>If the responses to Questions IV.A.1 - 3 are all "No," go to Question IV.H.1.</i> Note that utility electric generators in Bexar County are no longer subject to 30 TAC Chapter 117, Subchapter E, Division 1, as of 1/1/2025. Therefore, the response is "NO".</p>	<input type="checkbox"/> Yes <input checked="" type="checkbox"/> No
B. Utility Electric Generation in Ozone Nonattainment Areas		
	<p>1. The application area includes units specified in 30 TAC §§ 117.1000, 117.1200, or 117.1300. <i>If the response to Question IV.B.1 is "No," go to Question IV.C.1.</i></p>	<input type="checkbox"/> Yes <input type="checkbox"/> No
	<p>2. The application area is complying with a System Cap in 30 TAC §§ 117.1020 or 117.1220.</p>	<input type="checkbox"/> Yes <input type="checkbox"/> No

Application Area-Wide Applicability Determinations and General Information
Form OP-REQ1 (Page 14)
Federal Operating Permit Program
Texas Commission on Environmental Quality

Date	Permit No.	Regulated Entity No.
04/16/2026	O5	RN100217439

For SOP applications, answer ALL questions unless otherwise directed.

◆ For GOP applications, answer ONLY these questions unless otherwise directed.

IV. Title 30 TAC Chapter 117 - Control of Air Pollution from Nitrogen Compounds (continued)		
C. Commercial, Institutional, and Industrial Sources in Ozone Nonattainment Areas		
◆ 1.	The application area is located at a site subject to 30 TAC Chapter 117, Subchapter B and includes units specified in 30 TAC §§ 117.100, 117.300, or 117.400. <i>For SOP applications, if the response to Question IV.C.1 is "No," go to Question IV.D.1. For GOP applications for GOP 517, if the response to Question IV.C.1 is "No," go to Section IV.F.</i>	<input type="checkbox"/> Yes <input type="checkbox"/> NO
◆ 2.	The application area is located at a site that was a major source of NO _x before November 15, 1992.	<input type="checkbox"/> Yes <input type="checkbox"/> No <input type="checkbox"/> N/A
◆ 3.	The application area includes an electric generating facility required to comply with the System Cap in 30 TAC § 117.320.	<input type="checkbox"/> Yes <input type="checkbox"/> No
D. Adipic Acid Manufacturing		
1.	The application area is located at, or part of, an adipic acid production unit.	<input type="checkbox"/> Yes <input type="checkbox"/> No <input type="checkbox"/> N/A
E. Nitric Acid Manufacturing - Ozone Nonattainment Areas		
1.	The application area is located at, or part of, a nitric acid production unit.	<input type="checkbox"/> Yes <input type="checkbox"/> No <input type="checkbox"/> N/A
F. Combustion Control at Minor Sources in Ozone Nonattainment Areas - Boilers, Process Heaters, Stationary Engines and Gas Turbines		
◆ 1.	The application area is located at a site that is a minor source of NO _x in the Houston/Galveston/Brazoria or Dallas/Fort Worth Eight-Hour areas (except for Wise County). <i>For SOP applications, if the response to Question IV.F.1 is "No," go to Question IV.G.1. For GOP applications, if the response to Question IV.F.1 is "No," go to Section VI.</i>	<input type="checkbox"/> Yes <input type="checkbox"/> No
◆ 2.	The application area is located in the Houston/Galveston/Brazoria area and has units that qualify for an exemption under 30 TAC § 117.2003(a).	<input type="checkbox"/> Yes <input type="checkbox"/> No
◆ 3.	The application area is located in the Houston/Galveston/Brazoria area and has units that qualify for an exemption under 30 TAC § 117.2003(b).	<input type="checkbox"/> Yes <input type="checkbox"/> No

Application Area-Wide Applicability Determinations and General Information
Form OP-REQ1 (Page 15)
Federal Operating Permit Program
Texas Commission on Environmental Quality

Date	Permit No.	Regulated Entity No.
04/16/2026	O5	RN100217439

For SOP applications, answer ALL questions unless otherwise directed.

◆ For GOP applications, answer ONLY these questions unless otherwise directed.

IV. Title 30 TAC Chapter 117 - Control of Air Pollution from Nitrogen Compounds (continued)		
F. Combustion Control at Minor Sources in Ozone Nonattainment Areas - Boilers, Process Heaters, Stationary Engines and Gas Turbines (continued)		
◆ 4.	The application area is located in the Dallas/Fort Worth Eight-Hour area (except for Wise County) and has units that qualify for an exemption under 30 TAC § 117.2103.	<input type="checkbox"/> Yes <input type="checkbox"/> No
◆ 5.	The application area has units subject to the emission specifications under 30 TAC §§ 117.2010 or 30 TAC § 117.2110.	<input type="checkbox"/> Yes <input type="checkbox"/> No
6.	The application area has a unit that has been approved for alternative case specific specifications (ACSS) in 30 TAC § 117.2025 or 30 TAC § 117.2125. <i>If the response to Question IV.F.6 is "No," go to Section IV.G.</i>	<input type="checkbox"/> Yes <input type="checkbox"/> No
7.	An ACSS for carbon monoxide (CO) has been approved?	<input type="checkbox"/> Yes <input type="checkbox"/> No
8.	An ACSS for ammonia (NH ₃) has been approved?	<input type="checkbox"/> Yes <input type="checkbox"/> No
9.	Provide the Permit Number(s) and authorization/issuance date(s) of the NSR project(s) that incorporates an ACSS below.	
G. Utility Electric Generation in East and Central Texas		
1.	The application area includes utility electric power boilers and/or stationary gas turbines (including duct burners used in turbine exhaust ducts) that were placed into service before December 31, 1995. <i>If the response to Question IV.G.1 is "No," go to Question IV.H.1.</i>	<input type="checkbox"/> Yes <input type="checkbox"/> No
2.	The application area is complying with the System Cap in 30 TAC § 117.3020.	<input type="checkbox"/> Yes <input type="checkbox"/> No
H. Multi-Region Combustion Control - Water Heaters, Small Boilers, and Process Heaters		
1.	The application area includes a manufacturer, distributor, retailer or installer of natural gas fired water heaters, boilers or process heaters with a maximum rated capacity of 2.0 MMBtu/hr or less. <i>If the response to question IV.H.1 is "No," go to Section V.</i>	<input type="checkbox"/> Yes <input checked="" type="checkbox"/> No
2.	All water heaters, boilers or process heaters manufactured, distributed, retailed or installed qualify for an exemption under 30 TAC § 117.3203.	<input type="checkbox"/> Yes <input type="checkbox"/> No

Application Area-Wide Applicability Determinations and General Information
Form OP-REQ1 (Page 16)
Federal Operating Permit Program
Texas Commission on Environmental Quality

Date	Permit No.	Regulated Entity No.
04/16/2026	O5	RN100217439

For SOP applications, answer ALL questions unless otherwise directed.

◆ For GOP applications, answer ONLY these questions unless otherwise directed.

V. Title 40 Code of Federal Regulations Part 59 (40 CFR Part 59) - National Volatile Organic Compound Emission Standards for Consumer and Commercial Products		
A. Subpart B - National Volatile Organic Compound Emission Standards for Automobile Refinish Coatings		
1.	The application area manufactures automobile refinish coatings or coating components and sells or distributes these coatings or coating components in the United States.	<input type="checkbox"/> Yes <input checked="" type="checkbox"/> No
2.	The application area imports automobile refinish coatings or coating components, manufactured on or after January 11, 1999, and sells or distributes these coatings or coating components in the United States. <i>If the responses to Questions V.A.1 and V.A.2 are both "No," go to Section V.B.</i>	<input type="checkbox"/> Yes <input checked="" type="checkbox"/> No
3.	All automobile refinish coatings or coating components manufactured or imported by the application area meet one or more of the exemptions specified in 40 CFR § 59.100(c)(1) - (6).	<input type="checkbox"/> Yes <input type="checkbox"/> No
B. Subpart C - National Volatile Organic Compound Emission Standards for Consumer Products		
1.	The application area manufactures consumer products for sale or distribution in the United States.	<input type="checkbox"/> Yes <input checked="" type="checkbox"/> No
2.	The application area imports consumer products manufactured on or after December 10, 1998 and sells or distributes these consumer products in the United States.	<input type="checkbox"/> Yes <input checked="" type="checkbox"/> No
3.	The application area is a distributor of consumer products whose name appears on the label of one or more of the products. <i>If the responses to Questions V.B.1 - V.B.3 are all "No," go to Section V.C.</i>	<input type="checkbox"/> Yes <input checked="" type="checkbox"/> No
4.	All consumer products manufactured, imported, or distributed by the application area meet one or more of the exemptions specified in 40 CFR § 59.201(c)(1) - (7).	<input type="checkbox"/> Yes <input type="checkbox"/> No

Application Area-Wide Applicability Determinations and General Information
Form OP-REQ1 (Page 17)
Federal Operating Permit Program
Texas Commission on Environmental Quality

Date	Permit No.	Regulated Entity No.
04/16/2026	O5	RN100217439

For SOP applications, answer ALL questions unless otherwise directed.

◆ For GOP applications, answer ONLY these questions unless otherwise directed.

V. Title 40 Code of Federal Regulations Part 59 (40 CFR Part 59) - National Volatile Organic Compound Emission Standards for Consumer and Commercial Products (continued)	
C. Subpart D - National Volatile Organic Compound Emission Standards for Architectural Coatings	
1. The application area manufactures or imports architectural coatings for sale or distribution in the United States.	<input type="checkbox"/> Yes <input checked="" type="checkbox"/> No
2. The application area manufactures or imports architectural coatings that are registered under the Federal Insecticide, Fungicide, and Rodenticide Act. <i>If the responses to Questions V.C.1-2 are both "No," go to Section V.D.</i>	<input type="checkbox"/> Yes <input checked="" type="checkbox"/> No
3. All architectural coatings manufactured or imported by the application area meet one or more of the exemptions specified in 40 CFR §59.400(c)(1)-(5).	<input type="checkbox"/> Yes <input type="checkbox"/> No
D. Subpart E - National Volatile Organic Compound Emission Standards for Aerosol Coatings	
1. The application area manufactures or imports aerosol coating products for sale or distribution in the United States.	<input type="checkbox"/> Yes <input checked="" type="checkbox"/> No
2. The application area is a distributor of aerosol coatings for resale or distribution in the United States.	<input type="checkbox"/> Yes <input checked="" type="checkbox"/> No
E. Subpart F - Control of Evaporative Emissions from New and In-Use Portable Fuel Containers	
1. The application area manufactures or imports portable fuel containers for sale or distribution in the United States. <i>If the response to Question V.E.1 is "No," go to Section VI.</i>	<input type="checkbox"/> Yes <input checked="" type="checkbox"/> No
2. All portable fuel containers manufactured or imported by the application area meet one or more of the exemptions specified in 40 CFR § 59.605(a) - (c).	<input type="checkbox"/> Yes <input type="checkbox"/> No
VI. Title 40 Code of Federal Regulations Part 60 - New Source Performance Standards	
A. Applicability	
◆ 1. The application area includes a unit(s) that is subject to one or more 40 CFR Part 60 subparts. <i>If the response to Question VI.A.1 is "No," go to Section VII.</i>	<input checked="" type="checkbox"/> Yes <input type="checkbox"/> No

Application Area-Wide Applicability Determinations and General Information
Form OP-REQ1 (Page 18)
Federal Operating Permit Program
Texas Commission on Environmental Quality

Date	Permit No.	Regulated Entity No.
04/16/2026	O5	RN100217439

For SOP applications, answer ALL questions unless otherwise directed.

◆ For GOP applications, answer ONLY these questions unless otherwise directed.

VI. Title 40 Code of Federal Regulations Part 60 - New Source Performance Standards (continued)	
B. Subpart Y - Standards of Performance for Coal Preparation and Processing Plants	
1. The application area is located at a coal preparation and processing plant. <i>If the response to Question VI.B.1 is "No," go to Section VI.C.</i>	<input type="checkbox"/> Yes <input checked="" type="checkbox"/> No
2. The coal preparation and processing plant has a design capacity greater than 200 tons per day (tpd). <i>If the response to Question VI.B.2 is "No," go to Section VI.C.</i>	<input type="checkbox"/> Yes <input type="checkbox"/> No
3. The plant has an option to enforceably limit its operating level to less than 200 tpd and is choosing this option. <i>If the response to Question VI.B.3 is "Yes," go to Section VI.C.</i>	<input type="checkbox"/> Yes <input type="checkbox"/> No
4. The plant contains an open storage pile, as defined in § 60.251, as an affected facility. <i>If the response to Question VI.B.4 is "No," go to Section VI.C.</i>	<input type="checkbox"/> Yes <input type="checkbox"/> No
5. The open storage pile was constructed, reconstructed or modified after May 27, 2009.	<input type="checkbox"/> Yes <input type="checkbox"/> No
C. Subpart GG - Standards of Performance for Stationary Gas Turbines (GOP applicants only)	
◆ 1. The application area includes one or more stationary gas turbines that have a heat input at peak load greater than or equal to 10 MMBtu/hr (10.7GJ/hr), based on the lower heating value of the fuel fired. <i>If the response to Question VI.C.1 is "No" or "N/A," go to Section VI.E.</i>	<input type="checkbox"/> Yes <input type="checkbox"/> No <input type="checkbox"/> N/A
◆ 2. One or more of the affected facilities were constructed, modified, or reconstructed after October 3, 1977 and prior to February 19, 2005. <i>If the response to Question VI.C.2 is "No," go to Section VI.E.</i>	<input type="checkbox"/> Yes <input type="checkbox"/> No
◆ 3. One or more stationary gas turbines in the application area are using a previously approved alternative fuel monitoring schedule as specified in 40 CFR § 60.334(h)(4).	<input type="checkbox"/> Yes <input type="checkbox"/> No
◆ 4. The exemption specified in 40 CFR § 60.332(e) is being utilized for one or more stationary gas turbines in the application area.	<input type="checkbox"/> Yes <input type="checkbox"/> No

Application Area-Wide Applicability Determinations and General Information
Form OP-REQ1 (Page 19)
Federal Operating Permit Program
Texas Commission on Environmental Quality

Date	Permit No.	Regulated Entity No.
04/16/2026	O5	RN100217439

- For SOP applications, answer ALL questions unless otherwise directed.
- ◆ For GOP applications, answer ONLY these questions unless otherwise directed.

VI. Title 40 Code of Federal Regulations Part 60 - New Source Performance Standards (continued)		
C. Subpart GG - Standards of Performance for Stationary Gas Turbines (GOP applicants only) (continued)		
◆	5. One or more stationary gas turbines subject to 40 CFR Part 60, Subpart GG in the application area is injected with water or steam for the control of nitrogen oxides.	<input type="checkbox"/> Yes <input type="checkbox"/> No
D. Subpart XX - Standards of Performance for Bulk Gasoline Terminals		
	1. The application area includes bulk gasoline terminal loading racks. <i>If the response to Question VI.D.1 is "No," go to Section VI.E.</i>	<input type="checkbox"/> Yes <input checked="" type="checkbox"/> No <input type="checkbox"/> N/A
	2. One or more of the loading racks were constructed or modified after December 17, 1980, and are not subject to 40 CFR Part 63, Subpart CC.	<input type="checkbox"/> Yes <input type="checkbox"/> No
E. Subpart LLL - Standards of Performance for Onshore Natural Gas Processing: Sulfur Dioxide (SO₂) Emissions		
◆	1. The application area includes affected facilities identified in 40 CFR § 60.640(a) that process natural gas (onshore). <i>For SOP applications, if the response to Question VI.E.1 is "No," go to Section VI.F. For GOP applications, if the response to Question VI.E.1 is or "N/A," go to Section VI.H.</i>	<input type="checkbox"/> Yes <input checked="" type="checkbox"/> No
◆	2. The affected facilities commenced construction or modification after January 20, 1984 and on or before August 23, 2011. <i>For SOP applications, if the response to Question VI.E.2 is "NO," go to Section VI.F. For GOP applications, if the response to Question VI.E.2 is "No," go to Section VI.H.</i>	<input type="checkbox"/> Yes <input type="checkbox"/> No
◆	3. The application area includes a gas sweetening unit with a design capacity greater than or equal to 2 long tons per day (LTPD) of hydrogen sulfide but operates at less than 2 LTPD. <i>For SOP applications, if the response to Question VI.E.3 is "No," go to Section VI.F. For GOP applications, if the response to Question VI.E.3 is "No," go to Section VI.H.</i>	<input type="checkbox"/> Yes <input type="checkbox"/> No

Application Area-Wide Applicability Determinations and General Information
Form OP-REQ1 (Page 20)
Federal Operating Permit Program
Texas Commission on Environmental Quality

Date	Permit No.	Regulated Entity No.
04/16/2026	O5	RN100217439

For SOP applications, answer ALL questions unless otherwise directed.

◆ For GOP applications, answer ONLY these questions unless otherwise directed.

VI. Title 40 Code of Federal Regulations Part 60 - New Source Performance Standards (continued)	
E. Subpart LLL - Standards of Performance for Onshore Natural Gas Processing: Sulfur Dioxide (SO₂) Emissions (continued)	
◆ 4. Federally enforceable operating limits have been established in the preconstruction authorization limiting the gas sweetening unit to less than 2 LTPD. <i>For SOP applications, if the response to Question VI.E.4. is "No," go to Section VI.F. For GOP applications, if the response to Question VI.E.4. is "No," go to Section VI.H.</i>	<input type="checkbox"/> Yes <input type="checkbox"/> No
◆ 5. Please provide the Unit ID(s) for the gas sweetening unit(s) that have established federally enforceable operating limits in the space provided below	
F. Subpart OOO - Standards of Performance for Nonmetallic Mineral Processing Plants	
1. The application area includes affected facilities identified in 40 CFR § 60.670(a)(1) that are located at a fixed or portable nonmetallic mineral processing plant. <i>If the response to Question VI.F.1 is "No," go to Section VI.G.</i>	<input type="checkbox"/> Yes <input checked="" type="checkbox"/> No
2. Affected facilities identified in 40 CFR § 60.670(a)(1) and located in the application area are subject to 40 CFR Part 60, Subpart OOO.	<input type="checkbox"/> Yes <input type="checkbox"/> No
G. Subpart QQQ - Standards of Performance for VOC Emissions from Petroleum Refinery Wastewater Systems	
1. The application area is located at a petroleum refinery and includes one or more of the affected facilities identified in 40 CFR § 60.690(a)(2) - (4) for which construction, modification, or reconstruction was commenced after May 4, 1987. <i>If the response to Question VI.G.1 is "No," go to Section VI.H.</i>	<input type="checkbox"/> Yes <input checked="" type="checkbox"/> No
2. The application area includes storm water sewer systems.	<input type="checkbox"/> Yes <input type="checkbox"/> No

Application Area-Wide Applicability Determinations and General Information
Form OP-REQ1 (Page 21)
Federal Operating Permit Program
Texas Commission on Environmental Quality

Date	Permit No.	Regulated Entity No.
04/16/2026	O5	RN100217439

For SOP applications, answer ALL questions unless otherwise directed.

◆ For GOP applications, answer ONLY these questions unless otherwise directed.

VI. Title 40 Code of Federal Regulations Part 60 - New Source Performance Standards (continued)		
G. Subpart QQQ - Standards of Performance for VOC Emissions from Petroleum Refinery Wastewater Systems (continued)		
3.	The application area includes ancillary equipment which is physically separate from the wastewater system and does not come in contact with or store oily wastewater.	<input type="checkbox"/> Yes <input type="checkbox"/> No
4.	The application area includes non-contact cooling water systems.	<input type="checkbox"/> Yes <input type="checkbox"/> No
5.	The application area includes individual drain systems. <i>If the response to Question VI.G.5 is "No," go to Section VI.H.</i>	<input type="checkbox"/> Yes <input type="checkbox"/> No
6.	The application area includes one or more individual drain systems that meet the exemption specified in 40 CFR § 60.692-2(d).	<input type="checkbox"/> Yes <input type="checkbox"/> No
7.	The application area includes completely closed drain systems.	<input type="checkbox"/> Yes <input type="checkbox"/> No
H. Subpart AAAA - Standards of Performance for Small Municipal Waste Incineration Units for Which Construction Commenced After August 30, 1999 or for Which Modification or Reconstruction Commenced on or After June 6, 2004		
◆ 1.	The application area includes at least one small municipal waste incineration unit, other than an air curtain incinerator. <i>If the response to Question VI.H.1. is "N/A," go to Section VI.I. If the response to Question VI.H.1 is "No," go to Question VI.H.4.</i>	<input type="checkbox"/> Yes <input checked="" type="checkbox"/> No <input type="checkbox"/> N/A
◆ 2.	The application area includes at least one small municipal waste incineration unit, other than an air curtain incinerator, constructed after August 30, 1999 or modified or reconstructed on or after June 6, 2006.	<input type="checkbox"/> Yes <input type="checkbox"/> No
◆ 3.	The application area includes at least one small municipal waste incineration unit, other than an air curtain incinerator, constructed before August 30, 1999 and not modified or reconstructed on or after June 6, 2006.	<input type="checkbox"/> Yes <input type="checkbox"/> No
◆ 4.	The application area includes at least one air curtain incinerator. <i>If the response to Question VI.H.4 is "No," go to Section VI.I.</i>	<input type="checkbox"/> Yes <input checked="" type="checkbox"/> No

Application Area-Wide Applicability Determinations and General Information
Form OP-REQ1 (Page 22)
Federal Operating Permit Program
Texas Commission on Environmental Quality

Date	Permit No.	Regulated Entity No.
04/16/2026	O5	RN100217439

For SOP applications, answer ALL questions unless otherwise directed.

◆ For GOP applications, answer ONLY these questions unless otherwise directed.

VI. Title 40 Code of Federal Regulations Part 60 - New Source Performance Standards (continued)		
H. Subpart AAAA - Standards of Performance for Small Municipal Waste Incineration Units for Which Construction Commenced After August 30, 1999 or for Which Modification or Reconstruction Commenced on or After June 6, 2004 (continued)		
◆	5. The application area includes at least one air curtain incinerator constructed after August 30, 1999 or modified or reconstructed on or after June 6, 2006. <i>If the response to Question VI.H.5 is "No," go to Question VI.H.7.</i>	<input type="checkbox"/> Yes <input type="checkbox"/> No
◆	6. All air curtain incinerators constructed after August 30, 1999 or modified or reconstructed on or after June 6, 2006 combust only yard waste.	<input type="checkbox"/> Yes <input type="checkbox"/> No
◆	7. The application area includes at least one air curtain incinerator constructed before August 30, 1999 and not modified or reconstructed on or after June 6, 2006.	<input type="checkbox"/> Yes <input type="checkbox"/> No
◆	8. All air curtain incinerators constructed before August 30, 1999 and not modified or reconstructed on or after June 6, 2006 combust only yard waste.	<input type="checkbox"/> Yes <input type="checkbox"/> No
I. Subpart CCCC - Standards of Performance for Commercial and Industrial Solid Waste Incineration Units for Which Construction Commenced After November 30, 1999 or for Which Modification or Reconstruction Commenced on or After June 1, 2001		
◆	1. The application area includes at least one commercial or industrial solid waste incineration unit, other than an air curtain incinerator. <i>If the response to Question VI.I.1 is "N/A," go to Section VI.J. If the response to Question VI.I.1 is "No," go to Question VI.I.4.</i>	<input type="checkbox"/> Yes <input checked="" type="checkbox"/> No <input type="checkbox"/> N/A
◆	2. The application area includes at least one commercial or industrial solid waste incineration unit, other than an air curtain incinerator, constructed after November 30, 1999 or modified or reconstructed on or after June 1, 2001.	<input type="checkbox"/> Yes <input type="checkbox"/> No

Application Area-Wide Applicability Determinations and General Information
Form OP-REQ1 (Page 23)
Federal Operating Permit Program
Texas Commission on Environmental Quality

Date	Permit No.	Regulated Entity No.
04/16/2026	O5	RN100217439

For SOP applications, answer ALL questions unless otherwise directed.

◆ For GOP applications, answer ONLY these questions unless otherwise directed.

VI. Title 40 Code of Federal Regulations Part 60 - New Source Performance Standards (continued)		
I. Subpart CCCC - Standards of Performance for Commercial and Industrial Solid Waste Incineration Units for Which Construction Commenced After November 30, 1999 or for Which Modification or Reconstruction Commenced on or After June 1, 2001 (continued)		
◆ 3.	The application area includes at least one commercial or industrial solid waste incineration unit, other than an air curtain incinerator, constructed before November 30, 1999 and not modified or reconstructed on or after June 1, 2001.	<input type="checkbox"/> Yes <input type="checkbox"/> No
◆ 4.	The application area includes at least one air curtain incinerator. <i>If the response to Question VI.I.4 is "No," go to Section VI.J.</i>	<input type="checkbox"/> Yes <input checked="" type="checkbox"/> No
◆ 5.	The application area includes at least one air curtain incinerator, constructed after November 30, 1999 or modified or reconstructed on or after June 1, 2001. <i>If the response to Question VI.I.5 is "No," go to VI.I.7.</i>	<input type="checkbox"/> Yes <input type="checkbox"/> No
◆ 6.	All air curtain incinerators constructed after November 30, 1999 or modified or reconstructed on or after June 1, 2001 combust only wood waste, clean lumber, or yard waste or a mixture of these materials.	<input type="checkbox"/> Yes <input type="checkbox"/> No
◆ 7.	The application area includes at least one air curtain incinerator, constructed before November 30, 1999 and not modified or reconstructed on or after June 1, 2001.	<input type="checkbox"/> Yes <input type="checkbox"/> No
◆ 8.	All air curtain incinerators constructed before November 30, 1999 and not modified or reconstructed on or after June 1, 2001 combust only wood waste, clean lumber, or yard waste or a mixture of these materials.	<input type="checkbox"/> Yes <input type="checkbox"/> No

Application Area-Wide Applicability Determinations and General Information
Form OP-REQ1 (Page 24)
Federal Operating Permit Program
Texas Commission on Environmental Quality

Date	Permit No.	Regulated Entity No.
04/16/2026	O5	RN100217439

For SOP applications, answer ALL questions unless otherwise directed.

◆ For GOP applications, answer ONLY these questions unless otherwise directed.

VI. Title 40 Code of Federal Regulations Part 60 - New Source Performance Standards (continued)		
J. Subpart EEEE - Standards of Performance for Other Solid Waste Incineration Units for Which Construction Commenced After December 9, 2004 or for Which Modification or Reconstruction Commenced on or After June 16, 2006		
◆	1. The application area includes at least one very small municipal waste incineration unit or institutional incineration unit, other than an air curtain incinerator. <i>If the response to Question VI.J.1 is "N/A," go to Section VI.K. If the response to Question VI.J.1 is "No," go to Question VI.J.4.</i>	<input type="checkbox"/> Yes <input checked="" type="checkbox"/> No <input type="checkbox"/> N/A
◆	2. The application area includes at least one very small municipal waste incineration unit, other than an air curtain incinerator, constructed after December 9, 2004 or modified or reconstructed on or after June 16, 2006.	<input type="checkbox"/> Yes <input type="checkbox"/> No
◆	3. The application area includes at least one very small municipal waste incineration unit, other than an air curtain incinerator, constructed before December 9, 2004 and not modified or reconstructed on or after June 16, 2006.	<input type="checkbox"/> Yes <input type="checkbox"/> No
◆	4. The application area includes at least one air curtain incinerator. <i>If the response to Question VI.J.4 is "No," go to Section VI.K.</i>	<input type="checkbox"/> Yes <input checked="" type="checkbox"/> No
◆	5. The application area includes at least one air curtain incinerator constructed after December 9, 2004 or modified or reconstructed on or after June 16, 2006. <i>If the response to Question VI.J.5 is "No," go to Question VI.J.7.</i>	<input type="checkbox"/> Yes <input type="checkbox"/> No
◆	6. All air curtain incinerators constructed after December 9, 2004 or modified or reconstructed on or after June 16, 2006 combust only wood waste, clean lumber, or yard waste or a mixture of these materials.	<input type="checkbox"/> Yes <input type="checkbox"/> No
◆	7. The application area includes at least one air curtain incinerator constructed before December 9, 2004 and not modified or reconstructed on or after June 16, 2006.	<input type="checkbox"/> Yes <input type="checkbox"/> No

Application Area-Wide Applicability Determinations and General Information
Form OP-REQ1 (Page 25)
Federal Operating Permit Program
Texas Commission on Environmental Quality

Date	Permit No.	Regulated Entity No.
04/16/2026	O5	RN100217439

For SOP applications, answer ALL questions unless otherwise directed.

◆ For GOP applications, answer ONLY these questions unless otherwise directed.

VI. Title 40 Code of Federal Regulations Part 60 - New Source Performance Standards (NSPS) (continued)		
J. Subpart EEEE - Standards of Performance for Other Solid Waste Incineration Units for Which Construction Commenced After December 9, 2004 or for Which Modification or Reconstruction Commenced on or After June 16, 2006 (continued)		
◆	8. All air curtain incinerators constructed before December 9, 2004 and not modified or reconstructed on or after June 16, 2006 combust only wood waste, clean lumber, or yard waste or a mixture of these materials.	<input type="checkbox"/> Yes <input type="checkbox"/> No
◆	9. The air curtain incinerator is located at an institutional facility and is a distinct operating unit of the institutional facility that generated the waste.	<input type="checkbox"/> Yes <input type="checkbox"/> No
◆	10. The air curtain incinerator burns less than 35 tons per day of wood waste, clean lumber, or yard waste or a mixture of these materials.	<input type="checkbox"/> Yes <input type="checkbox"/> No
K. Subpart OOOO - Standards of Performance for Crude Oil and Natural Gas Production, Transmission and Distribution		
◆	1. The application area includes one or more of the onshore affected facilities listed in 40 CFR § 60.5365(a)-(g) that are subject to 40 CFR Part 60, Subpart OOOO.	<input type="checkbox"/> Yes <input checked="" type="checkbox"/> No
VII. Title 40 Code of Federal Regulations Part 61 - National Emission Standards for Hazardous Air Pollutants		
A. Applicability		
◆	1. The application area includes a unit(s) that is subject to one or more 40 CFR Part 61 subparts. <i>If the response to Question VII.A.1 is "No" or "N/A," go to Section VIII.</i>	<input type="checkbox"/> Yes <input checked="" type="checkbox"/> No <input type="checkbox"/> N/A
B. Subpart F - National Emission Standard for Vinyl Chloride		
	1. The application area is located at a plant which produces ethylene dichloride by reaction of oxygen and hydrogen chloride with ethylene, vinyl chloride by any process, and/or one or more polymers containing any fraction of polymerized vinyl chloride.	<input type="checkbox"/> Yes <input type="checkbox"/> No
C. Subpart J - National Emission Standard for Benzene Emissions for Equipment Leaks (Fugitive Emission Sources) of Benzene (Complete this section for GOP applications only)		
◆	1. The application area includes equipment in benzene service.	<input type="checkbox"/> Yes <input type="checkbox"/> No <input type="checkbox"/> N/A

Application Area-Wide Applicability Determinations and General Information
Form OP-REQ1 (Page 26)
Federal Operating Permit Program
Texas Commission on Environmental Quality

Date	Permit No.	Regulated Entity No.
04/16/2026	O5	RN100217439

For SOP applications, answer ALL questions unless otherwise directed.

◆ For GOP applications, answer ONLY these questions unless otherwise directed.

VII. Title 40 Code of Federal Regulations Part 61 - National Emission Standards for Hazardous Air Pollutants (continued)	
D. Subpart L - National Emission Standard for Benzene Emissions from Coke By-Product Recovery Plants	
1. The application area is located at a coke by-product recovery plant and includes one or more of the affected sources identified in 40 CFR § 61.130(a) - (b). <i>If the response to Question VII.D.1 is "No," go to Section VII.E.</i>	<input type="checkbox"/> Yes <input type="checkbox"/> No
2. The application area includes equipment in benzene service as determined by 40 CFR § 61.137(b).	<input type="checkbox"/> Yes <input type="checkbox"/> No
3. The application area has elected to comply with the provisions of 40 CFR § 61.243-1 and 40 CFR § 61.243-2.	<input type="checkbox"/> Yes <input type="checkbox"/> No
E. Subpart M - National Emission Standard for Asbestos	
<i>Applicability</i>	
1. The application area includes sources, operations, or activities specified in 40 CFR §§ 61.143, 61.144, 61.146, 61.147, 61.148, or 61.155. <i>If the response to Question VII.E.1 is "No," go to Section VII.F.</i>	<input type="checkbox"/> Yes <input type="checkbox"/> No
<i>Roadway Construction</i>	
2. The application area includes roadways constructed or maintained with asbestos tailings or asbestos-containing waste material.	<input type="checkbox"/> Yes <input type="checkbox"/> No
<i>Manufacturing Commercial Asbestos</i>	
3. The application area includes a manufacturing operation using commercial asbestos. <i>If the response to Question VII.E.3 is "No," go to Question VII.E.4.</i>	<input type="checkbox"/> Yes <input type="checkbox"/> No
a. Visible emissions are discharged to outside air from the manufacturing operation	<input type="checkbox"/> Yes <input type="checkbox"/> No
b. An alternative emission control and waste treatment method is being used that has received prior U.S. Environmental Protection Agency (EPA) approval.	<input type="checkbox"/> Yes <input type="checkbox"/> No

Application Area-Wide Applicability Determinations and General Information
Form OP-REQ1 (Page 27)
Federal Operating Permit Program
Texas Commission on Environmental Quality

Date	Permit No.	Regulated Entity No.
04/16/2026	O5	RN100217439

For SOP applications, answer ALL questions unless otherwise directed.

◆ For GOP applications, answer ONLY these questions unless otherwise directed.

VII. Title 40 Code of Federal Regulations Part 61 - National Emission Standards for Hazardous Air Pollutants (continued)	
E. Subpart M - National Emission Standard for Asbestos (continued)	
<i>Manufacturing Commercial Asbestos (continued)</i>	
c. Asbestos-containing waste material is processed into non-friable forms.	<input type="checkbox"/> Yes <input type="checkbox"/> No
d. Asbestos-containing waste material is adequately wetted.	<input type="checkbox"/> Yes <input type="checkbox"/> No
e. Alternative filtering equipment is being used that has received EPA approval.	<input type="checkbox"/> Yes <input type="checkbox"/> No
f. A high efficiency particulate air (HEPA) filter is being used that is certified to be at least 99.97% efficient for 0.3-micron particles	<input type="checkbox"/> Yes <input type="checkbox"/> No
g. The EPA has authorized the use of wet collectors designed to operate with a unit contacting energy of at least 9.95 kilopascals.	<input type="checkbox"/> Yes <input type="checkbox"/> No
<i>Asbestos Spray Application</i>	
4. The application area includes operations in which asbestos-containing materials are spray applied. <i>If the response to Question VII.E.4 is "No," go to Question VII.E.5.</i>	<input type="checkbox"/> Yes <input type="checkbox"/> No
a. Asbestos fibers are encapsulated with a bituminous or resinous binder during spraying and are not friable after drying. <i>If the response to Question VII.E.4.a is "Yes," go to Question VII.E.5.</i>	<input type="checkbox"/> Yes <input type="checkbox"/> No
b. Spray-on applications on buildings, structures, pipes, and conduits do not use material containing more than 1% asbestos.	<input type="checkbox"/> Yes <input type="checkbox"/> No
c. An alternative emission control and waste treatment method is being used that has received prior EPA approval.	<input type="checkbox"/> Yes <input type="checkbox"/> No

Application Area-Wide Applicability Determinations and General Information
Form OP-REQ1 (Page 28)
Federal Operating Permit Program
Texas Commission on Environmental Quality

Date	Permit No.	Regulated Entity No.
04/16/2026	O5	RN100217439

For SOP applications, answer ALL questions unless otherwise directed.

◆ For GOP applications, answer ONLY these questions unless otherwise directed.

VII. Title 40 Code of Federal Regulations Part 61 - National Emission Standards for Hazardous Air Pollutants (continued)	
E. Subpart M - National Emission Standard for Asbestos (continued)	
<i>Asbestos Spray Application (continued)</i>	
d. Asbestos-containing waste material is processed into non-friable forms.	<input type="checkbox"/> Yes <input type="checkbox"/> No
e. Asbestos-containing waste material is adequately wetted.	<input type="checkbox"/> Yes <input type="checkbox"/> No
f. Alternative filtering equipment is being used that has received EPA approval.	<input type="checkbox"/> Yes <input type="checkbox"/> No
g. A HEPA filter is being used that is certified to be at least 99.97% efficient for 0.3-micron particles.	<input type="checkbox"/> Yes <input type="checkbox"/> No
h. The EPA has authorized the use of wet collectors designed to operate with a unit contacting energy of at least 9.95 kilopascals.	<input type="checkbox"/> Yes <input type="checkbox"/> No
<i>Fabricating Commercial Asbestos</i>	
5. The application area includes a fabricating operation using commercial asbestos. <i>If the response to Question VII.E.5 is "No," go to Question VII.E.6.</i>	<input type="checkbox"/> Yes <input type="checkbox"/> No
a. Visible emissions are discharged to outside air from the manufacturing operation.	<input type="checkbox"/> Yes <input type="checkbox"/> No
b. An alternative emission control and waste treatment method is being used that has received prior EPA approval.	<input type="checkbox"/> Yes <input type="checkbox"/> No
c. Asbestos-containing waste material is processed into non-friable forms.	<input type="checkbox"/> Yes <input type="checkbox"/> No
d. Asbestos-containing waste material is adequately wetted.	<input type="checkbox"/> Yes <input type="checkbox"/> No
e. Alternative filtering equipment is being used that has received EPA approval.	<input type="checkbox"/> Yes <input type="checkbox"/> No

Application Area-Wide Applicability Determinations and General Information
Form OP-REQ1 (Page 29)
Federal Operating Permit Program
Texas Commission on Environmental Quality

Date	Permit No.	Regulated Entity No.
04/16/2026	O5	RN100217439

- For SOP applications, answer ALL questions unless otherwise directed.
- ◆ For GOP applications, answer ONLY these questions unless otherwise directed.

VII. Title 40 Code of Federal Regulations Part 61 - National Emission Standards for Hazardous Air Pollutants (continued)	
E. Subpart M - National Emission Standard for Asbestos (continued)	
<i>Fabricating Commercial Asbestos (continued)</i>	
f. A HEPA filter is being used that is certified to be at least 99.97% efficient for 0.3-micron particles.	<input type="checkbox"/> Yes <input type="checkbox"/> No
g. The EPA has authorized the use of wet collectors designed to operate with a unit contacting energy of at least 9.95 kilopascals.	<input type="checkbox"/> Yes <input type="checkbox"/> No
<i>Non-sprayed Asbestos Insulation</i>	
6. The application area includes insulating materials (other than spray applied insulating materials) that are either molded and friable or wet-applied and friable after drying.	<input type="checkbox"/> Yes <input type="checkbox"/> No
<i>Asbestos Conversion</i>	
7. The application area includes operations that convert regulated asbestos-containing material and asbestos-containing waste material into nonasbestos (asbestos-free) material.	<input type="checkbox"/> Yes <input type="checkbox"/> No
F. Subpart P - National Emission Standard for Inorganic Arsenic Emissions from Arsenic Trioxide and Metallic Arsenic Production Facilities	
1. The application area is located at a metallic arsenic production plant or at an arsenic trioxide plant that processes low-grade arsenic bearing materials by a roasting condensation process.	<input type="checkbox"/> Yes <input type="checkbox"/> No
G. Subpart BB - National Emission Standard for Benzene Emissions from Benzene Transfer Operations	
1. The application area is located at a benzene production facility and/or bulk terminal. <i>If the response to Question VII.G.1 is "No," go to Section VII.H.</i>	<input type="checkbox"/> Yes <input type="checkbox"/> No
2. The application area includes benzene transfer operations at marine vessel loading racks.	<input type="checkbox"/> Yes <input type="checkbox"/> No

Application Area-Wide Applicability Determinations and General Information
Form OP-REQ1 (Page 30)
Federal Operating Permit Program
Texas Commission on Environmental Quality

Date	Permit No.	Regulated Entity No.
04/16/2026	O5	RN100217439

For SOP applications, answer ALL questions unless otherwise directed.

◆ For GOP applications, answer ONLY these questions unless otherwise directed.

VII. Title 40 Code of Federal Regulations Part 61 - National Emission Standards for Hazardous Air Pollutants (continued)	
G. Subpart BB - National Emission Standard for Benzene Emissions from Benzene Transfer Operations (continued)	
3. The application area includes benzene transfer operations at railcar loading racks.	<input type="checkbox"/> Yes <input type="checkbox"/> No
4. The application area includes benzene transfer operations at tank-truck loading racks.	<input type="checkbox"/> Yes <input type="checkbox"/> No
H. Subpart FF - National Emission Standard for Benzene Waste Operations	
<i>Applicability</i>	
1. The application area includes a chemical manufacturing plant, coke by-product recovery plant, or petroleum refinery facility as defined in § 61.341.	<input type="checkbox"/> Yes <input type="checkbox"/> No
2. The application area is located at a hazardous waste treatment, storage, and disposal (TSD) facility site as described in 40 CFR § 61.340(b). <i>If the responses to Questions VII.H.1 and VII.H.2 are both "No," go to Section VIII.</i>	<input type="checkbox"/> Yes <input type="checkbox"/> No
3. The application area is located at a site that has no benzene onsite in wastes, products, byproducts, or intermediates. <i>If the response to Question VII.H.3 is "Yes," go to Section VIII.</i>	<input type="checkbox"/> Yes <input type="checkbox"/> No
4. The application area is located at a site having a total annual benzene quantity from facility waste less than 1 megagram per year (Mg/yr). <i>If the response to Question VII.H.4 is "Yes," go to Section VIII</i>	<input type="checkbox"/> Yes <input type="checkbox"/> No
5. The application area is located at a site having a total annual benzene quantity from facility waste greater than or equal to 1 Mg/yr but less than 10 Mg/yr. <i>If the response to Question VII.H.5 is "Yes," go to Section VIII.</i>	<input type="checkbox"/> Yes <input type="checkbox"/> No

Application Area-Wide Applicability Determinations and General Information
Form OP-REQ1 (Page 31)
Federal Operating Permit Program
Texas Commission on Environmental Quality

Date	Permit No.	Regulated Entity No.
04/16/2026	O5	RN100217439

For SOP applications, answer ALL questions unless otherwise directed.

◆ For GOP applications, answer ONLY these questions unless otherwise directed.

VII. Title 40 Code of Federal Regulations Part 61 - National Emission Standards for Hazardous Air Pollutants (continued)		
H. Subpart FF - National Emission Standard for Benzene Waste Operations (continued)		
<i>Applicability (continued)</i>		
6.	The flow-weighted annual average benzene concentration of each waste stream at the site is based on documentation.	<input type="checkbox"/> Yes <input type="checkbox"/> No
7.	The application area has waste streams with flow-weighted annual average water content of 10% or greater.	<input type="checkbox"/> Yes <input type="checkbox"/> No
<i>Waste Stream Exemptions</i>		
8.	The application area has waste streams that meet the exemption specified in 40 CFR § 61.342(c)(2) (the flow-weighted annual average benzene concentration is less than 10 ppmw).	<input type="checkbox"/> Yes <input type="checkbox"/> No
9.	The application area has waste streams that meet the exemption specified in 40 CFR § 61.342(c)(3) because process wastewater has a flow rate less than 0.02 liters per minute or an annual wastewater quantity less than 10 Mg/yr.	<input type="checkbox"/> Yes <input type="checkbox"/> No
10.	The application area has waste streams that meet the exemption specified in 40 CFR § 61.342(c)(3) because the total annual benzene quantity is less than or equal to 2 Mg/yr.	<input type="checkbox"/> Yes <input type="checkbox"/> No
11.	The application area transfers waste off-site for treatment by another facility.	<input type="checkbox"/> Yes <input type="checkbox"/> No
12.	The application area is complying with 40 CFR § 61.342(d).	<input type="checkbox"/> Yes <input type="checkbox"/> No
13.	The application area is complying with 40 CFR § 61.342(e). <i>If the response to Question VII.H.13 is "No," go to Question VII.H.15.</i>	<input type="checkbox"/> Yes <input type="checkbox"/> No
14.	The application area has facility waste with a flow weighted annual average water content of less than 10%.	<input type="checkbox"/> Yes <input type="checkbox"/> No

Application Area-Wide Applicability Determinations and General Information
Form OP-REQ1 (Page 32)
Federal Operating Permit Program
Texas Commission on Environmental Quality

Date	Permit No.	Regulated Entity No.
04/16/2026	O5	RN100217439

For SOP applications, answer ALL questions unless otherwise directed.

◆ For GOP applications, answer ONLY these questions unless otherwise directed.

VII. Title 40 Code of Federal Regulations Part 61 - National Emission Standards for Hazardous Air Pollutants (continued)	
H. Subpart FF - National Emission Standard for Benzene Waste Operations (continued)	
<i>Container Requirements</i>	
15. The application area has containers, as defined in 40 CFR § 61.341, that receive non-exempt benzene waste. <i>If the response to Question VII.H.15 is "No," go to Question VII.H.18.</i>	<input type="checkbox"/> Yes <input type="checkbox"/> No
16. The application area is an alternate means of compliance to meet the 40 CFR § 61.345 requirements for containers. <i>If the response to Question VII.H.16 is "Yes," go to Question VII.H.18.</i>	<input type="checkbox"/> Yes <input type="checkbox"/> No
17. Covers and closed-vent systems used for containers operate such that the container is maintained at a pressure less than atmospheric pressure.	<input type="checkbox"/> Yes <input type="checkbox"/> No
<i>Individual Drain Systems</i>	
18. The application area has individual drain systems, as defined in 40 CFR § 61.341, that receive or manage non-exempt benzene waste. <i>If the response to Question VII.H.18 is "No," go to Question VII.H.25.</i>	<input type="checkbox"/> Yes <input type="checkbox"/> No
19. The application area is using an alternate means of compliance to meet the 40 CFR § 61.346 requirements for individual drain systems. <i>If the response to Question VII.H.19 is "Yes," go to Question VII.H.25.</i>	<input type="checkbox"/> Yes <input type="checkbox"/> No
20. The application area has individual drain systems complying with 40 CFR § 61.346(a). <i>If the response to Question VII.H.20 is "No," go to Question VII.H.22.</i>	<input type="checkbox"/> Yes <input type="checkbox"/> No
21. Covers and closed-vent systems used for individual drain systems operate such that the individual drain system is maintained at a pressure less than atmospheric pressure.	<input type="checkbox"/> Yes <input type="checkbox"/> No

Application Area-Wide Applicability Determinations and General Information
Form OP-REQ1 (Page 33)
Federal Operating Permit Program
Texas Commission on Environmental Quality

Date	Permit No.	Regulated Entity No.
04/16/2026	O5	RN100217439

For SOP applications, answer ALL questions unless otherwise directed.

◆ For GOP applications, answer ONLY these questions unless otherwise directed.

VII. Title 40 Code of Federal Regulations Part 61 - National Emission Standards for Hazardous Air Pollutants (continued)	
H. Subpart FF - National Emission Standard for Benzene Waste Operations (continued)	
<i>Individual Drain Systems (continued)</i>	
22. The application area has individual drain systems complying with 40 CFR § 61.346(b). <i>If the response to Question VII.H.22 is "No," go to Question VII.H.25.</i>	<input type="checkbox"/> Yes <input type="checkbox"/> No
23. Junction boxes in the individual drain systems are equipped with a system to prevent the flow of organic vapors from the junction box vent pipe to the atmosphere during normal operation.	<input type="checkbox"/> Yes <input type="checkbox"/> No
24. Junction box vent pipes in the individual drain systems are connected to a closed-vent system and control device.	<input type="checkbox"/> Yes <input type="checkbox"/> No
<i>Remediation Activities</i>	
25. Remediation activities take place at the application area subject to 40 CFR Part 61, Subpart FF.	<input type="checkbox"/> Yes <input type="checkbox"/> No
VIII. Title 40 Code of Federal Regulations Part 63 - National Emission Standards for Hazardous Air Pollutants for Source Categories	
A. Applicability	
◆ 1. The application area includes a unit(s) that is subject to one or more 40 CFR Part 63 subparts other than subparts made applicable by reference under subparts in 40 CFR Part 60, 61 or 63. <i>See instructions for 40 CFR Part 63 subparts made applicable only by reference.</i>	<input checked="" type="checkbox"/> Yes <input type="checkbox"/> No
B. Subpart F - National Emission Standards for Organic Hazardous Air Pollutants from the Synthetic Organic Chemical Manufacturing Industry	
1. The application area is located at a plant site that is a major source as defined in the Federal Clean Air Act § 112(a). <i>If the response to Question VIII.B.1 is "No," go to Section VIII.D.</i>	<input type="checkbox"/> Yes <input checked="" type="checkbox"/> No

Application Area-Wide Applicability Determinations and General Information
Form OP-REQ1 (Page 34)
Federal Operating Permit Program
Texas Commission on Environmental Quality

Date	Permit No.	Regulated Entity No.
04/16/2026	O5	RN100217439

For SOP applications, answer ALL questions unless otherwise directed.

◆ For GOP applications, answer ONLY these questions unless otherwise directed.

VIII. Title 40 Code of Federal Regulations Part 63 - National Emission Standards for Hazardous Air Pollutants for Source Categories (continued)		
B. Subpart F - National Emission Standards for Organic Hazardous Air Pollutants from the Synthetic Organic Chemical Manufacturing Industry (continued)		
2.	The application area is located at a site that includes at least one chemical manufacturing process unit, as defined in 40 CFR § 63.101, that manufactures as a primary product one or more of the chemicals listed in 40 CFR § 63.100(b)(1)(i) or (b)(1)(ii). <i>If the response to Question VIII.B.2 is "No," go to Section VIII.D.</i>	<input type="checkbox"/> Yes <input type="checkbox"/> No
3.	The application area is located at a site that includes at least one chemical manufacturing process unit, as defined in 40 CFR § 63.101, that manufactures as a primary product one or more of the chemicals listed in 40 CFR § 63.100(b)(1)(i) or (b)(1)(ii) and uses as a reactant or manufactures as a product, or co-product, one or more of the organic hazardous air pollutants listed in table 2 of 40 CFR Part 63, Subpart F.	<input type="checkbox"/> Yes <input type="checkbox"/> No
4.	The application area includes a chemical manufacturing process unit, as defined in 40 CFR § 63.101, that manufactures as a primary product one or more of the chemicals listed in 40 CFR § 63.100(b)(1)(i) or (b)(1)(ii) and uses as a reactant or manufactures as a product, or co-product, one or more of the organic hazardous air pollutants listed in table 2 of 40 CFR Part 63, Subpart F.	<input type="checkbox"/> Yes <input type="checkbox"/> No
5.	The application area includes a chemical manufacturing process unit, as defined in 40 CFR § 63.101, that manufactures as a primary product one or more of the chemicals listed in 40 CFR § 63.100(b)(1)(i) or (b)(1)(ii) and does <u>not</u> use as a reactant or manufacture as a product, or co-product, one or more of the organic hazardous air pollutants listed in table 2 of 40 CFR Part 63, Subpart F. <i>If the response to Questions VIII.B.3, B.4 and B.5 are all "No," go to Section VIII.D.</i>	<input type="checkbox"/> Yes <input type="checkbox"/> No

Application Area-Wide Applicability Determinations and General Information
Form OP-REQ1 (Page 35)
Federal Operating Permit Program
Texas Commission on Environmental Quality

Date	Permit No.	Regulated Entity No.
04/16/2026	O5	RN100217439

For SOP applications, answer ALL questions unless otherwise directed.

◆ For GOP applications, answer ONLY these questions unless otherwise directed.

VIII. Title 40 Code of Federal Regulations Part 63 - National Emission Standards for Hazardous Air Pollutants for Source Categories (continued)		
C. Subpart G - National Emission Standards for Organic Hazardous Air Pollutants from the Synthetic Organic Chemical Manufacturing Industry for Process Vents, Storage Vessels, Transfer Operations, and Wastewater		
<i>Applicability</i>		
1.	The application area is located at a site that is subject to 40 CFR 63, Subpart F and the application area includes process vents, storage vessels, transfer racks, or waste streams associated with a chemical manufacturing process subject to 40 CFR 63, Subpart F. <i>If the response to Question VIII.C.1 is "No," go to Section VIII.D.</i>	<input type="checkbox"/> Yes <input type="checkbox"/> No
2.	The application area includes fixed roofs, covers, and/or enclosures that are required to comply with 40 CFR § 63.148.	<input type="checkbox"/> Yes <input type="checkbox"/> No
3.	The application area includes vapor collection systems or closed-vent systems that are required to comply with 40 CFR § 63.148. <i>If the response to Question VIII.C.3 is "No," go to Question VIII.C.8.</i>	<input type="checkbox"/> Yes <input type="checkbox"/> No
4.	The application area includes vapor collection systems or closed-vent systems that are constructed of hard piping.	<input type="checkbox"/> Yes <input type="checkbox"/> No
5.	The application area includes vapor collection systems or closed-vent systems that contain bypass lines that could divert a vent stream away from a control device and to the atmosphere. <i>If the response to Question VIII.C.5 is "No," go to Question VIII.C.8.</i>	<input type="checkbox"/> Yes <input type="checkbox"/> No
<i>Vapor Collection and Closed Vent Systems</i>		
6.	Flow indicators are installed, calibrated, maintained, and operated at the entrances to bypass lines in the application area.	<input type="checkbox"/> Yes <input type="checkbox"/> No
7.	Bypass lines in the application area are secured in the closed position with a car-seal or a lock-and-key type configuration.	<input type="checkbox"/> Yes <input type="checkbox"/> No

Application Area-Wide Applicability Determinations and General Information
Form OP-REQ1 (Page 36)
Federal Operating Permit Program
Texas Commission on Environmental Quality

Date	Permit No.	Regulated Entity No.
04/16/2026	O5	RN100217439

For SOP applications, answer ALL questions unless otherwise directed.

◆ For GOP applications, answer ONLY these questions unless otherwise directed.

VIII. Title 40 Code of Federal Regulations Part 63 - National Emission Standards for Hazardous Air Pollutants for Source Categories (continued)	
C. Subpart G - National Emission Standards for Organic Hazardous Air Pollutants from the Synthetic Organic Chemical Manufacturing Industry for Process Vents, Storage Vessels, Transfer Operations, and Wastewater (continued)	
<i>Reloading or Cleaning of Railcars, Tank Trucks, or Barges</i>	
8. The application area includes reloading and/or cleaning of railcars, tank trucks, or barges that deliver HAPs to a storage tank. <i>If the response to Question VIII.C.8 is "No," go to Question VIII.C.11.</i>	<input type="checkbox"/> Yes <input type="checkbox"/> No
9. The application area includes operations that are complying with § 63.119(g)(6) through the use of a closed-vent system with a control device used to reduce inlet emissions of HAPs by at least 95 percent by weight or greater.	<input type="checkbox"/> Yes <input type="checkbox"/> No
10. The application area includes operations that are complying with § 63.119(g)(6) through the use of a vapor balancing system.	<input type="checkbox"/> Yes <input type="checkbox"/> No
<i>Transfer Racks</i>	
11. The application area includes Group 1 transfer racks that load organic HAPs.	<input type="checkbox"/> Yes <input type="checkbox"/> No
<i>Process Wastewater Streams</i>	
12. The application area includes process wastewater streams. <i>If the response to Question VIII.C.12 is "No," go to Question VIII.C.34.</i>	<input type="checkbox"/> Yes <input type="checkbox"/> No
13. The application area includes process wastewater streams that are also subject to the provisions of 40 CFR Part 61, Subpart FF. <i>If the response to Question VIII.C.13 is "No," go to Question VIII.C.15.</i>	<input type="checkbox"/> Yes <input type="checkbox"/> No
14. The application area includes process wastewater streams that are complying with 40 CFR §§ 63.110(e)(1)(i) and (e)(1)(ii).	<input type="checkbox"/> Yes <input type="checkbox"/> No
15. The application area includes process wastewater streams that are also subject to the provisions of 40 CFR Part 61, Subpart F. <i>If the response to Question VIII.C.15 is "No," go to Question VIII.C.17.</i>	<input type="checkbox"/> Yes <input type="checkbox"/> No

Application Area-Wide Applicability Determinations and General Information
Form OP-REQ1 (Page 37)
Federal Operating Permit Program
Texas Commission on Environmental Quality

Date	Permit No.	Regulated Entity No.
04/16/2026	O5	RN100217439

For SOP applications, answer ALL questions unless otherwise directed.

◆ For GOP applications, answer ONLY these questions unless otherwise directed.

VIII. Title 40 Code of Federal Regulations Part 63 - National Emission Standards for Hazardous Air Pollutants for Source Categories (continued)	
C. Subpart G - National Emission Standards for Organic Hazardous Air Pollutants from the Synthetic Organic Chemical Manufacturing Industry for Process Vents, Storage Vessels, Transfer Operations, and Wastewater (continued)	
<i>Process Wastewater Streams (continued)</i>	
16. The application area includes process wastewater streams utilizing the compliance option specified in 40 CFR § 63.110(f)(4)(ii).	<input type="checkbox"/> Yes <input type="checkbox"/> No
17. The application area includes process wastewater streams that are also subject to the provisions of 40 CFR Parts 260 through 272. <i>If the response to Question VIII.C.17 is "No," go to Question VIII.C.20.</i>	<input type="checkbox"/> Yes <input type="checkbox"/> No
18. The application area includes process wastewater streams complying with 40 CFR § 63.110(e)(2)(i).	<input type="checkbox"/> Yes <input type="checkbox"/> No
19. The application are includes process wastewater streams complying with 40 CFR § 63.110(e)(2)(ii).	<input type="checkbox"/> Yes <input type="checkbox"/> No
20. The application area includes process wastewater streams, located at existing sources, that are designated as Group 1; are required to be treated as Group 1 under 40 CFR § 63.110; or are determined to be Group 1 for Table 9 compounds.	<input type="checkbox"/> Yes <input type="checkbox"/> No
21. The application area includes process wastewater streams, located at existing sources that are Group 2.	<input type="checkbox"/> Yes <input type="checkbox"/> No
22. The application area includes process wastewater streams, located at new sources, that are designated as Group 1; required to be treated as Group 1 under 40 CFR § 63.110; or are determined to be Group 1 for Table 8 or Table 9 compounds.	<input type="checkbox"/> Yes <input type="checkbox"/> No
23. The application area includes process wastewater streams, located at new sources that are Group 2 for both Table 8 and Table 9 compounds.	<input type="checkbox"/> Yes <input type="checkbox"/> No

Application Area-Wide Applicability Determinations and General Information
Form OP-REQ1 (Page 38)
Federal Operating Permit Program
Texas Commission on Environmental Quality

Date	Permit No.	Regulated Entity No.
04/16/2026	O5	RN100217439

For SOP applications, answer ALL questions unless otherwise directed.

◆ For GOP applications, answer ONLY these questions unless otherwise directed.

VIII. Title 40 Code of Federal Regulations Part 63 - National Emission Standards for Hazardous Air Pollutants for Source Categories (continued)		
C. Subpart G - National Emission Standards for Organic Hazardous Air Pollutants from the Synthetic Organic Chemical Manufacturing Industry for Process Vents, Storage Vessels, Transfer Operations, and Wastewater (continued)		
<i>Process Wastewater Streams (continued)</i>		
24.	All Group 1 wastewater streams at the site are demonstrated to have a total source mass flow rate of less than 1 MG/yr. <i>If the response to Question VIII.C.24 is "Yes," go to Question VIII.C.34.</i>	<input type="checkbox"/> Yes <input type="checkbox"/> No
25.	The site has untreated and/or partially treated Group 1 wastewater streams demonstrated to have a total source mass flow rate of less than 1 MG/yr. <i>If the response to Question VIII.C.25 is "No," go to Question VIII.C.27.</i>	<input type="checkbox"/> Yes <input type="checkbox"/> No
26.	The application area includes waste management units that receive or manage a partially treated Group 1 wastewater stream prior to or during treatment.	<input type="checkbox"/> Yes <input type="checkbox"/> No
27.	Group 1 wastewater streams or residual removed from Group 1 wastewater streams are transferred to an on-site treatment operation that is not owned or operated by the owner or operator of the source generating the waste stream or residual.	<input type="checkbox"/> Yes <input type="checkbox"/> No
28.	Group 1 wastewater streams or residual removed from Group 1 wastewater streams are transferred to an off-site treatment operation. <i>If the responses to Questions VIII.C.27 - VIII.C.28 are both "No," go to Question VIII.C.30.</i>	<input type="checkbox"/> Yes <input type="checkbox"/> No
29.	The application area includes waste management units that receive or manage a Group 1 wastewater stream, or a residual removed from a Group 1 wastewater stream prior to shipment or transport.	<input type="checkbox"/> Yes <input type="checkbox"/> No
30.	The application area includes containers that receive, manage, or treat a Group 1 wastewater stream or a residual removed from a Group 1 wastewater stream.	<input type="checkbox"/> Yes <input type="checkbox"/> No

Application Area-Wide Applicability Determinations and General Information
Form OP-REQ1 (Page 39)
Federal Operating Permit Program
Texas Commission on Environmental Quality

Date	Permit No.	Regulated Entity No.
04/16/2026	O5	RN100217439

For SOP applications, answer ALL questions unless otherwise directed.

◆ For GOP applications, answer ONLY these questions unless otherwise directed.

VIII. Title 40 Code of Federal Regulations Part 63 - National Emission Standards for Hazardous Air Pollutants for Source Categories (continued)		
C. Subpart G - National Emission Standards for Organic Hazardous Air Pollutants from the Synthetic Organic Chemical Manufacturing Industry for Process Vents, Storage Vessels, Transfer Operations, and Wastewater (continued)		
<i>Drains</i>		
31.	The application area includes individual drain systems that receive or manage a Group 1 wastewater stream, or a residual removed from a Group 1 wastewater stream. <i>If the response to Question VIII.C.31 is "No," go to Question VIII.C.34.</i>	<input type="checkbox"/> Yes <input type="checkbox"/> No
32.	The application area includes individual drain systems that are complying with 40 CFR § 63.136 through the use of cover and, if vented, closed vent systems and control devices.	<input type="checkbox"/> Yes <input type="checkbox"/> No
33.	The application area includes individual drain systems that are complying with 40 CFR § 63.136 through the use of water seals or tightly fitting caps or plugs.	<input type="checkbox"/> Yes <input type="checkbox"/> No
34.	The application area includes drains, drain hubs, manholes, lift stations, trenches, or pipes that are part of a chemical manufacturing process unit that meets the criteria of 40 CFR § 63.100(b). <i>If the response to Question VIII.C.34 is "No," go to Question VIII.C.39.</i>	<input type="checkbox"/> Yes <input type="checkbox"/> No
35.	The application area includes drains, drain hubs, manholes, lift stations, trenches or pipes (that are part of a chemical manufacturing process unit) that meet the criteria listed in 40 CFR § 63.149(d). <i>If the response to Question VIII.C.35 is "No," go to Question VIII.C.39.</i>	<input type="checkbox"/> Yes <input type="checkbox"/> No
36.	The application area includes drains, drain hubs, manholes, lift stations, trenches, or pipes that convey water with a total annual average concentration greater than or equal to 10,000 parts per million by weight of compounds listed in 40 CFR Part 63 Subpart G, Table 9, at any flow rate.	<input type="checkbox"/> Yes <input type="checkbox"/> No

Application Area-Wide Applicability Determinations and General Information
Form OP-REQ1 (Page 40)
Federal Operating Permit Program
Texas Commission on Environmental Quality

Date	Permit No.	Regulated Entity No.
04/16/2026	O5	RN100217439

For SOP applications, answer ALL questions unless otherwise directed.

◆ For GOP applications, answer ONLY these questions unless otherwise directed.

VIII. Title 40 Code of Federal Regulations Part 63 - National Emission Standards for Hazardous Air Pollutants for Source Categories (continued)	
C. Subpart G-National Emission Standards for Organic Hazardous Air Pollutants from the Synthetic Organic Chemical Manufacturing Industry for Process Vents, Storage Vessels, Transfer Operation, and Wastewater (continued)	
<i>Drains (continued)</i>	
37. The application area includes drains, drain hubs, manholes, lift stations, trenches or pipes that convey water with a total annual average concentration greater than or equal to 1,000 parts per million by weight of compounds listed in 40 CFR Part 63 Subpart G, Table 9, at an annual average flow rate greater than or equal to 10 liters per minute.	<input type="checkbox"/> Yes <input type="checkbox"/> No
38. The application area includes drains, drain hubs, manholes, lift stations, trenches or pipes that are part of a chemical manufacturing process unit that is subject to the new source requirements of 40 CFR § 63.100(l)(1) or (l)(2); and the equipment conveys water with a total annual average concentration greater than or equal to 10 parts per million by weight of compounds listed in 40 CFR Part 63 Subpart G, Table 8, at an average annual flow rate greater than or equal to 0.02 liter per minute.	<input type="checkbox"/> Yes <input type="checkbox"/> No
<i>Gas Streams</i>	
39. The application area includes gas streams meeting the characteristics of 40 CFR § 63.107(b) - (h) or the criteria of 40 CFR § 63.113(i) and are transferred to a control device not owned or operated by the applicant.	<input type="checkbox"/> Yes <input type="checkbox"/> No
40. The applicant is unable to comply with 40 CFR §§ 63.113 - 63.118 for one or more reasons described in 40 CFR § 63.100(q)(1), (3), or (5).	<input type="checkbox"/> Yes <input type="checkbox"/> No
D. Subpart N - National Emission Standards for Chromium Emissions From Hard and Decorative Chromium Electroplating and Chromium Anodizing Tanks	
1. The application area includes chromium electroplating or chromium anodizing tanks located at hard chromium electroplating, decorative chromium electroplating, and/or chromium anodizing operations.	<input type="checkbox"/> Yes <input checked="" type="checkbox"/> No

Application Area-Wide Applicability Determinations and General Information
Form OP-REQ1 (Page 41)
Federal Operating Permit Program
Texas Commission on Environmental Quality

Date	Permit No.	Regulated Entity No.
04/16/2026	O5	RN100217439

For SOP applications, answer ALL questions unless otherwise directed.

◆ For GOP applications, answer ONLY these questions unless otherwise directed.

VIII. Title 40 Code of Federal Regulations Part 63 - National Emission Standards for Hazardous Air Pollutants for Source Categories (continued)		
E. Subpart O - Ethylene Oxide Emissions Standards for Sterilization Facilities		
1.	The application area includes sterilization facilities where ethylene oxide is used in the sterilization or fumigation of materials. <i>If the response to Question VIII.E.1 is "No," go to Section VIII.F.</i>	<input type="checkbox"/> Yes <input checked="" type="checkbox"/> No
2.	Sterilization facilities located in the application area are subject to 40 CFR Part 63, Subpart O. <i>If the response to Question VIII.E.2 is "No," go to Section VIII.F.</i>	<input type="checkbox"/> Yes <input type="checkbox"/> No
3.	The sterilization source has used less than 1 ton (907 kg) of ethylene oxide within all consecutive 12-month periods after December 6, 1996.	<input type="checkbox"/> Yes <input type="checkbox"/> No
4.	The sterilization source has used less than 10 tons (9070 kg) of ethylene oxide within all consecutive 12-month periods after December 6, 1996.	<input type="checkbox"/> Yes <input type="checkbox"/> No
F. Subpart Q - National Emission Standards for Industrial Process Cooling Towers		
1.	The application area includes industrial process cooling towers. <i>If the response to Question VIII.F.1 is "No," go to Section VIII.G.</i>	<input checked="" type="checkbox"/> Yes <input type="checkbox"/> No
2.	Chromium-based water treatment chemicals have been used on or after September 8, 1994.	<input type="checkbox"/> Yes <input checked="" type="checkbox"/> No
G. Subpart R - National Emission Standards for Gasoline Distribution Facilities (Bulk Gasoline Terminals and Pipeline Breakout Stations)		
1.	The application area includes a bulk gasoline terminal.	<input type="checkbox"/> Yes <input checked="" type="checkbox"/> No
2.	The application area includes a pipeline breakout station. <i>If the responses to Questions VIII.G.1 and VIII.G.2 are both "No," go to Section VIII.H.</i>	<input type="checkbox"/> Yes <input checked="" type="checkbox"/> No
3.	The bulk gasoline terminal or pipeline breakout station is located within a contiguous area and under common control with another bulk gasoline terminal or a pipeline breakout station. <i>If the response to Question VIII.G.3 is "Yes," go to Question VIII.G.10.</i>	<input type="checkbox"/> Yes <input type="checkbox"/> No

Application Area-Wide Applicability Determinations and General Information
Form OP-REQ1 (Page 42)
Federal Operating Permit Program
Texas Commission on Environmental Quality

Date	Permit No.	Regulated Entity No.
04/16/2026	O5	RN100217439

For SOP applications, answer ALL questions unless otherwise directed.

◆ For GOP applications, answer ONLY these questions unless otherwise directed.

VIII. Title 40 Code of Federal Regulations Part 63 - National Emission Standards for Hazardous Air Pollutants for Source Categories (continued)		
G. Subpart R - National Emission Standards for Gasoline Distribution Facilities (Bulk Gasoline Terminals and Pipeline Breakout Stations) (continued)		
4.	The bulk gasoline terminal or pipeline breakout station is located within a contiguous area and under common control with sources, other than bulk gasoline terminals or pipeline breakout stations that emit or have the potential to emit HAPs. <i>If the response to Question VIII.G.4 is "Yes," go to Question VIII.G.10.</i>	<input type="checkbox"/> Yes <input type="checkbox"/> No
5.	An emissions screening factor was calculated for the bulk gasoline terminal or pipeline breakout station. <i>If the response to Question VIII.G.5 is "No," go to Question VIII.G.10.</i>	<input type="checkbox"/> Yes <input type="checkbox"/> No
6.	The value 0.04(OE) is less than 5% of the value of the bulk gasoline terminal emissions screening factor (ET) or the pipeline breakout station emissions screening factor (Ep). <i>If the response to Question VIII.G.6 is "No," go to Question VIII.G.10.</i>	<input type="checkbox"/> Yes <input type="checkbox"/> No
7.	Emissions screening factor less than 0.5 (ET or EP < 0.5). <i>If the response to Question VIII.G.7 is "Yes," go to Section VIII.H.</i>	<input type="checkbox"/> Yes <input type="checkbox"/> No
8.	Emissions screening factor greater than or equal to 0.5, but less than 1.0 (0.5 ≤ ET or EP < 1.0). <i>If the response to Question VIII.G.8 is "Yes," go to Section VIII.H.</i>	<input type="checkbox"/> Yes <input type="checkbox"/> No
9.	Emissions screening factor greater than or equal to 1.0 (ET or EP ≥ 1.0). <i>If the response to Question VIII.G.9 is "Yes," go to Question VIII.G.11.</i>	<input type="checkbox"/> Yes <input type="checkbox"/> No
10.	The site at which the application area is located is a major source of HAP. <i>If the response to Question VIII.G.10 is "No," go to Section VIII.H.</i>	<input type="checkbox"/> Yes <input type="checkbox"/> No
11.	The application area is using an alternative leak monitoring program as described in 40 CFR § 63.424(f).	<input type="checkbox"/> Yes <input type="checkbox"/> No

Application Area-Wide Applicability Determinations and General Information
Form OP-REQ1 (Page 43)
Federal Operating Permit Program
Texas Commission on Environmental Quality

Date	Permit No.	Regulated Entity No.
04/16/2026	O5	RN100217439

For SOP applications, answer ALL questions unless otherwise directed.

◆ For GOP applications, answer ONLY these questions unless otherwise directed.

VIII. Title 40 Code of Federal Regulations Part 63 - National Emission Standards for Hazardous Air Pollutants for Source Categories (continued)		
H. Subpart S - National Emission Standards for Hazardous Air Pollutants from the Pulp and Paper Industry		
1.	The application area includes processes that produce pulp, paper, or paperboard and are located at a plant site that is a major source of HAPs as defined in 40 CFR § 63.2. <i>If the response to Question VIII.H.1 is "No," go to Section VIII.I.</i>	<input type="checkbox"/> Yes <input checked="" type="checkbox"/> No
2.	The application area uses processes and materials specified in 40 CFR § 63.440(a)(1) - (3). <i>If the response to Question VIII.H.2 is "No," go to Section VIII.I.</i>	<input type="checkbox"/> Yes <input type="checkbox"/> No
3.	The application area includes one or more sources subject to 40 CFR Part 63, Subpart S that are existing sources. <i>If the response to Question VIII.H.3 is "No," go to Section VIII.I.</i>	<input type="checkbox"/> Yes <input type="checkbox"/> No
4.	The application area includes one or more kraft pulping systems that are existing sources.	<input type="checkbox"/> Yes <input type="checkbox"/> No
5.	The application area includes one or more dissolving-grade bleaching systems that are existing sources at a kraft or sulfite pulping mill.	<input type="checkbox"/> Yes <input type="checkbox"/> No
6.	The application area includes bleaching systems that are existing sources and are complying with the Voluntary Advanced Technology Incentives Program for Effluent Limitation Guidelines in 40 CFR § 430.24. <i>If the response to Question VIII.H.6 is "No," go to Section VIII.I.</i>	<input type="checkbox"/> Yes <input type="checkbox"/> No
7.	The application area includes bleaching systems that are complying with 40 CFR § 63.440(d)(3)(i).	<input type="checkbox"/> Yes <input type="checkbox"/> No
8.	The application area includes bleaching systems that are complying with 40 CFR § 63.440(d)(3)(ii).	<input type="checkbox"/> Yes <input type="checkbox"/> No

Application Area-Wide Applicability Determinations and General Information
Form OP-REQ1 (Page 44)
Federal Operating Permit Program
Texas Commission on Environmental Quality

Date	Permit No.	Regulated Entity No.
04/16/2026	O5	RN100217439

For SOP applications, answer ALL questions unless otherwise directed.

◆ For GOP applications, answer ONLY these questions unless otherwise directed.

VIII. Title 40 Code of Federal Regulations Part 63 - National Emission Standards for Hazardous Air Pollutants for Source Categories (continued)	
I. Subpart T - National Emission Standards for Halogenated Solvent Cleaning	
1. The application area includes an individual batch vapor, in-line vapor, in-line cold, and/or batch cold solvent cleaning machine that uses a hazardous air pollutant (HAP) solvent, or any combination of halogenated HAP solvents, in a total concentration greater than 5% by weight, as a cleaning and/or drying agent.	<input type="checkbox"/> Yes <input checked="" type="checkbox"/> No
2. The application area is located at a major source and includes solvent cleaning machines, qualifying as affected facilities, that use perchloroethylene, trichloroethylene or methylene chloride.	<input type="checkbox"/> Yes <input checked="" type="checkbox"/> No
3. The application area is located at an area source and includes solvent cleaning machines, other than cold batch cleaning machines, that use perchloroethylene, trichloroethylene or methylene chloride.	<input type="checkbox"/> Yes <input checked="" type="checkbox"/> No
J. Subpart U - National Emission Standards for Hazardous Air Pollutant Emissions: Group 1 Polymers and Resins	
1. The application area includes elastomer product process units and/or wastewater streams and wastewater operations that are associated with elastomer product process units. <i>If the response to Question VIII.J.1 is "No," go to Section VIII.K.</i>	<input type="checkbox"/> Yes <input checked="" type="checkbox"/> No
2. Elastomer product process units and/or wastewater streams and wastewater operations located in the application area are subject to 40 CFR Part 63, Subpart U. <i>If the response to Question VIII.J.2 is "No," go to Section VIII.K.</i>	<input type="checkbox"/> Yes <input type="checkbox"/> No
3. The application area includes process wastewater streams that are designated as Group 1 or are determined to be Group 1 for organic HAPs as defined in 40 CFR § 63.482.	<input type="checkbox"/> Yes <input type="checkbox"/> No
4. The application area includes process wastewater streams that are Group 2 for organic HAPs as defined in 40 CFR § 63.482.	<input type="checkbox"/> Yes <input type="checkbox"/> No

Application Area-Wide Applicability Determinations and General Information
Form OP-REQ1 (Page 45)
Federal Operating Permit Program
Texas Commission on Environmental Quality

Date	Permit No.	Regulated Entity No.
04/16/2026	O5	RN100217439

For SOP applications, answer ALL questions unless otherwise directed.

◆ For GOP applications, answer ONLY these questions unless otherwise directed.

VIII. Title 40 Code of Federal Regulations Part 63 - National Emission Standards for Hazardous Air Pollutants for Source Categories (continued)		
J. Subpart U - National Emission Standards for Hazardous Air Pollutant Emissions: Group 1 Polymers and Resins (continued)		
5.	All Group 1 wastewater streams at the site are demonstrated to have a total source mass flow rate of less than 1 MG/yr. <i>If the response to Question VIII.J.5 is "Yes," go to Question VIII.J.15.</i>	<input type="checkbox"/> Yes <input type="checkbox"/> No
6.	The site has untreated and/or partially treated Group 1 wastewater streams demonstrated to have a total source mass flow rate of less than 1 MG/yr. <i>If the response to Question VIII.J.6 is "No," go to Question VIII.J.8.</i>	<input type="checkbox"/> Yes <input type="checkbox"/> No
7.	The application area includes waste management units that receive or manage a partially treated Group 1 wastewater stream prior to or during treatment.	<input type="checkbox"/> Yes <input type="checkbox"/> No
8.	Group 1 wastewater streams or residual removed from Group 1 wastewater streams are transferred to an on-site treatment operation that is not owned or operated by the owner or operator of the source generating the waste stream or residual.	<input type="checkbox"/> Yes <input type="checkbox"/> No
9.	Group 1 wastewater streams or residual removed from Group 1 wastewater streams are transferred to an off-site treatment operation. <i>If the responses to Questions VIII.J.8 - VIII.J.9 are both "No," go to Question VIII.J.11.</i>	<input type="checkbox"/> Yes <input type="checkbox"/> No
10.	The application area includes waste management units that receive or manage a Group 1 wastewater stream, or a residual removed from a Group 1 wastewater stream prior to shipment or transport.	<input type="checkbox"/> Yes <input type="checkbox"/> No

Application Area-Wide Applicability Determinations and General Information
Form OP-REQ1 (Page 46)
Federal Operating Permit Program
Texas Commission on Environmental Quality

Date	Permit No.	Regulated Entity No.
04/16/2026	O5	RN100217439

For SOP applications, answer ALL questions unless otherwise directed.

◆ For GOP applications, answer ONLY these questions unless otherwise directed.

VIII. Title 40 Code of Federal Regulations Part 63 - National Emission Standards for Hazardous Air Pollutants for Source Categories (continued)	
J. Subpart U - National Emission Standards for Hazardous Air Pollutant Emissions: Group 1 Polymers and Resins (continued)	
<i>Containers</i>	
11. The application area includes containers that receive, manage, or treat a Group 1 wastewater stream or a residual removed from a Group 1 wastewater stream.	<input type="checkbox"/> Yes <input type="checkbox"/> No
<i>Drains</i>	
12. The application area includes individual drain systems that receive or manage a Group 1 wastewater stream, or a residual removed from a Group 1 wastewater stream. <i>If the response to Question VIII.J.12 is "No," go to Question VIII.J.15.</i>	<input type="checkbox"/> Yes <input type="checkbox"/> No
13. The application area includes individual drain systems that are complying with 40 CFR § 63.136 through the use of cover and, if vented, closed vent systems and control devices.	<input type="checkbox"/> Yes <input type="checkbox"/> No
14. The application area includes individual drain systems that are complying with 40 CFR § 63.136 through the use of water seals or tightly fitting caps or plugs.	<input type="checkbox"/> Yes <input type="checkbox"/> No
15. The application area includes drains, drain hubs, manholes, lift stations, trenches, or pipes that are part of an elastomer product process unit. <i>If the response to Question VIII.J.15 is "No," go to Section VIII.K.</i>	<input type="checkbox"/> Yes <input type="checkbox"/> No
16. The application area includes drains, drain hubs, manholes, lift stations, trenches or pipes that meet the criteria listed in 40 CFR § 63.149(d) and § 63.501(a)(12). <i>If the response to Question VIII.J.16 is "No," go to Section VIII.K.</i>	<input type="checkbox"/> Yes <input type="checkbox"/> No

Application Area-Wide Applicability Determinations and General Information
Form OP-REQ1 (Page 47)
Federal Operating Permit Program
Texas Commission on Environmental Quality

Date	Permit No.	Regulated Entity No.
04/16/2026	O5	RN100217439

For SOP applications, answer ALL questions unless otherwise directed.

◆ For GOP applications, answer ONLY these questions unless otherwise directed.

VIII. Title 40 Code of Federal Regulations Part 63 - National Emission Standards for Hazardous Air Pollutants for Source Categories (continued)	
J. Subpart U - National Emission Standards for Hazardous Air Pollutant Emissions: Group 1 Polymers and Resins (continued)	
<i>Drains (continued)</i>	
17. The application area includes drains, drain hubs, manholes, lift stations, trenches, or pipes that convey water with a total annual average concentration greater than or equal to 10,000 parts per million by weight of compounds meeting the definition of organic HAP in 40 CFR § 63.482, at any flow rate.	<input type="checkbox"/> Yes <input type="checkbox"/> No
18. The application area includes drains, drain hubs, manholes, lift stations, trenches or pipes that convey water with a total annual average concentration greater than or equal to 1,000 parts per million by weight of compounds meeting the definition of organic HAP in 40 CFR § 63.482, at an annual average flow rate greater than or equal to 10 liters per minute.	<input type="checkbox"/> Yes <input type="checkbox"/> No
19. The application area includes drains, drain hubs, manholes, lift stations, trenches or pipes that are part of an elastomer product process unit that is a new affected source or part of a new affected source and the equipment conveys water with a total annual average concentration greater than or equal to 10 parts per million by weight of compounds meeting the definition of organic HAP in 40 CFR § 63.482, at an average annual flow rate greater than or equal to 0.02 liter per minute.	<input type="checkbox"/> Yes <input type="checkbox"/> No
K. Subpart W - National Emission Standards for Hazardous Air Pollutants for Epoxy Resins Production and Non-nylon Polyamides Production	
1. The manufacture of basic liquid epoxy resins (BLR) and/or manufacture of wet strength resins (WSR) is conducted in the application area. <i>If the response to Question VIII.K.1 is "No" or "N/A," go to Section VIII.L.</i>	<input type="checkbox"/> Yes <input checked="" type="checkbox"/> No <input type="checkbox"/> N/A
2. The application area includes a BLR and/or WSR research and development facility.	<input type="checkbox"/> Yes <input type="checkbox"/> No

Application Area-Wide Applicability Determinations and General Information
Form OP-REQ1 (Page 48)
Federal Operating Permit Program
Texas Commission on Environmental Quality

Date	Permit No.	Regulated Entity No.
04/16/2026	O5	RN100217439

For SOP applications, answer ALL questions unless otherwise directed.

◆ For GOP applications, answer ONLY these questions unless otherwise directed.

VIII. Title 40 Code of Federal Regulations Part 63 - National Emission Standards for Hazardous Air Pollutants for Source Categories (continued)		
L. Subpart X - National Emission Standards for Hazardous Air Pollutants from Secondary Lead Smelting		
1. The application area includes one or more of the affected sources in 40 CFR § 63.541(a) that are located at a secondary lead smelter. <i>If the response to Question VIII.L.1 is "No" or "N/A," go to Section VIII.M.</i>	<input type="checkbox"/> Yes <input checked="" type="checkbox"/> No <input type="checkbox"/> N/A	
2. The application area is using and approved alternate to the requirements of § 63.545(c)(1)-(5) for control of fugitive dust emission sources.	<input type="checkbox"/> Yes <input type="checkbox"/> No	
M. Subpart Y - National Emission Standards for Marine Tank Vessel Loading Operations		
1. The application area includes marine tank vessel loading operations that are specified in 40 CFR § 63.560 and located at an affected source as defined in 40 CFR § 63.561.	<input type="checkbox"/> Yes <input checked="" type="checkbox"/> No	
N. Subpart CC - National Emission Standards for Hazardous Air Pollutants from Petroleum Refineries		
<i>Applicability</i>		
1. The application area includes petroleum refining process units and/or related emission points that are specified in 40 CFR § 63.640(c)(1) - (c)(7). <i>If the response to Question VIII.N.1 is "No," go to Section VIII.O.</i>	<input type="checkbox"/> Yes <input checked="" type="checkbox"/> No	
2. All petroleum refining process units/and or related emission points within the application area are specified in 40 CFR § 63.640(g)(1) - (g)(7). <i>If the response to Question VIII.N.2 is "Yes," go to Section VIII.O.</i>	<input type="checkbox"/> Yes <input type="checkbox"/> No	

Application Area-Wide Applicability Determinations and General Information
Form OP-REQ1 (Page 49)
Federal Operating Permit Program
Texas Commission on Environmental Quality

Date	Permit No.	Regulated Entity No.
04/16/2026	O5	RN100217439

For SOP applications, answer ALL questions unless otherwise directed.

◆ For GOP applications, answer ONLY these questions unless otherwise directed.

VIII. Title 40 Code of Federal Regulations Part 63 - National Emission Standards for Hazardous Air Pollutants for Source Categories (continued)		
N. Subpart CC - National Emission Standards for Hazardous Air Pollutants from Petroleum Refineries (continued)		
<i>Applicability (continued)</i>		
3.	The application area is located at a plant site that is a major source as defined in the Federal Clean Air Act § 112(a). <i>If the response to Question VIII.N.3 is "No," go to Section VIII.O.</i>	<input type="checkbox"/> Yes <input type="checkbox"/> No
4.	The application area is located at a plant site which emits or has equipment containing/contacting one or more of the HAPs listed in table 1 of 40 CFR Part 63, Subpart CC. <i>If the response to Question VIII.N.4 is "No," go to Section VIII.O.</i>	<input type="checkbox"/> Yes <input type="checkbox"/> No
5.	The application area includes Group 1 wastewater streams that are not conveyed, stored, or treated in a wastewater stream management unit that also receives streams subject to the provisions of 40 CFR §§ 63.133 - 63.147 of Subpart G wastewater provisions section.	<input type="checkbox"/> Yes <input type="checkbox"/> No
6.	The application area includes Group 2 wastewater streams that are not conveyed, stored, or treated in a wastewater stream management unit that also receives streams subject to the provisions of 40 CFR §§ 63.133 - 63.147 of Subpart G wastewater provisions section.	<input type="checkbox"/> Yes <input type="checkbox"/> No
7.	The application area includes Group 1 or Group 2 wastewater streams that are conveyed, stored, or treated in a wastewater stream management unit that also receives streams subject to the provisions of 40 CFR §§ 63.133 - 63.147 of Subpart G wastewater provisions section. <i>If the response to Question VIII.N.7 is "No," go to Question VIII.N.13.</i>	<input type="checkbox"/> Yes <input type="checkbox"/> No
8.	The application area includes Group 1 or Group 2 wastewater streams that are complying with 40 CFR § 63.640(o)(2)(i).	<input type="checkbox"/> Yes <input type="checkbox"/> No

Application Area-Wide Applicability Determinations and General Information
Form OP-REQ1 (Page 50)
Federal Operating Permit Program
Texas Commission on Environmental Quality

Date	Permit No.	Regulated Entity No.
04/16/2026	O5	RN100217439

For SOP applications, answer ALL questions unless otherwise directed.

◆ For GOP applications, answer ONLY these questions unless otherwise directed.

VIII. Title 40 Code of Federal Regulations Part 63 - National Emission Standards for Hazardous Air Pollutants for Source Categories (continued)	
N. Subpart CC - National Emission Standards for Hazardous Air Pollutants from Petroleum Refineries (continued)	
<i>Applicability (continued)</i>	
9. The application area includes Group 1 or Group 2 wastewater streams that are complying with 40 CFR § 63.640(o)(2)(ii). <i>If the response to Question VIII.N.9 is "No," go to Question VIII.N.13.</i>	<input type="checkbox"/> Yes <input type="checkbox"/> No
10. The application area includes Group 2 wastewater streams or organic streams whose benzene emissions are subject to control through the use of one or more treatment processes or waste management units under the provisions of 40 CFR Part 61, Subpart FF on or after December 31, 1992.	<input type="checkbox"/> Yes <input type="checkbox"/> No
Containers, Drains, and other Appurtenances	
11. The application area includes containers that are subject to the requirements of 40 CFR § 63.135 as a result of complying with 40 CFR § 63.640(o)(2)(ii).	<input type="checkbox"/> Yes <input type="checkbox"/> No
12. The application area includes individual drain systems that are subject to the requirements of 40 CFR § 63.136 as a result of complying with 40 CFR § 63.640(o)(2)(ii).	<input type="checkbox"/> Yes <input type="checkbox"/> No
13. The application area includes Group 1 gasoline loading racks as specified in § 63.650(a).	<input type="checkbox"/> Yes <input type="checkbox"/> No
O. Subpart DD - National Emission Standards for Off-site Waste and Recovery Operations	
1. The application area receives material that meets the criteria for off-site material as specified in 40 CFR § 63.680(b)(1). <i>If the response to Question VIII.O.1 is "No" or "N/A," go to Section VIII.P</i>	<input type="checkbox"/> Yes <input checked="" type="checkbox"/> No <input type="checkbox"/> N/A
2. Materials specified in 40 CFR § 63.680(b)(2) are received at the application area.	<input type="checkbox"/> Yes <input type="checkbox"/> No
3. The application area has a waste management operation receiving off-site material and is regulated under 40 CFR Part 264 or Part 265.	<input type="checkbox"/> Yes <input type="checkbox"/> No

Application Area-Wide Applicability Determinations and General Information
Form OP-REQ1 (Page 51)
Federal Operating Permit Program
Texas Commission on Environmental Quality

Date	Permit No.	Regulated Entity No.
04/16/2026	O5	RN100217439

For SOP applications, answer ALL questions unless otherwise directed.

◆ For GOP applications, answer ONLY these questions unless otherwise directed.

VIII. Title 40 Code of Federal Regulations Part 63 - National Emission Standards for Hazardous Air Pollutants for Source Categories (continued)		
O. Subpart DD - National Emission Standards for Off-site Waste and Recovery Operations (continued)		
4.	The application area has a waste management operation treating wastewater which is an off-site material and is exempted under 40 CFR §§ 264.1(g)(6) or 265.1(c)(10).	<input type="checkbox"/> Yes <input type="checkbox"/> No
5.	The application area has an operation subject to Clean Water Act, § 402 or § 307(b) but is not owned by a “state” or “municipality.”	<input type="checkbox"/> Yes <input type="checkbox"/> No
6.	The predominant activity in the application area is the treatment of wastewater received from off-site.	<input type="checkbox"/> Yes <input type="checkbox"/> No
7.	The application area has a recovery operation that recycles or reprocesses hazardous waste which is an off-site material and is exempted under 40 CFR §§ 264.1(g)(2) or 265.1(c)(6).	<input type="checkbox"/> Yes <input type="checkbox"/> No
8.	The application area has a recovery operation that recycles or reprocesses used solvent which is an off-site material and is not part of a chemical, petroleum, or other manufacturing process that is required to use air emission controls by another subpart of 40 CFR Part 63 or Part 61.	<input type="checkbox"/> YES <input type="checkbox"/> No
9.	The application area has a recovery operation that re-refines or reprocesses used oil which is an off-site material and is regulated under 40 CFR Part 279, Subpart F (Standards for Used Oil Processors and Refiners).	<input type="checkbox"/> Yes <input type="checkbox"/> No
10.	The application area is located at a site where the total annual quantity of HAPs in the off-site material is less than 1 megagram per year. <i>If the response to Question VIII.O.10 is “Yes,” go to Section VIII.P.</i>	<input type="checkbox"/> Yes <input type="checkbox"/> No

Application Area-Wide Applicability Determinations and General Information
Form OP-REQ1 (Page 52)
Federal Operating Permit Program
Texas Commission on Environmental Quality

Date	Permit No.	Regulated Entity No.
04/16/2026	O5	RN100217439

For SOP applications, answer ALL questions unless otherwise directed.

◆ For GOP applications, answer ONLY these questions unless otherwise directed.

VIII. Title 40 Code of Federal Regulations Part 63 - National Emission Standards for Hazardous Air Pollutants for Source Categories (continued)		
O. Subpart DD - National Emission Standards for Off-site Waste and Recovery Operations (continued)		
11.	The application area receives offsite materials with average VOHAP concentration less than 500 ppmw at the point of delivery that are not combined with materials having a VOHAP concentration of 500 ppmw or greater. <i>If the response to Question VIII.O.11 is "No," go to Question VIII.O.14.</i>	<input type="checkbox"/> Yes <input type="checkbox"/> No
12.	VOHAP concentration is determined by direct measurement.	<input type="checkbox"/> Yes <input type="checkbox"/> No
13.	VOHAP concentration is based on knowledge of the off-site material.	<input type="checkbox"/> Yes <input type="checkbox"/> No
14.	The application area includes an equipment component that is a pump, compressor, and agitator, pressure relief device, sampling connection system, open-ended valve or line, valve, connector or instrumentation system. <i>If the response to Question VIII.O.14 is "No," go to Question VIII.O.17.</i>	<input type="checkbox"/> Yes <input type="checkbox"/> No
15.	An equipment component in the application area contains or contacts off-site material with a HAP concentration greater than or equal to 10% by weight.	<input type="checkbox"/> Yes <input type="checkbox"/> No
16.	An equipment component in the application area is intended to operate 300 hours or more during a 12-month period.	<input type="checkbox"/> Yes <input type="checkbox"/> No
17.	The application area includes containers that manage non-exempt off-site material.	<input type="checkbox"/> Yes <input type="checkbox"/> No
18.	The application area includes individual drain systems that manage non-exempt off-site materials.	<input type="checkbox"/> Yes <input type="checkbox"/> No

Application Area-Wide Applicability Determinations and General Information
Form OP-REQ1 (Page 53)
Federal Operating Permit Program
Texas Commission on Environmental Quality

Date	Permit No.	Regulated Entity No.
04/16/2026	O5	RN100217439

For SOP applications, answer ALL questions unless otherwise directed.

◆ For GOP applications, answer ONLY these questions unless otherwise directed.

VIII. Title 40 Code of Federal Regulations Part 63 - National Emission Standards for Hazardous Air Pollutants for Source Categories (continued)		
P. Subpart GG - National Emission Standards for Aerospace Manufacturing and Rework Facilities		
1.	The application area includes facilities that manufacture or rework commercial, civil, or military aerospace vehicles or components. <i>If the response to Question VIII.P.1 is "No" or "N/A," go to Section VIII.Q.</i>	<input type="checkbox"/> Yes <input checked="" type="checkbox"/> No <input type="checkbox"/> N/A
2.	The application area includes one or more of the affected sources specified in 40 CFR § 63.741(c)(1) - (7).	<input type="checkbox"/> Yes <input type="checkbox"/> No
Q. Subpart HH - National Emission Standards for Hazardous Air Pollutants From Oil and Natural Gas Production Facilities.		
◆ 1.	The application area contains facilities that process, upgrade or store hydrocarbon liquids that are located at oil and natural gas production facilities prior to the point of custody transfer.	<input type="checkbox"/> Yes <input checked="" type="checkbox"/> No
◆ 2.	The application area contains facilities that process, upgrade or store natural gas prior to the point at which natural gas enters the natural gas transmission and storage source category or is delivered to a final end user. <i>For SOP applications, if the responses to Questions VIII.Q.1 and VIII.Q.2 are both "No," go to Section VIII.R.</i> <i>For GOP applications, if the responses to Questions VIII.Q.1 and VIII.Q.2 are both "No," go to Section VIII.Z.</i>	<input type="checkbox"/> Yes <input checked="" type="checkbox"/> No
◆ 3.	The application area contains only facilities that exclusively process, store or transfer black oil as defined in § 63.761. <i>For SOP applications, if the response to Question VIII.Q.3 is "Yes," go to Section VIII.R.</i> <i>For GOP applications, if the response to Question VIII.Q.3 is "Yes," go to Section VIII.Z.</i>	<input type="checkbox"/> Yes <input type="checkbox"/> No
◆ 4.	The application area is located at a site that is a major source of HAP. <i>If the response to Question VIII.Q.4 is "No," go to Question VIII.Q.6.</i>	<input type="checkbox"/> Yes <input type="checkbox"/> No

Application Area-Wide Applicability Determinations and General Information
Form OP-REQ1 (Page 54)
Federal Operating Permit Program
Texas Commission on Environmental Quality

Date	Permit No.	Regulated Entity No.
04/16/2026	O5	RN100217439

For SOP applications, answer ALL questions unless otherwise directed.

◆ For GOP applications, answer ONLY these questions unless otherwise directed.

VIII. Title 40 Code of Federal Regulations Part 63 - National Emission Standards for Hazardous Air Pollutants for Source Categories (continued)		
Q. Subpart - HH - National Emission Standards for Hazardous Air Pollutants From Oil and Natural Gas Production Facilities (continued)		
◆ 5.	<p>The application area contains only a facility, prior to the point of custody transfer, with facility-wide actual annual average natural gas throughput less than 18.4 thousand standard cubic meters (649,789.9 ft³) per day and a facility-wide actual annual average hydrocarbon liquid throughput less than 39,700 liters (10,487.6 gallons) per day.</p> <p><i>For SOP applications, if the response to Question VIII.Q.5 is "Yes," go to Section VIII.R.</i></p> <p><i>For GOP applications, if the response to Question VIII.Q.5 is "Yes," go to Section VIII.Z.</i></p> <p><i>For all applications, if the response to Question VIII.Q.5 is "No," go to Question VIII.Q.9.</i></p>	<input type="checkbox"/> Yes <input type="checkbox"/> No
◆ 6.	<p>The application area includes a triethylene glycol (TEG) dehydration unit.</p> <p><i>For SOP applications, if the answer to Question VIII.Q.6 is "No," go to Section VIII.R. For GOP applications, if the response to Question VIII.Q.6 is "No," go to Section VIII.Z.</i></p>	<input type="checkbox"/> Yes <input type="checkbox"/> No
◆ 7.	<p>The application area is located at a site that is within the boundaries of UA plus offset or a UC, as defined in 40 CFR § 63.761.</p>	<input type="checkbox"/> Yes <input type="checkbox"/> No
◆ 8.	<p>The site has actual emissions of 5 tons per year or more of a single HAP, or 12.5 tons per year or more of a combination of HAP.</p>	<input type="checkbox"/> Yes <input type="checkbox"/> No
◆ 9.	<p>Emissions for major source determination are being estimated based on the maximum natural gas or hydrocarbon liquid throughput as calculated in § 63.760(a)(1)(i)-(iii).</p>	<input type="checkbox"/> Yes <input type="checkbox"/> No

Application Area-Wide Applicability Determinations and General Information
Form OP-REQ1 (Page 55)
Federal Operating Permit Program
Texas Commission on Environmental Quality

Date	Permit No.	Regulated Entity No.
04/16/2026	O5	RN100217439

For SOP applications, answer ALL questions unless otherwise directed.

◆ For GOP applications, answer ONLY these questions unless otherwise directed.

VIII. Title 40 Code of Federal Regulations Part 63 - National Emission Standards for Hazardous Air Pollutants for Source Categories (continued)	
R. Subpart II - National Emission Standards for Shipbuilding and Ship Repair (Surface Coating)	
1. The application area includes shipbuilding or ship repair operations. <i>If the response to Question VIII.R.1 is "NO," go to Section VIII.S.</i>	<input type="checkbox"/> Yes <input checked="" type="checkbox"/> No
2. Shipbuilding or ship repair operations located in the application area are subject to 40 CFR Part 63, Subpart II.	<input type="checkbox"/> Yes <input type="checkbox"/> No
S. Subpart JJ - National Emission Standards for Wood Furniture Manufacturing Operations	
1. The application area includes wood furniture manufacturing operations and/or wood furniture component manufacturing operations. <i>If the response to Question VIII.S.1 is "No" or "N/A," go to Section VIII.T.</i>	<input type="checkbox"/> Yes <input checked="" type="checkbox"/> No <input type="checkbox"/> N/A
2. The application area meets the definition of an "incidental wood manufacturer" as defined in 40 CFR § 63.801.	<input type="checkbox"/> Yes <input type="checkbox"/> No
T. Subpart KK - National Emission Standards for the Printing and Publishing Industry	
1. The application area includes publication rotogravure, product and packaging rotogravure, or wide-web flexographic printing presses.	<input type="checkbox"/> Yes <input checked="" type="checkbox"/> No <input type="checkbox"/> N/A
U. Subpart PP - National Emission Standards for Containers	
1. The application area includes containers for which another 40 CFR Part 60, 61, or 63 subpart references the use of 40 CFR Part 63, Subpart PP for the control of air emissions. <i>If the response to Question VIII.U.1 is "NO," go to Section VIII.V.</i>	<input type="checkbox"/> Yes <input checked="" type="checkbox"/> No
2. The application area includes containers using Container Level 1 controls.	<input type="checkbox"/> Yes <input type="checkbox"/> No
3. The application area includes containers using Container Level 2 controls.	<input type="checkbox"/> Yes <input type="checkbox"/> No

Application Area-Wide Applicability Determinations and General Information
Form OP-REQ1 (Page 56)
Federal Operating Permit Program
Texas Commission on Environmental Quality

Date	Permit No.	Regulated Entity No.
04/16/2026	O5	RN100217439

For SOP applications, answer ALL questions unless otherwise directed.

◆ For GOP applications, answer ONLY these questions unless otherwise directed.

VIII. Title 40 Code of Federal Regulations Part 63 - National Emission Standards for Hazardous Air Pollutants for Source Categories (continued)	
U. Subpart PP - National Emission Standards for Containers (continued)	
4. The application area includes containers using Container Level 3 controls.	<input type="checkbox"/> Yes <input type="checkbox"/> No
V. Subpart RR - National Emission Standards for Individual Drain Systems	
1. The application area includes individual drain systems for which another 40 CFR Part 60, 61, or 63 subpart references the use of 40 CFR Part 63, Subpart RR for the control of air emissions.	<input type="checkbox"/> Yes <input checked="" type="checkbox"/> No
W. Subpart YY - National Emission Standards for Hazardous Air Pollutants for Source Categories - Generic Maximum Achievable Control Technology Standards	
1. The application area includes an acetal resins production process unit; an acrylic and modacrylic fiber production process unit complying with 40 CFR § 63.1103(b)(3)(i); or an existing polycarbonate production process.	<input type="checkbox"/> Yes <input checked="" type="checkbox"/> No
2. The application area includes process wastewater streams generated from an acetal resins production process unit; an acrylic and modacrylic fiber production process unit complying with 40 CFR § 63.1103(b)(3)(i); or an existing polycarbonate production process. <i>If the responses to Questions VIII.W.1 and VIII.W.2 are both "No," go to Question VIII.W.20.</i>	<input type="checkbox"/> Yes <input checked="" type="checkbox"/> No
3. The application area includes process wastewater streams that are designated as Group 1 or are determined to be Group 1 under the requirements of 40 CFR § 63.132(c).	<input type="checkbox"/> Yes <input type="checkbox"/> No
4. The application area includes process wastewater streams that are determined to be Group 2 under the requirements of 40 CFR § 63.132(c).	<input type="checkbox"/> Yes <input type="checkbox"/> No
5. All Group 1 wastewater streams at the site are determined to have a total source mass flow rate of less than 1 MG/yr.	<input type="checkbox"/> Yes <input type="checkbox"/> No
6. The site has untreated and/or partially treated Group 1 wastewater streams demonstrated to have a total source mass flow rate of less than 1 MG/yr. <i>If the response to Question VIII.W.6 is "No," go to Question VIII.W.8.</i>	<input type="checkbox"/> Yes <input type="checkbox"/> No

Application Area-Wide Applicability Determinations and General Information
Form OP-REQ1 (Page 57)
Federal Operating Permit Program
Texas Commission on Environmental Quality

Date	Permit No.	Regulated Entity No.
04/16/2026	O5	RN100217439

For SOP applications, answer ALL questions unless otherwise directed.

◆ For GOP applications, answer ONLY these questions unless otherwise directed.

VIII. Title 40 Code of Federal Regulations Part 63 - National Emission Standards for Hazardous Air Pollutants for Source Categories (continued)		
W. Subpart YY - National Emission Standards for Hazardous Air Pollutants for Source Categories - Generic Maximum Achievable Control Technology Standards (continued)		
7.	The application area includes waste management units that receive or manage a partially treated Group 1 wastewater stream prior to or during treatment.	<input type="checkbox"/> Yes <input type="checkbox"/> No
8.	Group 1 wastewater streams or residual removed from Group 1 wastewater streams are transferred to an on-site treatment operation that is not owned or operated by the owner or operator of the source generating the waste stream or residual.	<input type="checkbox"/> Yes <input type="checkbox"/> No
9.	Group 1 wastewater streams or residual removed from Group 1 wastewater streams are transferred to an off-site treatment operation. <i>If the responses to Questions VIII.W.8 and W.9 are both "No," go to Question VIII.W.11.</i>	<input type="checkbox"/> Yes <input type="checkbox"/> No
10.	The application area includes waste management units that receive or manage a Group 1 wastewater stream, or a residual removed from a Group 1 wastewater stream prior to shipment or transport.	<input type="checkbox"/> Yes <input type="checkbox"/> No
11.	The application area includes containers that receive, manage, or treat a Group 1 wastewater stream or a residual removed from a Group 1 wastewater stream.	<input type="checkbox"/> Yes <input type="checkbox"/> No
12.	The application area includes individual drain systems that receive, manage, or treat a Group 1 wastewater stream or a residual removed from a Group 1 wastewater stream. <i>If the response to Question VIII.W.12 is "No," go to Question VIII.W.15.</i>	<input type="checkbox"/> Yes <input type="checkbox"/> No
13.	The application area includes individual drain systems that are complying with 40 CFR § 63.136 through the use of covers and, if vented, closed vent systems and control devices.	<input type="checkbox"/> Yes <input type="checkbox"/> No
14.	The application area includes individual drain systems that are complying with 40 CFR § 63.136 through the use of water seals or tightly fitting caps or plugs.	<input type="checkbox"/> Yes <input type="checkbox"/> No

Application Area-Wide Applicability Determinations and General Information
Form OP-REQ1 (Page 58)
Federal Operating Permit Program
Texas Commission on Environmental Quality

Date	Permit No.	Regulated Entity No.
04/16/2026	O5	RN100217439

For SOP applications, answer ALL questions unless otherwise directed.

◆ For GOP applications, answer ONLY these questions unless otherwise directed.

VIII. Title 40 Code of Federal Regulations Part 63 - National Emission Standards for Hazardous Air Pollutants for Source Categories (continued)	
W. Subpart YY - National Emission Standards for Hazardous Air Pollutants for Source Categories - Generic Maximum Achievable Control Technology Standards (continued)	
<p>15. The application area includes drains, drain hubs, manholes, lift stations, trenches, or pipes that are part of an acetal resins production process unit; an acrylic and modacrylic fiber production process unit complying with 40 CFR § 63.1103(b)(3)(i); or an existing polycarbonate production process unit. <i>If the response to Question VIII.W.15 is "No," go to Question VIII.W.20.</i></p>	<input type="checkbox"/> Yes <input type="checkbox"/> No
<p>16. The application area includes drains, drain hubs, manholes, lift stations, trenches or pipes that meet the criteria listed in 40 CFR § 63.1106(c)(1) - (3). <i>If the response to Question VIII.W.16 is "No," go to Question VIII.W.20.</i></p>	<input type="checkbox"/> Yes <input type="checkbox"/> No
<p>17. The application area includes drains, drain hubs, manholes, lift stations, trenches or pipes that convey water with a total annual average concentration greater than or equal to 10,000 parts per million by weight of compounds meeting the definition of organic HAP in Table 9 to 40 CFR Part 60, Subpart G, at any flow rate.</p>	<input type="checkbox"/> Yes <input type="checkbox"/> No
<p>18. The application area includes drains, drain hubs, manholes, lift stations, trenches or pipes that convey water with a total annual average concentration greater than or equal to 1,000 parts per million by weight of compounds meeting the definition of organic HAP in Table 9 to 40 CFR Part 60, Subpart G, at an annual average flow rate greater than or equal to 10 liters per minute.</p>	<input type="checkbox"/> Yes <input type="checkbox"/> No

Application Area-Wide Applicability Determinations and General Information
Form OP-REQ1 (Page 59)
Federal Operating Permit Program
Texas Commission on Environmental Quality

Date	Permit No.	Regulated Entity No.
04/16/2026	O5	RN100217439

For SOP applications, answer ALL questions unless otherwise directed.

◆ For GOP applications, answer ONLY these questions unless otherwise directed.

VIII. Title 40 Code of Federal Regulations Part 63 - National Emission Standards for Hazardous Air Pollutants for Source Categories (continued)	
W. Subpart YY - National Emission Standards for Hazardous Air Pollutants for Source Categories - Generic Maximum Achievable Control Technology Standards (continued)	
19. The application area includes drains, drain hubs, manholes, lift stations, trenches or pipes that are part of an acrylic resins or acrylic and modacrylic fiber production process unit that is part of a new affected source or is a new affected source and the equipment conveys water with a total annual average concentration greater than or equal to 10 ppmw of compounds meeting the definition of organic HAP in Table 9 to 40 CFR Part 60, Subpart G, at an average annual flow rate greater than or equal to 0.02 liter per minute.	<input type="checkbox"/> Yes <input type="checkbox"/> No
20. The application area includes an ethylene production process unit.	<input type="checkbox"/> Yes <input checked="" type="checkbox"/> No <input type="checkbox"/> N/A
21. The application area includes waste streams generated from an ethylene production process unit. <i>If the responses to Questions VIII.W.20 and VIII.W.21 are both "No" or "N/A," go to Question VIII.W.54.</i>	<input type="checkbox"/> Yes <input checked="" type="checkbox"/> No <input type="checkbox"/> N/A
22. The waste stream(s) contains at least one of the chemicals listed in 40 CFR § 63.1103(e), Table 7(g)(1). <i>If the response to Question VIII.W.22 is "No," go to Question VIII.W.54.</i>	<input type="checkbox"/> Yes <input type="checkbox"/> No
23. Waste stream(s) are transferred off-site for treatment. <i>If the response to Question VIII.W.23 is "No," go to Question VIII.W.25.</i>	<input type="checkbox"/> Yes <input type="checkbox"/> No
24. The application area has waste management units that treat or manage waste stream(s) prior to transfer off-site for treatment. <i>If the response to Question VIII.W.24 is "No," go to Question VIII.W.54.</i>	<input type="checkbox"/> Yes <input type="checkbox"/> No

Application Area-Wide Applicability Determinations and General Information
Form OP-REQ1 (Page 60)
Federal Operating Permit Program
Texas Commission on Environmental Quality

Date	Permit No.	Regulated Entity No.
04/16/2026	O5	RN100217439

For SOP applications, answer ALL questions unless otherwise directed.

◆ For GOP applications, answer ONLY these questions unless otherwise directed.

VIII. Title 40 Code of Federal Regulations Part 63 - National Emission Standards for Hazardous Air Pollutants for Source Categories (continued)		
W. Subpart YY - National Emission Standards for Hazardous Air Pollutants for Source Categories - Generic Maximum Achievable Control Technology Standards (continued)		
25.	The total annual benzene quantity from waste at the site is less than 10 Mg/yr as determined according to 40 CFR § 61.342(a).	<input type="checkbox"/> Yes <input type="checkbox"/> No
26.	The application area contains at least one waste stream that is a continuous butadiene waste stream as defined in 40 CFR § 63.1082(b). <i>If the response to Question VIII.W.26 is "No," go to Question VIII.W.43.</i>	<input type="checkbox"/> Yes <input type="checkbox"/> No
27.	The waste stream(s) contains at least 10 ppmw 1, 3-butadiene at a flow rate of 0.02 liters per minute or is designated for control. <i>If the response to Question VIII.W.27 is "No," go to Question VIII.W.43.</i>	<input type="checkbox"/> Yes <input type="checkbox"/> No
28.	The control requirements of 40 CFR Part 63, Subpart G for process wastewater as specified in 40 CFR § 63.1095(a)(2) are selected for control of the waste stream(s). <i>If the response to Question VIII.W.28 is "No," go to Question VIII.W.33.</i>	<input type="checkbox"/> Yes <input type="checkbox"/> No
29.	The application area includes containers that receive, manage, or treat a continuous butadiene waste stream.	<input type="checkbox"/> Yes <input type="checkbox"/> No
30.	The application area includes individual drain systems that receive, manage, or treat a continuous butadiene waste stream. <i>If the response to Question VIII.W.30 is "No," go to Question VIII.W.43.</i>	<input type="checkbox"/> Yes <input type="checkbox"/> No
31.	The application area includes individual drain systems that are complying with 40 CFR § 63.136 through the use of cover and, if vented, closed vent systems and control devices.	<input type="checkbox"/> Yes <input type="checkbox"/> No

Application Area-Wide Applicability Determinations and General Information
Form OP-REQ1 (Page 61)
Federal Operating Permit Program
Texas Commission on Environmental Quality

Date	Permit No.	Regulated Entity No.
04/16/2026	O5	RN100217439

For SOP applications, answer ALL questions unless otherwise directed.

◆ For GOP applications, answer ONLY these questions unless otherwise directed.

VIII. Title 40 Code of Federal Regulations Part 63 - National Emission Standards for Hazardous Air Pollutants for Source Categories (continued)	
W. Subpart YY - National Emission Standards for Hazardous Air Pollutants for Source Categories - Generic Maximum Achievable Control Technology Standards (continued)	
32. The application area includes individual drain systems that are complying with 40 CFR § 63.136 through the use of water seals or tightly fitting caps or plugs. <i>If the response to Question VIII.W.32 is required, go to Question VIII.W.43.</i>	<input type="checkbox"/> Yes <input type="checkbox"/> No
33. The application area has containers, as defined in 40 CFR § 61.341, that receive a continuous butadiene waste stream. <i>If the response to Question VIII.W.33 is "No," go to Question VIII.W.36.</i>	<input type="checkbox"/> Yes <input type="checkbox"/> No
34. The application area is an alternate means of compliance to meet the 40 CFR § 61.345 requirements for containers. <i>If the response to Question VIII.W.34 is "Yes," go to Question VIII.W.36.</i>	<input type="checkbox"/> Yes <input type="checkbox"/> No
35. Covers and closed-vent systems used for containers operate such that the container is maintained at a pressure less than atmospheric pressure.	<input type="checkbox"/> Yes <input type="checkbox"/> No
36. The application area has individual drain systems, as defined in 40 CFR § 61.341, that receive or manage a continuous butadiene waste stream. <i>If the response to Question VIII.W.36 is "No," go to Question VIII.W.43.</i>	<input type="checkbox"/> Yes <input type="checkbox"/> No
37. The application area is using an alternate means of compliance to meet the 40 CFR § 61.346 requirements for individual drain systems. <i>If the response to Question VIII.W.37 is "Yes," go to Question VIII.W.43.</i>	<input type="checkbox"/> Yes <input type="checkbox"/> No

Application Area-Wide Applicability Determinations and General Information
Form OP-REQ1 (Page 62)
Federal Operating Permit Program
Texas Commission on Environmental Quality

Date	Permit No.	Regulated Entity No.
04/16/2026	O5	RN100217439

For SOP applications, answer ALL questions unless otherwise directed.

◆ For GOP applications, answer ONLY these questions unless otherwise directed.

VIII. Title 40 Code of Federal Regulations Part 63 - National Emission Standards for Hazardous Air Pollutants for Source Categories (continued)		
W. Subpart YY - National Emission Standards for Hazardous Air Pollutants for Source Categories - Generic Maximum Achievable Control Technology Standards (continued)		
38.	The application area has individual drain systems complying with 40 CFR § 61.346(a). <i>If the response to Question VIII.W.38 is "No," go to Question VIII.W.40.</i>	<input type="checkbox"/> Yes <input type="checkbox"/> No
39.	Covers and closed-vent systems used for individual drain systems operate such that the individual drain system is maintained at a pressure less than atmospheric pressure.	<input type="checkbox"/> Yes <input type="checkbox"/> No
40.	The application area has individual drain systems complying with 40 CFR § 61.346(b). <i>If the response to Question VIII.W.40 is "No," go to Question VIII.W.43.</i>	<input type="checkbox"/> Yes <input type="checkbox"/> No
41.	Junction boxes in the individual drain systems are equipped with a system to prevent the flow of organic vapors from the junction box vent pipe to the atmosphere during normal operation.	<input type="checkbox"/> Yes <input type="checkbox"/> No
42.	Junction box vent pipes in the individual drain systems are connected to a closed-vent system and control device.	<input type="checkbox"/> Yes <input type="checkbox"/> No
43.	The application area has at least one waste stream that contains benzene. <i>If the response to Question VIII.W.43 is "No," go to Question VIII.W.54.</i>	<input type="checkbox"/> Yes <input type="checkbox"/> No
44.	The application area has containers, as defined in 40 CFR § 61.341, that receive a waste stream containing benzene. <i>If the response to Question VIII.W.44 is "No," go to Question VIII.W.47.</i>	<input type="checkbox"/> Yes <input type="checkbox"/> No
45.	The application area is an alternate means of compliance to meet the 40 CFR § 61.345 requirements for containers. <i>If the response to Question VIII.W.45 is "Yes," go to Question VIII.W.47.</i>	<input type="checkbox"/> Yes <input type="checkbox"/> No

Application Area-Wide Applicability Determinations and General Information
Form OP-REQ1 (Page 63)
Federal Operating Permit Program
Texas Commission on Environmental Quality

Date	Permit No.	Regulated Entity No.
04/16/2026	O5	RN100217439

For SOP applications, answer ALL questions unless otherwise directed.

◆ For GOP applications, answer ONLY these questions unless otherwise directed.

VIII. Title 40 Code of Federal Regulations Part 63 - National Emission Standards for Hazardous Air Pollutants for Source Categories (continued)	
W. Subpart YY - National Emission Standards for Hazardous Air Pollutants for Source Categories - Generic Maximum Achievable Control Technology Standards (continued)	
46. Covers and closed-vent systems used for containers operate such that the container is maintained at a pressure less than atmospheric pressure.	<input type="checkbox"/> Yes <input type="checkbox"/> No
47. The application area has individual drain systems, as defined in 40 CFR § 61.341, that receive or manage a waste stream containing benzene. <i>If the response to Question VIII.W.47 is "No," go to Question VIII.W.54.</i>	<input type="checkbox"/> Yes <input type="checkbox"/> No
48. The application area is using an alternate means of compliance to meet the 40 CFR § 61.346 requirements for individual drain systems. <i>If the response to Question VIII.W.48 is "Yes," go to Question VIII.W.54.</i>	<input type="checkbox"/> Yes <input type="checkbox"/> No
49. The application area has individual drain systems complying with 40 CFR § 61.346(a). <i>If the response to Question VIII.W.49 is "No," go to Question VIII.W.51.</i>	<input type="checkbox"/> Yes <input type="checkbox"/> No
50. Covers and closed-vent systems used for individual drain systems operate such that the individual drain system is maintained at a pressure less than atmospheric pressure.	<input type="checkbox"/> Yes <input type="checkbox"/> No
51. The application area has individual drain systems complying with 40 CFR § 61.346(b). <i>If the response to Question VIII.W.51 is "No," go to Question VIII.W.54.</i>	<input type="checkbox"/> Yes <input type="checkbox"/> No
52. Junction boxes in the individual drain systems are equipped with a system to prevent the flow of organic vapors from the junction box vent pipe to the atmosphere during normal operation.	<input type="checkbox"/> Yes <input type="checkbox"/> No

Application Area-Wide Applicability Determinations and General Information
Form OP-REQ1 (Page 64)
Federal Operating Permit Program
Texas Commission on Environmental Quality

Date	Permit No.	Regulated Entity No.
04/16/2026	O5	RN100217439

For SOP applications, answer ALL questions unless otherwise directed.

◆ For GOP applications, answer ONLY these questions unless otherwise directed.

VIII. Title 40 Code of Federal Regulations Part 63 - National Emission Standards for Hazardous Air Pollutants for Source Categories (continued)	
W. Subpart YY - National Emission Standards for Hazardous Air Pollutants for Source Categories - Generic Maximum Achievable Control Technology Standards (continued)	
53. Junction box vent pipes in the individual drain systems are connected to a closed-vent system and control device.	<input type="checkbox"/> Yes <input type="checkbox"/> No
54. The application area contains a cyanide chemicals manufacturing process. <i>If the response to Question VIII.W.54 is "No," go to Section VIII.X.</i>	<input type="checkbox"/> Yes <input checked="" type="checkbox"/> No
55. The cyanide chemicals manufacturing process generates maintenance wastewater containing hydrogen cyanide or acetonitrile.	<input type="checkbox"/> Yes <input type="checkbox"/> No
X. Subpart JJJ - National Emission Standards for Hazardous Air Pollutant Emissions: Group IV Polymers and Resins	
1. The application area includes thermoplastic product process units, and/or their associated affected sources specified in 40 CFR § 63.1310(a)(1) - (5), that are subject to 40 CFR Part 63, Subpart JJJ. <i>If the response to Question VIII.X.1 is "No," go to Section VIII.Y.</i>	<input type="checkbox"/> Yes <input checked="" type="checkbox"/> No
2. The application area includes thermoplastic product process units and/or wastewater streams and wastewater operations that are associated with thermoplastic product process units. <i>If the response to Question VIII.X.2 is "No," go to Section VIII.Y.</i>	<input type="checkbox"/> Yes <input type="checkbox"/> No
3. All process wastewater streams generated or managed in the application area are from sources producing polystyrene. <i>If the response to Question VIII.X.3 is "Yes," go to Section VIII.Y.</i>	<input type="checkbox"/> Yes <input type="checkbox"/> No
4. All process wastewater streams generated or managed in the application area are from sources producing ASA/AMSAN. <i>If the response to Question VIII.X.4 is "Yes," go to Section VIII.Y.</i>	<input type="checkbox"/> Yes <input type="checkbox"/> No

Application Area-Wide Applicability Determinations and General Information
Form OP-REQ1 (Page 65)
Federal Operating Permit Program
Texas Commission on Environmental Quality

Date	Permit No.	Regulated Entity No.
04/16/2026	O5	RN100217439

For SOP applications, answer ALL questions unless otherwise directed.

◆ For GOP applications, answer ONLY these questions unless otherwise directed.

VIII. Title 40 Code of Federal Regulations Part 63 - National Emission Standards for Hazardous Air Pollutants for Source Categories (continued)		
X. Subpart JJJ - National Emission Standards for Hazardous Air Pollutant Emissions: Group IV Polymers and Resins (continued)		
5.	The application area includes process wastewater streams that are designated as Group 1 or are determined to be Group 1 for organic HAPs as defined in 40 CFR § 63.1312.	<input type="checkbox"/> Yes <input type="checkbox"/> No
6.	The application area includes process wastewater streams, located at existing sources, that are Group 2 for organic HAPs as defined in 40 CFR § 63.1312.	<input type="checkbox"/> Yes <input type="checkbox"/> No
7.	The application area includes process wastewater streams, located at new sources, that are Group 2 for organic HAPs as defined in 40 CFR § 63.1312.	<input type="checkbox"/> Yes <input type="checkbox"/> No
8.	All Group 1 wastewater streams at the site are demonstrated to have a total source mass flow rate of less than 1 MG/yr. <i>If the response to Question VIII.X.8 is "Yes," go to Question VIII.X.18.</i>	<input type="checkbox"/> Yes <input type="checkbox"/> No
9.	The site has untreated and/or partially treated Group 1 wastewater streams demonstrated to have a total source mass flow rate of less than 1 MG/yr. <i>If the response to Question VIII.X.9 is "No," go to Question VIII.X.11.</i>	<input type="checkbox"/> Yes <input type="checkbox"/> No
10.	The application area includes waste management units that receive or manage a partially treated Group 1 wastewater stream prior to or during treatment.	<input type="checkbox"/> Yes <input type="checkbox"/> No
11.	Group 1 wastewater streams or residual removed from Group 1 wastewater streams are transferred to an on-site treatment operation that is not owned or operated by the owner or operator of the source generating the waste stream or residual.	<input type="checkbox"/> Yes <input type="checkbox"/> No
12.	Group 1 wastewater streams or residual removed from Group 1 wastewater streams are transferred to an off-site treatment operation. <i>If the responses to Questions VIII.X.11 - VIII.X.12 are both "No," go to Question VIII.X.14.</i>	<input type="checkbox"/> Yes <input type="checkbox"/> No

Application Area-Wide Applicability Determinations and General Information
Form OP-REQ1 (Page 66)
Federal Operating Permit Program
Texas Commission on Environmental Quality

Date	Permit No.	Regulated Entity No.
04/16/2026	O5	RN100217439

For SOP applications, answer ALL questions unless otherwise directed.

◆ For GOP applications, answer ONLY these questions unless otherwise directed.

VIII. Title 40 Code of Federal Regulations Part 63 - National Emission Standards for Hazardous Air Pollutants for Source Categories (continued)	
X. Subpart JJJ - National Emission Standards for Hazardous Air Pollutant Emissions: Group IV Polymers and Resins (continued)	
13. The application area includes waste management units that receive or manage a Group 1 wastewater stream, or a residual removed from a Group 1 wastewater stream prior to shipment or transport.	<input type="checkbox"/> Yes <input type="checkbox"/> No
Containers	
14. The application area includes containers that receive, manage, or treat a Group 1 wastewater stream or a residual removed from a Group 1 wastewater stream.	<input type="checkbox"/> Yes <input type="checkbox"/> No
Drains	
15. The application area includes individual drain systems that receive or manage a Group 1 wastewater stream or a residual removed from a Group 1 wastewater stream. <i>If the response to Question VIII.X.15 is "No," go to Question VIII.X.18.</i>	<input type="checkbox"/> Yes <input type="checkbox"/> No
16. The application area includes individual drain systems that are complying with 40 CFR § 63.136 through the use of cover and, if vented, closed vent systems and control devices.	<input type="checkbox"/> Yes <input type="checkbox"/> No
17. The application area includes individual drain systems that are complying with 40 CFR § 63.136 through the use of water seals or tightly fitting caps or plugs.	<input type="checkbox"/> Yes <input type="checkbox"/> No
18. The application area includes drains, drain hubs, manholes, lift stations, trenches, or pipes that are part of a thermoplastic product process unit. <i>If the response to Question VIII.X.18 is "No," go to Section VIII.Y.</i>	<input type="checkbox"/> Yes <input type="checkbox"/> No

Application Area-Wide Applicability Determinations and General Information
Form OP-REQ1 (Page 67)
Federal Operating Permit Program
Texas Commission on Environmental Quality

Date	Permit No.	Regulated Entity No.
04/16/2026	O5	RN100217439

For SOP applications, answer ALL questions unless otherwise directed.

◆ For GOP applications, answer ONLY these questions unless otherwise directed.

VIII. Title 40 Code of Federal Regulations Part 63 - National Emission Standards for Hazardous Air Pollutants for Source Categories (continued)	
X. Subpart JJJ - National Emission Standards for Hazardous Air Pollutant Emissions: Group IV Polymers and Resins (continued)	
<i>Drains (continued)</i>	
<p>19. The application area includes drains, drain hubs, manholes, lift stations, trenches or pipes that meet the criteria listed in 40 CFR § 63.149(d) and § 63.1330(b)(12). <i>If the response to Question VIII.X.19 is "NO," go to Section VIII.Y.</i></p>	<input type="checkbox"/> Yes <input type="checkbox"/> No
<p>20. The application area includes drains, drain hubs, manholes, lift stations, trenches, or pipes that convey water with a total annual average concentration greater than or equal to 10,000 parts per million by weight of compounds meeting the definition of organic HAP in 40 CFR § 63.1312, at any flow rate.</p>	<input type="checkbox"/> Yes <input type="checkbox"/> No
<p>21. The application area includes drains, drain hubs, manholes, lift stations, trenches or pipes that convey water with a total annual average concentration greater than or equal to 1,000 parts per million by weight of compounds meeting the definition of organic HAP in 40 CFR § 63.1312, at an annual average flow rate greater than or equal to 10 liters per minute.</p>	<input type="checkbox"/> Yes <input type="checkbox"/> No
<p>22. The application area includes drains, drain hubs, manholes, lift stations, trenches or pipes that are part of an thermoplastic product process unit that is a new affected source or part of a new affected source and the equipment conveys water with a total annual average concentration greater than or equal to 10 parts per million by weight of compounds meeting the definition of organic HAP in 40 CFR § 63.1312, at an average annual flow rate greater than or equal to 0.02 liter per minute</p>	<input type="checkbox"/> Yes <input type="checkbox"/> No

Application Area-Wide Applicability Determinations and General Information
Form OP-REQ1 (Page 68)
Federal Operating Permit Program
Texas Commission on Environmental Quality

Date	Permit No.	Regulated Entity No.
04/16/2026	O5	RN100217439

For SOP applications, answer ALL questions unless otherwise directed.

◆ For GOP applications, answer ONLY these questions unless otherwise directed.

VIII. Title 40 Code of Federal Regulations Part 63 - National Emission Standards for Hazardous Air Pollutants for Source Categories (continued)	
Y. Subpart UUU - National Emission Standards for Hazardous Air Pollutants for Petroleum Refineries: Catalytic Cracking Units, Catalytic Reforming Units, and Sulfur Recovery Units.	
1. The application area is subject to 40 CFR Part 63, Subpart UUU - National Emission Standards for Hazardous Air Pollutants for Petroleum Refineries: Catalytic Cracking Units, Catalytic Reforming Units, and Sulfur Recovery Units.	<input type="checkbox"/> Yes <input checked="" type="checkbox"/> No
Z. Subpart AAAA - National Emission Standards for Hazardous Air Pollutants for Municipal Solid Waste (MSW) Landfills.	
◆ 1. The application area is subject to 40 CFR Part 63, Subpart AAAA - National Emission Standards for Hazardous Air Pollutants for Municipal Solid Waste Landfills.	<input type="checkbox"/> Yes <input checked="" type="checkbox"/> No
AA. Subpart FFFF - National Emission Standards for Hazardous Air Pollutants for Miscellaneous Organic Chemical Production and Processes (MON)	
1. The application area is located at a site that includes process units that manufacture as a primary product one or more of the chemicals listed in 40 CFR § 63.2435(b)(1).	<input type="checkbox"/> Yes <input checked="" type="checkbox"/> No
2. The application area is located at a plant site that is a major source as defined in FCAA § 112(a).	<input type="checkbox"/> Yes <input checked="" type="checkbox"/> No
3. The application area is located at a site that includes miscellaneous chemical manufacturing process units (MCPU) that process, use or generate one or more of the organic hazardous air pollutants listed in § 112(b) of the Clean Air Act or hydrogen halide and halogen HAP. <i>If the response to Question VIII.AA.1, AA.2 or AA.3 is "No," go to Section VIII.BB.</i>	<input type="checkbox"/> Yes <input checked="" type="checkbox"/> No
4. The application area includes process vents, storage vessels, transfer racks, or waste streams associated with a miscellaneous chemical manufacturing process subject to 40 CFR 63, Subpart FFFF. <i>If the response to Question VIII.AA.4 is "No," go to Section VIII.BB.</i>	<input type="checkbox"/> Yes <input type="checkbox"/> No

Application Area-Wide Applicability Determinations and General Information
Form OP-REQ1 (Page 69)
Federal Operating Permit Program
Texas Commission on Environmental Quality

Date	Permit No.	Regulated Entity No.
04/16/2026	O5	RN100217439

For SOP applications, answer ALL questions unless otherwise directed.

◆ For GOP applications, answer ONLY these questions unless otherwise directed.

VIII. Title 40 Code of Federal Regulations Part 63 - National Emission Standards for Hazardous Air Pollutants for Source Categories (continued)	
AA. Subpart FFFF - National Emission Standards for Hazardous Air Pollutants for Miscellaneous Organic Chemical Production and Processes (MON) (continued)	
5. The application area includes process wastewater streams. <i>If the response to Question VIII.AA.5 is "No," go to Question VIII.AA.24.</i>	<input type="checkbox"/> Yes <input type="checkbox"/> No
6. The application area includes process wastewater streams, located at existing sources, that are designated as Group 1 or are determined to be Group 1 for compounds listed in Table 8 of 40 CFR Part 63, Subpart G or Table 8 and Table 9 of 40 CFR Part 63, Subpart FFFF, as appropriate.	<input type="checkbox"/> Yes <input type="checkbox"/> No
7. The application area includes process wastewater streams, located at existing sources, that are Group 2 for compounds listed in Table 8 or Table 8 and Table 9 of 40 CFR Part 63, Subpart FFFF, as appropriate.	<input type="checkbox"/> Yes <input type="checkbox"/> No
8. The application area includes process wastewater streams, located at new sources, that are designated as Group 1 or are determined to be Group 1 for compounds listed in Table 8 of 40 CFR Part 63, Subpart G or Table 8 and Table 9 of 40 CFR Part 63, Subpart FFFF, as appropriate.	<input type="checkbox"/> Yes <input type="checkbox"/> No
9. The application area includes process wastewater streams, located at new sources, that are Group 2 for compounds listed in Table 8 or Table 8 and Table 9 of 40 CFR Part 63, Subpart FFFF, as appropriate.	<input type="checkbox"/> Yes <input type="checkbox"/> No
10. All Group 1 wastewater streams at the site are demonstrated to have a total source mass flow rate of less than 1 MG/yr. <i>If the response to Question VIII.AA.10 is "Yes," go to Question VIII.AA.24.</i>	<input type="checkbox"/> Yes <input type="checkbox"/> No
11. The site has untreated and/or partially treated Group 1 wastewater streams demonstrated to have a total source mass flow rate of less than 1 MG/yr. <i>If the response to Question VIII.AA.11 is "No," go to Question VIII.AA.13.</i>	<input type="checkbox"/> Yes <input type="checkbox"/> No
12. The application area includes waste management units that receive or manage a partially treated Group 1 wastewater stream prior to or during treatment.	<input type="checkbox"/> Yes <input type="checkbox"/> No
13. Group 1 wastewater streams or residual removed from Group 1 wastewater streams are transferred to an on-site treatment operation that is not owned or operated by the owner or operator of the source generating the waste stream or residual.	<input type="checkbox"/> Yes <input type="checkbox"/> No

Application Area-Wide Applicability Determinations and General Information
Form OP-REQ1 (Page 70)
Federal Operating Permit Program
Texas Commission on Environmental Quality

Date	Permit No.	Regulated Entity No.
04/16/2026	O5	RN100217439

For SOP applications, answer ALL questions unless otherwise directed.

◆ For GOP applications, answer ONLY these questions unless otherwise directed.

VIII. Title 40 Code of Federal Regulations Part 63 - National Emission Standards for Hazardous Air Pollutants for Source Categories (continued)		
AA. Subpart FFFF - National Emission Standards for Hazardous Air Pollutants for Miscellaneous Organic Chemical Production and Processes (MON) (continued)		
14.	Group 1 wastewater streams or residual removed from Group 1 wastewater streams are transferred to an off-site treatment operation. <i>If the responses to Questions VIII.AA.13 and VIII.AA.14 are both "No," go to Question VIII.AA.20.</i>	<input type="checkbox"/> Yes <input type="checkbox"/> No
15.	Group 1 wastewater streams are transferred to an offsite treatment facility meeting the requirements of 40 CFR § 63.138(h). <i>If the response to Question VIII.AA.15 is "No," go to Question VIII.AA.17.</i>	<input type="checkbox"/> Yes <input type="checkbox"/> No
16.	The option to document in the notification of compliance status report that the wastewater will be treated in a facility meeting the requirements of 40 CFR § 63.138(h) is elected.	<input type="checkbox"/> Yes <input type="checkbox"/> No
17.	Group 1 wastewater streams or residuals with a total annual average concentration of compounds in Table 8 of 40 CFR Part 63, Subpart FFFF less than 50 ppmw are transferred offsite. <i>If the response to Question VIII.AA.17 is "No," go to Question VIII.AA.19.</i>	<input type="checkbox"/> Yes <input type="checkbox"/> No
18.	The transferor is demonstrating that less than 5 percent of the HAP in Table 9 of 40 CFR Part 63, Subpart FFFF is emitted from waste management units up to the activated sludge unit.	<input type="checkbox"/> Yes <input type="checkbox"/> No
19.	The application area includes waste management units that receive or manage a Group 1 wastewater stream, or a residual removed from a Group 1 wastewater stream prior to shipment or transport.	<input type="checkbox"/> Yes <input type="checkbox"/> No
20.	The application area includes containers that receive, manage, or treat a Group 1 wastewater stream or a residual removed from a Group 1 wastewater stream.	<input type="checkbox"/> Yes <input type="checkbox"/> No
21.	The application area includes individual drain systems that receive or manage a Group 1 wastewater stream, or a residual removed from a Group 1 wastewater stream. <i>If the response to Question VIII.AA.21 is "No," go to Question VIII.AA.24.</i>	<input type="checkbox"/> Yes <input type="checkbox"/> No
22.	The application area includes individual drain systems that are complying with 40 CFR § 63.136 through the use of cover and, if vented, closed vent systems and control devices.	<input type="checkbox"/> Yes <input type="checkbox"/> No

Application Area-Wide Applicability Determinations and General Information
Form OP-REQ1 (Page 71)
Federal Operating Permit Program
Texas Commission on Environmental Quality

Date	Permit No.	Regulated Entity No.
04/16/2026	O5	RN100217439

For SOP applications, answer ALL questions unless otherwise directed.

◆ For GOP applications, answer ONLY these questions unless otherwise directed.

VIII. Title 40 Code of Federal Regulations Part 63 - National Emission Standards for Hazardous Air Pollutants for Source Categories (continued)	
AA. Subpart FFFF - National Emission Standards for Hazardous Air Pollutants for Miscellaneous Organic Chemical Production and Processes (MON) (continued)	
23. The application area includes individual drain systems that are complying with 40 CFR § 63.136 through the use of water seals or tightly fitting caps or plugs.	<input type="checkbox"/> Yes <input type="checkbox"/> No
24. The application area includes drains, drain hubs, manholes, lift stations, trenches, or pipes that are part of a chemical manufacturing process unit that meets the criteria of 40 CFR § 63.100(b). <i>If the response to Question VIII.AA.24 is "No," go to Section VIII.BB.</i>	<input type="checkbox"/> Yes <input type="checkbox"/> No
25. The application area includes drains, drain hubs, manholes, lift stations, trenches or pipes (that are part of a miscellaneous chemical manufacturing process unit) that meet the criteria listed in 40 CFR § 63.149(d). <i>If the response to Question VIII.AA.25 is "No," go to Section VIII.BB.</i>	<input type="checkbox"/> Yes <input type="checkbox"/> No
26. The application area includes drains, drain hubs, manholes, lift stations, trenches or pipes that convey water with a total annual average concentration of compounds in table 8 of 40 CFR Part 63, Subpart FFFF is greater than or equal to 10,000 ppmw at any flow rate, and the total annual load of compounds in table 8 of 40 CFR Part 63, Subpart FFFF is greater than or equal to 200 lb/yr.	<input type="checkbox"/> Yes <input type="checkbox"/> No
27. The application area includes drains, drain hubs, manholes, lift stations, trenches, or pipes that convey water with a total annual average concentration of compounds in table 8 of 40 CFR Part 63, Subpart FFFF is greater than or equal to 1,000 ppmw, and the annual average flow rate is greater than or equal to 1 liter per minute.	<input type="checkbox"/> Yes <input type="checkbox"/> No
28. The application area includes drains, drain hubs, manholes, lift stations, trenches or pipes that are part of a chemical manufacturing process unit that is subject to the new source requirements of 40 CFR § 63.2445(a); and the equipment conveys water with a combined total annual average concentration of compounds in tables 8 and 9 of 40 CFR Part 63, Subpart FFFF is greater than or equal to 30,000 ppmw, and the combined total annual load of compounds in tables 8 and 9 to this subpart is greater than or equal to 1 tpy.	<input type="checkbox"/> Yes <input type="checkbox"/> No

Application Area-Wide Applicability Determinations and General Information
Form OP-REQ1 (Page 72)
Federal Operating Permit Program
Texas Commission on Environmental Quality

Date	Permit No.	Regulated Entity No.
04/16/2026	O5	RN100217439

For SOP applications, answer ALL questions unless otherwise directed.

◆ For GOP applications, answer ONLY these questions unless otherwise directed.

VIII. Title 40 Code of Federal Regulations Part 63 - National Emission Standards for Hazardous Air Pollutants for Source Categories (continued)	
BB. Subpart GGGG - National Emission Standards for Hazardous Air Pollutants for: Solvent Extractions for Vegetable Oil Production.	
1. The application area includes a vegetable oil production process that: is by itself a major source of HAP emissions or, is collocated within a plant site with other sources that are individually or collectively a major source of HAP emissions.	<input type="checkbox"/> Yes <input checked="" type="checkbox"/> No
CC. Subpart GGGGG - National Emission Standards for Hazardous Air Pollutants: Site Remediation	
1. The application area includes a facility at which a site remediation is conducted. <i>If the answer to Question VIII.CC.1 is "No," go to Section VIII.DD.</i>	<input type="checkbox"/> Yes <input checked="" type="checkbox"/> No
2. The application area is located at a site that is a major source of HAP. <i>If the answer to Question VIII.CC.2 is "No," go to Section VIII.DD.</i>	<input type="checkbox"/> Yes <input type="checkbox"/> No
3. All site remediations qualify for one of the exemptions contained in 40 CFR § 63.7881(b)(1) through (6). <i>If the answer to Question VIII.CC.3 is "Yes," go to Section VIII.DD.</i>	<input type="checkbox"/> Yes <input type="checkbox"/> No
4. All site remediation activities are complete, and the Administrator has been notified in writing. <i>If the answer to Question VIII.CC.4 is "Yes," go to Section VIII.DD.</i>	<input type="checkbox"/> Yes <input type="checkbox"/> No
5. Prior to beginning site remediation activities, it was determined that the total quantity of HAP listed in Table 1 of Subpart GGGGG that will be removed during all site remediations will be less than 1 Mg/yr. <i>If the answer to Question VIII.CC.5 is "Yes," go to Section VIII.DD.</i>	<input type="checkbox"/> Yes <input type="checkbox"/> No
6. The site remediation will be completed within 30 consecutive calendar days.	<input type="checkbox"/> Yes <input type="checkbox"/> No
7. No site remediation will exceed 30 consecutive calendar days. <i>If the answer to Question VIII.CC.7 is "Yes," go to Section VIII.DD.</i>	<input type="checkbox"/> Yes <input type="checkbox"/> No
8. Site remediation materials subject to 40 CFR Part 63, Subpart GGGGG are transferred from the application area to an off-site facility.	<input type="checkbox"/> Yes <input type="checkbox"/> No
9. All site remediation materials subject to 40 CFR Part 63, Subpart GGGGG are transferred from the application area to an off-site facility. <i>If the answer to Question VIII.CC.9 is "Yes," go to Section VIII.DD.</i>	<input type="checkbox"/> Yes <input type="checkbox"/> No

Application Area-Wide Applicability Determinations and General Information
Form OP-REQ1 (Page 73)
Federal Operating Permit Program
Texas Commission on Environmental Quality

Date	Permit No.	Regulated Entity No.
04/16/2026	O5	RN100217439

For SOP applications, answer ALL questions unless otherwise directed.

◆ For GOP applications, answer ONLY these questions unless otherwise directed.

VIII. Title 40 Code of Federal Regulations Part 63 - National Emission Standards for Hazardous Air Pollutants for Source Categories (continued)		
CC. Subpart GGGGG - National Emission Standards for Hazardous Air Pollutants: Site Remediation (continued)		
10.	The application area includes a remediation material management unit used for cleanup of radioactive mixed waste per § 63.7886(c).	<input type="checkbox"/> Yes <input type="checkbox"/> No
11.	The application area includes a remediation material management unit or combination of units with a total annual quantity of HAP less than 1 Mg/yr that is being exempted from § 63.7886(b) per § 63.7886(d).	<input type="checkbox"/> Yes <input type="checkbox"/> No
12.	The application area includes a remediation material management unit that has an average total VOHAP concentration of remediation material less than 500 ppmw and is complying with § 63.7886(b)(2). <i>If the response to Question VIII.CC.12 is "No," go to Question VIII.CC.14.</i>	<input type="checkbox"/> Yes <input type="checkbox"/> No
13.	The application area includes a remediation material management unit that concentrates all or part of the material such that the material's VOHAP concentration could increase.	<input type="checkbox"/> Yes <input type="checkbox"/> No
14.	The application area includes containers that manage site remediation materials subject to 40 CFR Part 63, Subpart GGGGG. <i>If the response to Question VIII.CC.14 is "No," go to Question VIII.CC.21.</i>	<input type="checkbox"/> Yes <input type="checkbox"/> No
15.	The application area includes containers that are also subject to and complying with another subpart under 40 CFR part 61 or part 63 per § 63.7886(b)(3).	<input type="checkbox"/> Yes <input type="checkbox"/> No
16.	The application area includes containers that are complying with alternative work practice standards that have been approved by the EPA per § 63.7900(e).	<input type="checkbox"/> Yes <input type="checkbox"/> No
17.	The application area includes containers using Container Level 1 controls as specified in 40 CFR § 63.922(b).	<input type="checkbox"/> Yes <input type="checkbox"/> No
18.	The application area includes containers with a capacity greater than 0.46 m ³ that meet the requirements of 40 CFR § 63.7900(b)(3)(i) and (ii).	<input type="checkbox"/> Yes <input type="checkbox"/> No
19.	The application area includes containers using Container Level 2 controls as specified in 40 CFR § 63.923(b).	<input type="checkbox"/> Yes <input type="checkbox"/> No
20.	The application area includes containers using Container Level 3 controls as specified in 40 CFR § 63.924(b).	<input type="checkbox"/> Yes <input type="checkbox"/> No
21.	The application area includes individual drain systems complying with the requirements of 40 CFR § 63.962.	<input type="checkbox"/> Yes <input type="checkbox"/> No

Application Area-Wide Applicability Determinations and General Information
Form OP-REQ1 (Page 74)
Federal Operating Permit Program
Texas Commission on Environmental Quality

Date	Permit No.	Regulated Entity No.
04/16/2026	O5	RN100217439

- For SOP applications, answer ALL questions unless otherwise directed.
- ◆ For GOP applications, answer ONLY these questions unless otherwise directed.

VIII. Title 40 Code of Federal Regulations Part 63 - National Emission Standards for Hazardous Air Pollutants for Source Categories (continued)		
DD. Subpart YYYYYY - National Emission Standards for Hazardous Air Pollutants for Area/Sources: Electric Arc Furnace Steelmaking Facilities		
1. The application area includes an electric arc furnace (EAF) steelmaking facility, and the site is an area source of hazardous air pollutant (HAP) emissions. <i>If the response to Question VIII.DD.1 is "No," go to Section VIII.EE.</i>	<input type="checkbox"/> Yes <input checked="" type="checkbox"/> No	
2. The EAF steelmaking facility is a research and development facility. <i>If the response to Question VIII.DD.2 is "Yes," go to Section VIII.EE.</i>	<input type="checkbox"/> Yes <input type="checkbox"/> No	
3. Metallic scrap is utilized in the EAF.	<input type="checkbox"/> Yes <input type="checkbox"/> No	
4. Scrap containing motor vehicle scrap is utilized in the EAF.	<input type="checkbox"/> Yes <input type="checkbox"/> No	
5. Scrap not containing motor vehicle scrap is utilized in the EAF.	<input type="checkbox"/> Yes <input type="checkbox"/> No	
EE. Subpart BBBBBB - National Emission Standards for Hazardous Air Pollutants for Source Category: Gasoline Distribution Bulk Terminals, Bulk Plants and Pipeline Facilities		
1. The application area is located at a site that is an area source of HAPs. <i>If the answer to Question EE.1 is "No," go to Section VIII.FF.</i>	<input checked="" type="checkbox"/> Yes <input type="checkbox"/> No	
2. The application area includes a pipeline breakout station, as defined in 40 CFR Part 63, Subpart BBBBBB, not subject to the control requirements of 40 CFR Part 63, Subpart R.	<input type="checkbox"/> Yes <input checked="" type="checkbox"/> No	
3. The application area includes a pipeline pumping station as defined in 40 CFR Part 63, Subpart BBBBBB.	<input type="checkbox"/> Yes <input checked="" type="checkbox"/> No	

Application Area-Wide Applicability Determinations and General Information
Form OP-REQ1 (Page 75)
Federal Operating Permit Program
Texas Commission on Environmental Quality

Date	Permit No.	Regulated Entity No.
04/16/2026	O5	RN100217439

For SOP applications, answer ALL questions unless otherwise directed.

◆ For GOP applications, answer ONLY these questions unless otherwise directed.

VIII. Title 40 Code of Federal Regulations Part 63 - National Emission Standards for Hazardous Air Pollutants for Source Categories (continued)		
EE. Subpart BBBBBB - National Emission Standards for Hazardous Air Pollutants for Source Category: Gasoline Distribution Bulk Terminals, Bulk Plants and Pipeline Facilities (continued)		
4.	The application area includes a bulk gasoline plant as defined in 40 CFR Part 63, Subpart BBBBBB. <i>If the answer to Question VIII.EE.4 is "No," go to Question VIII.EE.6.</i>	<input type="checkbox"/> Yes <input checked="" type="checkbox"/> No
5.	The bulk gasoline plant was operating, prior to January 10, 2010, in compliance with an enforceable State, local or tribal rule or permit that requires submerged fill as specified in 40 CFR § 63.11086(a).	<input type="checkbox"/> Yes <input type="checkbox"/> No
6.	The application area includes a bulk gasoline terminal, as defined in 40 CFR Part 63, Subpart BBBBBB, not subject to the control requirements of 40 CFR Part 63, Subpart R or Subpart CC. <i>If the answer to Question VIII.EE.6 is "No," go to Section VIII.FF.</i>	<input type="checkbox"/> Yes <input checked="" type="checkbox"/> No
7.	The bulk gasoline terminal has throughput of less than 250,000 gallons per day. <i>If the answer to Question VIII.EE.7 is "Yes," go to Section VIII.FF.</i>	<input type="checkbox"/> Yes <input type="checkbox"/> No
8.	The bulk gasoline terminal loads gasoline into gasoline cargo tanks other than railcar cargo tanks.	<input type="checkbox"/> Yes <input type="checkbox"/> No
9.	The bulk gasoline terminal loads gasoline into railcar cargo tanks. <i>If the answer to Question VIII.EE.9 is "No," go to Section VIII.FF.</i>	<input type="checkbox"/> Yes <input type="checkbox"/> No
10.	The bulk gasoline terminal loads gasoline into railcar cargo tanks which do not collect vapors from a vapor balance system.	<input type="checkbox"/> Yes <input type="checkbox"/> No

Application Area-Wide Applicability Determinations and General Information
Form OP-REQ1 (Page 76)
Federal Operating Permit Program
Texas Commission on Environmental Quality

Date	Permit No.	Regulated Entity No.
04/16/2026	O5	RN100217439

For SOP applications, answer ALL questions unless otherwise directed.

◆ For GOP applications, answer ONLY these questions unless otherwise directed.

VIII. Title 40 Code of Federal Regulations Part 63 - National Emission Standards for Hazardous Air Pollutants for Source Categories (continued)		
EE. Subpart BBBB - National Emission Standards for Hazardous Air Pollutants for Source Category: Gasoline Distribution Bulk Terminals, Bulk Plants and Pipeline Facilities (continued)		
11. The bulk gasoline terminal loads gasoline into railcar cargo tanks which collect vapors from a vapor balance system and that system complies with a Federal, State, local, tribal rule or permit.	<input type="checkbox"/> Yes <input type="checkbox"/> No	
FF. Subpart CCCCC - National Emission Standards for Hazardous Air Pollutants for Source Category: Gasoline Dispensing Facilities		
◆ 1. The application area is located at a site that is an area source of hazardous air pollutants. <i>If the answer to Question VIII.FF.1 is "No," go to Section VIII.GG.</i>	<input checked="" type="checkbox"/> Yes <input type="checkbox"/> No	
◆ 2. The application area includes at least one gasoline dispensing facility as defined in 40 CFR § 63.11132. <i>If the answer to Question VIII.FF.2 is "No," go to Section VIII.GG.</i>	<input type="checkbox"/> Yes <input checked="" type="checkbox"/> No	
◆ 3. The application area includes at least one gasoline dispensing facility with a monthly throughput of less than 10,000 gallons.	<input type="checkbox"/> Yes <input type="checkbox"/> No	
◆ 4. The application area includes at least one gasoline dispensing facility where gasoline is dispensed from a fixed gasoline storage tank into a portable gasoline tank for the on-site delivery and subsequent dispensing into other gasoline-fueled equipment.	<input type="checkbox"/> Yes <input type="checkbox"/> No	
GG. Recently Promulgated 40 CFR Part 63 Subparts		
◆ 1. The application area is subject to one or more promulgated 40 CFR Part 63 subparts not addressed on this form. <i>If the response to Question VIII.GG.1 is "No," go to Section IX. A list of promulgated 40 CFR Part 63 subparts not otherwise addressed on OP-REQ1 is included in the instructions.</i>	<input checked="" type="checkbox"/> Yes <input type="checkbox"/> No	
◆ 2. Provide the Subpart designation (i.e. Subpart EEE) in the space provided below.		
Subpart ZZZZ		

Application Area-Wide Applicability Determinations and General Information
Form OP-REQ1 (Page 77)
Federal Operating Permit Program
Texas Commission on Environmental Quality

Date	Permit No.	Regulated Entity No.
04/16/2026	O5	RN100217439

- ◆ For SOP applications, answer ALL questions unless otherwise directed.
- ◆ For GOP applications, answer ONLY these questions unless otherwise directed.

IX. Title 40 Code of Federal Regulations Part 68 (40 CFR Part 68) - Chemical Accident Prevention Provisions	
A. Applicability	
◆ 1. The application area contains processes subject to 40 CFR Part 68, Chemical Accident Prevention Provisions, and specified in 40 CFR § 68.10.	<input type="checkbox"/> Yes <input checked="" type="checkbox"/> No
X. Title 40 Code of Federal Regulations Part 82 (40 CFR Part 82) - Protection of Stratospheric Ozone	
A. Subpart A - Production and Consumption Controls	
◆ 1. The application area is located at a site that produces, transforms, destroys, imports, or exports a controlled substance or product.	<input type="checkbox"/> Yes <input checked="" type="checkbox"/> No <input type="checkbox"/> N/A
B. Subpart B - Servicing of Motor Vehicle Air Conditioners	
◆ 1. Servicing, maintenance, and/or repair of fleet vehicle air conditioning systems using ozone-depleting refrigerants is conducted in the application area.	<input type="checkbox"/> Yes <input checked="" type="checkbox"/> NO
C. Subpart C - Ban on Nonessential Products Containing Class I Substances and Ban on Nonessential Products Containing or Manufactured with Class II Substances	
◆ 1. The application area sells or distributes one or more nonessential products (which release a Class I or Class II substance) that are subject to 40 CFR Part 82, Subpart C.	<input type="checkbox"/> Yes <input checked="" type="checkbox"/> No <input type="checkbox"/> N/A
D. Subpart D - Federal Procurement	
◆ 1. The application area is owned/operated by a department, agency, or instrumentality of the United States.	<input type="checkbox"/> Yes <input checked="" type="checkbox"/> No <input type="checkbox"/> N/A
E. Subpart E - The Labeling of Products Using Ozone Depleting Substances	
◆ 1. The application area includes containers in which a Class I or Class II substance is stored or transported prior to the sale of the Class I or Class II substance to the ultimate consumer.	<input type="checkbox"/> Yes <input checked="" type="checkbox"/> No <input type="checkbox"/> N/A
◆ 2. The application area is a manufacturer, importer, wholesaler, distributor, or retailer of products containing a Class I or Class II substance.	<input type="checkbox"/> Yes <input checked="" type="checkbox"/> No <input type="checkbox"/> N/A
◆ 3. The application area is a manufacturer, importer, wholesaler, distributor, or retailer of products manufactured with a process that uses a Class I or Class II substance.	<input type="checkbox"/> Yes <input checked="" type="checkbox"/> No <input type="checkbox"/> N/A

Application Area-Wide Applicability Determinations and General Information
Form OP-REQ1 (Page 78)
Federal Operating Permit Program
Texas Commission on Environmental Quality

Date	Permit No.	Regulated Entity No.
04/16/2026	O5	RN100217439

For SOP applications, answer ALL questions unless otherwise directed.

◆ For GOP applications, answer ONLY these questions unless otherwise directed.

X. Title 40 Code of Federal Regulations Part 82 (40 CFR Part 82) - Protection of Stratospheric Ozone (continued)		
F. Subpart F - Recycling and Emissions Reduction		
◆	1. Servicing, maintenance, and/or repair on refrigeration and non-motor vehicle air condition appliances using ozone-depleting refrigerants or non-exempt substitutes is conducted in the application area.	<input checked="" type="checkbox"/> Yes <input type="checkbox"/> No
◆	2. Disposal of appliances (including motor vehicle air conditioners) or refrigerant or non-exempt substitute reclamation occurs in the application area.	<input type="checkbox"/> Yes <input checked="" type="checkbox"/> No <input type="checkbox"/> N/A
◆	3. The application area manufactures appliances or refrigerant recycling and recovery equipment.	<input type="checkbox"/> Yes <input checked="" type="checkbox"/> No <input type="checkbox"/> N/A
G. Subpart G - Significant New Alternatives Policy Program		
◆	1. The application area manufactures, formulates, or creates chemicals, product substitutes, or alternative manufacturing processes that are intended for use as a replacement for a Class I or Class II compound. <i>If the response to Question X.G.1 is "No" or "N/A," go to Section X.H.</i>	<input type="checkbox"/> Yes <input checked="" type="checkbox"/> No <input type="checkbox"/> N/A
◆	2. All substitutes produced by the application area meet one or more of the exemptions in 40 CFR § 82.176(b)(1) - (7).	<input type="checkbox"/> Yes <input type="checkbox"/> No <input type="checkbox"/> N/A
H. Subpart H -Halon Emissions Reduction		
◆	1. Testing, servicing, maintaining, repairing, or disposing of equipment containing halons is conducted in the application area.	<input type="checkbox"/> Yes <input checked="" type="checkbox"/> No <input type="checkbox"/> N/A
◆	2. Disposal of halons or manufacturing of halon blends is conducted in the application area.	<input type="checkbox"/> Yes <input checked="" type="checkbox"/> No <input type="checkbox"/> N/A
XI. Miscellaneous		
A. Requirements Reference Tables (RRT) and Flowcharts		
1.	The application area contains units that are potentially subject to a regulation for which the TCEQ has not developed an RRT and flowchart.	<input type="checkbox"/> Yes <input checked="" type="checkbox"/> No

Application Area-Wide Applicability Determinations and General Information
Form OP-REQ1 (Page 79)
Federal Operating Permit Program
Texas Commission on Environmental Quality

Date	Permit No.	Regulated Entity No.
04/16/2026	O5	RN100217439

For SOP applications, answer ALL questions unless otherwise directed.

◆ For GOP applications, answer ONLY these questions unless otherwise directed.

XI. Miscellaneous (continued)		
B. Forms		
◆	1. The application area contains units that are potentially subject to a regulation for which the TCEQ has not developed a unit attribute form. <i>If the response to Question XI.B.1 is "No" or "N/A," go to Section XI.C.</i>	<input type="checkbox"/> Yes <input checked="" type="checkbox"/> No <input type="checkbox"/> N/A
◆	2. Provide the Part and Subpart designation for the federal rule(s) or the Chapter, Subchapter, and Division designation for the State regulation(s) in the space provided below.	
C. Emission Limitation Certifications		
◆	1. The application area includes units for which federally enforceable emission limitations have been established by certification.	<input checked="" type="checkbox"/> Yes <input type="checkbox"/> No
D. Alternative Means of Control, Alternative Emission Limitation or Standard, or Equivalent Requirements		
	1. The application area is located at a site that is subject to a site-specific requirement of the state implementation plan (SIP).	<input type="checkbox"/> Yes <input checked="" type="checkbox"/> No
	2. The application area includes units located at the site that are subject to a site-specific requirement of the SIP.	<input type="checkbox"/> Yes <input checked="" type="checkbox"/> No
	3. The application area includes units which demonstrate compliance by using an alternative means of control, alternative emission limitation or standard or equivalent requirements approved by the EPA Administrator. <i>If the response to Question XI.D.3 is "Yes," please include a copy of the approval document with the application.</i>	<input type="checkbox"/> Yes <input checked="" type="checkbox"/> No
	4. The application area includes units which demonstrate compliance by using an alternative means of control, alternative emission limitation or standard or equivalent requirements approved by the TCEQ Executive Director. <i>If the response to Question XI.D.4 is "Yes," please include a copy of the approval document with the application.</i>	<input type="checkbox"/> Yes <input checked="" type="checkbox"/> No

Application Area-Wide Applicability Determinations and General Information
Form OP-REQ1 (Page 80)
Federal Operating Permit Program
Texas Commission on Environmental Quality

Date	Permit No.	Regulated Entity No.
04/16/2026	O5	RN100217439

For SOP applications, answer ALL questions unless otherwise directed.

◆ For GOP applications, answer ONLY these questions unless otherwise directed.

XI. Miscellaneous (continued)		
E. Title IV - Acid Rain Program		
1. The application area includes emission units subject to the Acid Rain Program (ARP), including the Opt-In Program.		<input checked="" type="checkbox"/> Yes <input type="checkbox"/> No
2. The application area includes emission units qualifying for the new unit exemption under 40 CFR § 72.7.		<input type="checkbox"/> Yes <input checked="" type="checkbox"/> No
3. The application area includes emission units qualifying for the retired unit exemption under 40 CFR § 72.8.		<input checked="" type="checkbox"/> Yes <input type="checkbox"/> No
F. 40 CFR Part 97, Subpart EEEEE - Cross-State Air Pollution Rule (CSAPR) NO_x Ozone Season Group 2 Trading Program		
1. The application area includes emission units subject to the requirements of the CSAPR NO _x Ozone Season Group 2 Trading Program. <i>If the response to Question XI.F.1 is "No," go to Question XI.F.7.</i>		<input checked="" type="checkbox"/> Yes <input type="checkbox"/> No
2. The application area includes units that are complying with the CEMS requirements of 40 CFR Part 75, Subpart H for NO _x and heat input.		<input checked="" type="checkbox"/> Yes <input type="checkbox"/> No
3. The application area includes gas or oil-fired units that are complying with the CEMS requirements of 40 CFR Part 75, Subpart H for NO _x , and the monitoring requirements of 40 CFR Part 75, Appendix D for heat input.		<input checked="" type="checkbox"/> Yes <input type="checkbox"/> No
4. The application area includes gas or oil-fired peaking units that are complying with the monitoring requirements of 40 CFR Part 75, Appendix E for NO _x , and the monitoring requirements of 40 CFR Part 75, Appendix D for heat input.		<input type="checkbox"/> Yes <input checked="" type="checkbox"/> No
5. The application area includes gas or oil-fired units that are complying with the Low Mass Emissions monitoring requirements of 40 CFR § 75.19 for NO _x and heat input.		<input checked="" type="checkbox"/> Yes <input type="checkbox"/> No
6. The application area includes units that are complying with EPA-approved alternative monitoring system requirements of 40 CFR Part 75, Subpart E for NO _x and heat input.		<input checked="" type="checkbox"/> Yes <input type="checkbox"/> No
7. The application area includes emission units that qualify for the CSAPR NO _x Ozone Season Group 2 retired unit exemption.		<input type="checkbox"/> Yes <input checked="" type="checkbox"/> No

Application Area-Wide Applicability Determinations and General Information
Form OP-REQ1 (Page 81)
Federal Operating Permit Program
Texas Commission on Environmental Quality

Date	Permit No.	Regulated Entity No.
04/16/2026	O5	RN100217439

For SOP applications, answer ALL questions unless otherwise directed.

◆ For GOP applications, answer ONLY these questions unless otherwise directed.

XI. Miscellaneous (continued)	
G. 40 CFR Part 97, Subpart FFFFF - Texas SO₂ Trading Program	
1. The application area includes emission units complying with the requirements of the Texas SO ₂ Trading Program. <i>If the response to Question XI.G.1 is "No," go to Question XI.G.6.</i>	<input type="checkbox"/> Yes <input checked="" type="checkbox"/> No
2. The application area includes units that are complying with the CEMS requirements of 40 CFR Part 75, Subpart B for SO ₂ and 40 CFR Part 75, Subpart H for heat input.	<input type="checkbox"/> Yes <input type="checkbox"/> No
3. The application area includes gas or oil-fired units that are complying with the monitoring requirements of 40 CFR Part 75, Appendix D for SO ₂ and heat input.	<input type="checkbox"/> Yes <input type="checkbox"/> No
4. The application area includes gas or oil-fired units that are complying with the Low Mass Emissions monitoring requirements of 40 CFR § 75.19 for SO ₂ and heat input.	<input type="checkbox"/> Yes <input type="checkbox"/> No
5. The application area includes units that are complying with EPA-approved alternative monitoring system requirements of 40 CFR Part 75, Subpart E for SO ₂ and heat input.	<input type="checkbox"/> Yes <input type="checkbox"/> No
6. The application area includes emission units that qualify for the Texas SO ₂ Trading Program retired unit exemption.	<input type="checkbox"/> Yes <input checked="" type="checkbox"/> No
H. Permit Shield (SOP Applicants Only)	
1. A permit shield for negative applicability entries on Form OP-REQ2 (Negative Applicable Requirement Determinations) is being requested or already exists in the permit.	<input checked="" type="checkbox"/> Yes <input type="checkbox"/> No

Application Area-Wide Applicability Determinations and General Information
Form OP-REQ1 (Page 82)
Federal Operating Permit Program
Texas Commission on Environmental Quality

Date	Permit No.	Regulated Entity No.
04/16/2026	O5	RN100217439

For SOP applications, answer ALL questions unless otherwise directed.

◆ For GOP applications, answer ONLY these questions unless otherwise directed.

XI. Miscellaneous (continued)		
I. GOP Type (Complete this section for GOP applications only)		
◆	1. The application area is applying for initial issuance, revision, or renewal of an oil and gas general operating permit under GOP No. 511 - Oil and Gas General Operating Permit for Brazoria, Chambers, Collin, Dallas, Denton, El Paso, Ellis, Fort Bend, Galveston, Hardin, Harris, Jefferson, Johnson, Kaufman, Liberty, Montgomery, Orange, Parker, Rockwall, Tarrant, Waller, and Wise Counties.	<input type="checkbox"/> Yes <input type="checkbox"/> No
◆	2. The application area is applying for initial issuance, revision, or renewal of an oil and gas general operating permit under GOP No. 512 - Oil and Gas General Operating Permit for Gregg, Nueces, and Victoria Counties.	<input type="checkbox"/> Yes <input type="checkbox"/> No
◆	3. The application area is applying for initial issuance, revision, or renewal of an oil and gas general operating permit under GOP No. 513 - Oil and Gas General Operating Permit for Aransas, Bexar, Calhoun, Matagorda, San Patricio, and Travis Counties.	<input type="checkbox"/> Yes <input type="checkbox"/> No
◆	4. The application area is applying for initial issuance, revision, or renewal of an oil and gas general operating permit under GOP No. 514 - Oil and Gas General Operating Permit for All Texas Counties Except Aransas, Bexar, Brazoria, Calhoun, Chambers, Collin, Dallas, Denton, El Paso, Ellis, Fort Bend, Galveston, Gregg, Hardin, Harris, Jefferson, Johnson, Kaufman, Liberty, Matagorda, Montgomery, Nueces, Orange, Parker, Rockwall, San Patricio, Tarrant, Travis, Victoria, Waller, and Wise County.	<input type="checkbox"/> Yes <input type="checkbox"/> No
◆	5. The application area is applying for initial issuance, revision, or renewal of a solid waste landfill general operating permit under GOP No. 517 - Municipal Solid Waste Landfill general operating permit.	<input type="checkbox"/> Yes <input type="checkbox"/> No
J. Title 30 TAC Chapter 101, Subchapter H		
◆	1. The application area is located in a nonattainment area. <i>If the response to Question XI.J.1 is "No," go to Question XI.J.3.</i>	<input checked="" type="checkbox"/> Yes <input type="checkbox"/> No
◆	2. The applicant has or will generate emission reductions to be credited in the TCEQ Emissions Banking and Trading Program.	<input checked="" type="checkbox"/> Yes <input type="checkbox"/> No <input type="checkbox"/> N/A
◆	3. The applicant has or will generate discrete emission reductions to be credited in the TCEQ Emissions Banking and Trading Program.	<input checked="" type="checkbox"/> Yes <input type="checkbox"/> No <input type="checkbox"/> N/A

Application Area-Wide Applicability Determinations and General Information
Form OP-REQ1 (Page 83)
Federal Operating Permit Program
Texas Commission on Environmental Quality

Date	Permit No.	Regulated Entity No.
04/16/2026	O5	RN100217439

For SOP applications, answer ALL questions unless otherwise directed.

◆ For GOP applications, answer ONLY these questions unless otherwise directed.

XI. Miscellaneous (continued)		
J. Title 30 TAC Chapter 101, Subchapter H (continued)		
◆ 4.	The application area is located at a site in the Houston/Galveston/Brazoria nonattainment area where the facilities have a collective uncontrolled design capacity to emit 10 tpy or more of NO _x . <i>If the response to Question XI.J.4 is "Yes," go to Question XI.J.6.</i>	<input type="checkbox"/> Yes <input checked="" type="checkbox"/> No
◆ 5.	The application area is located at a site in the Houston/Galveston/Brazoria nonattainment area where the facilities previously had a collective uncontrolled design capacity to emit 10 tpy or more of NO _x and is subject to 101.351(c).	<input type="checkbox"/> Yes <input checked="" type="checkbox"/> No
6.	The application area includes an electric generating facility permitted under 30 TAC Chapter 116, Subchapter I.	<input checked="" type="checkbox"/> Yes <input type="checkbox"/> No
◆ 7.	The application area is located at a site in the Houston/Galveston/Brazoria nonattainment area and the site has a potential to emit more than 10 tpy of highly reactive volatile organic compounds (HRVOC) from facilities covered under 30 TAC Chapter 115, Subchapter H, Divisions 1 and 2.	<input type="checkbox"/> Yes <input checked="" type="checkbox"/> No
◆ 8.	The application area is located at a site in the Houston/Galveston/Brazoria nonattainment area, the site has a potential to emit 10 tpy or less of HRVOC from covered facilities and the applicant is opting to comply with the requirements of 30 TAC Chapter 101, Subchapter H, Division 6, Highly Reactive VOC Emissions Cap and Trade Program.	<input type="checkbox"/> Yes <input checked="" type="checkbox"/> No
K. Periodic Monitoring		
◆ 1.	The applicant or permit holder is submitting at least one periodic monitoring proposal described on Form OP-MON in this application. <i>If the response to Question XI.K.1 is "Yes," go to Section XI.L.</i>	<input type="checkbox"/> Yes <input checked="" type="checkbox"/> No
◆ 2.	The permit currently contains at least one periodic monitoring requirement. <i>If the responses to Questions XI.K.1 and XI.K.2 are both "No," go to Section XI.L.</i>	<input checked="" type="checkbox"/> Yes <input type="checkbox"/> No
◆ 3.	All periodic monitoring requirements are being removed from the permit with this application.	<input type="checkbox"/> Yes <input checked="" type="checkbox"/> No

Application Area-Wide Applicability Determinations and General Information
Form OP-REQ1 (Page 84)
Federal Operating Permit Program
Texas Commission on Environmental Quality

Date	Permit No.	Regulated Entity No.
04/16/2026	O5	RN100217439

For SOP applications, answer ALL questions unless otherwise directed.

◆ For GOP applications, answer ONLY these questions unless otherwise directed.

XI. Miscellaneous (continued)		
L. Compliance Assurance Monitoring		
◆	1. The application area includes at least one unit that does not meet the CAM exemptions in 40 CFR § 64.2(b) for all applicable requirements that it is subject to, and the unit has a pre-control device potential to emit greater than or equal to the amount in tons per year required in a site classified as a major source. <i>If the response to Question XI.L.1 is "No," go to Section XI.M.</i>	<input type="checkbox"/> Yes <input checked="" type="checkbox"/> No
◆	2. The unit or units defined by XI.L.1 are using a control device to comply with an applicable requirement. <i>If the response to Question XI.L.2 is "No," go to Section XI.M.</i>	<input type="checkbox"/> Yes <input type="checkbox"/> No
◆	3. The permit holder has submitted a CAM proposal on Form OP-MON in a previous application.	<input type="checkbox"/> Yes <input type="checkbox"/> No
◆	4. The owner/operator or permit holder is submitting a CAM proposal on Form OP-MON according to the deadlines for submittals in 40 CFR § 64.5 in this application. <i>If the responses to Questions XI.L.3 and XI.L.4 are both "No," go to Section XI.M.</i>	<input type="checkbox"/> Yes <input type="checkbox"/> No
5.	The owner/operator or permit holder is submitting a CAM implementation plan and schedule to be incorporated as enforceable conditions in the permit.	<input type="checkbox"/> Yes <input type="checkbox"/> No
6.	Provide the unit identification numbers for the units for which the applicant is submitting a CAM implementation plan and schedule in the space below.	
◆	7. At least one unit defined by XI.L.1 and XI.L.2 is using a CEMS, COMS or PEMS meeting the requirements of 40 CFR § 64.3(d)(2).	<input type="checkbox"/> Yes <input type="checkbox"/> No
◆	8. All units defined by XI.L.1 and XI.L.2 are using a CEMS, COMS or PEMS meeting the requirements of 40 CFR § 64.3(d)(2). <i>If the response to Question XI.L.8 is "Yes," go to Section XI.M.</i>	<input type="checkbox"/> Yes <input type="checkbox"/> No

Application Area-Wide Applicability Determinations and General Information
Form OP-REQ1 (Page 85)
Federal Operating Permit Program
Texas Commission on Environmental Quality

Date	Permit No.	Regulated Entity No.
04/16/2026	O5	RN100217439

For SOP applications, answer ALL questions unless otherwise directed.

◆ For GOP applications, answer ONLY these questions unless otherwise directed.

XI. Miscellaneous (continued)		
L. Compliance Assurance Monitoring (continued)		
◆	9. At least one of the CAM proposals as described by question XI.L.3 or XI.L.4 addresses particulate matter, and the emission unit has a capture system as defined in 40 CFR §64.1.	<input type="checkbox"/> Yes <input type="checkbox"/> No
◆	10. At least one of the CAM proposals as described by question XI.L.3 or XI.L.4 addresses VOC, and the emission unit has a capture system as defined in 40 CFR §64.1.	<input type="checkbox"/> Yes <input type="checkbox"/> No
◆	11. At least one of the CAM proposals as described by question XI.L.3 or XI.L.4 addresses a regulated pollutant other than particulate matter or VOC, and the emission unit has a capture system as defined in 40 CFR §64.1.	<input type="checkbox"/> Yes <input type="checkbox"/> No
◆	12. The control device in the CAM proposal as described by question XI.L.3 or XI.L.4 has a bypass.	<input type="checkbox"/> Yes <input type="checkbox"/> No
M. Title 30 TAC Chapter 113, Subchapter D, Division 5 - Emission Guidelines and Compliance Times		
◆	1. The application area includes at least one air curtain incinerator that commenced construction on or before December 9, 2004. <i>If the response to Question XI.M.1 is "No," or "N/A," go to Section XII.</i>	<input type="checkbox"/> Yes <input checked="" type="checkbox"/> No <input type="checkbox"/> N/A
◆	2. All air curtain incinerators constructed on or before December 9, 2004 combust only wood waste, clean lumber, or yard waste or a mixture of these materials.	<input type="checkbox"/> Yes <input type="checkbox"/> No
XII. New Source Review (NSR) Authorizations		
A. Waste Permits with Air Addendum		
◆	1. The application area includes a Municipal Solid Waste Permit or an Industrial Hazardous Waste with an Air Addendum. <i>If the response to XII.A.1 is "Yes," include the waste permit numbers and issuance date in Section XII.J.</i>	<input type="checkbox"/> Yes <input checked="" type="checkbox"/> No

Application Area-Wide Applicability Determinations and General Information
Form OP-REQ1 (Page 86)
Federal Operating Permit Program
Texas Commission on Environmental Quality

Date	Permit No.	Regulated Entity No.
04/16/2026	O5	RN100217439

For SOP applications, answer ALL questions unless otherwise directed.

◆ For GOP applications, answer ONLY these questions unless otherwise directed.

XII. New Source Review (NSR) Authorizations (continued)		
B. Air Quality Standard Permits		
◆	1. The application area includes at least one Air Quality Standard Permit NSR authorization. <i>If the response to XII.B.1 is "No," go to Section XII.C. If the response to XII.B.1 is "Yes," be sure to include the standard permit's registration numbers in Section XII.H and answer XII.B.2 - B.16 as appropriate.</i>	<input type="checkbox"/> Yes <input checked="" type="checkbox"/> No
◆	2. The application area includes at least one "State Pollution Control Project" Air Quality Standard Permit NSR authorization under 30 TAC § 116.617.	<input type="checkbox"/> Yes <input type="checkbox"/> No
◆	3. The application area includes at least one non-rule Air Quality Standard Permit for Pollution Control Projects NSR authorization.	<input type="checkbox"/> Yes <input type="checkbox"/> No
◆	4. The application area includes at least one "Installation and/or Modification of Oil and Gas Facilities" Air Quality Standard Permit NSR authorization under 30 TAC § 116.620.	<input type="checkbox"/> Yes <input type="checkbox"/> No
◆	5. The application area includes at least one non-rule Air Quality Standard Permit for Oil and Gas Handling and Production Facilities NSR authorization.	<input type="checkbox"/> Yes <input type="checkbox"/> No
◆	6. The application area includes at least one "Municipal Solid Waste Landfill" Air Quality Standard Permit NSR authorization under 30 TAC § 116.621.	<input type="checkbox"/> Yes <input type="checkbox"/> No
◆	7. The application area includes at least one "Municipal Solid Waste Landfill Facilities and Transfer Stations" Standard Permit authorization under 30 TAC Chapter 330, Subchapter U.	<input type="checkbox"/> Yes <input type="checkbox"/> No
8.	The application area includes at least one "Concrete Batch Plant" Air Quality Standard Permit NSR authorization.	<input type="checkbox"/> Yes <input type="checkbox"/> No
9.	The application area includes at least one "Concrete Batch Plant with Enhanced Controls" Air Quality Standard Permit NSR authorization.	<input type="checkbox"/> Yes <input type="checkbox"/> No
10.	The application area includes at least one "Hot Mix Asphalt Plant" Air Quality Standard Permit NSR authorization.	<input type="checkbox"/> Yes <input type="checkbox"/> No

Application Area-Wide Applicability Determinations and General Information
Form OP-REQ1 (Page 87)
Federal Operating Permit Program
Texas Commission on Environmental Quality

Date	Permit No.	Regulated Entity No.
04/16/2026	O5	RN100217439

For SOP applications, answer ALL questions unless otherwise directed.

◆ For GOP applications, answer ONLY these questions unless otherwise directed.

XII. New Source Review (NSR) Authorizations (continued)		
B. Air Quality Standard Permits (continued)		
◆	11. The application area includes at least one “Rock Crusher” Air Quality Standard Permit NSR authorization.	<input type="checkbox"/> Yes <input type="checkbox"/> No
◆	12. The application area includes at least one “Electric Generating Unit” Air Quality Standard Permit NSR authorization. <i>If the response to XII.B.12 is “No,” go to Question XII.B.15.</i>	<input type="checkbox"/> Yes <input type="checkbox"/> No
◆	13. For purposes of “Electric Generating Unit” Air Quality Standard Permit, the application area is located in the East Texas Region.	<input type="checkbox"/> Yes <input type="checkbox"/> No
◆	14. For purposes of “Electric Generating Unit” Air Quality Standard Permit, the application area is located in the West Texas Region.	<input type="checkbox"/> Yes <input type="checkbox"/> No
◆	15. The application area includes at least one “Boiler” Air Quality Standard Permit NSR authorization.	<input type="checkbox"/> Yes <input type="checkbox"/> No
◆	16. The application area includes at least one “Sawmill” Air Quality Standard Permit NSR authorization.	<input type="checkbox"/> Yes <input type="checkbox"/> No
C. Flexible Permits		
	1. The application area includes at least one Flexible Permit NSR authorization.	<input type="checkbox"/> Yes <input checked="" type="checkbox"/> No
D. Multiple Plant Permits		
	1. The application area includes at least one Multi-Plant Permit NSR authorization.	<input type="checkbox"/> Yes <input checked="" type="checkbox"/> No

**Application Area-Wide Applicability Determinations and General Information
Form OP-REQ1 (Page 88)
Federal Operating Permit Program
Texas Commission on Environmental Quality**

Date	Permit No.	Regulated Entity No.
04/16/2026	O5	RN100217439

For SOP applications, answer ALL questions unless otherwise directed.

◆ For GOP applications, answer ONLY these questions unless otherwise directed.

XII. NSR Authorizations (Attach additional sheets if necessary for sections XII.E-J)

E. PSD Permits and PSD Major Pollutants

Permit No.	Issuance Date	Pollutant(s):	Permit No.	Issuance Date	Pollutant(s):
PSD1X1027	09/22/2023	NOx, CO, PM			

If PSD Permits are held for the application area, please complete the Major NSR Summary Table located under the Technical Forms heading at: www.tceq.texas.gov/permitting/air/titlev/site/site_experts.html.

F. Nonattainment (NA) Permits and NA Major Pollutants

Permit No.	Issuance Date	Pollutant(s):	Permit No.	Issuance Date	Pollutant(s):

If NA Permits are held for the application area, please complete the Major NSR Summary Table located under the Technical Forms heading at: www.tceq.texas.gov/permitting/air/titlev/site/site_experts.html.

G. NSR Authorizations with FCAA § 112(g) Requirements

NSR Permit No.	Issuance Date	NSR Permit No.	Issuance Date	NSR Permit No	Issuance Date

Application Area-Wide Applicability Determinations and General Information
Form OP-REQ1 (Page 89)
Federal Operating Permit Program
Texas Commission on Environmental Quality

Date	Permit No.	Regulated Entity No.
04/16/2026	O5	RN100217439

For SOP applications, answer ALL questions unless otherwise directed.

◆ For GOP applications, answer ONLY these questions unless otherwise directed.

XII. NSR Authorizations (continued) - (Attach additional sheets if necessary for sections XII.E-J.)

◆ **H. Title 30 TAC Chapter 116 Permits, Special Permits, Standard Permits, Other Authorizations (Other Than Permits By Rule, PSD Permits, NA Permits) for the Application Area**

Authorization No.	Issuance Date	Authorization No.	Issuance Date	Authorization No.	Issuance Date
53284	09/22/2023				

◆ **I. Permits by Rule (30 TAC Chapter 106) for the Application Area**

A list of selected Permits by Rule (previously referred to as standard exemptions) that are required to be listed in the FOP application is available in the instructions.

PBR No.	Version No./Date	PBR No.	Version No./Date	PBR No.	Version No./Date
003	11/05/1986	106.244	09/04/2000	106.472	09/04/2000
003	09/13/1993	106.263	11/01/2001	106.473	09/04/2000
005	09/17/1973	106.265	09/04/2000	106.511	09/04/2000
005	06/07/1996	106.316	09/04/2000	106.532	09/04/2000
051	07/20/1992	106.317	09/04/2000		
106.102	09/04/2000	106.355	11/01/2001		
106.227	09/04/2000	106.371	09/04/2000		
106.242	09/04/2000	106.412	09/04/2000		

◆ **J. Municipal Solid Waste and Industrial Hazardous Waste Permits with an Air Addendum**

Permit No.	Issuance Date	Permit No.	Issuance Date	Permit No.	Issuance Date

Form OP-REQ2
Negative Applicable/Superseded Requirement Determinations
Texas Commission on Environmental Quality

Date	Permit No.	Regulated Entity No.
04/16/2026	05	RN100217439

Unit AI	Revision No.	Unit/Group/Process ID No.	Unit/Group/Process Applicable Form	Potentially Applicable Regulatory Name	Negative Applicability/Superseded Requirement Citation	Negative Applicability/Superseded Requirement Reason
A	3	TK-DSL3	OP-UA3	40 CFR Part 60, Subpart Kc	§60.110c(a)	The storage tank capacity is less than 20,000 gallons.

**Applicable Requirements Summary
Form OP-REQ3 (Page 1)
Federal Operating Permit Program**

Table 1a: Additions

Date: 04/16/2026	Regulated Entity No.: RN100217439	Permit No.: O5
Company Name: CPS Energy (City Public Service Board)	Area Name: Leon Creek Plant	

Revision No.	Unit/Group/Process ID No.	Unit/Group/Process Applicable Form	SOP/GOP Index No	Pollutant	Applicable Regulatory Requirement Name	Applicable Regulatory Requirement Standard(s)
1	TK-DSL3	OP-UA3	R5112-1	VOC	30 TAC Chapter 115, Storage of VOCs	§115.111(a)(1)
4	GRPCT	OP-UA1	R7B2-1	NOx	30 TAC Chapter 117, Subchapter C, Division 2	§117.1100(a)(3) §117.1100(b) §117.1105(a)(1) §117.1105(b)

**Applicable Requirements Summary
Form OP-REQ3 (Page 2)
Federal Operating Permit Program**

Table 1b: Additions

Date: 04/16/2026	Regulated Entity No.: RN100217439	Permit No.: O5
Company Name: CPS Energy (City Public Service Board)	Area Name: Leon Creek Plant	

Revision No.	Unit/Group/Process ID No.	SOP/GOP Index No.	Pollutant	Monitoring and Testing Requirements	Recordkeeping Requirements	Reporting Requirements
1	TK-DSL3	R5112-1	VOC	[G]§115.117	§115.118(a)(1) §115.118(a)(5) §115.118(a)(7)	None
4	GRPCT	R7B2-1	NOx	§117.1140	§117.1145(c) §117.1145(e)	§117.1145(a) §117.1145(b) §117.1145(d) §117.1152

ATTACHMENT 4 – UNIT ATTRIBUTE FORM

**Miscellaneous and Generic Unit Attributes
Form OP-UA1
Federal Operating Permit Program
Texas Commission on Environmental Quality**

General Information

Requested Information	Response
Date:	04-16-2026
Customer Reference No.:	CN600129019
Regulated Entity No.:	RN100217439
Permit No.:	O5
Permit Area Name:	Leon Creek Plant
Permit Type:	SOP
Project Type:	Renewal
Submission Type:	New Application
Project Number (if available):	
Form Information	TCEQ Entry Only
Title V Form Release Date:	10/1998
Form Number:	10044
APD ID Number:	35v1.0
Version Revised Date:	07/2025
	This form is for use by facilities subject to air quality permit requirements and may be revised periodically.

**Miscellaneous and Generic Unit Attributes
Form OP-UA1
Federal Operating Permit Program
Texas Commission on Environmental Quality**

Table 1

Unit ID No.	SOP/GOP Index No.	Unit Type	Date Constructed/Placed in Service	Functionally Identical Replacement	Maximum Rated Capacity	Technical Information and Unit Description
GRPCGT	R7C2-1	EP	FCD+			General Electric LM6000 simple cycle turbines

[Go to the Table of Contents](#)

**Storage Tank/Vessel Attributes
Form OP-UA3
Federal Operating Permit Program
Texas Commission on Environmental Quality**

General Information

Requested Information	Response
Date:	04-16-2026
Customer Reference No.:	CN600129019
Regulated Entity No.:	RN100217439
Permit No.:	O5
Permit Area Name:	Leon Creek Plant
Permit Type:	SOP
Project Type:	Renewal
Submission Type:	New Application
Project Number (if available):	
Form Information	TCEQ Entry Only
Title V Form Release Date:	10/2025
Form Number:	10008
APD ID Number:	37v2.0
Version Revised Date:	10/2025
	This form is for use by facilities subject to air quality permit requirements and may be revised periodically.

**Storage Tank/Vessel Attributes
Form OP-UA3
Federal Operating Permit Program
Texas Commission on Environmental Quality**

Table 3: Title 40 Code of Federal Regulations Part 60 (40 CFR Part 60)

Subpart Kb: Standards of Performance for Volatile Organic Liquid Storage Vessels (Including Petroleum Liquid Storage Vessels)

Unit ID No.	SOP/GOP Index No.	Product Stored	Storage Capacity	WW Tank Control	Maximum TVP	Storage Vessel Description	AMEL ID No.	Guidepole	Reid Vapor Pressure	Control Device ID No.
TK-DSL3	60Kb-1	VOL	10K-							

[Go to the Table of Contents](#)

**Storage Tank/Vessel Attributes
Form OP-UA3
Federal Operating Permit Program
Texas Commission on Environmental Quality**

**Table 4a: Title 30 Texas Administrative Code Chapter 115 (30 TAC Chapter 115)
Subchapter B: Storage of Volatile Organic Compounds (VOCs)**

Unit ID No.	SOP/GOP Index No.	Alternate Control Requirement	ACR ID No.	Product Stored	Storage Capacity	Throughput	Potential to Emit	Uncontrolled Emissions
TK-DSL3	R5112-1	NO		VOC1	A1K-25K			

[Go to the Table of Contents](#)

ATTACHMENT 5 – MAJOR NSR SUMMARY TABLE

**Texas Commission on Environmental Quality
Major NSR Summary Table**

Permits Numbers: 53284 and PSDTX1027					Issuance Date: 1/18/2013 (Revised: 08/2017)		
Emission Point No. (1)	Source Name (2)	Air Contaminant Name (3)	Emission Rates		Monitoring and Testing Requirements	Recordkeeping Requirements	Reporting Requirements
			lbs/hour	TPY (4)	Spec. Cond./Appl. Info.	Spec. Cond./Appl. Info.	Spec. Cond./Appl. Info.
CGT1	GE LM6000 Combustion Turbine	NO _x	8.40	34.60	1, 4, 6, 9, 10, 11, 13, 14, 20	1, 6, 9, 10, 11, 13, 14, 17, 18, 20, 21, 22	1, 9, 10, 11, 23
		NO _x (MSS) ⁽⁷⁾	151.30				
		CO	12.20	50.50			
		CO (MSS) ⁽⁷⁾	892.0				
		VOC	4.60	18.90			
		VOC (MSS) ⁽⁷⁾	14.90				
		PM ₁₀	11.30	49.50			
		SO ₂	1.30	5.50			
		NH ₃	4.30	17.90			
		(NH ₄) ₂ SO ₄	0.30	1.40			
		H ₂ SO ₄	0.20	1.0			
CGT2	GE LM6000 Combustion Turbine	NO _x	8.40	34.60	1, 4, 6, 9, 10, 11, 13, 14, 20	1, 6, 9, 10, 11, 13, 14, 17, 18, 20, 21, 22	1, 9, 10, 11, 23
		NO _x (MSS) ⁽⁷⁾	151.30				
		CO	12.20	50.50			
		CO (MSS) ⁽⁷⁾	892.0				
		VOC	4.60	18.90			
		VOC (MSS) ⁽⁷⁾	14.90				
		PM ₁₀	11.30	49.50			
		SO ₂	1.30	5.50			
		(NH ₄) ₂ SO ₄	0.30	1.40			

Major NSR Summary Table

Permits Numbers: 53284 and PSDTX1027					Issuance Date: 1/18/2013 (Revised: 08/2017)		
Emission Point No. (1)	Source Name (2)	Air Contaminant Name (3)	Emission Rates		Monitoring and Testing Requirements	Recordkeeping Requirements	Reporting Requirements
			lbs/hour	TPY (4)	Spec. Cond./Appl. Info.	Spec. Cond./Appl. Info.	Spec. Cond./Appl. Info.
		H ₂ SO ₄	0.20	1.0			
CGT3	GE LM6000 Combustion Turbine	NO _x	8.40	34.60	1, 4, 6, 9, 10, 11, 13, 14, 20	1, 6, 9, 10, 11, 13, 14, 17, 18, 20, 21, 22	1, 9, 10, 11, 23
		NO _x (MSS) ⁽⁷⁾	151.30				
		CO	12.20	50.50			
		CO (MSS) ⁽⁷⁾	892.0				
		VOC	4.60	18.90			
		VOC (MSS) ⁽⁷⁾	14.90				
		PM ₁₀	11.30	49.50			
		SO ₂	1.30	5.50			
		NH ₃	4.30	17.90			
		(NH ₄) ₂ SO ₄	0.30	1.40			
		H ₂ SO ₄	0.20	1.0			
CGT4	GE LM6000 Combustion Turbine	NO _x	8.40	34.60	1, 4, 6, 9, 10, 11, 13, 14, 20	1, 6, 9, 10, 11, 13, 14, 17, 18, 20, 21, 22	1, 9, 10, 11, 23
		NO _x (MSS) ⁽⁷⁾	151.30				
		CO	12.20	50.50			
		CO (MSS) ⁽⁷⁾	892.0				
		VOC	4.60	18.90			
		VOC (MSS) ⁽⁷⁾	14.90				
		PM ₁₀	11.30	49.50			
		SO ₂	1.30	5.50			
NH ₃	4.30	17.90					

Major NSR Summary Table

Permits Numbers: 53284 and PSDTX1027					Issuance Date: 1/18/2013 (Revised: 08/2017)		
Emission Point No. (1)	Source Name (2)	Air Contaminant Name (3)	Emission Rates		Monitoring and Testing Requirements	Recordkeeping Requirements	Reporting Requirements
			lbs/hour	TPY (4)	Spec. Cond./Appl. Info.	Spec. Cond./Appl. Info.	Spec. Cond./Appl. Info.
		(NH ₄) ₂ SO ₄	0.30	1.40			
		H ₂ SO ₄	0.20	1.0			
EMGEN1	Emergency Generator ⁽⁵⁾	NO _x	32.40	8.10	6	6, 22	
		CO	7.43	1.86			
		VOC	0.95	0.24			
		PM ₁₀	0.95	0.24			
		SO ₂	0.55	0.14			
FWPUMP	Fire Water Pump ⁽⁵⁾	NO _x	9.30	2.33	6	6, 22	
		CO	2.00	0.50			
		VOC	0.74	0.19			
		PM ₁₀	0.66	0.17			
		SO ₂	0.12	0.03			
FUG-CGT	Plant Fugitives ⁽⁶⁾	VOC	0.07	0.32			
		NH ₃	0.02	0.07			
TK-DSL1	Diesel Tank 1 ⁽⁶⁾	VOC	0.03	<0.01			
TK-DSL2	Diesel Tank 2 ⁽⁶⁾	VOC	0.01	<0.01			
CT1	Cooling Tower 1	PM	0.04	0.19	6	6, 22	
CT2	Cooling Tower 2	PM	0.04	0.19	6	6, 22	

Major NSR Summary Table

Permits Numbers: 53284 and PSDTX1027					Issuance Date: 1/18/2013 (Revised: 08/2017)		
Emission Point No. (1)	Source Name (2)	Air Contaminant Name (3)	Emission Rates		Monitoring and Testing Requirements	Recordkeeping Requirements	Reporting Requirements
			lbs/hour	TPY (4)	Spec. Cond./Appl. Info.	Spec. Cond./Appl. Info.	Spec. Cond./Appl. Info.
MSS_FUG	Miscellaneous Maintenance Activities	VOC	0.27	<0.01	6, 18, 20	6, 18, 22	
		PM	11.35	0.02			
		PM ₁₀	5.37	0.01			
		PM _{2.5}	0.81	<0.01			
		NO _x	<0.01	<0.01			
		CO	<0.01	<0.01			
		SO ₂	<0.01	<0.01			
		NH ₃	7.67	<0.01			

Footnotes:

- (1) Emission point identification – either specific equipment designation or emission point number from plot plan.
- (2) Specific point source name. For fugitive sources, use area name or fugitive source name.
- (3) VOC – volatile organic compounds as defined in Title 30 Texas Administrative Code § 101.1
 NO_x – total oxides of nitrogen
 SO_x – sulfur dioxide
 PM – total particulate matter, suspended in the atmosphere, including PM₁₀ and PM_{2.5}
 PM₁₀ – particulate matter equal to or less than 10 microns in diameter, including PM_{2.5}
 PM_{2.5} – particulate matter equal to or less than 2.5 microns in diameter
 CO – carbon monoxide
 NH₃ – ammonia
 (NH₄)₂SO₄ – ammonia sulfate
 H₂SO₄ – sulfuric acid
- (4) Compliance with annual emission limits (tons per year) is based on a 12-month rolling period.
- (5) Emissions are based on non-emergency operation of 500 operating hours per year.
- (6) Fugitive emissions are an estimate based on component count and applicable fugitive emission factors.
- (7) For each pollutant whose emissions during planned MSS activities are measured using a CEMS, during any clock hour that includes one or more minutes of planned MSS activities, the pollutant's hourly emission limits that apply during planned MSS activities shall apply during that clock hour.

**ATTACHMENT 6 – ACID RAIN PERMIT APPLICATION AND
CERTIFICATE OF REPRESENTATION**



**Texas Commission on Environmental Quality
Form OP-AR1
Acid Rain Permit Application
Federal Operating Permit Processes**

Date: 04/16/2026	Permit Name: Leon Creek Plant	ORIS Code: 3609
Account No.: BG-0059-Q	RN: RN100217439	CN: CN600129019
AIRS No.:	FINDS No.:	Submission: New <input type="checkbox"/> Revised <input type="checkbox"/> Renewal <input checked="" type="checkbox"/>

Unit ID No.	NADB No.	Unit Will Hold SO ₂ Allowances Per 40 CFR § 72.9(c)(1)	NO _x Limitation*	New Units Commence Operation Date	New Units Monitor Certification Deadline
CGT1	CGT1	Yes	No	NA	NA
CGT2	CGT2	Yes	No	NA	NA
CGT3	CGT3	Yes	No	NA	NA
CGT4	CGT4	Yes	No	NA	NA

Note: If NO_x Limitation is "YES" (this applies to coal-fired units only), the unit is subject to the NO_x limitations of 40 CFR Part 76 and the Designated Representative must submit an Acid Rain Program Phase II NO_x Compliance plan (EPA Form 7610-28).



The report output is displayed below. Use your browser's print functionality to print the report. A PDF may be generated by selecting 'Print to PDF' as the printer destination. This report output can be best printed when the print settings on your computer are set to a landscape orientation. If the report is downloadable, a Download button will appear and you may click it to download the report output.

Certificate of Representation Report

Leon Creek (3609) - TX

State

Texas

County

Bexar County

EPA Region

6

Latitude

29.3511

Longitude

-98.5753

FRS ID

110001878077

Representatives

Primary Representative

Gregg R Ticken

Effective Date: 06/16/2021

City Public Service

Alternate Representative

Melissa A Clyde

Effective Date: 06/16/2021

City Public Service
Engineer

Director Environmental
Planning and Compliance

500 McCullough Avenue
San Antonio, TX 78205-9673

(210) 353-2158
(210) 353-3012 (Fax)
(210) 837-2607 (Other)
grtienken@cpsenergy.com

Submitted Electronic
Signature Agreement: Yes

P.O. Box 1771
San Antonio, TX 78296

(210) 353-3302
(210) 353-3012 (Fax)
maclyde@cpsenergy.com

Submitted Electronic
Signature Agreement: Yes

Units

Unit 3

Programs

ARP, CSOSG2

Is this unit in Indian Country?

No

Operating Status

Retired

Commence Operation Date

05/01/1953

Commence Commercial Operation Date

05/01/1953

Source Category

Electric Utility

NAICS Code

221112 - Fossil fuel electric power generation

Owner(s)

City of San Antonio

Operator

City of San Antonio

Unit 4

Programs

ARP, CSOSG2

Is this unit in Indian Country?

No

Operating Status

Retired

Commence Operation Date

05/01/1959

Commence Commercial Operation Date

05/01/1959

Source Category

Electric Utility

NAICS Code

221112 - Fossil fuel electric power generation

Owner(s)

City of San Antonio

Operator

City of San Antonio

Unit CGT1

Unit CGT2

Programs

ARP, CSOSG2

Is this unit in Indian Country?

No

Operating Status

Operating

Commence Operation Date

05/15/2004

Commence Commercial Operation Date

05/15/2004

Source Category

Electric Utility

NAICS Code

221112 - Fossil fuel electric power generation

Owner(s)

City of San Antonio

Operator

City of San Antonio

Notes

7/8/2004 - L DeSantis - CCO date provided by
Cindy Levesque.

Programs

ARP, CSOSG2

Is this unit in Indian Country?

No

Operating Status

Operating

Commence Operation Date

05/15/2004

Commence Commercial Operation Date

05/15/2004

Source Category

Electric Utility

NAICS Code

221112 - Fossil fuel electric power generation

Owner(s)

City of San Antonio

Operator

City of San Antonio

Notes

7/8/2004 - L DeSantis - CCO date provided by
Cindy Levesque.

Unit CGT3**Programs**

ARP, CSOSG2

Is this unit in Indian Country?

No

Operating Status

Operating

Commence Operation Date

05/15/2004

Commence Commercial Operation Date

05/15/2004

Source Category

Electric Utility

Unit CGT4**Programs**

ARP, CSOSG2

Is this unit in Indian Country?

No

Operating Status

Operating

Commence Operation Date

05/15/2004

Commence Commercial Operation Date

05/15/2004

Source Category

Electric Utility

NAICS Code

221112 - Fossil fuel electric power generation

Owner(s)

City of San Antonio

Operator

City of San Antonio

Notes

7/8/2004 - L DeSantis - CCO date provided by
Cindy Levesque.

NAICS Code

221112 - Fossil fuel electric power generation

Owner(s)

City of San Antonio

Operator

City of San Antonio

Notes

7/8/2004 - L DeSantis - CCO date provided by
Cindy Levesque.

Generators

Generator 3**Acid Rain Program Nameplate Capacity (MWe)**

75

Other Programs Nameplate Capacity (MWe)

75

Units Linked to Generator

3

Generator 4**Acid Rain Program Nameplate Capacity (MWe)**

114

Other Programs Nameplate Capacity (MWe)

114

Units Linked to Generator

4

Generator CGT1**Acid Rain Program Nameplate Capacity (MWe)**

57

Other Programs Nameplate Capacity (MWe)

57

Units Linked to Generator

CGT1

Generator CGT2**Acid Rain Program Nameplate Capacity (MWe)**

57

Other Programs Nameplate Capacity (MWe)

57

Units Linked to Generator

CGT2

Generator CGT3**Generator CGT4**

Acid Rain Program Nameplate Capacity (MWe)

57

Other Programs Nameplate Capacity (MWe)

57

Units Linked to Generator

CGT3

Acid Rain Program Nameplate Capacity (MWe)

57

Other Programs Nameplate Capacity (MWe)

57

Units Linked to Generator

CGT4



i [Accessibility](#)

Events & News

Events & News / News & Media Center / News

Events Calendar

News & Media Center

All Library Blogs

News

Newsletters

Photo & Video Galleries

Social Media

News

Central Library to reopen April 1

\$3 million Bond project transformed the Library's first and third floors

10 March 2023 Author: Victoria Villarreal (SAPL)

Number of views: 2420

0 Comments

SAN ANTONIO (March 10, 2023) - San Antonio's iconic Central Library (600 Soledad, 78205) is reopening on April 1 following major renovations as part of the City of San Antonio's 2017-2022 Bond Program. In celebration of the reopening, San Antonio Public Library (SAPL) will host a grand reopening event to welcome the community back into the improved Central Library.

APRIL 2026

Sun	Mon	Tue	Wed	Thu	Fri	Sat
29	30	31	1	2	3	4
5	6	7	8	9	10	11
12	13	14	15	16	17	18
19	20	21	22	23	24	25
26	27	28	29	30	1	2
3	4	5	6	7	8	9

The \$3 million project included the renovation of the first and third floors to create a safe, functional, and welcoming entryway for the public as well as a modernized children's area. The first floor features a new main desk, art walk, and inclusive restroom with adult-sized changing table. The new Children's Library at Central features a new story room/flexible programming space, interactive early literacy play area, new family restroom, lactation room, and a new Family Connect computer lab.

"Central Library is an integral part of the City of San Antonio, and we know this is a much-anticipated reopening," said Ramiro S. Salazar, SAPL Director. "We are excited to share the improved spaces with the residents of San Antonio and visitors to our city. This renovation project enhances San Antonio Public Library's place as a world-class resource offering access

Archive

2025	75	programs, and a myriad of experiences for our users and visitors. This
2024	68	renovation project improves many of our most popular spaces to keep up with
2023	95	the evolving needs of our community.”
2022	363	
2021	463	
2020	447	More information about the official reopening event on April 1 will be shared in
2019	442	the coming weeks.
2018	458	
2017	443	
2016	285	
2015	8	The grand reopening signals a return to regular service for the majority of
2014	1	Central Library. The building’s sixth floor will remain closed as SAPL’s Texana and Genealogy Department prepares for an extensive \$3 million renovation as part of the voter-approved 2017 and 2022 Bond programs, including \$500,000 in private funds raised by the San Antonio Public Library Foundation. The result of that project, the Texana Resource Center, will feature a completely new design, upgraded study areas, a new classroom, improved wayfinding, and a new gallery and display space. The Texana and Genealogy Department will offer interim services out of a location on Central Library’s first floor beginning later in the year.

Categories

Uncategorized	1
Adults	1
Closures	8
Early Childhood	29
Kids	525
Locations	14
Press Releases	258
Seniors	1
Special Events	4
Teens	1
Texana	2219

Visit the Library’s Bond website for more information about the Central Library and Texana Resource Center Bond Projects.

For more information about San Antonio Public Library including locations and services, visit mysapl.org. Library staff is available by phone at 210-207-2500 or by chat at ask.mysapl.org.

-###-

City of San Antonio - Vibrant & Thriving

San Antonio is a vibrant city with a thriving economy, deep cultural heritage and communities that are compassionate, inclusive and proudly diverse. It is the seventh largest city in the United States and one of the strongest fiscally managed cities in the country, nurturing entrepreneurship, encouraging investment and funding infrastructure. The City fosters partnership and growth opportunities in aerospace, bioscience, cybersecurity, green technologies, healthcare, and information technology. San Antonio’s famed Riverwalk

and Alamo are the top tourist attractions in Texas, and its historic missions are a designated World Heritage Site – the first and only in Texas. Proudly called Military City, USA®, San Antonio is home to one of the largest populations of active-duty military and veterans, as well as mission-critical commands, including military medicine, cybersecurity, pilot training and basic training. For more information, visit SanAntonio.gov and follow @COSAGov on social.

San Antonio Public Library: changing lives through information, imagination, and ideas

For over 120 years, the award-winning San Antonio Public Library (SAPL) has provided free learning, knowledge, communication, culture, and enjoyment to residents of San Antonio and Bexar County. The Library system, comprised of a world-class Central Library, 28 branch libraries, and a library outlet at the Briscoe Western Art Museum, boasts a collection of over 2 million items including books, eBooks, audiobooks, movies, and more. All locations provide free indoor and outdoor Wi-Fi as well as access to public computers and other technology. All SAPL locations also offer programs to serve the diverse needs and interests of community members of all ages. For more information, visit mysapl.org and follow us on social media @mysapl.

Print

Categories: Press Release

Tags:

Rate this article: No rating

Gallery



SAPL Transforms Lives
mysapl



Watch on

Quick Links



Get a Library Card



Newsletter Sign Up



Pay Library Fees



Find PIN/Password



Mobile App



Ask

Contact Us

600 Soledad
San Antonio, TX 78205
☎ 210.207.2500
✉ Contact Library Administration
📄 Take our Customer Satisfaction Survey

Work With Us

- 📄 Career Opportunities
- ♥ Volunteer Opportunities

Get Connected







Search the Directory

Search

Rep. Philip Cortez (D)

Last modified on: 01-10-2025 22:05:44

[↩ Back to Texas House of Representatives \(/online/txhouse/\)](/online/txhouse/)

TX House Representative (Texas House of Representatives (/online/txhouse/))

Entered Office: 01-10-2017

District: 117

General Information

Profession: Public Relations Consultant

Home Town: San Antonio

Birthdate: 07-07-1978

Spouse: Debbie Cruz Cortez



Personal Information

BA, Political Science; MPA-University of Texas at San Antonio; Ph.D. in Educational Leadership and Administration, the University of Texas at Austin (2017)

H-2013-2015, 2017–present.

Prior to his position as state representative, Cortez was elected in 2007 and re-elected in 2009 to the San Antonio City Council. As councilman, he represented District 4, focusing on the development of the district's neighborhoods and on improvement projects citywide. He fought to improve police and fire departments, clean up parks, and modernize libraries throughout the district. Mayor Julian Castro selected Cortez to serve as chairman of the Audit, Infrastructure and Growth Committees, President of the San Antonio Housing Trust Public Facility Corporation, and as a member of the Governance Committee.

In 2019, Representative Cortez retired from the U.S. Air Force after proudly serving for 20 years. He served for seven years as an enlisted airman with the 433rd Airlift Wing at Lackland Air Force Base, eventually rising to Staff Sergeant. In 2006, Representative Cortez was commissioned as Second Lieutenant. He was deployed to the Middle East in April 2016 for six months in support of Operation Inherent Resolve. Rep. Cortez was awarded a Commendation Medal (First Oak Leaf Cluster) for Outstanding Achievement during his deployment. During his tenure as state representative, Rep. Cortez has successfully passed legislation supporting veterans and their families, improving our public schools, protecting senior citizens, and bringing jobs to Bexar County. Additionally, he stood up for property rights through annexation reform on behalf of the citizens of West Bexar County. He currently serves on the House Committee on Insurance and the House Committee on Urban Affairs. Rep. Cortez is married to Debbie Cruz-Cortez, J.D. She received her law degree from SMU Dedman School of Law and now practices immigration and criminal defense in South Texas. They welcomed their first child, Camila Cortez on May 18, 2024. They are proud to ser

Office Information

Dist. 117 - Bexar (10%)

Sens. Gutierrez, Menéndez

Committees

SC on Defense and Veterans' Affairs-Chair (/online/housecom/detail.php?id=581); Homeland Security, Public Safety & Veterans' Affairs (/online/housecom/detail.php?id=571); Intergovernmental Affairs (/online/housecom/detail.php?id=564); Select Committee on General Aviation (/online/housecom/detail.php?id=599)

Contact and Phone Numbers

Capitol Office:

4N.3

Capitol Phone: (512) 463-0269

📍 Zip Codes Within The District (<https://fyi.capitol.texas.gov/fyiwebdocs/PDF/house/dist117/r9.pdf>)

📍 District Map (<http://www.fyi.legis.state.tx.us/fyiwebdocs/PDF/house/dist117/m1.pdf>)

✉️ [Subscribe or Login to View Emails \(/catalog\)](#)

District Office

2600 SW Military Dr. , Suite 211

San Antonio, TX 78224

☎ (210) 923-3638

📠 (210) 923-3646

Staff

Office	Office Holder	Phone / Fax
Chief of Staff	Hannah Reinhard (/online/person/?id=69681&staff=10195)	(210) 587-5047
District Director	Valeria Quintero (/online/person/?id=72320&staff=11088)	(512) 463-0269

⚡ Helpful Links

Find My Incumbent (<http://www.fyi.legis.state.tx.us/>)

Capitol Maps (<https://tspb.texas.gov/plan/maps/maps.html>)

Bill Filings (<http://www.legis.state.tx.us/>)

Bill Search (<http://www.legis.state.tx.us/Search/BillSearch.aspx>)

Texas at Your Fingertips (<https://texas.gov/>)

State Symbols (<https://www.thestoryoftexas.com/education/texas-symbols>)

Governor Appointment (<https://gov.texas.gov/news/category/appointment>)

Addressing Procedures (<https://lrl.texas.gov/genInfo/ContactLeg.cfm>)

**TEXAS STATE
DIRECTORY** (1)

Since 1935 the Texas State Directory has been a trusted resource and has been referred to as the bible for anyone working in or wanting to learn about state, city and county government.

Useful Links

- [FIND MY INCUMBENT \(HTTP://WWW.FYI.LEGIS.STATE.TX.US/\)](http://www.fyi.legis.state.tx.us/) >
- [CAPITOL MAPS \(HTTPS://TSPB.TEXAS.GOV/PLAN/MAPS/MAPS.HTML\)](https://tspb.texas.gov/plan/maps/maps.html) >
- [BILL FILINGS \(HTTP://WWW.LEGIS.STATE.TX.US/\)](http://www.legis.state.tx.us/) >
- [BILL SEARCH \(HTTP://WWW.LEGIS.STATE.TX.US/SEARCH/BILLSEARCH.ASPX\)](http://www.legis.state.tx.us/search/billsearch.aspx) >
- [TEXAS AT YOUR FINGERTIPS \(HTTPS://TEXAS.GOV/\)](https://texas.gov/) >
- [STATE SYMBOLS \(HTTP://WWW.LEGIS.STATE.TX.US/RESOURCES/STATESYMBOLS.ASPX\)](http://www.legis.state.tx.us/resources/statesymbols.aspx) >
- [GOVERNOR APPOINTMENT \(HTTPS://GOV.TEXAS.GOV/NEWS/CATEGORY/APPOINTMENT\)](https://gov.texas.gov/news/category/appointment) >

Contact Us

Texas State Directory Press



1800 Nueces St.

Austin, Texas 78701

 (512) 473-2447

 [Contact Us \(/contact/\)](/contact/)

2026 © All Rights Reserved. [Privacy Policy \(/privacy/\)](/privacy/) | [Terms of Service \(/terms/\)](/terms/)

 (<https://www.facebook.com/Texas-State-Directory-142890752404984/>)  (<https://twitter.com/TSDPress>)



Search the Directory

Search

Sen. Roland Gutierrez (D)

Last modified on: 12-17-2022 13:16:11

[← Back to Texas Senate \(/online/txsenate/\)](/online/txsenate/)

TX Senator (Texas Senate (/online/txsenate/))

Entered Office: 01-12-2021

Term Ends: 01-2027

District: 19

General Information

Profession: Attorney

Home Town: San Antonio

Birthdate: 09-01-1970

Spouse: Sarah



Personal Information

BA, Political Science-UT San Antonio; JD-St. Mary's School of Law

H-2008-2021; TS-2021-present

Office Information

Dist. 19 - Atascosa (33%), Bexar (34%), Brewster (7%), Crockett, Edwards, Frio, Guadalupe (20%), Kinney, Maverick, Real, Terrell, Uvalde, Val Verde, Zavala

Committees

Local Government (</online/sencom/detail.php?id=305>); Water, Agriculture & Rural Affairs (</online/sencom/detail.php?id=523>)

Contact and Phone Numbers

Capitol Office:

3S.3

Capitol Phone: (512) 463-0119

✉ [Subscribe or Login to View Emails \(/catalog\)](/catalog)

📍 [District Map \(http://www.fyi.legis.texas.gov/fyiwebdocs/pdf/senate/dist19/m1.pdf\)](http://www.fyi.legis.texas.gov/fyiwebdocs/pdf/senate/dist19/m1.pdf)

Uvalde Office

2401 Garner Field Rd

Building Q2

Uvalde, TX 78801

📞 (830) 278-1234

San Antonio Office

1313 SE Military Dr., Suite 207

San Antonio, TX 78214

📞 (210) 532-2302

📠 (210) 532-2353

Staff

Office	Office Holder	Phone / Fax
Chief of Staff	Margaret Frain Wallace (/online/person/?id=62830&staff=8672)	(512) 463-0119 / (512) 463-1017
District Director	Katie Farias (/online/person/?id=67324&staff=9763)	(512) 463-0119
Legislative Director/Attorney	Martin Golando (/online/person/?id=72325&staff=11093)	(512) 463-0119
Communications Director	Jorjo Vasquez (/online/person/?id=73260&staff=11562)	

⚡ Helpful Links

[Find My Incumbent \(http://www.fyi.legis.state.tx.us/\)](http://www.fyi.legis.state.tx.us/)

[Capitol Maps \(https://tspb.texas.gov/plan/maps/maps.html\)](https://tspb.texas.gov/plan/maps/maps.html)

[Bill Filings \(http://www.legis.state.tx.us/\)](http://www.legis.state.tx.us/)

[Bill Search \(http://www.legis.state.tx.us/Search/BillSearch.aspx\)](http://www.legis.state.tx.us/Search/BillSearch.aspx)

[Texas at Your Fingertips \(https://texas.gov/\)](https://texas.gov/)

[State Symbols \(https://www.thestoryoftexas.com/education/texas-symbols\)](https://www.thestoryoftexas.com/education/texas-symbols)

[Governor Appointment \(https://gov.texas.gov/news/category/appointment\)](https://gov.texas.gov/news/category/appointment)

[Addressing Procedures \(https://lrl.texas.gov/genInfo/ContactLeg.cfm\)](https://lrl.texas.gov/genInfo/ContactLeg.cfm)

TEXAS STATE DIRECTORY (1)

Since 1935 the Texas State Directory has been a trusted resource and has been referred to as the bible for anyone working in or wanting to learn about state, city and county government.

Useful Links

[FIND MY INCUMBENT \(HTTP://WWW.FYI.LEGIS.STATE.TX.US/\)](http://www.fyi.legis.state.tx.us/) >

[CAPITOL MAPS \(HTTPS://TSPB.TEXAS.GOV/PLAN/MAPS/MAPS.HTML\)](https://tspb.texas.gov/plan/maps/maps.html) >

[BILL FILINGS \(HTTP://WWW.LEGIS.STATE.TX.US/\)](http://www.legis.state.tx.us/) >

[BILL SEARCH \(HTTP://WWW.LEGIS.STATE.TX.US/SEARCH/BILLSEARCH.ASPX\)](http://www.legis.state.tx.us/Search/BillSearch.aspx) >

[TEXAS AT YOUR FINGERTIPS \(HTTPS://TEXAS.GOV/\)](https://texas.gov/) >

[STATE SYMBOLS \(HTTP://WWW.LEGIS.STATE.TX.US/RESOURCES/STATESYMBOLS.ASPX\)](http://www.legis.state.tx.us/resources/statesymbols.aspx) >

[GOVERNOR APPOINTMENT \(HTTPS://GOV.TEXAS.GOV/NEWS/CATEGORY/APPOINTMENT\)](https://gov.texas.gov/news/category/appointment) >

Contact Us



Texas State Directory Press
1800 Nueces St.

Austin, Texas 78701

 (512) 473-2447

 [Contact Us \(/contact/\)](/contact/)

2026 © All Rights Reserved. [Privacy Policy \(/privacy/\)](/privacy/) | [Terms of Service \(/terms/\)](/terms/)

 (<https://www.facebook.com/Texas-State-Directory-142890752404984/>)  (<https://twitter.com/TSDPress>)

7718 Quintana Rd

Follow these links to contact your representatives:

Congressman Joaquin Castro

U.S. Congressional District 20



Representative Phillip Cortez

Texas House District 117



Senator Roland Gutierrez

Texas Senate District 19



Ms. Marisa B. Perez-Diaz

State Board of Education District 3



Senator John Cornyn

U.S. Senate



Senator Ted Cruz

U.S. Senate



U.S. CONGRESSIONAL DISTRICTS FOR 2026 ELECTIONS

U.S. Congressional District 35

Brooke T. Paup, *Chairwoman*
Catarina R. Gonzales, *Commissioner*
Tonya R. Miller, *Commissioner*
Kelly Keel, *Executive Director*



TEXAS COMMISSION ON ENVIRONMENTAL QUALITY

Protecting Texas by Reducing and Preventing Pollution

April 23, 2026

THE HONORABLE ROLAND GUTIERREZ
TEXAS SENATE
PO BOX 12068
AUSTIN TX 78711-2068

Re: Accepted Federal Operating Permit Renewal Application
Project Number: 40091
Permit Number: O5
City Public Service Board
Leon Creek Plant
San Antonio, Bexar County
Regulated Entity Number: RN100217439
Customer Reference Number: CN600129019

Dear Senator Gutierrez:

This letter notifies you that the Texas Commission on Environmental Quality has received a federal operating permit (FOP) renewal application for a site located in your district. As part of this permitting process, the applicant is required to publish a formal newspaper public notice. The notice will inform the public of their right to make comments or request a public hearing. This link to an electronic map of the site or facility's general location is provided as a public courtesy and not part of the application or notice. For exact location, refer to application. <https://gisweb.tceq.texas.gov/LocationMapper/?marker=-98.575555,29.351111&level=13>.

The FOP program regulates both new and existing major sources of emissions. The goal of the program is to improve air quality in Texas through increased compliance by codifying existing applicable regulatory requirements into the FOP. The FOP provides the applicant authorization to operate the equipment at the site. The FOP identifies and codifies air emission requirements (known as applicable requirements) that apply to the emission units at the site. The FOP does not authorize construction of emission units or emissions from those units. The New Source Review (NSR) permit is the mechanism for these authorizations.

The Honorable Roland Gutierrez
Page 2
April 23, 2026

Re: Accepted Federal Operating Permit Renewal Application

This letter is being sent to you for information only and no action is required. If you need further information, please contact me at (512) 239-1250.

Sincerely,

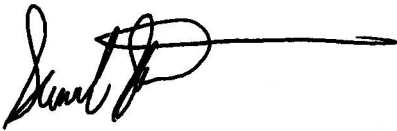
A handwritten signature in black ink, appearing to read "Samuel Short", followed by a long horizontal line extending to the right.

Samuel Short, Deputy Director
Air Permits Division
Office of Air
Texas Commission on Environmental Quality

Brooke T. Paup, *Chairwoman*
Catarina R. Gonzales, *Commissioner*
Tonya R. Miller, *Commissioner*
Kelly Keel, *Executive Director*



TEXAS COMMISSION ON ENVIRONMENTAL QUALITY

Protecting Texas by Reducing and Preventing Pollution

April 23, 2026

THE HONORABLE PHILIP CORTEZ
TEXAS HOUSE OF REPRESENTATIVES
PO BOX 2910
AUSTIN TX 78768-2910

Re: Accepted Federal Operating Permit Renewal Application
Project Number: 40091
Permit Number: O5
City Public Service Board
Leon Creek Plant
San Antonio, Bexar County
Regulated Entity Number: RN100217439
Customer Reference Number: CN600129019

Dear Representative Cortez:

This letter notifies you that the Texas Commission on Environmental Quality has received a federal operating permit (FOP) renewal application for a site located in your district. As part of this permitting process, the applicant is required to publish a formal newspaper public notice. The notice will inform the public of their right to make comments or request a public hearing. This link to an electronic map of the site or facility's general location is provided as a public courtesy and not part of the application or notice. For exact location, refer to application. <https://gisweb.tceq.texas.gov/LocationMapper/?marker=-98.575555,29.351111&level=13>.

The FOP program regulates both new and existing major sources of emissions. The goal of the program is to improve air quality in Texas through increased compliance by codifying existing applicable regulatory requirements into the FOP. The FOP provides the applicant authorization to operate the equipment at the site.

This letter is being sent to you for information only and no action is required. If you need further information, please contact me at (512) 239-1250.

Sincerely,

A handwritten signature in black ink, appearing to read "Samuel Short", with a long horizontal line extending to the right.

Samuel Short, Deputy Director
Air Permits Division
Office of Air
Texas Commission on Environmental Quality

From: [eNotice TCEQ](#)
To: roland.gutierrez@senate.texas.gov; Philip.cortez@house.texas.gov
Subject: TCEQ Notice - Permit Number O5
Date: Thursday, April 23, 2026 3:04:05 PM
Attachments: [TCEQ Notice O5 40091.pdf](#)

This email is being sent to electronically transmit an official document issued by the Office of Air of the Texas Commission on Environmental Quality.

This email is being sent to you because either (a) you filed a document with the Office of the Chief Clerk that made you part of the official mailing list for the above referenced matter, or (b) notice to you is legally required. As authorized by Texas Water Code 5.128, this electronic transmittal is replacing the previous practice of hard copy distribution. Amendments to Texas Government Code 552.137 prompted a change to the agency's privacy policy regarding confidentiality of certain email addresses. The revised privacy policy can be viewed at http://www.tceq.state.tx.us/help/policies/electronic_info_policy.html.

Questions regarding this email may be submitted either by replying directly to this email or by calling Mr. Rhyan Stone with the Air Permits Division at (512) 239-1293.

The attached document is provided in an Adobe Acrobat .pdf format. If you cannot display the attachment, you may need to visit the Adobe web site (<http://get.adobe.com/reader>) to download the free Adobe Acrobat Reader software.