

Texas Commission on Environmental Quality

Title V Existing

3670

Site Information (Regulated Entity)

What is the name of the permit area to be authorized?	MONTANA POWER STATION
Does the site have a physical address?	Yes
Physical Address	
Number and Street	13511B MONTANA AVE
City	EL PASO
State	TX
ZIP	79938
County	EL PASO
Latitude (N) (##.#####)	31.823888
Longitude (W) (-###.#####)	106.211944
Primary SIC Code	4911
Secondary SIC Code	
Primary NAICS Code	221112
Secondary NAICS Code	
Regulated Entity Site Information	
What is the Regulated Entity's Number (RN)?	RN106392624
What is the name of the Regulated Entity (RE)?	MONTANA POWER STATION
Does the RE site have a physical address?	Yes
Physical Address	
Number and Street	13511B MONTANA AVE
City	EL PASO
State	TX
ZIP	79938
County	EL PASO
Latitude (N) (##.#####)	31.8238
Longitude (W) (-###.#####)	-106.2119
Facility NAICS Code	
What is the primary business of this entity?	POWER GENERATION

Customer (Applicant) Information

How is this applicant associated with this site?	Owner Operator
What is the applicant's Customer Number (CN)?	CN600352819
Type of Customer	Corporation
Full legal name of the applicant:	
Legal Name	El Paso Electric Company
Texas SOS Filing Number	1073400
Federal Tax ID	740607870
State Franchise Tax ID	17406078703
State Sales Tax ID	

Local Tax ID	
DUNS Number	7928955
Number of Employees	501+
Independently Owned and Operated?	

Responsible Official Contact

Person TCEQ should contact for questions about this application:

Organization Name	EL PASO ELECTRIC COMPANY
Prefix	MR
First	DAVID
Middle	
Last	HAWKINS
Suffix	
Credentials	
Title	VP SYSTEM OPERATIONS AND RESOURCE STRATEGY
Enter new address or copy one from list:	
Mailing Address	
Address Type	Domestic
Mailing Address (include Suite or Bldg. here, if applicable)	PO BOX 982
Routing (such as Mail Code, Dept., or Attn:)	
City	EL PASO
State	TX
ZIP	79960
Phone (###-###-####)	9155434067
Extension	
Alternate Phone (###-###-####)	
Fax (###-###-####)	
E-mail	dave.hawkins@epelectric.com

Designated Representative Contact

Person TCEQ should contact for questions about this application:

Select existing DR contact or enter a new contact.	DAVID HAWKINS(EL PASO ELECTRI...)
Organization Name	EL PASO ELECTRIC COMPANY
Prefix	MR
First	DAVID
Middle	
Last	HAWKINS
Suffix	
Credentials	
Title	VP SYSTEM OPERATIONS AND RESOURCE STRATEGY
Enter new address or copy one from list:	
Mailing Address	
Address Type	Domestic

Mailing Address (include Suite or Bldg. here, if applicable)	PO BOX 982
Routing (such as Mail Code, Dept., or Attn:)	
City	EL PASO
State	TX
Zip	79960
Phone (###-###-####)	9155434067
Extension	
Alternate Phone (###-###-####)	
Fax (###-###-####)	
E-mail	dave.hawkins@epelectric.com

Technical Contact

Person TCEQ should contact for questions about this application:

Select existing TC contact or enter a new contact.

New Contact

Organization Name

El Paso Electric Company

Prefix

MS

First

Celena

Middle

Last

Arreola

Suffix

Credentials

Title

Supervisor - Environmental Compliance

Enter new address or copy one from list:

Mailing Address

Address Type

Domestic

Mailing Address (include Suite or Bldg. here, if applicable)

PO BOX 982

Routing (such as Mail Code, Dept., or Attn:)

City

EL PASO

State

TX

ZIP

79960

Phone (###-###-####)

9154856762

Extension

Alternate Phone (###-###-####)

Fax (###-###-####)

E-mail

celena.arreola@epelectric.com

Title V General Information - Existing

1) Permit Type:

SOP

2) Permit Latitude Coordinate:

31 Deg 49 Min 26 Sec

3) Permit Longitude Coordinate:

106 Deg 12 Min 43 Sec

4) Is this submittal a new application or an update to an existing application?

New Application

4.1. What type of permitting action are you applying for?

Renewal

4.1.1. Are there any permits that should be voided upon issuance of this permit application

No

through permit conversion?

4.1.2. Are there any permits that should be voided upon issuance of this permit application through permit consolidation?

No

5) Does this application include Acid Rain Program or Cross-State Air Pollution Rule requirements?

Yes

Title V Attachments Existing

Attach OP-1 (Site Information Summary)

Attach OP-2 (Application for Permit Revision/Renewal)

Attach OP-ACPS (Application Compliance Plan and Schedule)

Attach OP-REQ1 (Application Area-Wide Applicability Determinations and General Information)

Attach OP-REQ2 (Negative Applicable Requirement Determinations)

Attach OP-REQ3 (Applicable Requirements Summary)

Attach OP-PBRSUP (Permits by Rule Supplemental Table)

Attach OP-SUMR (Individual Unit Summary for Revisions)

Attach OP-MON (Monitoring Requirements)

Attach OP-UA (Unit Attribute) Forms

If applicable, attach OP-AR1 (Acid Rain Permit Application)

Attach OP-CRO2 (Change of Responsible Official Information)

Attach OP-DEL (Delegation of Responsible Official)

Attach any other necessary information needed to complete the permit.

[File Properties]

File Name

FINAL EPE MPS TV Renewal Application 04-21-2026.pdf

Hash

E69B6189C2018A7EE311025DE16958AA590FBCE0B3B22C365A51878C835E84E9

MIME-Type

application/pdf

An additional space to attach any other necessary information needed to complete the permit.

Expedite Title V

1) Per Texas Health and Safety Code, Section 382.05155, does the applicant want to expedite the processing of this application?

No

Certification

I certify that I am the Responsible Official for this application and that, based on information and belief formed after reasonable inquiry, the statements and information on this form are true, accurate, and complete.

1. I am David C Hawkins, the owner of the STEERS account ER090469.
2. I have the authority to sign this data on behalf of the applicant named above.
3. I have personally examined the foregoing and am familiar with its content and the content of any attachments, and based upon my personal knowledge and/or inquiry of any individual responsible for information contained herein, that this information is true, accurate, and complete.
4. I further certify that I have not violated any term in my TCEQ STEERS participation agreement and that I have no reason to believe that the confidentiality or use of my password has been compromised at any time.
5. I understand that use of my password constitutes an electronic signature legally equivalent to my written signature.
6. I also understand that the attestations of fact contained herein pertain to the implementation, oversight and enforcement of a state and/or federal environmental program and must be true and complete to the best of my knowledge.
7. I am aware that criminal penalties may be imposed for statements or omissions that I know or have reason to believe are untrue or misleading.
8. I am knowingly and intentionally signing Title V Existing 3670.
9. My signature indicates that I am in agreement with the information on this form, and authorize its submittal to the TCEC

OWNER OPERATOR Signature: David C Hawkins OWNER OPERATOR

Account Number:	ER090469
Signature IP Address:	155.190.8.94
Signature Date:	2026-04-23
Signature Hash:	0D8A31DAAFECB74B3F13090FA86CA1F0B216B3D27C8ABC4A8D0ED8DCD0F68C0E
Form Hash Code at time of Signature:	DDE71A7D8EBB65F338EB682C1D1E6425BB1FE1ED49DDDA2219A5269404B3D679

Certification

I certify that I am the Designated Representative for this application and am authorized to make this submission on behalf of the owners and operators of the source or units for which the submission is made. I certify under penalty of law that I have personally examined, and am familiar with, the statements and information submitted in this document and all its attachments. Based on my inquiry of those individuals with primary responsibility for obtaining the information, I certify that the statements are to the best of my knowledge and belief true, accurate, and complete. I am aware that there are significant penalties for submitting false statements and information or omitting required statements and information, including the possibility of fine or imprisonment.

1. I am David C Hawkins, the owner of the STEERS account ER090469.
2. I have the authority to sign this data on behalf of the applicant named above.
3. I have personally examined the foregoing and am familiar with its content and the content of any attachments, and based upon my personal knowledge and/or inquiry of any individual responsible for information contained herein, that this information is true, accurate, and complete.
4. I further certify that I have not violated any term in my TCEQ STEERS participation agreement and that I have no reason to believe that the confidentiality or use of my password has been compromised at any time.
5. I understand that use of my password constitutes an electronic signature legally equivalent to my written signature.
6. I also understand that the attestations of fact contained herein pertain to the implementation, oversight and enforcement of a state and/or federal environmental program and must be true and complete to the best of my knowledge.
7. I am aware that criminal penalties may be imposed for statements or omissions that I know or have reason to believe are untrue or misleading.
8. I am knowingly and intentionally signing Title V Existing 3670.
9. My signature indicates that I am in agreement with the information on this form, and authorize its submittal to the TCEC

OWNER OPERATOR Signature: David C Hawkins OWNER OPERATOR

Account Number:	ER090469
-----------------	----------

Signature IP Address:	155.190.8.94
Signature Date:	2026-04-23
Signature Hash:	0D8A31DAAFECB74B3F13090FA86CA1F0B216B3D27C8ABC4A8D0ED8DCD0F68C0E
Form Hash Code at time of Signature:	DDE71A7D8EBB65F338EB682C1D1E6425BB1FE1ED49DDDA2219A5269404B3D679

Submission

Reference Number:	The application reference number is 918285
Submitted by:	The application was submitted by ER090469/David C Hawkins
Submitted Timestamp:	The application was submitted on 2026-04-23 at 08:33:59 CDT
Submitted From:	The application was submitted from IP address 155.190.8.94
Confirmation Number:	The confirmation number is 764289
Steers Version:	The STEERS version is 6.94
Permit Number:	The permit number is 3670

Additional Information

Application Creator: This account was created by Kendalle E Martin



WSP
1601 S. Mopac Expressway, Suite 325D
Austin, TX 78746
USA
wsp.com

2026-04-23
Reference: US-PE-0263098-002

Texas Commission on Environmental Quality (TCEQ)
Air Permits Initial Review Team (APIRT) M161
P.O. Box 13087
Austin, TX 78711-3087

via STEERS

**Subject: Title V Permit No. O3670 Renewal Application
El Paso Electric Company
El Paso County, Texas
Customer Reference No.: CN600352819
Regulated Entity No.: RN106392624**

APIRT:

WSP USA Inc. (WSP), on behalf of El Paso Electric Company (EPE), hereby submits the enclosed renewal application for Title V Federal Operating Permit No. O3670 for the Montana Power Station (MPS) located in El Paso County, Texas. This submittal constitutes a timely renewal as it is being submitted at least six months, but no earlier than 18 months, before the date of expiration of the authorization (October 27, 2026) per the requirements of 30 TAC §122.133.

If you have any questions or require additional information, please do not hesitate to contact Ms. Celena Arreola by email at celena.arreola@epelectric.com or myself at the contact information below.

Sincerely,

Kendalle Martin
Air Quality Engineer
Phone: 512-879-4347
kendalle.martin@wsp.com

CC:

- Ms. Celena Arreola, EPE, w/attachment (via email)
- Mr. Ivan Galindo, EPE, w/attachment (via email)
- Mr. Kent Waggoner, P.G., Air Section Manager, TCEQ Region 6, w/attachment (via mail)
- Mr. Al Melero, Director, Code of Compliance Division, City of El Paso, w/attachment (via mail)
- EPA Region 6 Title V Permitting Contact (via email: R6AirPermitsTX@epa.gov)

WSP USA Inc.
2026-04-23
Reference: US-PE-0263098-002



El Paso Electric Company

**Montana Power Station
El Paso, El Paso County**

Renewal Application Title V Federal Operating Permit
O3670

Customer Reference No. CN600352819

Regulated Entity No. RN106392624

2026-04-23

US-PE-0263098-002

Submitted To:

Texas Commission on Environmental Quality

Air Division

P.O. Box 13087

Austin, Texas 78711-3087



Table of Contents

1.	Introduction	1
2.	Area Map and Plot Plan.....	2
3.	Process Description and Process Flow Diagram.....	5
4.	Title V Application Forms	7

No table of figures entries found. **List of Figures**

Figure 1:	Area Map	3
Figure 2:	Plot Plan.....	4
Figure 3:	PFD.....	6

List of Forms

- Form OP-CRO1
- Form OP-1
- Form OP-2
- Form OP-AR1
- Certificate of Representation
- Form OP-ACPS
- Form OP-REQ1
- Form OP-SUM
- Form OP-UA2
- Form OP-UA3
- Form OP-UA11
- Form OP-UA15
- Form OP-PBRSUP



1. Introduction

El Paso Electric Company (EPE) owns and operates the Montana Power Station (MPS) located in El Paso, El Paso County, Texas. MPS is currently authorized under Electric Generating Unit (EGU) Standard Permit No.123471, Permit By Rule (PBR) registration No. 149594, and various unregistered PBRs.

Per 30 Texas Administrative Code (TAC) §122.241(a), the FOP for MPS (Permit Number O3670) expires five years from the date of issuance. Thus, EPE is submitting this permit renewal six months prior to its FOP expiration date of October 26, 2026 as required by 30 TAC §122.133(2).

The following documentation is provided with this application: all required TCEQ FOP Renewal application forms, including forms addressing application certification, administrative information, site wide applicability information, and unit attribute information.

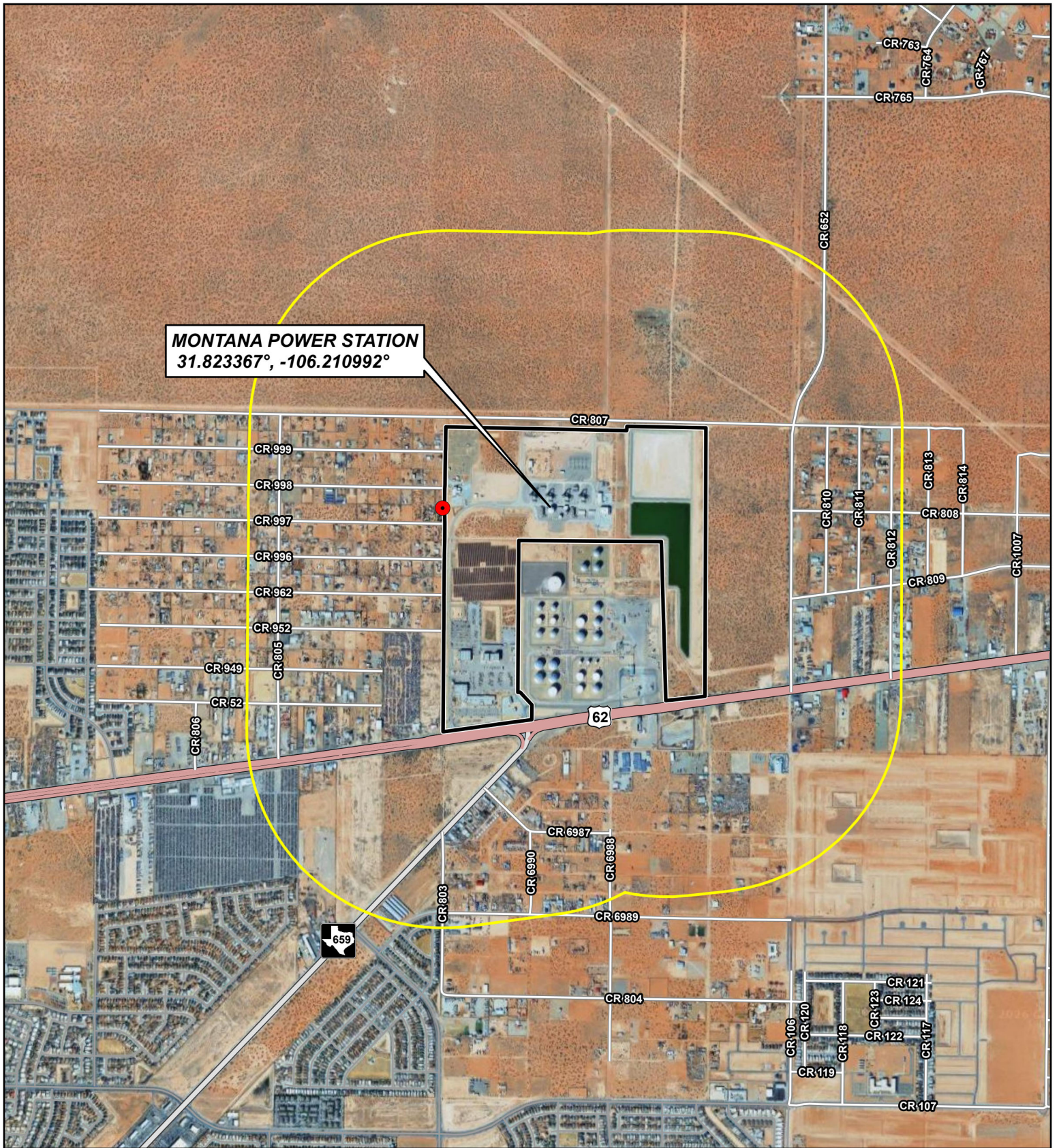


2. Area Map and Plot Plan

MPS is located in El Paso, El Paso County, Texas. A scaled area map is included in this section. A detailed plot plan of MPS showing the facilities addressed in this application is included in this section. Emission points are identified on the detailed plot plan.

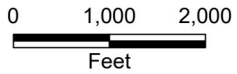


Figure 1: Area Map



MONTANA POWER STATION
 31.823367°, -106.210992°

- Nearest Receptor
- Facility Boundary
- 3000' Radius



EL PASO ELECTRIC COMPANY
 MONTANA POWER STATION

**FIGURE 1:
 AREA MAP**

EL PASO COUNTY,
 TEXAS



Date: 2/6/2026



Figure 2: Plot Plan

3. Process Description and Process Flow Diagram

This section includes a process description and process flow diagram for MPS.

Process Description

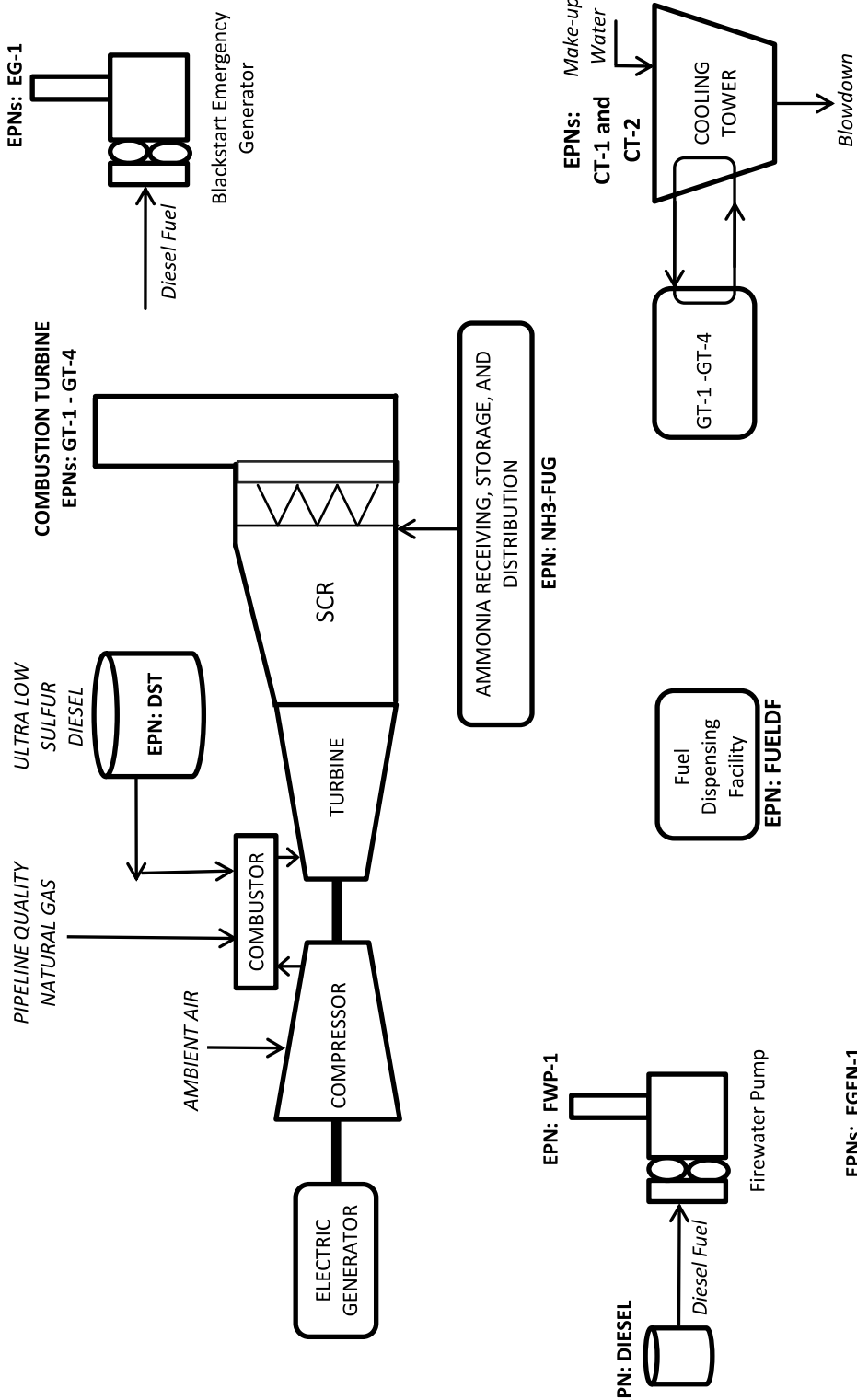
The Electric Generating Units (EGUs) at MPS include four 100 MWe (nominal) simple cycle GE LMS100PA combustion turbines (CTs) used in peaking service (EPNs: GT-1, GT-2, GT-3, and GT-4). The four CTs are primarily natural gas-fired but are authorized to fire diesel fuel during emergency situations, such as natural gas curtailment and testing. All four CTs are equipped with Selective Catalytic Reduction (SCR) for nitrogen oxide (NO_x) control and Oxidation Catalyst (OC) for carbon monoxide (CO) and volatile organic carbon (VOC) control. Ancillary air emitting equipment used to support MPS EGU operations includes:


- Two circulating-water cooling towers (EPNs: CT-1 and CT-2)
- One diesel-fired Internal Combustion (IC) engine Emergency Black Start Generator and diesel storage tank (EPN: EG-1)
- One diesel-fired IC engine Emergency Generator and diesel storage tank (EPN: EGEN-1)
- One diesel-fired IC engine Emergency Firewater Pump (EPN: FWP-1) and diesel storage tank (EPN: DIESEL)
- One diesel storage tank (EPN: DST) for use during emergency situations and testing
- One fuel dispensing facility (EPN: FUELDF)
- Fugitive emissions from piping components in ammonia service (EPN: NH₃-FUG)

Aqueous ammonia is stored in pressurized tanks, and the unloading operations are equipped with a vapor return line. Therefore, the ammonia storage tanks and unloading operations are not considered potential emission sources.



Figure 3: PFD



El Paso Electric Company Montana Power Station		PROCESS FLOW DIAGRAM	
Title V Permit No. 0367 Renewal Application		Project No: 0263098.01.01	
		Drawn by: K. Martin	Date: 02/06/2026
		Checked by: T. Naab	Sheet: 1 of 1



4. Title V Application Forms

List of Forms In Order of Attachment

FORM OP-CRO1

FORM OP-1

FORM OP-2

FORM OP-AR1

CERTIFICATE OF REPRESENTATION

FORM OP-ACPS

FORM OP-REQ1

FORM OP-SUM

FORM OP-UA2

FORM OP-UA3

FORM OP-UA11

FORM OP-UA15

FORM OP-PBRSUP



Form OP-CRO1

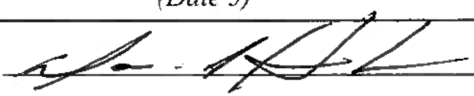
Form OP-CRO1
Certification by Responsible Official
Federal Operating Permit Program
Texas Commission on Environmental Quality

All initial issuance, revision, renewal, and reopening permit application submittals requiring certification must be addressed using this form. Updates to site operating permit (SOP) and temporary operating permit (TOP) applications, other than public notice verification materials, must be certified prior to authorization of public notice or start of public announcement. Updates to general operating permit (GOP) applications must be certified prior to receiving an authorization to operate under a GOP.

I. Identifying Information
RN: RN106392624
CN: CN600352819
Account No.: EE-A014-N
Permit No.: O3670
Project No.: TBA
Area Name: Montana Power Station
Company Name: El Paso Electric Company
II. Certification Type <i>(Please mark appropriate box)</i>
<input checked="" type="checkbox"/> Responsible Official Representative <input type="checkbox"/> Duly Authorized Representative
III. Submittal Type <i>(Please mark appropriate box) (Only one response can be accepted per form)</i>
<input type="checkbox"/> SOP/TOP Initial Permit Application <input checked="" type="checkbox"/> Permit Revision, Renewal, or Reopening
<input type="checkbox"/> GOP Initial Permit Application <input type="checkbox"/> Update to Permit Application
<input type="checkbox"/> Other: _____

Form OP-CRO1
Certification by Responsible Official
Federal Operating Permit Program
Texas Commission on Environmental Quality

All initial issuance, revision, and renewal permit application submittals requiring certification must be accompanied by this form. Updates to acid rain or CSAPR (other than public notice verification materials) must be certified prior to authorization of public notice for the draft permit.

IV. Certification of Truth			
This certification does not extend to information which is designated by TCEQ as information for reference only.			
I, <u>David Hawkins</u>		certify that I am the <u>RO</u>	
<i>(Certifier Name printed or typed)</i>		<i>(RO or DAR)</i>	
and that, based on information and belief formed after reasonable inquiry, the statements and information dated during the time period or on the specific date(s) below, are true, accurate, and complete: <i>Note: Enter Either a Time Period or Specific Date(s) for each certification. This section must be completed. The certification is not valid without documentation date(s).</i>			
Time Period: From _____		to _____	
<i>(Start Date)</i>		<i>(End Date)</i>	
Specific Dates: <u>04/23/2026</u>			
<i>(Date 1)</i>		<i>(Date 2)</i>	
<i>(Date 3)</i>		<i>(Date 4)</i>	
<i>(Date 5)</i>		<i>(Date 6)</i>	
Signature: 		Signature Date: <u>04/23/2026</u>	
Title: <u>VP- System Planning and Operations Support</u>			

Form OP-CRO1
Certification by Responsible Official
Federal Operating Permit Program
Texas Commission on Environmental Quality

All initial issuance, revision, and renewal permit application submittals requiring certification must be accompanied by this form. Updates to acid rain or CSAPR (other than public notice verification materials) must be certified prior to authorization of public notice for the draft permit.

I. Identifying Information
RN: RN106392624
CN: CN600352819
Account No.: EE-A014-N
Permit No.: O3670
Project No.: TBA
Area Name: Montana Power Station
Company Name: El Paso Electric Company
II. Certification Type <i>(Please mark appropriate box)</i>
<input checked="" type="checkbox"/> Designated Representative <input type="checkbox"/> Alternated Designated Representative
III. Requirement and Submittal Type <i>(Please mark the appropriate boxes for each row)</i>
Requirement: <input checked="" type="checkbox"/> Acid Rain Permit <input checked="" type="checkbox"/> CSAPR
Submittal Type: <input type="checkbox"/> Initial Permit Application <input type="checkbox"/> Update to Permit Application <input checked="" type="checkbox"/> Permit Revision or Renewal <input type="checkbox"/> Other:

Form OP-CRO1
Certification by Responsible Official
Federal Operating Permit Program
Texas Commission on Environmental Quality

IV. Certification of Truth

I, David Hawkins certify that I am the DR
(Certifier Name printed or typed) *(RO or DAR)*

am authorized to make this submission on behalf of the owners and operators of the source or units for which the submission is made. I certify under penalty of law that I have personally examined, and am familiar with, the statements and information submitted in this document and all its attachments. Based on my inquiry of those individuals with primary responsibility for obtaining the information, I certify that the statements are to the best of my knowledge and belief true, accurate, and complete. I am aware that there are significant penalties for submitting false statements and information or omitting required statements and information, including the possibility of fine or imprisonment. The above certification is for the statements and information dated during the time period or on the specific date(s) below:
Note: Enter Either a Time Period or Specific Date(s) for each certification. This section must be completed. The certification is not valid without documentation date(s).

Time Period: From _____ to _____
(Start Date) *(End Date)*

Specific Dates: 04/23/2026
(Date 1) *(Date 2)* *(Date 3)* *(Date 4)*
(Date 5) *(Date 6)*

Signature:  Signature Date: 04/23/2026

Title: VP- System Planning and Operations Support



Form OP-1

**Federal Operating Permit Program
Site Information Summary
Form OP-1 (Page 1)
Texas Commission on Environmental Quality**

Please print or type all information. Direct any questions regarding this application form to the Air Permits Division at (512) 239-1250 or to the Texas Commission on Environmental Quality, Office of Air, Air-Permits Division (MC 163), P.O. Box 13087, Austin, Texas 78711-3087.

I. Company Identifying Information
A. Company Name: El Paso Electric Company
B. Customer Reference Number (CN): CN600352819
C. Submittal Date (mm/dd/yyyy): 04/23/2026
II. Site Information
A. Site Name: Montana Power Station
B. Regulated Entity Reference Number (RN): RN106392624
C. Indicate affected state(s) required to review permit application: <i>(Check the appropriate box[es].)</i>
<input type="checkbox"/> AR <input type="checkbox"/> CO <input type="checkbox"/> KS <input type="checkbox"/> LA <input checked="" type="checkbox"/> NM <input type="checkbox"/> OK <input type="checkbox"/> N/A
D. Indicate all pollutants for which the site is a major source based on the site's potential to emit: <i>(Check the appropriate box[es].)</i>
<input type="checkbox"/> VOC <input checked="" type="checkbox"/> NO _x <input type="checkbox"/> SO ₂ <input checked="" type="checkbox"/> PM ₁₀ <input checked="" type="checkbox"/> CO <input type="checkbox"/> Pb <input type="checkbox"/> HAPS
Other:
E. Is the site a non-major source subject to the Federal Operating Permit Program? <input type="checkbox"/> Yes <input checked="" type="checkbox"/> No
F. Is the site within a local program area jurisdiction? <input checked="" type="checkbox"/> Yes <input type="checkbox"/> No
G. Will emissions averaging be used to comply with any Subpart of 40 CFR Part 63? <input type="checkbox"/> Yes <input checked="" type="checkbox"/> No
H. Indicate the 40 CFR Part 63 Subpart(s) that will use emissions averaging:
III. Permit Type
A. Type of Permit Requested: <i>(Select only one response)</i>
<input checked="" type="checkbox"/> Site Operating Permit (SOP) <input type="checkbox"/> Temporary Operating Permit (TOP) <input type="checkbox"/> General Operating Permit (GOP)

**Federal Operating Permit Program
Site Information Summary
Form OP-1 (Page 2)
Texas Commission on Environmental Quality**

IV. Initial Application Information <i>(Complete for Initial Issuance Applications Only.)</i>	
A. Is this submittal an abbreviated or a full application?	<input type="checkbox"/> Abbreviated <input type="checkbox"/> Full
B. If this is a full application, is the submittal a follow-up to an abbreviated application?	<input type="checkbox"/> Yes <input type="checkbox"/> No
C. If this is an abbreviated application, is this an early submittal for a combined SOP and Acid Rain permit?	<input type="checkbox"/> Yes <input type="checkbox"/> No
D. Has an electronic copy of this application been submitted (or is being submitted) to EPA? (Refer to the form instructions for additional information.)	<input type="checkbox"/> Yes <input type="checkbox"/> No
E. Has the required Public Involvement Plan been included with this application?	<input type="checkbox"/> Yes <input type="checkbox"/> No
V. Confidential Information	
A. Is confidential information submitted in conjunction with this application?	<input type="checkbox"/> Yes <input checked="" type="checkbox"/> No
VI. Responsible Official (RO) Identifying Information	
RO Name Prefix: (<input checked="" type="checkbox"/> Mr. <input type="checkbox"/> Mrs. <input type="checkbox"/> Ms. <input type="checkbox"/> Dr.)	
RO Full Name: David Hawkins	
RO Title: VP – System Planning and Operations Support	
Employer Name: El Paso Electric Company	
Mailing Address: 100 N. Stanton	
City: El Paso	
State: TX	
ZIP Code: 79901	
Territory:	
Country: USA	
Foreign Postal Code:	
Internal Mail Code:	
Telephone No.: 915-543-4067	
Fax No.:	
Email: David.Hawkins@epelectric.com	

**Federal Operating Permit Program
Site Information Summary
Form OP-1 (Page 3)
Texas Commission on Environmental Quality**

VII. Technical Contact Identifying Information <i>(Complete if different from RO.)</i>	
Technical Contact Name Prefix: (<input type="checkbox"/> Mr. <input type="checkbox"/> Mrs. <input checked="" type="checkbox"/> Ms. <input type="checkbox"/> Dr.)	
Technical Contact Full Name: Celena Arreola	
Technical Contact Title: Supervisor – Environmental Compliance	
Employer Name: El Paso Electric Company	
Mailing Address: P.O. Box 982	
City: El Paso	
State: TX	
ZIP Code: 79901	
Territory:	
Country: USA	
Foreign Postal Code:	
Internal Mail Code:	
Telephone No.: 915-485-6762	
Fax No.:	
Email: celena.arreola@epelectric.com	
VIII. Reference Only Requirements <i>(For reference only.)</i>	
A. State Senator: Senator Cesar Blanco	
B. State Representative: Representative Eddie Morales	
C. Has the applicant paid emissions fees for the most recent agency fiscal year (Sept. 1 - August 31)?	<input checked="" type="checkbox"/> Yes <input type="checkbox"/> No <input type="checkbox"/> N/A
D. Is the site subject to bilingual notice requirements pursuant to 30 TAC § 122.322?	<input checked="" type="checkbox"/> Yes <input type="checkbox"/> No
E. Indicate the alternate language(s) in which public notice is required: Spanish	

**Federal Operating Permit Program
Site Information Summary
Form OP-1 (Page 4)
Texas Commission on Environmental Quality**

IX. Off-Site Permit Request <i>(Optional for applicants requesting to hold the FOP and records at an off-site location.)</i>
A. Office/Facility Name:
B. Physical Address:
City:
State:
ZIP Code:
Territory:
Country:
Foreign Postal Code:
C. Physical Location:
D. Contact Name Prefix: (<input type="checkbox"/> Mr. <input type="checkbox"/> Mrs. <input type="checkbox"/> Ms. <input type="checkbox"/> Dr.)
Contact Full Name:
E. Telephone No.:
X. Application Area Information
A. Area Name: Montana Power Station
B. Physical Address: 13511B Montana Ave
City: El Paso
State: TX
ZIP Code: 79938
C. Physical Location:
D. Nearest City:
E. State:
F. ZIP Code:

**Federal Operating Permit Program
Site Information Summary
Form OP-1 (Page 5)
Texas Commission on Environmental Quality**

X. Application Area Information (continued)
G. Latitude (nearest second): 31° 49' 26"
H. Longitude (nearest second): 106° 12' 43"
I. Are there any emission units that were not in compliance with the applicable requirements identified in the application at the time of application submittal? <input type="checkbox"/> Yes <input checked="" type="checkbox"/> No
J. Indicate the estimated number of emission units in the application area: 13
K. Are there any emission units in the application area subject to the Acid Rain Program? <input checked="" type="checkbox"/> Yes <input type="checkbox"/> No
L. Affected Source Plant Code (or ORIS/Facility Code): 58562
XI. Public Notice <i>(Complete this section for SOP Applications and Acid Rain Permit Applications only.)</i>
A. Name of a public place to view application and draft permit: Esperanza Acosta Moreno Library
B. Physical Address: 12480 Pebble Hills Blvd
City: El Paso
ZIP Code: 79938
C. Contact Person (Someone who will answer questions from the public during the public notice period):
Contact Name Prefix: (<input type="checkbox"/> Mr. <input type="checkbox"/> Mrs. <input checked="" type="checkbox"/> Ms. <input type="checkbox"/> Dr.):
Contact Person Full Name: Celena Arreola
Contact Mailing Address: P.O. Box 982
City: El Paso
State: TX
ZIP Code: 79901
Territory:
Country: USA
Foreign Postal Code:
Internal Mail Code:
Telephone No.: 915-485-6762

**Federal Operating Permit Program
Site Information Summary
Form OP-1 (Page 6)
Texas Commission on Environmental Quality**

XII. Delinquent Fees and Penalties
Notice: This form will not be processed until all delinquent fees and/or penalties owed to TCEQ or the Office of Attorney General on behalf of TCEQ are paid in accordance with the "Delinquent Fee and Penalty Protocol."
Complete Sections XIII and XIV for Acid Rain Permit and CSAPR applications only. Please include a copy of the Certificate of Representation submitted to EPA.
XIII. Designated Representative (DR) Identifying Information
DR Name Prefix: (<input checked="" type="checkbox"/> Mr. <input type="checkbox"/> Mrs. <input type="checkbox"/> Ms. <input type="checkbox"/> Dr.)
DR Full Name: David Hawkins
DR Title: VP – System Planning and Operations Support
Employer Name: El Paso Electric Company
Mailing Address: 100 N. Stanton
City: El Paso
State: TX
ZIP Code: 79901
Territory:
Country: USA
Foreign Postal Code:
Internal Mail Code:
Telephone No.: 915-543-4067
Fax No.:
Email: David.Hawkins@epelectric.com

**Federal Operating Permit Program
Site Information Summary
Form OP-1 (Page 7)
Texas Commission on Environmental Quality**

Complete Sections XIII and XIV for Acid Rain Permit and CSAPR applications only. Please include a copy of the Certificate of Representation submitted to EPA.

XIV. Alternate Designated Representative (ADR) Identifying Information

ADR Name Prefix: (Mr. Mrs. Ms. Dr.)

ADR Full Name: Teresa M. Sosa

ADR Title: Environmental and Safety Director

Employer Name: El Paso Electric Company

Mailing Address: 100 N. Stanton

City: El Paso

State: TX

ZIP Code: 79901

Territory:

Country: USA

Foreign Postal Code:

Internal Mail Code:

Telephone No.: 915-543-5802

Fax No.:

Email: teresa.sosa@epelectric.com



Form OP-2

**Federal Operating Permit Program
Application for Permit Revision/Renewal
Form OP-2-Table 1
Texas Commission on Environmental Quality**

Date: 04/23/2026
Permit No.: 03670
Regulated Entity No.: RN106392624
Company Name: El Paso Electric Company
For Submissions to EPA
Has an electronic copy of this application been submitted (or is being submitted) to EPA? <input checked="" type="checkbox"/> YES <input type="checkbox"/> NO
I. Application Type
Indicate the type of application:
<input checked="" type="checkbox"/> Renewal
<input type="checkbox"/> Streamlined Revision (Must include provisional terms and conditions as explained in the instructions.)
<input type="checkbox"/> Significant Revision
<input type="checkbox"/> Revision Requesting Prior Approval
<input type="checkbox"/> Administrative Revision
<input type="checkbox"/> Response to Reopening
II. Qualification Statement
For SOP Revisions Only <input type="checkbox"/> YES <input type="checkbox"/> NO
For GOP Revisions Only <input type="checkbox"/> YES <input type="checkbox"/> NO

**Federal Operating Permit Program
Application for Permit Revision/Renewal
Form OP-2-Table 1 (continued)
Texas Commission on Environmental Quality**

III. Major Source Pollutants (Complete this section if the permit revision is due to a change at the site or change in regulations.)
Indicate all pollutants for which the site is a major source based on the site's potential to emit: (Check the appropriate box[es].)
<input type="checkbox"/> VOC <input checked="" type="checkbox"/> NO _x <input type="checkbox"/> SO ₂ <input checked="" type="checkbox"/> PM ₁₀ <input checked="" type="checkbox"/> CO <input type="checkbox"/> Pb <input type="checkbox"/> HAP
Other:
IV. Reference Only Requirements (For reference only)
Has the applicant paid emissions fees for the most recent agency fiscal year (September 1 - August 31)? <input checked="" type="checkbox"/> YES <input type="checkbox"/> NO <input type="checkbox"/> N/A
V. Delinquent Fees and Penalties
Notice: This form will not be processed until all delinquent fees and/or penalties owed to the TCEQ or the Office of the Attorney General on behalf of the TCEQ are paid in accordance with the Delinquent Fee and penalty protocol.



Form OP-AR1



Texas Commission on Environmental Quality
Form OP-ARI
Acid Rain Permit Application
Federal Operating Permit Processes

Date: 04/23/2026	Permit Name: O3670	ORIS Code: 58562	
Account No.: EE-A014-N	RN: RN106392624	CN: CN600352819	
AIRS No.:	FINDS No.:	Submission: New <input type="checkbox"/> Revised <input type="checkbox"/> Renewal <input checked="" type="checkbox"/>	

Unit ID No.	NADB No.	Unit Will Hold SO ₂ Allowances Per 40 CFR § 72.9(c)(1)	NO _x Limitation*	New Units Commence Operation Date	New Units Monitor Certification Deadline
GT-1	GT-1	Yes	NO		
GT-2	GT-2	Yes	NO		
GT-3	GT-3	Yes	NO		
GT-4	GT-4	Yes	NO		

Note: If NO_x Limitation is "YES" (this applies to coal-fired units only), the unit is subject to the NO_x limitations of 40 CFR Part 76 and the Designated Representative must submit an Acid Rain Program Phase II NO_x Compliance plan (EPA Form 7610-28).



Certificate of Representation



P.O. Box 982
El Paso, Texas
79960-0982
(915) 543-5711

March 15, 2022

U.S. Environmental Protection Agency
1200 Pennsylvania Avenue, NW
Mail Code 6204M
Attention: Designated Representative
Washington, DC 20460

Via E-mail to: CAMDForms@epa.gov

**Re: Change of Designated Representative
El Paso Electric Company
Copper, Newman, Rio Grande, and Montana Stations**

El Paso Electric is submitting this correspondence to remove Mr. Steven T. Buraczyk as Designated Representative (DR) and to add Mr. David C. Hawkins as the new Designated Representative for the following facilities:

Facility Name: Copper Station
Facility ID: 9
Applicable Programs: CSAPR NOx Ozone Season

Facility Name: Newman
Facility ID: 3456
Applicable Programs: Acid Rain, CSAPR NOx Ozone Season, Texas SO2 Trading Program

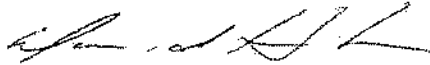
Facility Name: Rio Grande
Facility ID: 2444
Applicable Programs: Acid Rain

Facility Name: Montana
Facility ID: 58562
Applicable Programs: Acid Rain, CSAPR NOx Ozone Season

The contact information for the incoming DR (David C. Hawkins) is included in the attached P. 1 of the Certificate of Representation. Attached you will also find P 3-7 of the Certificate of Representation that include the certification statements for each of the applicable programs and the signature of the new DR and the current ADR. No other facility or unit data are changing.

If you have any questions or require additional information, please do not hesitate to contact Teresa M. Sosa at (915) 478-6009.

Sincerely,

A handwritten signature in black ink, appearing to read "D. Hawkins". The signature is fluid and cursive, with a prominent initial "D" and a long, sweeping underline.

David C. Hawkins
VP- Strategy and Sustainability

Enclosure: P. 1 and P. 3-7 of the Certificate of Representation.



Certificate of Representation

See instructions and 40 CFR 72.24, 97.416, 97.516, 97.616, 97.716, 97.816, and 97.916, 97.1016, or a comparable state regulation, as applicable. Note that the designated representative identified on this form is also the certifying official responsible for making related submissions for the identified unit(s), under additional programs, as indicated in the instructions.

This submission is: New Revised (revised submissions must be complete; see instructions)

STEP 1
Provide information for the plant

See Attached Letter with facility information for 4 facilities		State	Plant Code
Plant Name			
County Name			
Latitude		Longitude	

STEP 2
Enter requested information for the designated representative

David C. Hawkins		Vice President- Strategy and Sustainability	
Name		Title	
El Paso Electric Company			
Company Name			
100 N. Stanton	El Paso	TX	79901
Mailing Address	City	State	Zip Code
(915) 543-4067	(915) 543-4703		
Phone Number	Fax Number		
dave.hawkins@epelectric.com			
Email Address			

STEP 3
Enter requested information for the alternate designated representative

Teresa M. Sosa		Manager, Environmental	
Name		Title	
El Paso Electric Company			
Company Name			
100 N. Stanton	El Paso	TX	79901
Mailing Address	City	State	Zip Code
(915) 521-4649	(915) 543-5802		
Phone Number	Fax Number		
teresa.sosa@epelectric.com			
Email Address			

STEP 5: Read the applicable certification statements, sign, and date.

Acid Rain Program

I certify that I was selected as the 'designated representative' or 'alternate designated representative', as applicable, by an agreement binding on the owners and operators of the affected source and each affected unit at the source.

I certify that I have all necessary authority to carry out my duties and responsibilities under the Acid Rain Program on behalf of the owners and operators of the affected source and each affected unit at the source and that each such owner and operator shall be fully bound by my representations, actions, inactions, or submissions.

I certify that the owners and operators of the affected source and each affected unit at the source shall be bound by any order issued to me by the Administrator, the permitting authority, or a court regarding the source or unit.

Where there are multiple holders of a legal or equitable title to, or a leasehold interest in, an affected unit, or where a utility or industrial customer purchases power from an affected unit under a life-of-the-unit, firm power contractual arrangement, I certify that: I have given a written notice of my selection as the designated representative or alternate designated representative, as applicable, and of the agreement by which I was selected to each owner and operator of the affected source and each affected unit at the source and; allowances and proceeds of transactions involving allowances will be deemed to be held or distributed in proportion to each holder's legal, equitable, leasehold, or contractual reservation or entitlement, except that, if such multiple holders have expressly provided for a different distribution of allowances by contract, allowances and proceeds of transactions involving allowances will be deemed to be held or distributed in accordance with the contract.

CSAPR NO_x Annual Trading Program

I certify that I was selected as the designated representative or alternate designated representative, as applicable, by an agreement binding on the owners and operators of the source and each CSAPR NO_x Annual unit at the source.

I certify that I have all the necessary authority to carry out my duties and responsibilities under the CSAPR NO_x Annual Trading Program on behalf of the owners and operators of the source and of each CSAPR NO_x Annual unit at the source and that each such owner and operator shall be fully bound by my representations, actions, inactions, or submissions and by any decision or order issued to me by the Administrator regarding the source or unit.

Where there are multiple holders of a legal or equitable title to, or a leasehold interest in, a CSAPR NO_x Annual unit, or where a utility or industrial customer purchases power from a CSAPR NO_x Annual unit under a life-of-the-unit, firm power contractual arrangement, I certify that: I have given a written notice of my selection as the 'designated representative' or 'alternate designated representative', as applicable, and of the agreement by which I was selected to each owner and operator of the source and of each CSAPR NO_x Annual unit at the source; and CSAPR NO_x Annual allowances and; proceeds of transactions involving CSAPR NO_x Annual allowances will be deemed to be held or distributed in proportion to each holder's legal, equitable, leasehold, or contractual reservation or entitlement, except that, if such multiple holders have expressly provided for a different distribution of CSAPR NO_x Annual allowances by contract, CSAPR NO_x Annual allowances and proceeds of transactions involving CSAPR NO_x Annual allowances will be deemed to be held or distributed in accordance with the contract.

CSAPR NO_x Ozone Season Group 1 Trading Program

I certify that I was selected as the designated representative or alternate designated representative, as applicable, by an agreement binding on the owners and operators of the source and each CSAPR NO_x Ozone Season Group 1 unit at the source.

I certify that I have all the necessary authority to carry out my duties and responsibilities under the CSAPR NO_x Ozone Season Group 1 Trading Program on behalf of the owners and operators of the source and of each CSAPR NO_x Ozone Season Group 1 unit at the source and that each such owner and operator shall be fully bound by my representations, actions, inactions, or submissions and by any decision or order issued to me by the Administrator regarding the source or unit.

Where there are multiple holders of a legal or equitable title to, or a leasehold interest in, a CSAPR NO_x Ozone Season Group 1 unit, or where a utility or industrial customer purchases power from a CSAPR NO_x Ozone Season Group 1 unit under a life-of-the-unit, firm power contractual arrangement, I certify that: I have given a written notice of my selection as the 'designated representative' or 'alternate designated representative', as applicable, and of the agreement by which I was selected to each owner and operator of the source and of each CSAPR NO_x Ozone Season Group 1 unit at the source; and CSAPR NO_x Ozone Season Group 1 allowances and proceeds of transactions involving CSAPR NO_x Ozone Season Group 1 allowances will be deemed to be held or distributed in proportion to each holder's legal, equitable, leasehold, or contractual reservation or entitlement, except that, if such multiple holders have expressly provided for a different distribution of CSAPR NO_x Ozone Season Group 1 allowances by contract, CSAPR NO_x Ozone Season Group 1 allowances and proceeds of transactions involving CSAPR NO_x Ozone Season Group 1 allowances will be deemed to be held or distributed in accordance with the contract.

CSAPR NO_x Ozone Season Group 2 Trading Program

I certify that I was selected as the designated representative or alternate designated representative, as applicable, by an agreement binding on the owners and operators of the source and each CSAPR NO_x Ozone Season Group 2 unit at the source.

I certify that I have all the necessary authority to carry out my duties and responsibilities under the CSAPR NO_x Ozone Season Group 2 Trading Program on behalf of the owners and operators of the source and of each CSAPR NO_x Ozone Season Group 2 unit at the source and that each such owner and operator shall be fully bound by my representations, actions, inactions, or submissions and by any decision or order issued to me by the Administrator regarding the source or unit.

Where there are multiple holders of a legal or equitable title to, or a leasehold interest in, a CSAPR NO_x Ozone Season Group 2 unit, or where a utility or industrial customer purchases power from a CSAPR NO_x Ozone Season Group 2 unit under a life-of-the-unit, firm power contractual arrangement, I certify that: I have given a written notice of my selection as the 'designated representative' or 'alternate designated representative', as applicable, and of the agreement by which I was selected to each owner and operator of the source and of each CSAPR NO_x Ozone Season Group 2 unit at the source; and CSAPR NO_x Ozone Season Group 2 allowances and proceeds of transactions involving CSAPR NO_x Ozone Season Group 2 allowances will be deemed to be held or distributed in proportion to each holder's legal, equitable, leasehold, or contractual reservation or entitlement, except that, if such multiple holders have expressly provided for a different distribution of CSAPR NO_x Ozone Season Group 2 allowances by contract, CSAPR NO_x Ozone Season Group 2 allowances and proceeds of transactions involving CSAPR NO_x Ozone Season Group 2 allowances will be deemed to be held or distributed in accordance with the contract.

CSAPR NO_x Ozone Season Group 3 Trading Program

I certify that I was selected as the designated representative or alternate designated representative, as applicable, by an agreement binding on the owners and operators of the source and each CSAPR NO_x Ozone Season Group 3 unit at the source.

I certify that I have all the necessary authority to carry out my duties and responsibilities under the CSAPR NO_x Ozone Season Group 3 Trading Program on behalf of the owners and operators of the source and of each CSAPR NO_x Ozone Season Group 3 unit at the source and that each such owner and operator shall be fully bound by my representations, actions, inactions, or submissions and by any decision or order issued to me by the Administrator regarding the source or unit.

Where there are multiple holders of a legal or equitable title to, or a leasehold interest in, a CSAPR NO_x Ozone Season Group 3 unit, or where a utility or industrial customer purchases power from a CSAPR NO_x Ozone Season Group 3 unit under a life of the unit, firm power contractual arrangement, I certify that: I have given a written notice of my selection as the designated representative or alternate designated representative, as applicable, and of the agreement by which I was selected to each owner and operator of the source and of each CSAPR NO_x Ozone Season Group 3 unit at the source; and CSAPR NO_x Ozone Season Group 3 allowances and proceeds of transactions involving CSAPR NO_x Ozone Season Group 3 allowances will be deemed to be held or distributed in proportion to each holder's legal, equitable, leasehold, or contractual reservation or entitlement, except that, if such multiple holders have expressly provided for a different distribution of CSAPR NO_x Ozone Season Group 3 allowances by contract, CSAPR NO_x Ozone Season Group 3 allowances and proceeds of transactions involving CSAPR NO_x Ozone Season Group 3 allowances will be deemed to be held or distributed in accordance with the contract.

CSAPR SO₂ Group 1 Trading Program

I certify that I was selected as the designated representative or alternate designated representative, as applicable, by an agreement binding on the owners and operators of the source and each CSAPR SO₂ Group 1 unit at the source.

I certify that I have all the necessary authority to carry out my duties and responsibilities under the CSAPR SO₂ Group 1 Trading Program on behalf of the owners and operators of the source and of each CSAPR SO₂ Group 1 unit at the source and that each such owner and operator shall be fully bound by my representations, actions, inactions, or submissions and by any decision or order issued to me by the Administrator regarding the source or unit.

Where there are multiple holders of a legal or equitable title to, or a leasehold interest in, a CSAPR SO₂ Group 1 unit, or where a utility or industrial customer purchases power from a CSAPR SO₂ Group 1 unit under a life-of-the-unit, firm power contractual arrangement, I certify that: I have given a written notice of my selection as the 'designated representative' or 'alternate designated representative', as applicable, and of the agreement by which I was selected to each owner and operator of the source and of each CSAPR SO₂ Group 1 unit at the source; and CSAPR SO₂ Group 1 allowances and proceeds of transactions involving CSAPR SO₂ Group 1 allowances will be deemed to be held or distributed in proportion to each holder's legal, equitable, leasehold, or contractual reservation or entitlement, except that, if such multiple holders have expressly provided for a different distribution of CSAPR SO₂ Group 1 allowances by contract, CSAPR SO₂ Group 1 allowances and proceeds of transactions involving CSAPR SO₂ Group 1 allowances will be deemed to be held or distributed in accordance with the contract.

CSAPR SO₂ Group 2 Trading Program

I certify that I was selected as the designated representative or alternate designated representative, as applicable, by an agreement binding on the owners and operators of the source and each CSAPR SO₂ Group 2 unit at the source.

I certify that I have all the necessary authority to carry out my duties and responsibilities under the CSAPR SO₂ Group 2 Trading Program on behalf of the owners and operators of the source and of each CSAPR SO₂ Group 2 unit at the source and that each such owner and operator shall be fully bound by my representations, actions, inactions, or submissions and by any decision or order issued to me by the Administrator regarding the source or unit.

Where there are multiple holders of a legal or equitable title to, or a leasehold interest in, a CSAPR SO₂ Group 2 unit, or where a utility or industrial customer purchases power from a CSAPR SO₂ Group 2 unit under a life-of-the-unit, firm power contractual arrangement, I certify that: I have given a written notice of my selection as the 'designated representative' or 'alternate designated representative', as applicable, and of the agreement by which I was selected to each owner and operator of the source and of each CSAPR SO₂ Group 2 unit at the source; and CSAPR SO₂ Group 2 allowances and proceeds of transactions involving CSAPR SO₂ Group 2 allowances will be deemed to be held or distributed in proportion to each holder's legal, equitable, leasehold, or contractual reservation or entitlement, except that, if such multiple holders have expressly provided for a different distribution of CSAPR SO₂ Group 2 allowances by contract, CSAPR SO₂ Group 2 allowances and proceeds of transactions involving CSAPR SO₂ Group 2 allowances will be deemed to be held or distributed in accordance with the contract.

Texas SO₂ Trading Program

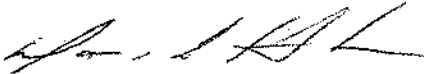
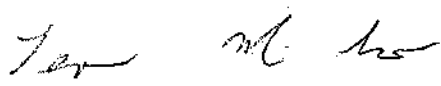
I certify that I was selected as the designated representative or alternate designated representative, as applicable, by an agreement binding on the owners and operators of the source and each Texas SO₂ Trading Program unit at the source.

I certify that I have all the necessary authority to carry out my duties and responsibilities under the Texas SO₂ Trading Program on behalf of the owners and operators of the source and of each Texas SO₂ Trading Program unit at the source and that each such owner and operator shall be fully bound by my representations, actions, inactions, or submissions and by any decision or order issued to me by the Administrator regarding the source or unit.

Where there are multiple holders of a legal or equitable title to, or a leasehold interest in, a Texas SO₂ Trading Program unit, or where a utility or industrial customer purchases power from a Texas SO₂ Trading Program unit under a life-of-the-unit, firm power contractual arrangement, I certify that: I have given a written notice of my selection as the 'designated representative' or 'alternate designated representative', as applicable, and of the agreement by which I was selected to each owner and operator of the source and of each Texas SO₂ Trading Program unit at the source; and Texas SO₂ Trading Program allowances and proceeds of transactions involving Texas SO₂ Trading Program allowances will be deemed to be held or distributed in proportion to each holder's legal, equitable, leasehold, or contractual reservation or entitlement, except that, if such multiple holders have expressly provided for a different distribution of Texas SO₂ Trading Program allowances by contract, Texas SO₂ Trading Program allowances and proceeds of transactions involving Texas SO₂ Trading Program allowances will be deemed to be held or distributed in accordance with the contract.

General

I am authorized to make this submission on behalf of the owners and operators of the source or units for which the submission is made. I certify under penalty of law that I have personally examined, and am familiar with, the statements and information submitted in this document and all its attachments. Based on my inquiry of those individuals with primary responsibility for obtaining the information, I certify that the statements and information are to the best of my knowledge and belief true, accurate, and complete. I am aware that there are significant penalties for submitting false statements and information or omitting required statements and information, including the possibility of fine or imprisonment.

 Signature (Designated Representative)	3/15/2022 Date
 Signature (Alternate Designated Representative)	3/15/2022 Date



Form OP-ACPS

**Texas Commission on Environmental Quality
Form OP-ACPS
Application Compliance Plan and Schedule**

Date: 04/23/2026	Regulated Entity No.: RN106392624	Permit No.: O3670
Company Name: El Paso Electric Company		Area Name: Montana Power Station

- Part 1 of this form must be submitted with all initial FOP applications and renewal applications.
- The Responsible Official must use Form OP-CRO1 (Certification by Responsible Official) to certify information contained in this form in accordance with 30 TAC § 122.132(d)(8).

Part 1

A. Compliance Plan — Future Activity Committal Statement	
<p>The <i>Responsible Official</i> commits, utilizing reasonable effort, to the following: As the responsible official it is my intent that all emission units shall continue to be in compliance with all applicable requirements they are currently in compliance with, and all emission units shall be in compliance by the compliance dates with any applicable requirements that become effective during the permit term.</p>	
B. Compliance Certification - Statement for Units in Compliance* (Indicate response by entering an "X" in the appropriate column)	
1. With the exception of those emission units listed in the Compliance Schedule section of this form (Part 2, below), and based, at minimum, on the compliance method specified in the associated applicable requirements, are all emission units addressed in this application in compliance with all their respective applicable requirements as identified in this application?	<input checked="" type="checkbox"/> YES <input type="checkbox"/> NO
2. Are there any non-compliance situations addressed in the Compliance Schedule Section of this form (Part 2)?	<input type="checkbox"/> YES <input checked="" type="checkbox"/> NO
3. If the response to Item B.2, above, is "Yes," indicate the total number of Part 2 attachments included in this submittal. <i>(For reference only)</i>	
<p>* For Site Operating Permits (SOPs), the complete application should be consulted for applicable requirements and their corresponding emission units when assessing compliance status. For General Operating Permits (GOPs), the application documentation, particularly Form OP-REQ1 should be consulted as well as the requirements contained in the appropriate General Permits portion of 30 TAC Chapter 122.</p> <p>Compliance should be assessed based, at a minimum, on the required monitoring, testing, record keeping, and/or reporting requirements, as appropriate, associated with the applicable requirement in question.</p>	

amin



Form OP-REQ1

Application Area-Wide Applicability Determinations and General Information
Form OP-REQ1 (Page 1)
Federal Operating Permit Program
Texas Commission on Environmental Quality

Date	Permit No.	Regulated Entity No.
04/23/2026	O3670	RN106392624

For SOP applications, answer ALL questions unless otherwise directed.

- ◆ For GOP applications, answer ONLY these questions unless otherwise directed.
- ◆

I. Title 30 TAC Chapter 111 - Control of Air Pollution from Visible Emissions and		
A. Visible Emissions		
◆	1. The application area includes stationary vents constructed on or before January 31, 1972.	<input type="checkbox"/> Yes <input checked="" type="checkbox"/> No
◆	2. The application area includes stationary vents constructed after January 31, 1972. <i>If the responses to Questions I.A.1 and I.A.2 are both "No," go to Question I.A.6. If the response to Question I.A.1 is "No" and the response to Question I.A.2 is "Yes," go to Question I.A.4.</i>	<input checked="" type="checkbox"/> Yes <input type="checkbox"/> No
◆	3. The application area is opting to comply with the requirements for stationary vents constructed after January 31, 1972 for vents in the application area constructed on or before January 31, 1972.	<input type="checkbox"/> Yes <input type="checkbox"/> No
◆	4. All stationary vents are addressed on a unit specific basis.	<input type="checkbox"/> Yes <input checked="" type="checkbox"/> No
◆	5. Test Method 9 (40 CFR Part 60, Appendix A, Method 9 - Visual Determination of the Opacity of Emissions from Stationary Sources) is used to determine opacity of emissions in the application area.	<input checked="" type="checkbox"/> Yes <input type="checkbox"/> No
◆	6. The application area includes structures subject to 30 TAC § 111.111(a)(7)(A).	<input checked="" type="checkbox"/> Yes <input type="checkbox"/> No
◆	7. The application area includes sources, other than those specified in 30 TAC § 111.111(a)(1), (4), or (7), subject to 30 TAC § 111.111(a)(8)(A).	<input type="checkbox"/> Yes <input checked="" type="checkbox"/> No
◆	8. Emissions from units in the application area include contributions from uncombined water.	<input checked="" type="checkbox"/> Yes <input type="checkbox"/> No
◆	9. The application area is located in the City of El Paso, including Fort Bliss Military Reservation, and includes solid fuel heating devices subject to 30 TAC § 111.111(c).	<input type="checkbox"/> Yes <input checked="" type="checkbox"/> No <input type="checkbox"/> N/A

Application Area-Wide Applicability Determinations and General Information
Form OP-REQ1 (Page 2)
Federal Operating Permit Program
Texas Commission on Environmental Quality

Date	Permit No.	Regulated Entity No.
04/23/2026	O3670	RN106392624

For SOP applications, answer ALL questions unless otherwise directed.

◆ For GOP applications, answer ONLY these questions unless otherwise directed.

I. Title 30 TAC Chapter 111 - Control of Air Pollution from Visible Emissions and Particulate Matter (continued)		
B. Materials Handling, Construction, Roads, Streets, Alleys, and Parking Lots		
1. Items a - d determine applicability of any of these requirements based on geographical location.		
◆	a. The application area is located within the city of El Paso.	<input type="checkbox"/> Yes <input checked="" type="checkbox"/> No
◆	b. The application area is located within the Fort Bliss Military Reservation, except areas specified in 30 TAC § 111.141.	<input type="checkbox"/> Yes <input checked="" type="checkbox"/> No
◆	c. The application area is located in the portion of Harris County inside the loop formed by Beltway 8.	<input type="checkbox"/> Yes <input checked="" type="checkbox"/> No
◆	d. The application area is located in the area of Nueces County outlined in Group II state implementation plan (SIP) for inhalable particulate matter adopted by the TCEQ on May 13, 1988.	<input type="checkbox"/> Yes <input checked="" type="checkbox"/> No
<i>If there is any "Yes" response to Questions I.B.1.a - d, answer Questions I.B.2.a - d. If all responses to Questions I.B.1.a-d are "No," go to Section I.C.</i>		
2. Items a - d determine the specific applicability of these requirements.		
◆	a. The application area is subject to 30 TAC § 111.143.	<input type="checkbox"/> Yes <input type="checkbox"/> No
◆	b. The application area is subject to 30 TAC § 111.145.	<input type="checkbox"/> Yes <input type="checkbox"/> No
◆	c. The application area is subject to 30 TAC § 111.147.	<input type="checkbox"/> Yes <input type="checkbox"/> No
◆	d. The application area is subject to 30 TAC § 111.149.	<input type="checkbox"/> Yes <input type="checkbox"/> No
C. Emissions Limits on Nonagricultural Processes		
◆	1. The application area includes a nonagricultural process subject to 30 TAC § 111.151.	<input checked="" type="checkbox"/> Yes <input type="checkbox"/> No
	2. The application area includes a vent from a nonagricultural process that is subject to additional monitoring requirements. <i>If the response to Question I.C.2 is "No," go to Question I.C.4.</i>	<input type="checkbox"/> Yes <input checked="" type="checkbox"/> No
	3. All vents from nonagricultural process in the application area are subject to additional monitoring requirements.	<input type="checkbox"/> Yes <input type="checkbox"/> No

Application Area-Wide Applicability Determinations and General Information
Form OP-REQ1 (Page 3)
Federal Operating Permit Program
Texas Commission on Environmental Quality

Date	Permit No.	Regulated Entity No.
04/23/2026	O3670	RN106392624

For SOP applications, answer ALL questions unless otherwise directed.

◆ For GOP applications, answer ONLY these questions unless otherwise directed.

I. Title 30 TAC Chapter 111 - Control of Air Pollution from Visible Emissions and Particulate Matter (continued)		
C. Emissions Limits on Nonagricultural Processes (continued)		
4.	The application area includes oil or gas fuel-fired steam generators subject to 30 TAC §§ 111.153(a) and 111.153(c).	<input type="checkbox"/> Yes <input checked="" type="checkbox"/> No
5.	The application area includes oil or gas fuel-fired steam generators that are subject to additional monitoring requirements. <i>If the response to Question I.C.5 is "No," go to Question I.C.7.</i>	<input type="checkbox"/> Yes <input checked="" type="checkbox"/> No
6.	All oil or gas fuel-fired steam generators in the application area are subject to additional monitoring requirements.	<input type="checkbox"/> Yes <input type="checkbox"/> No
7.	The application area includes solid fossil fuel-fired steam generators subject to 30 TAC §§ 111.153(a) and 111.153(b).	<input type="checkbox"/> Yes <input checked="" type="checkbox"/> No
8.	The application area includes solid fossil fuel-fired steam generators that are subject to additional monitoring requirements. <i>If the response to Question I.C.8 is "No," go to Section I.D.</i>	<input type="checkbox"/> Yes <input checked="" type="checkbox"/> No
9.	All solid fossil fuel-fired steam generators in the application area are subject to additional monitoring requirements.	<input type="checkbox"/> Yes <input type="checkbox"/> No
D. Emissions Limits on Agricultural Processes		
1.	The application area includes agricultural processes subject to 30 TAC § 111.171.	<input type="checkbox"/> Yes <input checked="" type="checkbox"/> No
E. Outdoor Burning		
◆ 1.	Outdoor burning is conducted in the application area. <i>If the response to Question I.E.1 is "No," go to Section II.</i>	<input type="checkbox"/> Yes <input checked="" type="checkbox"/> No
◆ 2.	Fire training is conducted in the application area and subject to the exception provided in 30 TAC § 111.205.	<input type="checkbox"/> Yes <input type="checkbox"/> No
◆ 3.	Fires for recreation, ceremony, cooking, and warmth are used in the application area and subject to the exception provided in 30 TAC § 111.207.	<input type="checkbox"/> Yes <input type="checkbox"/> No
◆ 4.	Disposal fires are used in the application area and subject to the exception provided in 30 TAC § 111.209.	<input type="checkbox"/> Yes <input type="checkbox"/> No

Application Area-Wide Applicability Determinations and General Information
Form OP-REQ1 (Page 4)
Federal Operating Permit Program
Texas Commission on Environmental Quality

Date	Permit No.	Regulated Entity No.
04/23/2026	O3670	RN106392624

For SOP applications, answer ALL questions unless otherwise directed.

◆ For GOP applications, answer ONLY these questions unless otherwise directed.

I. Title 30 TAC Chapter 111 - Control of Air Pollution from Visible Emissions and Particulate Matter (continued)		
E. Outdoor Burning (continued)		
◆	5. Prescribed burning is used in the application area and subject to the exception provided in 30 TAC § 111.211.	<input type="checkbox"/> Yes <input type="checkbox"/> No
◆	6. Hydrocarbon burning is used in the application area and subject to the exception provided in 30 TAC § 111.213.	<input type="checkbox"/> Yes <input type="checkbox"/> No
◆	7. The application area has received the TCEQ Executive Director approval of otherwise prohibited outdoor burning according to 30 TAC § 111.215.	<input type="checkbox"/> Yes <input type="checkbox"/> No
II. Title 30 TAC Chapter 112 - Control of Air Pollution from Sulfur Compounds		
A. Temporary Fuel Shortage Plan Requirements		
	1. The application area includes units that are potentially subject to the temporary fuel shortage plan requirements of 30 TAC §§ 112.15 - 112.18.	<input checked="" type="checkbox"/> Yes <input type="checkbox"/> No
III. Title 30 TAC Chapter 115 - Control of Air Pollution from Volatile Organic Compounds		
A. Applicability		
◆	1. The application area is located in the Houston/Galveston/Brazoria area, Beaumont/Port Arthur area, Dallas/Fort Worth area, El Paso area, or a covered attainment county as defined by 30 TAC § 115.10. <i>See instructions for inclusive counties. If the response to Question III.A.1 is "No," go to Section IV.</i>	<input checked="" type="checkbox"/> Yes <input type="checkbox"/> No
B. Storage of Volatile Organic Compounds		
◆	1. The application area includes storage tanks, reservoirs, or other containers capable of maintaining working pressure sufficient at all times to prevent any VOC vapor or gas loss to the atmosphere.	<input checked="" type="checkbox"/> Yes <input type="checkbox"/> No

Application Area-Wide Applicability Determinations and General Information
Form OP-REQ1 (Page 5)
Federal Operating Permit Program
Texas Commission on Environmental Quality

Date	Permit No.	Regulated Entity No.
04/23/2026	O3670	RN106392624

For SOP applications, answer ALL questions unless otherwise directed.

◆ For GOP applications, answer ONLY these questions unless otherwise directed.

III. Title 30 TAC Chapter 115 - Control of Air Pollution from Volatile Organic Compounds (continued)		
C. Industrial Wastewater		
1.	The application area includes affected VOC wastewater streams of an affected source category, as defined in 30 TAC § 115.140. <i>If the response to Question III.C.1 is "No" or "N/A," go to Section III.D.</i>	<input type="checkbox"/> Yes <input checked="" type="checkbox"/> No <input type="checkbox"/> N/A
2.	The application area is located at a petroleum refinery in the Beaumont/Port Arthur or Houston/Galveston/Brazoria area. <i>If the response to Question III.C.2 is "Yes" and the refinery is in the Beaumont/Port Arthur area, go to Section III.D.</i>	<input type="checkbox"/> Yes <input type="checkbox"/> No
3.	The application area is complying with the provisions of 40 CFR Part 63, Subpart G, as an alternative to complying with this division (relating to Industrial Wastewater). <i>If the response to Question III.C.3 is "Yes," go to Section III.D.</i>	<input type="checkbox"/> Yes <input type="checkbox"/> No
4.	The application area is located at a plant with an annual VOC loading in wastewater, as determined in accordance with 30 TAC § 115.148, less than or equal to 10 Mg (11.03 tons). <i>If the response to Question III.C.4 is "Yes," go to Section III.D.</i>	<input type="checkbox"/> Yes <input type="checkbox"/> No
5.	The application area includes wastewater drains, junction boxes, lift stations, or weirs that are subject to the control requirements of 30 TAC § 115.142(1).	<input type="checkbox"/> Yes <input type="checkbox"/> No
6.	The application area includes wastewater drains, junction boxes, lift stations, or weirs that handle streams chosen for exemption under 30 TAC § 115.147(2).	<input type="checkbox"/> Yes <input type="checkbox"/> No
7.	The application area includes wastewater drains, junction boxes, lift stations, or weirs that have an executive director approved exemption under 30 TAC § 115.147(4).	<input type="checkbox"/> Yes <input type="checkbox"/> No
D. Loading and Unloading of VOCs		
◆ 1.	The application area includes VOC loading operations.	<input checked="" type="checkbox"/> Yes <input type="checkbox"/> No
◆ 2.	The application area includes VOC transport vessel unloading operations. <i>For GOP applications, if the responses to Questions III.D.1 - D.2 are "No," go to Section III.E.</i>	<input checked="" type="checkbox"/> Yes <input type="checkbox"/> No

Application Area-Wide Applicability Determinations and General Information
Form OP-REQ1 (Page 6)
Federal Operating Permit Program
Texas Commission on Environmental Quality

Date	Permit No.	Regulated Entity No.
04/23/2026	O3670	RN106392624

For SOP applications, answer ALL questions unless otherwise directed.

◆ For GOP applications, answer ONLY these questions unless otherwise directed.

III. Title 30 TAC Chapter 115 - Control of Air Pollution from Volatile Organic Compounds (continued)		
D. Loading and Unloading of VOCs (continued)		
◆	3. Transfer operations at motor vehicle fuel dispensing facilities are the only VOC transfer operations conducted in the application area.	<input type="checkbox"/> Yes <input checked="" type="checkbox"/> No
E. Filling of Gasoline Storage Vessels (Stage I) for Motor Vehicle Fuel Dispensing Facilities		
◆	1. The application area includes one or more motor vehicle fuel dispensing facilities and gasoline is transferred from a tank-truck tank into a stationary storage container. <i>If the response to Question III.E.1 is "No," go to Section III.F.</i>	<input checked="" type="checkbox"/> Yes <input type="checkbox"/> No
◆	2. Transfers to stationary storage containers used exclusively for the fueling of agricultural implements are the only transfer operations conducted at facilities in the application area.	<input type="checkbox"/> Yes <input checked="" type="checkbox"/> No
◆	3. All transfers at facilities in the application area are made into stationary storage containers with internal floating roofs, external floating roofs, or their equivalent. <i>If the response to Question III.E.2 and/or E.3 is "Yes," go to Section III.F.</i>	<input type="checkbox"/> Yes <input checked="" type="checkbox"/> No
◆	4. The application area is located in a covered attainment county as defined in 30 TAC § 115.10. <i>If the response to Question III.E.4 is "No," go to Question III.E.9.</i>	<input type="checkbox"/> Yes <input checked="" type="checkbox"/> No
◆	5. Stationary gasoline storage containers with a nominal capacity less than or equal to 1,000 gallons are located at the facility.	<input type="checkbox"/> Yes <input type="checkbox"/> No
◆	6. Stationary gasoline storage containers with a nominal capacity greater than 1,000 gallons are located at the facility.	<input type="checkbox"/> Yes <input type="checkbox"/> No
◆	7. At facilities located in a covered attainment county other than Bastrop, Bexar, Caldwell, Comal, Guadalupe, Hays, Travis, Williamson, or Wilson County, transfers are made to stationary storage tanks greater than 1000 gallons located at a facility which has dispensed less than 100,000 gallons of gasoline in a calendar month after October 31, 2014. <i>If the response to Question III.E.7 is "Yes," go to Section III.F.</i>	<input type="checkbox"/> Yes <input type="checkbox"/> No

Application Area-Wide Applicability Determinations and General Information
Form OP-REQ1 (Page 7)
Federal Operating Permit Program
Texas Commission on Environmental Quality

Date	Permit No.	Regulated Entity No.
04/23/2026	O3670	RN106392624

For SOP applications, answer ALL questions unless otherwise directed.

◆ For GOP applications, answer ONLY these questions unless otherwise directed.

III. Title 30 TAC Chapter 115 - Control of Air Pollution from Volatile Organic Compounds (continued)		
E. Filling of Gasoline Storage Vessels (Stage I) for Motor Vehicle Fuel Dispensing Facilities (continued)		
◆	8. At facilities located in Bastrop, Bexar, Caldwell, Comal, Guadalupe, Hays, Travis, Williamson, or Wilson County, transfers are made to stationary storage tanks greater than 1000 gallons located at a facility which has dispensed no more than 25,000 gallons of gasoline in a calendar month after December 31, 2004. <i>If the response to Question III.E.8 is "Yes," go to Section III.F.</i>	<input type="checkbox"/> Yes <input type="checkbox"/> No
◆	9. Transfers are made to stationary storage tanks located at a motor vehicle fuel dispensing facility which has dispensed no more than 10,000 gallons of gasoline in any calendar month after January 1, 1991 and for which construction began prior to November 15, 1992.	<input type="checkbox"/> Yes <input checked="" type="checkbox"/> No
◆	10. Transfers are made to stationary storage tanks located at a motor vehicle fuel dispensing facility which has dispensed more than 10,000 gallons of gasoline in any calendar month after January 1, 1991 and for which construction began prior to November 15, 1992.	<input type="checkbox"/> Yes <input checked="" type="checkbox"/> No
◆	11. Transfers are made to stationary storage tanks located at a motor vehicle fuel dispensing facility which commenced construction on or after November 15, 1992.	<input checked="" type="checkbox"/> Yes <input type="checkbox"/> No
◆	12. At facilities located in Ellis, Johnson, Kaufman, Parker, or Rockwall County, transfers are made to stationary storage tanks located at a facility which has dispensed at least 10,000 gallons of gasoline but less than 125,000 gallons of gasoline in a calendar month after April 30, 2005.	<input type="checkbox"/> Yes <input checked="" type="checkbox"/> No
F. Control of VOC Leaks from Transport Vessels (Complete this section for GOP applications for GOPs 511, 512, 513 and 514 only)		
◆	1. Tank-truck tanks are filled with, or emptied of, gasoline at a facility that is subject to 30 TAC § 115.214(a)(1)(C) or 115.224(2) within the application area.	<input type="checkbox"/> Yes <input type="checkbox"/> No <input type="checkbox"/> N/A

Application Area-Wide Applicability Determinations and General Information
Form OP-REQ1 (Page 8)
Federal Operating Permit Program
Texas Commission on Environmental Quality

Date	Permit No.	Regulated Entity No.
04/23/2026	O3670	RN106392624

For SOP applications, answer ALL questions unless otherwise directed.

◆ For GOP applications, answer ONLY these questions unless otherwise directed.

III. Title 30 TAC Chapter 115 - Control of Air Pollution from Volatile Organic Compounds		
F. Control of VOC Leaks from Transport Vessels (Complete this section for GOP applications for GOPs 511, 512, 513 and 514 only) (continued)		
◆	2. Tank-truck tanks are filled with non-gasoline VOCs having a TVP greater than or equal to 0.5 psia under actual storage conditions at a facility subject to 30 TAC § 115.214(a)(1)(C) within the application area.	<input type="checkbox"/> Yes <input type="checkbox"/> No <input type="checkbox"/> N/A
◆	3. Tank-truck tanks are filled with, or emptied of, gasoline at a facility that is subject to 30 TAC § 115.214(b)(1)(C) or 115.224(2) within the application area.	<input type="checkbox"/> Yes <input type="checkbox"/> No <input type="checkbox"/> N/A
G. Control of Vehicle Refueling Emissions (Stage II) at Motor Vehicle Fuel Dispensing Facilities		
◆	1. The application area includes one or more motor vehicle fuel dispensing facilities and gasoline is transferred from a stationary storage container into motor vehicle fuel tanks. <i>If the response to Question III.G.1 is "No" or "N/A," go to Section III.H.</i>	<input checked="" type="checkbox"/> Yes <input type="checkbox"/> No <input type="checkbox"/> N/A
◆	2. The application area includes facilities that began construction on or after November 15, 1992 and prior to May 16, 2012.	<input checked="" type="checkbox"/> Yes <input type="checkbox"/> No
◆	3. The application area includes facilities that began construction prior to November 15, 1992. <i>If the responses to Questions III.G.2 and III.G.3 are both "No," go to Section III.H.</i>	<input type="checkbox"/> Yes <input checked="" type="checkbox"/> No
◆	4. The application area includes only facilities that have a monthly throughput of less than 10,000 gallons of gasoline.	<input checked="" type="checkbox"/> Yes <input type="checkbox"/> No
◆	5. The decommissioning of all Stage II vapor recovery control equipment located in the application area has been completed and the decommissioning notice submitted.	<input type="checkbox"/> Yes <input checked="" type="checkbox"/> No <input type="checkbox"/> N/A

Application Area-Wide Applicability Determinations and General Information
Form OP-REQ1 (Page 9)
Federal Operating Permit Program
Texas Commission on Environmental Quality

Date	Permit No.	Regulated Entity No.
04/23/2026	O3670	RN106392624

For SOP applications, answer ALL questions unless otherwise directed.

◆ For GOP applications, answer ONLY these questions unless otherwise directed.

III. Title 30 TAC Chapter 115 - Control of Air Pollution from Volatile Organic Compounds (continued)		
H. Control of Reid Vapor Pressure (RVP) of Gasoline		
◆	1. The application area includes stationary tanks, reservoirs, or other containers holding gasoline that may ultimately be used in a motor vehicle in El Paso County. <i>If the response to Question III.H.1 is "No" or "N/A," go to Section III.I.</i>	<input checked="" type="checkbox"/> Yes <input type="checkbox"/> No <input type="checkbox"/> N/A
◆	2. The application area includes stationary tanks, reservoirs, or other containers holding gasoline that will be used exclusively for the fueling of agricultural implements.	<input type="checkbox"/> Yes <input checked="" type="checkbox"/> No
◆	3. The application area includes a motor vehicle fuel dispensing facility.	<input checked="" type="checkbox"/> Yes <input type="checkbox"/> No
◆	4. The application area includes stationary tanks, reservoirs, or other containers holding gasoline and having a nominal capacity of 500 gallons or less.	<input type="checkbox"/> Yes <input checked="" type="checkbox"/> No
I. Process Unit Turnaround and Vacuum-Producing Systems in Petroleum Refineries		
	1. The application area is located at a petroleum refinery.	<input type="checkbox"/> Yes <input checked="" type="checkbox"/> No
J. Surface Coating Processes (Complete this section for GOP applications only.)		
◆	1. Surface coating operations (other than those performed on equipment located on-site and in-place) that meet the exemption specified in 30 TAC § 115.427(3)(A) or 115.427(7) are performed in the application area.	<input type="checkbox"/> Yes <input type="checkbox"/> No <input type="checkbox"/> N/A

Application Area-Wide Applicability Determinations and General Information
Form OP-REQ1 (Page 10)
Federal Operating Permit Program
Texas Commission on Environmental Quality

Date	Permit No.	Regulated Entity No.
04/23/2026	O3670	RN106392624

For SOP applications, answer ALL questions unless otherwise directed.

◆ For GOP applications, answer ONLY these questions unless otherwise directed.

III. Title 30 TAC Chapter 115 - Control of Air Pollution from Volatile Organic Compounds (continued)		
K. Cutback Asphalt		
1. Conventional cutback asphalt containing VOC solvents for the paving of roadways, driveways, or parking lots, is used or specified for use in the application area by a state, municipal, or county agency. <i>If the response to Question III.K.1 is "N/A," go to Section III.L.</i>	<input type="checkbox"/> Yes <input checked="" type="checkbox"/> No <input type="checkbox"/> N/A	
2. The use, application, sale, or offering for sale of conventional cutback asphalt containing VOC solvents for the paving of roadways, driveways, or parking lots occurs in the application area.	<input type="checkbox"/> Yes <input checked="" type="checkbox"/> No <input type="checkbox"/> N/A	
3. Asphalt emulsion is used or produced within the application area.	<input type="checkbox"/> Yes <input checked="" type="checkbox"/> No	
4. The application area is using an alternate control requirement as specified in 30 TAC § 115.513. <i>If the response to Question III.K.4 is "No," go to Section III.L.</i>	<input type="checkbox"/> Yes <input checked="" type="checkbox"/> No	
5. The application area uses, applies, sells, or offers for sale asphalt concrete, made with cutback asphalt, that meets the exemption specified in 30 TAC § 115.517(1).	<input type="checkbox"/> Yes <input type="checkbox"/> No	
6. The application area uses, applies, sells, or offers for sale cutback asphalt that is used solely as a penetrating prime coat.	<input type="checkbox"/> Yes <input type="checkbox"/> No	
7. The applicant using cutback asphalt is a state, municipal, or county agency.	<input type="checkbox"/> Yes <input type="checkbox"/> No	
L. Degassing of Storage Tanks, Transport Vessels and Marine Vessels		
◆ 1. The application area includes degassing operations for stationary, marine, and/or transport vessels. <i>If the response to Question III.L.1 is "No" or "N/A," go to Section III.M.</i>	<input type="checkbox"/> Yes <input checked="" type="checkbox"/> No <input type="checkbox"/> N/A	
◆ 2. Degassing of only ocean-going, self-propelled VOC marine vessels is performed in the application area. <i>If the response to Question III.L.2 is "Yes," go to Section III.M.</i>	<input type="checkbox"/> Yes <input type="checkbox"/> No <input type="checkbox"/> N/A	

Application Area-Wide Applicability Determinations and General Information
Form OP-REQ1 (Page 11)
Federal Operating Permit Program
Texas Commission on Environmental Quality

Date	Permit No.	Regulated Entity No.
04/23/2026	O3670	RN106392624

For SOP applications, answer ALL questions unless otherwise directed.

◆ For GOP applications, answer ONLY these questions unless otherwise directed.

III. Title 30 TAC Chapter 115 - Control of Air Pollution from Volatile Organic Compounds		
L. Degassing of Storage Tanks, Transport Vessels and Marine Vessels (continued)		
◆	3. Degassing of stationary VOC storage vessels with a nominal storage capacity of 1,000,000 gallons or more and a vapor space partial pressure greater than or equal to 0.5 psia of VOC is performed in the application area.	<input type="checkbox"/> Yes <input type="checkbox"/> No <input type="checkbox"/> N/A
◆	4. Degassing of stationary VOC storage vessels with a nominal storage capacity of 250,000 gallons or more, or a nominal storage capacity of 75,000 gallons and storing materials with a true vapor pressure greater than 2.6 psia, and a vapor space partial pressure greater than or equal to 0.5 psia of VOC is performed in the application area.	<input type="checkbox"/> Yes <input type="checkbox"/> No <input type="checkbox"/> N/A
◆	5. Degassing of VOC transport vessels with a nominal storage capacity of 8,000 gallons or more and a vapor space partial pressure greater than or equal to 0.5 psia of VOC is performed in the application area.	<input type="checkbox"/> Yes <input type="checkbox"/> No
◆	6. Degassing of VOC marine vessels with a nominal storage capacity of 10,000 barrels (420,000 gallons) or more and a vapor space partial pressure greater than or equal to 0.5 psia of VOC is performed in the application area.	<input type="checkbox"/> Yes <input type="checkbox"/> No <input type="checkbox"/> N/A
◆	7. Degassing of VOC marine vessels with a nominal storage capacity of 10,000 barrels (420,000 gallons) and a vapor space partial pressure \geq 0.5 psia that have sustained damage as specified in 30 TAC § 115.547(5) is performed in the application area.	<input type="checkbox"/> Yes <input type="checkbox"/> No <input type="checkbox"/> N/A
M. Petroleum Dry Cleaning Systems		
1.	The application area contains one or more petroleum dry cleaning facilities that use petroleum-based solvents.	<input type="checkbox"/> Yes <input checked="" type="checkbox"/> No <input type="checkbox"/> N/A

Application Area-Wide Applicability Determinations and General Information
Form OP-REQ1 (Page 12)
Federal Operating Permit Program
Texas Commission on Environmental Quality

Date	Permit No.	Regulated Entity No.
04/23/2026	O3670	RN106392624

For SOP applications, answer ALL questions unless otherwise directed.

◆ For GOP applications, answer ONLY these questions unless otherwise directed.

III. Title 30 TAC Chapter 115 - Control of Air Pollution from Volatile Organic Compounds (continued)		
N. Vent Gas Control (Highly Reactive Volatile Organic Compounds (HRVOC))		
1.	The application area includes one or more vent gas streams containing HRVOC.	<input type="checkbox"/> Yes <input checked="" type="checkbox"/> No <input type="checkbox"/> N/A
2.	The application area includes one or more flares that emit or have the potential to emit HRVOC. <i>If the responses to Questions III.N.1 and III.N.2 are both "No" or "N/A," go to Section III.O. If the response to Question III.N.1 is "Yes," continue with Question III.N.3.</i>	<input type="checkbox"/> Yes <input checked="" type="checkbox"/> No <input type="checkbox"/> N/A
3.	All vent streams in the application area that are routed to a flare contain less than 5.0% HRVOC by weight at all times.	<input type="checkbox"/> Yes <input type="checkbox"/> No
4.	All vent streams in the application area that are not routed to a flare contain less than 100 ppmv HRVOC at all times. <i>If the responses to Questions III.N.3 and III.N.4 are both "Yes," go to Section III.O.</i>	<input type="checkbox"/> Yes <input type="checkbox"/> No
5.	The application area contains pressure relief valves that are not controlled by a flare.	<input type="checkbox"/> Yes <input type="checkbox"/> No
6.	The application area has at least one vent stream which has no potential to emit HRVOC.	<input type="checkbox"/> Yes <input type="checkbox"/> No
7.	The application area has vent streams from a source described in 30 TAC § 115.727(c)(3)(A) - (H).	<input type="checkbox"/> Yes <input type="checkbox"/> No
O. Cooling Tower Heat Exchange Systems (HRVOC)		
1.	The application area includes one or more cooling tower heat exchange systems that emit or have the potential to emit HRVOC.	<input type="checkbox"/> Yes <input checked="" type="checkbox"/> No <input type="checkbox"/> N/A

Application Area-Wide Applicability Determinations and General Information
Form OP-REQ1 (Page 13)
Federal Operating Permit Program
Texas Commission on Environmental Quality

Date	Permit No.	Regulated Entity No.
04/23/2026	O3670	RN106392624

For SOP applications, answer ALL questions unless otherwise directed.

◆ For GOP applications, answer ONLY these questions unless otherwise directed.

IV. Title 30 TAC Chapter 117 - Control of Air Pollution from Nitrogen Compounds		
A. Applicability		
◆	<p>1. The application area is located in the Houston/Galveston/Brazoria, Beaumont/Port Arthur, or Dallas/Fort Worth Eight-Hour area. <i>For SOP applications, if the response to Question IV.A.1 is "Yes," complete Sections IV.B - IV.F and IV.H.</i> <i>For GOP applications for GOPs 511, 512, 513, or 514, if the response to Question IV.A.1 is "Yes," go to Section IV.F.</i> <i>For GOP applications for GOP 517, if the response to Question IV.A.1 is "Yes," complete Sections IV.C and IV.F.</i> <i>For GOP applications, if the response to Question IV.A.1 is "No," go to Section VI.</i></p>	<input type="checkbox"/> Yes <input checked="" type="checkbox"/> No
	<p>2. The application area is located in Bexar, Comal, Ellis, Hays, or McLennan County and includes a cement kiln. <i>If the response to Question IV.A.2 is "Yes," go to Question IV.H.1.</i></p>	<input type="checkbox"/> Yes <input checked="" type="checkbox"/> No
	<p>3. The application area includes a utility electric generator in an east or central Texas county. <i>See instructions for a list of counties included.</i> <i>If the response to Question IV.A.3 is "Yes," go to Question IV.G.1.</i> <i>If the responses to Questions IV.A.1 - 3 are all "No," go to Question IV.H.1.</i></p>	<input type="checkbox"/> Yes <input checked="" type="checkbox"/> No
B. Utility Electric Generation in Ozone Nonattainment Areas		
	<p>1. The application area includes units specified in 30 TAC §§ 117.1000, 117.1200, or 117.1300. <i>If the response to Question IV.B.1 is "No," go to Question IV.C.1.</i></p>	<input type="checkbox"/> Yes <input type="checkbox"/> No
	<p>2. The application area is complying with a System Cap in 30 TAC §§ 117.1020 or 117.1220.</p>	<input type="checkbox"/> Yes <input type="checkbox"/> No

Application Area-Wide Applicability Determinations and General Information
Form OP-REQ1 (Page 14)
Federal Operating Permit Program
Texas Commission on Environmental Quality

Date	Permit No.	Regulated Entity No.
04/23/2026	O3670	RN106392624

For SOP applications, answer ALL questions unless otherwise directed.

◆ For GOP applications, answer ONLY these questions unless otherwise directed.

IV. Title 30 TAC Chapter 117 - Control of Air Pollution from Nitrogen Compounds (continued)		
C. Commercial, Institutional, and Industrial Sources in Ozone Nonattainment Areas		
◆	1. The application area is located at a site subject to 30 TAC Chapter 117, Subchapter B and includes units specified in 30 TAC §§ 117.100, 117.300, or 117.400. <i>For SOP applications, if the response to Question IV.C.1 is "No," go to Question IV.D.1. For GOP applications for GOP 517, if the response to Question IV.C.1 is "No," go to Section IV.F.</i>	<input type="checkbox"/> Yes <input type="checkbox"/> No
◆	2. The application area is located at a site that was a major source of NO _x before November 15, 1992.	<input type="checkbox"/> Yes <input type="checkbox"/> No <input type="checkbox"/> N/A
◆	3. The application area includes an electric generating facility required to comply with the System Cap in 30 TAC § 117.320.	<input type="checkbox"/> Yes <input type="checkbox"/> No
D. Adipic Acid Manufacturing		
1.	The application area is located at, or part of, an adipic acid production unit.	<input type="checkbox"/> Yes <input type="checkbox"/> No <input type="checkbox"/> N/A
E. Nitric Acid Manufacturing - Ozone Nonattainment Areas		
1.	The application area is located at, or part of, a nitric acid production unit.	<input type="checkbox"/> Yes <input type="checkbox"/> No <input type="checkbox"/> N/A
F. Combustion Control at Minor Sources in Ozone Nonattainment Areas - Boilers, Process Heaters, Stationary Engines and Gas Turbines		
◆	1. The application area is located at a site that is a minor source of NO _x in the Houston/Galveston/Brazoria or Dallas/Fort Worth Eight-Hour areas (except for Wise County). <i>For SOP applications, if the response to Question IV.F.1 is "No," go to Question IV.G.1. For GOP applications, if the response to Question IV.F.1 is "No," go to Section VI.</i>	<input type="checkbox"/> Yes <input type="checkbox"/> No
◆	2. The application area is located in the Houston/Galveston/Brazoria area and has units that qualify for an exemption under 30 TAC § 117.2003(a).	<input type="checkbox"/> Yes <input type="checkbox"/> No
◆	3. The application area is located in the Houston/Galveston/Brazoria area and has units that qualify for an exemption under 30 TAC § 117.2003(b).	<input type="checkbox"/> Yes <input type="checkbox"/> No

Application Area-Wide Applicability Determinations and General Information
Form OP-REQ1 (Page 15)
Federal Operating Permit Program
Texas Commission on Environmental Quality

Date	Permit No.	Regulated Entity No.
04/23/2026	O3670	RN106392624

For SOP applications, answer ALL questions unless otherwise directed.

◆ For GOP applications, answer ONLY these questions unless otherwise directed.

IV. Title 30 TAC Chapter 117 - Control of Air Pollution from Nitrogen Compounds (continued)		
F. Combustion Control at Minor Sources in Ozone Nonattainment Areas - Boilers, Process Heaters, Stationary Engines and Gas Turbines (continued)		
◆	4. The application area is located in the Dallas/Fort Worth Eight-Hour area (except for Wise County) and has units that qualify for an exemption under 30 TAC § 117.2103.	<input type="checkbox"/> Yes <input type="checkbox"/> No
◆	5. The application area has units subject to the emission specifications under 30 TAC §§ 117.2010 or 30 TAC § 117.2110.	<input type="checkbox"/> Yes <input type="checkbox"/> No
	6. The application area has a unit that has been approved for alternative case specific specifications (ACSS) in 30 TAC § 117.2025 or 30 TAC § 117.2125. <i>If the response to Question IV.F.6 is "No," go to Section IV.G.</i>	<input type="checkbox"/> Yes <input type="checkbox"/> No
	7. An ACSS for carbon monoxide (CO) has been approved?	<input type="checkbox"/> Yes <input type="checkbox"/> No
	8. An ACSS for ammonia (NH ₃) has been approved?	<input type="checkbox"/> Yes <input type="checkbox"/> No
	9. Provide the Permit Number(s) and authorization/issuance date(s) of the NSR project(s) that incorporates an ACSS below.	
G. Utility Electric Generation in East and Central Texas		
	1. The application area includes utility electric power boilers and/or stationary gas turbines (including duct burners used in turbine exhaust ducts) that were placed into service before December 31, 1995. <i>If the response to Question IV.G.1 is "No," go to Question IV.H.1.</i>	<input type="checkbox"/> Yes <input type="checkbox"/> No
	2. The application area is complying with the System Cap in 30 TAC § 117.3020.	<input type="checkbox"/> Yes <input type="checkbox"/> No
H. Multi-Region Combustion Control - Water Heaters, Small Boilers, and Process Heaters		
	1. The application area includes a manufacturer, distributor, retailer or installer of natural gas fired water heaters, boilers or process heaters with a maximum rated capacity of 2.0 MMBtu/hr or less. <i>If the response to question IV.H.1 is "No," go to Section V.</i>	<input type="checkbox"/> Yes <input checked="" type="checkbox"/> No
	2. All water heaters, boilers or process heaters manufactured, distributed, retailed or installed qualify for an exemption under 30 TAC § 117.3203.	<input type="checkbox"/> Yes <input type="checkbox"/> No

Application Area-Wide Applicability Determinations and General Information
Form OP-REQ1 (Page 16)
Federal Operating Permit Program
Texas Commission on Environmental Quality

Date	Permit No.	Regulated Entity No.
04/23/2026	O3670	RN106392624

For SOP applications, answer ALL questions unless otherwise directed.

◆ For GOP applications, answer ONLY these questions unless otherwise directed.

V. Title 40 Code of Federal Regulations Part 59 (40 CFR Part 59) - National Volatile Organic Compound Emission Standards for Consumer and Commercial Products	
A. Subpart B - National Volatile Organic Compound Emission Standards for Automobile Refinish Coatings	
1. The application area manufactures automobile refinish coatings or coating components and sells or distributes these coatings or coating components in the United States.	<input type="checkbox"/> Yes <input checked="" type="checkbox"/> No
2. The application area imports automobile refinish coatings or coating components, manufactured on or after January 11, 1999, and sells or distributes these coatings or coating components in the United States. <i>If the responses to Questions V.A.1 and V.A.2 are both "No," go to Section V.B.</i>	<input type="checkbox"/> Yes <input checked="" type="checkbox"/> No
3. All automobile refinish coatings or coating components manufactured or imported by the application area meet one or more of the exemptions specified in 40 CFR § 59.100(c)(1) - (6).	<input type="checkbox"/> Yes <input type="checkbox"/> No
B. Subpart C - National Volatile Organic Compound Emission Standards for Consumer Products	
1. The application area manufactures consumer products for sale or distribution in the United States.	<input type="checkbox"/> Yes <input checked="" type="checkbox"/> No
2. The application area imports consumer products manufactured on or after December 10, 1998 and sells or distributes these consumer products in the United States.	<input type="checkbox"/> Yes <input checked="" type="checkbox"/> No
3. The application area is a distributor of consumer products whose name appears on the label of one or more of the products. <i>If the responses to Questions V.B.1 - V.B.3 are all "No," go to Section V.C.</i>	<input type="checkbox"/> Yes <input checked="" type="checkbox"/> No
4. All consumer products manufactured, imported, or distributed by the application area meet one or more of the exemptions specified in 40 CFR § 59.201(c)(1) - (7).	<input type="checkbox"/> Yes <input type="checkbox"/> No

Application Area-Wide Applicability Determinations and General Information
Form OP-REQ1 (Page 17)
Federal Operating Permit Program
Texas Commission on Environmental Quality

Date	Permit No.	Regulated Entity No.
04/23/2026	O3670	RN106392624

For SOP applications, answer ALL questions unless otherwise directed.

◆ For GOP applications, answer ONLY these questions unless otherwise directed.

V. Title 40 Code of Federal Regulations Part 59 (40 CFR Part 59) - National Volatile Organic Compound Emission Standards for Consumer and Commercial Products (continued)	
C. Subpart D - National Volatile Organic Compound Emission Standards for Architectural Coatings	
1. The application area manufactures or imports architectural coatings for sale or distribution in the United States.	<input type="checkbox"/> Yes <input checked="" type="checkbox"/> No
2. The application area manufactures or imports architectural coatings that are registered under the Federal Insecticide, Fungicide, and Rodenticide Act. <i>If the responses to Questions V.C.1-2 are both "No," go to Section V.D.</i>	<input type="checkbox"/> Yes <input checked="" type="checkbox"/> No
3. All architectural coatings manufactured or imported by the application area meet one or more of the exemptions specified in 40 CFR §59.400(c)(1)-(5).	<input type="checkbox"/> Yes <input type="checkbox"/> No
D. Subpart E - National Volatile Organic Compound Emission Standards for Aerosol Coatings	
1. The application area manufactures or imports aerosol coating products for sale or distribution in the United States.	<input type="checkbox"/> Yes <input checked="" type="checkbox"/> No
2. The application area is a distributor of aerosol coatings for resale or distribution in the United States.	<input type="checkbox"/> Yes <input checked="" type="checkbox"/> No
E. Subpart F - Control of Evaporative Emissions from New and In-Use Portable Fuel Containers	
1. The application area manufactures or imports portable fuel containers for sale or distribution in the United States. <i>If the response to Question V.E.1 is "No," go to Section VI.</i>	<input type="checkbox"/> Yes <input checked="" type="checkbox"/> No
2. All portable fuel containers manufactured or imported by the application area meet one or more of the exemptions specified in 40 CFR § 59.605(a) - (c).	<input type="checkbox"/> Yes <input type="checkbox"/> No
VI. Title 40 Code of Federal Regulations Part 60 - New Source Performance Standards	
A. Applicability	
◆ 1. The application area includes a unit(s) that is subject to one or more 40 CFR Part 60 subparts. <i>If the response to Question VI.A.1 is "No," go to Section VII.</i>	<input checked="" type="checkbox"/> Yes <input type="checkbox"/> No

Application Area-Wide Applicability Determinations and General Information
Form OP-REQ1 (Page 18)
Federal Operating Permit Program
Texas Commission on Environmental Quality

Date	Permit No.	Regulated Entity No.
04/23/2026	O3670	RN106392624

For SOP applications, answer ALL questions unless otherwise directed.

◆ For GOP applications, answer ONLY these questions unless otherwise directed.

VI. Title 40 Code of Federal Regulations Part 60 - New Source Performance Standards (continued)		
B. Subpart Y - Standards of Performance for Coal Preparation and Processing Plants		
1.	The application area is located at a coal preparation and processing plant. <i>If the response to Question VI.B.1 is "No," go to Section VI.C.</i>	<input type="checkbox"/> Yes <input checked="" type="checkbox"/> No
2.	The coal preparation and processing plant has a design capacity greater than 200 tons per day (tpd). <i>If the response to Question VI.B.2 is "No," go to Section VI.C.</i>	<input type="checkbox"/> Yes <input type="checkbox"/> No
3.	The plant has an option to enforceably limit its operating level to less than 200 tpd and is choosing this option. <i>If the response to Question VI.B.3 is "Yes," go to Section VI.C.</i>	<input type="checkbox"/> Yes <input type="checkbox"/> No
4.	The plant contains an open storage pile, as defined in § 60.251, as an affected facility. <i>If the response to Question VI.B.4 is "No," go to Section VI.C.</i>	<input type="checkbox"/> Yes <input type="checkbox"/> No
5.	The open storage pile was constructed, reconstructed or modified after May 27, 2009.	<input type="checkbox"/> Yes <input type="checkbox"/> No
C. Subpart GG - Standards of Performance for Stationary Gas Turbines (GOP applicants only)		
◆ 1.	The application area includes one or more stationary gas turbines that have a heat input at peak load greater than or equal to 10 MMBtu/hr (10.7GJ/hr), based on the lower heating value of the fuel fired. <i>If the response to Question VI.C.1 is "No" or "N/A," go to Section VI.E.</i>	<input type="checkbox"/> Yes <input type="checkbox"/> No <input type="checkbox"/> N/A
◆ 2.	One or more of the affected facilities were constructed, modified, or reconstructed after October 3, 1977 and prior to February 19, 2005. <i>If the response to Question VI.C.2 is "No," go to Section VI.E.</i>	<input type="checkbox"/> Yes <input type="checkbox"/> No
◆ 3.	One or more stationary gas turbines in the application area are using a previously approved alternative fuel monitoring schedule as specified in 40 CFR § 60.334(h)(4).	<input type="checkbox"/> Yes <input type="checkbox"/> No
◆ 4.	The exemption specified in 40 CFR § 60.332(e) is being utilized for one or more stationary gas turbines in the application area.	<input type="checkbox"/> Yes <input type="checkbox"/> No

Application Area-Wide Applicability Determinations and General Information
Form OP-REQ1 (Page 19)
Federal Operating Permit Program
Texas Commission on Environmental Quality

Date	Permit No.	Regulated Entity No.
04/23/2026	O3670	RN106392624

For SOP applications, answer ALL questions unless otherwise directed.

◆ For GOP applications, answer ONLY these questions unless otherwise directed.

VI. Title 40 Code of Federal Regulations Part 60 - New Source Performance Standards (continued)		
C. Subpart GG - Standards of Performance for Stationary Gas Turbines (GOP applicants only) (continued)		
◆	5. One or more stationary gas turbines subject to 40 CFR Part 60, Subpart GG in the application area is injected with water or steam for the control of nitrogen oxides.	<input type="checkbox"/> Yes <input type="checkbox"/> No
D. Subpart XX - Standards of Performance for Bulk Gasoline Terminals		
	1. The application area includes bulk gasoline terminal loading racks. <i>If the response to Question VI.D.1 is "No," go to Section VI.E.</i>	<input type="checkbox"/> Yes <input checked="" type="checkbox"/> No <input type="checkbox"/> N/A
	2. One or more of the loading racks were constructed or modified after December 17, 1980, and are not subject to 40 CFR Part 63, Subpart CC.	<input type="checkbox"/> Yes <input type="checkbox"/> No
E. Subpart LLL - Standards of Performance for Onshore Natural Gas Processing: Sulfur Dioxide (SO₂) Emissions		
◆	1. The application area includes affected facilities identified in 40 CFR § 60.640(a) that process natural gas (onshore). <i>For SOP applications, if the response to Question VI.E.1 is "No," go to Section VI.F. For GOP applications, if the response to Question VI.E.1 is or "N/A," go to Section VI.H.</i>	<input type="checkbox"/> Yes <input checked="" type="checkbox"/> No
◆	2. The affected facilities commenced construction or modification after January 20, 1984 and on or before August 23, 2011. <i>For SOP applications, if the response to Question VI.E.2 is "No," go to Section VI.F. For GOP applications, if the response to Question VI.E.2 is "No," go to Section VI.H.</i>	<input type="checkbox"/> Yes <input type="checkbox"/> No
◆	3. The application area includes a gas sweetening unit with a design capacity greater than or equal to 2 long tons per day (LTPD) of hydrogen sulfide but operates at less than 2 LTPD. <i>For SOP applications, if the response to Question VI.E.3 is "No," go to Section VI.F. For GOP applications, if the response to Question VI.E.3 is "No," go to Section VI.H.</i>	<input type="checkbox"/> Yes <input type="checkbox"/> No

Application Area-Wide Applicability Determinations and General Information
Form OP-REQ1 (Page 20)
Federal Operating Permit Program
Texas Commission on Environmental Quality

Date	Permit No.	Regulated Entity No.
04/23/2026	O3670	RN106392624

For SOP applications, answer ALL questions unless otherwise directed.

◆ For GOP applications, answer ONLY these questions unless otherwise directed.

VI. Title 40 Code of Federal Regulations Part 60 - New Source Performance Standards (continued)	
E. Subpart LLL - Standards of Performance for Onshore Natural Gas Processing: Sulfur Dioxide (SO₂) Emissions (continued)	
◆ 4. Federally enforceable operating limits have been established in the preconstruction authorization limiting the gas sweetening unit to less than 2 LTPD. <i>For SOP applications, if the response to Question VI.E.4. is "No," go to Section VI.F. For GOP applications, if the response to Question VI.E.4. is "No," go to Section VI.H.</i>	<input type="checkbox"/> Yes <input type="checkbox"/> No
◆ 5. Please provide the Unit ID(s) for the gas sweetening unit(s) that have established federally enforceable operating limits in the space provided below	
F. Subpart OOO - Standards of Performance for Nonmetallic Mineral Processing Plants	
1. The application area includes affected facilities identified in 40 CFR § 60.670(a)(1) that are located at a fixed or portable nonmetallic mineral processing plant. <i>If the response to Question VI.F.1 is "No," go to Section VI.G.</i>	<input type="checkbox"/> Yes <input checked="" type="checkbox"/> No
2. Affected facilities identified in 40 CFR § 60.670(a)(1) and located in the application area are subject to 40 CFR Part 60, Subpart OOO.	<input type="checkbox"/> Yes <input type="checkbox"/> No
G. Subpart QQQ - Standards of Performance for VOC Emissions from Petroleum Refinery Wastewater Systems	
1. The application area is located at a petroleum refinery and includes one or more of the affected facilities identified in 40 CFR § 60.690(a)(2) - (4) for which construction, modification, or reconstruction was commenced after May 4, 1987. <i>If the response to Question VI.G.1 is "No," go to Section VI.H.</i>	<input type="checkbox"/> Yes <input checked="" type="checkbox"/> No
2. The application area includes storm water sewer systems.	<input type="checkbox"/> Yes <input type="checkbox"/> No

Application Area-Wide Applicability Determinations and General Information
Form OP-REQ1 (Page 21)
Federal Operating Permit Program
Texas Commission on Environmental Quality

Date	Permit No.	Regulated Entity No.
04/23/2026	O3670	RN106392624

For SOP applications, answer ALL questions unless otherwise directed.

◆ For GOP applications, answer ONLY these questions unless otherwise directed.

VI. Title 40 Code of Federal Regulations Part 60 - New Source Performance Standards	
G. Subpart QQQ - Standards of Performance for VOC Emissions from Petroleum Refinery Wastewater Systems (continued)	
3. The application area includes ancillary equipment which is physically separate from the wastewater system and does not come in contact with or store oily wastewater.	<input type="checkbox"/> Yes <input type="checkbox"/> No
4. The application area includes non-contact cooling water systems.	<input type="checkbox"/> Yes <input type="checkbox"/> No
5. The application area includes individual drain systems. <i>If the response to Question VI.G.5 is "No," go to Section VI.H.</i>	<input type="checkbox"/> Yes <input type="checkbox"/> No
6. The application area includes one or more individual drain systems that meet the exemption specified in 40 CFR § 60.692-2(d).	<input type="checkbox"/> Yes <input type="checkbox"/> No
7. The application area includes completely closed drain systems.	<input type="checkbox"/> Yes <input type="checkbox"/> No
H. Subpart AAAA - Standards of Performance for Small Municipal Waste Incineration Units for Which Construction Commenced After August 30, 1999 or for Which Modification or Reconstruction Commenced on or After June 6, 2004	
◆ 1. The application area includes at least one small municipal waste incineration unit, other than an air curtain incinerator. <i>If the response to Question VI.H.1. is "N/A," go to Section VI.I. If the response to Question VI.H.1 is "No," go to Question VI.H.4.</i>	<input type="checkbox"/> Yes <input checked="" type="checkbox"/> No <input type="checkbox"/> N/A
◆ 2. The application area includes at least one small municipal waste incineration unit, other than an air curtain incinerator, constructed after August 30, 1999 or modified or reconstructed on or after June 6, 2006.	<input type="checkbox"/> Yes <input type="checkbox"/> No
◆ 3. The application area includes at least one small municipal waste incineration unit, other than an air curtain incinerator, constructed before August 30, 1999 and not modified or reconstructed on or after June 6, 2006.	<input type="checkbox"/> Yes <input type="checkbox"/> No
◆ 4. The application area includes at least one air curtain incinerator. <i>If the response to Question VI.H.4 is "No," go to Section VI.I.</i>	<input type="checkbox"/> Yes <input checked="" type="checkbox"/> No

Application Area-Wide Applicability Determinations and General Information
Form OP-REQ1 (Page 22)
Federal Operating Permit Program
Texas Commission on Environmental Quality

Date	Permit No.	Regulated Entity No.
04/23/2026	O3670	RN106392624

For SOP applications, answer ALL questions unless otherwise directed.

◆ For GOP applications, answer ONLY these questions unless otherwise directed.

VI. Title 40 Code of Federal Regulations Part 60 - New Source Performance Standards (continued)		
H. Subpart AAAA - Standards of Performance for Small Municipal Waste Incineration Units for Which Construction Commenced After August 30, 1999 or for Which Modification or Reconstruction Commenced on or After June 6, 2004 (continued)		
◆	5. The application area includes at least one air curtain incinerator constructed after August 30, 1999 or modified or reconstructed on or after June 6, 2006. <i>If the response to Question VI.H.5 is "No," go to Question VI.H.7.</i>	<input type="checkbox"/> Yes <input type="checkbox"/> No
◆	6. All air curtain incinerators constructed after August 30, 1999 or modified or reconstructed on or after June 6, 2006 combust only yard waste.	<input type="checkbox"/> Yes <input type="checkbox"/> No
◆	7. The application area includes at least one air curtain incinerator constructed before August 30, 1999 and not modified or reconstructed on or after June 6, 2006.	<input type="checkbox"/> Yes <input type="checkbox"/> No
◆	8. All air curtain incinerators constructed before August 30, 1999 and not modified or reconstructed on or after June 6, 2006 combust only yard waste.	<input type="checkbox"/> Yes <input type="checkbox"/> No
I. Subpart CCCC - Standards of Performance for Commercial and Industrial Solid Waste Incineration Units for Which Construction Commenced After November 30, 1999 or for Which Modification or Reconstruction Commenced on or After June 1, 2001		
◆	1. The application area includes at least one commercial or industrial solid waste incineration unit, other than an air curtain incinerator. <i>If the response to Question VI.I.1 is "N/A," go to Section VI.J. If the response to Question VI.I.1 is "No," go to Question VI.I.4.</i>	<input type="checkbox"/> Yes <input checked="" type="checkbox"/> No <input type="checkbox"/> N/A
◆	2. The application area includes at least one commercial or industrial solid waste incineration unit, other than an air curtain incinerator, constructed after November 30, 1999 or modified or reconstructed on or after June 1, 2001.	<input type="checkbox"/> Yes <input type="checkbox"/> No

Application Area-Wide Applicability Determinations and General Information
Form OP-REQ1 (Page 23)
Federal Operating Permit Program
Texas Commission on Environmental Quality

Date	Permit No.	Regulated Entity No.
04/23/2026	O3670	RN106392624

For SOP applications, answer ALL questions unless otherwise directed.

◆ For GOP applications, answer ONLY these questions unless otherwise directed.

VI. Title 40 Code of Federal Regulations Part 60 - New Source Performance Standards (continued)		
I. Subpart CCCC - Standards of Performance for Commercial and Industrial Solid Waste Incineration Units for Which Construction Commenced After November 30, 1999 or for Which Modification or Reconstruction Commenced on or After June 1, 2001 (continued)		
◆ 3.	The application area includes at least one commercial or industrial solid waste incineration unit, other than an air curtain incinerator, constructed before November 30, 1999 and not modified or reconstructed on or after June 1, 2001.	<input type="checkbox"/> Yes <input type="checkbox"/> No
◆ 4.	The application area includes at least one air curtain incinerator. <i>If the response to Question VI.I.4 is "No," go to Section VI.J.</i>	<input type="checkbox"/> Yes <input checked="" type="checkbox"/> No
◆ 5.	The application area includes at least one air curtain incinerator, constructed after November 30, 1999 or modified or reconstructed on or after June 1, 2001. <i>If the response to Question VI.I.5 is "No," go to VI.I.7.</i>	<input type="checkbox"/> Yes <input type="checkbox"/> No
◆ 6.	All air curtain incinerators constructed after November 30, 1999 or modified or reconstructed on or after June 1, 2001 combust only wood waste, clean lumber, or yard waste or a mixture of these materials.	<input type="checkbox"/> Yes <input type="checkbox"/> No
◆ 7.	The application area includes at least one air curtain incinerator, constructed before November 30, 1999 and not modified or reconstructed on or after June 1, 2001.	<input type="checkbox"/> Yes <input type="checkbox"/> No
◆ 8.	All air curtain incinerators constructed before November 30, 1999 and not modified or reconstructed on or after June 1, 2001 combust only wood waste, clean lumber, or yard waste or a mixture of these materials.	<input type="checkbox"/> Yes <input type="checkbox"/> No

Application Area-Wide Applicability Determinations and General Information
Form OP-REQ1 (Page 24)
Federal Operating Permit Program
Texas Commission on Environmental Quality

Date	Permit No.	Regulated Entity No.
04/23/2026	O3670	RN106392624

For SOP applications, answer ALL questions unless otherwise directed.

◆ For GOP applications, answer ONLY these questions unless otherwise directed.

VI. Title 40 Code of Federal Regulations Part 60 - New Source Performance Standards (continued)		
J. Subpart EEEE - Standards of Performance for Other Solid Waste Incineration Units for Which Construction Commenced After December 9, 2004 or for Which Modification or Reconstruction Commenced on or After June 16, 2006		
◆	1. The application area includes at least one very small municipal waste incineration unit or institutional incineration unit, other than an air curtain incinerator. <i>If the response to Question VI.J.1 is "N/A," go to Section VI.K. If the response to Question VI.J.1 is "No," go to Question VI.J.4.</i>	<input type="checkbox"/> Yes <input checked="" type="checkbox"/> No <input type="checkbox"/> N/A
◆	2. The application area includes at least one very small municipal waste incineration unit, other than an air curtain incinerator, constructed after December 9, 2004 or modified or reconstructed on or after June 16, 2006.	<input type="checkbox"/> Yes <input type="checkbox"/> No
◆	3. The application area includes at least one very small municipal waste incineration unit, other than an air curtain incinerator, constructed before December 9, 2004 and not modified or reconstructed on or after June 16, 2006.	<input type="checkbox"/> Yes <input type="checkbox"/> No
◆	4. The application area includes at least one air curtain incinerator. <i>If the response to Question VI.J.4 is "No," go to Section VI.K.</i>	<input type="checkbox"/> Yes <input checked="" type="checkbox"/> No
◆	5. The application area includes at least one air curtain incinerator constructed after December 9, 2004 or modified or reconstructed on or after June 16, 2006. <i>If the response to Question VI.J.5 is "No," go to Question VI.J.7.</i>	<input type="checkbox"/> Yes <input type="checkbox"/> No
◆	6. All air curtain incinerators constructed after December 9, 2004 or modified or reconstructed on or after June 16, 2006 combust only wood waste, clean lumber, or yard waste or a mixture of these materials.	<input type="checkbox"/> Yes <input type="checkbox"/> No
◆	7. The application area includes at least one air curtain incinerator constructed before December 9, 2004 and not modified or reconstructed on or after June 16, 2006.	<input type="checkbox"/> Yes <input type="checkbox"/> No

Application Area-Wide Applicability Determinations and General Information
Form OP-REQ1 (Page 25)
Federal Operating Permit Program
Texas Commission on Environmental Quality

Date	Permit No.	Regulated Entity No.
04/23/2026	O3670	RN106392624

For SOP applications, answer ALL questions unless otherwise directed.

◆ For GOP applications, answer ONLY these questions unless otherwise directed.

VI. Title 40 Code of Federal Regulations Part 60 - New Source Performance Standards (NSPS) (continued)		
J. Subpart EEEE - Standards of Performance for Other Solid Waste Incineration Units for Which Construction Commenced After December 9, 2004 or for Which Modification or Reconstruction Commenced on or After June 16, 2006 (continued)		
◆	8. All air curtain incinerators constructed before December 9, 2004 and not modified or reconstructed on or after June 16, 2006 combust only wood waste, clean lumber, or yard waste or a mixture of these materials.	<input type="checkbox"/> Yes <input type="checkbox"/> No
◆	9. The air curtain incinerator is located at an institutional facility and is a distinct operating unit of the institutional facility that generated the waste.	<input type="checkbox"/> Yes <input type="checkbox"/> No
◆	10. The air curtain incinerator burns less than 35 tons per day of wood waste, clean lumber, or yard waste or a mixture of these materials.	<input type="checkbox"/> Yes <input type="checkbox"/> No
K. Subpart OOOO - Standards of Performance for Crude Oil and Natural Gas Production, Transmission and Distribution		
◆	1. The application area includes one or more of the onshore affected facilities listed in 40 CFR § 60.5365(a)-(g) that are subject to 40 CFR Part 60, Subpart OOOO.	<input type="checkbox"/> Yes <input checked="" type="checkbox"/> No
VII. Title 40 Code of Federal Regulations Part 61 - National Emission Standards for Hazardous Air Pollutants		
A. Applicability		
◆	1. The application area includes a unit(s) that is subject to one or more 40 CFR Part 61 subparts. <i>If the response to Question VII.A.1 is "No" or "N/A," go to Section VIII.</i>	<input type="checkbox"/> Yes <input checked="" type="checkbox"/> No <input type="checkbox"/> N/A
B. Subpart F - National Emission Standard for Vinyl Chloride		
	1. The application area is located at a plant which produces ethylene dichloride by reaction of oxygen and hydrogen chloride with ethylene, vinyl chloride by any process, and/or one or more polymers containing any fraction of polymerized vinyl chloride.	<input type="checkbox"/> Yes <input type="checkbox"/> No
C. Subpart J - National Emission Standard for Benzene Emissions for Equipment Leaks (Fugitive Emission Sources) of Benzene (Complete this section for GOP applications only)		
◆	1. The application area includes equipment in benzene service.	<input type="checkbox"/> Yes <input type="checkbox"/> No <input type="checkbox"/> N/A

Application Area-Wide Applicability Determinations and General Information
Form OP-REQ1 (Page 26)
Federal Operating Permit Program
Texas Commission on Environmental Quality

Date	Permit No.	Regulated Entity No.
04/23/2026	O3670	RN106392624

For SOP applications, answer ALL questions unless otherwise directed.

◆ For GOP applications, answer ONLY these questions unless otherwise directed.

VII. Title 40 Code of Federal Regulations Part 61 - National Emission Standards for Hazardous Air Pollutants (continued)		
D. Subpart L - National Emission Standard for Benzene Emissions from Coke By-Product Recovery Plants		
1. The application area is located at a coke by-product recovery plant and includes one or more of the affected sources identified in 40 CFR § 61.130(a) - (b). <i>If the response to Question VII.D.1 is "No," go to Section VII.E.</i>	<input type="checkbox"/> Yes <input type="checkbox"/> No	
2. The application area includes equipment in benzene service as determined by 40 CFR § 61.137(b).	<input type="checkbox"/> Yes <input type="checkbox"/> No	
3. The application area has elected to comply with the provisions of 40 CFR § 61.243-1 and 40 CFR § 61.243-2.	<input type="checkbox"/> Yes <input type="checkbox"/> No	
E. Subpart M - National Emission Standard for Asbestos		
<i>Applicability</i>		
1. The application area includes sources, operations, or activities specified in 40 CFR §§ 61.143, 61.144, 61.146, 61.147, 61.148, or 61.155. <i>If the response to Question VII.E.1 is "No," go to Section VII.F.</i>	<input type="checkbox"/> Yes <input type="checkbox"/> No	
<i>Roadway Construction</i>		
2. The application area includes roadways constructed or maintained with asbestos tailings or asbestos-containing waste material.	<input type="checkbox"/> Yes <input type="checkbox"/> No	
<i>Manufacturing Commercial Asbestos</i>		
3. The application area includes a manufacturing operation using commercial asbestos. <i>If the response to Question VII.E.3 is "No," go to Question VII.E.4.</i>	<input type="checkbox"/> Yes <input type="checkbox"/> No	
a. Visible emissions are discharged to outside air from the manufacturing operation	<input type="checkbox"/> Yes <input type="checkbox"/> No	
b. An alternative emission control and waste treatment method is being used that has received prior U.S. Environmental Protection Agency (EPA) approval.	<input type="checkbox"/> Yes <input type="checkbox"/> No	

Application Area-Wide Applicability Determinations and General Information
Form OP-REQ1 (Page 27)
Federal Operating Permit Program
Texas Commission on Environmental Quality

Date	Permit No.	Regulated Entity No.
04/23/2026	O3670	RN106392624

For SOP applications, answer ALL questions unless otherwise directed.

◆ For GOP applications, answer ONLY these questions unless otherwise directed.

VII. Title 40 Code of Federal Regulations Part 61 - National Emission Standards for Hazardous Air Pollutants (continued)	
E. Subpart M - National Emission Standard for Asbestos (continued)	
<i>Manufacturing Commercial Asbestos (continued)</i>	
c. Asbestos-containing waste material is processed into non-friable forms.	<input type="checkbox"/> Yes <input type="checkbox"/> No
d. Asbestos-containing waste material is adequately wetted.	<input type="checkbox"/> Yes <input type="checkbox"/> No
e. Alternative filtering equipment is being used that has received EPA approval.	<input type="checkbox"/> Yes <input type="checkbox"/> No
f. A high efficiency particulate air (HEPA) filter is being used that is certified to be at least 99.97% efficient for 0.3-micron particles	<input type="checkbox"/> Yes <input type="checkbox"/> No
g. The EPA has authorized the use of wet collectors designed to operate with a unit contacting energy of at least 9.95 kilopascals.	<input type="checkbox"/> Yes <input type="checkbox"/> No
<i>Asbestos Spray Application</i>	
4. The application area includes operations in which asbestos-containing materials are spray applied. <i>If the response to Question VII.E.4 is "No," go to Question VII.E.5.</i>	<input type="checkbox"/> Yes <input type="checkbox"/> No
a. Asbestos fibers are encapsulated with a bituminous or resinous binder during spraying and are not friable after drying. <i>If the response to Question VII.E.4.a is "Yes," go to Question VII.E.5.</i>	<input type="checkbox"/> Yes <input type="checkbox"/> No
b. Spray-on applications on buildings, structures, pipes, and conduits do not use material containing more than 1% asbestos.	<input type="checkbox"/> Yes <input type="checkbox"/> No
c. An alternative emission control and waste treatment method is being used that has received prior EPA approval.	<input type="checkbox"/> Yes <input type="checkbox"/> No

Application Area-Wide Applicability Determinations and General Information
Form OP-REQ1 (Page 28)
Federal Operating Permit Program
Texas Commission on Environmental Quality

Date	Permit No.	Regulated Entity No.
04/23/2026	O3670	RN106392624

For SOP applications, answer ALL questions unless otherwise directed.

◆ For GOP applications, answer ONLY these questions unless otherwise directed.

VII. Title 40 Code of Federal Regulations Part 61 - National Emission Standards for Hazardous Air Pollutants (continued)	
E. Subpart M - National Emission Standard for Asbestos (continued)	
<i>Asbestos Spray Application (continued)</i>	
d. Asbestos-containing waste material is processed into non-friable forms.	<input type="checkbox"/> Yes <input type="checkbox"/> No
e. Asbestos-containing waste material is adequately wetted.	<input type="checkbox"/> Yes <input type="checkbox"/> No
f. Alternative filtering equipment is being used that has received EPA approval.	<input type="checkbox"/> Yes <input type="checkbox"/> No
g. A HEPA filter is being used that is certified to be at least 99.97% efficient for 0.3-micron particles.	<input type="checkbox"/> Yes <input type="checkbox"/> No
h. The EPA has authorized the use of wet collectors designed to operate with a unit contacting energy of at least 9.95 kilopascals.	<input type="checkbox"/> Yes <input type="checkbox"/> No
<i>Fabricating Commercial Asbestos</i>	
5. The application area includes a fabricating operation using commercial asbestos. <i>If the response to Question VII.E.5 is "No," go to Question VII.E.6.</i>	<input type="checkbox"/> Yes <input type="checkbox"/> No
a. Visible emissions are discharged to outside air from the manufacturing operation.	<input type="checkbox"/> Yes <input type="checkbox"/> No
b. An alternative emission control and waste treatment method is being used that has received prior EPA approval.	<input type="checkbox"/> Yes <input type="checkbox"/> No
c. Asbestos-containing waste material is processed into non-friable forms.	<input type="checkbox"/> Yes <input type="checkbox"/> No
d. Asbestos-containing waste material is adequately wetted.	<input type="checkbox"/> Yes <input type="checkbox"/> No
e. Alternative filtering equipment is being used that has received EPA approval.	<input type="checkbox"/> Yes <input type="checkbox"/> No

Application Area-Wide Applicability Determinations and General Information
Form OP-REQ1 (Page 29)
Federal Operating Permit Program
Texas Commission on Environmental Quality

Date	Permit No.	Regulated Entity No.
04/23/2026	O3670	RN106392624

For SOP applications, answer ALL questions unless otherwise directed.

◆ For GOP applications, answer ONLY these questions unless otherwise directed.

VII. Title 40 Code of Federal Regulations Part 61 - National Emission Standards for Hazardous Air Pollutants (continued)	
E. Subpart M - National Emission Standard for Asbestos (continued)	
<i>Fabricating Commercial Asbestos (continued)</i>	
f. A HEPA filter is being used that is certified to be at least 99.97% efficient for 0.3-micron particles.	<input type="checkbox"/> Yes <input type="checkbox"/> No
g. The EPA has authorized the use of wet collectors designed to operate with a unit contacting energy of at least 9.95 kilopascals.	<input type="checkbox"/> Yes <input type="checkbox"/> No
<i>Non-sprayed Asbestos Insulation</i>	
6. The application area includes insulating materials (other than spray applied insulating materials) that are either molded and friable or wet-applied and friable after drying.	<input type="checkbox"/> Yes <input type="checkbox"/> No
<i>Asbestos Conversion</i>	
7. The application area includes operations that convert regulated asbestos-containing material and asbestos-containing waste material into nonasbestos (asbestos-free) material.	<input type="checkbox"/> Yes <input type="checkbox"/> No
F. Subpart P - National Emission Standard for Inorganic Arsenic Emissions from Arsenic Trioxide and Metallic Arsenic Production Facilities	
1. The application area is located at a metallic arsenic production plant or at an arsenic trioxide plant that processes low-grade arsenic bearing materials by a roasting condensation process.	<input type="checkbox"/> Yes <input type="checkbox"/> No
G. Subpart BB - National Emission Standard for Benzene Emissions from Benzene Transfer Operations	
1. The application area is located at a benzene production facility and/or bulk terminal. <i>If the response to Question VII.G.1 is "No," go to Section VII.H.</i>	<input type="checkbox"/> Yes <input type="checkbox"/> No
2. The application area includes benzene transfer operations at marine vessel loading racks.	<input type="checkbox"/> Yes <input type="checkbox"/> No

Application Area-Wide Applicability Determinations and General Information
Form OP-REQ1 (Page 30)
Federal Operating Permit Program
Texas Commission on Environmental Quality

Date	Permit No.	Regulated Entity No.
04/23/2026	O3670	RN106392624

For SOP applications, answer ALL questions unless otherwise directed.

◆ For GOP applications, answer ONLY these questions unless otherwise directed.

VII. Title 40 Code of Federal Regulations Part 61 - National Emission Standards for		
G. Subpart BB - National Emission Standard for Benzene Emissions from Benzene Transfer Operations (continued)		
3.	The application area includes benzene transfer operations at railcar loading racks.	<input type="checkbox"/> Yes <input type="checkbox"/> No
4.	The application area includes benzene transfer operations at tank-truck loading racks.	<input type="checkbox"/> Yes <input type="checkbox"/> No
H. Subpart FF - National Emission Standard for Benzene Waste Operations		
<i>Applicability</i>		
1.	The application area includes a chemical manufacturing plant, coke by-product recovery plant, or petroleum refinery facility as defined in § 61.341.	<input type="checkbox"/> Yes <input type="checkbox"/> No
2.	The application area is located at a hazardous waste treatment, storage, and disposal (TSD) facility site as described in 40 CFR § 61.340(b). <i>If the responses to Questions VII.H.1 and VII.H.2 are both "No," go to Section VIII.</i>	<input type="checkbox"/> Yes <input type="checkbox"/> No
3.	The application area is located at a site that has no benzene onsite in wastes, products, byproducts, or intermediates. <i>If the response to Question VII.H.3 is "Yes," go to Section VIII.</i>	<input type="checkbox"/> Yes <input type="checkbox"/> No
4.	The application area is located at a site having a total annual benzene quantity from facility waste less than 1 megagram per year (Mg/yr). <i>If the response to Question VII.H.4 is "Yes," go to Section VIII</i>	<input type="checkbox"/> Yes <input type="checkbox"/> No
5.	The application area is located at a site having a total annual benzene quantity from facility waste greater than or equal to 1 Mg/yr but less than 10 Mg/yr. <i>If the response to Question VII.H.5 is "Yes," go to Section VIII.</i>	<input type="checkbox"/> Yes <input type="checkbox"/> No

Application Area-Wide Applicability Determinations and General Information
Form OP-REQ1 (Page 31)
Federal Operating Permit Program
Texas Commission on Environmental Quality

Date	Permit No.	Regulated Entity No.
04/23/2026	O3670	RN106392624

For SOP applications, answer ALL questions unless otherwise directed.

◆ For GOP applications, answer ONLY these questions unless otherwise directed.

VII. Title 40 Code of Federal Regulations Part 61 - National Emission Standards for Hazardous Air Pollutants (continued)	
H. Subpart FF - National Emission Standard for Benzene Waste Operations (continued)	
<i>Applicability (continued)</i>	
6. The flow-weighted annual average benzene concentration of each waste stream at the site is based on documentation.	<input type="checkbox"/> Yes <input type="checkbox"/> No
7. The application area has waste streams with flow-weighted annual average water content of 10% or greater.	<input type="checkbox"/> Yes <input type="checkbox"/> No
<i>Waste Stream Exemptions</i>	
8. The application area has waste streams that meet the exemption specified in 40 CFR § 61.342(c)(2) (the flow-weighted annual average benzene concentration is less than 10 ppmw).	<input type="checkbox"/> Yes <input type="checkbox"/> No
9. The application area has waste streams that meet the exemption specified in 40 CFR § 61.342(c)(3) because process wastewater has a flow rate less than 0.02 liters per minute or an annual wastewater quantity less than 10 Mg/yr.	<input type="checkbox"/> Yes <input type="checkbox"/> No
10. The application area has waste streams that meet the exemption specified in 40 CFR § 61.342(c)(3) because the total annual benzene quantity is less than or equal to 2 Mg/yr.	<input type="checkbox"/> Yes <input type="checkbox"/> No
11. The application area transfers waste off-site for treatment by another facility.	<input type="checkbox"/> Yes <input type="checkbox"/> No
12. The application area is complying with 40 CFR § 61.342(d).	<input type="checkbox"/> Yes <input type="checkbox"/> No
13. The application area is complying with 40 CFR § 61.342(e). <i>If the response to Question VII.H.13 is "No," go to Question VII.H.15.</i>	<input type="checkbox"/> Yes <input type="checkbox"/> No
14. The application area has facility waste with a flow weighted annual average water content of less than 10%.	<input type="checkbox"/> Yes <input type="checkbox"/> No

Application Area-Wide Applicability Determinations and General Information
Form OP-REQ1 (Page 32)
Federal Operating Permit Program
Texas Commission on Environmental Quality

Date	Permit No.	Regulated Entity No.
04/23/2026	O3670	RN106392624

For SOP applications, answer ALL questions unless otherwise directed.

◆ For GOP applications, answer ONLY these questions unless otherwise directed.

VII. Title 40 Code of Federal Regulations Part 61 - National Emission Standards for Hazardous Air Pollutants (continued)	
H. Subpart FF - National Emission Standard for Benzene Waste Operations (continued)	
<i>Container Requirements</i>	
15. The application area has containers, as defined in 40 CFR § 61.341, that receive non-exempt benzene waste. <i>If the response to Question VII.H.15 is "No," go to Question VII.H.18.</i>	<input type="checkbox"/> Yes <input type="checkbox"/> No
16. The application area is an alternate means of compliance to meet the 40 CFR § 61.345 requirements for containers. <i>If the response to Question VII.H.16 is "Yes," go to Question VII.H.18.</i>	<input type="checkbox"/> Yes <input type="checkbox"/> No
17. Covers and closed-vent systems used for containers operate such that the container is maintained at a pressure less than atmospheric pressure.	<input type="checkbox"/> Yes <input type="checkbox"/> No
<i>Individual Drain Systems</i>	
18. The application area has individual drain systems, as defined in 40 CFR § 61.341, that receive or manage non-exempt benzene waste. <i>If the response to Question VII.H.18 is "No," go to Question VII.H.25.</i>	<input type="checkbox"/> Yes <input type="checkbox"/> No
19. The application area is using an alternate means of compliance to meet the 40 CFR § 61.346 requirements for individual drain systems. <i>If the response to Question VII.H.19 is "Yes," go to Question VII.H.25.</i>	<input type="checkbox"/> Yes <input type="checkbox"/> No
20. The application area has individual drain systems complying with 40 CFR § 61.346(a). <i>If the response to Question VII.H.20 is "No," go to Question VII.H.22.</i>	<input type="checkbox"/> Yes <input type="checkbox"/> No
21. Covers and closed-vent systems used for individual drain systems operate such that the individual drain system is maintained at a pressure less than atmospheric pressure.	<input type="checkbox"/> Yes <input type="checkbox"/> No

Application Area-Wide Applicability Determinations and General Information
Form OP-REQ1 (Page 33)
Federal Operating Permit Program
Texas Commission on Environmental Quality

Date	Permit No.	Regulated Entity No.
04/23/2026	O3670	RN106392624

For SOP applications, answer ALL questions unless otherwise directed.

◆ For GOP applications, answer ONLY these questions unless otherwise directed.

VII. Title 40 Code of Federal Regulations Part 61 - National Emission Standards for Hazardous Air Pollutants (continued)	
H. Subpart FF - National Emission Standard for Benzene Waste Operations (continued)	
<i>Individual Drain Systems (continued)</i>	
22. The application area has individual drain systems complying with 40 CFR § 61.346(b). <i>If the response to Question VII.H.22 is "No," go to Question VII.H.25.</i>	<input type="checkbox"/> Yes <input type="checkbox"/> No
23. Junction boxes in the individual drain systems are equipped with a system to prevent the flow of organic vapors from the junction box vent pipe to the atmosphere during normal operation.	<input type="checkbox"/> Yes <input type="checkbox"/> No
24. Junction box vent pipes in the individual drain systems are connected to a closed-vent system and control device.	<input type="checkbox"/> Yes <input type="checkbox"/> No
<i>Remediation Activities</i>	
25. Remediation activities take place at the application area subject to 40 CFR Part 61, Subpart FF.	<input type="checkbox"/> Yes <input type="checkbox"/> No
VIII. Title 40 Code of Federal Regulations Part 63 - National Emission Standards for Hazardous Air Pollutants for Source Categories	
A. Applicability	
◆ 1. The application area includes a unit(s) that is subject to one or more 40 CFR Part 63 subparts other than subparts made applicable by reference under subparts in 40 CFR Part 60, 61 or 63. <i>See instructions for 40 CFR Part 63 subparts made applicable only by reference.</i>	<input checked="" type="checkbox"/> Yes <input type="checkbox"/> No
B. Subpart F - National Emission Standards for Organic Hazardous Air Pollutants from the Synthetic Organic Chemical Manufacturing Industry	
1. The application area is located at a plant site that is a major source as defined in the Federal Clean Air Act § 112(a). <i>If the response to Question VIII.B.1 is "No," go to Section VIII.D.</i>	<input type="checkbox"/> Yes <input checked="" type="checkbox"/> No

Application Area-Wide Applicability Determinations and General Information
Form OP-REQ1 (Page 34)
Federal Operating Permit Program
Texas Commission on Environmental Quality

Date	Permit No.	Regulated Entity No.
04/23/2026	O3670	RN106392624

For SOP applications, answer ALL questions unless otherwise directed.

◆ For GOP applications, answer ONLY these questions unless otherwise directed.

VIII. Title 40 Code of Federal Regulations Part 63 - National Emission Standards for Hazardous Air Pollutants for Source Categories (continued)	
B. Subpart F - National Emission Standards for Organic Hazardous Air Pollutants from the Synthetic Organic Chemical Manufacturing Industry (continued)	
<p>2. The application area is located at a site that includes at least one chemical manufacturing process unit, as defined in 40 CFR § 63.101, that manufactures as a primary product one or more of the chemicals listed in 40 CFR § 63.100(b)(1)(i) or (b)(1)(ii). <i>If the response to Question VIII.B.2 is "No," go to Section VIII.D.</i></p>	<input type="checkbox"/> Yes <input checked="" type="checkbox"/> No
<p>3. The application area is located at a site that includes at least one chemical manufacturing process unit, as defined in 40 CFR § 63.101, that manufactures as a primary product one or more of the chemicals listed in 40 CFR § 63.100(b)(1)(i) or (b)(1)(ii) and uses as a reactant or manufactures as a product, or co-product, one or more of the organic hazardous air pollutants listed in table 2 of 40 CFR Part 63, Subpart F.</p>	<input type="checkbox"/> Yes <input type="checkbox"/> No
<p>4. The application area includes a chemical manufacturing process unit, as defined in 40 CFR § 63.101, that manufactures as a primary product one or more of the chemicals listed in 40 CFR § 63.100(b)(1)(i) or (b)(1)(ii) and uses as a reactant or manufactures as a product, or co-product, one or more of the organic hazardous air pollutants listed in table 2 of 40 CFR Part 63, Subpart F.</p>	<input type="checkbox"/> Yes <input type="checkbox"/> No
<p>5. The application area includes a chemical manufacturing process unit, as defined in 40 CFR § 63.101, that manufactures as a primary product one or more of the chemicals listed in 40 CFR § 63.100(b)(1)(i) or (b)(1)(ii) and does <u>not</u> use as a reactant or manufacture as a product, or co-product, one or more of the organic hazardous air pollutants listed in table 2 of 40 CFR Part 63, Subpart F. <i>If the response to Questions VIII.B.3, B.4 and B.5 are all "No," go to Section VIII.D.</i></p>	<input type="checkbox"/> Yes <input type="checkbox"/> No

Application Area-Wide Applicability Determinations and General Information
Form OP-REQ1 (Page 35)
Federal Operating Permit Program
Texas Commission on Environmental Quality

Date	Permit No.	Regulated Entity No.
04/23/2026	O3670	RN106392624

For SOP applications, answer ALL questions unless otherwise directed.

◆ For GOP applications, answer ONLY these questions unless otherwise directed.

VIII. Title 40 Code of Federal Regulations Part 63 - National Emission Standards for Hazardous Air Pollutants for Source Categories (continued)	
C. Subpart G - National Emission Standards for Organic Hazardous Air Pollutants from the Synthetic Organic Chemical Manufacturing Industry for Process Vents, Storage Vessels, Transfer Operations, and Wastewater	
<i>Applicability</i>	
<p>1. The application area is located at a site that is subject to 40 CFR 63, Subpart F and the application area includes process vents, storage vessels, transfer racks, or waste streams associated with a chemical manufacturing process subject to 40 CFR 63, Subpart F. <i>If the response to Question VIII.C.1 is "No," go to Section VIII.D.</i></p>	<input type="checkbox"/> Yes <input type="checkbox"/> No
<p>2. The application area includes fixed roofs, covers, and/or enclosures that are required to comply with 40 CFR § 63.148.</p>	<input type="checkbox"/> Yes <input type="checkbox"/> No
<p>3. The application area includes vapor collection systems or closed-vent systems that are required to comply with 40 CFR § 63.148. <i>If the response to Question VIII.C.3 is "No," go to Question VIII.C.8.</i></p>	<input type="checkbox"/> Yes <input type="checkbox"/> No
<p>4. The application area includes vapor collection systems or closed-vent systems that are constructed of hard piping.</p>	<input type="checkbox"/> Yes <input type="checkbox"/> No
<p>5. The application area includes vapor collection systems or closed-vent systems that contain bypass lines that could divert a vent stream away from a control device and to the atmosphere. <i>If the response to Question VIII.C.5 is "No," go to Question VIII.C.8.</i></p>	<input type="checkbox"/> Yes <input type="checkbox"/> No
<i>Vapor Collection and Closed Vent Systems</i>	
<p>6. Flow indicators are installed, calibrated, maintained, and operated at the entrances to bypass lines in the application area.</p>	<input type="checkbox"/> Yes <input type="checkbox"/> No
<p>7. Bypass lines in the application area are secured in the closed position with a car-seal or a lock-and-key type configuration.</p>	<input type="checkbox"/> Yes <input type="checkbox"/> No

Application Area-Wide Applicability Determinations and General Information
Form OP-REQ1 (Page 36)
Federal Operating Permit Program
Texas Commission on Environmental Quality

Date	Permit No.	Regulated Entity No.
04/23/2026	O3670	RN106392624

For SOP applications, answer ALL questions unless otherwise directed.

◆ For GOP applications, answer ONLY these questions unless otherwise directed.

VIII. Title 40 Code of Federal Regulations Part 63 - National Emission Standards for Hazardous Air Pollutants for Source Categories (continued)		
C. Subpart G - National Emission Standards for Organic Hazardous Air Pollutants from the Synthetic Organic Chemical Manufacturing Industry for Process Vents, Storage Vessels, Transfer Operations, and Wastewater (continued)		
<i>Reloading or Cleaning of Railcars, Tank Trucks, or Barges</i>		
8.	The application area includes reloading and/or cleaning of railcars, tank trucks, or barges that deliver HAPs to a storage tank. <i>If the response to Question VIII.C.8 is "No," go to Question VIII.C.11.</i>	<input type="checkbox"/> Yes <input type="checkbox"/> No
9.	The application area includes operations that are complying with § 63.119(g)(6) through the use of a closed-vent system with a control device used to reduce inlet emissions of HAPs by at least 95 percent by weight or greater.	<input type="checkbox"/> Yes <input type="checkbox"/> No
10.	The application area includes operations that are complying with § 63.119(g)(6) through the use of a vapor balancing system.	<input type="checkbox"/> Yes <input type="checkbox"/> No
<i>Transfer Racks</i>		
11.	The application area includes Group 1 transfer racks that load organic HAPs.	<input type="checkbox"/> Yes <input type="checkbox"/> No
<i>Process Wastewater Streams</i>		
12.	The application area includes process wastewater streams. <i>If the response to Question VIII.C.12 is "No," go to Question VIII.C.34.</i>	<input type="checkbox"/> Yes <input type="checkbox"/> No
13.	The application area includes process wastewater streams that are also subject to the provisions of 40 CFR Part 61, Subpart FF. <i>If the response to Question VIII.C.13 is "No," go to Question VIII.C.15.</i>	<input type="checkbox"/> Yes <input type="checkbox"/> No
14.	The application area includes process wastewater streams that are complying with 40 CFR §§ 63.110(e)(1)(i) and (e)(1)(ii).	<input type="checkbox"/> Yes <input type="checkbox"/> No
15.	The application area includes process wastewater streams that are also subject to the provisions of 40 CFR Part 61, Subpart F. <i>If the response to Question VIII.C.15 is "No," go to Question VIII.C.17.</i>	<input type="checkbox"/> Yes <input type="checkbox"/> No

Application Area-Wide Applicability Determinations and General Information
Form OP-REQ1 (Page 37)
Federal Operating Permit Program
Texas Commission on Environmental Quality

Date	Permit No.	Regulated Entity No.
04/23/2026	O3670	RN106392624

For SOP applications, answer ALL questions unless otherwise directed.

◆ For GOP applications, answer ONLY these questions unless otherwise directed.

VIII. Title 40 Code of Federal Regulations Part 63 - National Emission Standards for Hazardous Air Pollutants for Source Categories (continued)	
C. Subpart G - National Emission Standards for Organic Hazardous Air Pollutants from the Synthetic Organic Chemical Manufacturing Industry for Process Vents, Storage Vessels, Transfer Operations, and Wastewater (continued)	
<i>Process Wastewater Streams (continued)</i>	
16. The application area includes process wastewater streams utilizing the compliance option specified in 40 CFR § 63.110(f)(4)(ii).	<input type="checkbox"/> Yes <input type="checkbox"/> No
17. The application area includes process wastewater streams that are also subject to the provisions of 40 CFR Parts 260 through 272. <i>If the response to Question VIII.C.17 is "No," go to Question VIII.C.20.</i>	<input type="checkbox"/> Yes <input type="checkbox"/> No
18. The application area includes process wastewater streams complying with 40 CFR § 63.110(e)(2)(i).	<input type="checkbox"/> Yes <input type="checkbox"/> No
19. The application are includes process wastewater streams complying with 40 CFR § 63.110(e)(2)(ii).	<input type="checkbox"/> Yes <input type="checkbox"/> No
20. The application area includes process wastewater streams, located at existing sources, that are designated as Group 1; are required to be treated as Group 1 under 40 CFR § 63.110; or are determined to be Group 1 for Table 9 compounds.	<input type="checkbox"/> Yes <input type="checkbox"/> No
21. The application area includes process wastewater streams, located at existing sources that are Group 2.	<input type="checkbox"/> Yes <input type="checkbox"/> No
22. The application area includes process wastewater streams, located at new sources, that are designated as Group 1; required to be treated as Group 1 under 40 CFR § 63.110; or are determined to be Group 1 for Table 8 or Table 9 compounds.	<input type="checkbox"/> Yes <input type="checkbox"/> No
23. The application area includes process wastewater streams, located at new sources that are Group 2 for both Table 8 and Table 9 compounds.	<input type="checkbox"/> Yes <input type="checkbox"/> No

Application Area-Wide Applicability Determinations and General Information
Form OP-REQ1 (Page 38)
Federal Operating Permit Program
Texas Commission on Environmental Quality

Date	Permit No.	Regulated Entity No.
04/23/2026	O3670	RN106392624

For SOP applications, answer ALL questions unless otherwise directed.

◆ For GOP applications, answer ONLY these questions unless otherwise directed.

VIII. Title 40 Code of Federal Regulations Part 63 - National Emission Standards for Hazardous Air Pollutants for Source Categories (continued)		
C. Subpart G - National Emission Standards for Organic Hazardous Air Pollutants from the Synthetic Organic Chemical Manufacturing Industry for Process Vents, Storage Vessels, Transfer Operations, and Wastewater (continued)		
<i>Process Wastewater Streams (continued)</i>		
24.	All Group 1 wastewater streams at the site are demonstrated to have a total source mass flow rate of less than 1 MG/yr. <i>If the response to Question VIII.C.24 is "Yes," go to Question VIII.C.34.</i>	<input type="checkbox"/> Yes <input type="checkbox"/> No
25.	The site has untreated and/or partially treated Group 1 wastewater streams demonstrated to have a total source mass flow rate of less than 1 MG/yr. <i>If the response to Question VIII.C.25 is "No," go to Question VIII.C.27.</i>	<input type="checkbox"/> Yes <input type="checkbox"/> No
26.	The application area includes waste management units that receive or manage a partially treated Group 1 wastewater stream prior to or during treatment.	<input type="checkbox"/> Yes <input type="checkbox"/> No
27.	Group 1 wastewater streams or residual removed from Group 1 wastewater streams are transferred to an on-site treatment operation that is not owned or operated by the owner or operator of the source generating the waste stream or residual.	<input type="checkbox"/> Yes <input type="checkbox"/> No
28.	Group 1 wastewater streams or residual removed from Group 1 wastewater streams are transferred to an off-site treatment operation. <i>If the responses to Questions VIII.C.27 - VIII.C.28 are both "No," go to Question VIII.C.30.</i>	<input type="checkbox"/> Yes <input type="checkbox"/> No
29.	The application area includes waste management units that receive or manage a Group 1 wastewater stream, or a residual removed from a Group 1 wastewater stream prior to shipment or transport.	<input type="checkbox"/> Yes <input type="checkbox"/> No
30.	The application area includes containers that receive, manage, or treat a Group 1 wastewater stream or a residual removed from a Group 1 wastewater stream.	<input type="checkbox"/> Yes <input type="checkbox"/> No

Application Area-Wide Applicability Determinations and General Information
Form OP-REQ1 (Page 39)
Federal Operating Permit Program
Texas Commission on Environmental Quality

Date	Permit No.	Regulated Entity No.
04/23/2026	O3670	RN106392624

For SOP applications, answer ALL questions unless otherwise directed.

◆ For GOP applications, answer ONLY these questions unless otherwise directed.

VIII. Title 40 Code of Federal Regulations Part 63 - National Emission Standards for Hazardous Air Pollutants for Source Categories (continued)	
C. Subpart G - National Emission Standards for Organic Hazardous Air Pollutants from the Synthetic Organic Chemical Manufacturing Industry for Process Vents, Storage Vessels, Transfer Operations, and Wastewater (continued)	
<i>Drains</i>	
<p>31. The application area includes individual drain systems that receive or manage a Group 1 wastewater stream, or a residual removed from a Group 1 wastewater stream. <i>If the response to Question VIII.C.31 is "No," go to Question VIII.C.34.</i></p>	<input type="checkbox"/> Yes <input type="checkbox"/> No
<p>32. The application area includes individual drain systems that are complying with 40 CFR § 63.136 through the use of cover and, if vented, closed vent systems and control devices.</p>	<input type="checkbox"/> Yes <input type="checkbox"/> No
<p>33. The application area includes individual drain systems that are complying with 40 CFR § 63.136 through the use of water seals or tightly fitting caps or plugs.</p>	<input type="checkbox"/> Yes <input type="checkbox"/> No
<p>34. The application area includes drains, drain hubs, manholes, lift stations, trenches, or pipes that are part of a chemical manufacturing process unit that meets the criteria of 40 CFR § 63.100(b). <i>If the response to Question VIII.C.34 is "No," go to Question VIII.C.39.</i></p>	<input type="checkbox"/> Yes <input type="checkbox"/> No
<p>35. The application area includes drains, drain hubs, manholes, lift stations, trenches or pipes (that are part of a chemical manufacturing process unit) that meet the criteria listed in 40 CFR § 63.149(d). <i>If the response to Question VIII.C.35 is "No," go to Question VIII.C.39.</i></p>	<input type="checkbox"/> Yes <input type="checkbox"/> No
<p>36. The application area includes drains, drain hubs, manholes, lift stations, trenches, or pipes that convey water with a total annual average concentration greater than or equal to 10,000 parts per million by weight of compounds listed in 40 CFR Part 63 Subpart G, Table 9, at any flow rate.</p>	<input type="checkbox"/> Yes <input type="checkbox"/> No

Application Area-Wide Applicability Determinations and General Information
Form OP-REQ1 (Page 40)
Federal Operating Permit Program
Texas Commission on Environmental Quality

Date	Permit No.	Regulated Entity No.
04/23/2026	O3670	RN106392624

For SOP applications, answer ALL questions unless otherwise directed.

◆ For GOP applications, answer ONLY these questions unless otherwise directed.

VIII. Title 40 Code of Federal Regulations Part 63 - National Emission Standards for Hazardous Air Pollutants for Source Categories (continued)	
C. Subpart G-National Emission Standards for Organic Hazardous Air Pollutants from the Synthetic Organic Chemical Manufacturing Industry for Process Vents, Storage Vessels, Transfer Operation, and Wastewater (continued)	
<i>Drains (continued)</i>	
37. The application area includes drains, drain hubs, manholes, lift stations, trenches or pipes that convey water with a total annual average concentration greater than or equal to 1,000 parts per million by weight of compounds listed in 40 CFR Part 63 Subpart G, Table 9, at an annual average flow rate greater than or equal to 10 liters per minute.	<input type="checkbox"/> Yes <input type="checkbox"/> No
38. The application area includes drains, drain hubs, manholes, lift stations, trenches or pipes that are part of a chemical manufacturing process unit that is subject to the new source requirements of 40 CFR § 63.100(1)(1) or (1)(2); and the equipment conveys water with a total annual average concentration greater than or equal to 10 parts per million by weight of compounds listed in 40 CFR Part 63 Subpart G, Table 8, at an average annual flow rate greater than or equal to 0.02 liter per minute.	<input type="checkbox"/> Yes <input type="checkbox"/> No
<i>Gas Streams</i>	
39. The application area includes gas streams meeting the characteristics of 40 CFR § 63.107(b) - (h) or the criteria of 40 CFR § 63.113(i) and are transferred to a control device not owned or operated by the applicant.	<input type="checkbox"/> Yes <input type="checkbox"/> No
40. The applicant is unable to comply with 40 CFR §§ 63.113 - 63.118 for one or more reasons described in 40 CFR § 63.100(q)(1), (3), or (5).	<input type="checkbox"/> Yes <input type="checkbox"/> No
D. Subpart N - National Emission Standards for Chromium Emissions From Hard and Decorative Chromium Electroplating and Chromium Anodizing Tanks	
1. The application area includes chromium electroplating or chromium anodizing tanks located at hard chromium electroplating, decorative chromium electroplating, and/or chromium anodizing operations.	<input type="checkbox"/> Yes <input checked="" type="checkbox"/> No

Application Area-Wide Applicability Determinations and General Information
Form OP-REQ1 (Page 41)
Federal Operating Permit Program
Texas Commission on Environmental Quality

Date	Permit No.	Regulated Entity No.
04/23/2026	O3670	RN106392624

For SOP applications, answer ALL questions unless otherwise directed.

◆ For GOP applications, answer ONLY these questions unless otherwise directed.

VIII. Title 40 Code of Federal Regulations Part 63 - National Emission Standards for Hazardous Air Pollutants for Source Categories (continued)		
E. Subpart O - Ethylene Oxide Emissions Standards for Sterilization Facilities		
1. The application area includes sterilization facilities where ethylene oxide is used in the sterilization or fumigation of materials. <i>If the response to Question VIII.E.1 is "No," go to Section VIII.F.</i>		<input type="checkbox"/> Yes <input checked="" type="checkbox"/> No
2. Sterilization facilities located in the application area are subject to 40 CFR Part 63, Subpart O. <i>If the response to Question VIII.E.2 is "No," go to Section VIII.F.</i>		<input type="checkbox"/> Yes <input type="checkbox"/> No
3. The sterilization source has used less than 1 ton (907 kg) of ethylene oxide within all consecutive 12-month periods after December 6, 1996.		<input type="checkbox"/> Yes <input type="checkbox"/> No
4. The sterilization source has used less than 10 tons (9070 kg) of ethylene oxide within all consecutive 12-month periods after December 6, 1996.		<input type="checkbox"/> Yes <input type="checkbox"/> No
F. Subpart Q - National Emission Standards for Industrial Process Cooling Towers		
1. The application area includes industrial process cooling towers. <i>If the response to Question VIII.F.1 is "No," go to Section VIII.G.</i>		<input checked="" type="checkbox"/> Yes <input type="checkbox"/> No
2. Chromium-based water treatment chemicals have been used on or after September 8, 1994.		<input type="checkbox"/> Yes <input checked="" type="checkbox"/> No
G. Subpart R - National Emission Standards for Gasoline Distribution Facilities (Bulk Gasoline Terminals and Pipeline Breakout Stations)		
1. The application area includes a bulk gasoline terminal.		<input type="checkbox"/> Yes <input checked="" type="checkbox"/> No
2. The application area includes a pipeline breakout station. <i>If the responses to Questions VIII.G.1 and VIII.G.2 are both "No," go to Section VIII.H.</i>		<input type="checkbox"/> Yes <input checked="" type="checkbox"/> No
3. The bulk gasoline terminal or pipeline breakout station is located within a contiguous area and under common control with another bulk gasoline terminal or a pipeline breakout station. <i>If the response to Question VIII.G.3 is "Yes," go to Question VIII.G.10.</i>		<input type="checkbox"/> Yes <input type="checkbox"/> No

Application Area-Wide Applicability Determinations and General Information
Form OP-REQ1 (Page 42)
Federal Operating Permit Program
Texas Commission on Environmental Quality

Date	Permit No.	Regulated Entity No.
04/23/2026	O3670	RN106392624

For SOP applications, answer ALL questions unless otherwise directed.

◆ For GOP applications, answer ONLY these questions unless otherwise directed.

VIII. Title 40 Code of Federal Regulations Part 63 - National Emission Standards for Hazardous Air Pollutants for Source Categories (continued)		
G. Subpart R - National Emission Standards for Gasoline Distribution Facilities (Bulk Gasoline Terminals and Pipeline Breakout Stations) (continued)		
4.	The bulk gasoline terminal or pipeline breakout station is located within a contiguous area and under common control with sources, other than bulk gasoline terminals or pipeline breakout stations that emit or have the potential to emit HAPs. <i>If the response to Question VIII.G.4 is "Yes," go to Question VIII.G.10.</i>	<input type="checkbox"/> Yes <input type="checkbox"/> No
5.	An emissions screening factor was calculated for the bulk gasoline terminal or pipeline breakout station. <i>If the response to Question VIII.G.5 is "No," go to Question VIII.G.10.</i>	<input type="checkbox"/> Yes <input type="checkbox"/> No
6.	The value 0.04(OE) is less than 5% of the value of the bulk gasoline terminal emissions screening factor (ET) or the pipeline breakout station emissions screening factor (Ep). <i>If the response to Question VIII.G.6 is "No," go to Question VIII.G.10.</i>	<input type="checkbox"/> Yes <input type="checkbox"/> No
7.	Emissions screening factor less than 0.5 (ET or EP < 0.5). <i>If the response to Question VIII.G.7 is "Yes," go to Section VIII.H.</i>	<input type="checkbox"/> Yes <input type="checkbox"/> No
8.	Emissions screening factor greater than or equal to 0.5, but less than 1.0 (0.5 ≤ ET or EP < 1.0). <i>If the response to Question VIII.G.8 is "Yes," go to Section VIII.H.</i>	<input type="checkbox"/> Yes <input type="checkbox"/> No
9.	Emissions screening factor greater than or equal to 1.0 (ET or EP ≥ 1.0). <i>If the response to Question VIII.G.9 is "Yes," go to Question VIII.G.11.</i>	<input type="checkbox"/> Yes <input type="checkbox"/> No
10.	The site at which the application area is located is a major source of HAP. <i>If the response to Question VIII.G.10 is "No," go to Section VIII.H.</i>	<input type="checkbox"/> Yes <input type="checkbox"/> No
11.	The application area is using an alternative leak monitoring program as described in 40 CFR § 63.424(f).	<input type="checkbox"/> Yes <input type="checkbox"/> No

Application Area-Wide Applicability Determinations and General Information
Form OP-REQ1 (Page 43)
Federal Operating Permit Program
Texas Commission on Environmental Quality

Date	Permit No.	Regulated Entity No.
04/23/2026	O3670	RN106392624

For SOP applications, answer ALL questions unless otherwise directed.

◆ For GOP applications, answer ONLY these questions unless otherwise directed.

VIII. Title 40 Code of Federal Regulations Part 63 - National Emission Standards for Hazardous Air Pollutants for Source Categories (continued)	
H. Subpart S - National Emission Standards for Hazardous Air Pollutants from the Pulp and Paper Industry	
<p>1. The application area includes processes that produce pulp, paper, or paperboard and are located at a plant site that is a major source of HAPs as defined in 40 CFR § 63.2. <i>If the response to Question VIII.H.1 is "No," go to Section VIII.I.</i></p>	<input type="checkbox"/> Yes <input checked="" type="checkbox"/> No
<p>2. The application area uses processes and materials specified in 40 CFR § 63.440(a)(1) - (3). <i>If the response to Question VIII.H.2 is "No," go to Section VIII.I.</i></p>	<input type="checkbox"/> Yes <input type="checkbox"/> No
<p>3. The application area includes one or more sources subject to 40 CFR Part 63, Subpart S that are existing sources. <i>If the response to Question VIII.H.3 is "No," go to Section VIII.I.</i></p>	<input type="checkbox"/> Yes <input type="checkbox"/> No
<p>4. The application area includes one or more kraft pulping systems that are existing sources.</p>	<input type="checkbox"/> Yes <input type="checkbox"/> No
<p>5. The application area includes one or more dissolving-grade bleaching systems that are existing sources at a kraft or sulfite pulping mill.</p>	<input type="checkbox"/> Yes <input type="checkbox"/> No
<p>6. The application area includes bleaching systems that are existing sources and are complying with the Voluntary Advanced Technology Incentives Program for Effluent Limitation Guidelines in 40 CFR § 430.24. <i>If the response to Question VIII.H.6 is "No," go to Section VIII.I.</i></p>	<input type="checkbox"/> Yes <input type="checkbox"/> No
<p>7. The application area includes bleaching systems that are complying with 40 CFR § 63.440(d)(3)(i).</p>	<input type="checkbox"/> Yes <input type="checkbox"/> No
<p>8. The application area includes bleaching systems that are complying with 40 CFR § 63.440(d)(3)(ii).</p>	<input type="checkbox"/> Yes <input type="checkbox"/> No

Application Area-Wide Applicability Determinations and General Information
Form OP-REQ1 (Page 44)
Federal Operating Permit Program
Texas Commission on Environmental Quality

Date	Permit No.	Regulated Entity No.
04/23/2026	O3670	RN106392624

For SOP applications, answer ALL questions unless otherwise directed.

◆ For GOP applications, answer ONLY these questions unless otherwise directed.

VIII. Title 40 Code of Federal Regulations Part 63 - National Emission Standards for Hazardous Air Pollutants for Source Categories (continued)		
I. Subpart T - National Emission Standards for Halogenated Solvent Cleaning		
1.	The application area includes an individual batch vapor, in-line vapor, in-line cold, and/or batch cold solvent cleaning machine that uses a hazardous air pollutant (HAP) solvent, or any combination of halogenated HAP solvents, in a total concentration greater than 5% by weight, as a cleaning and/or drying agent.	<input type="checkbox"/> Yes <input checked="" type="checkbox"/> No
2.	The application area is located at a major source and includes solvent cleaning machines, qualifying as affected facilities, that use perchloroethylene, trichloroethylene or methylene chloride.	<input type="checkbox"/> Yes <input checked="" type="checkbox"/> No
3.	The application area is located at an area source and includes solvent cleaning machines, other than cold batch cleaning machines, that use perchloroethylene, trichloroethylene or methylene chloride.	<input type="checkbox"/> Yes <input checked="" type="checkbox"/> No
J. Subpart U - National Emission Standards for Hazardous Air Pollutant Emissions: Group 1 Polymers and Resins		
1.	The application area includes elastomer product process units and/or wastewater streams and wastewater operations that are associated with elastomer product process units. <i>If the response to Question VIII.J.1 is "No," go to Section VIII.K.</i>	<input type="checkbox"/> Yes <input checked="" type="checkbox"/> No
2.	Elastomer product process units and/or wastewater streams and wastewater operations located in the application area are subject to 40 CFR Part 63, Subpart U. <i>If the response to Question VIII.J.2 is "No," go to Section VIII.K.</i>	<input type="checkbox"/> Yes <input type="checkbox"/> No
3.	The application area includes process wastewater streams that are designated as Group 1 or are determined to be Group 1 for organic HAPs as defined in 40 CFR § 63.482.	<input type="checkbox"/> Yes <input type="checkbox"/> No
4.	The application area includes process wastewater streams that are Group 2 for organic HAPs as defined in 40 CFR § 63.482.	<input type="checkbox"/> Yes <input type="checkbox"/> No

Application Area-Wide Applicability Determinations and General Information
Form OP-REQ1 (Page 45)
Federal Operating Permit Program
Texas Commission on Environmental Quality

Date	Permit No.	Regulated Entity No.
04/23/2026	O3670	RN106392624

For SOP applications, answer ALL questions unless otherwise directed.

◆ For GOP applications, answer ONLY these questions unless otherwise directed.

VIII. Title 40 Code of Federal Regulations Part 63 - National Emission Standards for Hazardous Air Pollutants for Source Categories (continued)		
J. Subpart U - National Emission Standards for Hazardous Air Pollutant Emissions: Group 1 Polymers and Resins (continued)		
5.	All Group 1 wastewater streams at the site are demonstrated to have a total source mass flow rate of less than 1 MG/yr. <i>If the response to Question VIII.J.5 is "Yes," go to Question VIII.J.15.</i>	<input type="checkbox"/> Yes <input type="checkbox"/> No
6.	The site has untreated and/or partially treated Group 1 wastewater streams demonstrated to have a total source mass flow rate of less than 1 MG/yr. <i>If the response to Question VIII.J.6 is "No," go to Question VIII.J.8.</i>	<input type="checkbox"/> Yes <input type="checkbox"/> No
7.	The application area includes waste management units that receive or manage a partially treated Group 1 wastewater stream prior to or during treatment.	<input type="checkbox"/> Yes <input type="checkbox"/> No
8.	Group 1 wastewater streams or residual removed from Group 1 wastewater streams are transferred to an on-site treatment operation that is not owned or operated by the owner or operator of the source generating the waste stream or residual.	<input type="checkbox"/> Yes <input type="checkbox"/> No
9.	Group 1 wastewater streams or residual removed from Group 1 wastewater streams are transferred to an off-site treatment operation. <i>If the responses to Questions VIII.J.8 - VIII.J.9 are both "No," go to Question VIII.J.11.</i>	<input type="checkbox"/> Yes <input type="checkbox"/> No
10.	The application area includes waste management units that receive or manage a Group 1 wastewater stream, or a residual removed from a Group 1 wastewater stream prior to shipment or transport.	<input type="checkbox"/> Yes <input type="checkbox"/> No

Application Area-Wide Applicability Determinations and General Information
Form OP-REQ1 (Page 46)
Federal Operating Permit Program
Texas Commission on Environmental Quality

Date	Permit No.	Regulated Entity No.
04/23/2026	O3670	RN106392624

For SOP applications, answer ALL questions unless otherwise directed.

◆ For GOP applications, answer ONLY these questions unless otherwise directed.

VIII. Title 40 Code of Federal Regulations Part 63 - National Emission Standards for Hazardous Air Pollutants for Source Categories (continued)	
J. Subpart U - National Emission Standards for Hazardous Air Pollutant Emissions: Group 1 Polymers and Resins (continued)	
<i>Containers</i>	
11. The application area includes containers that receive, manage, or treat a Group 1 wastewater stream or a residual removed from a Group 1 wastewater stream.	<input type="checkbox"/> Yes <input type="checkbox"/> No
<i>Drains</i>	
12. The application area includes individual drain systems that receive or manage a Group 1 wastewater stream, or a residual removed from a Group 1 wastewater stream. <i>If the response to Question VIII.J.12 is "No," go to Question VIII.J.15.</i>	<input type="checkbox"/> Yes <input type="checkbox"/> No
13. The application area includes individual drain systems that are complying with 40 CFR § 63.136 through the use of cover and, if vented, closed vent systems and control devices.	<input type="checkbox"/> Yes <input type="checkbox"/> No
14. The application area includes individual drain systems that are complying with 40 CFR § 63.136 through the use of water seals or tightly fitting caps or plugs.	<input type="checkbox"/> Yes <input type="checkbox"/> No
15. The application area includes drains, drain hubs, manholes, lift stations, trenches, or pipes that are part of an elastomer product process unit. <i>If the response to Question VIII.J.15 is "No," go to Section VIII.K.</i>	<input type="checkbox"/> Yes <input type="checkbox"/> No
16. The application area includes drains, drain hubs, manholes, lift stations, trenches or pipes that meet the criteria listed in 40 CFR § 63.149(d) and § 63.501(a)(12). <i>If the response to Question VIII.J.16 is "No," go to Section VIII.K.</i>	<input type="checkbox"/> Yes <input type="checkbox"/> No

Application Area-Wide Applicability Determinations and General Information
Form OP-REQ1 (Page 47)
Federal Operating Permit Program
Texas Commission on Environmental Quality

Date	Permit No.	Regulated Entity No.
04/23/2026	O3670	RN106392624

For SOP applications, answer ALL questions unless otherwise directed.

◆ For GOP applications, answer ONLY these questions unless otherwise directed.

VIII. Title 40 Code of Federal Regulations Part 63 - National Emission Standards for Hazardous Air Pollutants for Source Categories (continued)	
J. Subpart U - National Emission Standards for Hazardous Air Pollutant Emissions: Group 1 Polymers and Resins (continued)	
<i>Drains (continued)</i>	
17. The application area includes drains, drain hubs, manholes, lift stations, trenches, or pipes that convey water with a total annual average concentration greater than or equal to 10,000 parts per million by weight of compounds meeting the definition of organic HAP in 40 CFR § 63.482, at any flow rate.	<input type="checkbox"/> Yes <input type="checkbox"/> No
18. The application area includes drains, drain hubs, manholes, lift stations, trenches or pipes that convey water with a total annual average concentration greater than or equal to 1,000 parts per million by weight of compounds meeting the definition of organic HAP in 40 CFR § 63.482, at an annual average flow rate greater than or equal to 10 liters per minute.	<input type="checkbox"/> Yes <input type="checkbox"/> No
19. The application area includes drains, drain hubs, manholes, lift stations, trenches or pipes that are part of an elastomer product process unit that is a new affected source or part of a new affected source and the equipment conveys water with a total annual average concentration greater than or equal to 10 parts per million by weight of compounds meeting the definition of organic HAP in 40 CFR § 63.482, at an average annual flow rate greater than or equal to 0.02 liter per minute.	<input type="checkbox"/> Yes <input type="checkbox"/> No
K. Subpart W - National Emission Standards for Hazardous Air Pollutants for Epoxy Resins Production and Non-nylon Polyamides Production	
1. The manufacture of basic liquid epoxy resins (BLR) and/or manufacture of wet strength resins (WSR) is conducted in the application area. <i>If the response to Question VIII.K.1 is "No" or "N/A," go to Section VIII.L.</i>	<input type="checkbox"/> Yes <input checked="" type="checkbox"/> No <input type="checkbox"/> N/A
2. The application area includes a BLR and/or WSR research and development facility.	<input type="checkbox"/> Yes <input type="checkbox"/> No

Application Area-Wide Applicability Determinations and General Information
Form OP-REQ1 (Page 48)
Federal Operating Permit Program
Texas Commission on Environmental Quality

Date	Permit No.	Regulated Entity No.
04/23/2026	O3670	RN106392624

For SOP applications, answer ALL questions unless otherwise directed.

◆ For GOP applications, answer ONLY these questions unless otherwise directed.

VIII. Title 40 Code of Federal Regulations Part 63 - National Emission Standards for Hazardous Air Pollutants for Source Categories (continued)	
L. Subpart X - National Emission Standards for Hazardous Air Pollutants from Secondary Lead Smelting	
1. The application area includes one or more of the affected sources in 40 CFR § 63.541(a) that are located at a secondary lead smelter. <i>If the response to Question VIII.L.1 is "No" or "N/A," go to Section VIII.M.</i>	<input type="checkbox"/> Yes <input checked="" type="checkbox"/> No <input type="checkbox"/> N/A
2. The application area is using and approved alternate to the requirements of § 63.545(c)(1)-(5) for control of fugitive dust emission sources.	<input type="checkbox"/> Yes <input type="checkbox"/> No
M. Subpart Y - National Emission Standards for Marine Tank Vessel Loading Operations	
1. The application area includes marine tank vessel loading operations that are specified in 40 CFR § 63.560 and located at an affected source as defined in 40 CFR § 63.561.	<input type="checkbox"/> Yes <input checked="" type="checkbox"/> No
N. Subpart CC - National Emission Standards for Hazardous Air Pollutants from Petroleum Refineries	
<i>Applicability</i>	
1. The application area includes petroleum refining process units and/or related emission points that are specified in 40 CFR § 63.640(c)(1) - (c)(7). <i>If the response to Question VIII.N.1 is "No," go to Section VIII.O.</i>	<input type="checkbox"/> Yes <input checked="" type="checkbox"/> No
2. All petroleum refining process units/and or related emission points within the application area are specified in 40 CFR § 63.640(g)(1) - (g)(7). <i>If the response to Question VIII.N.2 is "Yes," go to Section VIII.O.</i>	<input type="checkbox"/> Yes <input type="checkbox"/> No

Application Area-Wide Applicability Determinations and General Information
Form OP-REQ1 (Page 49)
Federal Operating Permit Program
Texas Commission on Environmental Quality

Date	Permit No.	Regulated Entity No.
04/23/2026	O3670	RN106392624

For SOP applications, answer ALL questions unless otherwise directed.

◆ For GOP applications, answer ONLY these questions unless otherwise directed.

VIII. Title 40 Code of Federal Regulations Part 63 - National Emission Standards for Hazardous Air Pollutants for Source Categories (continued)	
N. Subpart CC - National Emission Standards for Hazardous Air Pollutants from Petroleum Refineries (continued)	
<i>Applicability (continued)</i>	
<p>3. The application area is located at a plant site that is a major source as defined in the Federal Clean Air Act § 112(a). <i>If the response to Question VIII.N.3 is "No," go to Section VIII.O.</i></p>	<input type="checkbox"/> Yes <input type="checkbox"/> No
<p>4. The application area is located at a plant site which emits or has equipment containing/contacting one or more of the HAPs listed in table 1 of 40 CFR Part 63, Subpart CC. <i>If the response to Question VIII.N.4 is "No," go to Section VIII.O.</i></p>	<input type="checkbox"/> Yes <input type="checkbox"/> No
<p>5. The application area includes Group 1 wastewater streams that are not conveyed, stored, or treated in a wastewater stream management unit that also receives streams subject to the provisions of 40 CFR §§ 63.133 - 63.147 of Subpart G wastewater provisions section.</p>	<input type="checkbox"/> Yes <input type="checkbox"/> No
<p>6. The application area includes Group 2 wastewater streams that are not conveyed, stored, or treated in a wastewater stream management unit that also receives streams subject to the provisions of 40 CFR §§ 63.133 - 63.147 of Subpart G wastewater provisions section.</p>	<input type="checkbox"/> Yes <input type="checkbox"/> No
<p>7. The application area includes Group 1 or Group 2 wastewater streams that are conveyed, stored, or treated in a wastewater stream management unit that also receives streams subject to the provisions of 40 CFR §§ 63.133 - 63.147 of Subpart G wastewater provisions section. <i>If the response to Question VIII.N.7 is "No," go to Question VIII.N.13.</i></p>	<input type="checkbox"/> Yes <input type="checkbox"/> No
<p>8. The application area includes Group 1 or Group 2 wastewater streams that are complying with 40 CFR § 63.640(o)(2)(i).</p>	<input type="checkbox"/> Yes <input type="checkbox"/> No

Application Area-Wide Applicability Determinations and General Information
Form OP-REQ1 (Page 50)
Federal Operating Permit Program
Texas Commission on Environmental Quality

Date	Permit No.	Regulated Entity No.
04/23/2026	O3670	RN106392624

For SOP applications, answer ALL questions unless otherwise directed.

◆ For GOP applications, answer ONLY these questions unless otherwise directed.

VIII. Title 40 Code of Federal Regulations Part 63 - National Emission Standards for	
N. Subpart CC - National Emission Standards for Hazardous Air Pollutants from Petroleum Refineries (continued)	
<i>Applicability (continued)</i>	
9. The application area includes Group 1 or Group 2 wastewater streams that are complying with 40 CFR § 63.640(o)(2)(ii). <i>If the response to Question VIII.N.9 is "No," go to Question VIII.N.13.</i>	<input type="checkbox"/> Yes <input type="checkbox"/> No
10. The application area includes Group 2 wastewater streams or organic streams whose benzene emissions are subject to control through the use of one or more treatment processes or waste management units under the provisions of 40 CFR Part 61, Subpart FF on or after December 31, 1992.	<input type="checkbox"/> Yes <input type="checkbox"/> No
Containers, Drains, and other Appurtenances	
11. The application area includes containers that are subject to the requirements of 40 CFR § 63.135 as a result of complying with 40 CFR § 63.640(o)(2)(ii).	<input type="checkbox"/> Yes <input type="checkbox"/> No
12. The application area includes individual drain systems that are subject to the requirements of 40 CFR § 63.136 as a result of complying with 40 CFR § 63.640(o)(2)(ii).	<input type="checkbox"/> Yes <input type="checkbox"/> No
13. The application area includes Group 1 gasoline loading racks as specified in § 63.650(a).	<input type="checkbox"/> Yes <input type="checkbox"/> No
O. Subpart DD - National Emission Standards for Off-site Waste and Recovery Operations	
1. The application area receives material that meets the criteria for off-site material as specified in 40 CFR § 63.680(b)(1). <i>If the response to Question VIII.O.1 is "No" or "N/A," go to Section VIII.P</i>	<input type="checkbox"/> Yes <input checked="" type="checkbox"/> No <input type="checkbox"/> N/A
2. Materials specified in 40 CFR § 63.680(b)(2) are received at the application area.	<input type="checkbox"/> Yes <input type="checkbox"/> No
3. The application area has a waste management operation receiving off-site material and is regulated under 40 CFR Part 264 or Part 265.	<input type="checkbox"/> Yes <input type="checkbox"/> No

Application Area-Wide Applicability Determinations and General Information
Form OP-REQ1 (Page 51)
Federal Operating Permit Program
Texas Commission on Environmental Quality

Date	Permit No.	Regulated Entity No.
04/23/2026	O3670	RN106392624

For SOP applications, answer ALL questions unless otherwise directed.

◆ For GOP applications, answer ONLY these questions unless otherwise directed.

VIII. Title 40 Code of Federal Regulations Part 63 - National Emission Standards for Hazardous Air Pollutants for Source Categories (continued)		
O. Subpart DD - National Emission Standards for Off-site Waste and Recovery Operations (continued)		
4.	The application area has a waste management operation treating wastewater which is an off-site material and is exempted under 40 CFR § 264.1(g)(6) or § 265.1(c)(10).	<input type="checkbox"/> Yes <input type="checkbox"/> No
5.	The application area has an operation subject to Clean Water Act, § 402 or § 307(b) but is not owned by a “state” or “municipality.”	<input type="checkbox"/> Yes <input type="checkbox"/> No
6.	The predominant activity in the application area is the treatment of wastewater received from off-site.	<input type="checkbox"/> Yes <input type="checkbox"/> No
7.	The application area has a recovery operation that recycles or reprocesses hazardous waste which is an off-site material and is exempted under 40 CFR § 264.1(g)(2) or § 265.1(c)(6).	<input type="checkbox"/> Yes <input type="checkbox"/> No
8.	The application area has a recovery operation that recycles or reprocesses used solvent which is an off-site material and is not part of a chemical, petroleum, or other manufacturing process that is required to use air emission controls by another subpart of 40 CFR Part 63 or Part 61.	<input type="checkbox"/> YES <input type="checkbox"/> No
9.	The application area has a recovery operation that re-refines or reprocesses used oil which is an off-site material and is regulated under 40 CFR Part 279, Subpart F (Standards for Used Oil Processors and Refiners).	<input type="checkbox"/> Yes <input type="checkbox"/> No
10.	The application area is located at a site where the total annual quantity of HAPs in the off-site material is less than 1 megagram per year. <i>If the response to Question VIII.O.10 is “Yes,” go to Section VIII.P.</i>	<input type="checkbox"/> Yes <input type="checkbox"/> No

Application Area-Wide Applicability Determinations and General Information
Form OP-REQ1 (Page 52)
Federal Operating Permit Program
Texas Commission on Environmental Quality

Date	Permit No.	Regulated Entity No.
04/23/2026	O3670	RN106392624

For SOP applications, answer ALL questions unless otherwise directed.

◆ For GOP applications, answer ONLY these questions unless otherwise directed.

VIII. Title 40 Code of Federal Regulations Part 63 - National Emission Standards for	
O. Subpart DD - National Emission Standards for Off-site Waste and Recovery Operations (continued)	
<p>11. The application area receives offsite materials with average VOHAP concentration less than 500 ppmw at the point of delivery that are not combined with materials having a VOHAP concentration of 500 ppmw or greater. <i>If the response to Question VIII.O.11 is "No," go to Question VIII.O.14.</i></p>	<input type="checkbox"/> Yes <input type="checkbox"/> No
<p>12. VOHAP concentration is determined by direct measurement.</p>	<input type="checkbox"/> Yes <input type="checkbox"/> No
<p>13. VOHAP concentration is based on knowledge of the off-site material.</p>	<input type="checkbox"/> Yes <input type="checkbox"/> No
<p>14. The application area includes an equipment component that is a pump, compressor, and agitator, pressure relief device, sampling connection system, open-ended valve or line, valve, connector or instrumentation system. <i>If the response to Question VIII.O.14 is "No," go to Question VIII.O.17.</i></p>	<input type="checkbox"/> Yes <input type="checkbox"/> No
<p>15. An equipment component in the application area contains or contacts off-site material with a HAP concentration greater than or equal to 10% by weight.</p>	<input type="checkbox"/> Yes <input type="checkbox"/> No
<p>16. An equipment component in the application area is intended to operate 300 hours or more during a 12-month period.</p>	<input type="checkbox"/> Yes <input type="checkbox"/> No
<p>17. The application area includes containers that manage non-exempt off-site material.</p>	<input type="checkbox"/> Yes <input type="checkbox"/> No
<p>18. The application area includes individual drain systems that manage non-exempt off-site materials.</p>	<input type="checkbox"/> Yes <input type="checkbox"/> No

Application Area-Wide Applicability Determinations and General Information
Form OP-REQ1 (Page 53)
Federal Operating Permit Program
Texas Commission on Environmental Quality

Date	Permit No.	Regulated Entity No.
04/23/2026	O3670	RN106392624

For SOP applications, answer ALL questions unless otherwise directed.

◆ For GOP applications, answer ONLY these questions unless otherwise directed.

VIII. Title 40 Code of Federal Regulations Part 63 - National Emission Standards for		
P. Subpart GG - National Emission Standards for Aerospace Manufacturing and Rework Facilities		
1.	The application area includes facilities that manufacture or rework commercial, civil, or military aerospace vehicles or components. <i>If the response to Question VIII.P.1 is "No" or "N/A," go to Section VIII.Q.</i>	<input type="checkbox"/> Yes <input checked="" type="checkbox"/> No <input type="checkbox"/> N/A
2.	The application area includes one or more of the affected sources specified in 40 CFR § 63.741(c)(1) - (7).	<input type="checkbox"/> Yes <input type="checkbox"/> No
Q. Subpart HH - National Emission Standards for Hazardous Air Pollutants From Oil and Natural Gas Production Facilities.		
◆ 1.	The application area contains facilities that process, upgrade or store hydrocarbon liquids that are located at oil and natural gas production facilities prior to the point of custody transfer.	<input type="checkbox"/> Yes <input checked="" type="checkbox"/> No
◆ 2.	The application area contains facilities that process, upgrade or store natural gas prior to the point at which natural gas enters the natural gas transmission and storage source category or is delivered to a final end user. <i>For SOP applications, if the responses to Questions VIII.Q.1 and VIII.Q.2 are both "No," go to Section VIII.R.</i> <i>For GOP applications, if the responses to Questions VIII.Q.1 and VIII.Q.2 are both "No," go to Section VIII.Z.</i>	<input type="checkbox"/> Yes <input checked="" type="checkbox"/> No
◆ 3.	The application area contains only facilities that exclusively process, store or transfer black oil as defined in § 63.761. <i>For SOP applications, if the response to Question VIII.Q.3 is "Yes," go to Section VIII.R.</i> <i>For GOP applications, if the response to Question VIII.Q.3 is "Yes," go to Section VIII.Z.</i>	<input type="checkbox"/> Yes <input type="checkbox"/> No
◆ 4.	The application area is located at a site that is a major source of HAP. <i>If the response to Question VIII.Q.4 is "No," go to Question VIII.Q.6.</i>	<input type="checkbox"/> Yes <input type="checkbox"/> No

Application Area-Wide Applicability Determinations and General Information
Form OP-REQ1 (Page 54)
Federal Operating Permit Program
Texas Commission on Environmental Quality

Date	Permit No.	Regulated Entity No.
04/23/2026	O3670	RN106392624

For SOP applications, answer ALL questions unless otherwise directed.

◆ For GOP applications, answer ONLY these questions unless otherwise directed.

VIII. Title 40 Code of Federal Regulations Part 63 - National Emission Standards for Hazardous Air Pollutants for Source Categories (continued)	
Q. Subpart - HH - National Emission Standards for Hazardous Air Pollutants From Oil and Natural Gas Production Facilities (continued)	
<p>◆ 5. The application area contains only a facility, prior to the point of custody transfer, with facility-wide actual annual average natural gas throughput less than 18.4 thousand standard cubic meters (649,789.9 ft³) per day and a facility-wide actual annual average hydrocarbon liquid throughput less than 39,700 liters (10,487.6 gallons) per day.</p> <p><i>For SOP applications, if the response to Question VIII.Q.5 is "Yes," go to Section VIII.R.</i></p> <p><i>For GOP applications, if the response to Question VIII.Q.5 is "Yes," go to Section VIII.Z.</i></p> <p><i>For all applications, if the response to Question VIII.Q.5 is "No," go to Question VIII.Q.9.</i></p>	<input type="checkbox"/> Yes <input type="checkbox"/> No
<p>◆ 6. The application area includes a triethylene glycol (TEG) dehydration unit.</p> <p><i>For SOP applications, if the answer to Question VIII.Q.6 is "No," go to Section VIII.R. For GOP applications, if the response to Question VIII.Q.6 is "No," go to Section VIII.Z.</i></p>	<input type="checkbox"/> Yes <input type="checkbox"/> No
<p>◆ 7. The application area is located at a site that is within the boundaries of UA plus offset or a UC, as defined in 40 CFR § 63.761.</p>	<input type="checkbox"/> Yes <input type="checkbox"/> No
<p>◆ 8. The site has actual emissions of 5 tons per year or more of a single HAP, or 12.5 tons per year or more of a combination of HAP.</p>	<input type="checkbox"/> Yes <input type="checkbox"/> No
<p>◆ 9. Emissions for major source determination are being estimated based on the maximum natural gas or hydrocarbon liquid throughput as calculated in § 63.760(a)(1)(i)-(iii).</p>	<input type="checkbox"/> Yes <input type="checkbox"/> No

Application Area-Wide Applicability Determinations and General Information
Form OP-REQ1 (Page 55)
Federal Operating Permit Program
Texas Commission on Environmental Quality

Date	Permit No.	Regulated Entity No.
04/23/2026	O3670	RN106392624

For SOP applications, answer ALL questions unless otherwise directed.

◆ For GOP applications, answer ONLY these questions unless otherwise directed.

VIII. Title 40 Code of Federal Regulations Part 63 - National Emission Standards for Hazardous Air Pollutants for Source Categories (continued)		
R. Subpart II - National Emission Standards for Shipbuilding and Ship Repair (Surface Coating)		
1.	The application area includes shipbuilding or ship repair operations. <i>If the response to Question VIII.R.1 is "No," go to Section VIII.S.</i>	<input type="checkbox"/> Yes <input checked="" type="checkbox"/> No
2.	Shipbuilding or ship repair operations located in the application area are subject to 40 CFR Part 63, Subpart II.	<input type="checkbox"/> Yes <input type="checkbox"/> No
S. Subpart JJ - National Emission Standards for Wood Furniture Manufacturing Operations		
1.	The application area includes wood furniture manufacturing operations and/or wood furniture component manufacturing operations. <i>If the response to Question VIII.S.1 is "No" or "N/A," go to Section VIII.T.</i>	<input type="checkbox"/> Yes <input checked="" type="checkbox"/> No <input type="checkbox"/> N/A
2.	The application area meets the definition of an "incidental wood manufacturer" as defined in 40 CFR § 63.801.	<input type="checkbox"/> Yes <input type="checkbox"/> No
T. Subpart KK - National Emission Standards for the Printing and Publishing Industry		
1.	The application area includes publication rotogravure, product and packaging rotogravure, or wide-web flexographic printing presses.	<input type="checkbox"/> Yes <input checked="" type="checkbox"/> No <input type="checkbox"/> N/A
U. Subpart PP - National Emission Standards for Containers		
1.	The application area includes containers for which another 40 CFR Part 60, 61, or 63 subpart references the use of 40 CFR Part 63, Subpart PP for the control of air emissions. <i>If the response to Question VIII.U.1 is "No," go to Section VIII.V.</i>	<input type="checkbox"/> Yes <input checked="" type="checkbox"/> No
2.	The application area includes containers using Container Level 1 controls.	<input type="checkbox"/> Yes <input type="checkbox"/> No
3.	The application area includes containers using Container Level 2 controls.	<input type="checkbox"/> Yes <input type="checkbox"/> No

Application Area-Wide Applicability Determinations and General Information
Form OP-REQ1 (Page 56)
Federal Operating Permit Program
Texas Commission on Environmental Quality

Date	Permit No.	Regulated Entity No.
04/23/2026	O3670	RN106392624

For SOP applications, answer ALL questions unless otherwise directed.

◆ For GOP applications, answer ONLY these questions unless otherwise directed.

VIII. Title 40 Code of Federal Regulations Part 63 - National Emission Standards for Hazardous Air Pollutants for Source Categories (continued)		
U. Subpart PP - National Emission Standards for Containers (continued)		
4.	The application area includes containers using Container Level 3 controls.	<input type="checkbox"/> Yes <input type="checkbox"/> No
V. Subpart RR - National Emission Standards for Individual Drain Systems		
1.	The application area includes individual drain systems for which another 40 CFR Part 60, 61, or 63 subpart references the use of 40 CFR Part 63, Subpart RR for the control of air emissions.	<input type="checkbox"/> Yes <input checked="" type="checkbox"/> No
W. Subpart YY - National Emission Standards for Hazardous Air Pollutants for Source Categories - Generic Maximum Achievable Control Technology Standards		
1.	The application area includes an acetal resins production process unit; an acrylic and modacrylic fiber production process unit complying with 40 CFR § 63.1103(b)(3)(i); or an existing polycarbonate production process.	<input type="checkbox"/> Yes <input checked="" type="checkbox"/> No
2.	The application area includes process wastewater streams generated from an acetal resins production process unit; an acrylic and modacrylic fiber production process unit complying with 40 CFR § 63.1103(b)(3)(i); or an existing polycarbonate production process. <i>If the responses to Questions VIII.W.1 and VIII.W.2 are both "No," go to Question VIII.W.20.</i>	<input type="checkbox"/> Yes <input checked="" type="checkbox"/> No
3.	The application area includes process wastewater streams that are designated as Group 1 or are determined to be Group 1 under the requirements of 40 CFR § 63.132(c).	<input type="checkbox"/> Yes <input type="checkbox"/> No
4.	The application area includes process wastewater streams that are determined to be Group 2 under the requirements of 40 CFR § 63.132(c).	<input type="checkbox"/> Yes <input type="checkbox"/> No
5.	All Group 1 wastewater streams at the site are determined to have a total source mass flow rate of less than 1 MG/yr.	<input type="checkbox"/> Yes <input type="checkbox"/> No
6.	The site has untreated and/or partially treated Group 1 wastewater streams demonstrated to have a total source mass flow rate of less than 1 MG/yr. <i>If the response to Question VIII.W.6 is "No," go to Question VIII.W.8.</i>	<input type="checkbox"/> Yes <input type="checkbox"/> No

Application Area-Wide Applicability Determinations and General Information
Form OP-REQ1 (Page 57)
Federal Operating Permit Program
Texas Commission on Environmental Quality

Date	Permit No.	Regulated Entity No.
04/23/2026	O3670	RN106392624

For SOP applications, answer ALL questions unless otherwise directed.

◆ For GOP applications, answer ONLY these questions unless otherwise directed.

VIII. Title 40 Code of Federal Regulations Part 63 - National Emission Standards for Hazardous Air Pollutants for Source Categories (continued)		
W. Subpart YY - National Emission Standards for Hazardous Air Pollutants for Source Categories - Generic Maximum Achievable Control Technology Standards (continued)		
7.	The application area includes waste management units that receive or manage a partially treated Group 1 wastewater stream prior to or during treatment.	<input type="checkbox"/> Yes <input type="checkbox"/> No
8.	Group 1 wastewater streams or residual removed from Group 1 wastewater streams are transferred to an on-site treatment operation that is not owned or operated by the owner or operator of the source generating the waste stream or residual.	<input type="checkbox"/> Yes <input type="checkbox"/> No
9.	Group 1 wastewater streams or residual removed from Group 1 wastewater streams are transferred to an off-site treatment operation. <i>If the responses to Questions VIII.W.8 and W.9 are both "No," go to Question VIII.W.11.</i>	<input type="checkbox"/> Yes <input type="checkbox"/> No
10.	The application area includes waste management units that receive or manage a Group 1 wastewater stream, or a residual removed from a Group 1 wastewater stream prior to shipment or transport.	<input type="checkbox"/> Yes <input type="checkbox"/> No
11.	The application area includes containers that receive, manage, or treat a Group 1 wastewater stream or a residual removed from a Group 1 wastewater stream.	<input type="checkbox"/> Yes <input type="checkbox"/> No
12.	The application area includes individual drain systems that receive, manage, or treat a Group 1 wastewater stream or a residual removed from a Group 1 wastewater stream. <i>If the response to Question VIII.W.12 is "No," go to Question VIII.W.15.</i>	<input type="checkbox"/> Yes <input type="checkbox"/> No
13.	The application area includes individual drain systems that are complying with 40 CFR § 63.136 through the use of covers and, if vented, closed vent systems and control devices.	<input type="checkbox"/> Yes <input type="checkbox"/> No
14.	The application area includes individual drain systems that are complying with 40 CFR § 63.136 through the use of water seals or tightly fitting caps or plugs.	<input type="checkbox"/> Yes <input type="checkbox"/> No

Application Area-Wide Applicability Determinations and General Information
Form OP-REQ1 (Page 58)
Federal Operating Permit Program
Texas Commission on Environmental Quality

Date	Permit No.	Regulated Entity No.
04/23/2026	O3670	RN106392624

For SOP applications, answer ALL questions unless otherwise directed.

◆ For GOP applications, answer ONLY these questions unless otherwise directed.

VIII. Title 40 Code of Federal Regulations Part 63 - National Emission Standards for Hazardous Air Pollutants for Source Categories (continued)	
W. Subpart YY - National Emission Standards for Hazardous Air Pollutants for Source Categories - Generic Maximum Achievable Control Technology Standards (continued)	
<p>15. The application area includes drains, drain hubs, manholes, lift stations, trenches, or pipes that are part of an acetal resins production process unit; an acrylic and modacrylic fiber production process unit complying with 40 CFR § 63.1103(b)(3)(i); or an existing polycarbonate production process unit. <i>If the response to Question VIII.W.15 is "No," go to Question VIII.W.20.</i></p>	<input type="checkbox"/> Yes <input type="checkbox"/> No
<p>16. The application area includes drains, drain hubs, manholes, lift stations, trenches or pipes that meet the criteria listed in 40 CFR § 63.1106(c)(1) - (3). <i>If the response to Question VIII.W.16 is "No," go to Question VIII.W.20.</i></p>	<input type="checkbox"/> Yes <input type="checkbox"/> No
<p>17. The application area includes drains, drain hubs, manholes, lift stations, trenches or pipes that convey water with a total annual average concentration greater than or equal to 10,000 parts per million by weight of compounds meeting the definition of organic HAP in Table 9 to 40 CFR Part 60, Subpart G, at any flow rate.</p>	<input type="checkbox"/> Yes <input type="checkbox"/> No
<p>18. The application area includes drains, drain hubs, manholes, lift stations, trenches or pipes that convey water with a total annual average concentration greater than or equal to 1,000 parts per million by weight of compounds meeting the definition of organic HAP in Table 9 to 40 CFR Part 60, Subpart G, at an annual average flow rate greater than or equal to 10 liters per minute.</p>	<input type="checkbox"/> Yes <input type="checkbox"/> No

Application Area-Wide Applicability Determinations and General Information
Form OP-REQ1 (Page 59)
Federal Operating Permit Program
Texas Commission on Environmental Quality

Date	Permit No.	Regulated Entity No.
04/23/2026	O3670	RN106392624

For SOP applications, answer ALL questions unless otherwise directed.

◆ For GOP applications, answer ONLY these questions unless otherwise directed.

VIII. Title 40 Code of Federal Regulations Part 63 - National Emission Standards for Hazardous Air Pollutants for Source Categories (continued)	
W. Subpart YY - National Emission Standards for Hazardous Air Pollutants for Source Categories - Generic Maximum Achievable Control Technology Standards (continued)	
19. The application area includes drains, drain hubs, manholes, lift stations, trenches or pipes that are part of an acrylic resins or acrylic and modacrylic fiber production process unit that is part of a new affected source or is a new affected source and the equipment conveys water with a total annual average concentration greater than or equal to 10 ppmw of compounds meeting the definition of organic HAP in Table 9 to 40 CFR Part 60, Subpart G, at an average annual flow rate greater than or equal to 0.02 liter per minute.	<input type="checkbox"/> Yes <input type="checkbox"/> No
20. The application area includes an ethylene production process unit.	<input type="checkbox"/> Yes <input checked="" type="checkbox"/> No <input type="checkbox"/> N/A
21. The application area includes waste streams generated from an ethylene production process unit. <i>If the responses to Questions VIII.W.20 and VIII.W.21 are both "No" or "N/A," go to Question VIII.W.54.</i>	<input type="checkbox"/> Yes <input checked="" type="checkbox"/> No <input type="checkbox"/> N/A
22. The waste stream(s) contains at least one of the chemicals listed in 40 CFR § 63.1103(e), Table 7(g)(1). <i>If the response to Question VIII.W.22 is "No," go to Question VIII.W.54.</i>	<input type="checkbox"/> Yes <input type="checkbox"/> No
23. Waste stream(s) are transferred off-site for treatment. <i>If the response to Question VIII.W.23 is "No," go to Question VIII.W.25.</i>	<input type="checkbox"/> Yes <input type="checkbox"/> No
24. The application area has waste management units that treat or manage waste stream(s) prior to transfer off-site for treatment. <i>If the response to Question VIII.W.24 is "No," go to Question VIII.W.54.</i>	<input type="checkbox"/> Yes <input type="checkbox"/> No

Application Area-Wide Applicability Determinations and General Information
Form OP-REQ1 (Page 60)
Federal Operating Permit Program
Texas Commission on Environmental Quality

Date	Permit No.	Regulated Entity No.
04/23/2026	O3670	RN106392624

For SOP applications, answer ALL questions unless otherwise directed.

◆ For GOP applications, answer ONLY these questions unless otherwise directed.

VIII. Title 40 Code of Federal Regulations Part 63 - National Emission Standards for Hazardous Air Pollutants for Source Categories (continued)		
W. Subpart YY - National Emission Standards for Hazardous Air Pollutants for Source Categories - Generic Maximum Achievable Control Technology Standards (continued)		
25.	The total annual benzene quantity from waste at the site is less than 10 Mg/yr as determined according to 40 CFR § 61.342(a).	<input type="checkbox"/> Yes <input type="checkbox"/> No
26.	The application area contains at least one waste stream that is a continuous butadiene waste stream as defined in 40 CFR § 63.1082(b). <i>If the response to Question VIII.W.26 is "No," go to Question VIII.W.43.</i>	<input type="checkbox"/> Yes <input type="checkbox"/> No
27.	The waste stream(s) contains at least 10 ppmw 1, 3-butadiene at a flow rate of 0.02 liters per minute or is designated for control. <i>If the response to Question VIII.W.27 is "No," go to Question VIII.W.43.</i>	<input type="checkbox"/> Yes <input type="checkbox"/> No
28.	The control requirements of 40 CFR Part 63, Subpart G for process wastewater as specified in 40 CFR § 63.1095(a)(2) are selected for control of the waste stream(s). <i>If the response to Question VIII.W.28 is "No," go to Question VIII.W.33.</i>	<input type="checkbox"/> Yes <input type="checkbox"/> No
29.	The application area includes containers that receive, manage, or treat a continuous butadiene waste stream.	<input type="checkbox"/> Yes <input type="checkbox"/> No
30.	The application area includes individual drain systems that receive, manage, or treat a continuous butadiene waste stream. <i>If the response to Question VIII.W.30 is "No," go to Question VIII.W.43.</i>	<input type="checkbox"/> Yes <input type="checkbox"/> No
31.	The application area includes individual drain systems that are complying with 40 CFR § 63.136 through the use of cover and, if vented, closed vent systems and control devices.	<input type="checkbox"/> Yes <input type="checkbox"/> No

Application Area-Wide Applicability Determinations and General Information
Form OP-REQ1 (Page 61)
Federal Operating Permit Program
Texas Commission on Environmental Quality

Date	Permit No.	Regulated Entity No.
04/23/2026	O3670	RN106392624

For SOP applications, answer ALL questions unless otherwise directed.

◆ For GOP applications, answer ONLY these questions unless otherwise directed.

VIII. Title 40 Code of Federal Regulations Part 63 - National Emission Standards for Hazardous Air Pollutants for Source Categories (continued)	
W. Subpart YY - National Emission Standards for Hazardous Air Pollutants for Source Categories - Generic Maximum Achievable Control Technology Standards (continued)	
32. The application area includes individual drain systems that are complying with 40 CFR § 63.136 through the use of water seals or tightly fitting caps or plugs. <i>If the response to Question VIII.W.32 is required, go to Question VIII.W.43.</i>	<input type="checkbox"/> Yes <input type="checkbox"/> No
33. The application area has containers, as defined in 40 CFR § 61.341, that receive a continuous butadiene waste stream. <i>If the response to Question VIII.W.33 is "No," go to Question VIII.W.36.</i>	<input type="checkbox"/> Yes <input type="checkbox"/> No
34. The application area is an alternate means of compliance to meet the 40 CFR § 61.345 requirements for containers. <i>If the response to Question VIII.W.34 is "Yes," go to Question VIII.W.36.</i>	<input type="checkbox"/> Yes <input type="checkbox"/> No
35. Covers and closed-vent systems used for containers operate such that the container is maintained at a pressure less than atmospheric pressure.	<input type="checkbox"/> Yes <input type="checkbox"/> No
36. The application area has individual drain systems, as defined in 40 CFR § 61.341, that receive or manage a continuous butadiene waste stream. <i>If the response to Question VIII.W.36 is "No," go to Question VIII.W.43.</i>	<input type="checkbox"/> Yes <input type="checkbox"/> No
37. The application area is using an alternate means of compliance to meet the 40 CFR § 61.346 requirements for individual drain systems. <i>If the response to Question VIII.W.37 is "Yes," go to Question VIII.W.43.</i>	<input type="checkbox"/> Yes <input type="checkbox"/> No

Application Area-Wide Applicability Determinations and General Information
Form OP-REQ1 (Page 62)
Federal Operating Permit Program
Texas Commission on Environmental Quality

Date	Permit No.	Regulated Entity No.
04/23/2026	O3670	RN106392624

For SOP applications, answer ALL questions unless otherwise directed.

◆ For GOP applications, answer ONLY these questions unless otherwise directed.

VIII. Title 40 Code of Federal Regulations Part 63 - National Emission Standards for Hazardous Air Pollutants for Source Categories (continued)		
W. Subpart YY - National Emission Standards for Hazardous Air Pollutants for Source Categories - Generic Maximum Achievable Control Technology Standards (continued)		
38.	The application area has individual drain systems complying with 40 CFR § 61.346(a). <i>If the response to Question VIII.W.38 is "No," go to Question VIII.W.40.</i>	<input type="checkbox"/> Yes <input type="checkbox"/> No
39.	Covers and closed-vent systems used for individual drain systems operate such that the individual drain system is maintained at a pressure less than atmospheric pressure.	<input type="checkbox"/> Yes <input type="checkbox"/> No
40.	The application area has individual drain systems complying with 40 CFR § 61.346(b). <i>If the response to Question VIII.W.40 is "No," go to Question VIII.W.43.</i>	<input type="checkbox"/> Yes <input type="checkbox"/> No
41.	Junction boxes in the individual drain systems are equipped with a system to prevent the flow of organic vapors from the junction box vent pipe to the atmosphere during normal operation.	<input type="checkbox"/> Yes <input type="checkbox"/> No
42.	Junction box vent pipes in the individual drain systems are connected to a closed-vent system and control device.	<input type="checkbox"/> Yes <input type="checkbox"/> No
43.	The application area has at least one waste stream that contains benzene. <i>If the response to Question VIII.W.43 is "No," go to Question VIII.W.54.</i>	<input type="checkbox"/> Yes <input type="checkbox"/> No
44.	The application area has containers, as defined in 40 CFR § 61.341, that receive a waste stream containing benzene. <i>If the response to Question VIII.W.44 is "No," go to Question VIII.W.47.</i>	<input type="checkbox"/> Yes <input type="checkbox"/> No
45.	The application area is an alternate means of compliance to meet the 40 CFR § 61.345 requirements for containers. <i>If the response to Question VIII.W.45 is "Yes," go to Question VIII.W.47.</i>	<input type="checkbox"/> Yes <input type="checkbox"/> No

Application Area-Wide Applicability Determinations and General Information
Form OP-REQ1 (Page 63)
Federal Operating Permit Program
Texas Commission on Environmental Quality

Date	Permit No.	Regulated Entity No.
04/23/2026	O3670	RN106392624

For SOP applications, answer ALL questions unless otherwise directed.

◆ For GOP applications, answer ONLY these questions unless otherwise directed.

VIII. Title 40 Code of Federal Regulations Part 63 - National Emission Standards for Hazardous Air Pollutants for Source Categories (continued)		
W. Subpart YY - National Emission Standards for Hazardous Air Pollutants for Source Categories - Generic Maximum Achievable Control Technology Standards (continued)		
46.	Covers and closed-vent systems used for containers operate such that the container is maintained at a pressure less than atmospheric pressure.	<input type="checkbox"/> Yes <input type="checkbox"/> No
47.	The application area has individual drain systems, as defined in 40 CFR § 61.341, that receive or manage a waste stream containing benzene. <i>If the response to Question VIII.W.47 is "No," go to Question VIII.W.54.</i>	<input type="checkbox"/> Yes <input type="checkbox"/> No
48.	The application area is using an alternate means of compliance to meet the 40 CFR § 61.346 requirements for individual drain systems. <i>If the response to Question VIII.W.48 is "Yes," go to Question VIII.W.54.</i>	<input type="checkbox"/> Yes <input type="checkbox"/> No
49.	The application area has individual drain systems complying with 40 CFR § 61.346(a). <i>If the response to Question VIII.W.49 is "No," go to Question VIII.W.51.</i>	<input type="checkbox"/> Yes <input type="checkbox"/> No
50.	Covers and closed-vent systems used for individual drain systems operate such that the individual drain system is maintained at a pressure less than atmospheric pressure.	<input type="checkbox"/> Yes <input type="checkbox"/> No
51.	The application area has individual drain systems complying with 40 CFR § 61.346(b). <i>If the response to Question VIII.W.51 is "No," go to Question VIII.W.54.</i>	<input type="checkbox"/> Yes <input type="checkbox"/> No
52.	Junction boxes in the individual drain systems are equipped with a system to prevent the flow of organic vapors from the junction box vent pipe to the atmosphere during normal operation.	<input type="checkbox"/> Yes <input type="checkbox"/> No

Application Area-Wide Applicability Determinations and General Information
Form OP-REQ1 (Page 64)
Federal Operating Permit Program
Texas Commission on Environmental Quality

Date	Permit No.	Regulated Entity No.
04/23/2026	O3670	RN106392624

For SOP applications, answer ALL questions unless otherwise directed.

◆ For GOP applications, answer ONLY these questions unless otherwise directed.

VIII. Title 40 Code of Federal Regulations Part 63 - National Emission Standards for Hazardous Air Pollutants for Source Categories (continued)		
W. Subpart YY - National Emission Standards for Hazardous Air Pollutants for Source Categories - Generic Maximum Achievable Control Technology Standards (continued)		
53.	Junction box vent pipes in the individual drain systems are connected to a closed-vent system and control device.	<input type="checkbox"/> Yes <input type="checkbox"/> No
54.	The application area contains a cyanide chemicals manufacturing process. <i>If the response to Question VIII.W.54 is "No," go to Section VIII.X.</i>	<input type="checkbox"/> Yes <input checked="" type="checkbox"/> No
55.	The cyanide chemicals manufacturing process generates maintenance wastewater containing hydrogen cyanide or acetonitrile.	<input type="checkbox"/> Yes <input type="checkbox"/> No
X. Subpart JJJ - National Emission Standards for Hazardous Air Pollutant Emissions: Group IV Polymers and Resins		
1.	The application area includes thermoplastic product process units, and/or their associated affected sources specified in 40 CFR § 63.1310(a)(1) - (5), that are subject to 40 CFR Part 63, Subpart JJJ. <i>If the response to Question VIII.X.1 is "No," go to Section VIII.Y.</i>	<input type="checkbox"/> Yes <input checked="" type="checkbox"/> No
2.	The application area includes thermoplastic product process units and/or wastewater streams and wastewater operations that are associated with thermoplastic product process units. <i>If the response to Question VIII.X.2 is "No," go to Section VIII.Y.</i>	<input type="checkbox"/> Yes <input type="checkbox"/> No
3.	All process wastewater streams generated or managed in the application area are from sources producing polystyrene. <i>If the response to Question VIII.X.3 is "Yes," go to Section VIII.Y.</i>	<input type="checkbox"/> Yes <input type="checkbox"/> No
4.	All process wastewater streams generated or managed in the application area are from sources producing ASA/AMSAN. <i>If the response to Question VIII.X.4 is "Yes," go to Section VIII.Y.</i>	<input type="checkbox"/> Yes <input type="checkbox"/> No

Application Area-Wide Applicability Determinations and General Information
Form OP-REQ1 (Page 65)
Federal Operating Permit Program
Texas Commission on Environmental Quality

Date	Permit No.	Regulated Entity No.
04/23/2026	O3670	RN106392624

For SOP applications, answer ALL questions unless otherwise directed.

◆ For GOP applications, answer ONLY these questions unless otherwise directed.

VIII. Title 40 Code of Federal Regulations Part 63 - National Emission Standards for Hazardous Air Pollutants for Source Categories (continued)		
X. Subpart JJJ - National Emission Standards for Hazardous Air Pollutant Emissions: Group IV Polymers and Resins (continued)		
5.	The application area includes process wastewater streams that are designated as Group 1 or are determined to be Group 1 for organic HAPs as defined in 40 CFR § 63.1312.	<input type="checkbox"/> Yes <input type="checkbox"/> No
6.	The application area includes process wastewater streams, located at existing sources, that are Group 2 for organic HAPs as defined in 40 CFR § 63.1312.	<input type="checkbox"/> Yes <input type="checkbox"/> No
7.	The application area includes process wastewater streams, located at new sources, that are Group 2 for organic HAPs as defined in 40 CFR § 63.1312.	<input type="checkbox"/> Yes <input type="checkbox"/> No
8.	All Group 1 wastewater streams at the site are demonstrated to have a total source mass flow rate of less than 1 MG/yr. <i>If the response to Question VIII.X.8 is "Yes," go to Question VIII.X.18.</i>	<input type="checkbox"/> Yes <input type="checkbox"/> No
9.	The site has untreated and/or partially treated Group 1 wastewater streams demonstrated to have a total source mass flow rate of less than 1 MG/yr. <i>If the response to Question VIII.X.9 is "No," go to Question VIII.X.11.</i>	<input type="checkbox"/> Yes <input type="checkbox"/> No
10.	The application area includes waste management units that receive or manage a partially treated Group 1 wastewater stream prior to or during treatment.	<input type="checkbox"/> Yes <input type="checkbox"/> No
11.	Group 1 wastewater streams or residual removed from Group 1 wastewater streams are transferred to an on-site treatment operation that is not owned or operated by the owner or operator of the source generating the waste stream or residual.	<input type="checkbox"/> Yes <input type="checkbox"/> No
12.	Group 1 wastewater streams or residual removed from Group 1 wastewater streams are transferred to an off-site treatment operation. <i>If the responses to Questions VIII.X.11 - VIII.X.12 are both "No," go to Question VIII.X.14.</i>	<input type="checkbox"/> Yes <input type="checkbox"/> No

Application Area-Wide Applicability Determinations and General Information
Form OP-REQ1 (Page 66)
Federal Operating Permit Program
Texas Commission on Environmental Quality

Date	Permit No.	Regulated Entity No.
04/23/2026	O3670	RN106392624

For SOP applications, answer ALL questions unless otherwise directed.

◆ For GOP applications, answer ONLY these questions unless otherwise directed.

VIII. Title 40 Code of Federal Regulations Part 63 - National Emission Standards for Hazardous Air Pollutants for Source Categories (continued)	
X. Subpart JJJ - National Emission Standards for Hazardous Air Pollutant Emissions: Group IV Polymers and Resins (continued)	
13. The application area includes waste management units that receive or manage a Group 1 wastewater stream, or a residual removed from a Group 1 wastewater stream prior to shipment or transport.	<input type="checkbox"/> Yes <input type="checkbox"/> No
<i>Containers</i>	
14. The application area includes containers that receive, manage, or treat a Group 1 wastewater stream or a residual removed from a Group 1 wastewater stream.	<input type="checkbox"/> Yes <input type="checkbox"/> No
<i>Drains</i>	
15. The application area includes individual drain systems that receive or manage a Group 1 wastewater stream or a residual removed from a Group 1 wastewater stream. <i>If the response to Question VIII.X.15 is "No," go to Question VIII.X.18.</i>	<input type="checkbox"/> Yes <input type="checkbox"/> No
16. The application area includes individual drain systems that are complying with 40 CFR § 63.136 through the use of cover and, if vented, closed vent systems and control devices.	<input type="checkbox"/> Yes <input type="checkbox"/> No
17. The application area includes individual drain systems that are complying with 40 CFR § 63.136 through the use of water seals or tightly fitting caps or plugs.	<input type="checkbox"/> Yes <input type="checkbox"/> No
18. The application area includes drains, drain hubs, manholes, lift stations, trenches, or pipes that are part of a thermoplastic product process unit. <i>If the response to Question VIII.X.18 is "No," go to Section VIII.Y.</i>	<input type="checkbox"/> Yes <input type="checkbox"/> No

Application Area-Wide Applicability Determinations and General Information
Form OP-REQ1 (Page 67)
Federal Operating Permit Program
Texas Commission on Environmental Quality

Date	Permit No.	Regulated Entity No.
04/23/2026	O3670	RN106392624

For SOP applications, answer ALL questions unless otherwise directed.

◆ For GOP applications, answer ONLY these questions unless otherwise directed.

VIII. Title 40 Code of Federal Regulations Part 63 - National Emission Standards for Hazardous Air Pollutants for Source Categories (continued)	
X. Subpart JJJ - National Emission Standards for Hazardous Air Pollutant Emissions: Group IV Polymers and Resins (continued)	
<i>Drains (continued)</i>	
<p>19. The application area includes drains, drain hubs, manholes, lift stations, trenches or pipes that meet the criteria listed in 40 CFR § 63.149(d) and § 63.1330(b)(12). <i>If the response to Question VIII.X.19 is "No," go to Section VIII.Y.</i></p>	<input type="checkbox"/> Yes <input type="checkbox"/> No
<p>20. The application area includes drains, drain hubs, manholes, lift stations, trenches, or pipes that convey water with a total annual average concentration greater than or equal to 10,000 parts per million by weight of compounds meeting the definition of organic HAP in 40 CFR § 63.1312, at any flow rate.</p>	<input type="checkbox"/> Yes <input type="checkbox"/> No
<p>21. The application area includes drains, drain hubs, manholes, lift stations, trenches or pipes that convey water with a total annual average concentration greater than or equal to 1,000 parts per million by weight of compounds meeting the definition of organic HAP in 40 CFR § 63.1312, at an annual average flow rate greater than or equal to 10 liters per minute.</p>	<input type="checkbox"/> Yes <input type="checkbox"/> No
<p>22. The application area includes drains, drain hubs, manholes, lift stations, trenches or pipes that are part of an thermoplastic product process unit that is a new affected source or part of a new affected source and the equipment conveys water with a total annual average concentration greater than or equal to 10 parts per million by weight of compounds meeting the definition of organic HAP in 40 CFR § 63.1312, at an average annual flow rate greater than or equal to 0.02 liter per minute</p>	<input type="checkbox"/> Yes <input type="checkbox"/> No

Application Area-Wide Applicability Determinations and General Information
Form OP-REQ1 (Page 68)
Federal Operating Permit Program
Texas Commission on Environmental Quality

Date	Permit No.	Regulated Entity No.
04/23/2026	O3670	RN106392624

For SOP applications, answer ALL questions unless otherwise directed.

◆ For GOP applications, answer ONLY these questions unless otherwise directed.

VIII. Title 40 Code of Federal Regulations Part 63 - National Emission Standards for Hazardous Air Pollutants for Source Categories (continued)		
Y. Subpart UUU - National Emission Standards for Hazardous Air Pollutants for Petroleum Refineries: Catalytic Cracking Units, Catalytic Reforming Units, and Sulfur Recovery Units.		
1. The application area is subject to 40 CFR Part 63, Subpart UUU - National Emission Standards for Hazardous Air Pollutants for Petroleum Refineries: Catalytic Cracking Units, Catalytic Reforming Units, and Sulfur Recovery Units.	<input type="checkbox"/> Yes <input checked="" type="checkbox"/> No	
Z. Subpart AAAA - National Emission Standards for Hazardous Air Pollutants for Municipal Solid Waste (MSW) Landfills.		
◆ 1. The application area is subject to 40 CFR Part 63, Subpart AAAA - National Emission Standards for Hazardous Air Pollutants for Municipal Solid Waste Landfills.	<input type="checkbox"/> Yes <input checked="" type="checkbox"/> No	
AA. Subpart FFFF - National Emission Standards for Hazardous Air Pollutants for Miscellaneous Organic Chemical Production and Processes (MON)		
1. The application area is located at a site that includes process units that manufacture as a primary product one or more of the chemicals listed in 40 CFR § 63.2435(b)(1).	<input type="checkbox"/> Yes <input checked="" type="checkbox"/> No	
2. The application area is located at a plant site that is a major source as defined in FCAA § 112(a).	<input type="checkbox"/> Yes <input checked="" type="checkbox"/> No	
3. The application area is located at a site that includes miscellaneous chemical manufacturing process units (MCPU) that process, use or generate one or more of the organic hazardous air pollutants listed in § 112(b) of the Clean Air Act or hydrogen halide and halogen HAP. <i>If the response to Question VIII.AA.1, AA.2 or AA.3 is "No," go to Section VIII.BB.</i>	<input type="checkbox"/> Yes <input checked="" type="checkbox"/> No	
4. The application area includes process vents, storage vessels, transfer racks, or waste streams associated with a miscellaneous chemical manufacturing process subject to 40 CFR 63, Subpart FFFF. <i>If the response to Question VIII.AA.4 is "No," go to Section VIII.BB.</i>	<input type="checkbox"/> Yes <input type="checkbox"/> No	

Application Area-Wide Applicability Determinations and General Information
Form OP-REQ1 (Page 69)
Federal Operating Permit Program
Texas Commission on Environmental Quality

Date	Permit No.	Regulated Entity No.
04/23/2026	O3670	RN106392624

For SOP applications, answer ALL questions unless otherwise directed.

◆ For GOP applications, answer ONLY these questions unless otherwise directed.

VIII. Title 40 Code of Federal Regulations Part 63 - National Emission Standards for	
AA. Subpart FFFF - National Emission Standards for Hazardous Air Pollutants for Miscellaneous Organic Chemical Production and Processes (MON) (continued)	
5. The application area includes process wastewater streams. <i>If the response to Question VIII.AA.5 is "No," go to Question VIII.AA.24.</i>	<input type="checkbox"/> Yes <input type="checkbox"/> No
6. The application area includes process wastewater streams, located at existing sources, that are designated as Group 1 or are determined to be Group 1 for compounds listed in Table 8 of 40 CFR Part 63, Subpart G or Table 8 and Table 9 of 40 CFR Part 63, Subpart FFFF, as appropriate.	<input type="checkbox"/> Yes <input type="checkbox"/> No
7. The application area includes process wastewater streams, located at existing sources, that are Group 2 for compounds listed in Table 8 or Table 8 and Table 9 of 40 CFR Part 63, Subpart FFFF, as appropriate.	<input type="checkbox"/> Yes <input type="checkbox"/> No
8. The application area includes process wastewater streams, located at new sources, that are designated as Group 1 or are determined to be Group 1 for compounds listed in Table 8 of 40 CFR Part 63, Subpart G or Table 8 and Table 9 of 40 CFR Part 63, Subpart FFFF, as appropriate.	<input type="checkbox"/> Yes <input type="checkbox"/> No
9. The application area includes process wastewater streams, located at new sources, that are Group 2 for compounds listed in Table 8 or Table 8 and Table 9 of 40 CFR Part 63, Subpart FFFF, as appropriate.	<input type="checkbox"/> Yes <input type="checkbox"/> No
10. All Group 1 wastewater streams at the site are demonstrated to have a total source mass flow rate of less than 1 MG/yr. <i>If the response to Question VIII.AA.10 is "Yes," go to Question VIII.AA.24.</i>	<input type="checkbox"/> Yes <input type="checkbox"/> No
11. The site has untreated and/or partially treated Group 1 wastewater streams demonstrated to have a total source mass flow rate of less than 1 MG/yr. <i>If the response to Question VIII.AA.11 is "No," go to Question VIII.AA.13.</i>	<input type="checkbox"/> Yes <input type="checkbox"/> No
12. The application area includes waste management units that receive or manage a partially treated Group 1 wastewater stream prior to or during treatment.	<input type="checkbox"/> Yes <input type="checkbox"/> No
13. Group 1 wastewater streams or residual removed from Group 1 wastewater streams are transferred to an on-site treatment operation that is not owned or operated by the owner or operator of the source generating the waste stream or residual.	<input type="checkbox"/> Yes <input type="checkbox"/> No

Application Area-Wide Applicability Determinations and General Information
Form OP-REQ1 (Page 70)
Federal Operating Permit Program
Texas Commission on Environmental Quality

Date	Permit No.	Regulated Entity No.
04/23/2026	O3670	RN106392624

For SOP applications, answer ALL questions unless otherwise directed.

◆ For GOP applications, answer ONLY these questions unless otherwise directed.

VIII. Title 40 Code of Federal Regulations Part 63 - National Emission Standards for Hazardous Air Pollutants for Source Categories (continued)		
AA. Subpart FFFF - National Emission Standards for Hazardous Air Pollutants for Miscellaneous Organic Chemical Production and Processes (MON) (continued)		
14.	Group 1 wastewater streams or residual removed from Group 1 wastewater streams are transferred to an off-site treatment operation. <i>If the responses to Questions VIII.AA.13 and VIII.AA.14 are both "No," go to Question VIII.AA.20.</i>	<input type="checkbox"/> Yes <input type="checkbox"/> No
15.	Group 1 wastewater streams are transferred to an offsite treatment facility meeting the requirements of 40 CFR § 63.138(h). <i>If the response to Question VIII.AA.15 is "No," go to Question VIII.AA.17.</i>	<input type="checkbox"/> Yes <input type="checkbox"/> No
16.	The option to document in the notification of compliance status report that the wastewater will be treated in a facility meeting the requirements of 40 CFR § 63.138(h) is elected.	<input type="checkbox"/> Yes <input type="checkbox"/> No
17.	Group 1 wastewater streams or residuals with a total annual average concentration of compounds in Table 8 of 40 CFR Part 63, Subpart FFFF less than 50 ppmw are transferred offsite. <i>If the response to Question VIII.AA.17 is "No," go to Question VIII.AA.19.</i>	<input type="checkbox"/> Yes <input type="checkbox"/> No
18.	The transferor is demonstrating that less than 5 percent of the HAP in Table 9 of 40 CFR Part 63, Subpart FFFF is emitted from waste management units up to the activated sludge unit.	<input type="checkbox"/> Yes <input type="checkbox"/> No
19.	The application area includes waste management units that receive or manage a Group 1 wastewater stream, or a residual removed from a Group 1 wastewater stream prior to shipment or transport.	<input type="checkbox"/> Yes <input type="checkbox"/> No
20.	The application area includes containers that receive, manage, or treat a Group 1 wastewater stream or a residual removed from a Group 1 wastewater stream.	<input type="checkbox"/> Yes <input type="checkbox"/> No
21.	The application area includes individual drain systems that receive or manage a Group 1 wastewater stream, or a residual removed from a Group 1 wastewater stream. <i>If the response to Question VIII.AA.21 is "No," go to Question VIII.AA.24.</i>	<input type="checkbox"/> Yes <input type="checkbox"/> No
22.	The application area includes individual drain systems that are complying with 40 CFR § 63.136 through the use of cover and, if vented, closed vent systems and control devices.	<input type="checkbox"/> Yes <input type="checkbox"/> No

Application Area-Wide Applicability Determinations and General Information
Form OP-REQ1 (Page 71)
Federal Operating Permit Program
Texas Commission on Environmental Quality

Date	Permit No.	Regulated Entity No.
04/23/2026	O3670	RN106392624

For SOP applications, answer ALL questions unless otherwise directed.

◆ For GOP applications, answer ONLY these questions unless otherwise directed.

VIII. Title 40 Code of Federal Regulations Part 63 - National Emission Standards for Hazardous Air Pollutants for Source Categories (continued)		
AA. Subpart FFFF - National Emission Standards for Hazardous Air Pollutants for Miscellaneous Organic Chemical Production and Processes (MON) (continued)		
23.	The application area includes individual drain systems that are complying with 40 CFR § 63.136 through the use of water seals or tightly fitting caps or plugs.	<input type="checkbox"/> Yes <input type="checkbox"/> No
24.	The application area includes drains, drain hubs, manholes, lift stations, trenches, or pipes that are part of a chemical manufacturing process unit that meets the criteria of 40 CFR § 63.100(b). <i>If the response to Question VIII.AA.24 is "No," go to Section VIII.BB.</i>	<input type="checkbox"/> Yes <input type="checkbox"/> No
25.	The application area includes drains, drain hubs, manholes, lift stations, trenches or pipes (that are part of a miscellaneous chemical manufacturing process unit) that meet the criteria listed in 40 CFR § 63.149(d). <i>If the response to Question VIII.AA.25 is "No," go to Section VIII.BB.</i>	<input type="checkbox"/> Yes <input type="checkbox"/> No
26.	The application area includes drains, drain hubs, manholes, lift stations, trenches or pipes that convey water with a total annual average concentration of compounds in table 8 of 40 CFR Part 63, Subpart FFFF is greater than or equal to 10,000 ppmw at any flow rate, and the total annual load of compounds in table 8 of 40 CFR Part 63, Subpart FFFF is greater than or equal to 200 lb/yr.	<input type="checkbox"/> Yes <input type="checkbox"/> No
27.	The application area includes drains, drain hubs, manholes, lift stations, trenches, or pipes that convey water with a total annual average concentration of compounds in table 8 of 40 CFR Part 63, Subpart FFFF is greater than or equal to 1,000 ppmw, and the annual average flow rate is greater than or equal to 1 liter per minute.	<input type="checkbox"/> Yes <input type="checkbox"/> No
28.	The application area includes drains, drain hubs, manholes, lift stations, trenches or pipes that are part of a chemical manufacturing process unit that is subject to the new source requirements of 40 CFR § 63.2445(a); and the equipment conveys water with a combined total annual average concentration of compounds in tables 8 and 9 of 40 CFR Part 63, Subpart FFFF is greater than or equal to 30,000 ppmw, and the combined total annual load of compounds in tables 8 and 9 to this subpart is greater than or equal to 1 tpy.	<input type="checkbox"/> Yes <input type="checkbox"/> No

Application Area-Wide Applicability Determinations and General Information
Form OP-REQ1 (Page 72)
Federal Operating Permit Program
Texas Commission on Environmental Quality

Date	Permit No.	Regulated Entity No.
04/23/2026	O3670	RN106392624

For SOP applications, answer ALL questions unless otherwise directed.

◆ For GOP applications, answer ONLY these questions unless otherwise directed.

VIII. Title 40 Code of Federal Regulations Part 63 - National Emission Standards for Hazardous Air Pollutants for Source Categories (continued)	
BB. Subpart GGGG - National Emission Standards for Hazardous Air Pollutants for: Solvent Extractions for Vegetable Oil Production.	
1. The application area includes a vegetable oil production process that: is by itself a major source of HAP emissions or, is collocated within a plant site with other sources that are individually or collectively a major source of HAP emissions.	<input type="checkbox"/> Yes <input checked="" type="checkbox"/> No
CC. Subpart GGGGG - National Emission Standards for Hazardous Air Pollutants: Site Remediation	
1. The application area includes a facility at which a site remediation is conducted. <i>If the answer to Question VIII.CC.1 is "No," go to Section VIII.DD.</i>	<input type="checkbox"/> Yes <input checked="" type="checkbox"/> No
2. The application area is located at a site that is a major source of HAP. <i>If the answer to Question VIII.CC.2 is "No," go to Section VIII.DD.</i>	<input type="checkbox"/> Yes <input type="checkbox"/> No
3. All site remediations qualify for one of the exemptions contained in 40 CFR § 63.7881(b)(1) through (6). <i>If the answer to Question VIII.CC.3 is "Yes," go to Section VIII.DD.</i>	<input type="checkbox"/> Yes <input type="checkbox"/> No
4. All site remediation activities are complete, and the Administrator has been notified in writing. <i>If the answer to Question VIII.CC.4 is "Yes," go to Section VIII.DD.</i>	<input type="checkbox"/> Yes <input type="checkbox"/> No
5. Prior to beginning site remediation activities, it was determined that the total quantity of HAP listed in Table 1 of Subpart GGGGG that will be removed during all site remediations will be less than 1 Mg/yr. <i>If the answer to Question VIII.CC.5 is "Yes," go to Section VIII.DD.</i>	<input type="checkbox"/> Yes <input type="checkbox"/> No
6. The site remediation will be completed within 30 consecutive calendar days.	<input type="checkbox"/> Yes <input type="checkbox"/> No
7. No site remediation will exceed 30 consecutive calendar days. <i>If the answer to Question VIII.CC.7 is "Yes," go to Section VIII.DD.</i>	<input type="checkbox"/> Yes <input type="checkbox"/> No
8. Site remediation materials subject to 40 CFR Part 63, Subpart GGGGG are transferred from the application area to an off-site facility.	<input type="checkbox"/> Yes <input type="checkbox"/> No
9. All site remediation materials subject to 40 CFR Part 63, Subpart GGGGG are transferred from the application area to an off-site facility. <i>If the answer to Question VIII.CC.9 is "Yes," go to Section VIII.DD.</i>	<input type="checkbox"/> Yes <input type="checkbox"/> No

Application Area-Wide Applicability Determinations and General Information
Form OP-REQ1 (Page 73)
Federal Operating Permit Program
Texas Commission on Environmental Quality

Date	Permit No.	Regulated Entity No.
04/23/2026	O3670	RN106392624

For SOP applications, answer ALL questions unless otherwise directed.

◆ For GOP applications, answer ONLY these questions unless otherwise directed.

VIII. Title 40 Code of Federal Regulations Part 63 - National Emission Standards for Hazardous Air Pollutants for Source Categories (continued)		
CC. Subpart GGGGG - National Emission Standards for Hazardous Air Pollutants: Site Remediation (continued)		
10.	The application area includes a remediation material management unit used for cleanup of radioactive mixed waste per § 63.7886(c).	<input type="checkbox"/> Yes <input type="checkbox"/> No
11.	The application area includes a remediation material management unit or combination of units with a total annual quantity of HAP less than 1 Mg/yr that is being exempted from § 63.7886(b) per § 63.7886(d).	<input type="checkbox"/> Yes <input type="checkbox"/> No
12.	The application area includes a remediation material management unit that has an average total VOHAP concentration of remediation material less than 500 ppmw and is complying with § 63.7886(b)(2). <i>If the response to Question VIII.CC.12 is "No," go to Question VIII.CC.14.</i>	<input type="checkbox"/> Yes <input type="checkbox"/> No
13.	The application area includes a remediation material management unit that concentrates all or part of the material such that the material's VOHAP concentration could increase.	<input type="checkbox"/> Yes <input type="checkbox"/> No
14.	The application area includes containers that manage site remediation materials subject to 40 CFR Part 63, Subpart GGGGG. <i>If the response to Question VIII.CC.14 is "No," go to Question VIII.CC.21.</i>	<input type="checkbox"/> Yes <input type="checkbox"/> No
15.	The application area includes containers that are also subject to and complying with another subpart under 40 CFR part 61 or part 63 per § 63.7886(b)(3).	<input type="checkbox"/> Yes <input type="checkbox"/> No
16.	The application area includes containers that are complying with alternative work practice standards that have been approved by the EPA per § 63.7900(e).	<input type="checkbox"/> Yes <input type="checkbox"/> No
17.	The application area includes containers using Container Level 1 controls as specified in 40 CFR § 63.922(b).	<input type="checkbox"/> Yes <input type="checkbox"/> No
18.	The application area includes containers with a capacity greater than 0.46 m ³ that meet the requirements of 40 CFR § 63.7900(b)(3)(i) and (ii).	<input type="checkbox"/> Yes <input type="checkbox"/> No
19.	The application area includes containers using Container Level 2 controls as specified in 40 CFR § 63.923(b).	<input type="checkbox"/> Yes <input type="checkbox"/> No
20.	The application area includes containers using Container Level 3 controls as specified in 40 CFR § 63.924(b).	<input type="checkbox"/> Yes <input type="checkbox"/> No
21.	The application area includes individual drain systems complying with the requirements of 40 CFR § 63.962.	<input type="checkbox"/> Yes <input type="checkbox"/> No

Application Area-Wide Applicability Determinations and General Information
Form OP-REQ1 (Page 74)
Federal Operating Permit Program
Texas Commission on Environmental Quality

Date	Permit No.	Regulated Entity No.
04/23/2026	O3670	RN106392624

For SOP applications, answer ALL questions unless otherwise directed.

◆ For GOP applications, answer ONLY these questions unless otherwise directed.

VIII. Title 40 Code of Federal Regulations Part 63 - National Emission Standards for Hazardous Air Pollutants for Source Categories (continued)	
DD. Subpart YYYYYY - National Emission Standards for Hazardous Air Pollutants for Area/Sources: Electric Arc Furnace Steelmaking Facilities	
1. The application area includes an electric arc furnace (EAF) steelmaking facility, and the site is an area source of hazardous air pollutant (HAP) emissions. <i>If the response to Question VIII.DD.1 is "No," go to Section VIII.EE.</i>	<input type="checkbox"/> Yes <input checked="" type="checkbox"/> No
2. The EAF steelmaking facility is a research and development facility. <i>If the response to Question VIII.DD.2 is "Yes," go to Section VIII.EE.</i>	<input type="checkbox"/> Yes <input type="checkbox"/> No
3. Metallic scrap is utilized in the EAF.	<input type="checkbox"/> Yes <input type="checkbox"/> No
4. Scrap containing motor vehicle scrap is utilized in the EAF.	<input type="checkbox"/> Yes <input type="checkbox"/> No
5. Scrap not containing motor vehicle scrap is utilized in the EAF.	<input type="checkbox"/> Yes <input type="checkbox"/> No
EE. Subpart BBBBBB - National Emission Standards for Hazardous Air Pollutants for Source Category: Gasoline Distribution Bulk Terminals, Bulk Plants and Pipeline Facilities	
1. The application area is located at a site that is an area source of HAPs. <i>If the answer to Question EE.1 is "No," go to Section VIII.FF.</i>	<input checked="" type="checkbox"/> Yes <input type="checkbox"/> No
2. The application area includes a pipeline breakout station, as defined in 40 CFR Part 63, Subpart BBBBBB, not subject to the control requirements of 40 CFR Part 63, Subpart R.	<input type="checkbox"/> Yes <input checked="" type="checkbox"/> No
3. The application area includes a pipeline pumping station as defined in 40 CFR Part 63, Subpart BBBBBB.	<input type="checkbox"/> Yes <input checked="" type="checkbox"/> No

Application Area-Wide Applicability Determinations and General Information
Form OP-REQ1 (Page 75)
Federal Operating Permit Program
Texas Commission on Environmental Quality

Date	Permit No.	Regulated Entity No.
04/23/2026	O3670	RN106392624

For SOP applications, answer ALL questions unless otherwise directed.

◆ For GOP applications, answer ONLY these questions unless otherwise directed.

VIII. Title 40 Code of Federal Regulations Part 63 - National Emission Standards for		
EE. Subpart BBBBBB - National Emission Standards for Hazardous Air Pollutants for Source Category: Gasoline Distribution Bulk Terminals, Bulk Plants and Pipeline Facilities (continued)		
4.	The application area includes a bulk gasoline plant as defined in 40 CFR Part 63, Subpart BBBBBB. <i>If the answer to Question VIII.EE.4 is "No," go to Question VIII.EE.6.</i>	<input type="checkbox"/> Yes <input checked="" type="checkbox"/> No
5.	The bulk gasoline plant was operating, prior to January 10, 2010, in compliance with an enforceable State, local or tribal rule or permit that requires submerged fill as specified in 40 CFR § 63.11086(a).	<input type="checkbox"/> Yes <input type="checkbox"/> No
6.	The application area includes a bulk gasoline terminal, as defined in 40 CFR Part 63, Subpart BBBBBB, not subject to the control requirements of 40 CFR Part 63, Subpart R or Subpart CC. <i>If the answer to Question VIII.EE.6 is "No," go to Section VIII.FF.</i>	<input type="checkbox"/> Yes <input checked="" type="checkbox"/> No
7.	The bulk gasoline terminal has throughput of less than 250,000 gallons per day. <i>If the answer to Question VIII.EE.7 is "Yes," go to Section VIII.FF.</i>	<input type="checkbox"/> Yes <input type="checkbox"/> No
8.	The bulk gasoline terminal loads gasoline into gasoline cargo tanks other than railcar cargo tanks.	<input type="checkbox"/> Yes <input type="checkbox"/> No
9.	The bulk gasoline terminal loads gasoline into railcar cargo tanks. <i>If the answer to Question VIII.EE.9 is "No," go to Section VIII.FF.</i>	<input type="checkbox"/> Yes <input type="checkbox"/> No
10.	The bulk gasoline terminal loads gasoline into railcar cargo tanks which do not collect vapors from a vapor balance system.	<input type="checkbox"/> Yes <input type="checkbox"/> No

Application Area-Wide Applicability Determinations and General Information
Form OP-REQ1 (Page 76)
Federal Operating Permit Program
Texas Commission on Environmental Quality

Date	Permit No.	Regulated Entity No.
04/23/2026	O3670	RN106392624

For SOP applications, answer ALL questions unless otherwise directed.

◆ For GOP applications, answer ONLY these questions unless otherwise directed.

VIII. Title 40 Code of Federal Regulations Part 63 - National Emission Standards for Hazardous Air Pollutants for Source Categories (continued)		
EE. Subpart BBBBBB - National Emission Standards for Hazardous Air Pollutants for Source Category: Gasoline Distribution Bulk Terminals, Bulk Plants and Pipeline Facilities (continued)		
11. The bulk gasoline terminal loads gasoline into railcar cargo tanks which collect vapors from a vapor balance system and that system complies with a Federal, State, local, tribal rule or permit.	<input type="checkbox"/> Yes <input type="checkbox"/> No	
FF. Subpart CCCCCC - National Emission Standards for Hazardous Air Pollutants for Source Category: Gasoline Dispensing Facilities		
◆ 1. The application area is located at a site that is an area source of hazardous air pollutants. <i>If the answer to Question VIII.FF.1 is "No," go to Section VIII.GG.</i>	<input checked="" type="checkbox"/> Yes <input type="checkbox"/> No	
◆ 2. The application area includes at least one gasoline dispensing facility as defined in 40 CFR § 63.11132. <i>If the answer to Question VIII.FF.2 is "No," go to Section VIII.GG.</i>	<input checked="" type="checkbox"/> Yes <input type="checkbox"/> No	
◆ 3. The application area includes at least one gasoline dispensing facility with a monthly throughput of less than 10,000 gallons.	<input checked="" type="checkbox"/> Yes <input type="checkbox"/> No	
◆ 4. The application area includes at least one gasoline dispensing facility where gasoline is dispensed from a fixed gasoline storage tank into a portable gasoline tank for the on-site delivery and subsequent dispensing into other gasoline-fueled equipment.	<input checked="" type="checkbox"/> Yes <input type="checkbox"/> No	
GG. Recently Promulgated 40 CFR Part 63 Subparts		
◆ 1. The application area is subject to one or more promulgated 40 CFR Part 63 subparts not addressed on this form. <i>If the response to Question VIII.GG.1 is "No," go to Section IX. A list of promulgated 40 CFR Part 63 subparts not otherwise addressed on OP-REQ1 is included in the instructions.</i>	<input checked="" type="checkbox"/> Yes <input type="checkbox"/> No	
◆ 2. Provide the Subpart designation (i.e. Subpart EEE) in the space provided below.		
Subpart ZZZZ		

Application Area-Wide Applicability Determinations and General Information
Form OP-REQ1 (Page 77)
Federal Operating Permit Program
Texas Commission on Environmental Quality

Date	Permit No.	Regulated Entity No.
04/23/2026	O3670	RN106392624

For SOP applications, answer ALL questions unless otherwise directed.

◆ For GOP applications, answer ONLY these questions unless otherwise directed.

IX. Title 40 Code of Federal Regulations Part 68 (40 CFR Part 68) - Chemical Accident Prevention Provisions		
A. Applicability		
◆	1. The application area contains processes subject to 40 CFR Part 68, Chemical Accident Prevention Provisions, and specified in 40 CFR § 68.10.	<input type="checkbox"/> Yes <input checked="" type="checkbox"/> No
X. Title 40 Code of Federal Regulations Part 82 (40 CFR Part 82) - Protection of Stratospheric Ozone		
A. Subpart A - Production and Consumption Controls		
◆	1. The application area is located at a site that produces, transforms, destroys, imports, or exports a controlled substance or product.	<input type="checkbox"/> Yes <input checked="" type="checkbox"/> No <input type="checkbox"/> N/A
B. Subpart B - Servicing of Motor Vehicle Air Conditioners		
◆	1. Servicing, maintenance, and/or repair of fleet vehicle air conditioning systems using ozone-depleting refrigerants is conducted in the application area.	<input type="checkbox"/> Yes <input checked="" type="checkbox"/> No
C. Subpart C - Ban on Nonessential Products Containing Class I Substances and Ban on Nonessential Products Containing or Manufactured with Class II Substances		
◆	1. The application area sells or distributes one or more nonessential products (which release a Class I or Class II substance) that are subject to 40 CFR Part 82, Subpart C.	<input type="checkbox"/> Yes <input checked="" type="checkbox"/> No <input type="checkbox"/> N/A
D. Subpart D - Federal Procurement		
◆	1. The application area is owned/operated by a department, agency, or instrumentality of the United States.	<input type="checkbox"/> Yes <input checked="" type="checkbox"/> No <input type="checkbox"/> N/A
E. Subpart E - The Labeling of Products Using Ozone Depleting Substances		
◆	1. The application area includes containers in which a Class I or Class II substance is stored or transported prior to the sale of the Class I or Class II substance to the ultimate consumer.	<input type="checkbox"/> Yes <input checked="" type="checkbox"/> No <input type="checkbox"/> N/A
◆	2. The application area is a manufacturer, importer, wholesaler, distributor, or retailer of products containing a Class I or Class II substance.	<input type="checkbox"/> Yes <input checked="" type="checkbox"/> No <input type="checkbox"/> N/A
◆	3. The application area is a manufacturer, importer, wholesaler, distributor, or retailer of products manufactured with a process that uses a Class I or Class II substance.	<input type="checkbox"/> Yes <input checked="" type="checkbox"/> No <input type="checkbox"/> N/A

Application Area-Wide Applicability Determinations and General Information
Form OP-REQ1 (Page 78)
Federal Operating Permit Program
Texas Commission on Environmental Quality

Date	Permit No.	Regulated Entity No.
04/23/2026	O3670	RN106392624

For SOP applications, answer ALL questions unless otherwise directed.

◆ For GOP applications, answer ONLY these questions unless otherwise directed.

X. Title 40 Code of Federal Regulations Part 82 (40 CFR Part 82) - Protection of Stratospheric Ozone (continued)		
F. Subpart F - Recycling and Emissions Reduction		
◆	1. Servicing, maintenance, and/or repair on refrigeration and non-motor vehicle air condition appliances using ozone-depleting refrigerants or non-exempt substitutes is conducted in the application area.	<input type="checkbox"/> Yes <input checked="" type="checkbox"/> No
◆	2. Disposal of appliances (including motor vehicle air conditioners) or refrigerant or non-exempt substitute reclamation occurs in the application area.	<input type="checkbox"/> Yes <input checked="" type="checkbox"/> No <input type="checkbox"/> N/A
◆	3. The application area manufactures appliances or refrigerant recycling and recovery equipment.	<input type="checkbox"/> Yes <input checked="" type="checkbox"/> No <input type="checkbox"/> N/A
G. Subpart G - Significant New Alternatives Policy Program		
◆	1. The application area manufactures, formulates, or creates chemicals, product substitutes, or alternative manufacturing processes that are intended for use as a replacement for a Class I or Class II compound. <i>If the response to Question X.G.1 is "No" or "N/A," go to Section X.H.</i>	<input type="checkbox"/> Yes <input checked="" type="checkbox"/> No <input type="checkbox"/> N/A
◆	2. All substitutes produced by the application area meet one or more of the exemptions in 40 CFR § 82.176(b)(1) - (7).	<input type="checkbox"/> Yes <input type="checkbox"/> No <input type="checkbox"/> N/A
H. Subpart H -Halon Emissions Reduction		
◆	1. Testing, servicing, maintaining, repairing, or disposing of equipment containing halons is conducted in the application area.	<input type="checkbox"/> Yes <input checked="" type="checkbox"/> No <input type="checkbox"/> N/A
◆	2. Disposal of halons or manufacturing of halon blends is conducted in the application area.	<input type="checkbox"/> Yes <input checked="" type="checkbox"/> No <input type="checkbox"/> N/A
XI. Miscellaneous		
A. Requirements Reference Tables (RRT) and Flowcharts		
1.	The application area contains units that are potentially subject to a regulation for which the TCEQ has not developed an RRT and flowchart.	<input type="checkbox"/> Yes <input checked="" type="checkbox"/> No

Application Area-Wide Applicability Determinations and General Information
Form OP-REQ1 (Page 79)
Federal Operating Permit Program
Texas Commission on Environmental Quality

Date	Permit No.	Regulated Entity No.
04/23/2026	O3670	RN106392624

For SOP applications, answer ALL questions unless otherwise directed.

◆ For GOP applications, answer ONLY these questions unless otherwise directed.

XI. Miscellaneous (continued)		
B. Forms		
◆	1. The application area contains units that are potentially subject to a regulation for which the TCEQ has not developed a unit attribute form. <i>If the response to Question XI.B.1 is "No," or "N/A," go to Section XI.C.</i>	<input type="checkbox"/> Yes <input checked="" type="checkbox"/> No <input type="checkbox"/> N/A
◆	2. Provide the Part and Subpart designation for the federal rule(s) or the Chapter, Subchapter, and Division designation for the State regulation(s) in the space provided below.	
C. Emission Limitation Certifications		
◆	1. The application area includes units for which federally enforceable emission limitations have been established by certification.	<input checked="" type="checkbox"/> Yes <input type="checkbox"/> No
D. Alternative Means of Control, Alternative Emission Limitation or Standard, or Equivalent Requirements		
	1. The application area is located at a site that is subject to a site-specific requirement of the state implementation plan (SIP).	<input type="checkbox"/> Yes <input checked="" type="checkbox"/> No
	2. The application area includes units located at the site that are subject to a site-specific requirement of the SIP.	<input type="checkbox"/> Yes <input checked="" type="checkbox"/> No
	3. The application area includes units which demonstrate compliance by using an alternative means of control, alternative emission limitation or standard or equivalent requirements approved by the EPA Administrator. <i>If the response to Question XI.D.3 is "Yes," please include a copy of the approval document with the application.</i>	<input type="checkbox"/> Yes <input checked="" type="checkbox"/> No
	4. The application area includes units which demonstrate compliance by using an alternative means of control, alternative emission limitation or standard or equivalent requirements approved by the TCEQ Executive Director. <i>If the response to Question XI.D.4 is "Yes," please include a copy of the approval document with the application.</i>	<input type="checkbox"/> Yes <input checked="" type="checkbox"/> No

Application Area-Wide Applicability Determinations and General Information
Form OP-REQ1 (Page 80)
Federal Operating Permit Program
Texas Commission on Environmental Quality

Date	Permit No.	Regulated Entity No.
04/23/2026	O3670	RN106392624

For SOP applications, answer ALL questions unless otherwise directed.

◆ For GOP applications, answer ONLY these questions unless otherwise directed.

XI. Miscellaneous (continued)		
E. Title IV - Acid Rain Program		
1.	The application area includes emission units subject to the Acid Rain Program (ARP), including the Opt-In Program.	<input checked="" type="checkbox"/> Yes <input type="checkbox"/> No
2.	The application area includes emission units qualifying for the new unit exemption under 40 CFR § 72.7.	<input type="checkbox"/> Yes <input checked="" type="checkbox"/> No
3.	The application area includes emission units qualifying for the retired unit exemption under 40 CFR § 72.8.	<input type="checkbox"/> Yes <input checked="" type="checkbox"/> No
F. 40 CFR Part 97, Subpart EEEEE - Cross-State Air Pollution Rule (CSAPR) NO_x Ozone Season Group 2 Trading Program		
1.	The application area includes emission units subject to the requirements of the CSAPR NO _x Ozone Season Group 2 Trading Program. <i>If the response to Question XI.F.1 is "No," go to Question XI.F.7.</i>	<input checked="" type="checkbox"/> Yes <input type="checkbox"/> No
2.	The application area includes units that are complying with the CEMS requirements of 40 CFR Part 75, Subpart H for NO _x and heat input.	<input checked="" type="checkbox"/> Yes <input type="checkbox"/> No
3.	The application area includes gas or oil-fired units that are complying with the CEMS requirements of 40 CFR Part 75, Subpart H for NO _x , and the monitoring requirements of 40 CFR Part 75, Appendix D for heat input.	<input checked="" type="checkbox"/> Yes <input type="checkbox"/> No
4.	The application area includes gas or oil-fired peaking units that are complying with the monitoring requirements of 40 CFR Part 75, Appendix E for NO _x , and the monitoring requirements of 40 CFR Part 75, Appendix D for heat input.	<input type="checkbox"/> Yes <input checked="" type="checkbox"/> No
5.	The application area includes gas or oil-fired units that are complying with the Low Mass Emissions monitoring requirements of 40 CFR § 75.19 for NO _x and heat input.	<input type="checkbox"/> Yes <input checked="" type="checkbox"/> No
6.	The application area includes units that are complying with EPA-approved alternative monitoring system requirements of 40 CFR Part 75, Subpart E for NO _x and heat input.	<input type="checkbox"/> Yes <input checked="" type="checkbox"/> No
7.	The application area includes emission units that qualify for the CSAPR NO _x Ozone Season Group 2 retired unit exemption.	<input type="checkbox"/> Yes <input checked="" type="checkbox"/> No

Application Area-Wide Applicability Determinations and General Information
Form OP-REQ1 (Page 81)
Federal Operating Permit Program
Texas Commission on Environmental Quality

Date	Permit No.	Regulated Entity No.
04/23/2026	O3670	RN106392624

For SOP applications, answer ALL questions unless otherwise directed.

◆ For GOP applications, answer ONLY these questions unless otherwise directed.

XI. Miscellaneous (continued)		
G. 40 CFR Part 97, Subpart FFFFF - Texas SO₂ Trading Program		
1.	The application area includes emission units complying with the requirements of the Texas SO ₂ Trading Program. <i>If the response to Question XI.G.1 is "No," go to Question XI.G.6.</i>	<input type="checkbox"/> Yes <input checked="" type="checkbox"/> No
2.	The application area includes units that are complying with the CEMS requirements of 40 CFR Part 75, Subpart B for SO ₂ and 40 CFR Part 75, Subpart H for heat input.	<input type="checkbox"/> Yes <input type="checkbox"/> No
3.	The application area includes gas or oil-fired units that are complying with the monitoring requirements of 40 CFR Part 75, Appendix D for SO ₂ and heat input.	<input type="checkbox"/> Yes <input type="checkbox"/> No
4.	The application area includes gas or oil-fired units that are complying with the Low Mass Emissions monitoring requirements of 40 CFR § 75.19 for SO ₂ and heat input.	<input type="checkbox"/> Yes <input type="checkbox"/> No
5.	The application area includes units that are complying with EPA-approved alternative monitoring system requirements of 40 CFR Part 75, Subpart E for SO ₂ and heat input.	<input type="checkbox"/> Yes <input type="checkbox"/> No
6.	The application area includes emission units that qualify for the Texas SO ₂ Trading Program retired unit exemption.	<input type="checkbox"/> Yes <input checked="" type="checkbox"/> No
H. Permit Shield (SOP Applicants Only)		
1.	A permit shield for negative applicability entries on Form OP-REQ2 (Negative Applicable Requirement Determinations) is being requested or already exists in the permit.	<input checked="" type="checkbox"/> Yes <input type="checkbox"/> No

Application Area-Wide Applicability Determinations and General Information
Form OP-REQ1 (Page 82)
Federal Operating Permit Program
Texas Commission on Environmental Quality

Date	Permit No.	Regulated Entity No.
04/23/2026	O3670	RN106392624

For SOP applications, answer ALL questions unless otherwise directed.

◆ For GOP applications, answer ONLY these questions unless otherwise directed.

XI. Miscellaneous (continued)		
I. GOP Type (Complete this section for GOP applications only)		
◆	1. The application area is applying for initial issuance, revision, or renewal of an oil and gas general operating permit under GOP No. 511 - Oil and Gas General Operating Permit for Brazoria, Chambers, Collin, Dallas, Denton, El Paso, Ellis, Fort Bend, Galveston, Hardin, Harris, Jefferson, Johnson, Kaufman, Liberty, Montgomery, Orange, Parker, Rockwall, Tarrant, Waller, and Wise Counties.	<input type="checkbox"/> Yes <input type="checkbox"/> No
◆	2. The application area is applying for initial issuance, revision, or renewal of an oil and gas general operating permit under GOP No. 512 - Oil and Gas General Operating Permit for Gregg, Nueces, and Victoria Counties.	<input type="checkbox"/> Yes <input type="checkbox"/> No
◆	3. The application area is applying for initial issuance, revision, or renewal of an oil and gas general operating permit under GOP No. 513 - Oil and Gas General Operating Permit for Aransas, Bexar, Calhoun, Matagorda, San Patricio, and Travis Counties.	<input type="checkbox"/> Yes <input type="checkbox"/> No
◆	4. The application area is applying for initial issuance, revision, or renewal of an oil and gas general operating permit under GOP No. 514 - Oil and Gas General Operating Permit for All Texas Counties Except Aransas, Bexar, Brazoria, Calhoun, Chambers, Collin, Dallas, Denton, El Paso, Ellis, Fort Bend, Galveston, Gregg, Hardin, Harris, Jefferson, Johnson, Kaufman, Liberty, Matagorda, Montgomery, Nueces, Orange, Parker, Rockwall, San Patricio, Tarrant, Travis, Victoria, Waller, and Wise County.	<input type="checkbox"/> Yes <input type="checkbox"/> No
◆	5. The application area is applying for initial issuance, revision, or renewal of a solid waste landfill general operating permit under GOP No. 517 - Municipal Solid Waste Landfill general operating permit.	<input type="checkbox"/> Yes <input type="checkbox"/> No
J. Title 30 TAC Chapter 101, Subchapter H		
◆	1. The application area is located in a nonattainment area. <i>If the response to Question XI.J.1 is "No," go to Question XI.J.3.</i>	<input type="checkbox"/> Yes <input checked="" type="checkbox"/> No
◆	2. The applicant has or will generate emission reductions to be credited in the TCEQ Emissions Banking and Trading Program.	<input type="checkbox"/> Yes <input type="checkbox"/> No <input type="checkbox"/> N/A
◆	3. The applicant has or will generate discrete emission reductions to be credited in the TCEQ Emissions Banking and Trading Program.	<input type="checkbox"/> Yes <input checked="" type="checkbox"/> No <input type="checkbox"/> N/A

Application Area-Wide Applicability Determinations and General Information
Form OP-REQ1 (Page 83)
Federal Operating Permit Program
Texas Commission on Environmental Quality

Date	Permit No.	Regulated Entity No.
04/23/2026	O3670	RN106392624

For SOP applications, answer ALL questions unless otherwise directed.

◆ For GOP applications, answer ONLY these questions unless otherwise directed.

XI. Miscellaneous (continued)		
J. Title 30 TAC Chapter 101, Subchapter H (continued)		
◆ 4.	The application area is located at a site in the Houston/Galveston/Brazoria nonattainment area where the facilities have a collective uncontrolled design capacity to emit 10 tpy or more of NO _x . <i>If the response to Question XI.J.4 is "Yes," go to Question XI.J.6.</i>	<input type="checkbox"/> Yes <input checked="" type="checkbox"/> No
◆ 5.	The application area is located at a site in the Houston/Galveston/Brazoria nonattainment area where the facilities previously had a collective uncontrolled design capacity to emit 10 tpy or more of NO _x and is subject to 101.351(c).	<input type="checkbox"/> Yes <input checked="" type="checkbox"/> No
6.	The application area includes an electric generating facility permitted under 30 TAC Chapter 116, Subchapter I.	<input type="checkbox"/> Yes <input checked="" type="checkbox"/> No
◆ 7.	The application area is located at a site in the Houston/Galveston/Brazoria nonattainment area and the site has a potential to emit more than 10 tpy of highly reactive volatile organic compounds (HRVOC) from facilities covered under 30 TAC Chapter 115, Subchapter H, Divisions 1 and 2.	<input type="checkbox"/> Yes <input checked="" type="checkbox"/> No
◆ 8.	The application area is located at a site in the Houston/Galveston/Brazoria nonattainment area, the site has a potential to emit 10 tpy or less of HRVOC from covered facilities and the applicant is opting to comply with the requirements of 30 TAC Chapter 101, Subchapter H, Division 6, Highly Reactive VOC Emissions Cap and Trade Program.	<input type="checkbox"/> Yes <input checked="" type="checkbox"/> No
K. Periodic Monitoring		
◆ 1.	The applicant or permit holder is submitting at least one periodic monitoring proposal described on Form OP-MON in this application. <i>If the response to Question XI.K.1 is "Yes," go to Section XI.L.</i>	<input type="checkbox"/> Yes <input checked="" type="checkbox"/> No
◆ 2.	The permit currently contains at least one periodic monitoring requirement. <i>If the responses to Questions XI.K.1 and XI.K.2 are both "No," go to Section XI.L.</i>	<input checked="" type="checkbox"/> Yes <input type="checkbox"/> No
◆ 3.	All periodic monitoring requirements are being removed from the permit with this application.	<input type="checkbox"/> Yes <input checked="" type="checkbox"/> No

Application Area-Wide Applicability Determinations and General Information
Form OP-REQ1 (Page 84)
Federal Operating Permit Program
Texas Commission on Environmental Quality

Date	Permit No.	Regulated Entity No.
04/23/2026	O3670	RN106392624

For SOP applications, answer ALL questions unless otherwise directed.

◆ For GOP applications, answer ONLY these questions unless otherwise directed.

XI. Miscellaneous (continued)		
L. Compliance Assurance Monitoring		
◆	1. The application area includes at least one unit that does not meet the CAM exemptions in 40 CFR § 64.2(b) for all applicable requirements that it is subject to, and the unit has a pre-control device potential to emit greater than or equal to the amount in tons per year required in a site classified as a major source. <i>If the response to Question XI.L.1 is "No," go to Section XI.M.</i>	<input checked="" type="checkbox"/> Yes <input type="checkbox"/> No
◆	2. The unit or units defined by XI.L.1 are using a control device to comply with an applicable requirement. <i>If the response to Question XI.L.2 is "No," go to Section XI.M.</i>	<input checked="" type="checkbox"/> Yes <input type="checkbox"/> No
◆	3. The permit holder has submitted a CAM proposal on Form OP-MON in a previous application.	<input checked="" type="checkbox"/> Yes <input type="checkbox"/> No
◆	4. The owner/operator or permit holder is submitting a CAM proposal on Form OP-MON according to the deadlines for submittals in 40 CFR § 64.5 in this application. <i>If the responses to Questions XI.L.3 and XI.L.4 are both "No," go to Section XI.M.</i>	<input type="checkbox"/> Yes <input checked="" type="checkbox"/> No
	5. The owner/operator or permit holder is submitting a CAM implementation plan and schedule to be incorporated as enforceable conditions in the permit.	<input type="checkbox"/> Yes <input checked="" type="checkbox"/> No
	6. Provide the unit identification numbers for the units for which the applicant is submitting a CAM implementation plan and schedule in the space below.	
◆	7. At least one unit defined by XI.L.1 and XI.L.2 is using a CEMS, COMS or PEMS meeting the requirements of 40 CFR § 64.3(d)(2).	<input checked="" type="checkbox"/> Yes <input type="checkbox"/> No
◆	8. All units defined by XI.L.1 and XI.L.2 are using a CEMS, COMS or PEMS meeting the requirements of 40 CFR § 64.3(d)(2). <i>If the response to Question XI.L.8 is "Yes," go to Section XI.M.</i>	<input checked="" type="checkbox"/> Yes <input type="checkbox"/> No

Application Area-Wide Applicability Determinations and General Information
Form OP-REQ1 (Page 85)
Federal Operating Permit Program
Texas Commission on Environmental Quality

Date	Permit No.	Regulated Entity No.
04/23/2026	O3670	RN106392624

For SOP applications, answer ALL questions unless otherwise directed.

◆ For GOP applications, answer ONLY these questions unless otherwise directed.

XI. Miscellaneous (continued)		
L. Compliance Assurance Monitoring (continued)		
◆	9. At least one of the CAM proposals as described by question XI.L.3 or XI.L.4 addresses particulate matter, and the emission unit has a capture system as defined in 40 CFR §64.1.	<input type="checkbox"/> Yes <input type="checkbox"/> No
◆	10. At least one of the CAM proposals as described by question XI.L.3 or XI.L.4 addresses VOC, and the emission unit has a capture system as defined in 40 CFR §64.1.	<input type="checkbox"/> Yes <input type="checkbox"/> No
◆	11. At least one of the CAM proposals as described by question XI.L.3 or XI.L.4 addresses a regulated pollutant other than particulate matter or VOC, and the emission unit has a capture system as defined in 40 CFR §64.1.	<input type="checkbox"/> Yes <input type="checkbox"/> No
◆	12. The control device in the CAM proposal as described by question XI.L.3 or XI.L.4 has a bypass.	<input type="checkbox"/> Yes <input type="checkbox"/> No
M. Title 30 TAC Chapter 113, Subchapter D, Division 5 - Emission Guidelines and Compliance Times		
◆	1. The application area includes at least one air curtain incinerator that commenced construction on or before December 9, 2004. <i>If the response to Question XI.M.1 is "No," or "N/A," go to Section XII.</i>	<input type="checkbox"/> Yes <input checked="" type="checkbox"/> No <input type="checkbox"/> N/A
◆	2. All air curtain incinerators constructed on or before December 9, 2004 combust only wood waste, clean lumber, or yard waste or a mixture of these materials.	<input type="checkbox"/> Yes <input type="checkbox"/> No
XII. New Source Review (NSR) Authorizations		
A. Waste Permits with Air Addendum		
◆	1. The application area includes a Municipal Solid Waste Permit or an Industrial Hazardous Waste with an Air Addendum. <i>If the response to XII.A.1 is "Yes," include the waste permit numbers and issuance date in Section XII.J.</i>	<input type="checkbox"/> Yes <input checked="" type="checkbox"/> No

Application Area-Wide Applicability Determinations and General Information
Form OP-REQ1 (Page 86)
Federal Operating Permit Program
Texas Commission on Environmental Quality

Date	Permit No.	Regulated Entity No.
04/23/2026	O3670	RN106392624

For SOP applications, answer ALL questions unless otherwise directed.

◆ For GOP applications, answer ONLY these questions unless otherwise directed.

XII. New Source Review (NSR) Authorizations (continued)		
B. Air Quality Standard Permits		
◆ 1.	The application area includes at least one Air Quality Standard Permit NSR authorization. <i>If the response to XII.B.1 is "No," go to Section XII.C. If the response to XII.B.1 is "Yes," be sure to include the standard permit's registration numbers in Section XII.H and answer XII.B.2 - B.16 as appropriate.</i>	<input checked="" type="checkbox"/> Yes <input type="checkbox"/> No
◆ 2.	The application area includes at least one "State Pollution Control Project" Air Quality Standard Permit NSR authorization under 30 TAC § 116.617.	<input type="checkbox"/> Yes <input checked="" type="checkbox"/> No
◆ 3.	The application area includes at least one non-rule Air Quality Standard Permit for Pollution Control Projects NSR authorization.	<input type="checkbox"/> Yes <input checked="" type="checkbox"/> No
◆ 4.	The application area includes at least one "Installation and/or Modification of Oil and Gas Facilities" Air Quality Standard Permit NSR authorization under 30 TAC § 116.620.	<input type="checkbox"/> Yes <input checked="" type="checkbox"/> No
◆ 5.	The application area includes at least one non-rule Air Quality Standard Permit for Oil and Gas Handling and Production Facilities NSR authorization.	<input type="checkbox"/> Yes <input checked="" type="checkbox"/> No
◆ 6.	The application area includes at least one "Municipal Solid Waste Landfill" Air Quality Standard Permit NSR authorization under 30 TAC § 116.621.	<input type="checkbox"/> Yes <input checked="" type="checkbox"/> No
◆ 7.	The application area includes at least one "Municipal Solid Waste Landfill Facilities and Transfer Stations" Standard Permit authorization under 30 TAC Chapter 330, Subchapter U.	<input type="checkbox"/> Yes <input checked="" type="checkbox"/> No
8.	The application area includes at least one "Concrete Batch Plant" Air Quality Standard Permit NSR authorization.	<input type="checkbox"/> Yes <input checked="" type="checkbox"/> No
9.	The application area includes at least one "Concrete Batch Plant with Enhanced Controls" Air Quality Standard Permit NSR authorization.	<input type="checkbox"/> Yes <input checked="" type="checkbox"/> No
10.	The application area includes at least one "Hot Mix Asphalt Plant" Air Quality Standard Permit NSR authorization.	<input type="checkbox"/> Yes <input checked="" type="checkbox"/> No

Application Area-Wide Applicability Determinations and General Information
Form OP-REQ1 (Page 87)
Federal Operating Permit Program
Texas Commission on Environmental Quality

Date	Permit No.	Regulated Entity No.
04/23/2026	O3670	RN106392624

For SOP applications, answer ALL questions unless otherwise directed.

◆ For GOP applications, answer ONLY these questions unless otherwise directed.

XII. New Source Review (NSR) Authorizations (continued)		
B. Air Quality Standard Permits (continued)		
◆	11. The application area includes at least one “Rock Crusher” Air Quality Standard Permit NSR authorization.	<input type="checkbox"/> Yes <input checked="" type="checkbox"/> No
◆	12. The application area includes at least one “Electric Generating Unit” Air Quality Standard Permit NSR authorization. <i>If the response to XII.B.12 is “No,” go to Question XII.B.15.</i>	<input checked="" type="checkbox"/> Yes <input type="checkbox"/> No
◆	13. For purposes of “Electric Generating Unit” Air Quality Standard Permit, the application area is located in the East Texas Region.	<input type="checkbox"/> Yes <input checked="" type="checkbox"/> No
◆	14. For purposes of “Electric Generating Unit” Air Quality Standard Permit, the application area is located in the West Texas Region.	<input checked="" type="checkbox"/> Yes <input type="checkbox"/> No
◆	15. The application area includes at least one “Boiler” Air Quality Standard Permit NSR authorization.	<input type="checkbox"/> Yes <input checked="" type="checkbox"/> No
◆	16. The application area includes at least one “Sawmill” Air Quality Standard Permit NSR authorization.	<input type="checkbox"/> Yes <input checked="" type="checkbox"/> No
C. Flexible Permits		
	1. The application area includes at least one Flexible Permit NSR authorization.	<input type="checkbox"/> Yes <input checked="" type="checkbox"/> No
D. Multiple Plant Permits		
	1. The application area includes at least one Multi-Plant Permit NSR authorization.	<input type="checkbox"/> Yes <input checked="" type="checkbox"/> No

Application Area-Wide Applicability Determinations and General Information
Form OP-REQ1 (Page 88)
Federal Operating Permit Program
Texas Commission on Environmental Quality

Date	Permit No.	Regulated Entity No.
04/23/2026	O3670	RN106392624

For SOP applications, answer ALL questions unless otherwise directed.

◆ For GOP applications, answer ONLY these questions unless otherwise directed.

XII. NSR Authorizations (Attach additional sheets if necessary for sections XII.E-J.)

E. PSD Permits and PSD Major Pollutants

Permit No.	Issuance Date	Pollutant(s):	Permit No.	Issuance Date	Pollutant(s):

If PSD Permits are held for the application area, please complete the Major NSR Summary Table located under the Technical Forms heading at: www.tceq.texas.gov/permitting/air/titlev/site/site_experts.html.

F. Nonattainment (NA) Permits and NA Major Pollutants

Permit No.	Issuance Date	Pollutant(s):	Permit No.	Issuance Date	Pollutant(s):

If NA Permits are held for the application area, please complete the Major NSR Summary Table located under the Technical Forms heading at: www.tceq.texas.gov/permitting/air/titlev/site/site_experts.html.

G. NSR Authorizations with FCAA § 112(g) Requirements

NSR Permit No.	Issuance Date	NSR Permit No.	Issuance Date	NSR Permit No	Issuance Date

Application Area-Wide Applicability Determinations and General Information
Form OP-REQ1 (Page 89)
Federal Operating Permit Program
Texas Commission on Environmental Quality

Date	Permit No.	Regulated Entity No.
04/23/2026	O3670	RN106392624

For SOP applications, answer ALL questions unless otherwise directed.

- ◆ For GOP applications, answer ONLY these questions unless otherwise directed.

XII. NSR Authorizations (continued) - (Attach additional sheets if necessary for sections XII.E-J.)

- ◆ **H. Title 30 TAC Chapter 116 Permits, Special Permits, Standard Permits, Other Authorizations (Other Than Permits By Rule, PSD Permits, NA Permits) for the Application Area**

Authorization No.	Issuance Date	Authorization No.	Issuance Date	Authorization No.	Issuance Date
123471	03/07/2024				

- ◆ **I. Permits by Rule (30 TAC Chapter 106) for the Application Area**

A list of selected Permits by Rule (previously referred to as standard exemptions) that are required to be listed in the FOP application is available in the instructions.

PBR No.	Version No./Date	PBR No.	Version No./Date	PBR No.	Version No./Date
106.227	09/04/2000	106.452	09/04/2000		
106.454	11/01/2001	106.532	09/04/2000		
106.412	09/04/2000				
106.511	09/04/2000				
106.472	09/04/2000				
106.263	11/01/2001				
106.265	09/04/2000				
106.433	09/04/2000				

- ◆ **J. Municipal Solid Waste and Industrial Hazardous Waste Permits with an Air Addendum**

Permit No.	Issuance Date	Permit No.	Issuance Date	Permit No.	Issuance Date



Form OP-SUM

Negative Applicable/Superseded Requirement Determinations
Form OP-REQ2
Federal Operating Permit Program
Texas Commission on Environmental Quality

General Information

Requested Information	Response
Date:	04/23/2026
Customer Reference No.:	CN600352819
Regulated Entity No.:	RN106392624
Permit No.:	O3670
Permit Area Name:	Montana Power Station
Permit Type:	SOP
Project Type:	Renewal
Submission Type:	New Application
Project Number (if available):	N/A
Form Information	TCEQ Entry Only
Title V Form Release Date:	07/2025
Form Number:	10017
APD ID Number:	156v1.0
Version Revised Date:	07/2025
	This form is for use by facilities subject to air quality permit requirements and may be revised periodically.



Form OP-UA2

**Stationary Reciprocating Internal Combustions Engine Attributes
Form OP-UA2
Federal Operating Permit Program
Texas Commission on Environmental Quality**

General Information

Requested Information	Response
Date:	04/23/2026
Customer Reference No.:	CN600352819
Regulated Entity No.:	RN106392624
Permit No.:	O3670
Permit Area Name:	Montana Power Station
Permit Type:	SOP
Project Type:	Renewal
Submission Type:	New Application
Project Number (if available):	N/A
Form Information	TCEQ Entry Only
Title V Form Release Date:	02/2025
Form Number:	10003
APD ID Number:	27v1.0
Version Revised Date:	07/2025
	This form is for use by facilities subject to air quality permit requirements and may be revised periodically.

**Stationary Reciprocating Internal Combustions Engine Attributes
Form OP-UA2**

**Federal Operating Permit Program
Texas Commission on Environmental Quality**

**Table 2a: Title 40 Code of Federal Regulations Part 63 (40 CFR Part 63)
Subpart ZZZZ: National Emission Standards for Hazardous Air Pollutants for Stationary Reciprocating Internal Combustion Engines**

Unit ID No.	SOP/GOP Index No.	HAP Source	Brake HP	Construction/ Reconstruction Date	Nonindustrial Emergency Engine	Service Type	Stationary RICE Type
FWP-1	63ZZZZ-01	AREA	300-500	06+			
EGEN-1	63ZZZZ-02	AREA	500+	06+			
EG-1	63ZZZZ-03	AREA	500+	06+			

[Go to the Table of Contents](#)

Stationary Reciprocating Internal Combustions Engine Attributes
Form OP-UA2
Federal Operating Permit Program
Texas Commission on Environmental Quality

Table 2b: Title 40 Code of Federal Regulations Part 63 (40 CFR Part 63)
Subpart ZZZZ: National Emission Standards for Hazardous Air Pollutants for Stationary Reciprocating Internal Combustion Engines

Unit ID No.	SOP/GOP Index No.	Manufacture Date	Operating Hours	Different Schedule	Emission Limitation	Displacement
FWP-1	63ZZZZ-01					
EGEN-1	63ZZZZ-02					
EG-1	63ZZZZ-03					

[Go to the Table of Contents](#)

**Stationary Reciprocating Internal Combustions Engine Attributes
Form OP-UA2**

**Federal Operating Permit Program
Texas Commission on Environmental Quality**

**Table 2c: Title 40 Code of Federal Regulations Part 63 (40 CFR Part 63)
Subpart ZZZZ: National Emission Standards for Hazardous Air Pollutants for Stationary Reciprocating Internal Combustion Engines**

Unit ID No.	SOP/GOP Index No.	Crankcase	Performance Test	Control Technique	Operating Limits	Monitoring System
FWP-1	63ZZZZ-01					
EGEN-1	63ZZZZ-02					
EG-1	63ZZZZ-03	NO	NO	OTHER2	NO	OTHER

[Go to the Table of Contents](#)

Stationary Reciprocating Internal Combustions Engine Attributes
Form OP-UA2
Federal Operating Permit Program
Texas Commission on Environmental Quality

Table 5a: Title 40 Code of Federal Regulations Part 60 (40 CFR Part 60)
Subpart III: Standards of Performance for Stationary Compression Ignition Internal Combustion Engines

Unit ID No.	SOP/GOP Index No.	Applicability Date	Exemptions	Service	Commencing	Manufacture Date
FWP-1	60III-01	2005+	NONE	FIRE	CON	0706+
EGEN-1	60III-02	2005+	NONE	EMERG	CON	0406+
EG-1	60III-03	2005+	NONE	EMERG	CON	0406+

[Go to the Table of Contents](#)

Stationary Reciprocating Internal Combustions Engine Attributes
Form OP-UA2
Federal Operating Permit Program
Texas Commission on Environmental Quality

Table 5b: Title 40 Code of Federal Regulations Part 60 (40 CFR Part 60)
Subpart IIII: Standards of Performance for Stationary Compression Ignition Internal Combustion Engines

Unit ID No.	SOP/GOP Index No.	Diesel	AES No.	Displacement	Generator Set	Model Year	Install Date
FWP-1	60III-01	DIESEL		10-		2011	
EGEN-1	60III-02	DIESEL		25-30		2014	
EG-1	60III-03	DIESEL		30+			2012+

[Go to the Table of Contents](#)

Stationary Reciprocating Internal Combustions Engine Attributes
Form OP-UA2
Federal Operating Permit Program
Texas Commission on Environmental Quality

Table 5c: Title 40 Code of Federal Regulations Part 60 (40 CFR Part 60)
Subpart III: Standards of Performance for Stationary Compression Ignition Internal Combustion Engines

Unit ID No.	SOP/GOP Index No.	Kilowatts	Filter	AECD	Standard	Compliance Option	PM Compliance	Options
FWP-1	60III-01	F130-368			NO	MANU YES		2650-
EGEN-1	60III-02	E600-1400		NO	NO	MANU YES		
EG-1	60III-03			NO	NO			

[Go to the Table of Contents](#)



Form OP-UA3

**Storage Tank/Vessel Attributes
Form OP-UA3
Federal Operating Permit Program
Texas Commission on Environmental Quality**

General Information

Requested Information	Response
Date:	04/23/2026
Customer Reference No.:	CN600352819
Regulated Entity No.:	RN106392624
Permit No.:	O3670
Permit Area Name:	Montana Power Station
Permit Type:	SOP
Project Type:	Renewal
Submission Type:	New Application
Project Number (if available):	N/A
Form Information	TCEQ Entry Only
Title V Form Release Date:	02/2025
Form Number:	10008
APD ID Number:	37v1.0
Version Revised Date:	02/2025
	This form is for use by facilities subject to air quality permit requirements and may be revised periodically.

Storage Tank/Vessel Attributes
 Form OP-UA3
 Federal Operating Permit Program
 Texas Commission on Environmental Quality

**Table 3: Title 40 Code of Federal Regulations Part 60 (40 CFR Part 60)
 Subpart Kb: Standards of Performance for Volatile Organic Liquid Storage Vessels (Including Petroleum Liquid Storage Vessels)**

Unit ID No.	SOP/GOP Index No.	Product Stored	Storage Capacity	WW Tank Control	Maximum TVP	Storage Vessel Description	AMEL ID No.	Guidepole	Reid Vapor Pressure	Control Device ID No.
DST	60Kb-1	VOL	40K+	NONE	0.5-					
DIESEL	60Kb-2	VOL	10K-							

[Go to the Table of Contents](#)

Storage Tank/Vessel Attributes
Form OP-UA3
Federal Operating Permit Program
Texas Commission on Environmental Quality

**Table 4a: Title 30 Texas Administrative Code Chapter 115 (30 TAC Chapter 115)
Subchapter B: Storage of Volatile Organic Compounds (VOCs)**

Unit ID No.	SOP/GOP Index No.	Alternate Control Requirement	ACR ID No.	Product Stored	Storage Capacity	Throughput	Potential to Emit	Uncontrolled Emissions
DST	R5112	NO		VOC1	A40K+			
DIESEL	R5112	NO		VOC1	A1K-			

[Go to the Table of Contents](#)

**Storage Tank/Vessel Attributes
Form OP-UA3
Federal Operating Permit Program
Texas Commission on Environmental Quality**

**Table 4b: Title 30 Texas Administrative Code Chapter 115 (30 TAC Chapter 115)
Subchapter B: Storage of Volatile Organic Compounds (VOCs)**

Unit ID No.	SOP/GOP Index No.	Construction Date	Tank Description	True Vapor Pressure	Primary Seal	Secondary Seal	Control Device Type	Control Device ID No.
DST	R5112		NONE1	1-				
DIESEL	R5112		NONE1	1-				

[Go to the Table of Contents](#)



Form OP-UA11

**Stationary Turbine Attributes
Form OP-UA11
Federal Operating Permit Program
Texas Commission on Environmental Quality**

General Information

Requested Information	Response
Date:	04/23/2026
Customer Reference No.:	CN600352819
Regulated Entity No.:	RN106392624
Permit No.:	O3670
Permit Area Name:	Montana Power Station
Permit Type:	SOP
Project Type:	Renewal
Submission Type:	New Application
Project Number (if available):	N/A
Form Information	TCEQ Entry Only
Title V Form Release Date:	01/2025
Form Number:	10023
APD ID Number:	45v1.0
Version Revised Date:	07/2025
	This form is for use by facilities subject to air quality permit requirements and may be revised periodically.

Stationary Turbine Attributes
Form OP-UA11
Federal Operating Permit Program
Texas Commission on Environmental Quality

Table 6a: Title 40 Code of Federal Regulations Part 60 (40 CFR Part 60)
Subpart KKKK: Stationary Combustion Turbines

Unit ID No.	SOP Index No.	Unit Type	Construction/ Modification Date	Heat Input	Subject to Da	Service Type	NOx Standard	Fuel Type
GRP-GT	60KKKK-1	SIMPLE	2005C	850+	NO	NOTER	YES	NGFO+
GRP-GT	60KKKK-2	SIMPLE	2005C	850+	NO	NOTER	YES	NGFO+

[Go to the Table of Contents](#)

Stationary Turbine Attributes
Form OP-UA11
Federal Operating Permit Program
Texas Commission on Environmental Quality

Table 6b: Title 40 Code of Federal Regulations Part 60 (40 CFR Part 60)
Subpart KKKK: Stationary Combustion Turbines

Unit ID No.	SOP Index No.	75% of Peak	30 MW	Turbine Use	NOx Control	NOx Monitoring	Common Steam Header	Duct Burner
GRP-GT	60KKKK-1	YES	NO	ELCT	YES	CEMS		
GRP-GT	60KKKK-2	NO		ELCT	YES	CEMS		

[Go to the Table of Contents](#)

Stationary Turbine Attributes
Form OP-UA11
Federal Operating Permit Program
Texas Commission on Environmental Quality

Table 6c: Title 40 Code of Federal Regulations Part 60 (40 CFR Part 60)
Subpart KKKK: Stationary Combustion Turbines

Unit ID No.	SOP Index No.	Location	SO2 Standard	Fuel Monitoring	Fuel Quality	Performance Test	Intermediate Storage	Fuel Schedules
GRP-GT	60KKKK-1	NO	NO	YES	SAMP	SAMP		
GRP-GT	60KKKK-2	NO	NO	YES	SAMP	SAMP		

[Go to the Table of Contents](#)



Form OP-UA15

**Emission Point/Stationary Vent/Distillation Operation Vent/Process Vent Attributes
Form OP-UA15
Federal Operating Permit Program
Texas Commission on Environmental Quality**

General Information

Requested Information	Response
Date:	04/23/2026
Customer Reference No.:	CN600352819
Regulated Entity No.:	RN106392624
Permit No.:	O3670
Permit Area Name:	Montana Power Station
Permit Type:	SOP
Project Type:	Renewal
Submission Type:	New Application
Project Number (if available):	N/A
Form Information	TCEQ Entry Only
Title V Form Release Date:	11/2022
Form Number:	10046
APD ID Number:	50v1.0
Version Revised Date:	07/2025
	This form is for use by facilities subject to air quality permit requirements and may be revised periodically.

Emission Point/Stationary Vent/Distillation Operation Vent/Process Vent Attributes
Form OP-UA15
Federal Operating Permit Program
Texas Commission on Environmental Quality

Table 1a: Title 30 Texas Administrative Code Chapter 111 (30 TAC Chapter 111)
Subchapter A: Visible Emissions

Emission Point ID No.	SOP/GOP Index No.	Alternate Opacity Limitation	AOL ID No.	Vent Source	Opacity Monitoring System	Construction Date	Effluent Flow Rate
CT-1	R1111	NO		OTHER	NONE	72+	100+
CT-2	R1111	NO		OTHER	NONE	72+	100+
GRP-GT	R1111	NO		OTHER	NONE	72+	100+

[Go to the Table of Contents](#)



Form OP-PBRSUP

Permit By Rule Supplemental Table (Page 1)
Table A: Registered Permits by Rule (30 TAC Chapter 106) for the Application Area
Texas Commission on Environmental Quality

Date	Permit Number	Regulated Entity Number
04/23/2026	O3670	RN106392624

Unit ID No.	Registration No.	PBR No.	Registration Date
EG-1	149594	106.511/09/04/2000	01/12/2018

Permit By Rule Supplemental Table (Page 2)
Table B: Claimed (not registered) Permits by Rule (30 TAC Chapter 106) for the Application Area
Texas Commission on Environmental Quality

Date	Permit Number	Regulated Entity Number
04/23/2026	O3670	RNI06392624

Unit ID No.	PBR No.	Version No./Date
WELD	106.227	09/04/2000
DST	106.472	09/04/2000
EGEN-1	106.511	09/04/2000
FUELDF	106.412	09/04/2000
PARTWASH	106.454	11/01/2001
SITEMSS	106.263	11/01/2001
HANDHELD	106.265	09/04/2000
SURFCOAT	106.433	09/04/2000
OUTDRBLST	106.452	09/04/2000
SLUDGE	106.532	09/04/2000

Permit By Rule Supplemental Table (Page 3)
Table C: Claimed (not registered) Permits by Rule (30 TAC Chapter 106) for Insignificant Sources for the Application Area
Texas Commission on Environmental Quality

Date	Permit Number	Regulated Entity Number
04/23/2026	O3670	RNI106392624

PBR No.	Version No./Date
None	

Permit By Rule Supplemental Table (Page 4)
Table D: Monitoring Requirements for registered and claimed PBRs for the Application Area
Texas Commission on Environmental Quality

Date	Permit Number	Regulated Entity Number
04/23/2026	O3670	RN106392624

Unit ID No.	PBR No.	Version No./Date Or Registration No.	Monitoring Requirement
EG-1	106.511	149594	Keep records of monthly engine run time hours and identify whether for maintenance or emergency purposes.
WELD	106.227	09/04/2000	Maintain records that brazing, soldering, or welding equipment does not emit greater than 0.6 ton per year of lead.
DST	106.472	09/04/2000	Maintain records verifying the chemicals loaded, unloaded, or stored are limited to listed chemicals in the PBR.
EGEN-1	106.511	09/04/2000	Keep records of monthly engine run time hours and identify whether for maintenance or emergency purposes.
FUELDF	106.412	09/04/2000	Keep records demonstrating equipment is used exclusively to store and dispense motor fuels into heavy and light-duty motor vehicles.
PARTWASH	106.454	11/01/2001	Maintain records demonstrating the true vapor pressure of the solvent does not exceed 0.6 psia at an operating temperature of 100 degrees Fahrenheit.

Permit By Rule Supplemental Table (Page 4)
Table D: Monitoring Requirements for registered and claimed PBRs for the Application Area (continued)
Texas Commission on Environmental Quality

Date	Permit Number	Regulated Entity Number
04/23/2026	O3670	RN106392624

Unit ID No.	PBR No.	Version No./Date Or Registration No.	Monitoring Requirement
SITEMSS	106.263	11/01/2001	Maintain records for all maintenance, start-up, or shutdown (MSS) activities and temporary maintenance facilities.
HANDHELD	106.265	09/04/2000	Verify equipment is used for buffing, polishing, carving, cutting, drilling, machining, routing, sanding, sawing, surface grinding, or turning of ceramic art work, ceramic precision parts, leather, metals, plastics, fiber board, masonry, carbon, glass, graphite, or wood.
SURFCOAT	106.433	09/04/2000	Maintain records of good housekeeping procedures, fuel type and usage rates of drying or curing ovens (if not electric). Demonstrate total annual uncontrolled emissions from coating materials are below 30 lb/hr and 25 TPY VOC, or 5 lb/hr and 10 TPY exempt solvents. Opacity of visible emissions shall not exceed 5.0% averaged over a 6-minute period.
OUTDRBLST	106.452	09/04/2000	Document enclosed abrasive blasting with fabric filter with a maximum filtering velocity of 4.0 feet per minute (ft/min) with mechanical cleaning or 7.0 ft/min with air cleaning. Maintain records of: daily, monthly, and annual abrasive usage rates; abrasive cleaning operating hours; and no visible fugitive emissions occur from the facility.
SLUDGE	106.532	09/04/2000	Verify that the facility will only perform the functions listed in 106.532(1)(A)-(O) and maintain records, including test results, standard reference materials, calculations, and/or other information, which document that the sum of the partial pressures of all species of VOC in the oil/water separator is less than 1.5 psia, chlorine or sulfur dioxide emissions will not exceed 10 tons per year, and final emissions of HCl resulting from combustion of chlorine or chlorine-containing compounds shall not exceed 0.1 pounds per hour.

wsp





Join

Log in

Esperanza Acosta Moreno Library – El Paso Public Libraries

Location System

El Paso Library

Library Information

Esperanza Acosta Moreno Library – El Paso Public Libraries

(915) 212-0442

12480 Pebble Hills Boulevard

El Paso, TX 79938

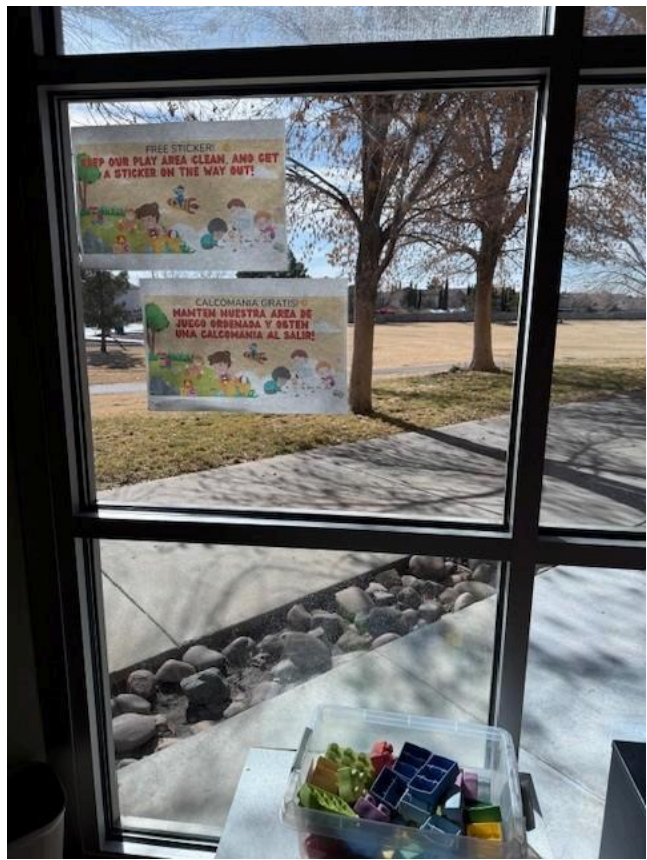
United States



Google

Map data ©2026





During 2025, we hosted two separate series of 5-week workshops, during the late winter and early fall seasons, on Thursday mornings at 10 am after pre-registering attendees via social media promotion; the workshops were very much a success in both instances with enthusiastic and consistent participation, more or less, although by the last workshop session participation would tend to taper off due to various factors. The average attendance per session would amount

to about 30 participants. Although most often the children would be brought in by one primary caregiver, who would usually be the mother or occasionally another relative such as a grandparent, we also had quite a few parents who would regularly come in pairs with their children to play and interact with them which was quite fulfilling to witness.

Feedback responses from the parent/child post-workshop surveys were generally very positive and reinforced the objectives and work behind planning and conducting these workshops; parents indicated that they felt informed about their children's development and found the resource professionals to be helpful. The dramatic play, musical instruments and toys for babies were among the more popular stations with one parent stating that she made it a point to encourage her child to try out the other toys; during the first session, I as the facilitator did make it clear that the parents should mainly follow their children's lead but could still gently guide them accordingly as well as take opportunities to teach them how to better cooperate or share toys with other children with the understanding that these skills take some time to fully develop- one parent indicated that one of the aspects they liked most about the workshops was the socialization with other children that their own child was exposed to directly.

Overall, it was very rewarding and fairly easy to coordinate and work with partnering organizations to provide reliable and friendly resource professionals to come and visit in order to provide useful information and giveaways for the families.



Search the Directory

Search

Rep. Eddie Morales, Jr. (D)

Last modified on: 01-10-2025 23:31:20

[↩ Back to Texas House of Representatives \(/online/txhouse/\)](/online/txhouse/)

TX House Representative (Texas House of Representatives (/online/txhouse/))

Entered Office: 01-12-2021

District: 74

General Information

Profession: Attorney

Home Town: Eagle Pass

Birthdate: 01-24-1975

Spouse: Hellen

Download vCard (/online/vcard/?id=66159&office=16747) (? (/online/aboutvcards/))



+ Add to Favorites (/online/add_favorite/?name=Rep. Eddie Morales, Jr.)

Personal Information

BA, The University of Texas at Austin 1997; JD, St. Mary's University School of Law, 2000

Office Information

Dist. 74 - Brewster, Culberson, El Paso (6%), Hudspeth, Jeff Davis, Kinney, Maverick, Presidio, Reeves, Terrell, Val Verde

Sens. Blanco, Gutierrez

Committees

Energy Resources-VC (</online/housecom/detail.php?id=267>); Select Committee on Governmental Oversight (</online/housecom/detail.php?id=600>); Transportation (</online/housecom/detail.php?id=292>)

Contact and Phone Numbers

Capitol Office:

E2.406

Capitol Phone: (512) 463-0566

📍 Zip Codes Within The District (<https://fyi.capitol.texas.gov/fyiwebdocs/PDF/house/dist74/r9.pdf>)

📍 District Map (<http://www.fyi.legis.state.tx.us/fyiwebdocs/PDF/house/dist74/m1.pdf>)

✉ eddie.morales@house.texas.gov (<mailto:eddie.morales@house.texas.gov>)

100 Monroe St.

Eagle Pass, TX 78852

📞 (512) 463-0566

1915 Veterans Blvd.

Del Rio, TX 78840

Staff

Office	Office Holder	Phone / Fax
Chief of Staff	Cayden McCord (/online/person/?id=71311&staff=10880)	(512) 463-0566
Deputy Chief of Staff/LD	Raymundo Rodriguez (/online/person/?id=68456&staff=10019)	(512) 463-0566
Dist. DirectorEagle Pass-Del Rio	Sonia Moreno (/online/person/?id=72959&staff=11439)	(512) 463-0566
Field Rep./El Paso & West Texas	Gracie Viramontes (/online/person/?id=72960&staff=11440)	(512) 463-0566

Office	Office Holder	Phone / Fax
Legislative Aide	Joaquin Olivas (/online/person/?id=72958&staff=11438)	(512) 463-0566
Legislative Aide	Cuauhtemoc Saucedo (/online/person/?id=72957&staff=11437)	(512) 463-0566

Recent Searches

McCamey (City) (/online/search/?tosearch=McCamey+%28City%29&searchcat=1)

Hemphill (City) (/online/search/?tosearch=Hemphill+%28City%29&searchcat=1)

College Station (/online/search/?tosearch=college+station&searchcat=1)

My Favorites (/online/favorites/)

Cities (/online/city/?page=35)

Cities (/online/city/)

Counties (/online/county/?aid=m)

Helpful Links

Find My Incumbent (<http://www.fyi.legis.state.tx.us/>)

Capitol Maps (<https://tspb.texas.gov/plan/maps/maps.html>)

Bill Filings (<http://www.legis.state.tx.us/>)

Bill Search (<http://www.legis.state.tx.us/Search/BillSearch.aspx>)

Texas at Your Fingertips (<https://texas.gov/>)

State Symbols (<https://www.thestoryoftexas.com/education/texas-symbols>)

Governor Appointment (<https://gov.texas.gov/news/category/appointment>)

Addressing Procedures (<https://lrl.texas.gov/genInfo/ContactLeg.cfm>)

Since 1935 the Texas State Directory has been a trusted resource and has been referred to as the bible for anyone working in or wanting to learn about state, city and county government.

Recent Searches

MCCAMEY (CITY) (</ONLINE/SEARCH/?TOSEARCH=MCCAMEY+%28CITY%29&SEARCHCAT=1>)

HEMPHILL (CITY) (</ONLINE/SEARCH/?TOSEARCH=HEMPHILL+%28CITY%29&SEARCHCAT=1>)

COLLEGE STATION (</ONLINE/SEARCH/?TOSEARCH=COLLEGE+STATION&SEARCHCAT=1>)

FARMERSVILLE (</ONLINE/SEARCH/?TOSEARCH=FARMERSVILLE&SEARCHCAT=1>)

RAY POWELL (</ONLINE/SEARCH/?TOSEARCH=RAY+POWELL&SEARCHCAT=1>)

Useful Links

FIND MY INCUMBENT ([HTTP://WWW.FYI.LEGIS.STATE.TX.US/](http://www.fyi.legis.state.tx.us/)) >

CAPITOL MAPS ([HTTPS://TSPB.TEXAS.GOV/PLAN/MAPS/MAPS.HTML](https://tspb.texas.gov/plan/maps/maps.html)) >

BILL FILINGS ([HTTP://WWW.LEGIS.STATE.TX.US/](http://www.legis.state.tx.us/)) >

BILL SEARCH ([HTTP://WWW.LEGIS.STATE.TX.US/SEARCH/BILLSEARCH.ASPX](http://www.legis.state.tx.us/search/billsearch.aspx)) >

TEXAS AT YOUR FINGERTIPS ([HTTPS://TEXAS.GOV/](https://texas.gov/)) >

STATE SYMBOLS ([HTTP://WWW.LEGIS.STATE.TX.US/RESOURCES/STATESYMBOLS.ASPX](http://www.legis.state.tx.us/resources/statesymbols.aspx)) >


GOVERNOR APPOINTMENT ([HTTPS://GOV.TEXAS.GOV/NEWS/CATEGORY/APPOINTMENT](https://gov.texas.gov/news/category/appointment)) >

Contact Us

Texas State Directory Press

1800 Nueces St.

Austin, Texas 78701

 (512) 473-2447

 [Contact Us \(/contact/\)](/contact/)



Search the Directory

Search

Sen. César Blanco (D)

Last modified on: 07-14-2025 14:14:49

[← Back to Texas Senate \(/online/txsenate/\)](/online/txsenate/)

TX Senator (Texas Senate (/online/txsenate/))

Entered Office: 01-03-2021

Term Ends: 01-2029

District: 29

General Information

Profession: Consultant & Business Owner

Home Town: El Paso

Birthdate: 04-23-1976

Spouse: Lilly

Download vCard (/online/vcard/?id=50237&office=28536) (? (/online/aboutvcards/))



✚ Add to Favorites (/online/add_favorite/?name=)

Personal Information

B.A. Political Science-University of Texas at El Paso

Office Information

Dist. 29 - Brewster (93%), Culberson, El Paso, Hudspeth, Jeff Davis, Pecos, Presidio, Reeves

Committees

Business & Commerce (/online/sencom/detail.php?id=298); Committee on Disaster Preparedness and Flooding (/online/sencom/detail.php?id=587); Committee on Religious Liberty (/online/sencom/detail.php?id=596); Health & Human Services (/online/sencom/detail.php?id=303); Natural Resources (/online/sencom/detail.php?id=311); Water, Agriculture & Rural Affairs (/online/sencom/detail.php?id=523)

Contact and Phone Numbers

Capitol Office:

3E.2

☎ (915) 577-0029

📍 District Map (<https://redistricting.capitol.texas.gov/Current-districts>)

✉ cesar.blanco@senate.texas.gov (<mailto:cesar.blanco@senate.texas.gov>)

District Office

416 N. Stanton Street, Suite 700

El Paso, TX 79901

☎ (915) 577-0029

1618 Airport Drive, Room 126

Fort Stockton, TX 79735

☎ (432) 336-2910

Capiitol Staff

Office	Office Holder	Phone / Fax
Chief of Staff	Cassandra Urrutia (/online/person/?id=66847&staff=10857)	(512) 463-0129
Communications Director	Taylor Sanchez (/online/person/?id=71288&staff=10858)	(512) 463-0129
Digital Media Strategist	Arista Garcia (/online/person/?id=71289&staff=10859)	(512) 463-0129
Legislative Aide	Carlo Moran (/online/person/?id=72467&staff=11233)	(512) 463-0129

El Paso District Office

416 N. Stanton, Ste. 700

El Paso, TX 79901

☎ (915) 577-0029

📠 (915) 577-0030

Office	Office Holder	Phone / Fax
Executive Assistant & Scheduler	Mayela Granados (/online/person/?id=69749&staff=10238)	(915) 577-0029
Community Liaison	Alejandra Villarreal (/online/person/?id=69750&staff=10239)	(915) 577-0029
Senior Policy Analyst	Alex Rodriguez (/online/person/?id=71292&staff=10862)	(915) 577-0029
Constituent Caseworker	Arely Villalobos (/online/person/?id=71293&staff=10863)	(915) 577-0029
Legislative Aide	Bianca Perez (/online/person/?id=72468&staff=11476)	(915) 577-0029

Fort Stockton rural Office

1618 Airport Drive


Room 126

Fort Stockton, TX 79735

☎ (432) 336-2910

Other Offices Held

TX Senator (?id=50237&office=20320) (Sunset Advisory Commission (/online/abc/detail.php?id=231))

 Recent Searches
McCamey (City) (/online/search/?tosearch=McCamey+%28City%29&searchcat=1)
Hemphill (City) (/online/search/?tosearch=Hemphill+%28City%29&searchcat=1)
College Station (/online/search/?tosearch=college+station&searchcat=1)

 My Favorites (/online/favorites/)
Cities (/online/city/?page=35)
Cities (/online/city/)
Counties (/online/county/?aid=m)

⚡ Helpful Links

[Find My Incumbent \(http://www.fyi.legis.state.tx.us/\)](http://www.fyi.legis.state.tx.us/)

[Capitol Maps \(https://tspb.texas.gov/plan/maps/maps.html\)](https://tspb.texas.gov/plan/maps/maps.html)

[Bill Filings \(http://www.legis.state.tx.us/\)](http://www.legis.state.tx.us/)

[Bill Search \(http://www.legis.state.tx.us/Search/BillSearch.aspx\)](http://www.legis.state.tx.us/Search/BillSearch.aspx)

[Texas at Your Fingertips \(https://texas.gov/\)](https://texas.gov/)

[State Symbols \(https://www.thestoryoftexas.com/education/texas-symbols\)](https://www.thestoryoftexas.com/education/texas-symbols)

[Governor Appointment \(https://gov.texas.gov/news/category/appointment\)](https://gov.texas.gov/news/category/appointment)

[Addressing Procedures \(https://lrl.texas.gov/genInfo/ContactLeg.cfm\)](https://lrl.texas.gov/genInfo/ContactLeg.cfm)

TEXAS STATE DIRECTORY (1)

Since 1935 the Texas State Directory has been a trusted resource and has been referred to as the bible for anyone working in or wanting to learn about state, city and county government.

Recent Searches

[MCCAMEY \(CITY\) \(/ONLINE/SEARCH/?TOSEARCH=MCCAMEY+%28CITY%29&SEARCHCAT=1\)](#)

[HEMPHILL \(CITY\) \(/ONLINE/SEARCH/?TOSEARCH=HEMPHILL+%28CITY%29&SEARCHCAT=1\)](#)

[COLLEGE STATION \(/ONLINE/SEARCH/?TOSEARCH=COLLEGE+STATION&SEARCHCAT=1\)](#)

[FARMERSVILLE \(/ONLINE/SEARCH/?TOSEARCH=FARMERSVILLE&SEARCHCAT=1\)](#)

[RAY POWELL \(/ONLINE/SEARCH/?TOSEARCH=RAY+POWELL&SEARCHCAT=1\)](#)

Useful Links

[FIND MY INCUMBENT \(HTTP://WWW.FYI.LEGIS.STATE.TX.US/\)](http://www.fyi.legis.state.tx.us/)

>

[CAPITOL MAPS \(HTTPS://TSPB.TEXAS.GOV/PLAN/MAPS/MAPS.HTML\)](https://tspb.texas.gov/plan/maps/maps.html)

>

[BILL FILINGS \(HTTP://WWW.LEGIS.STATE.TX.US/\)](http://www.legis.state.tx.us/)

>

[BILL SEARCH \(HTTP://WWW.LEGIS.STATE.TX.US/SEARCH/BILLSEARCH.ASPX\)](http://www.legis.state.tx.us/search/billsearch.aspx) >

[TEXAS AT YOUR FINGERTIPS \(HTTPS://TEXAS.GOV/\)](https://texas.gov/) >

[STATE SYMBOLS \(HTTP://WWW.LEGIS.STATE.TX.US/RESOURCES/STATESYMBOLS.ASPX\)](http://www.legis.state.tx.us/resources/statesymbols.aspx) >


[GOVERNOR APPOINTMENT \(HTTPS://GOV.TEXAS.GOV/NEWS/CATEGORY/APPOINTMENT\)](https://gov.texas.gov/news/category/appointment) >

Contact Us

Texas State Directory Press



1800 Nueces St.

Austin, Texas 78701

 (512) 473-2447

 [Contact Us \(/contact/\)](/contact/)

2026 © All Rights Reserved. [Privacy Policy \(/privacy/\)](/privacy/) | [Terms of Service \(/terms/\)](/terms/)

 (<https://www.facebook.com/Texas-State-Directory-142890752404984/>)  (<https://twitter.com/TSDPress>)

13511B Montana Ave

Follow these links to contact your representatives:

U.S. Representatives (2)

Districts 16 and 23



Representative Eddie Morales

Texas House District 74



Senator César Blanco

Texas Senate District 29



Mr. Gustavo Reveles

State Board of Education District 1



Senator John Cornyn

U.S. Senate



Senator Ted Cruz

U.S. Senate



U.S. CONGRESSIONAL DISTRICTS FOR 2026 ELECTIONS

U.S. Congressional District 16

Brooke T. Paup, *Chairwoman*
Catarina R. Gonzales, *Commissioner*
Tonya R. Miller, *Commissioner*
Kelly Keel, *Executive Director*



TEXAS COMMISSION ON ENVIRONMENTAL QUALITY

Protecting Texas by Reducing and Preventing Pollution

April 28, 2026

THE HONORABLE CESAR BLANCO
TEXAS SENATE
PO BOX 12068
AUSTIN TX 78711-2068

Re: Accepted Federal Operating Permit Renewal Application
Project Number: 40140
Permit Number: O3670
El Paso Electric Company
Montana Power Station
El Paso, El Paso County
Regulated Entity Number: RN106392624
Customer Reference Number: CN600352819

Dear Senator Blanco:

This letter notifies you that the Texas Commission on Environmental Quality has received a federal operating permit (FOP) renewal application for a site located in your district. As part of this permitting process, the applicant is required to publish a formal newspaper public notice. The notice will inform the public of their right to make comments or request a public hearing. This link to an electronic map of the site or facility's general location is provided as a public courtesy and not part of the application or notice. For exact location, refer to application. <https://gisweb.tceq.texas.gov/LocationMapper/?marker=-106.211944,31.823888&level=13>.

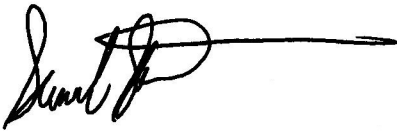
The FOP program regulates both new and existing major sources of emissions. The goal of the program is to improve air quality in Texas through increased compliance by codifying existing applicable regulatory requirements into the FOP. The FOP provides the applicant authorization to operate the equipment at the site. The FOP identifies and codifies air emission requirements (known as applicable requirements) that apply to the emission units at the site. The FOP does not authorize construction of emission units or emissions from those units. The New Source Review (NSR) permit is the mechanism for these authorizations.

The Honorable Cesar Blanco
Page 2
April 28, 2026

Re: Accepted Federal Operating Permit Renewal Application

This letter is being sent to you for information only and no action is required. If you need further information, please contact me at (512) 239-1250.

Sincerely,

A handwritten signature in black ink, appearing to read "Samuel Short", followed by a long horizontal line extending to the right.

Samuel Short, Deputy Director
Air Permits Division
Office of Air
Texas Commission on Environmental Quality

Brooke T. Paup, *Chairwoman*
Catarina R. Gonzales, *Commissioner*
Tonya R. Miller, *Commissioner*
Kelly Keel, *Executive Director*



TEXAS COMMISSION ON ENVIRONMENTAL QUALITY

Protecting Texas by Reducing and Preventing Pollution

April 28, 2026

THE HONORABLE EDDIE MORALES
TEXAS HOUSE OF REPRESENTATIVES
PO BOX 2910
AUSTIN TX 78768-2910

Re: Accepted Federal Operating Permit Renewal Application
Project Number: 40140
Permit Number: O3670
El Paso Electric Company
Montana Power Station
El Paso, El Paso County
Regulated Entity Number: RN106392624
Customer Reference Number: CN600352819

Dear Representative Morales:

This letter notifies you that the Texas Commission on Environmental Quality has received a federal operating permit (FOP) renewal application for a site located in your district. As part of this permitting process, the applicant is required to publish a formal newspaper public notice. The notice will inform the public of their right to make comments or request a public hearing. This link to an electronic map of the site or facility's general location is provided as a public courtesy and not part of the application or notice. For exact location, refer to application. <https://gisweb.tceq.texas.gov/LocationMapper/?marker=-106.211944,31.823888&level=13>.

The FOP program regulates both new and existing major sources of emissions. The goal of the program is to improve air quality in Texas through increased compliance by codifying existing applicable regulatory requirements into the FOP. The FOP provides the applicant authorization to operate the equipment at the site.

This letter is being sent to you for information only and no action is required. If you need further information, please contact me at (512) 239-1250.

Sincerely,

A handwritten signature in black ink, appearing to read "Samuel Short", with a long horizontal line extending to the right.

Samuel Short, Deputy Director
Air Permits Division
Office of Air
Texas Commission on Environmental Quality

From: [eNotice TCEQ](#)
To: cesar.blanco@senate.texas.gov; eddie.morales@house.texas.gov
Subject: TCEQ Notice - Permit Number O3670
Date: Tuesday, April 28, 2026 6:06:32 PM
Attachments: [TCEQ Notice - O3670 40140.pdf](#)

This email is being sent to electronically transmit an official document issued by the Office of Air of the Texas Commission on Environmental Quality.

This email is being sent to you because either (a) you filed a document with the Office of the Chief Clerk that made you part of the official mailing list for the above referenced matter, or (b) notice to you is legally required. As authorized by Texas Water Code 5.128, this electronic transmittal is replacing the previous practice of hard copy distribution. Amendments to Texas Government Code 552.137 prompted a change to the agency's privacy policy regarding confidentiality of certain email addresses. The revised privacy policy can be viewed at http://www.tceq.state.tx.us/help/policies/electronic_info_policy.html.

Questions regarding this email may be submitted either by replying directly to this email or by calling Mr. Rhyan Stone with the Air Permits Division at (512) 239-1293.

The attached document is provided in an Adobe Acrobat .pdf format. If you cannot display the attachment, you may need to visit the Adobe web site (<http://get.adobe.com/reader>) to download the free Adobe Acrobat Reader software.