

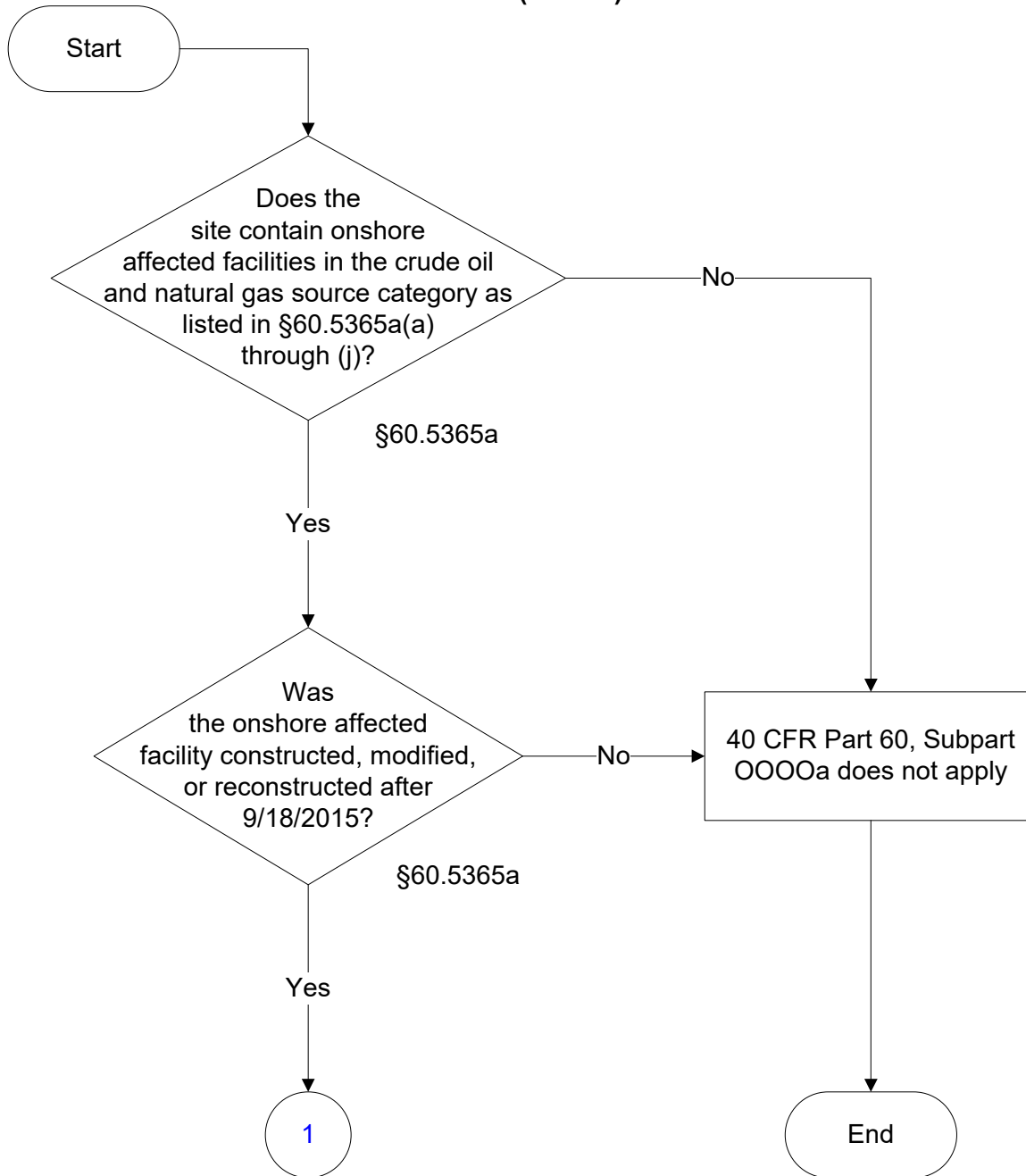

Below is a flowchart describing 40 CFR Part 60, Subpart OOOOa.
For the text of the statute/rule, please go to [40 CFR Part 60, Subpart OOOOa](#)

(1 of 82)



40 CFR Part 60, Subpart OOOOa

(2 of 82)

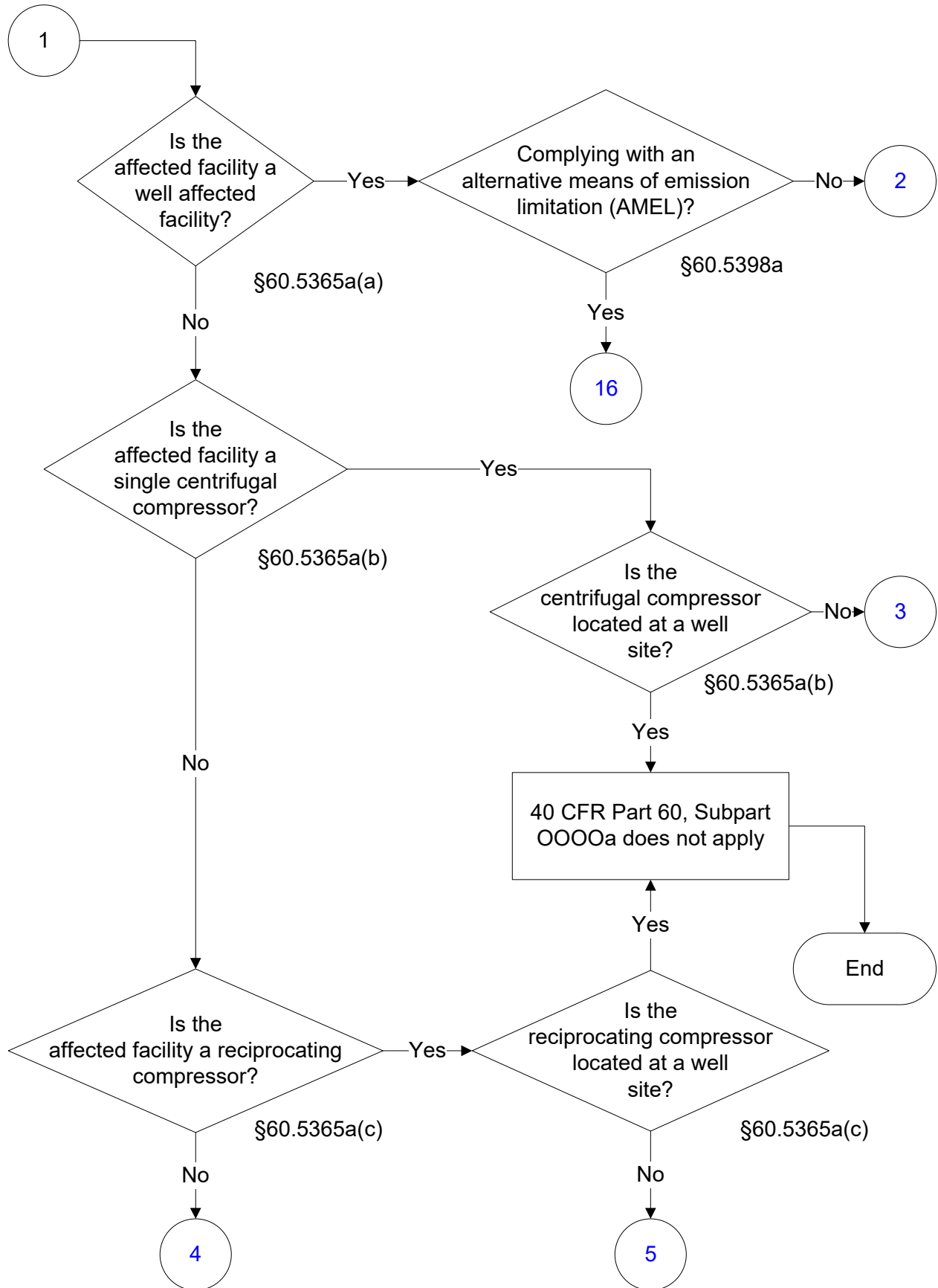

40 CFR Part 60, Subpart OOOOa
(3 of 82)

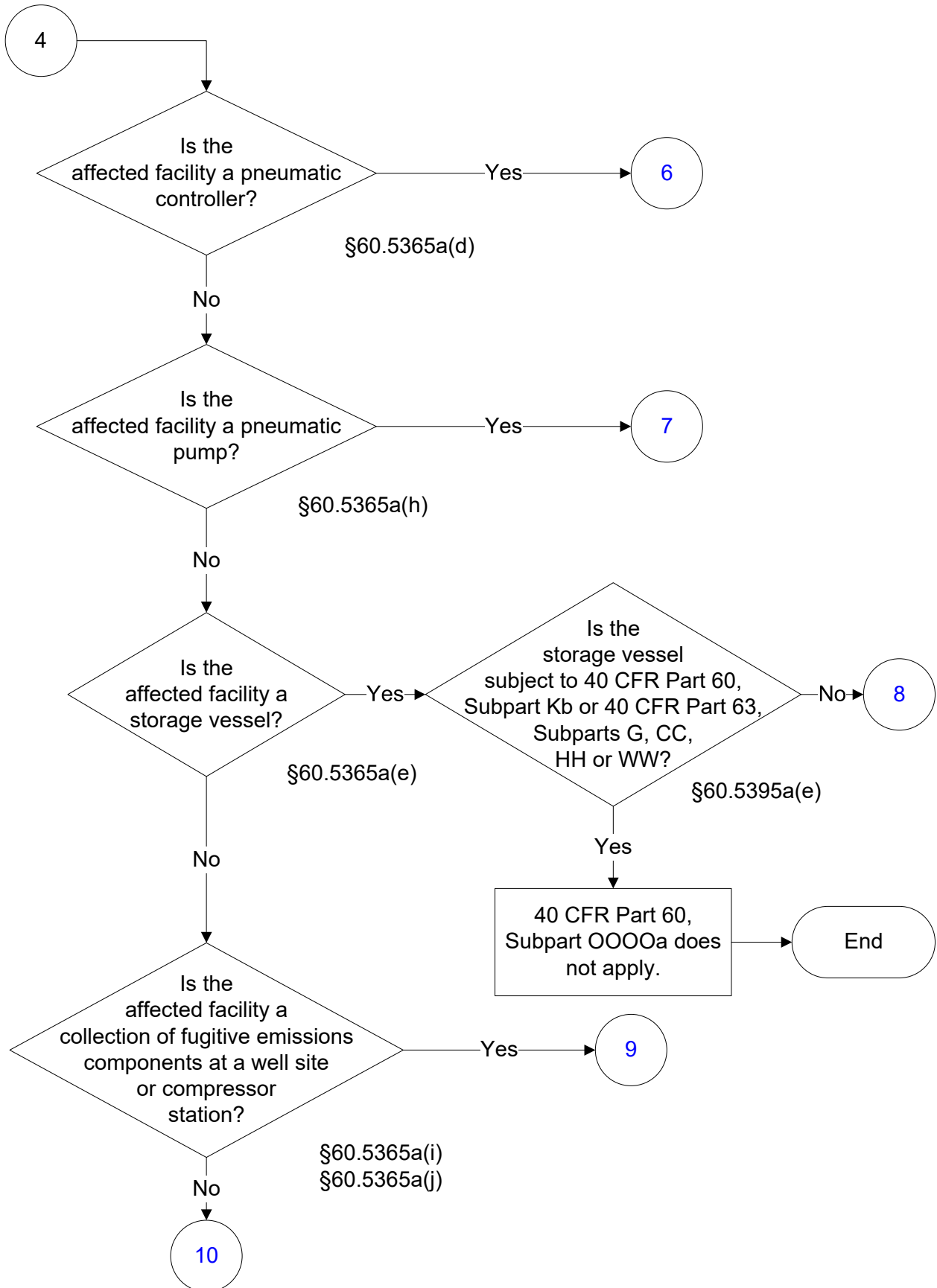

40 CFR Part 60, Subpart OOOOa
(4 of 82)

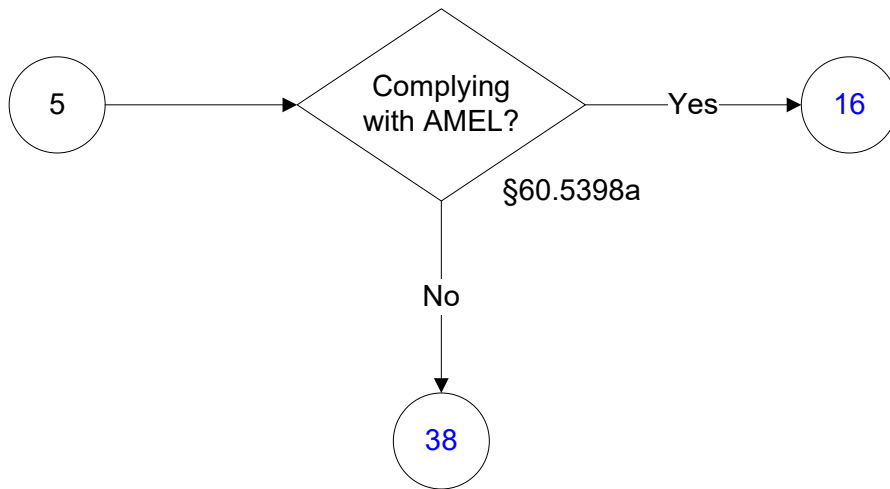
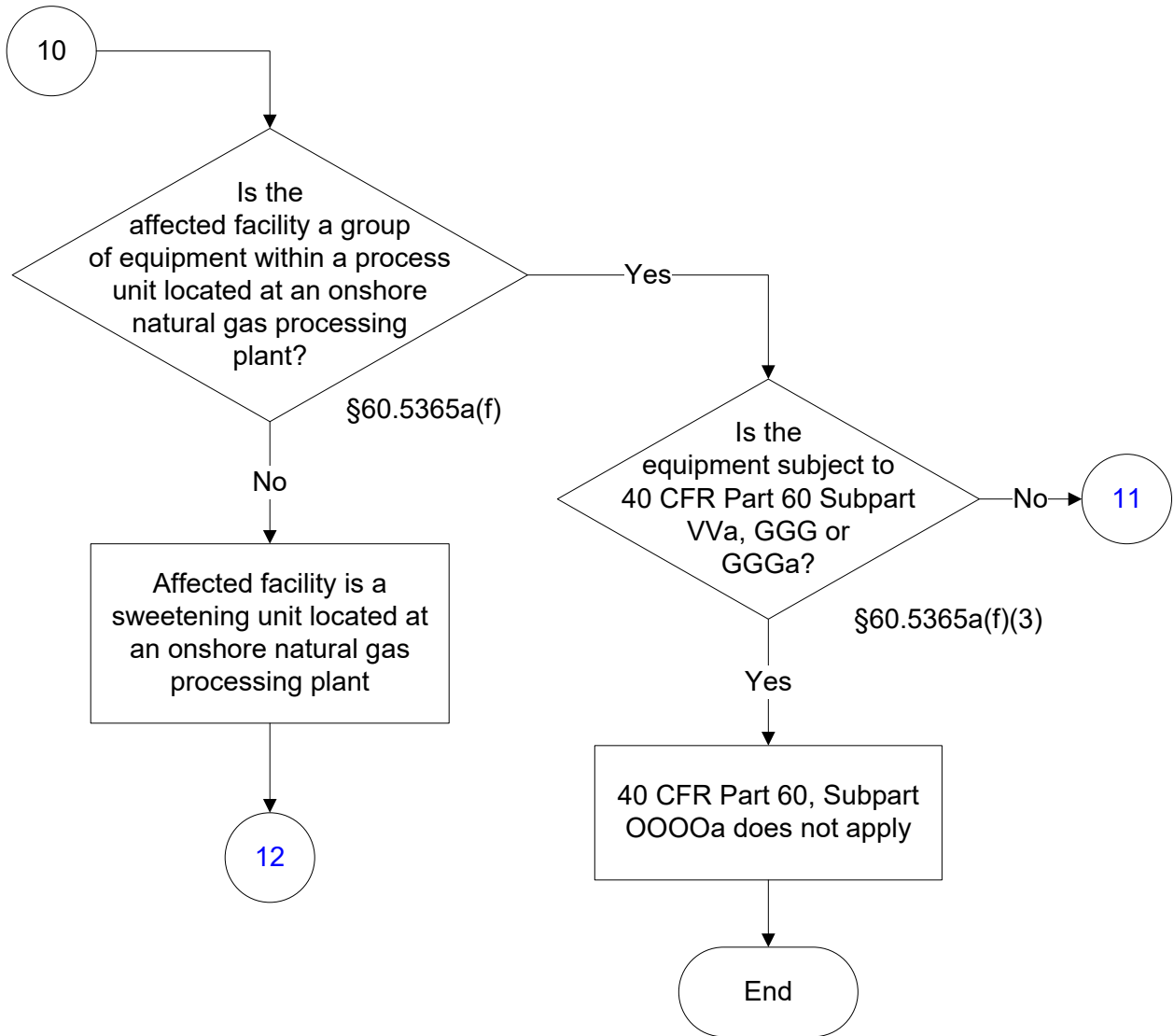

40 CFR Part 60, Subpart OOOOa

(5 of 82)

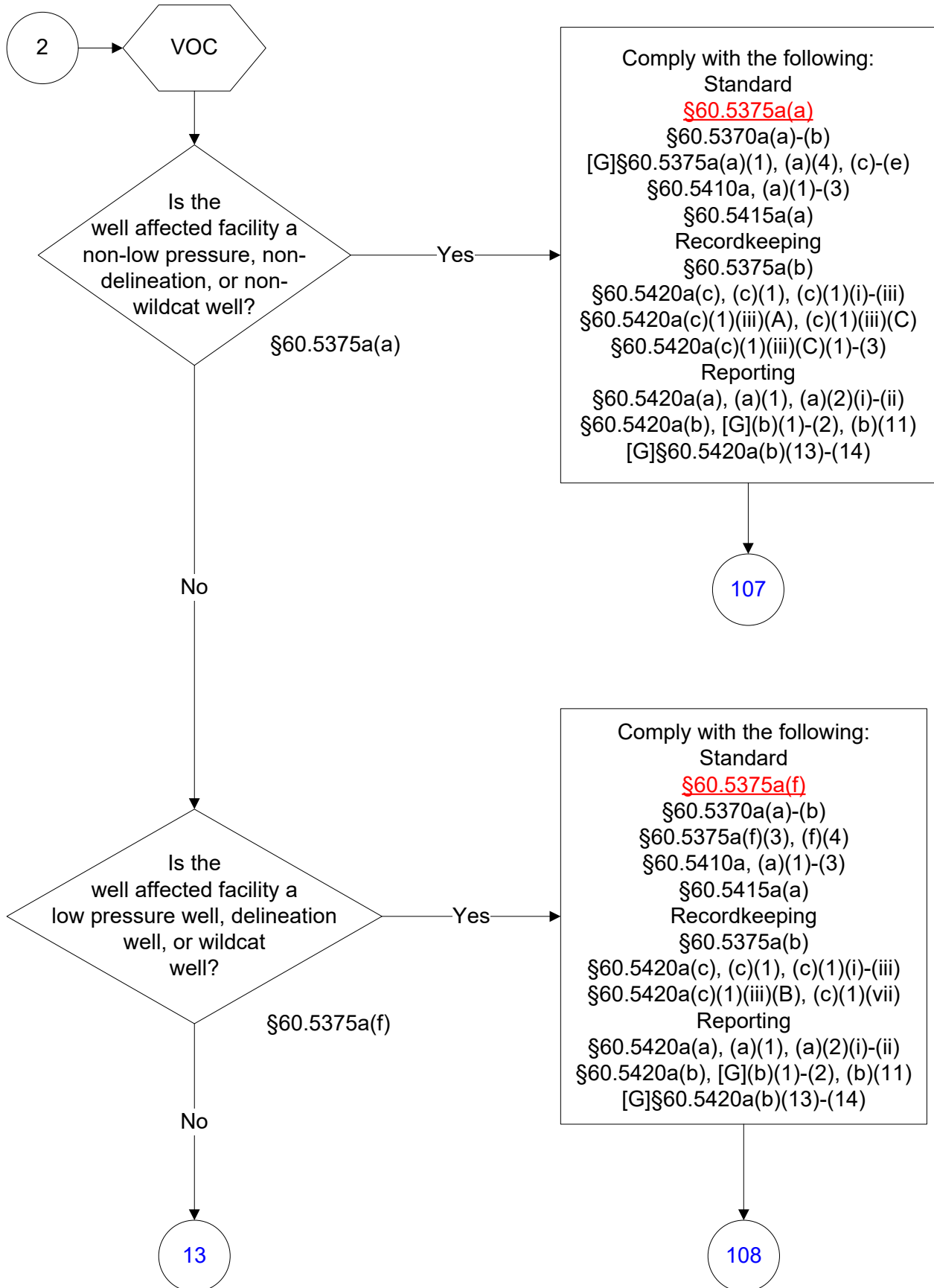

40 CFR Part 60, Subpart OOOOa
(6 of 82)

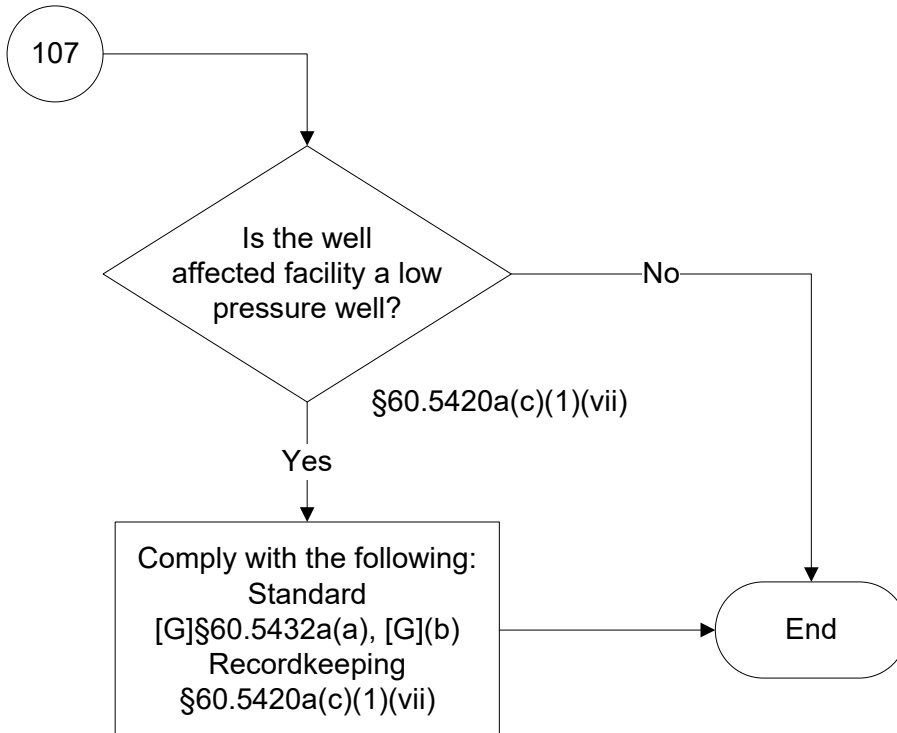
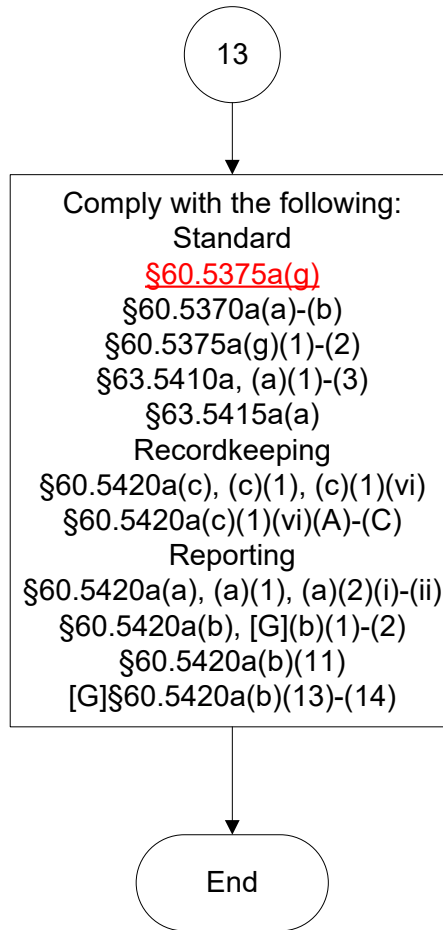

40 CFR Part 60, Subpart OOOOa

(7 of 82)

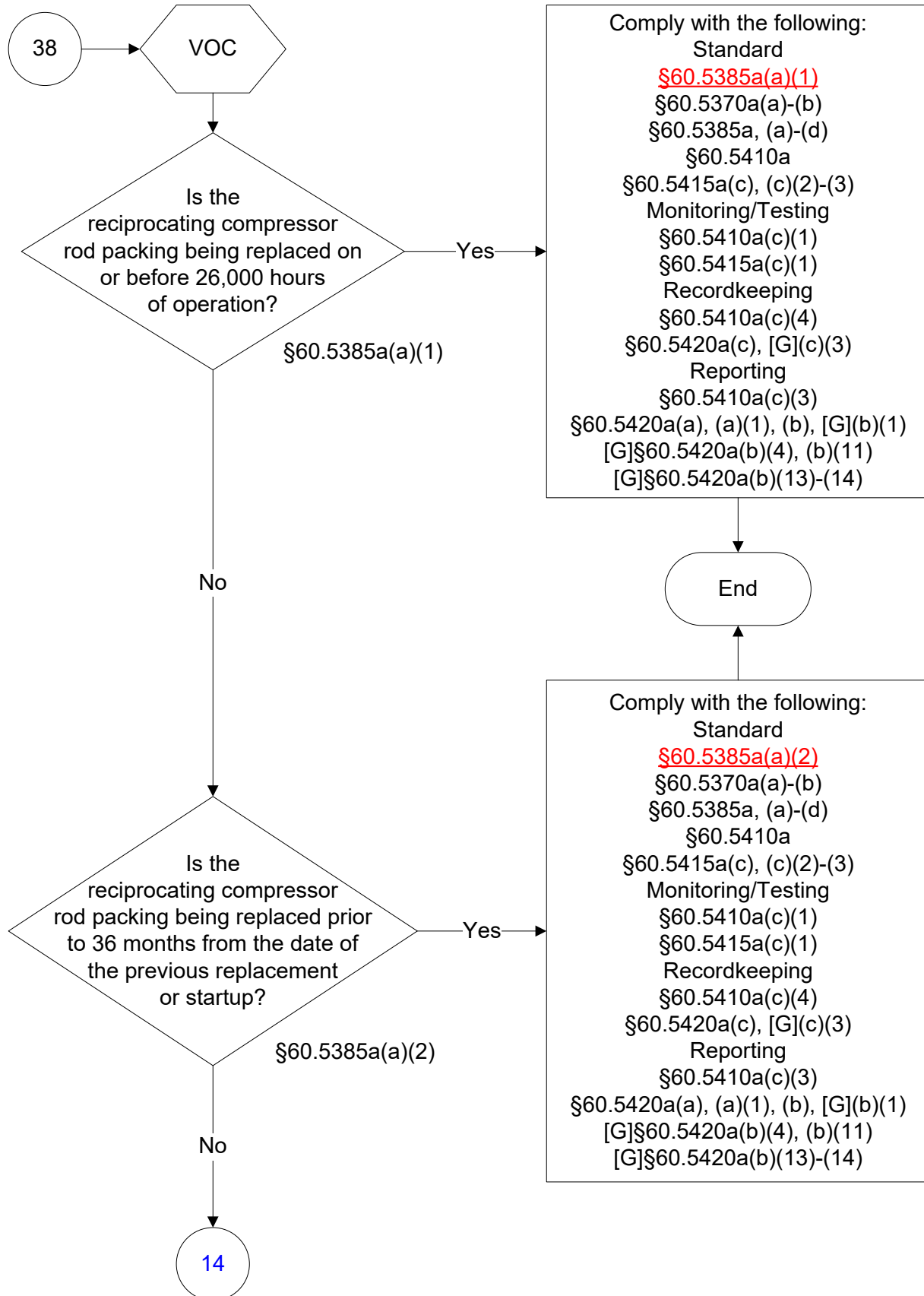

40 CFR Part 60, Subpart OOOOa
(8 of 82)

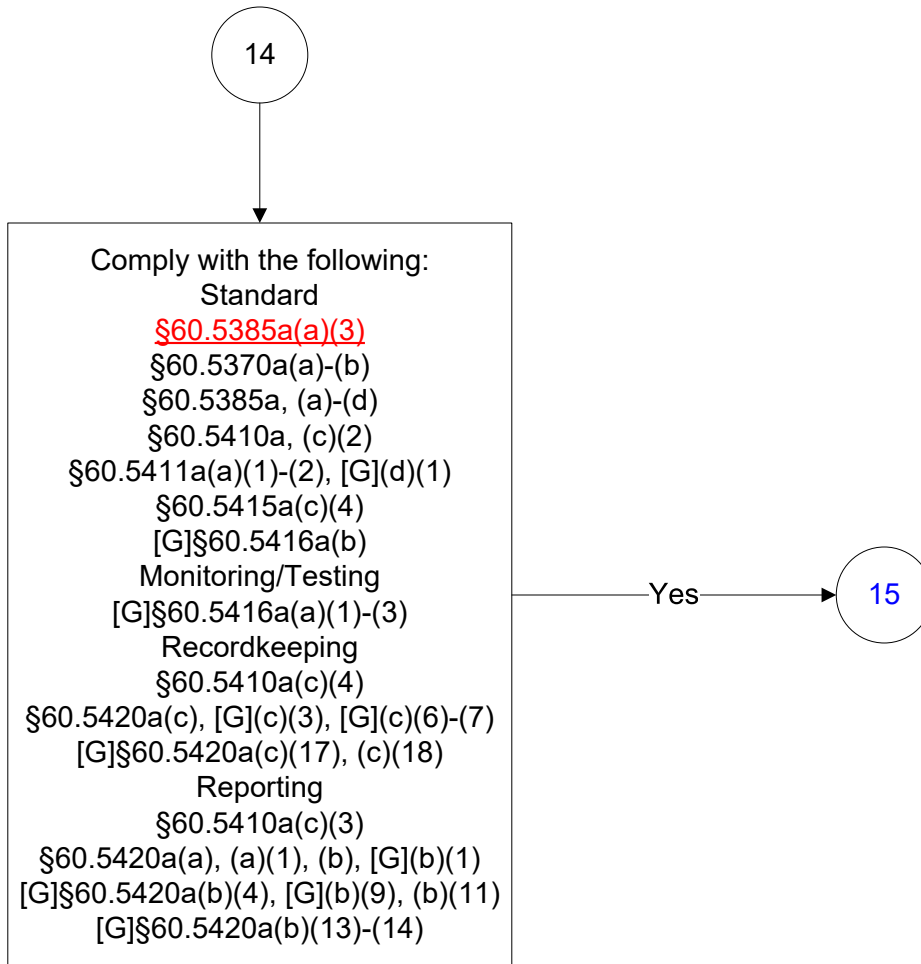

40 CFR Part 60, Subpart OOOOa
(9 of 82)

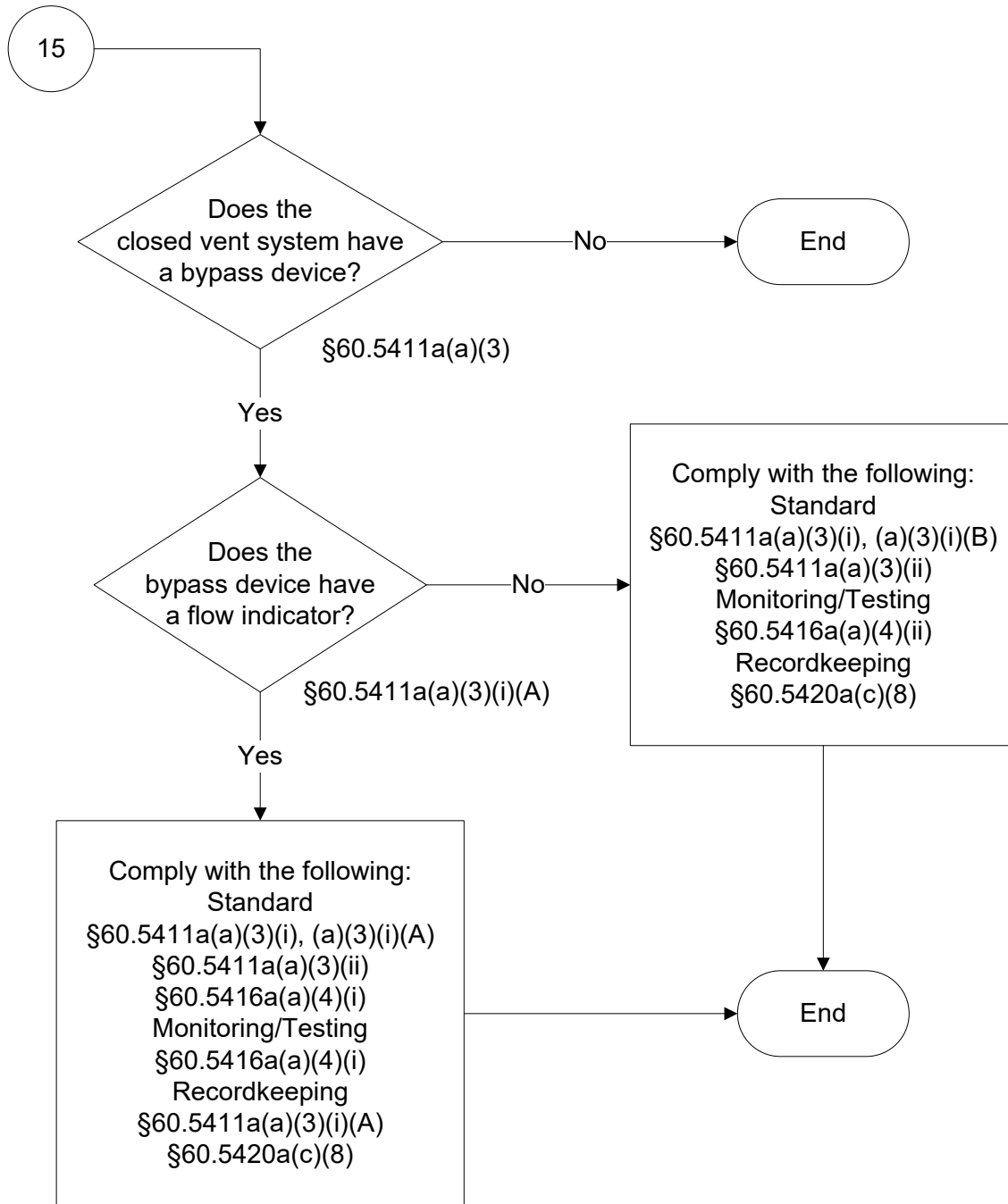

40 CFR Part 60, Subpart OOOOa

(10 of 82)

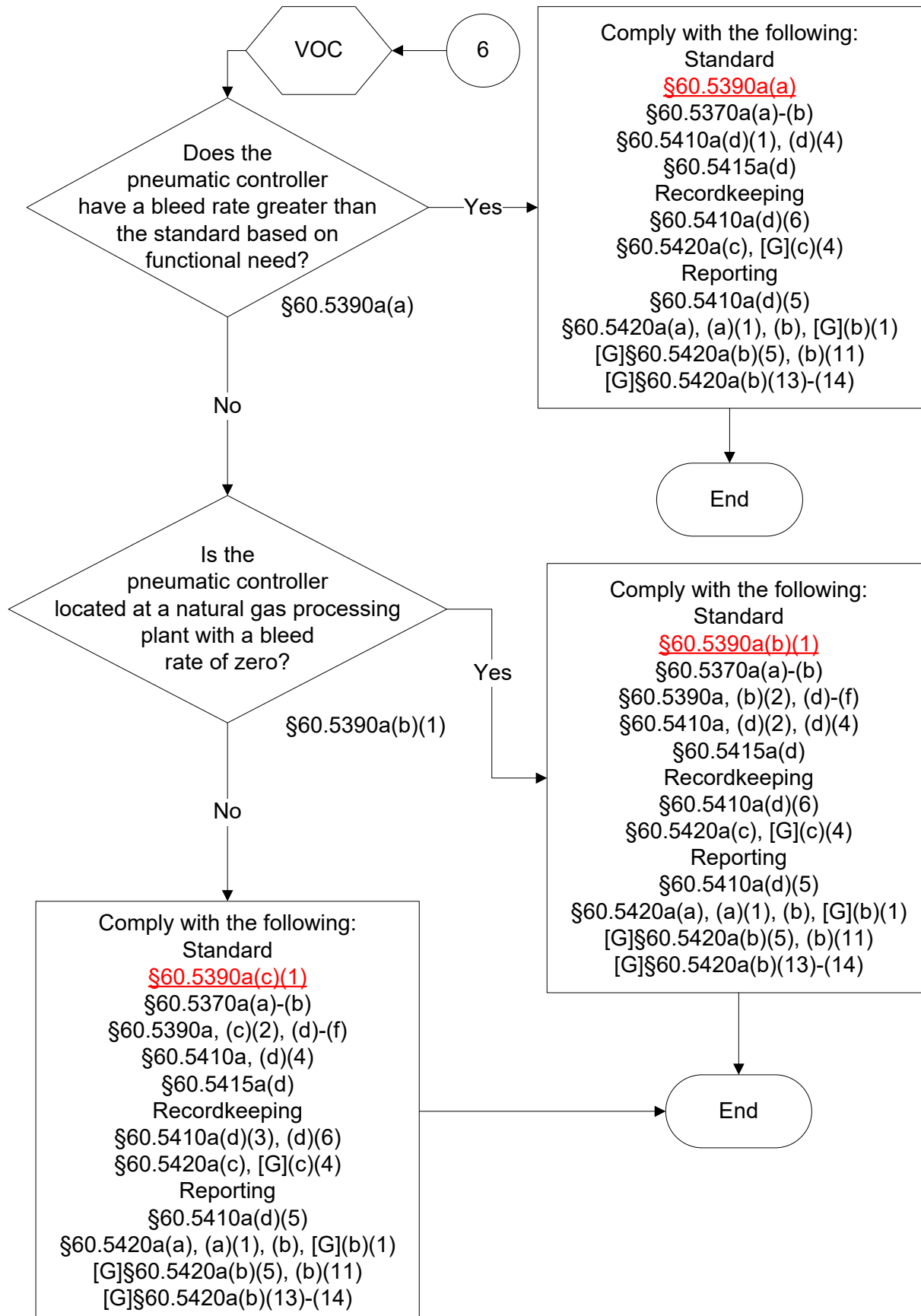

40 CFR Part 60, Subpart OOOOa
(11 of 82)

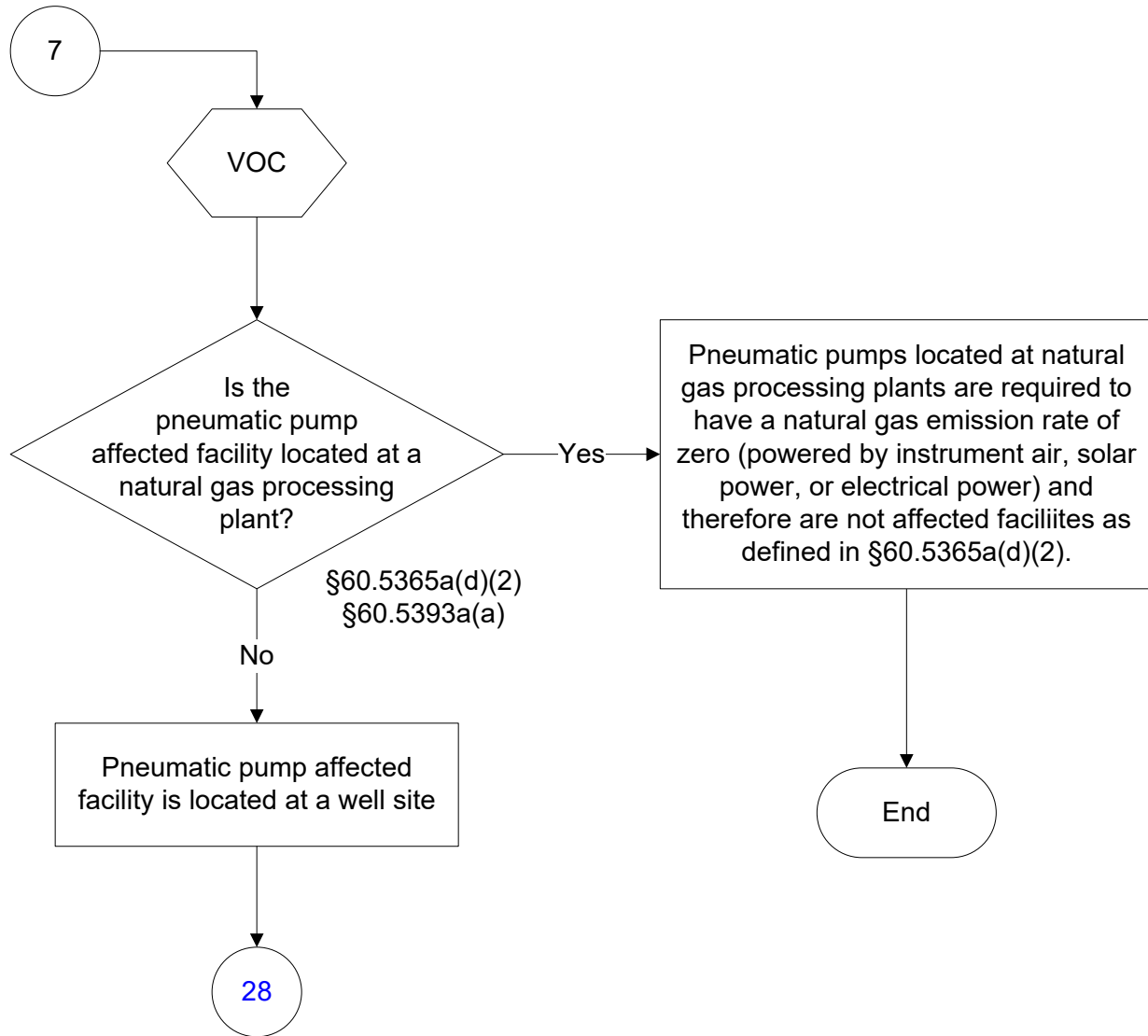

40 CFR Part 60, Subpart OOOOa

(12 of 82)

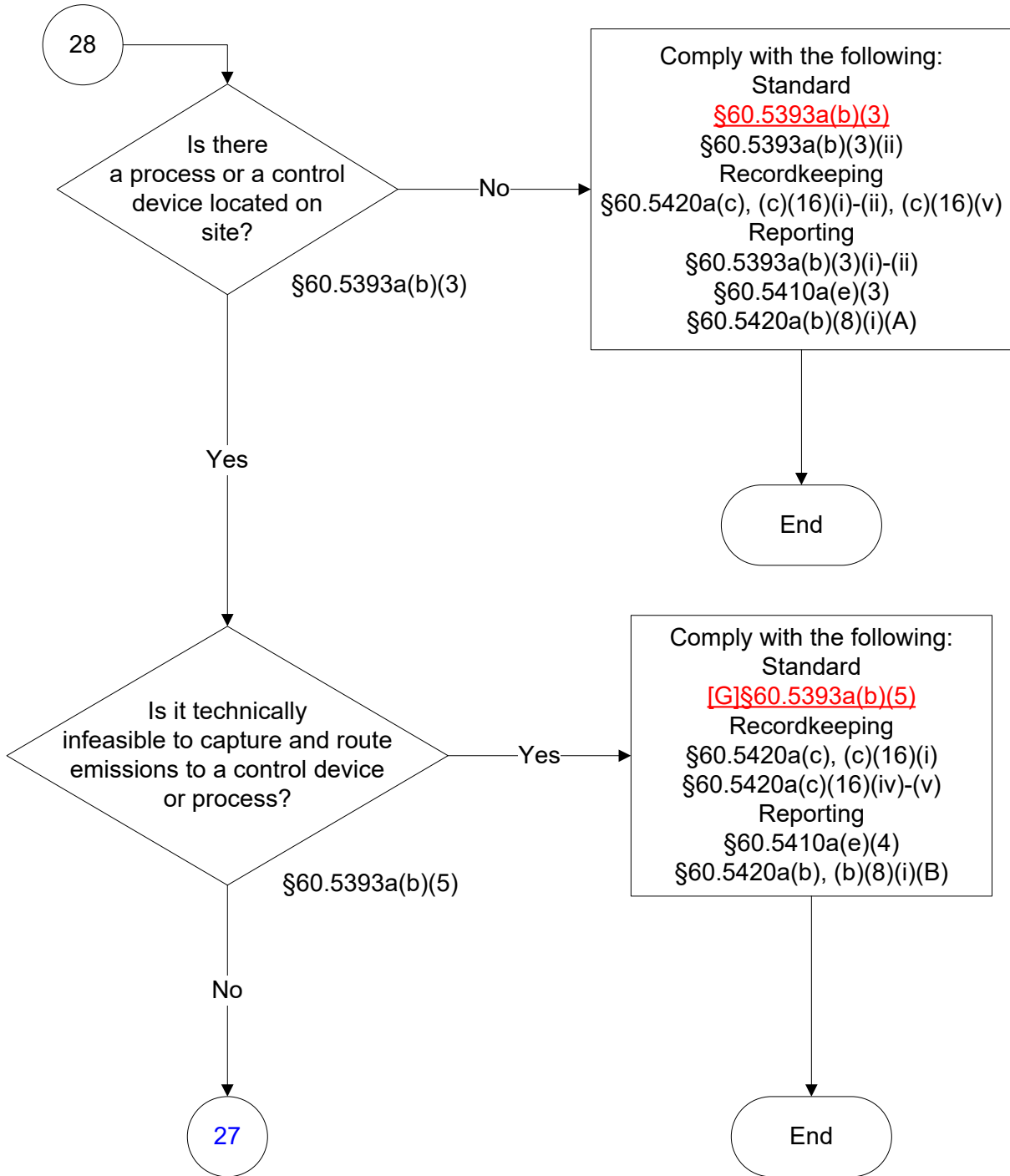

40 CFR Part 60, Subpart OOOOa
(13 of 82)

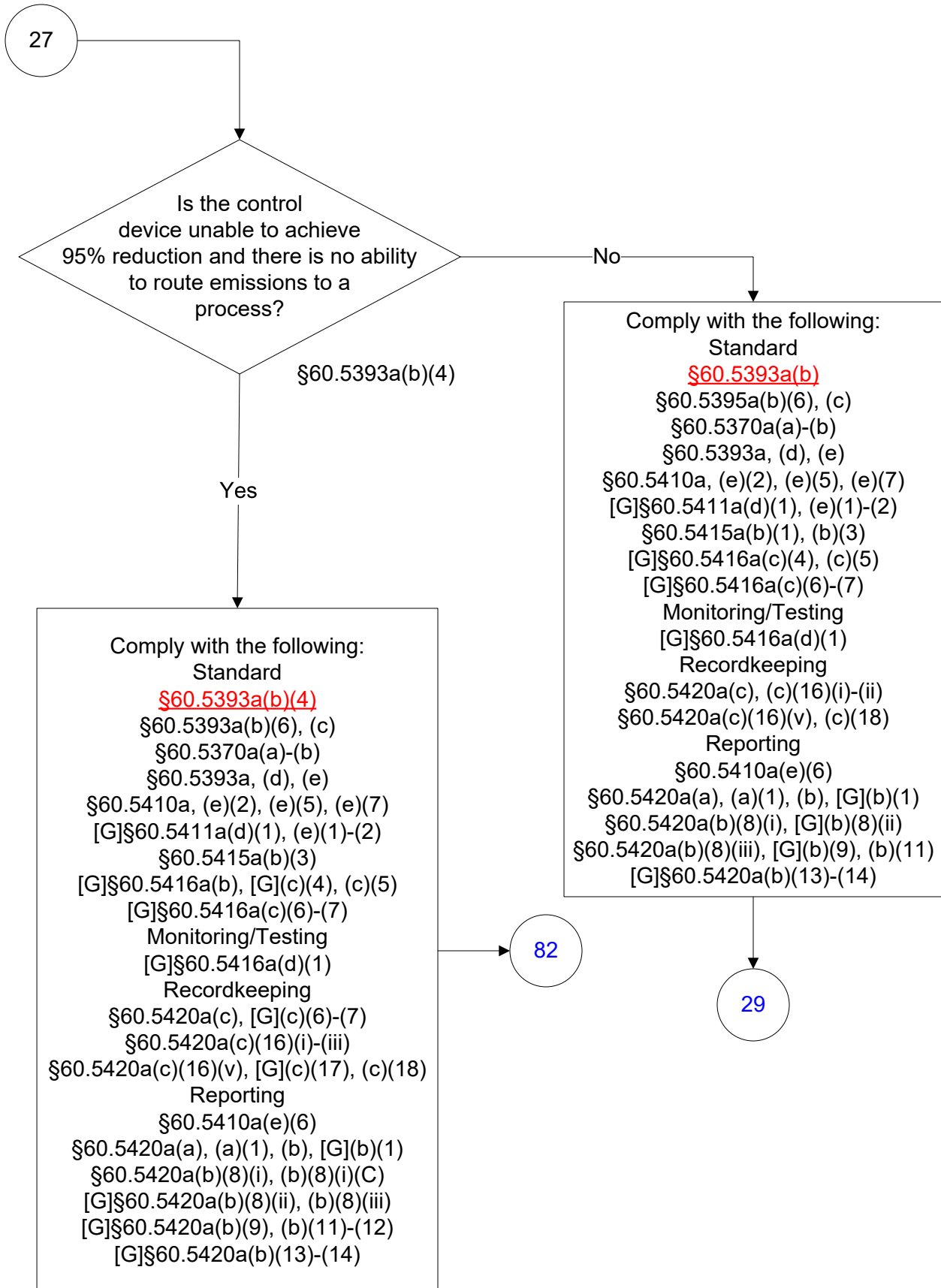

40 CFR Part 60, Subpart OOOOa
(14 of 82)

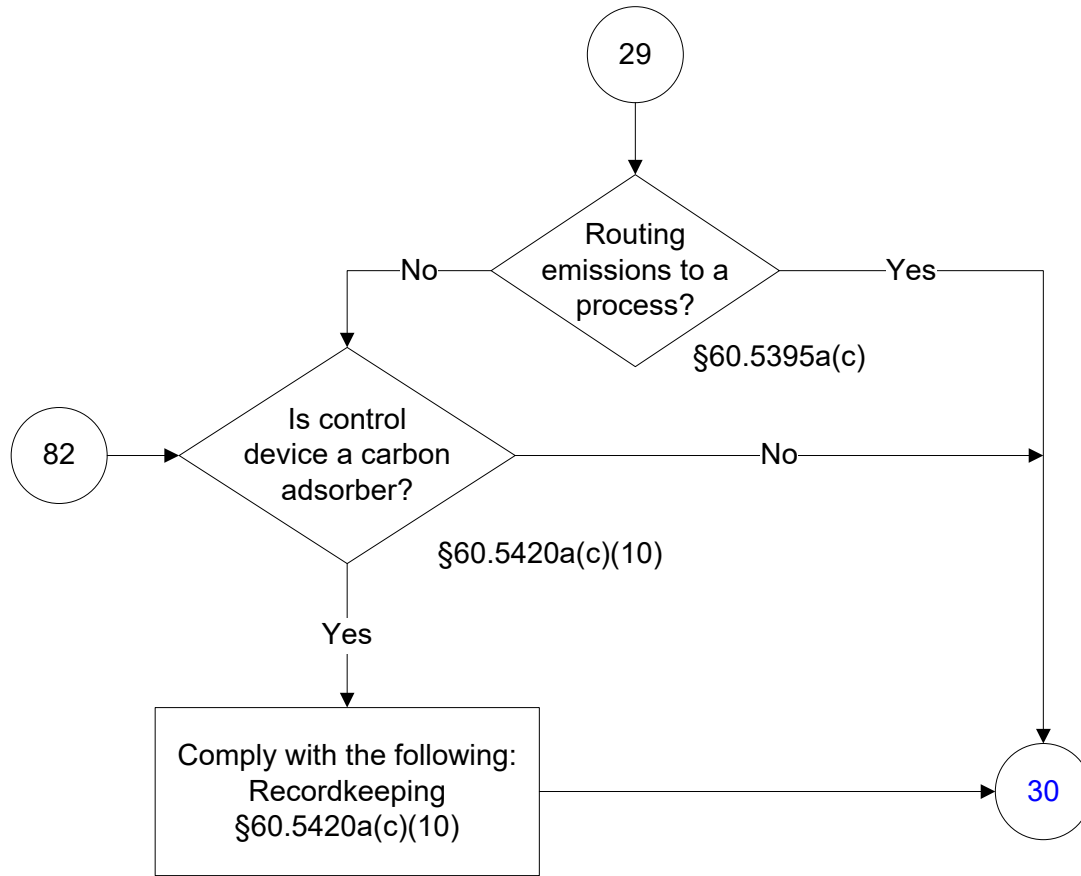

40 CFR Part 60, Subpart OOOOa
(15 of 82)

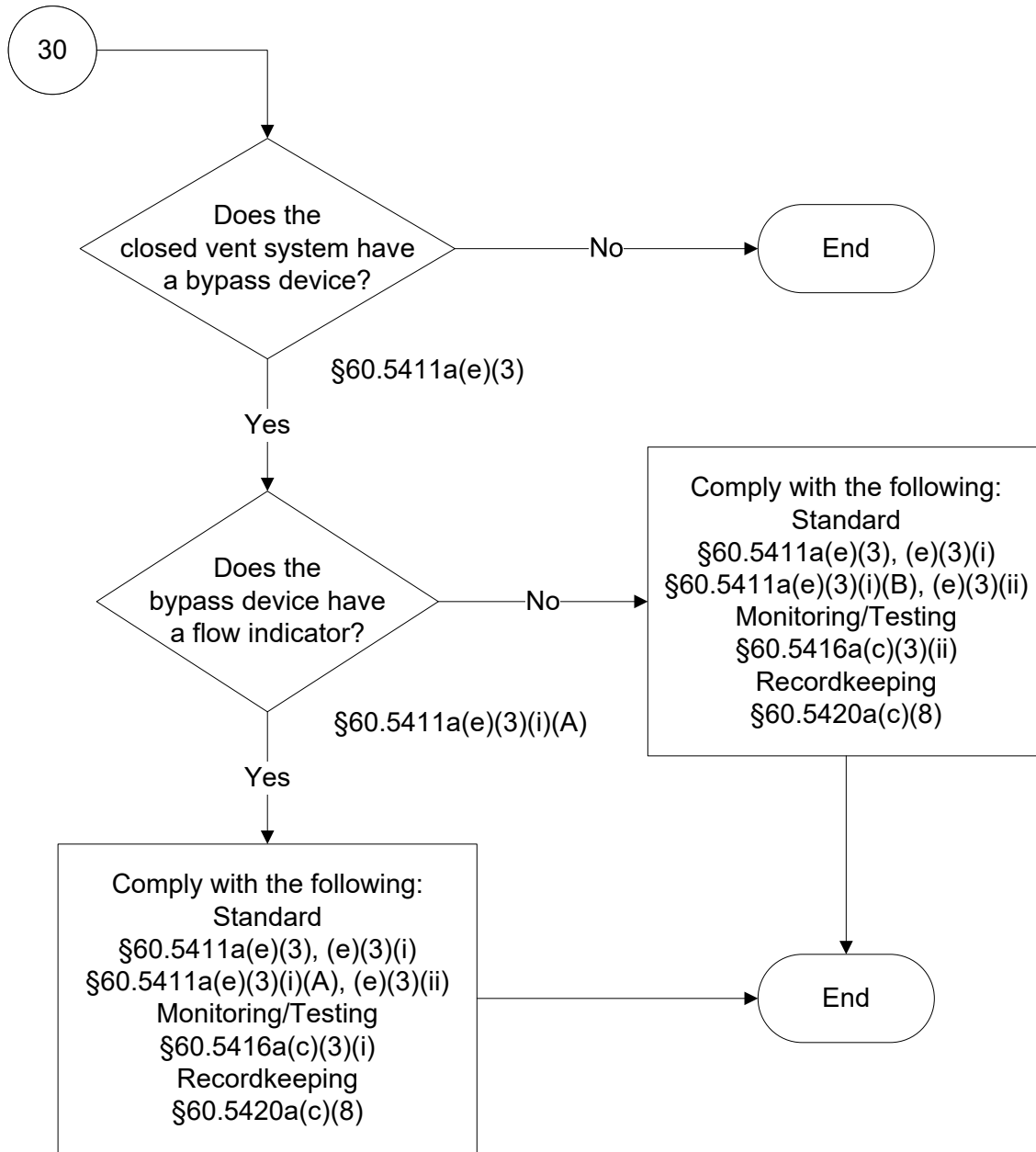

40 CFR Part 60, Subpart OOOOa

(16 of 82)

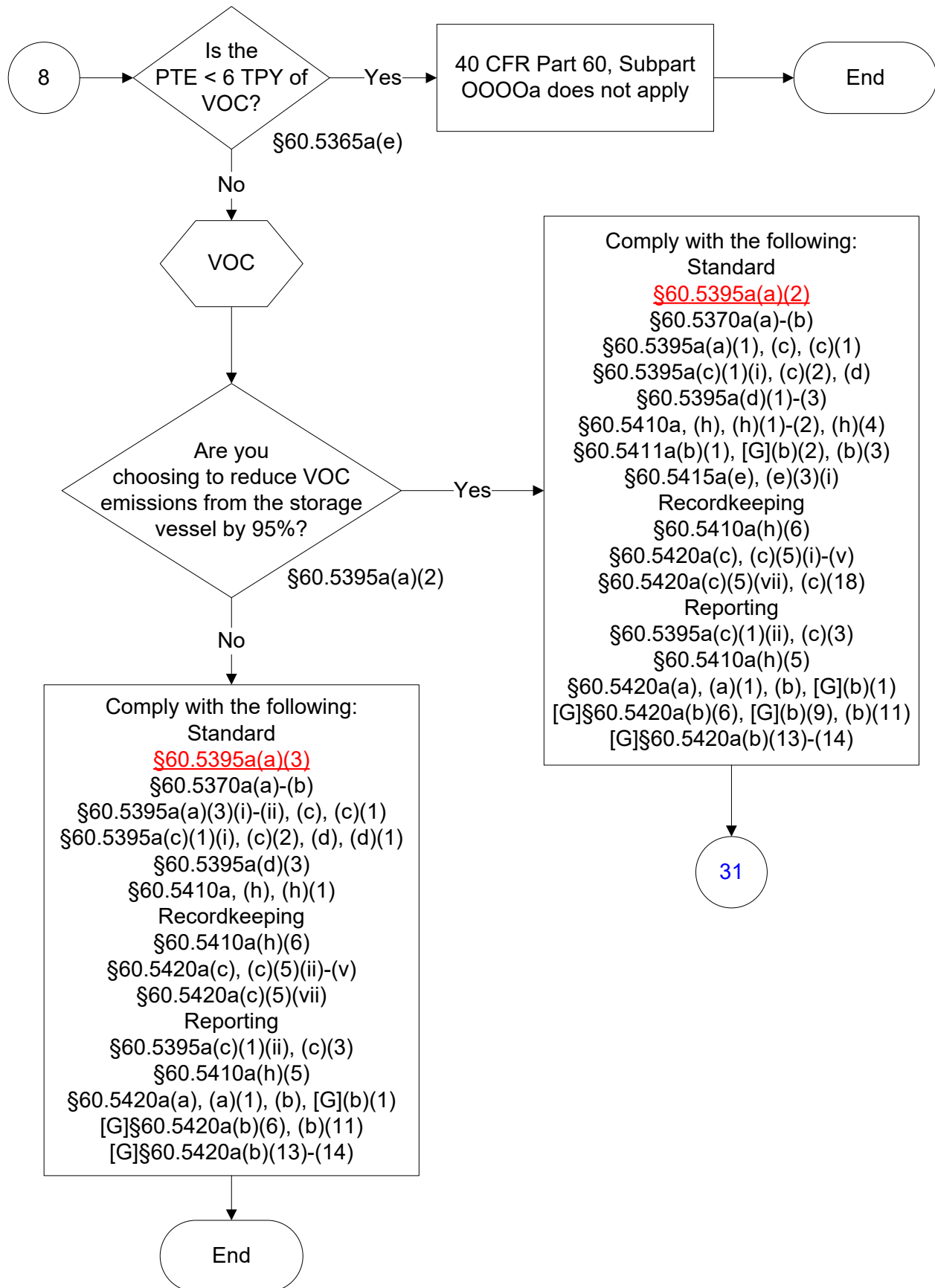

40 CFR Part 60, Subpart OOOOa
(17 of 82)

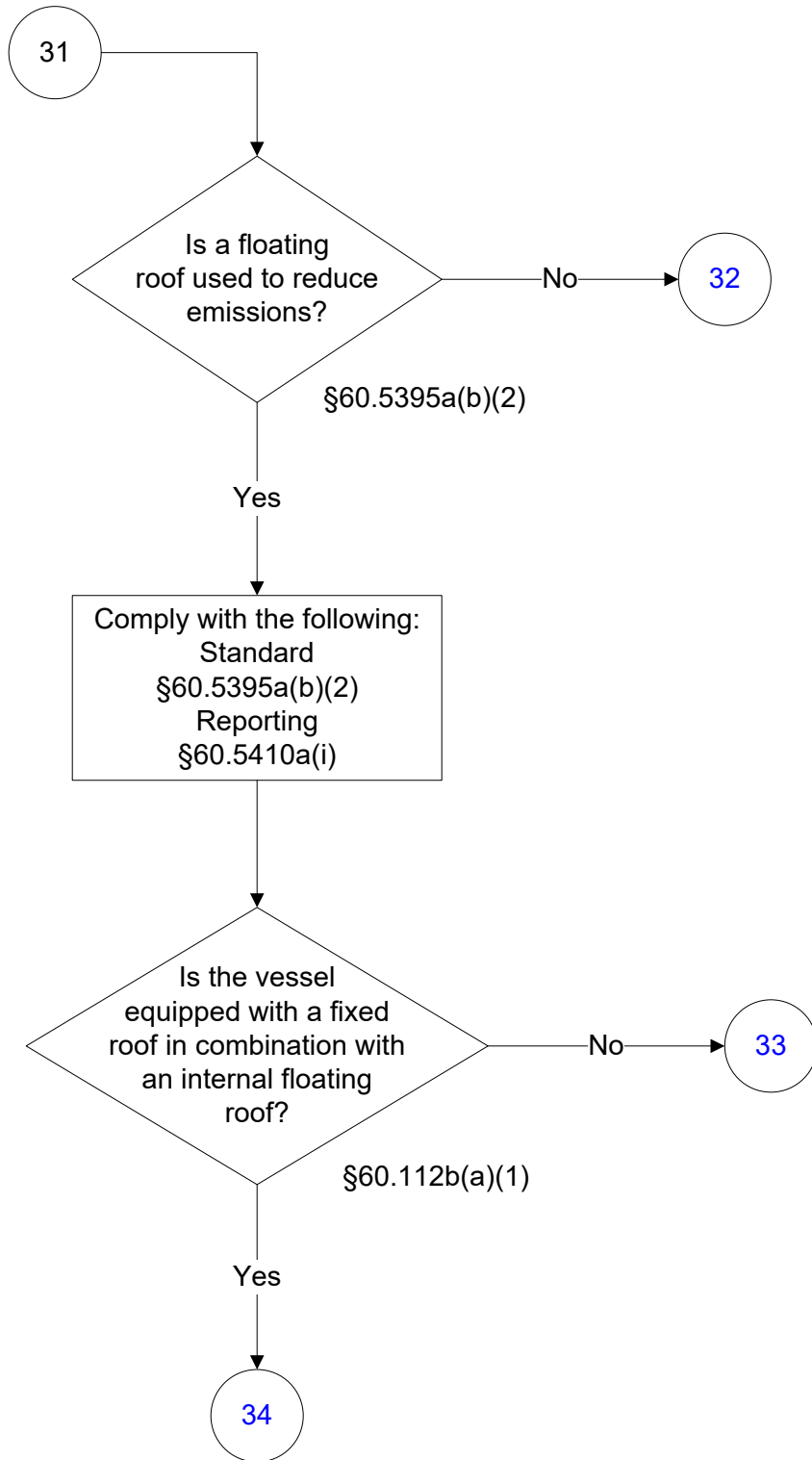

40 CFR Part 60, Subpart OOOOa
(18 of 82)

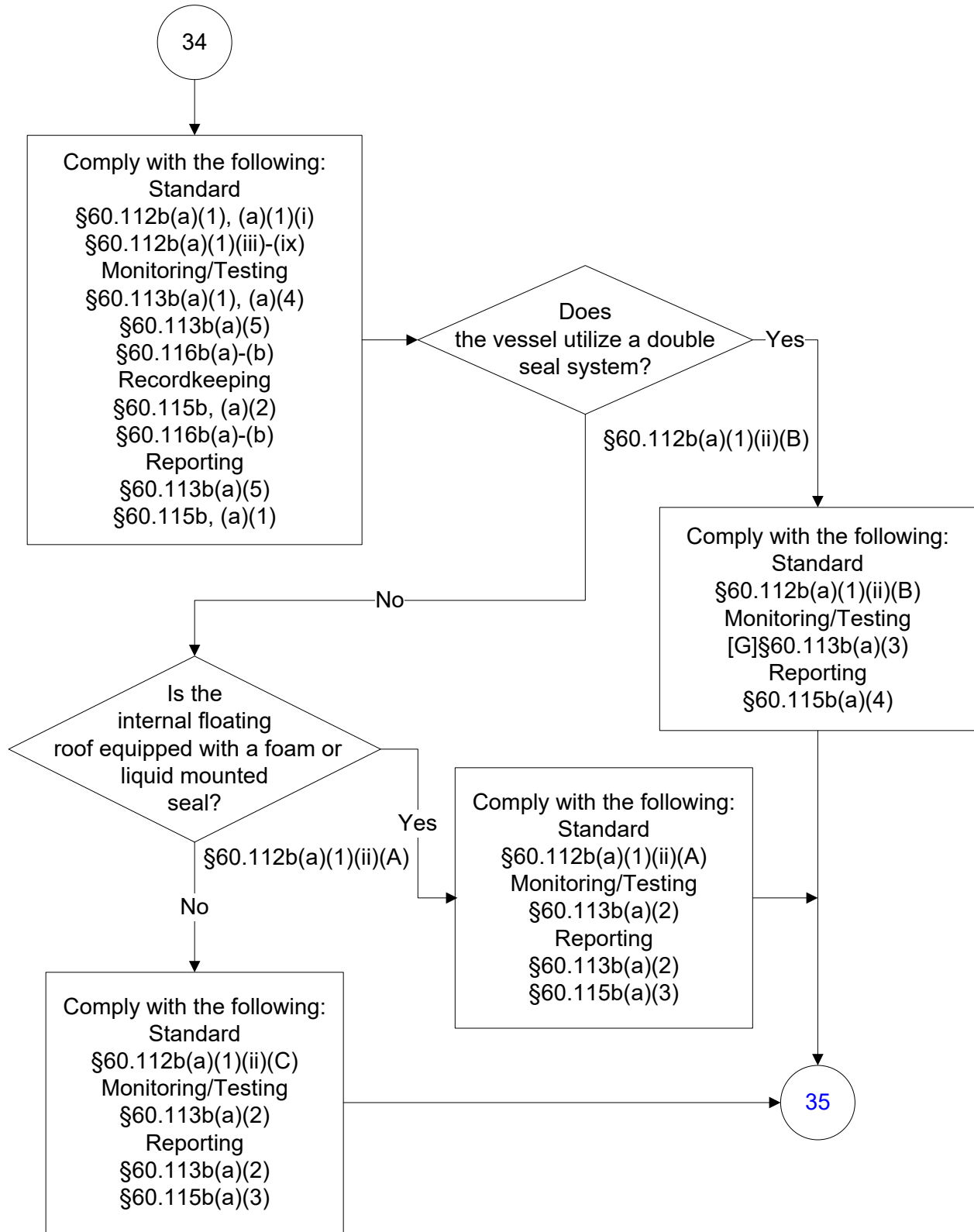

40 CFR Part 60, Subpart OOOOa

(19 of 82)

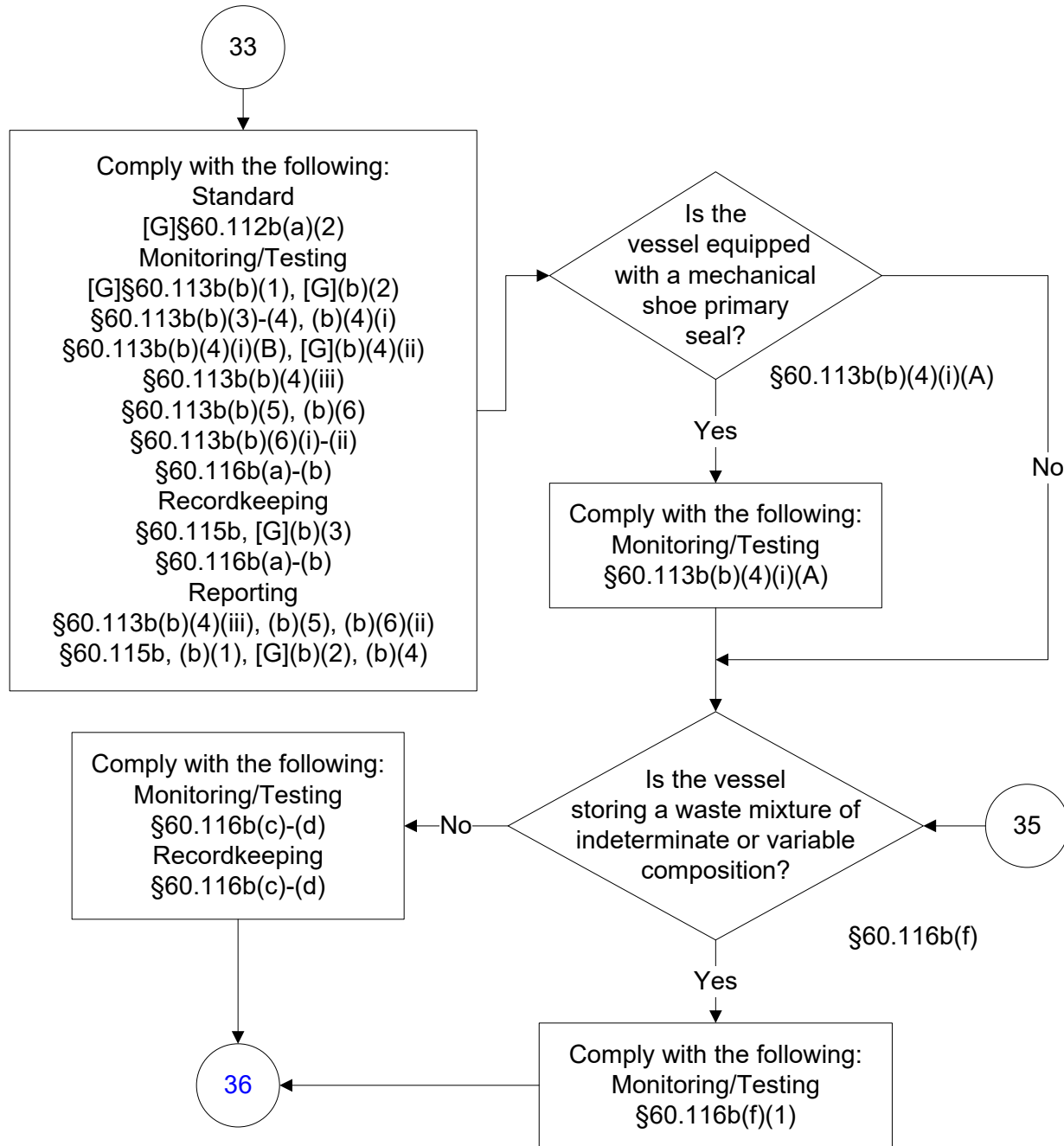

40 CFR Part 60, Subpart OOOOa
(20 of 82)

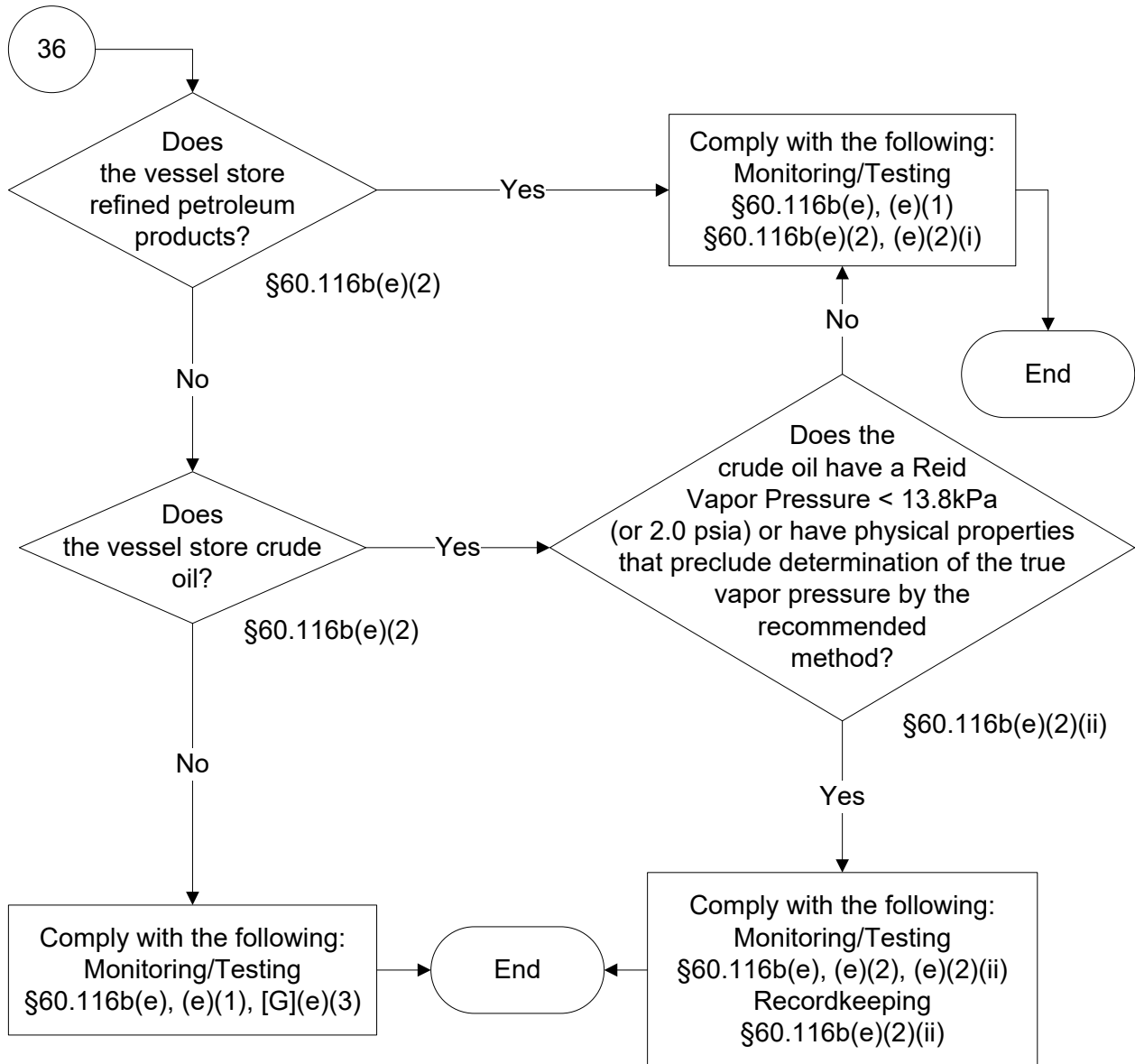

40 CFR Part 60, Subpart OOOOa

(21 of 82)

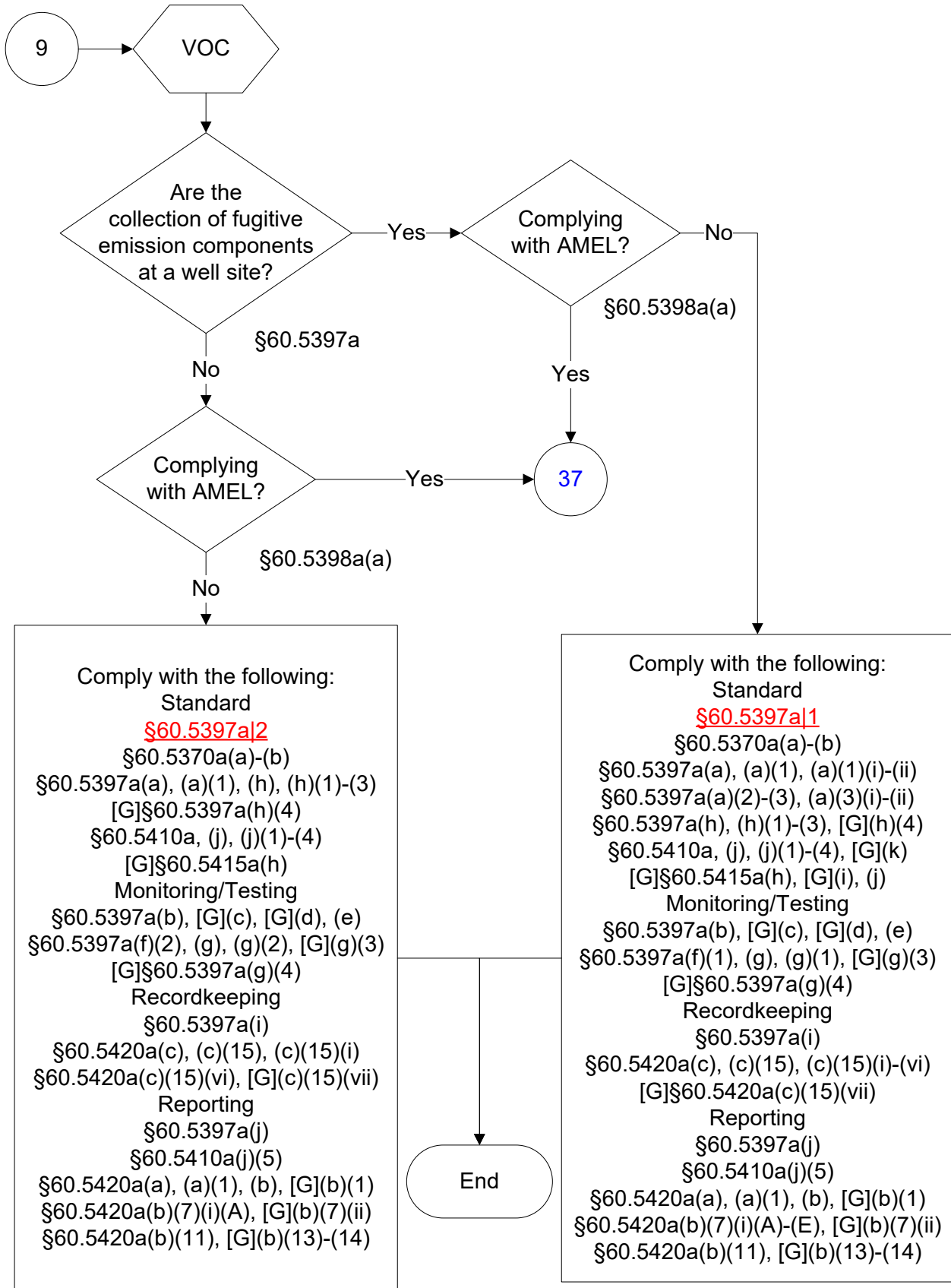

40 CFR Part 60, Subpart OOOOa

(22 of 82)

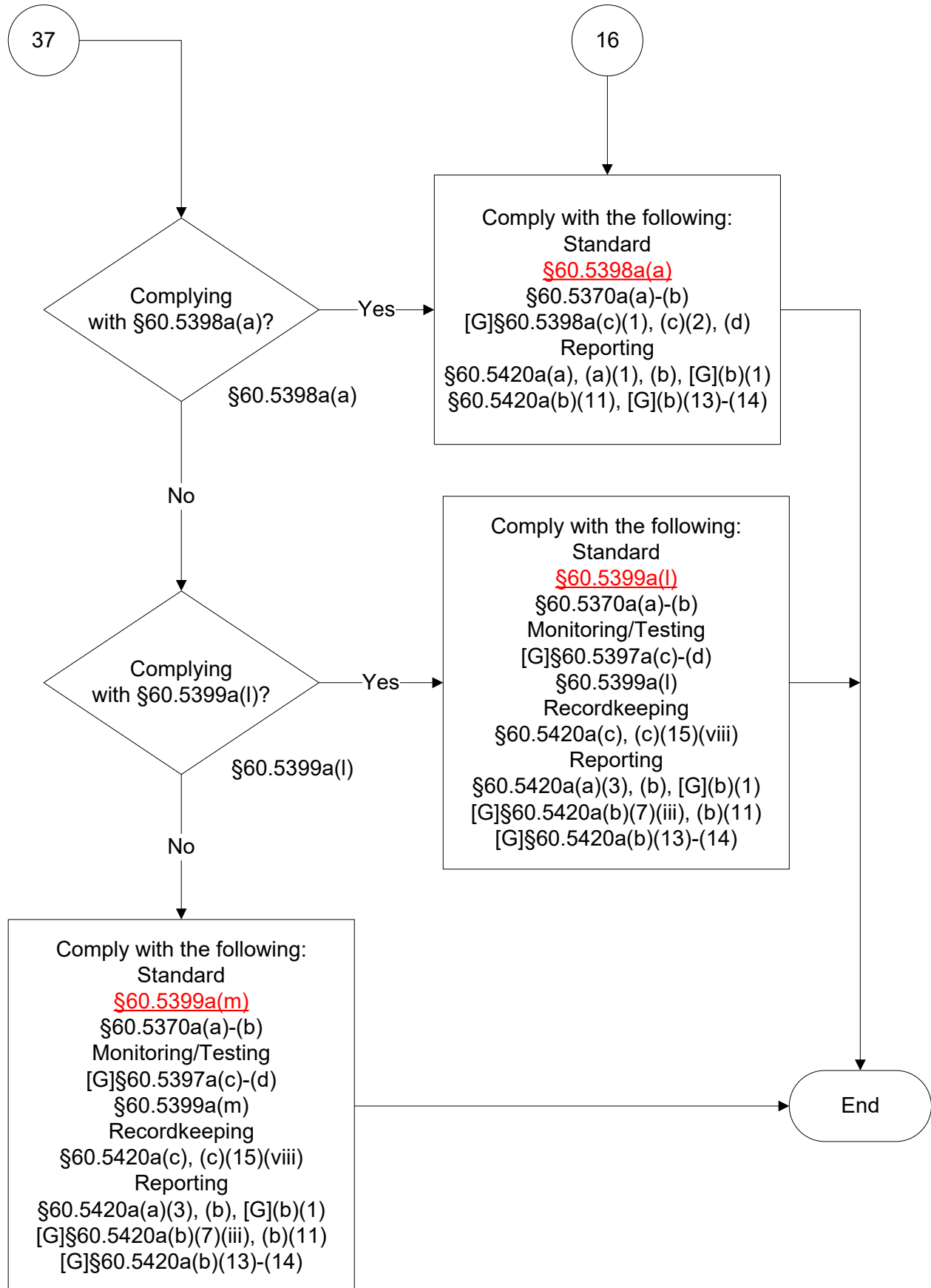

40 CFR Part 60, Subpart OOOOa

(23 of 82)

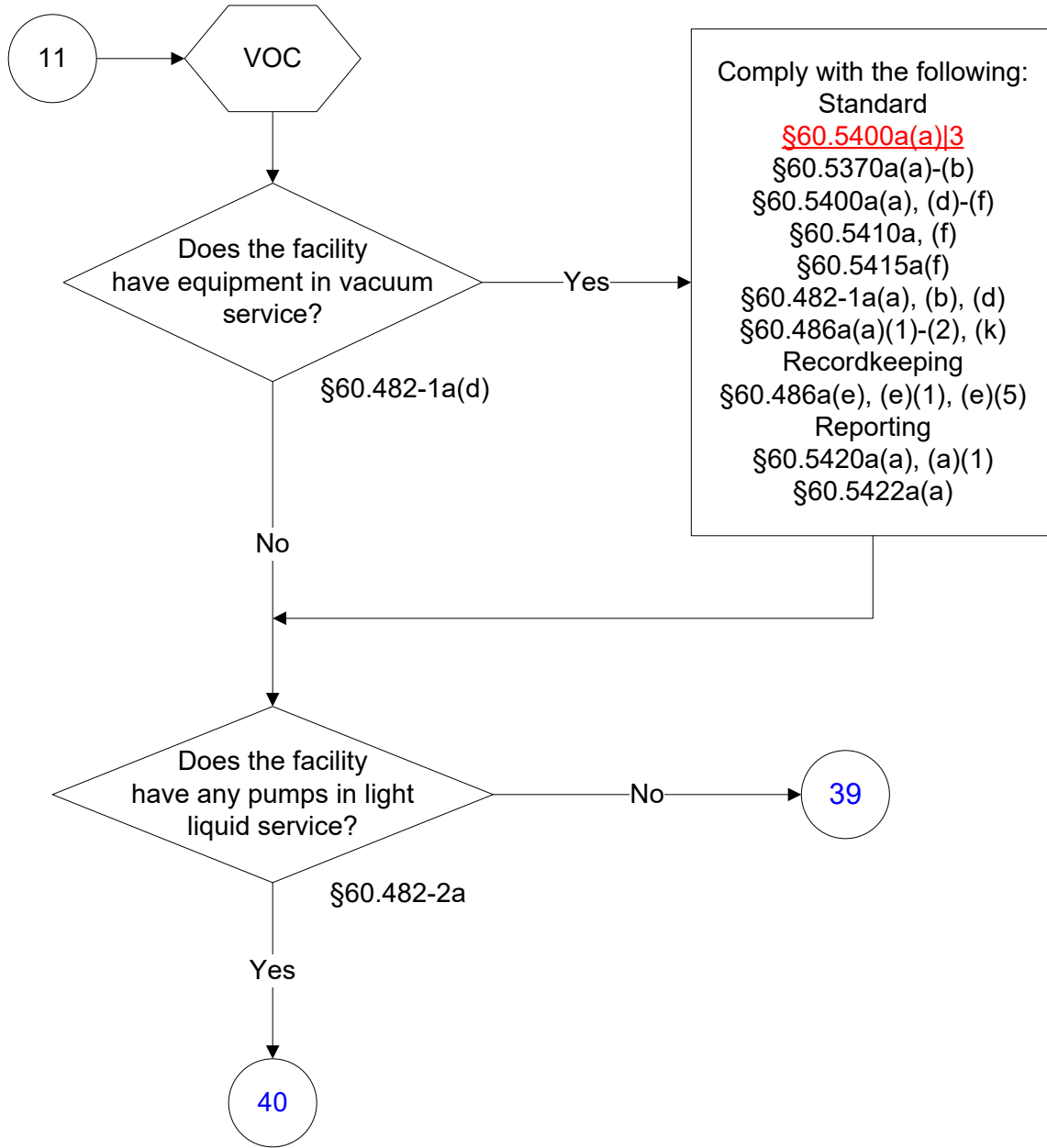

40 CFR Part 60, Subpart OOOOa
(24 of 82)

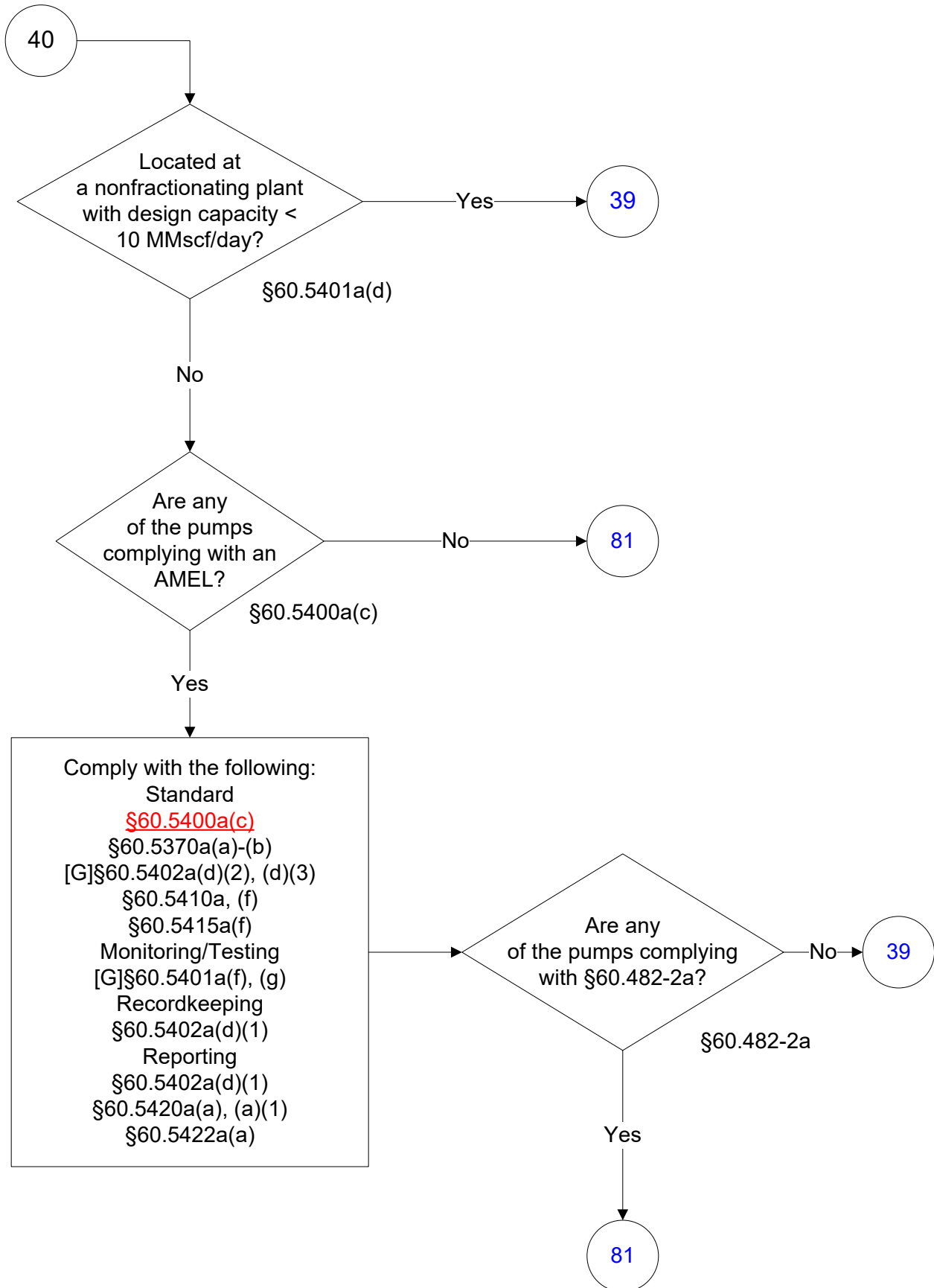

40 CFR Part 60, Subpart OOOOa
(25 of 82)

81

Comply with the following:
Standard

~~§60.5400a(a)~~4

§60.5370a(a)-(b)

§60.5400a(a), (d)-(f)

§60.5401a(d)

§60.5410a, (f)

§60.5415a(f)

§60.482-1a(a)-(b)

§60.482-2a(a)(1)-(2), (b)(1)

§60.482-2a(b)(1)(i)-(ii), (b)(2), (b)(2)(ii)

§60.482-2a(c)(1), [G](c)(2), (d), [G](d)(1)

§60.482-2a(d)(2)-(3), [G](d)(6), [G](e)

§60.482-2a(f), [G](g), (h)

§60.482-9a(a)-(b), [G](d), (f)

§60.485a(b), (c), (c)(1), (f)

§60.486a(a)(1)-(2), (k)

Monitoring/Testing

[G]§60.5401a(f), (g)

§60.482-1a(f)(1)-(2), [G](f)(3)

§60.482-2a(b)(2)(i), [G](d)(4), [G](d)(5)

§60.482-9a(a)

§60.485a(a), [G](b)(1), (b)(2), (c)(2)

§60.485a(d), (d)(2)-(3), [G](e)

Recordkeeping

§60.485a(b)(2)

[G]§60.486a(a)(3), [G](b)-(c), (e)

§60.486a(e)(1), [G](e)(2), [G](e)(4)

§60.486a(e)(7), [G](e)(8), [G](h)

Reporting

§60.5420a(a), (a)(1)

§60.5422a(a)

§60.487a(a), (b), (b)(1), (b)(3), (c)

§60.487a(c)(1), (c)(2), (c)(2)(i), (c)(2)(iii)

§60.487a(c)(2)(iv), (c)(2)(xi), (c)(3)-(4)

§60.487a(e)

39

40 CFR Part 60, Subpart OOOOa
(26 of 82)

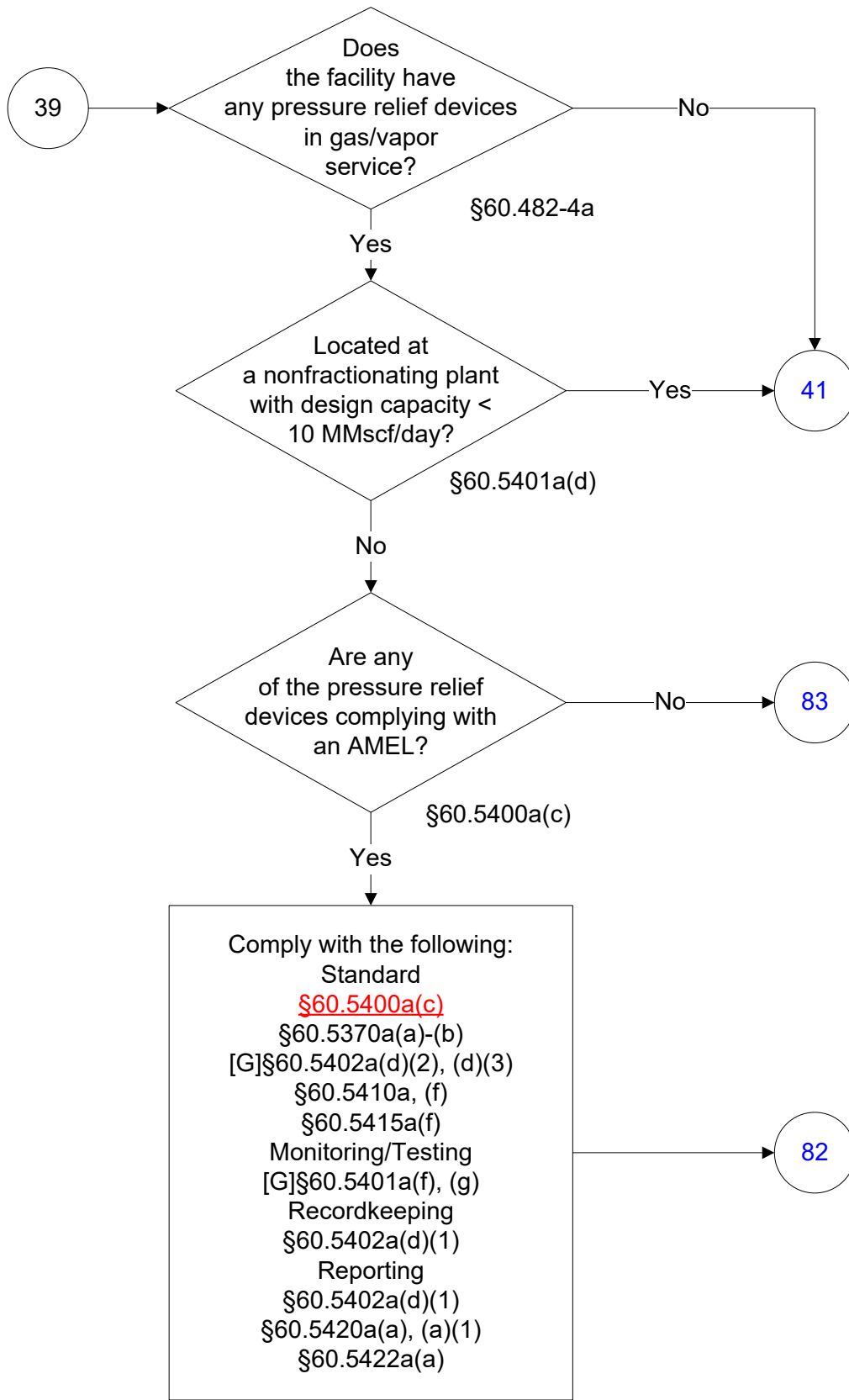

40 CFR Part 60, Subpart OOOOa
(27 of 82)

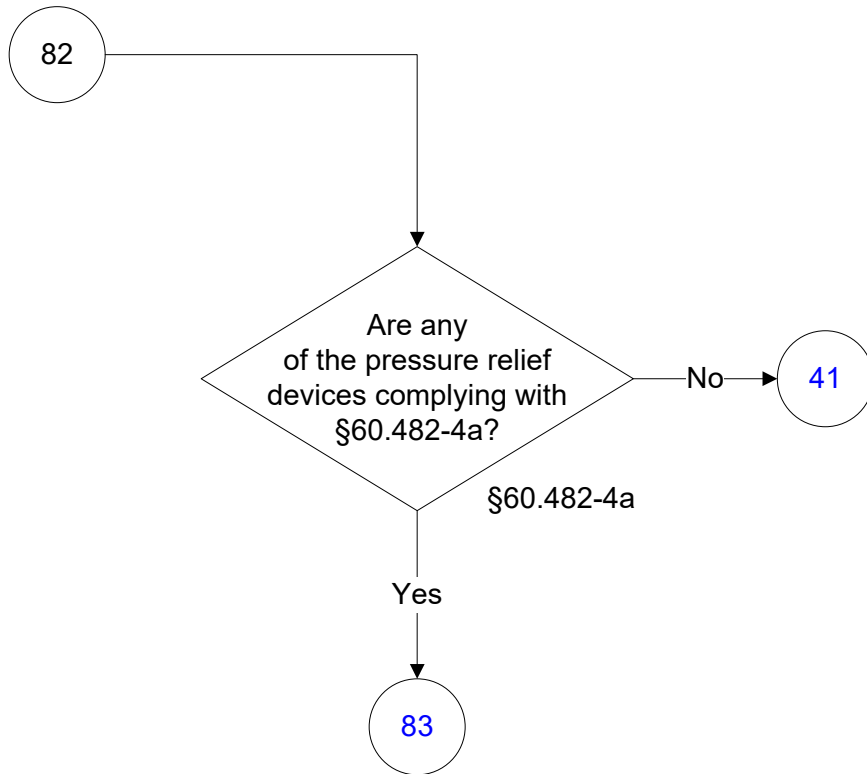

40 CFR Part 60, Subpart OOOOa
(28 of 82)

83

Comply with the following:
Standard

§60.5400a(a)5

§60.5370a(a)-(b)

§60.5400a(a), (d)-(f)

§60.5401a(b)(2), (b)(3)(i)-(ii)

§60.5401a(b)(4)(i)-(ii), (d)

§60.5410a, (f)

§60.5415a(f)

§60.482-1a(a)-(b)

§60.482-4a(a), (b)(1)-(2), (c)

§60.482-4a(d)(1)-(2)

§60.482-9a(a)-(b)

§60.485a(b), (c), (c)(1), (f)

§60.486a(a)(1)-(2), (k)

Monitoring/Testing

§60.5401a(b)(1), [G](f), (g)

§60.482-4a(b)(2)

§60.482-9a(a)

§60.485a(a), [G](b)(1), (b)(2), (c)(2)

§60.485a(d), (d)(2), (d)(3)

Recordkeeping

[G]§60.5421a(b)

§60.485a(b)(2)

§60.486a(e), (e)(1), (e)(3), [G](e)(4)

[G]§60.486a(e)(8), [G](e)(10), (f), (f)(1)

Reporting

§60.5420a(a), (a)(1)

§60.5422a(a), (b), [G](c)

§60.487a(a), (b), (b)(1), (c), (c)(1)

§60.487a(c)(2), (c)(2)(xi), (c)(3)-(4)

§60.487a(e)

41

40 CFR Part 60, Subpart OOOOa
(29 of 82)

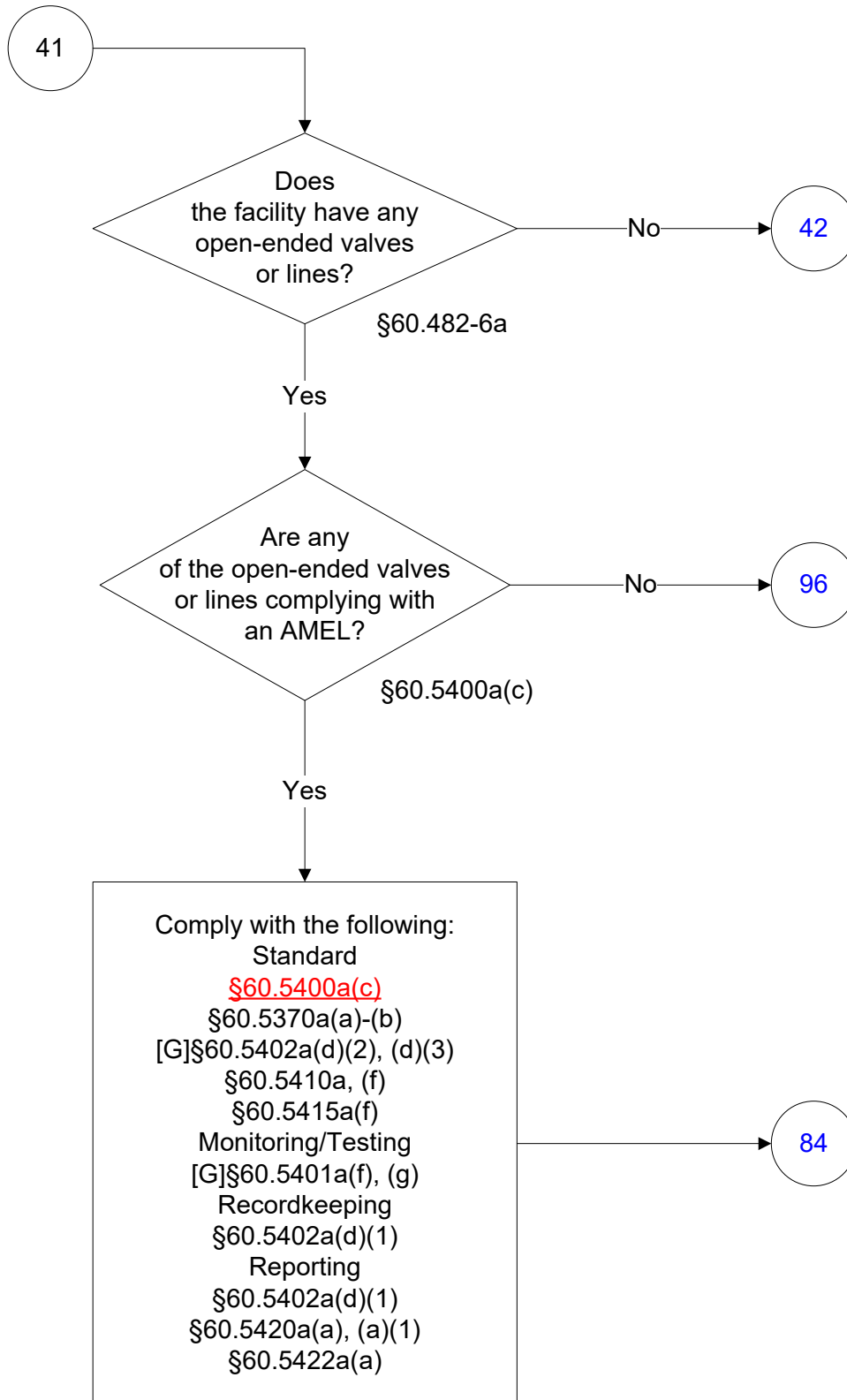

40 CFR Part 60, Subpart OOOOa
(30 of 82)

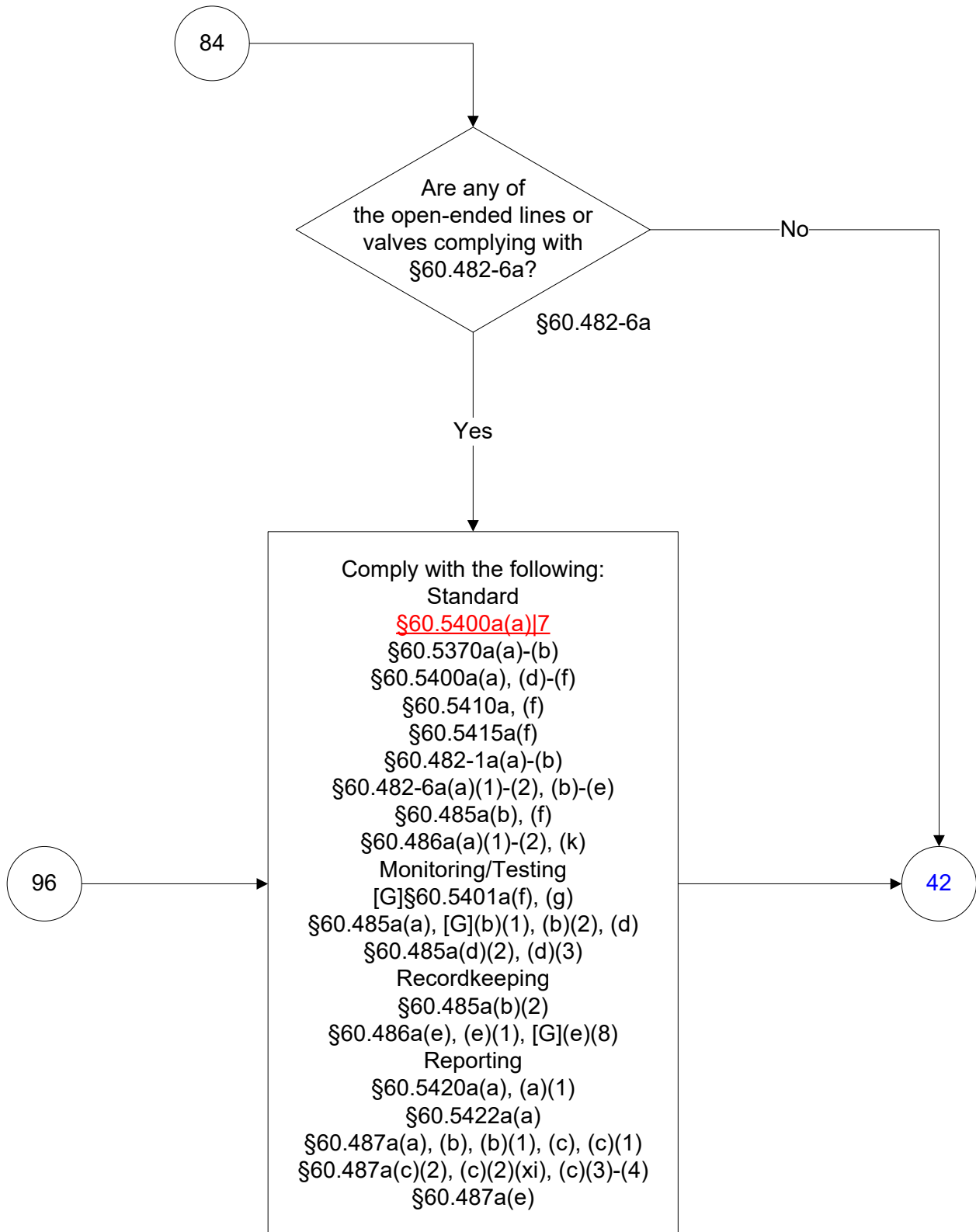

40 CFR Part 60, Subpart OOOOa
(31 of 82)

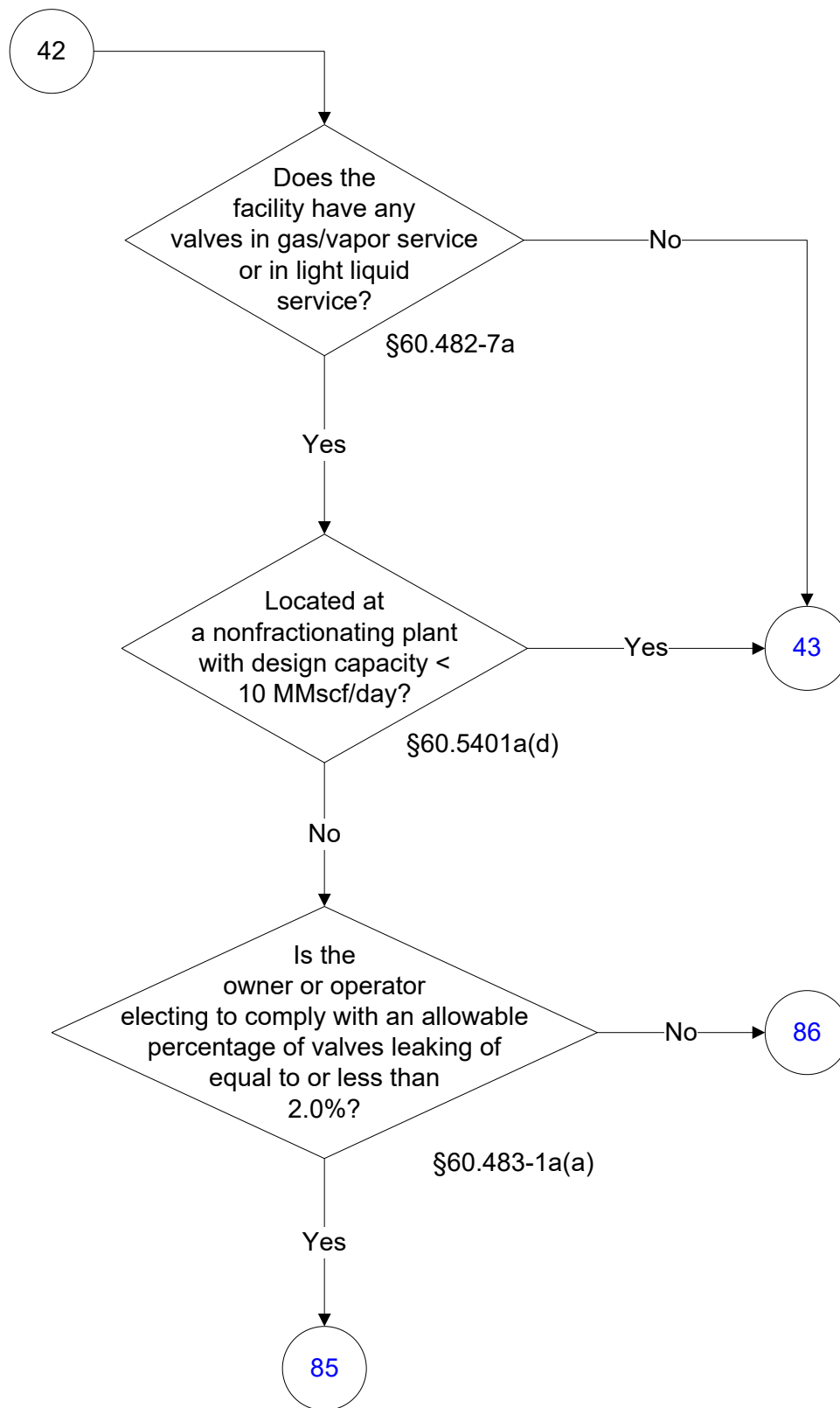

40 CFR Part 60, Subpart OOOOa
(32 of 82)

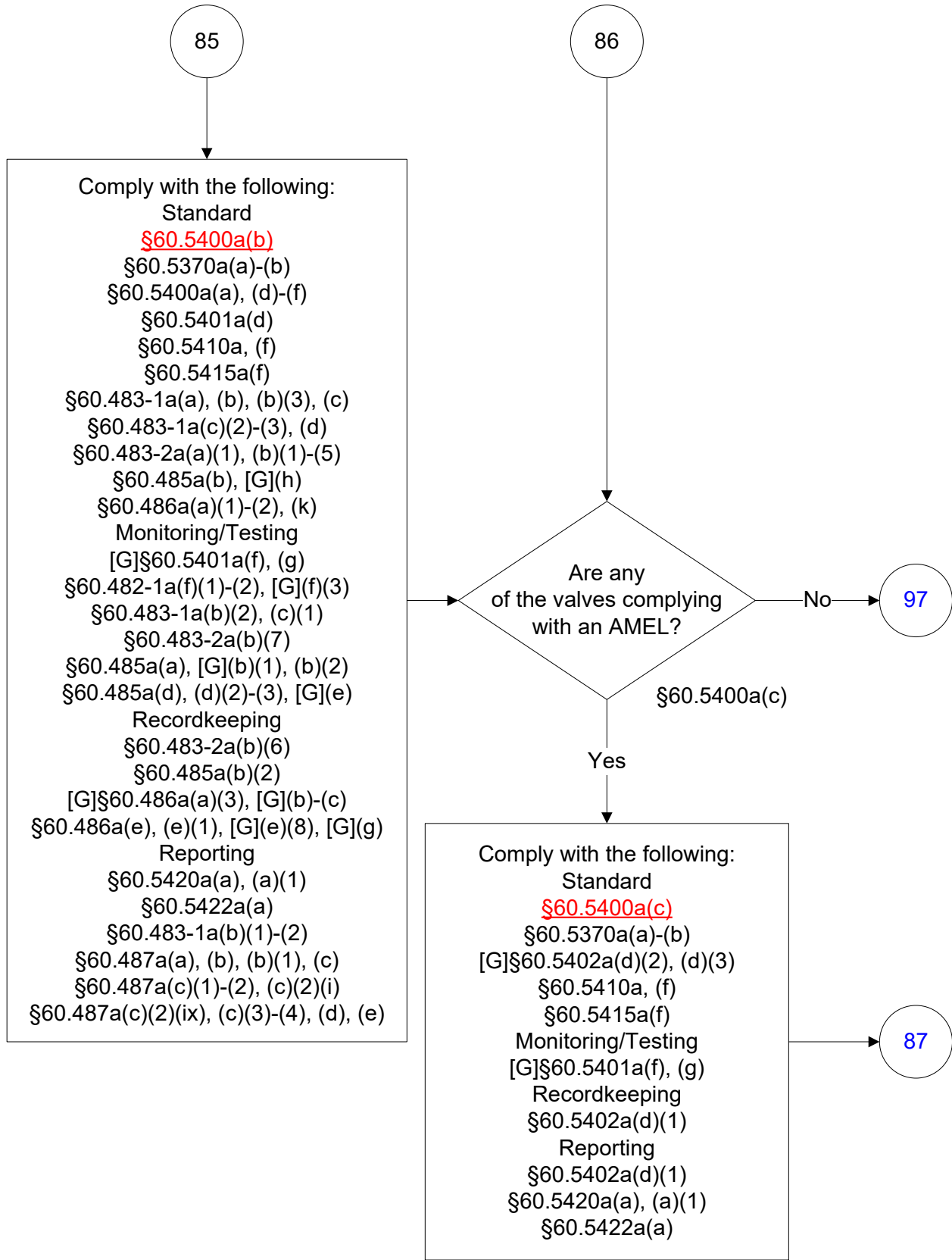

40 CFR Part 60, Subpart OOOOa
(33 of 82)

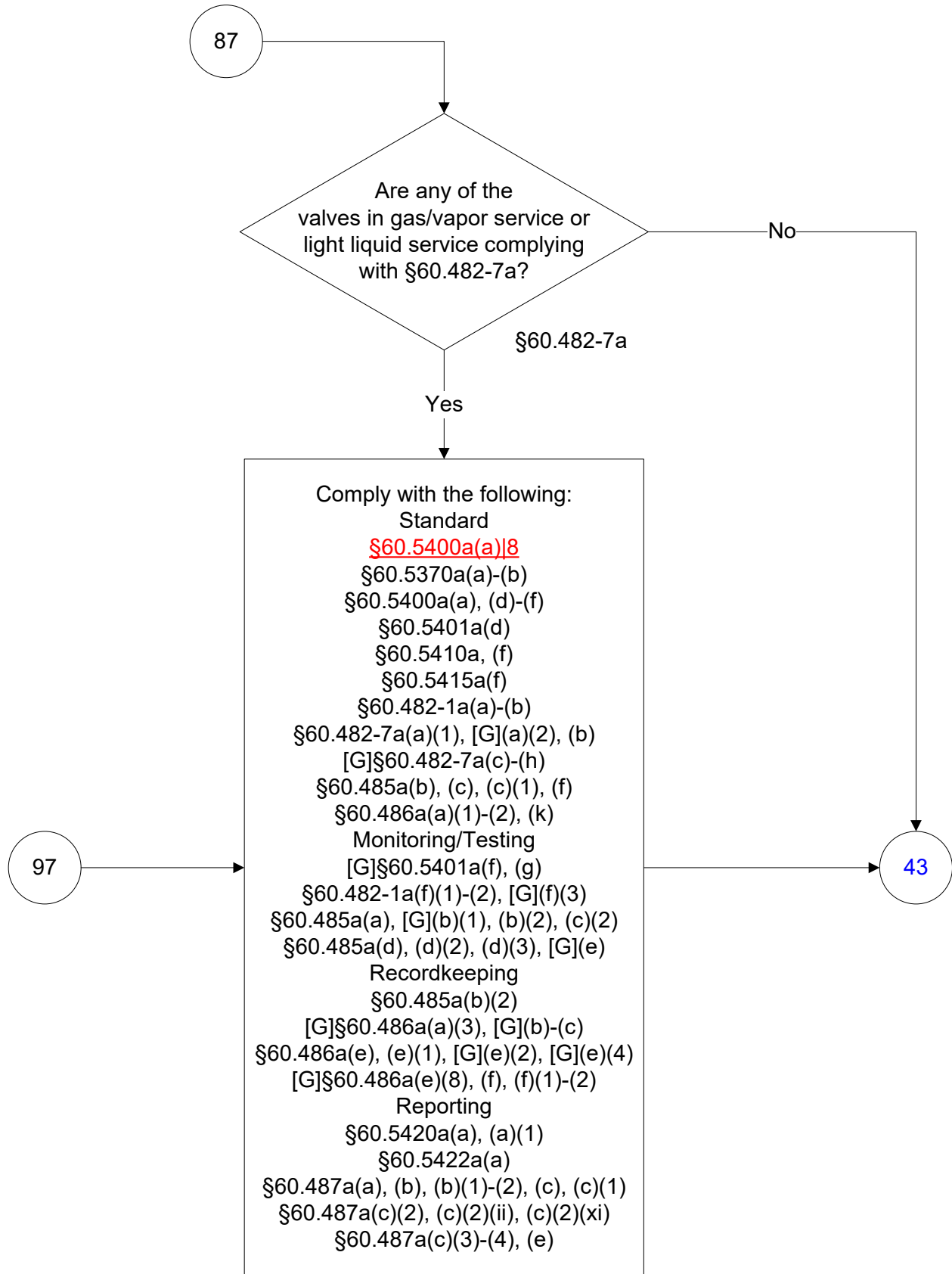

40 CFR Part 60, Subpart OOOOa
(34 of 82)

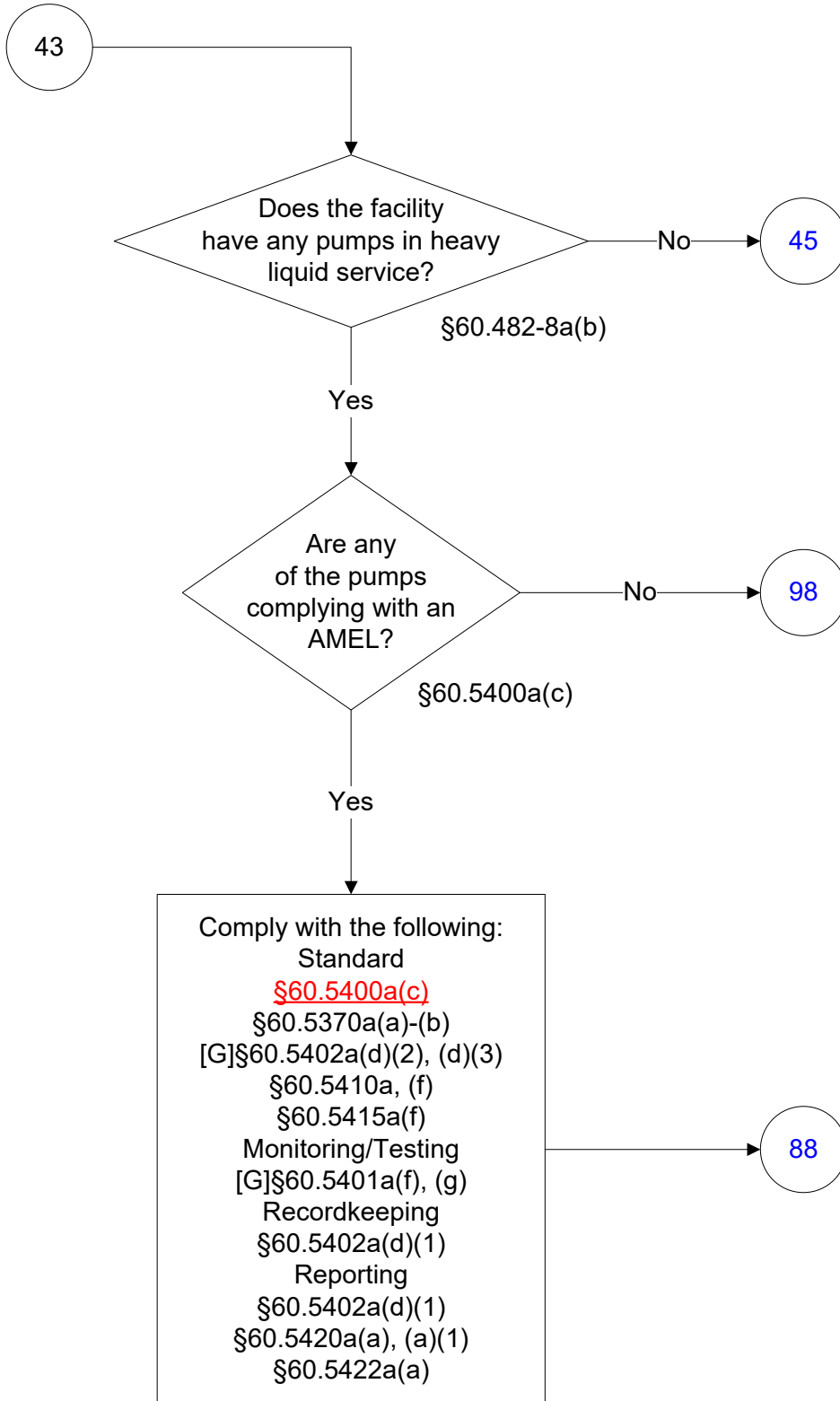

40 CFR Part 60, Subpart OOOOa
(35 of 82)

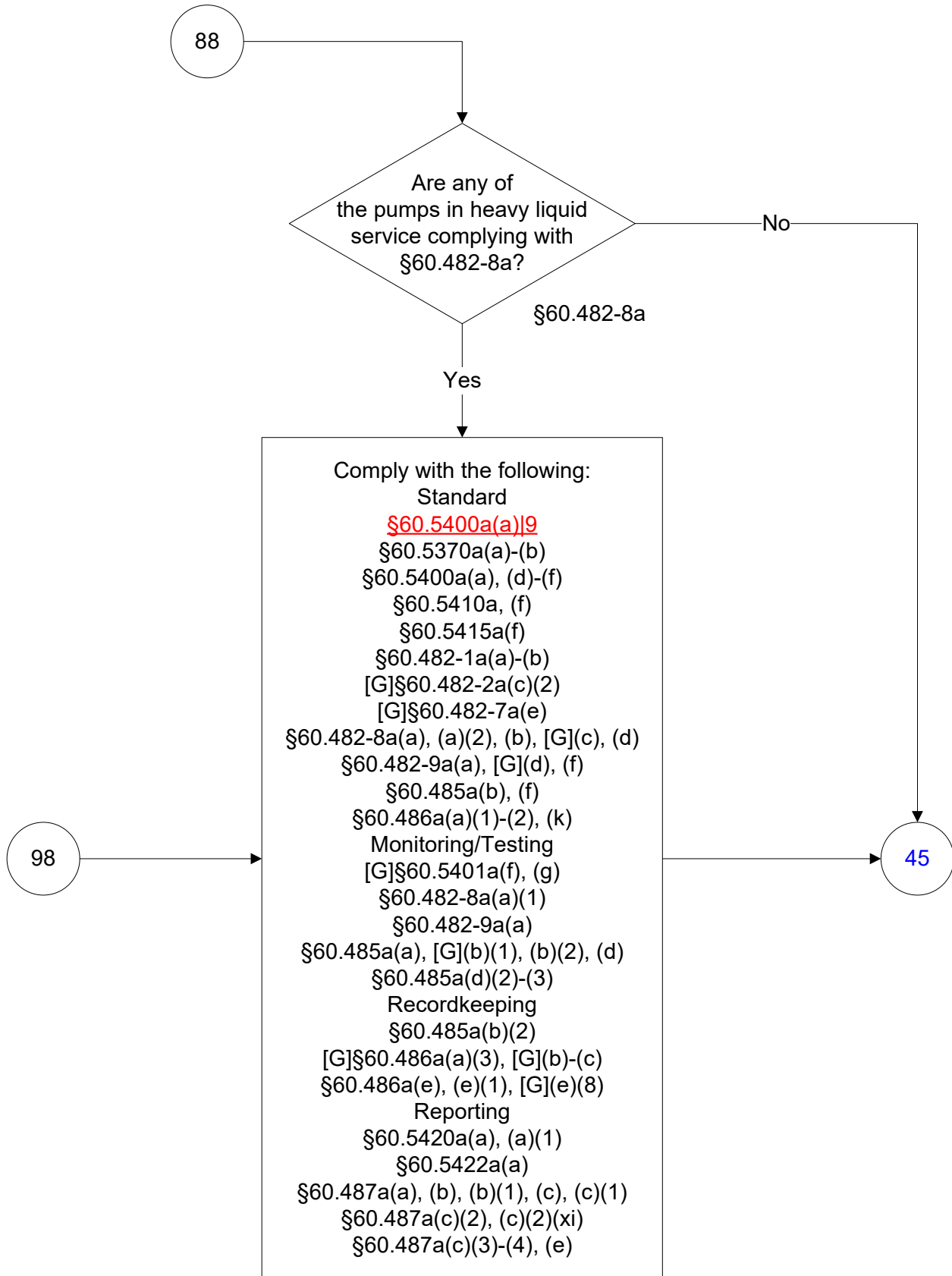

40 CFR Part 60, Subpart OOOOa
(36 of 82)

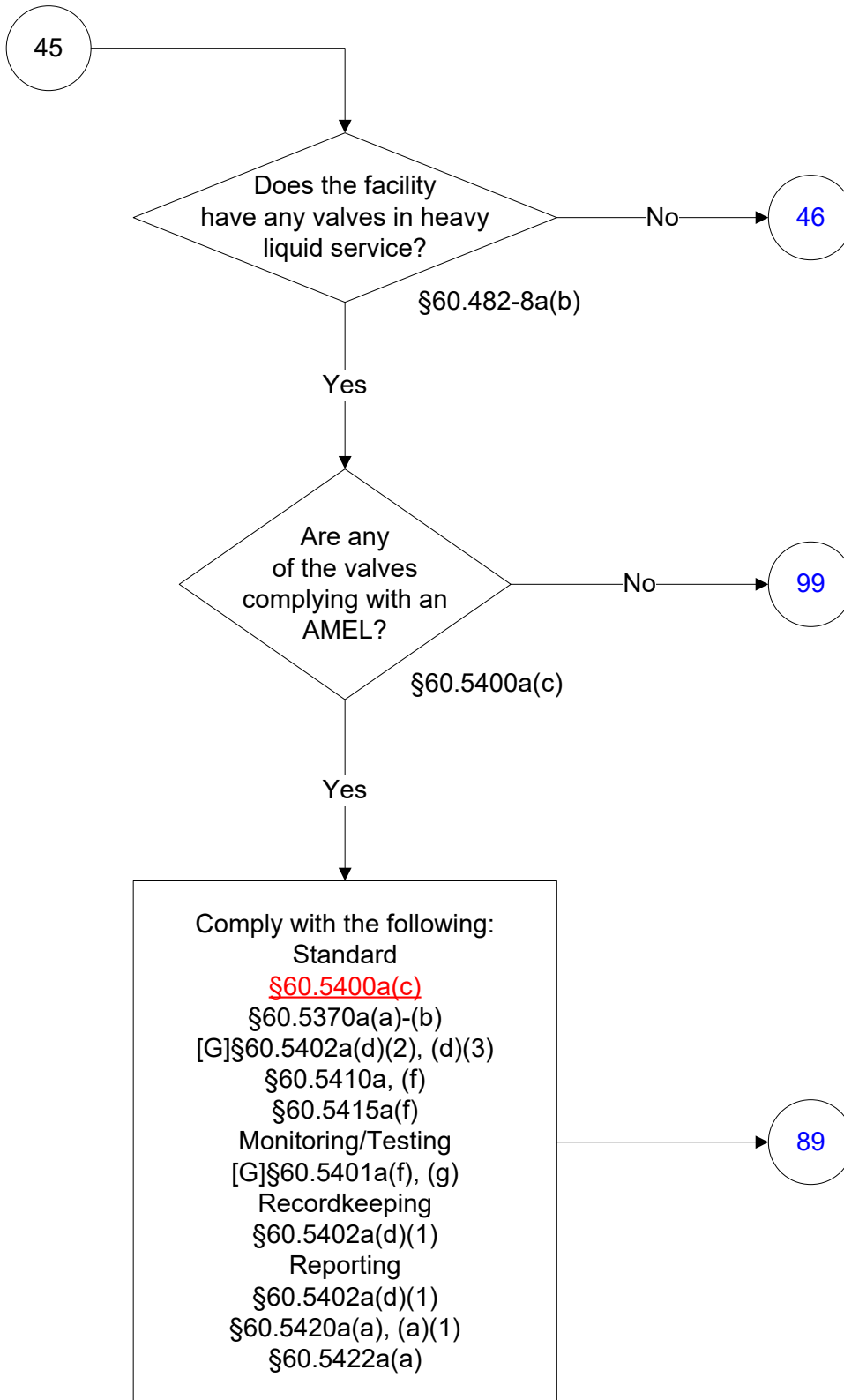

40 CFR Part 60, Subpart OOOOa
(37 of 82)

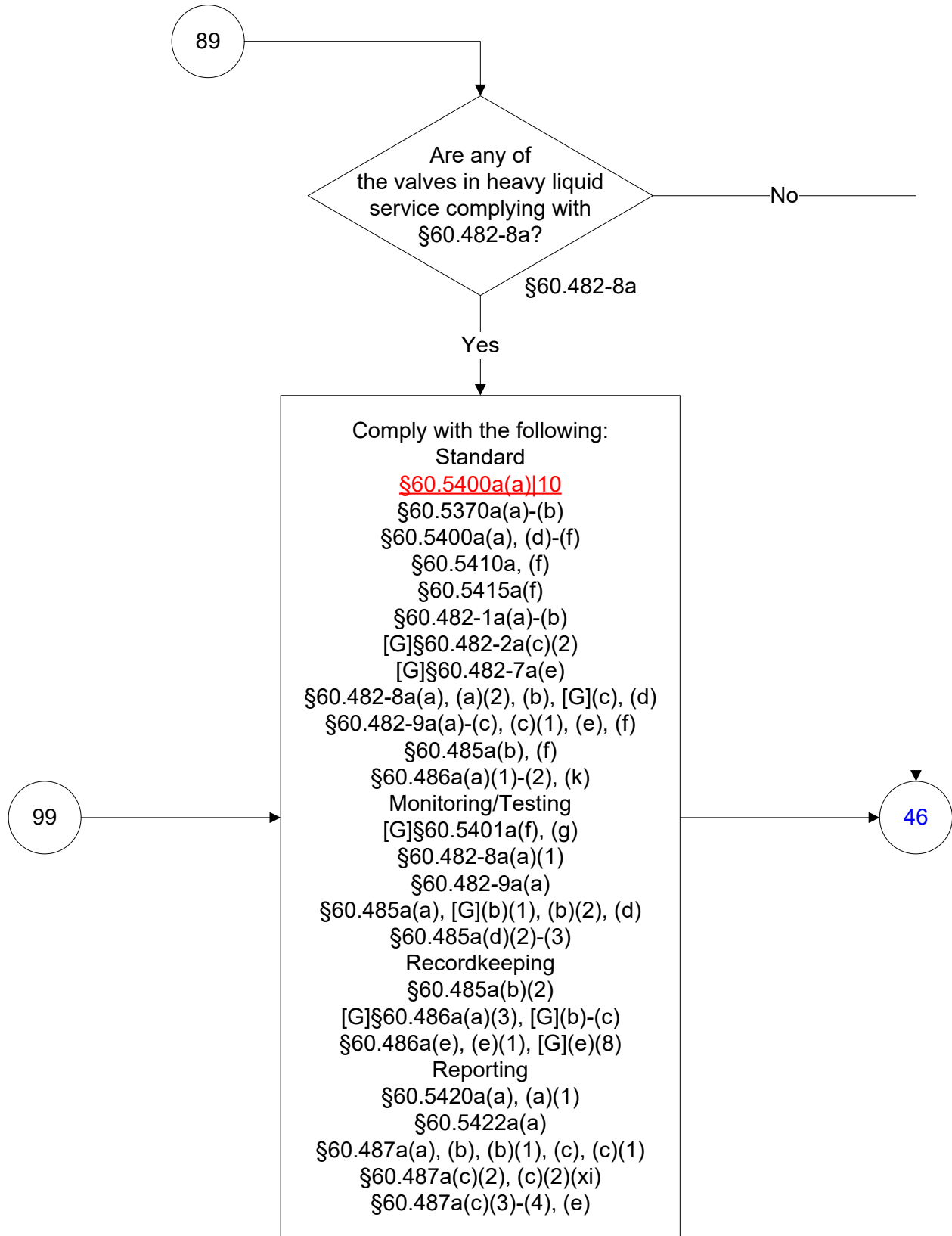

40 CFR Part 60, Subpart OOOOa
(38 of 82)

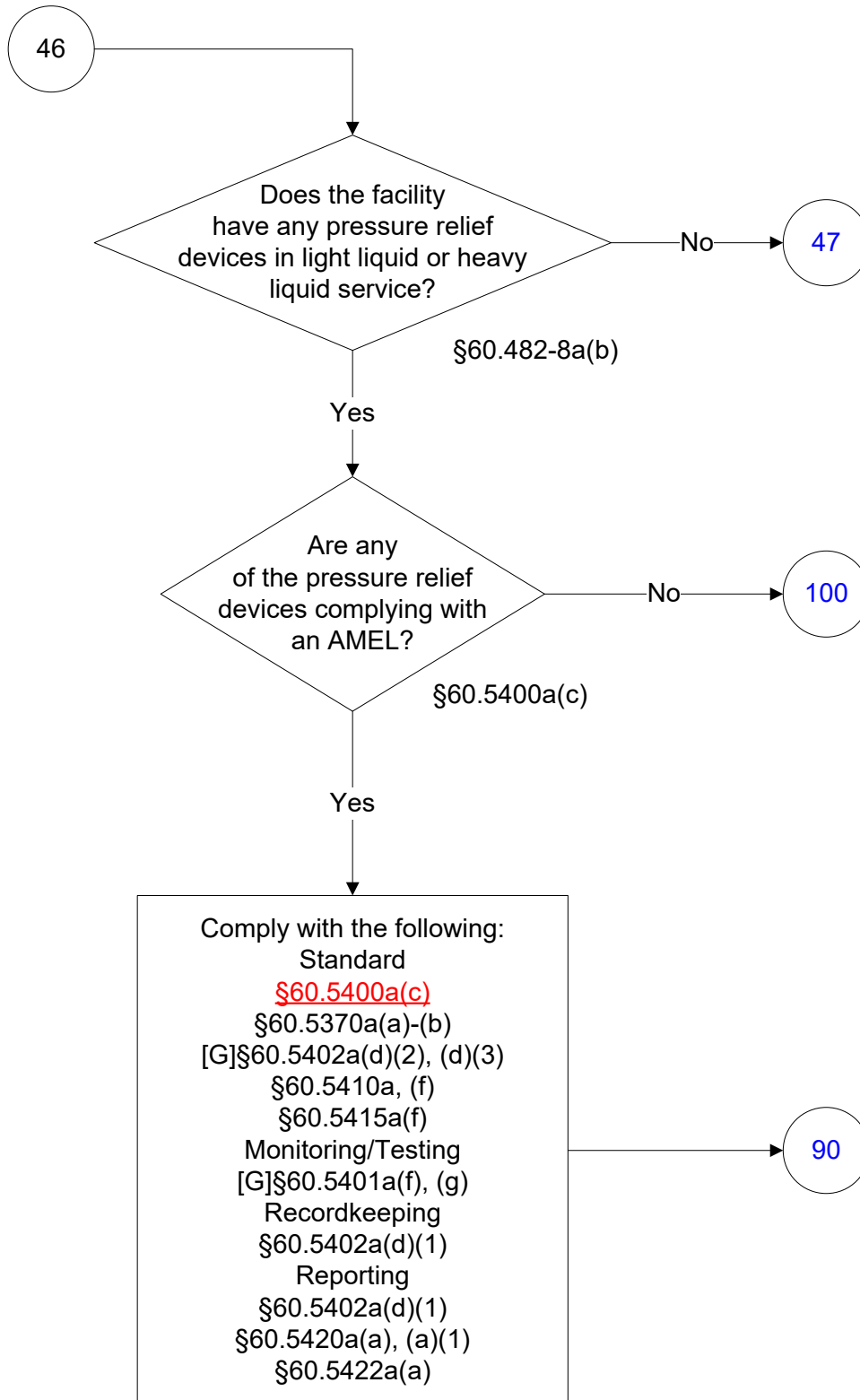

40 CFR Part 60, Subpart OOOOa
(39 of 82)

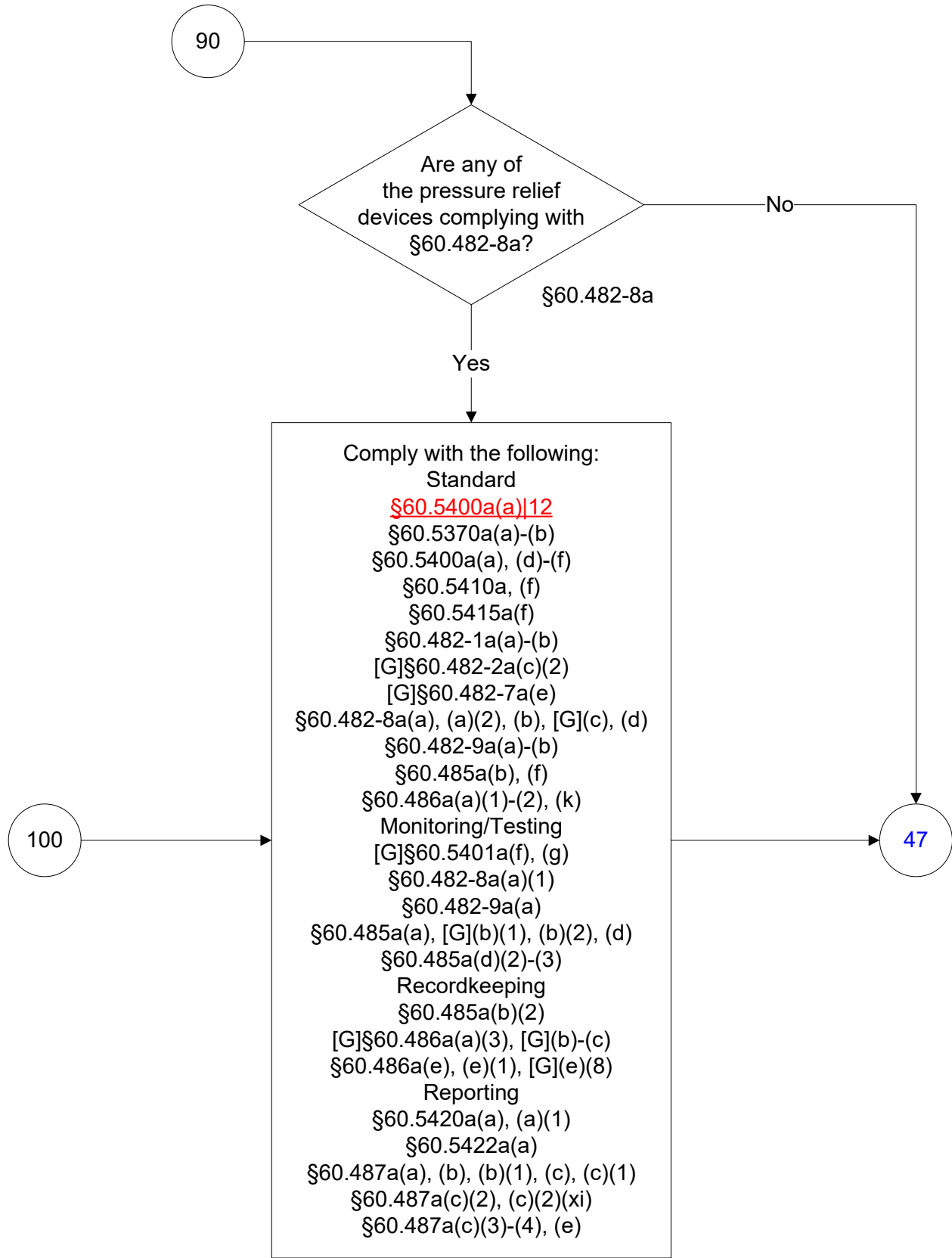

40 CFR Part 60, Subpart OOOOa
(40 of 82)

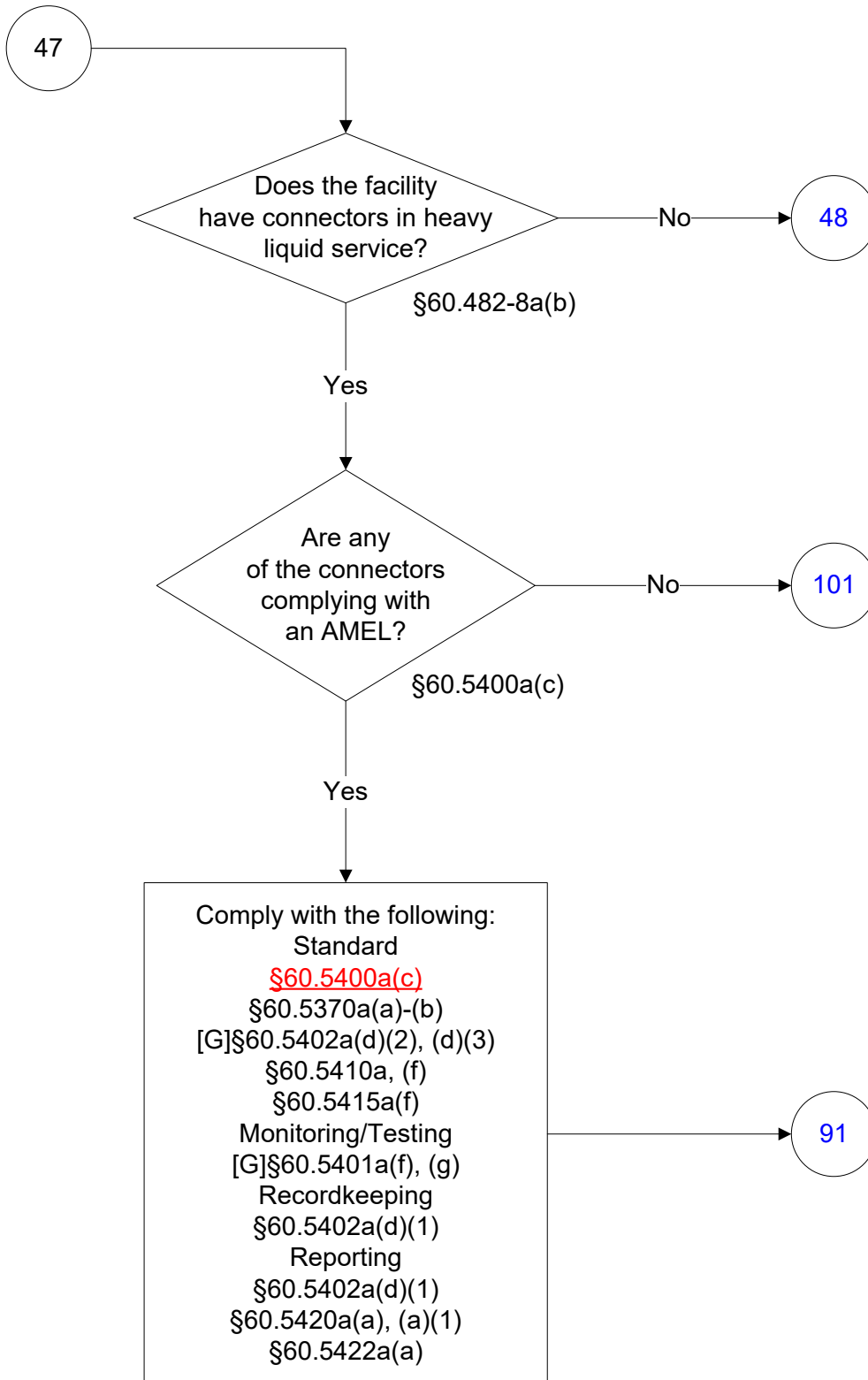

40 CFR Part 60, Subpart OOOOa
(41 of 82)

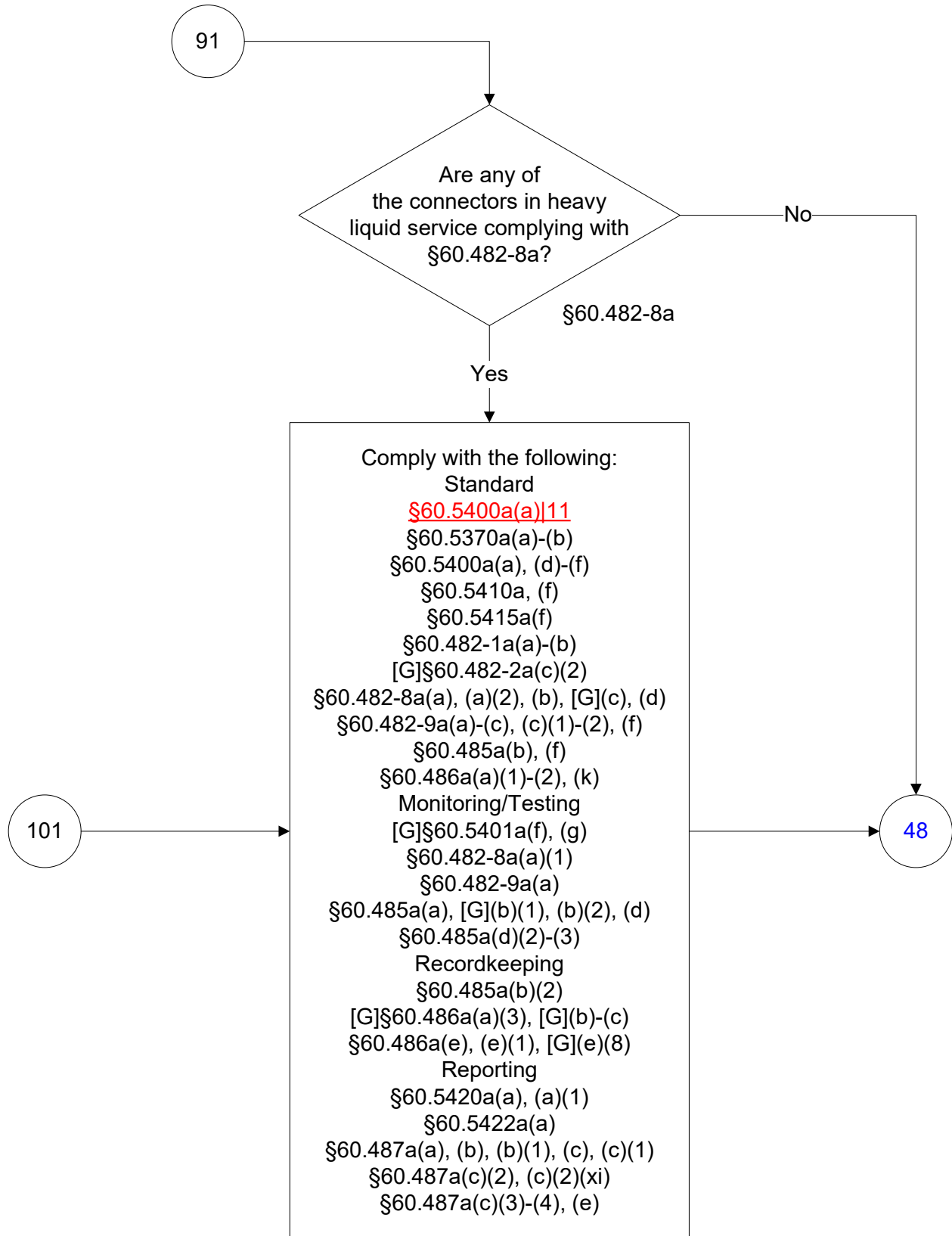

40 CFR Part 60, Subpart OOOOa

(42 of 82)

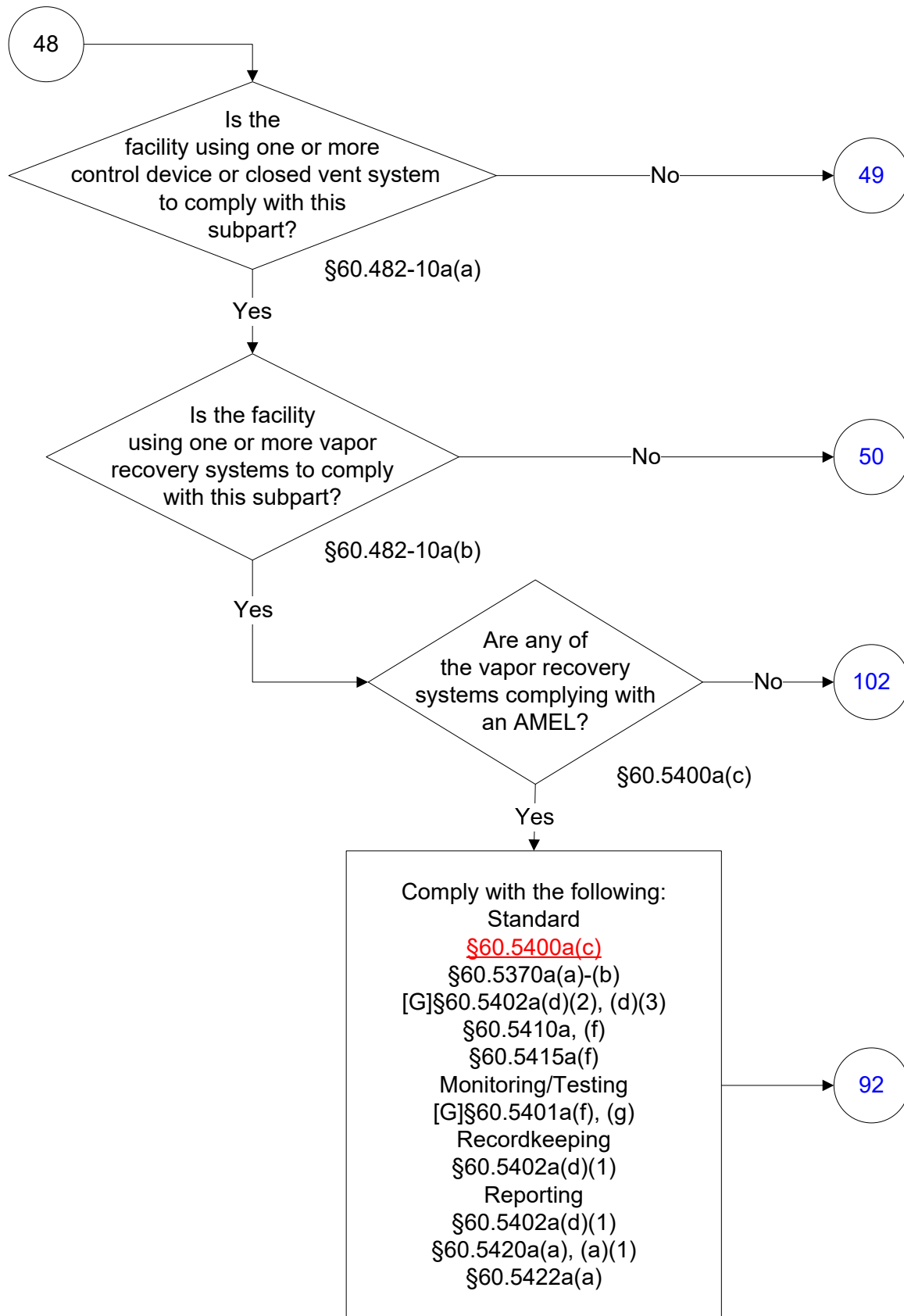

40 CFR Part 60, Subpart OOOOa
(43 of 82)

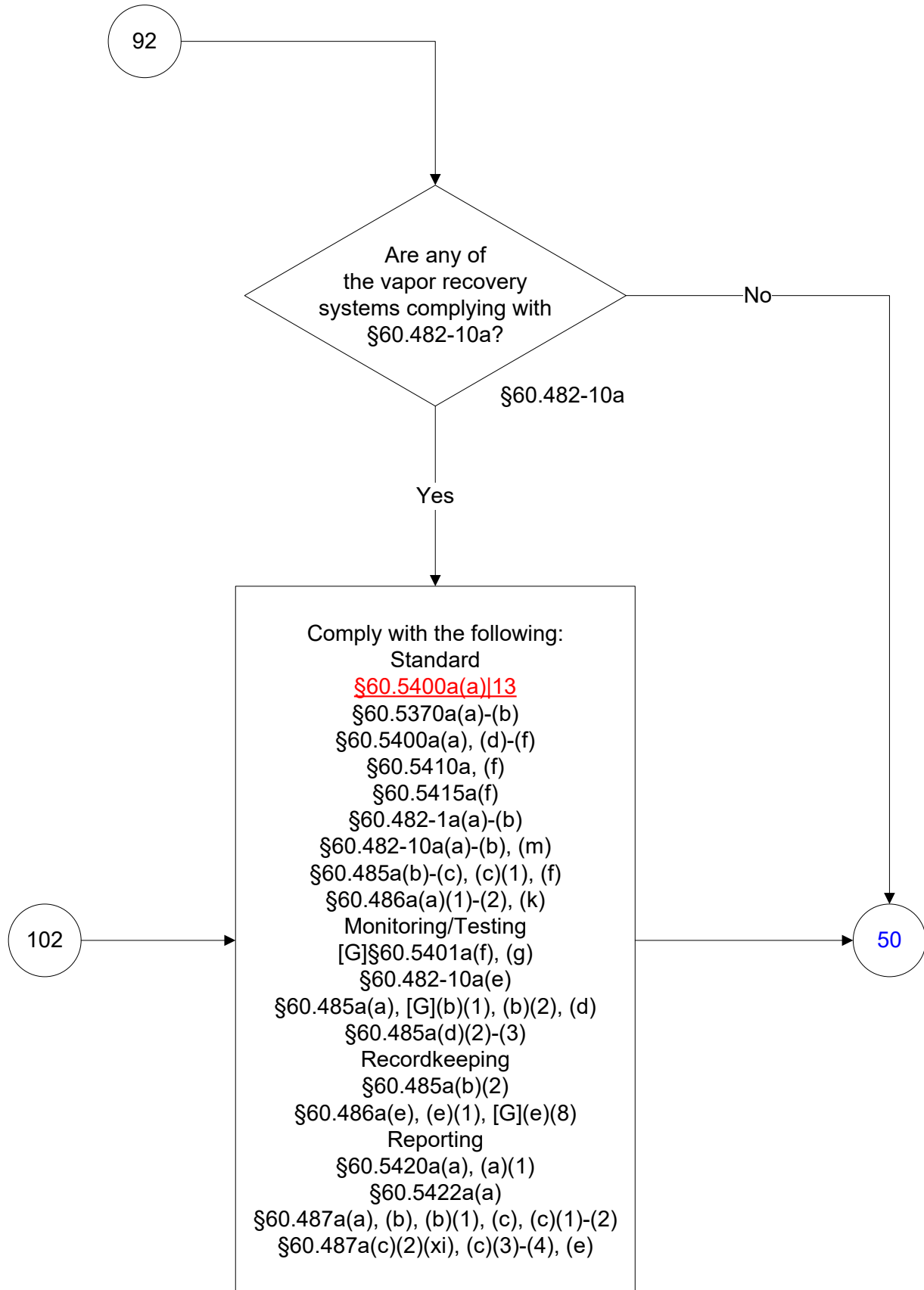

40 CFR Part 60, Subpart OOOOa
(44 of 82)

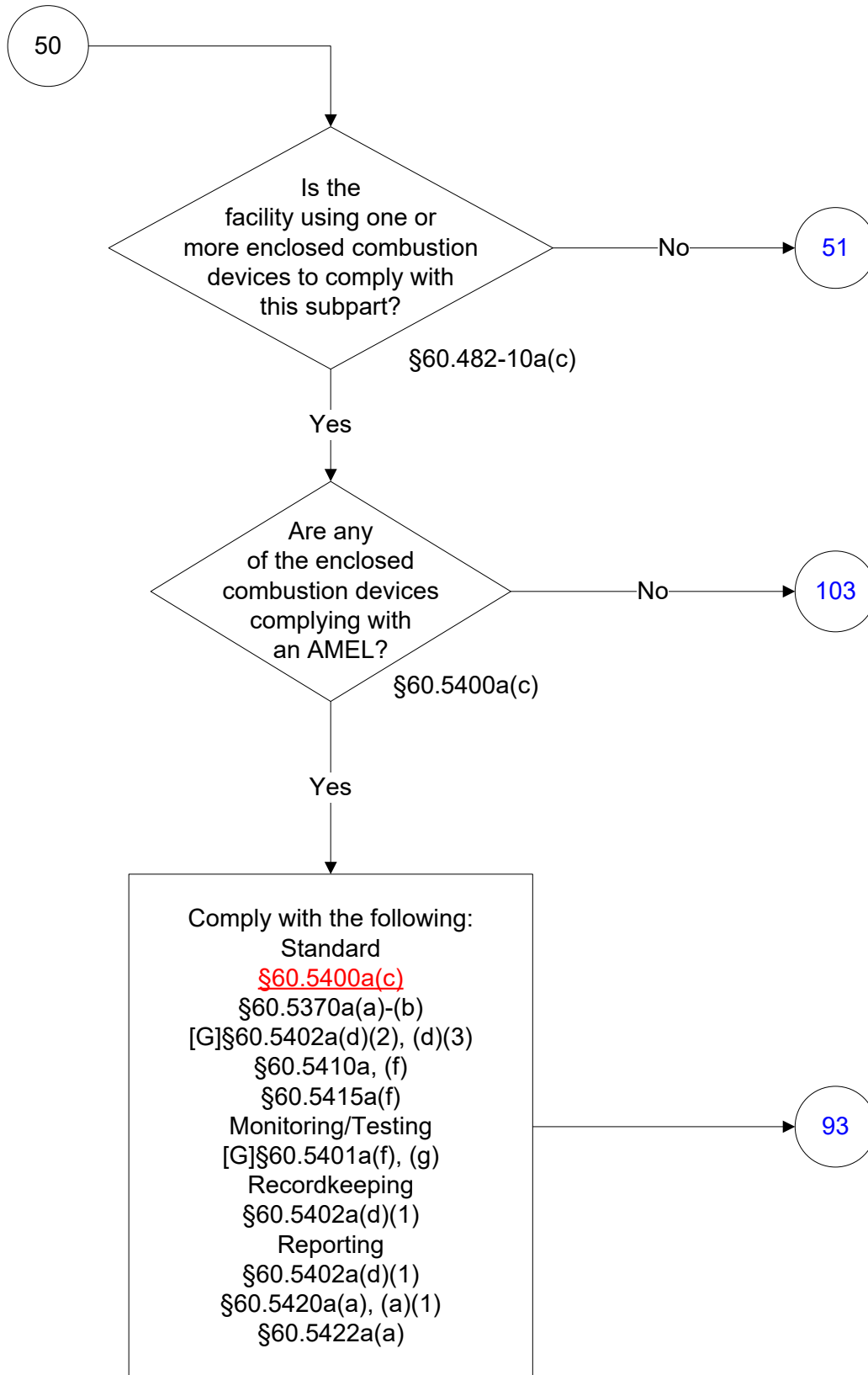

40 CFR Part 60, Subpart OOOOa
(45 of 82)

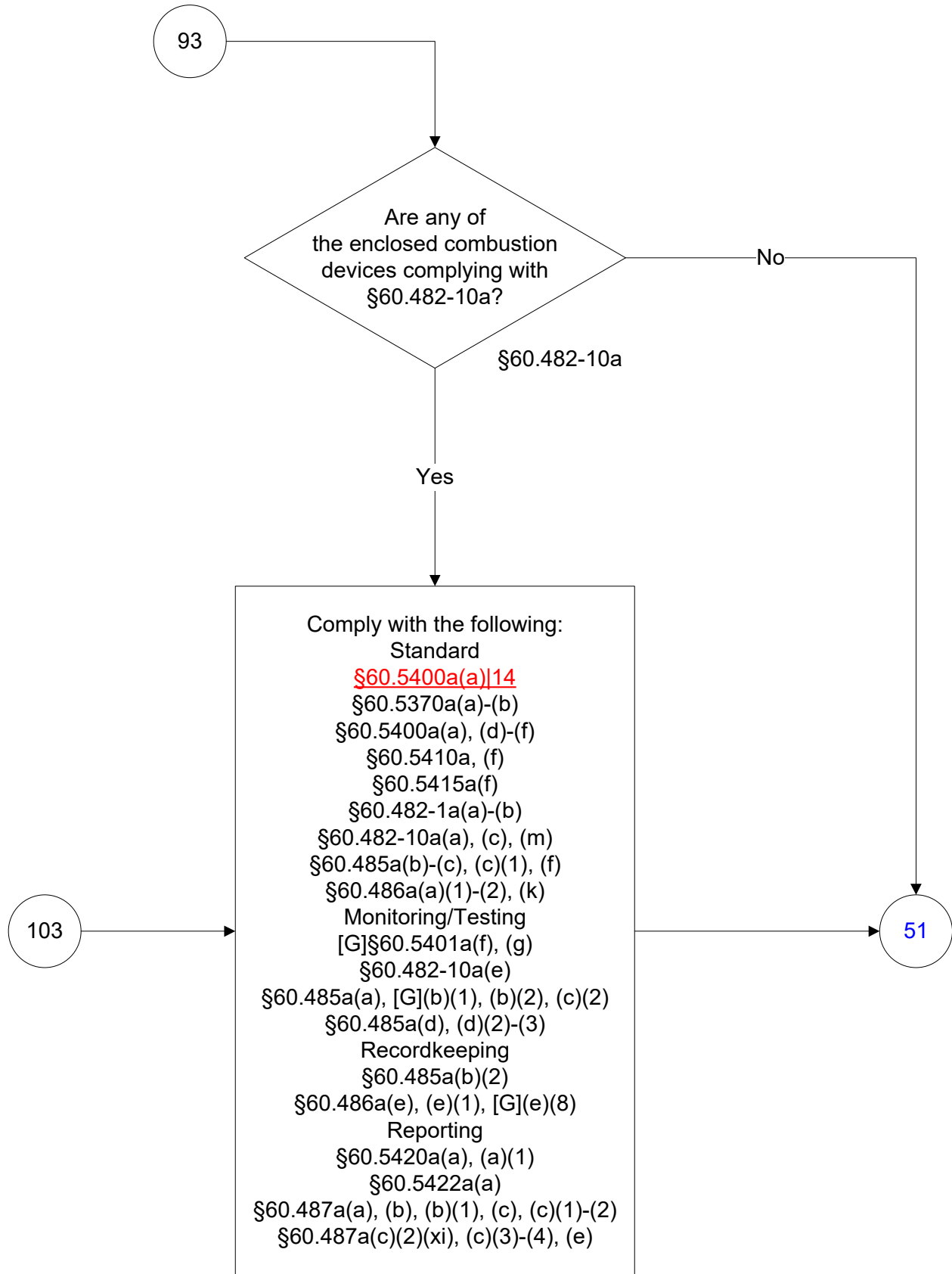

40 CFR Part 60, Subpart OOOOa
(46 of 82)

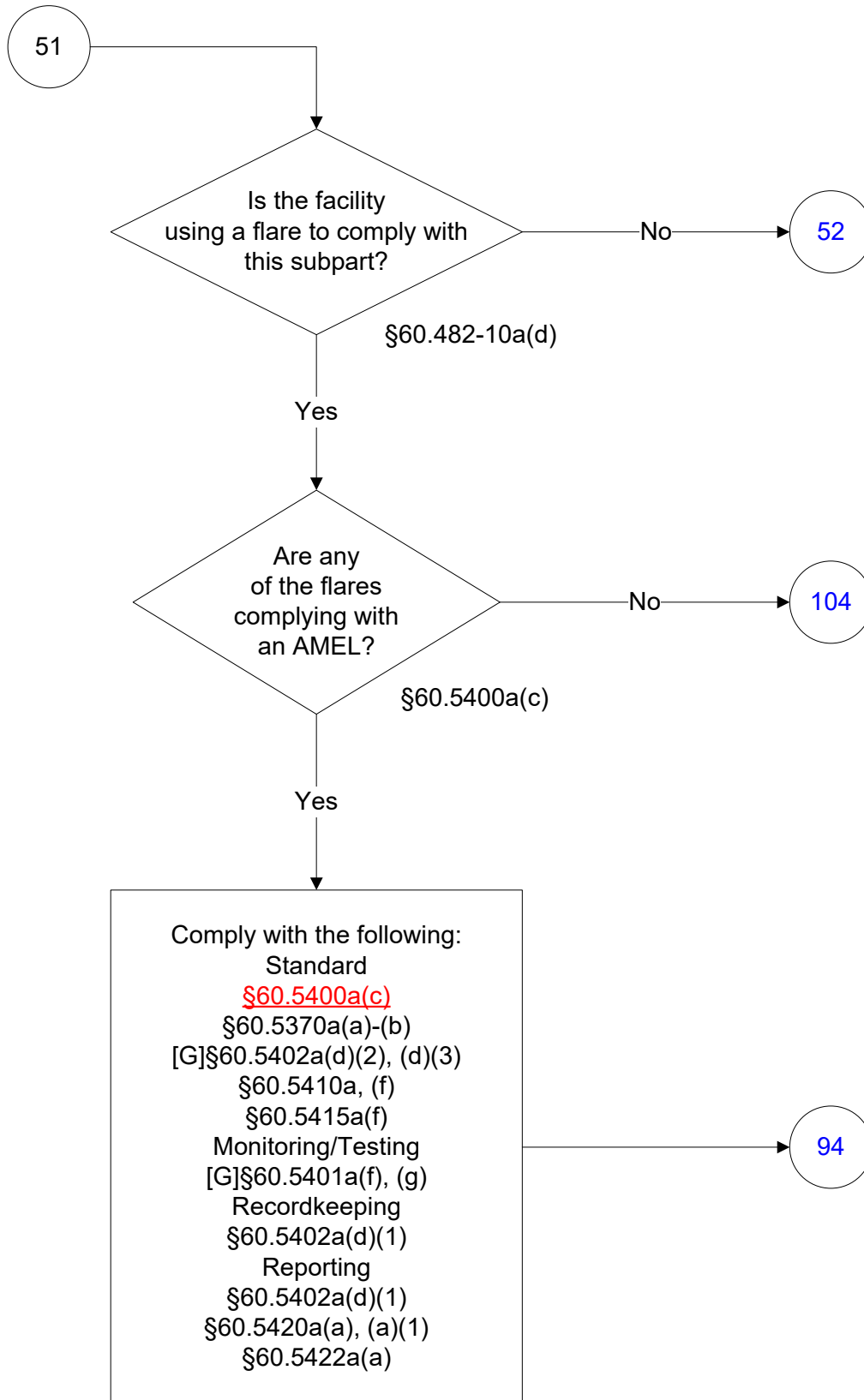

40 CFR Part 60, Subpart OOOOa
(47 of 82)

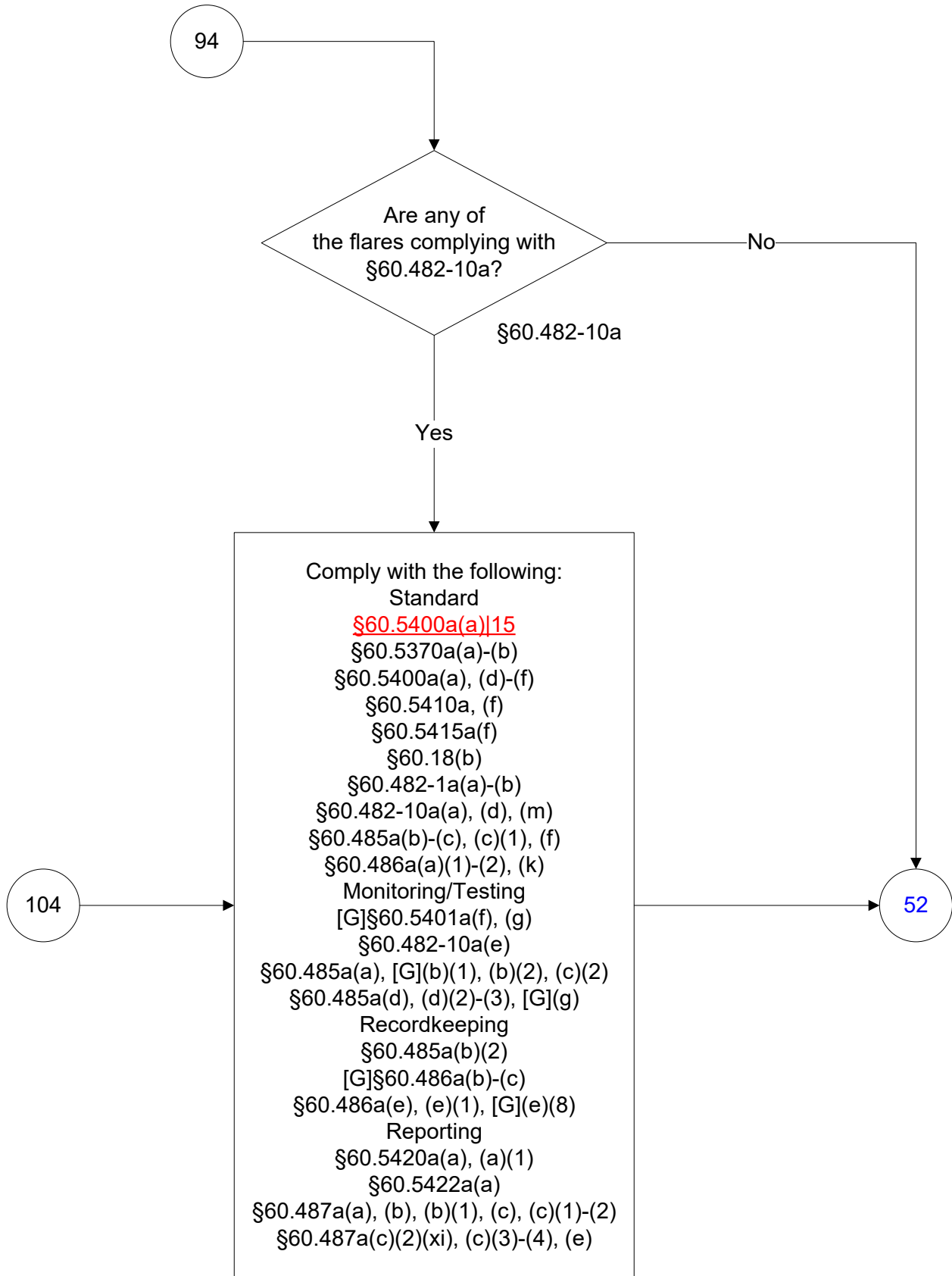

40 CFR Part 60, Subpart OOOOa
(48 of 82)

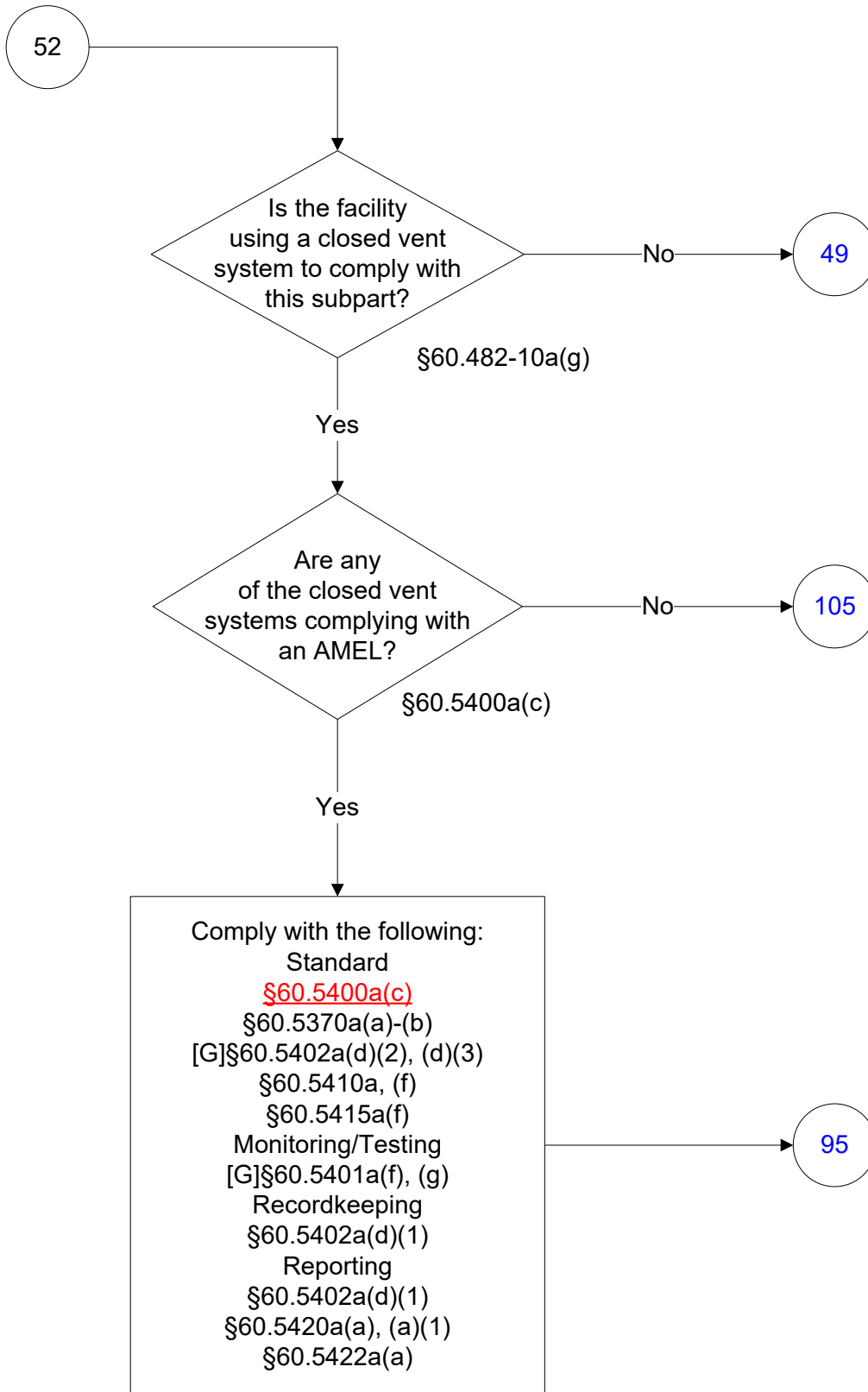

40 CFR Part 60, Subpart OOOOa
(49 of 82)

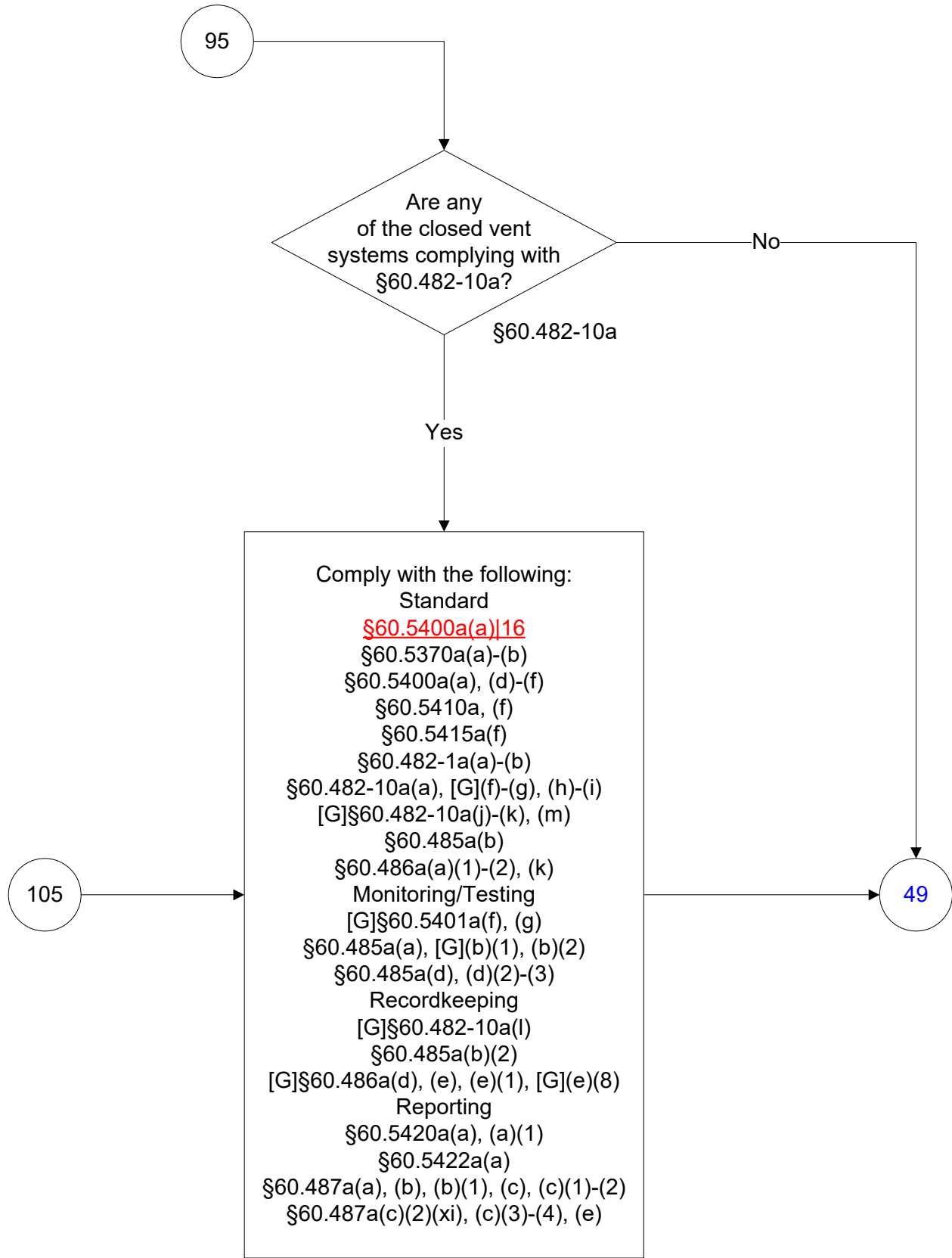

40 CFR Part 60, Subpart OOOOa
(50 of 82)

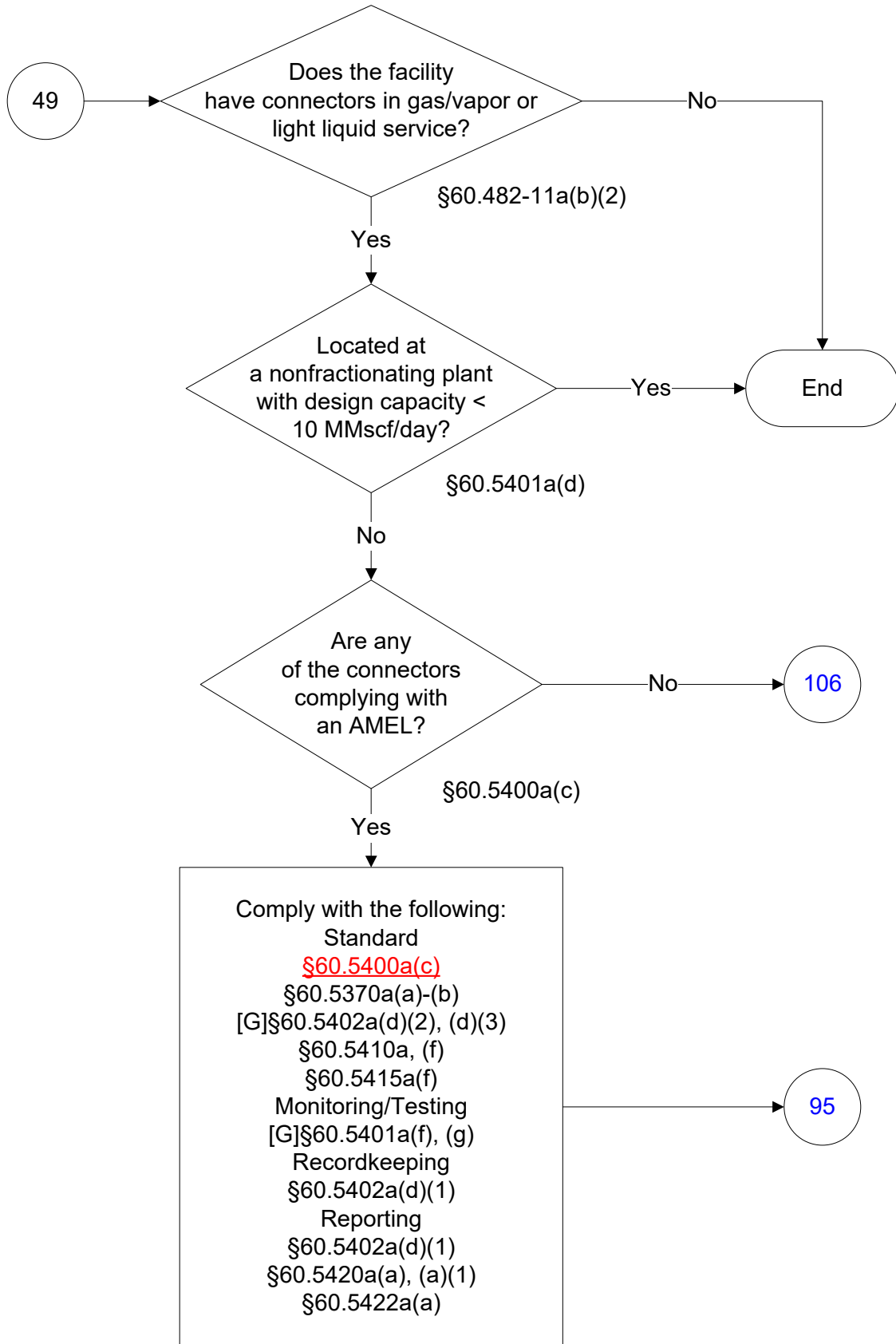

40 CFR Part 60, Subpart OOOOa
(51 of 82)

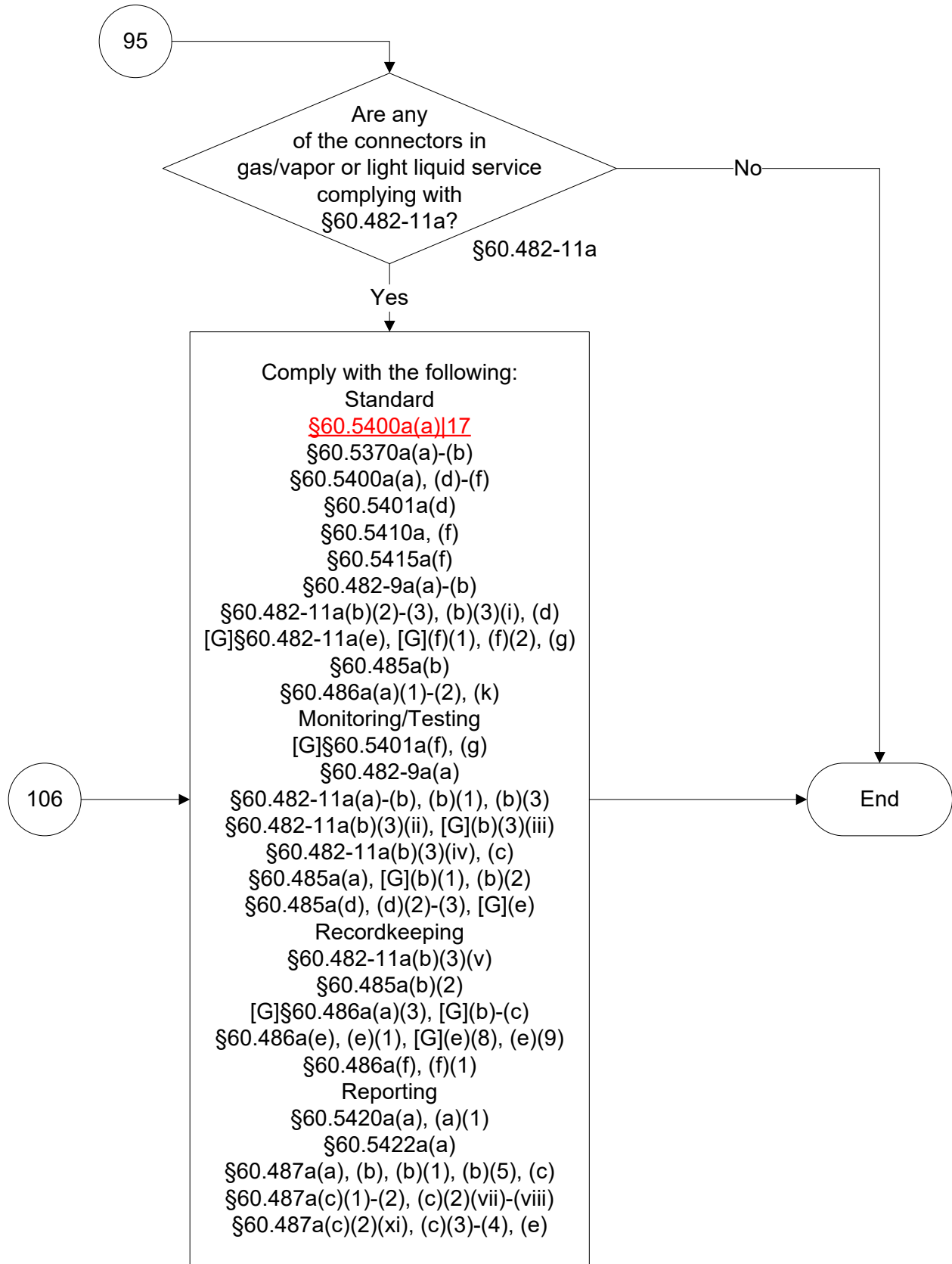

40 CFR Part 60, Subpart OOOOa
(52 of 82)

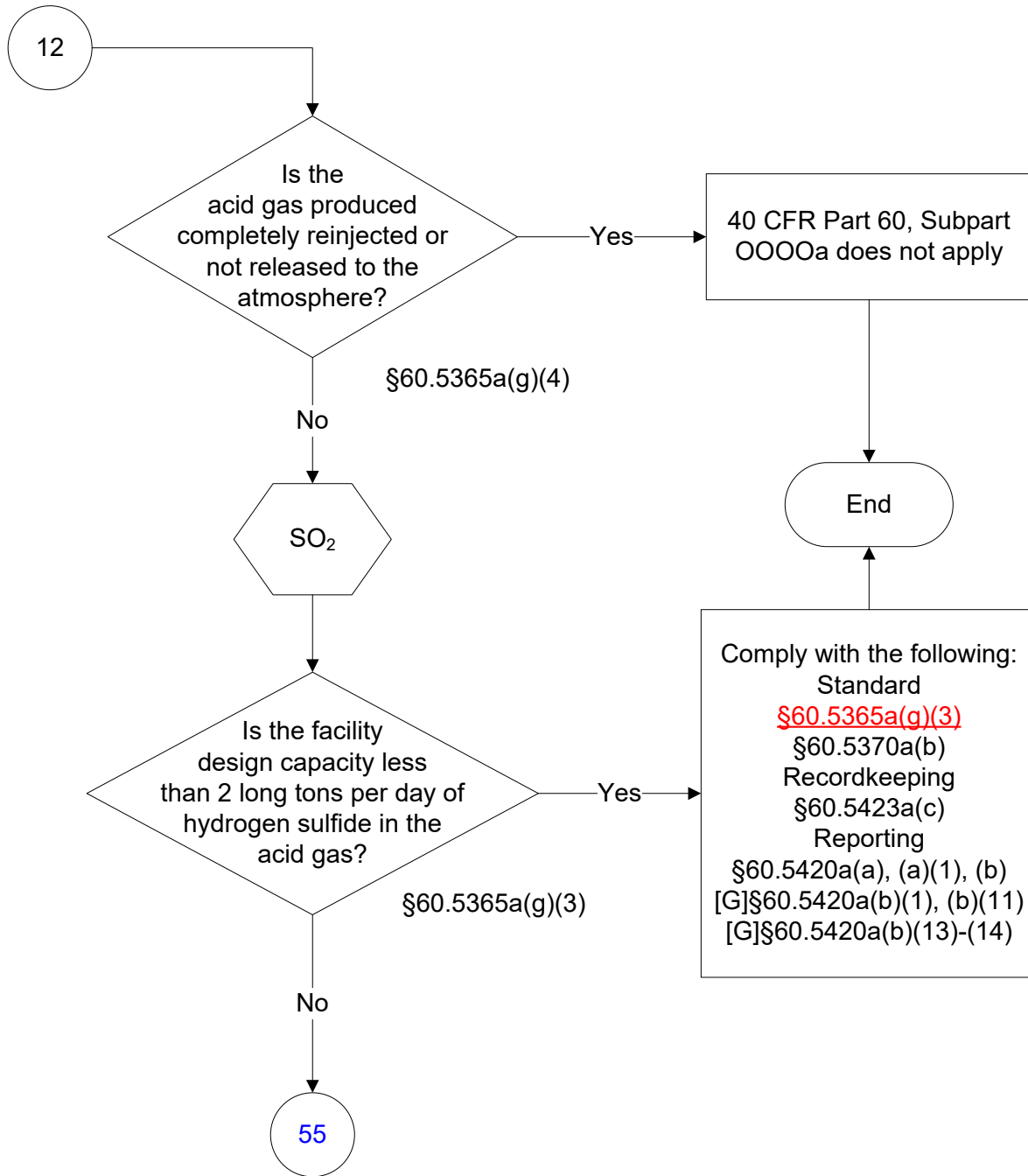

40 CFR Part 60, Subpart OOOOa
(53 of 82)

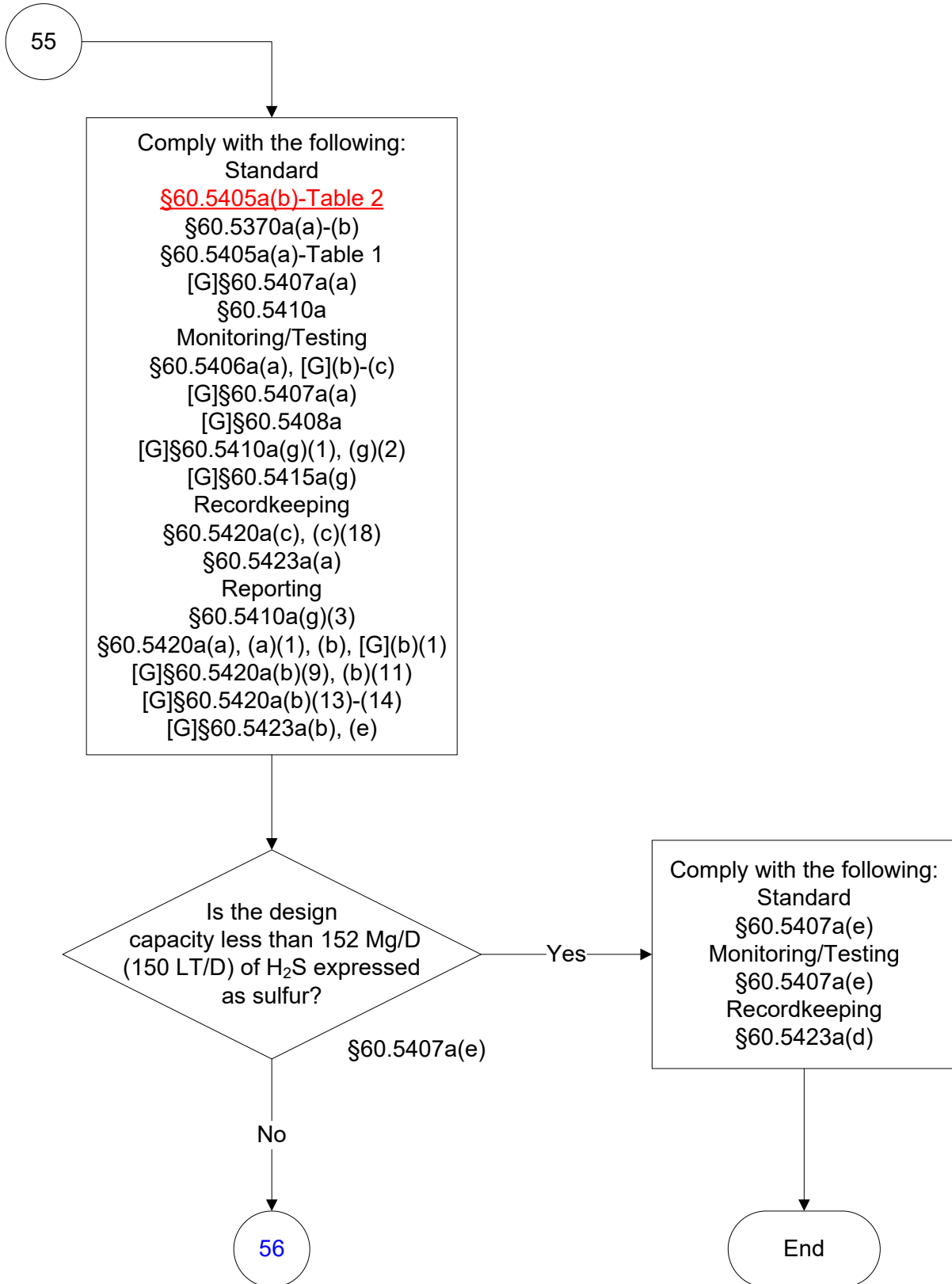

40 CFR Part 60, Subpart OOOOa
(54 of 82)

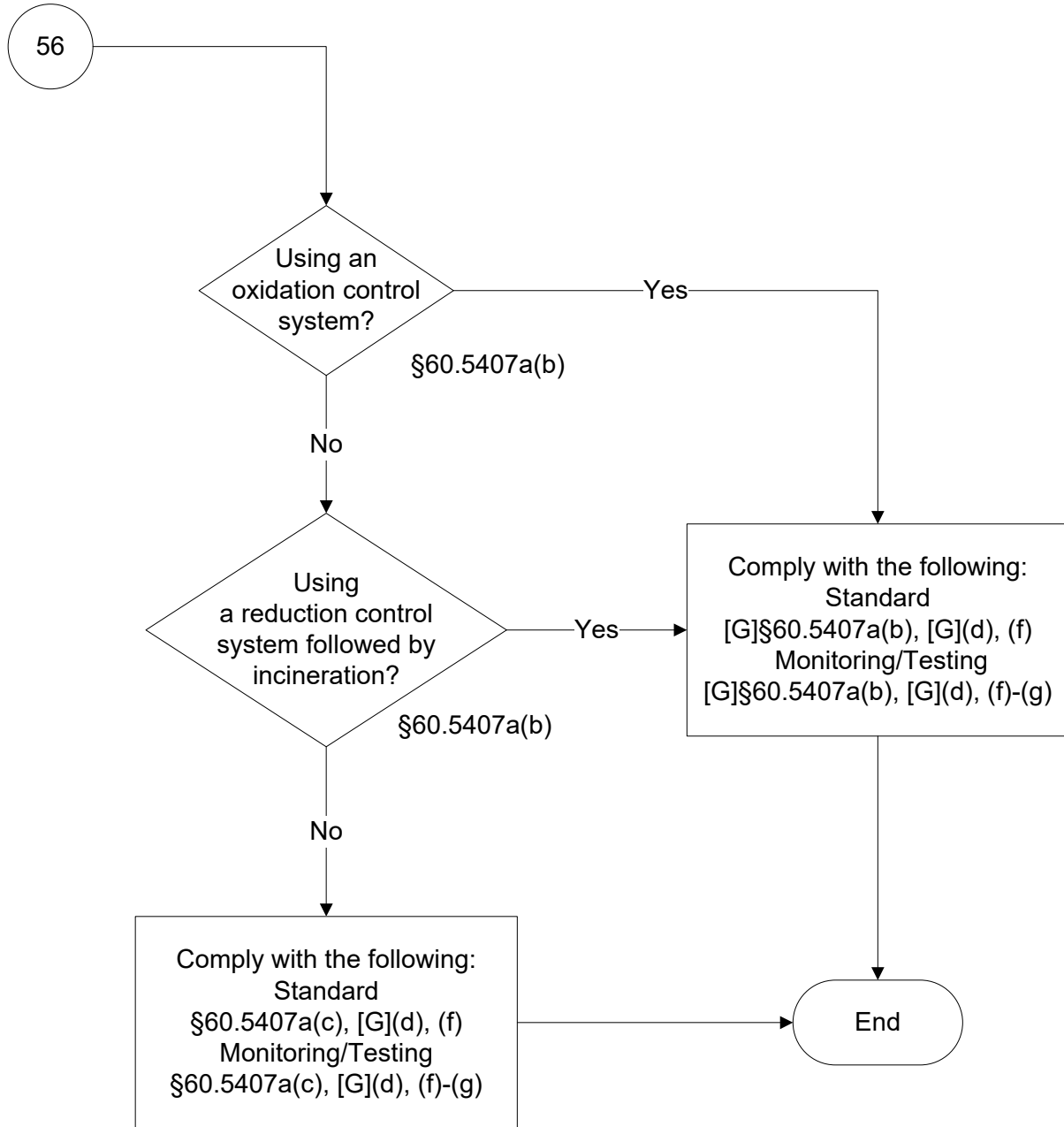

40 CFR Part 60, Subpart OOOOa

(55 of 82)

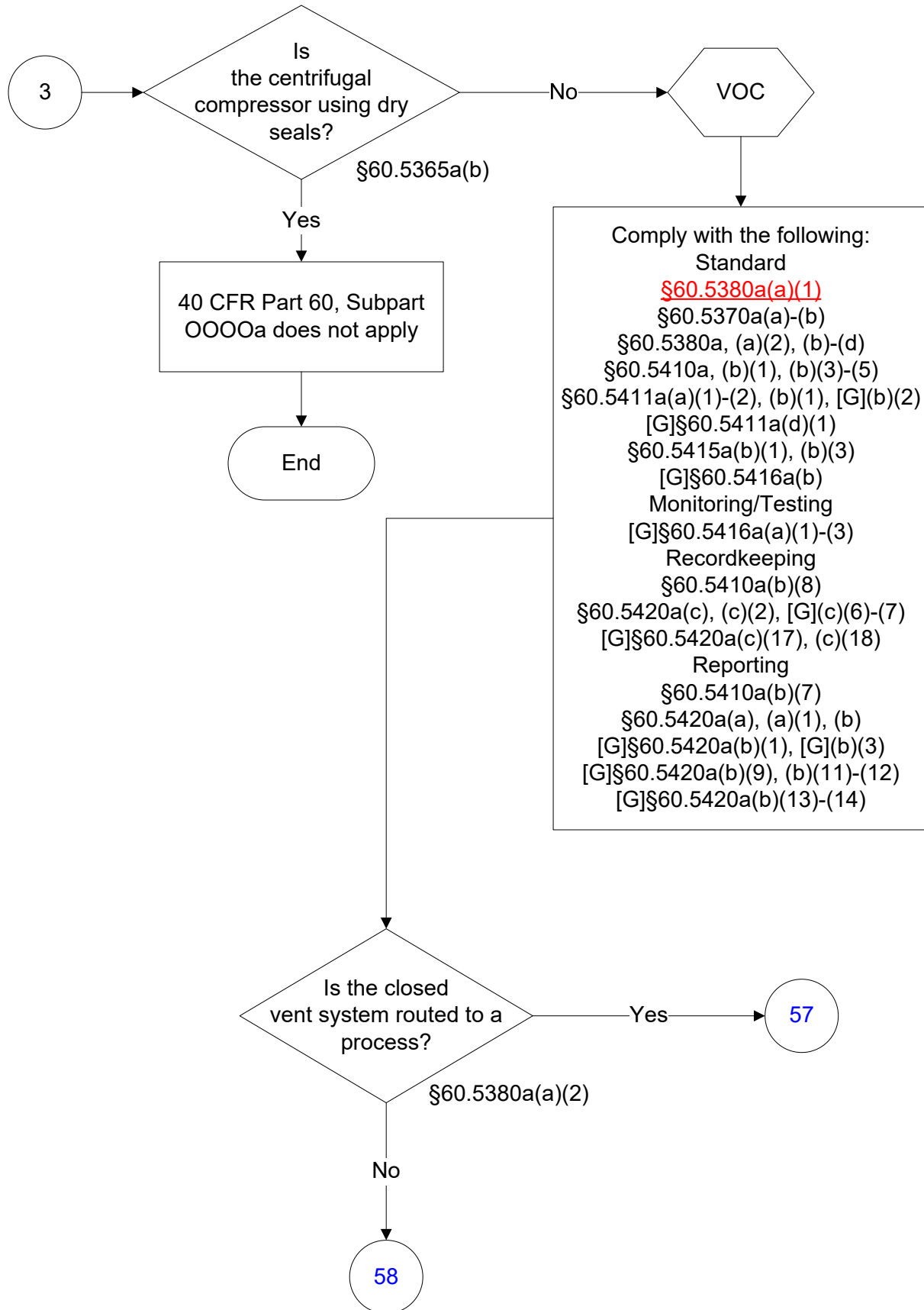

40 CFR Part 60, Subpart OOOOa
(56 of 82)

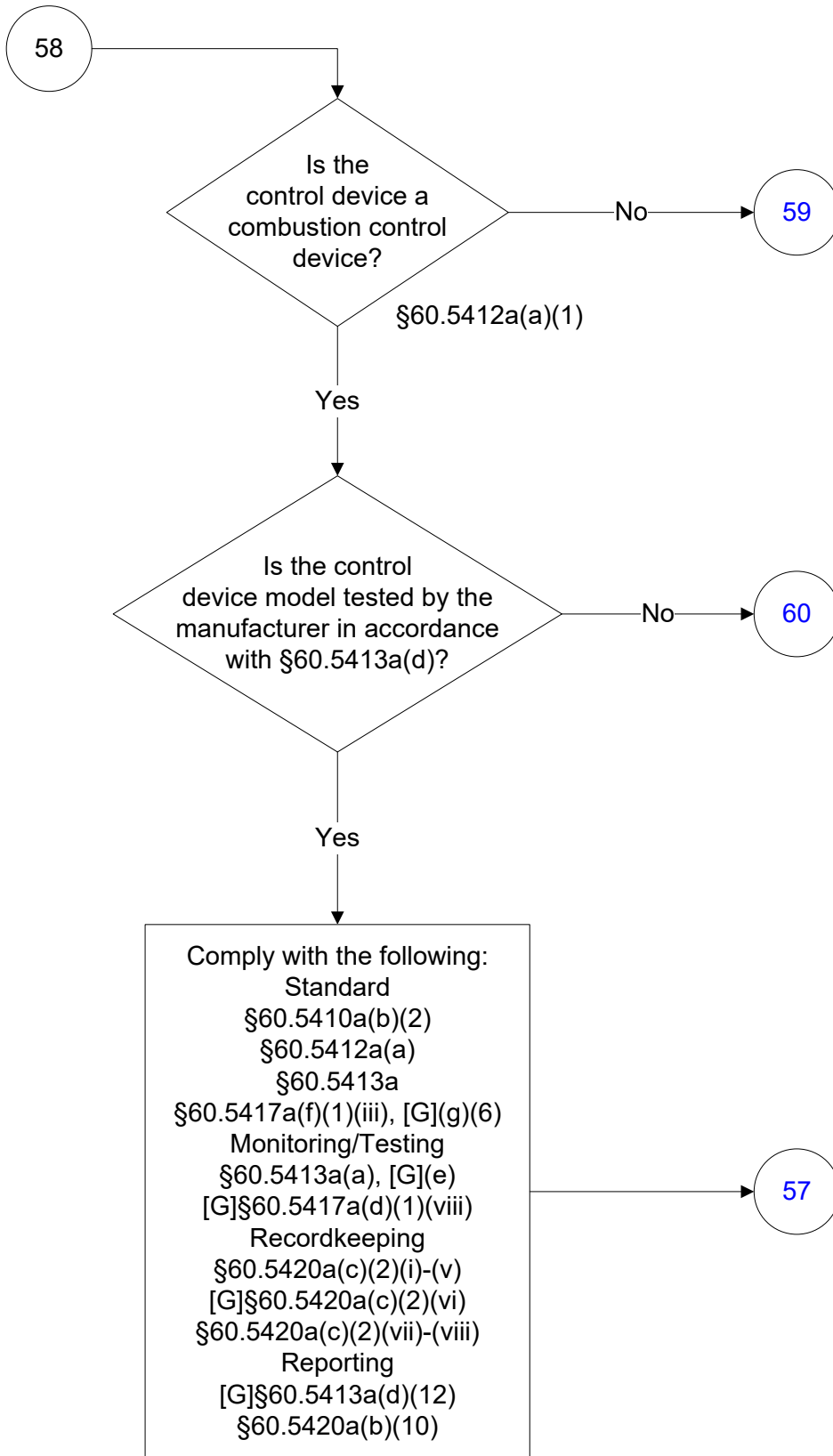

40 CFR Part 60, Subpart OOOOa
(57 of 82)

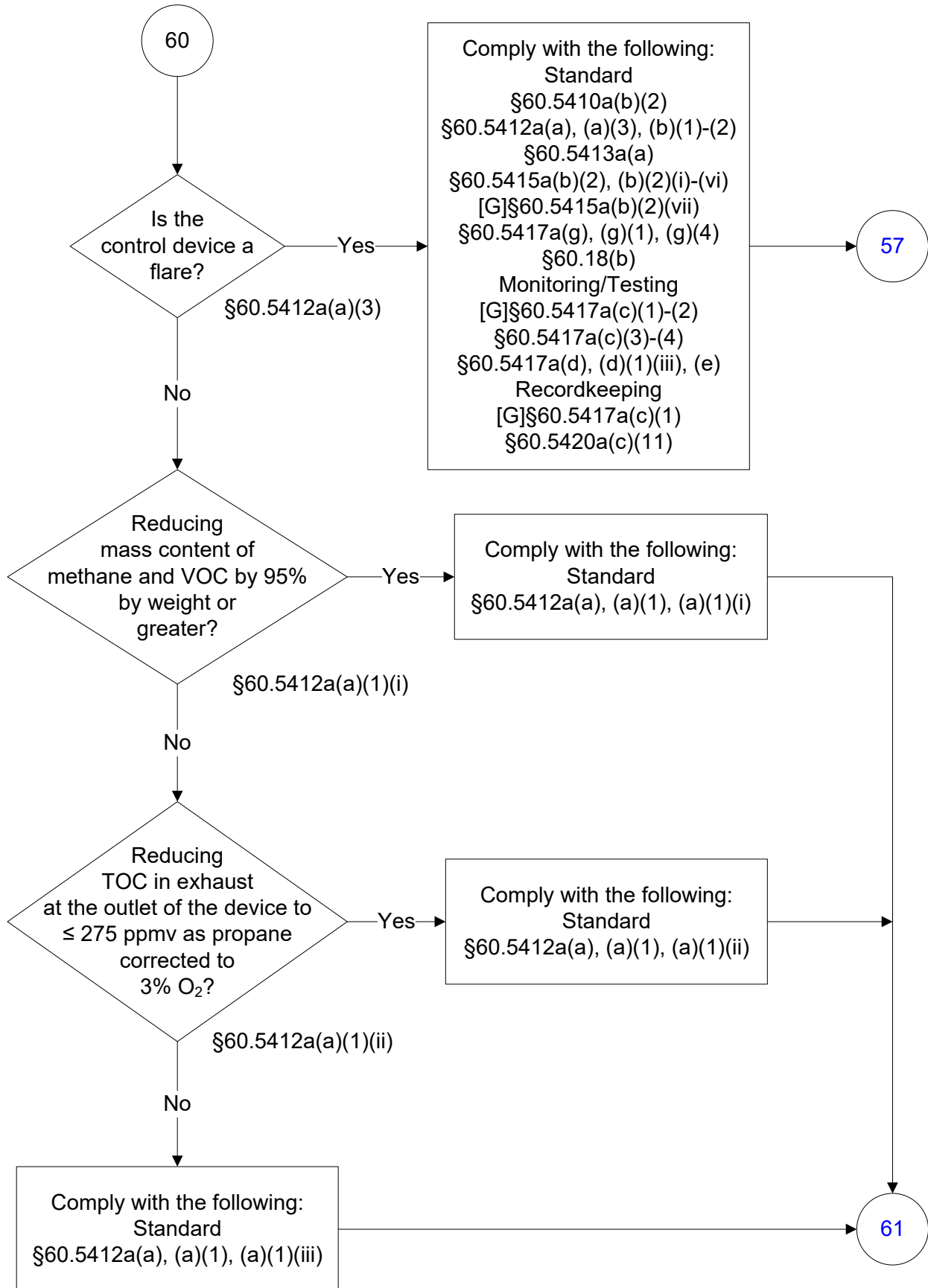

40 CFR Part 60, Subpart OOOOa
(58 of 82)

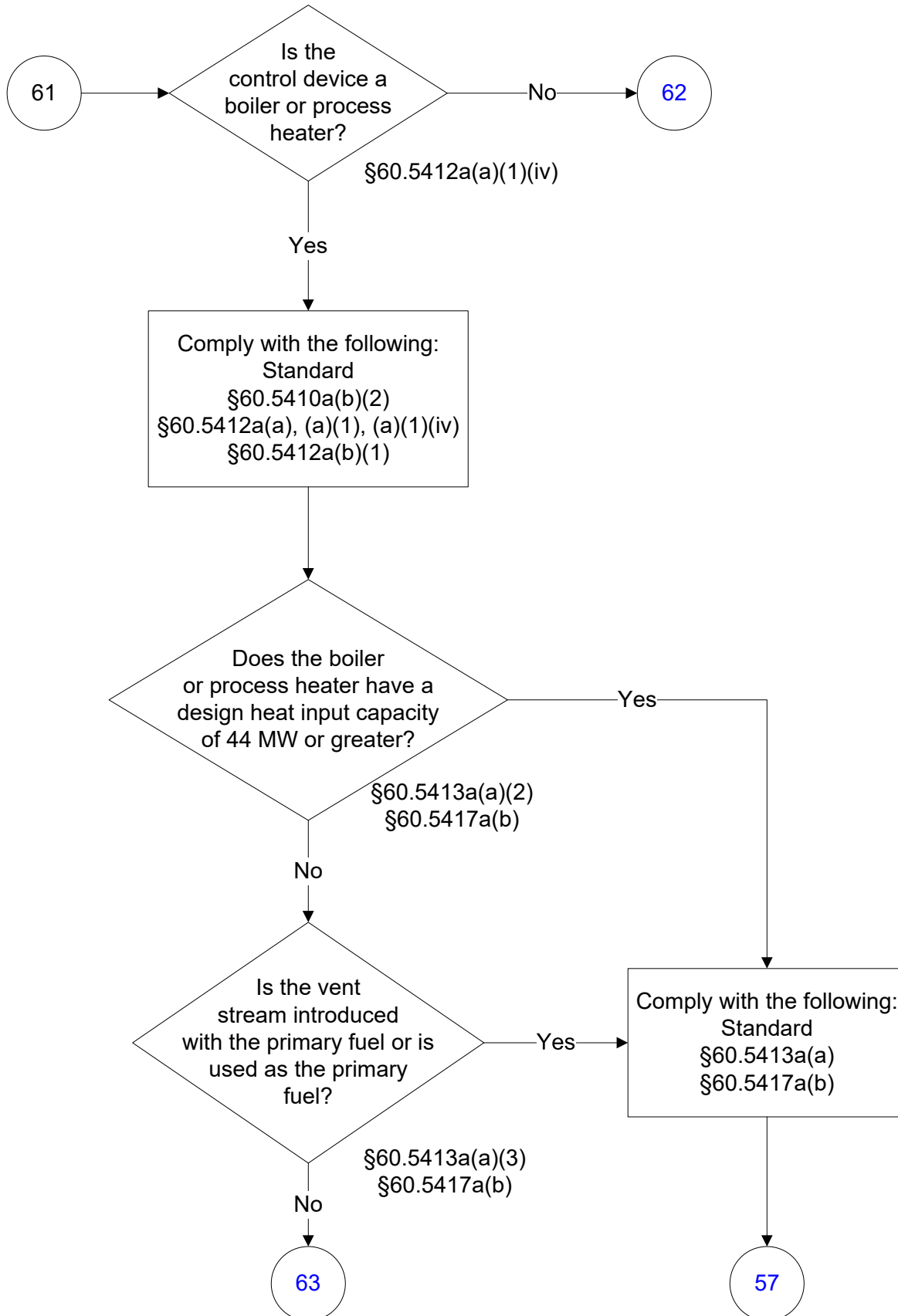

40 CFR Part 60, Subpart OOOOa

(59 of 82)

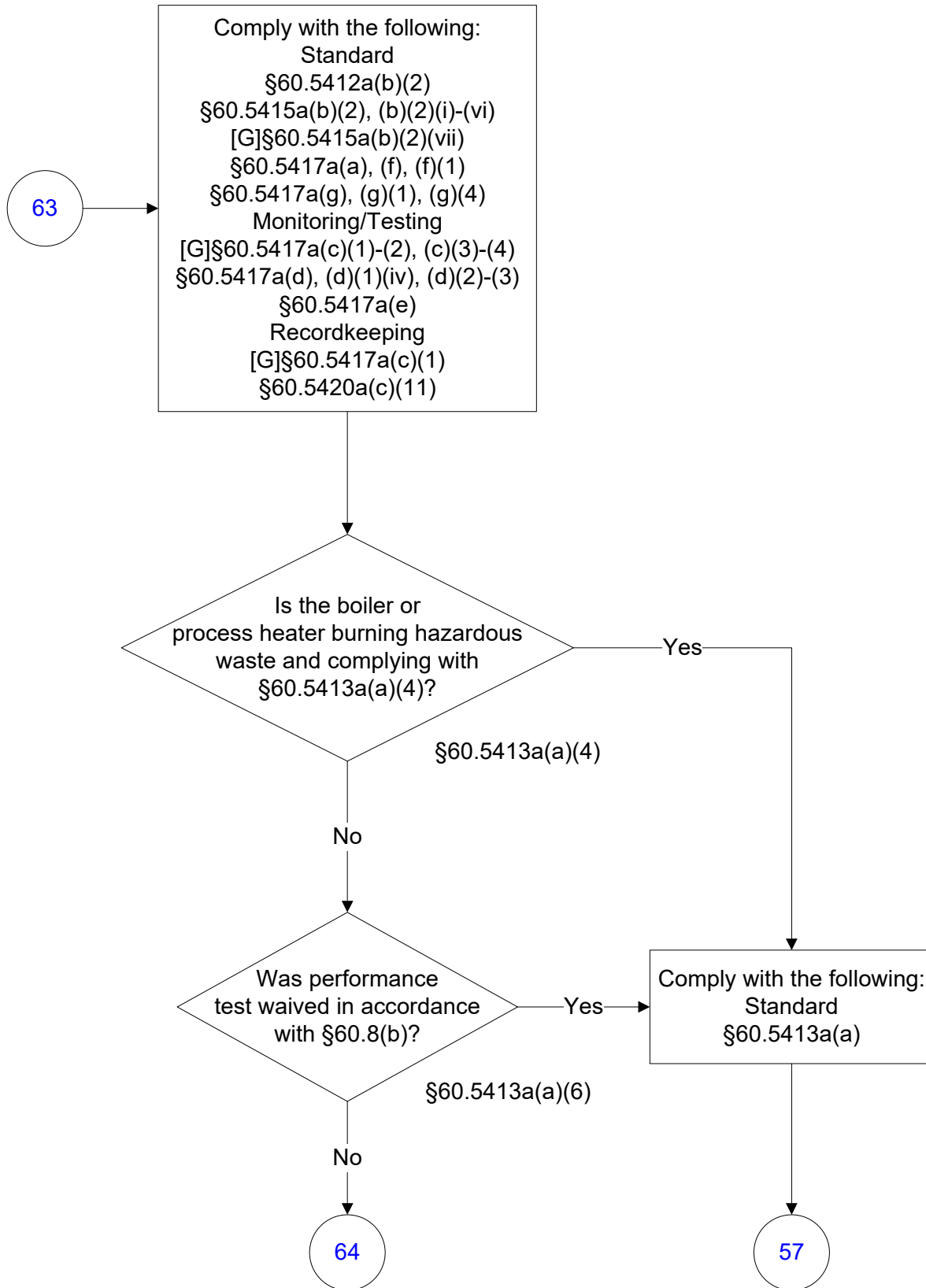

40 CFR Part 60, Subpart OOOOa
(60 of 82)

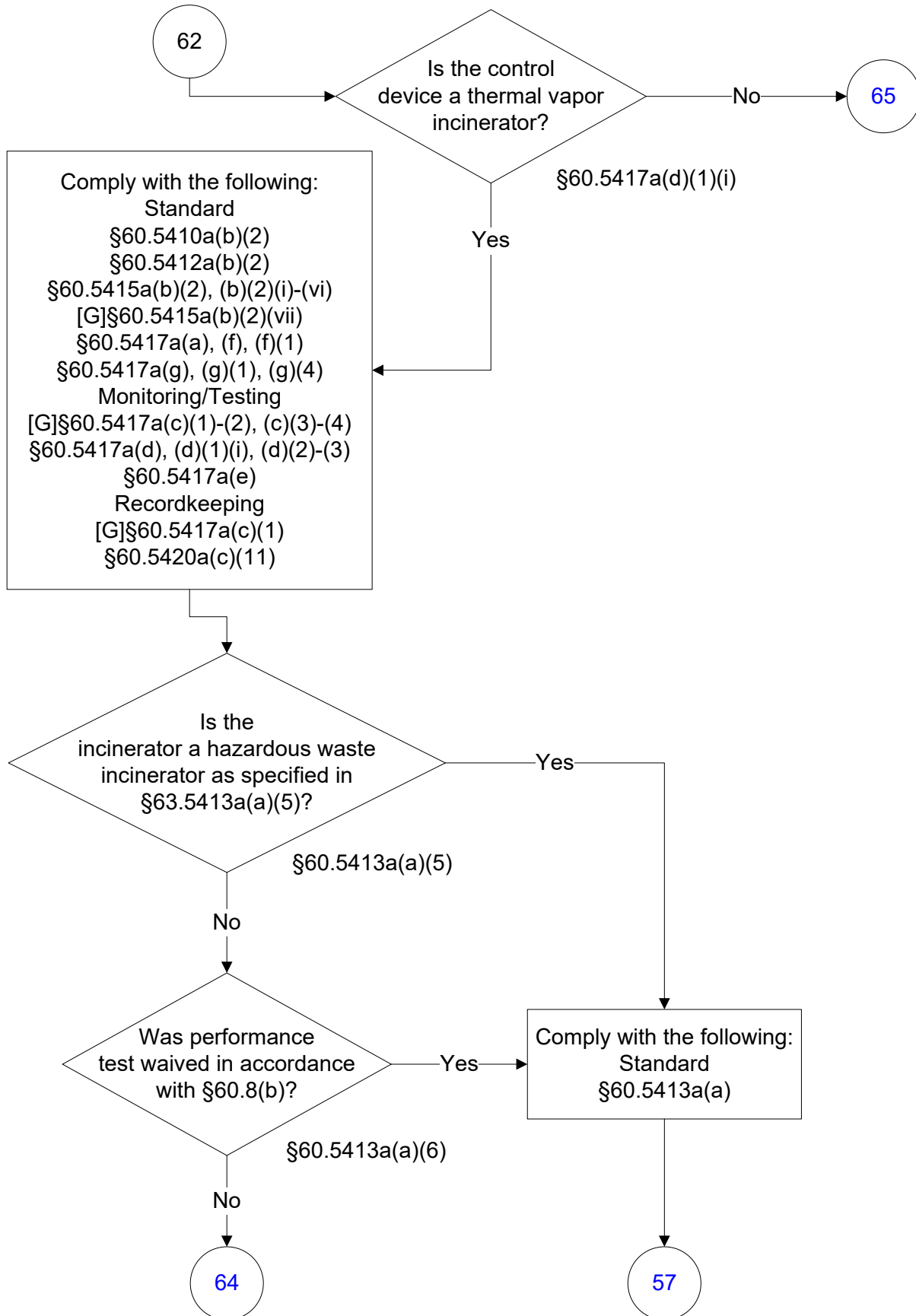

40 CFR Part 60, Subpart OOOOa
(61 of 82)

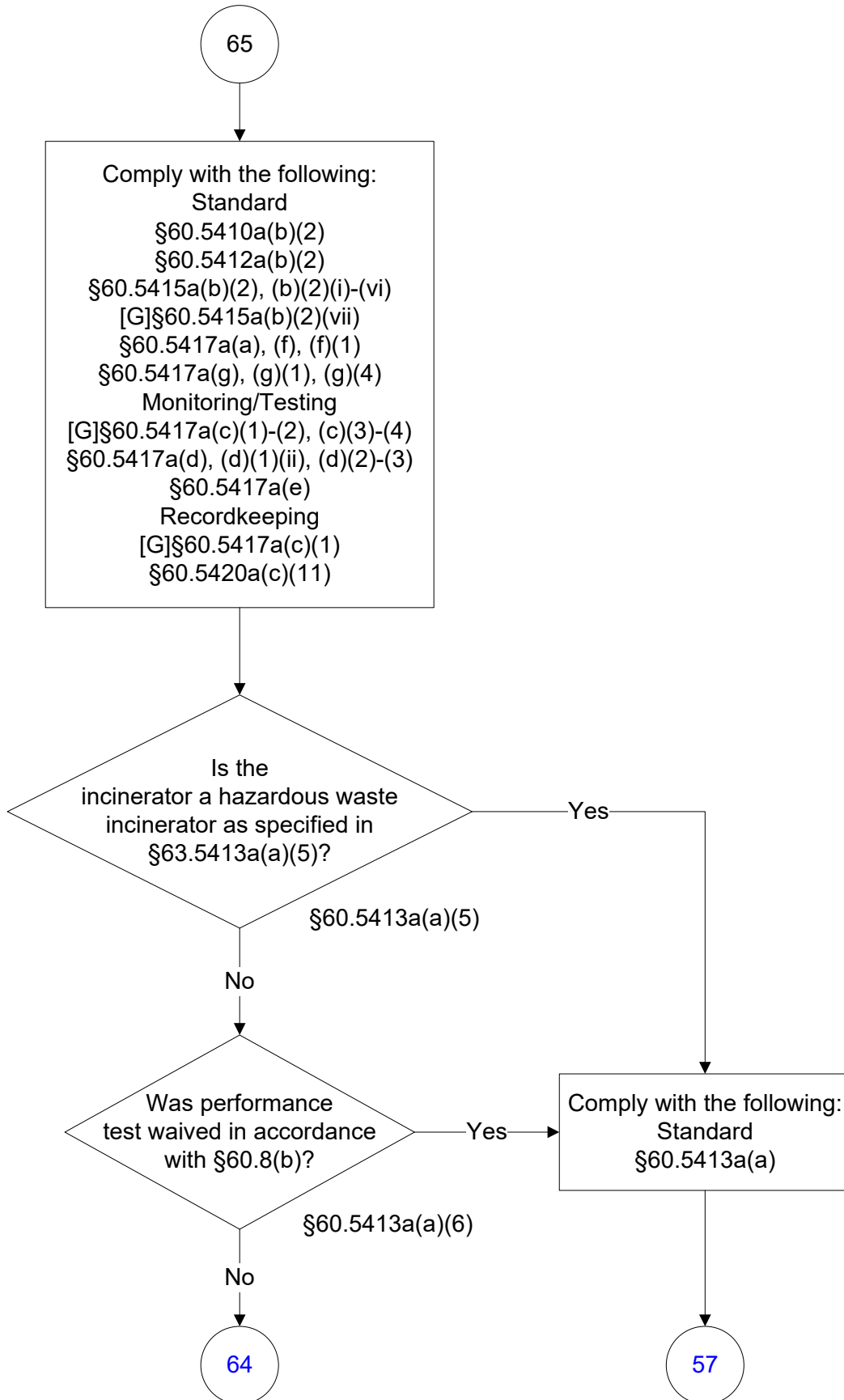

40 CFR Part 60, Subpart OOOOa
(62 of 82)

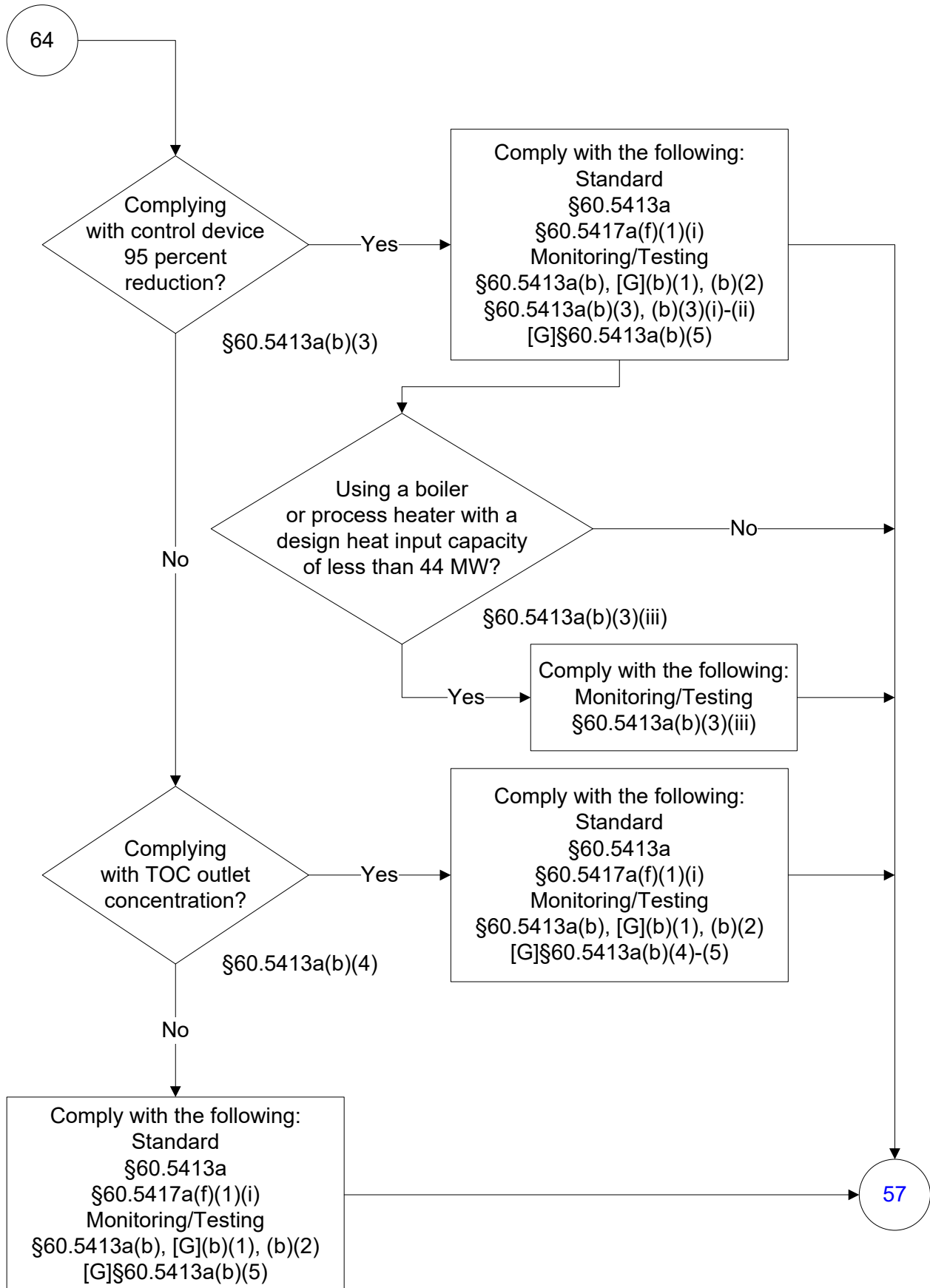

40 CFR Part 60, Subpart OOOOa
(63 of 82)

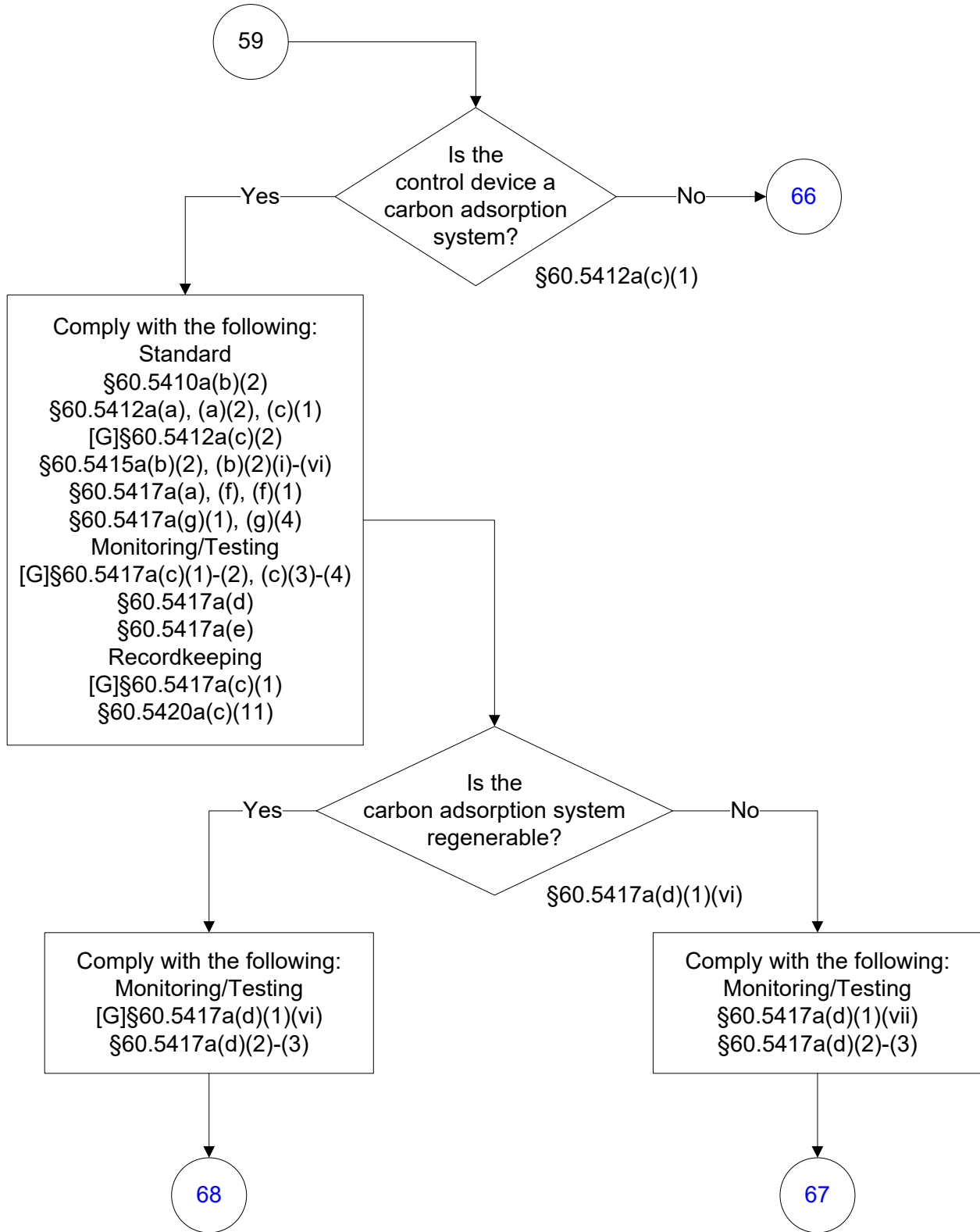

40 CFR Part 60, Subpart OOOOa
(64 of 82)

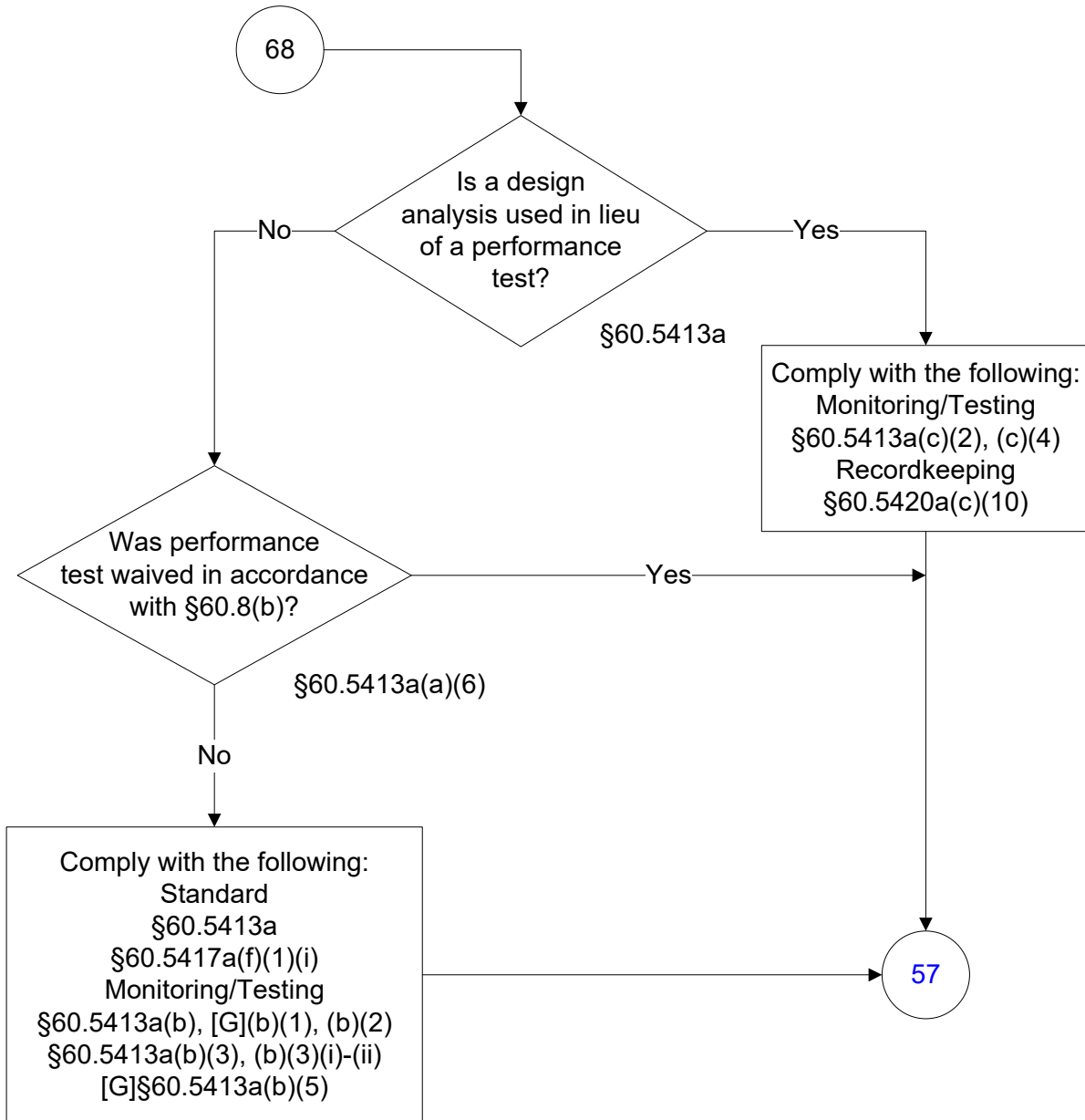

40 CFR Part 60, Subpart OOOOa
(65 of 82)

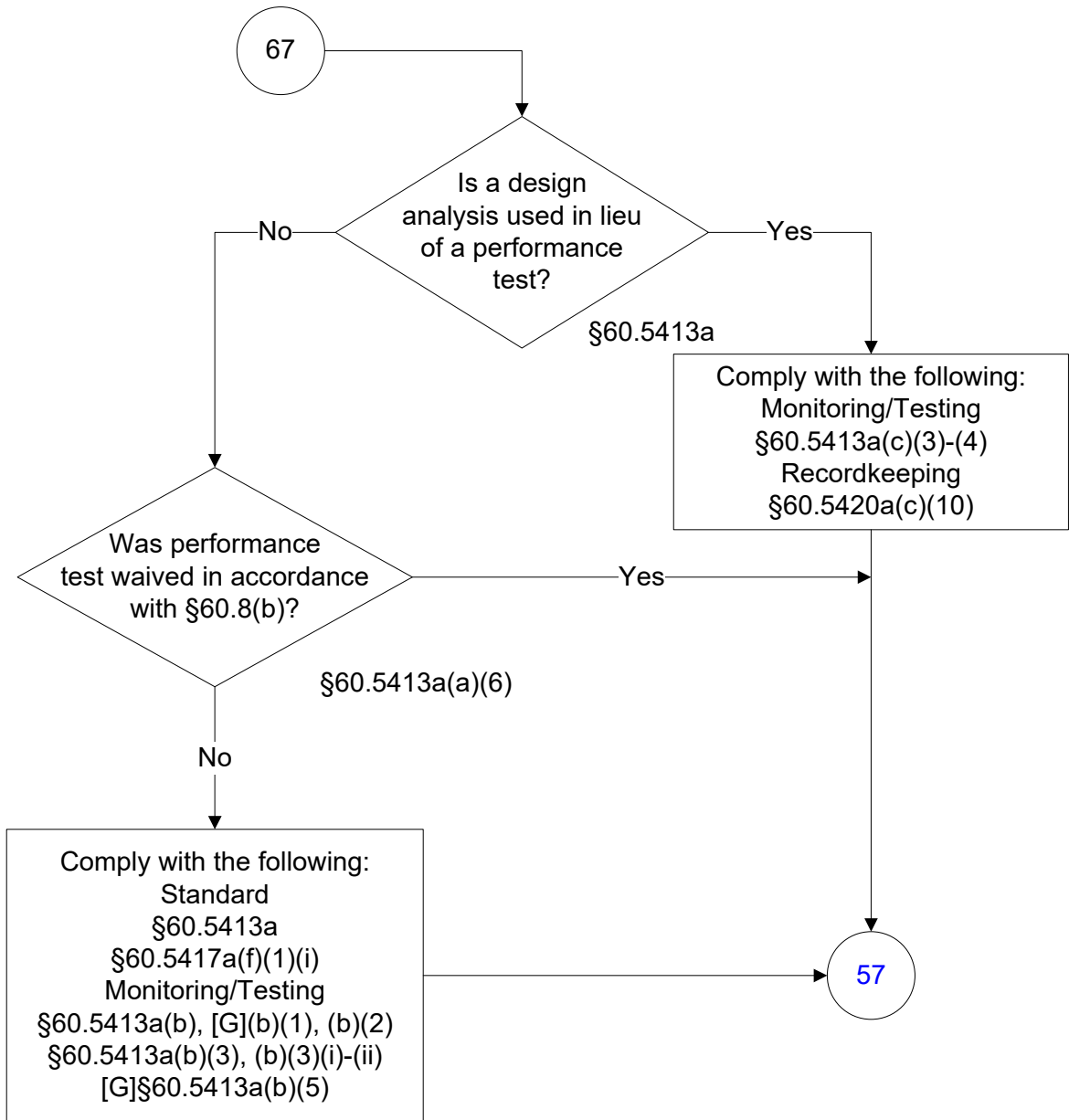

40 CFR Part 60, Subpart OOOOa
(66 of 82)

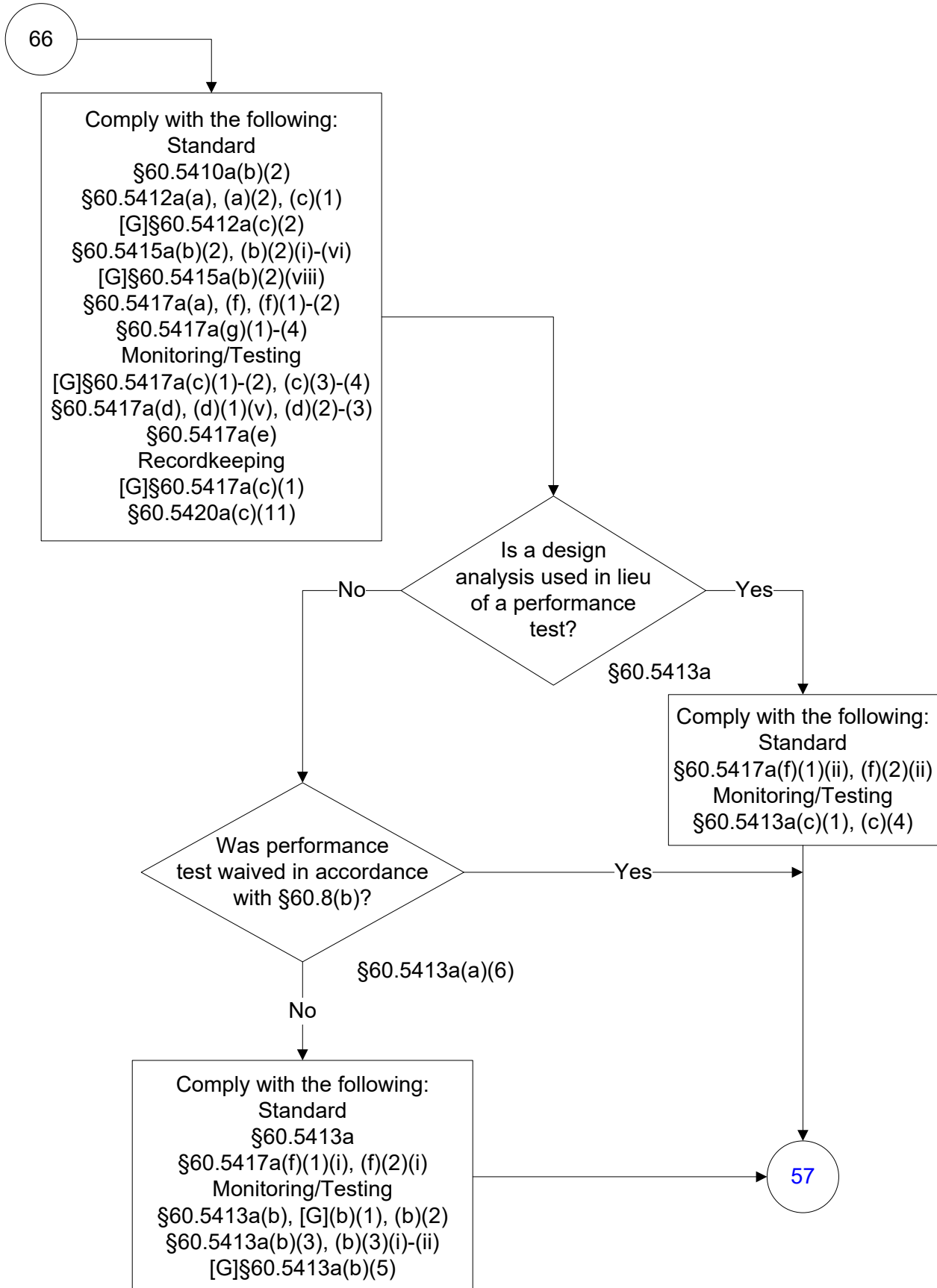

40 CFR Part 60, Subpart OOOOa
(67 of 82)

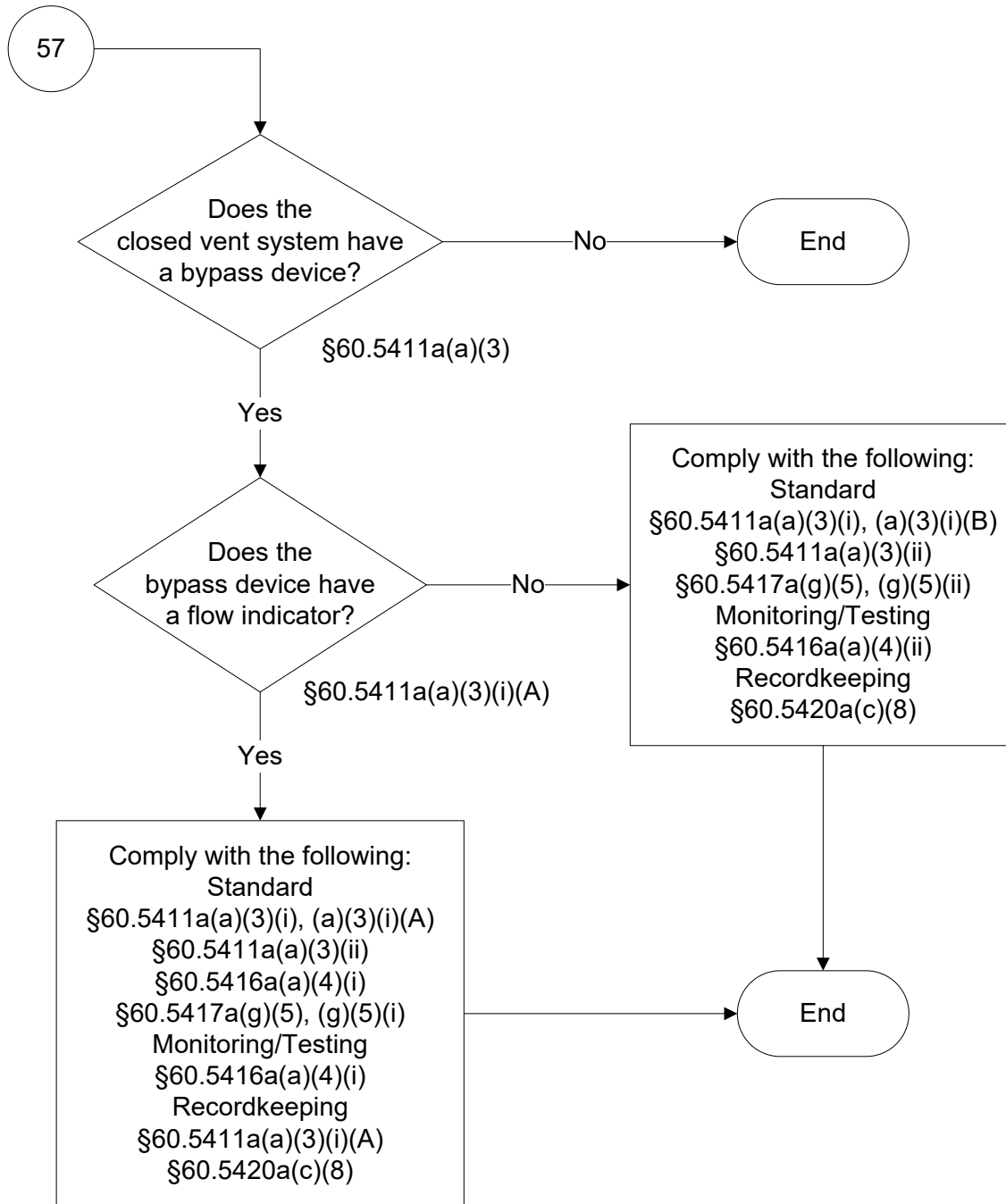

40 CFR Part 60, Subpart OOOOa
(68 of 82)

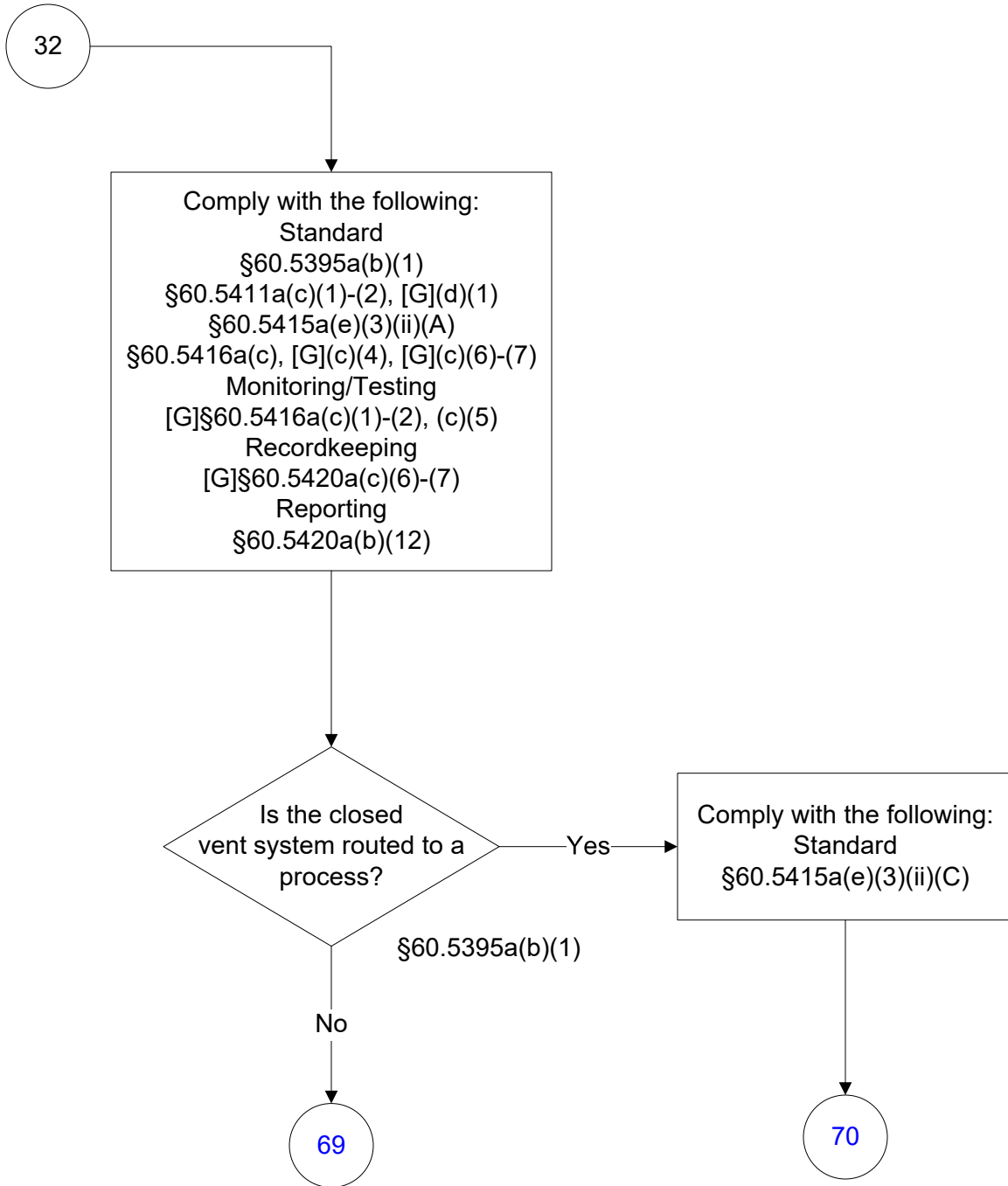

40 CFR Part 60, Subpart OOOOa
(69 of 82)

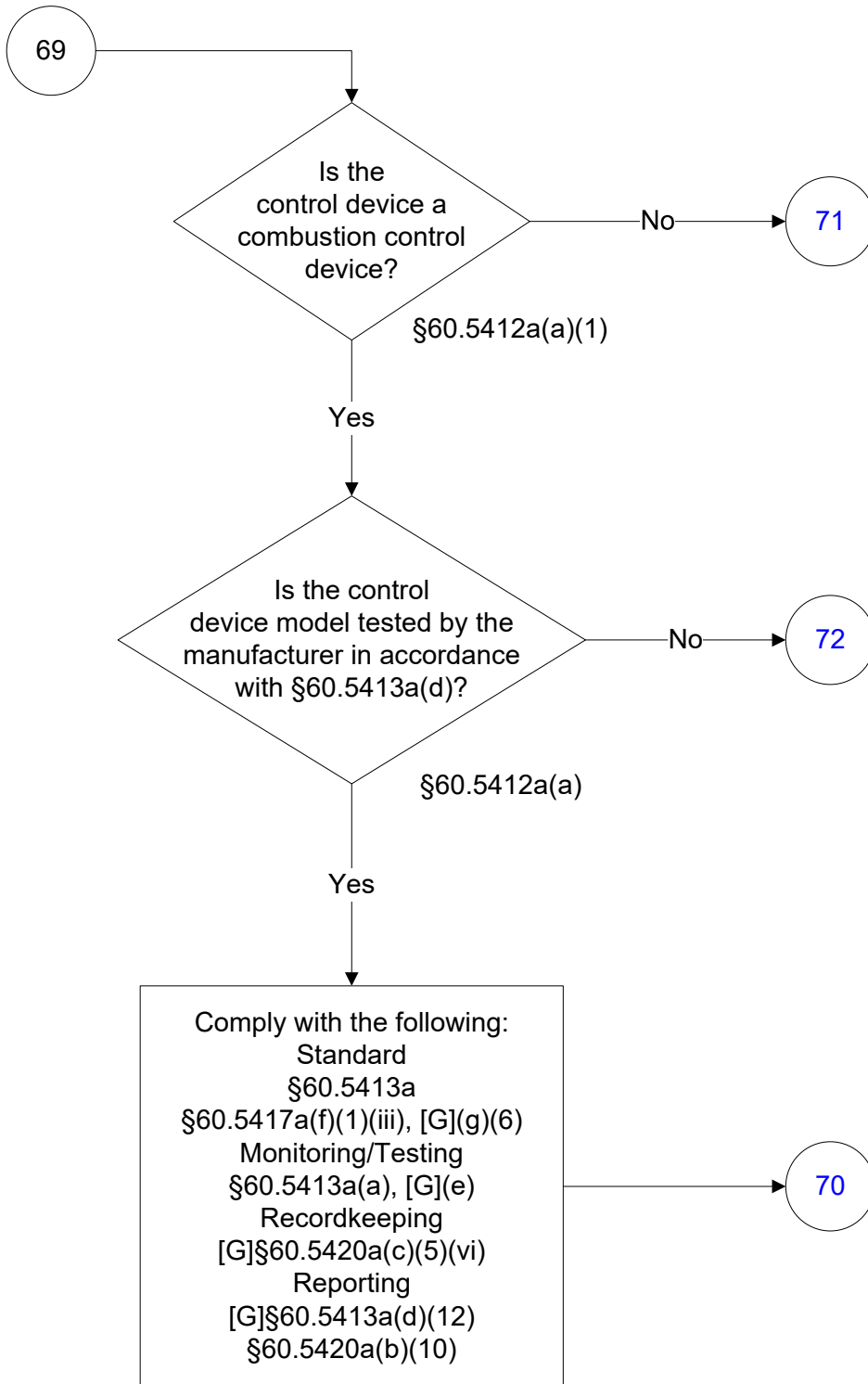

40 CFR Part 60, Subpart OOOOa
(70 of 82)

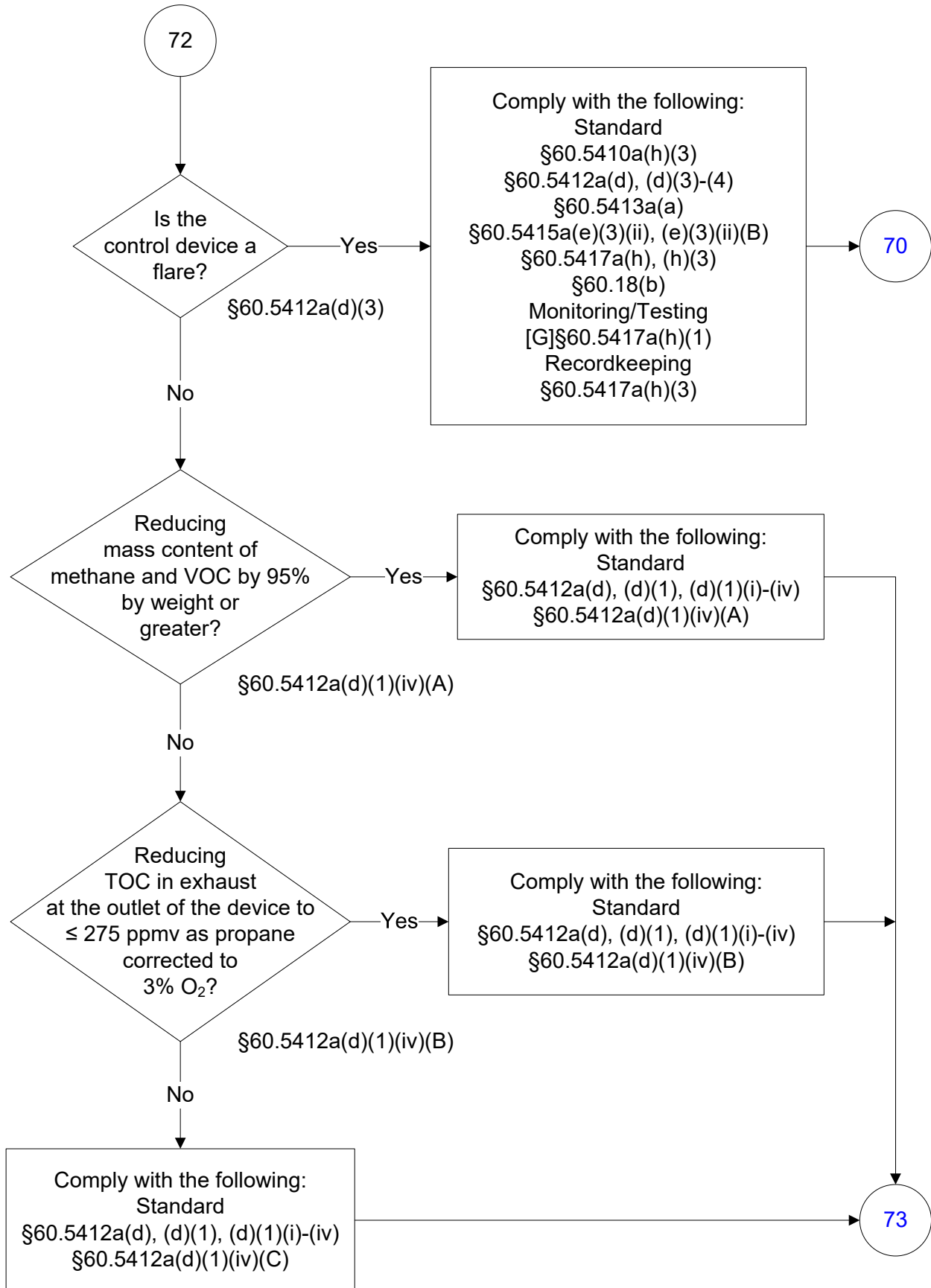

40 CFR Part 60, Subpart OOOOa
(71 of 82)

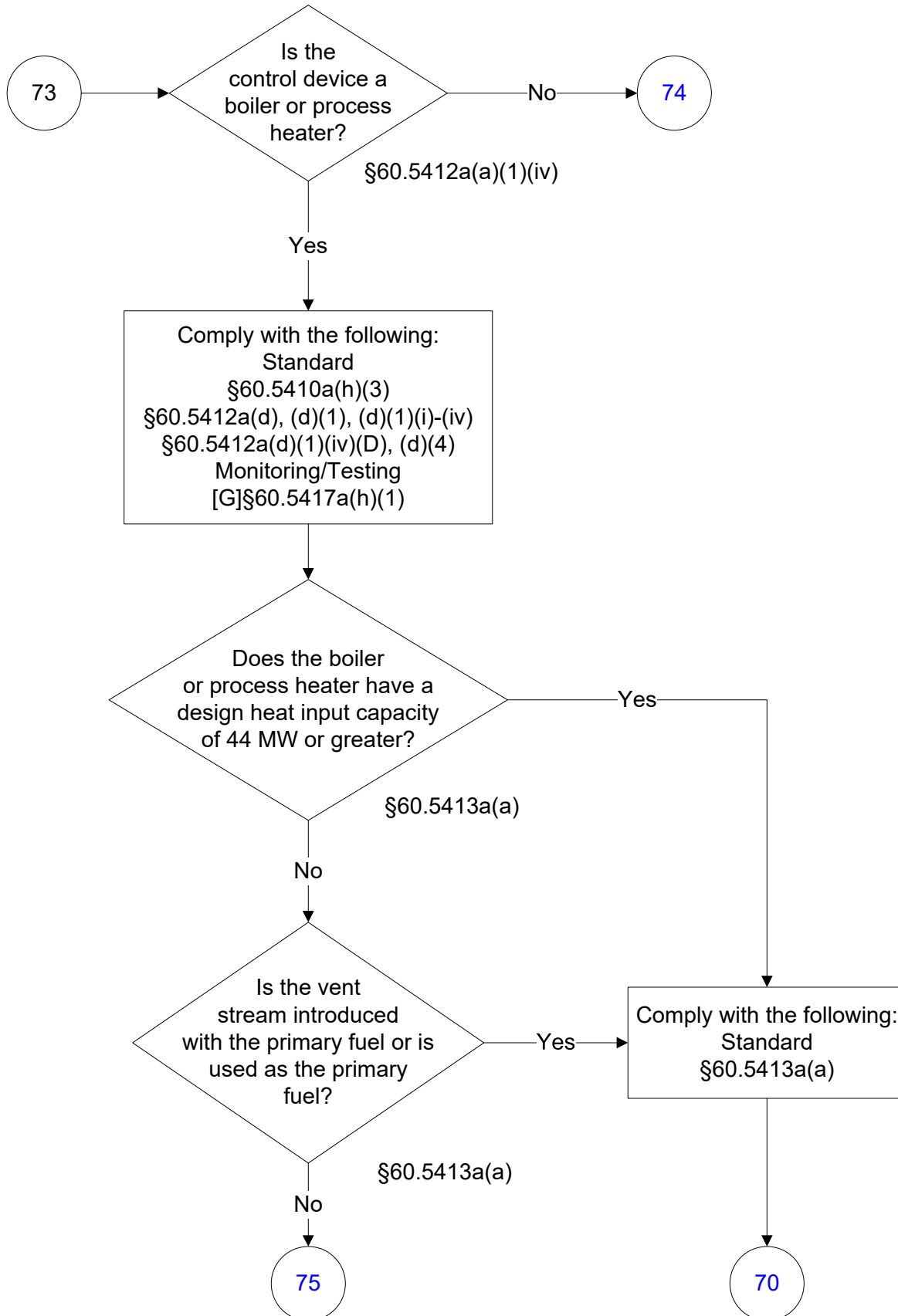

40 CFR Part 60, Subpart OOOOa
(72 of 82)

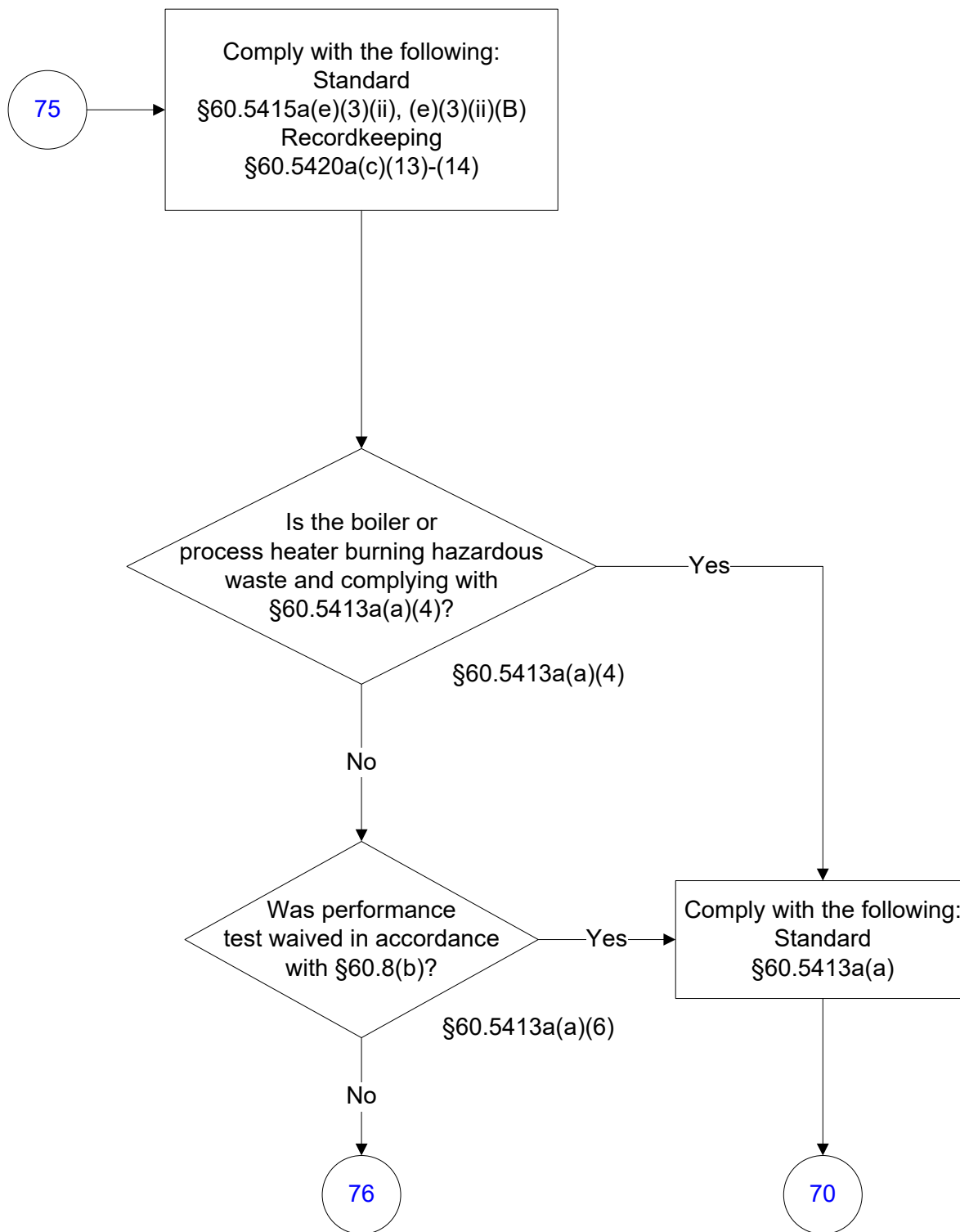

40 CFR Part 60, Subpart OOOOa
(73 of 82)

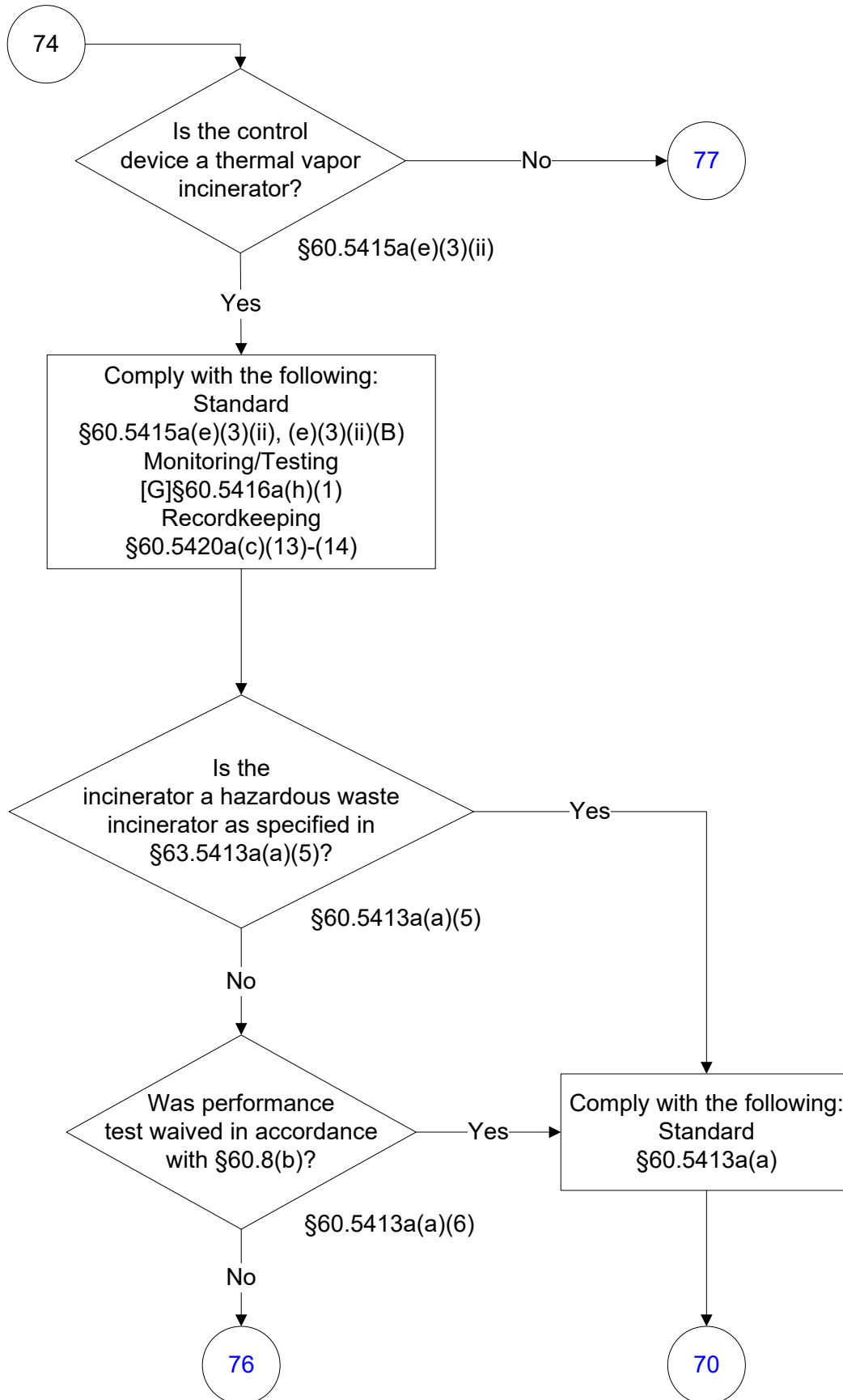

40 CFR Part 60, Subpart OOOOa
(74 of 82)

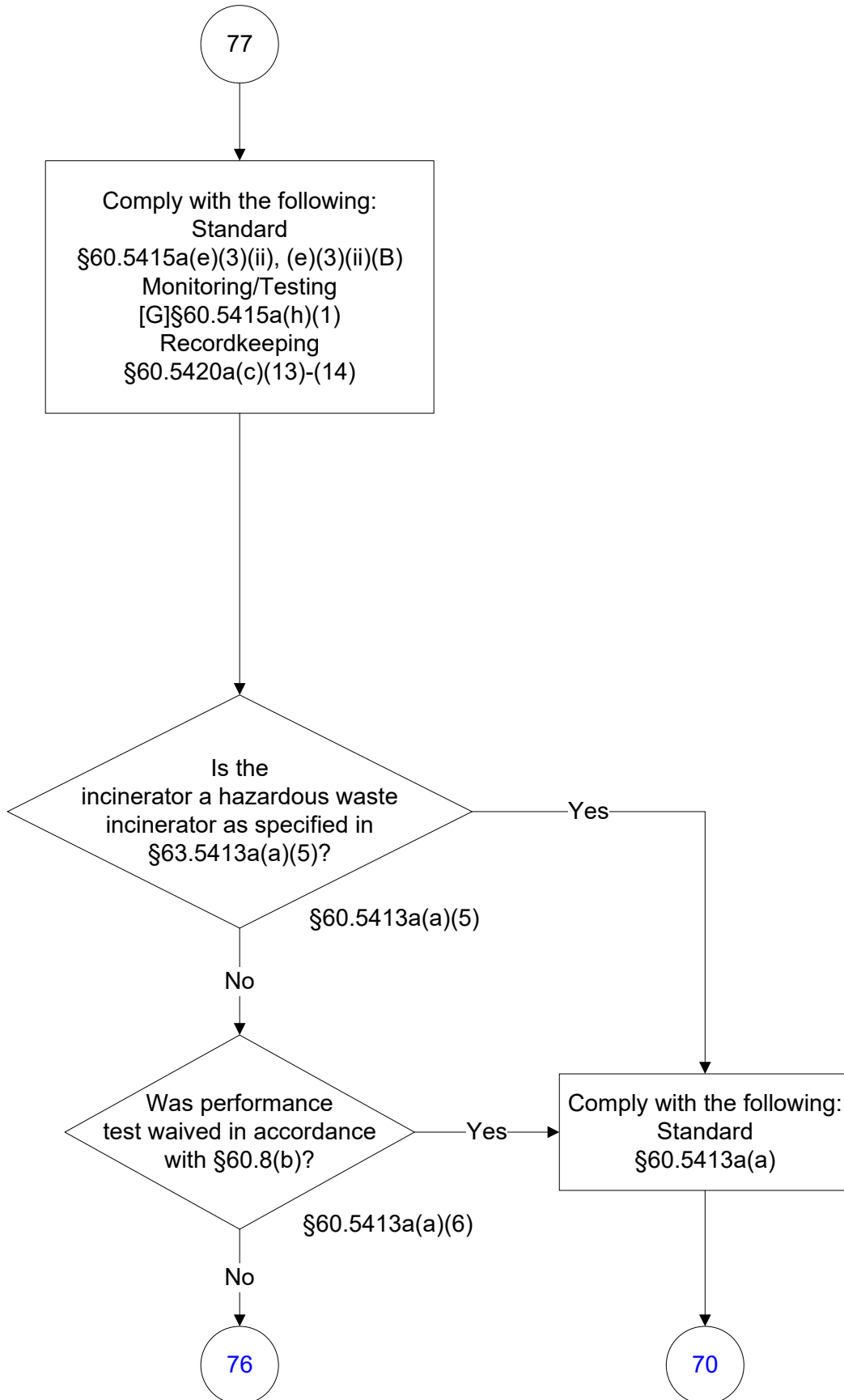

40 CFR Part 60, Subpart OOOOa
(75 of 82)

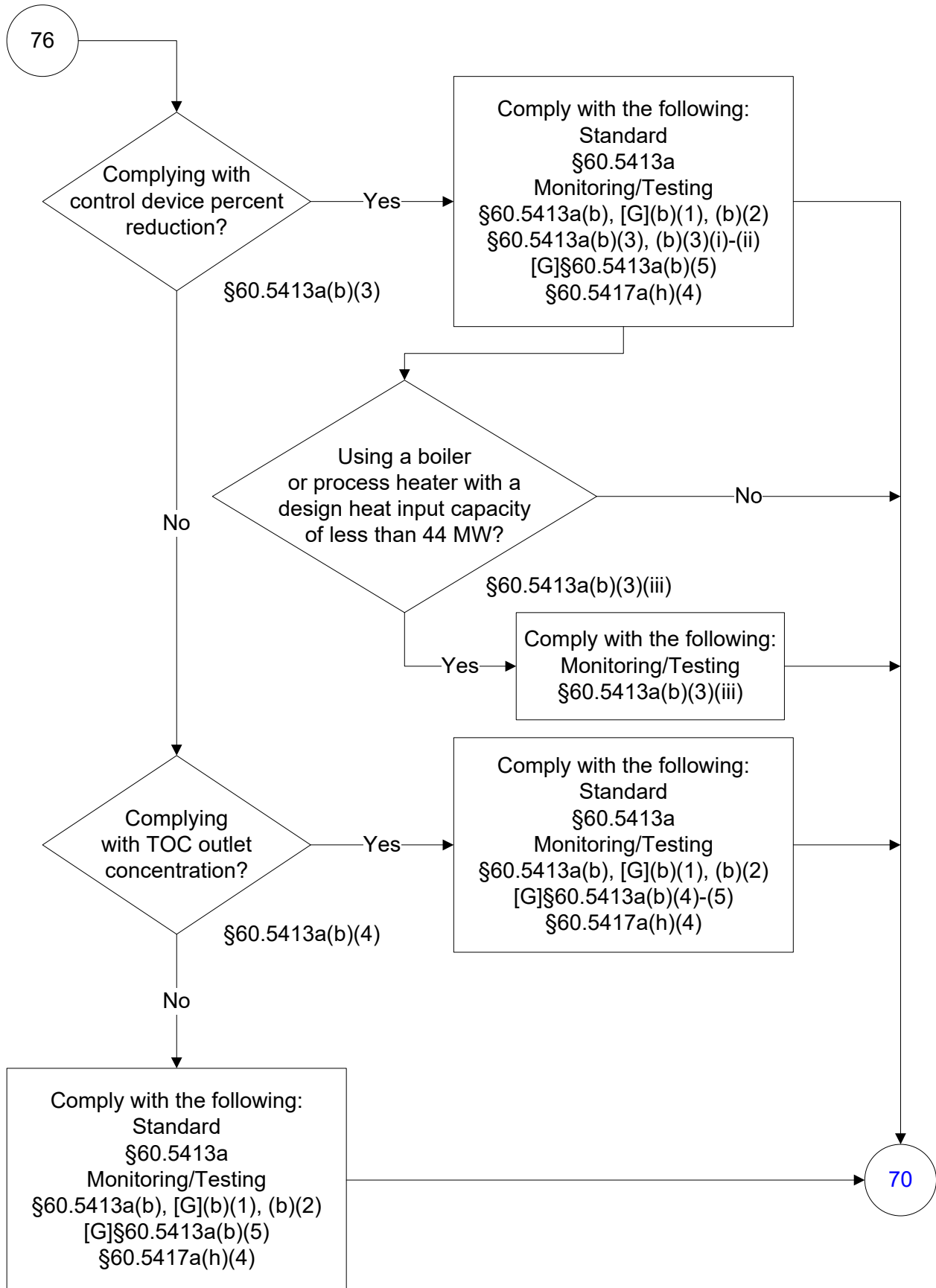

40 CFR Part 60, Subpart OOOOa
(76 of 82)

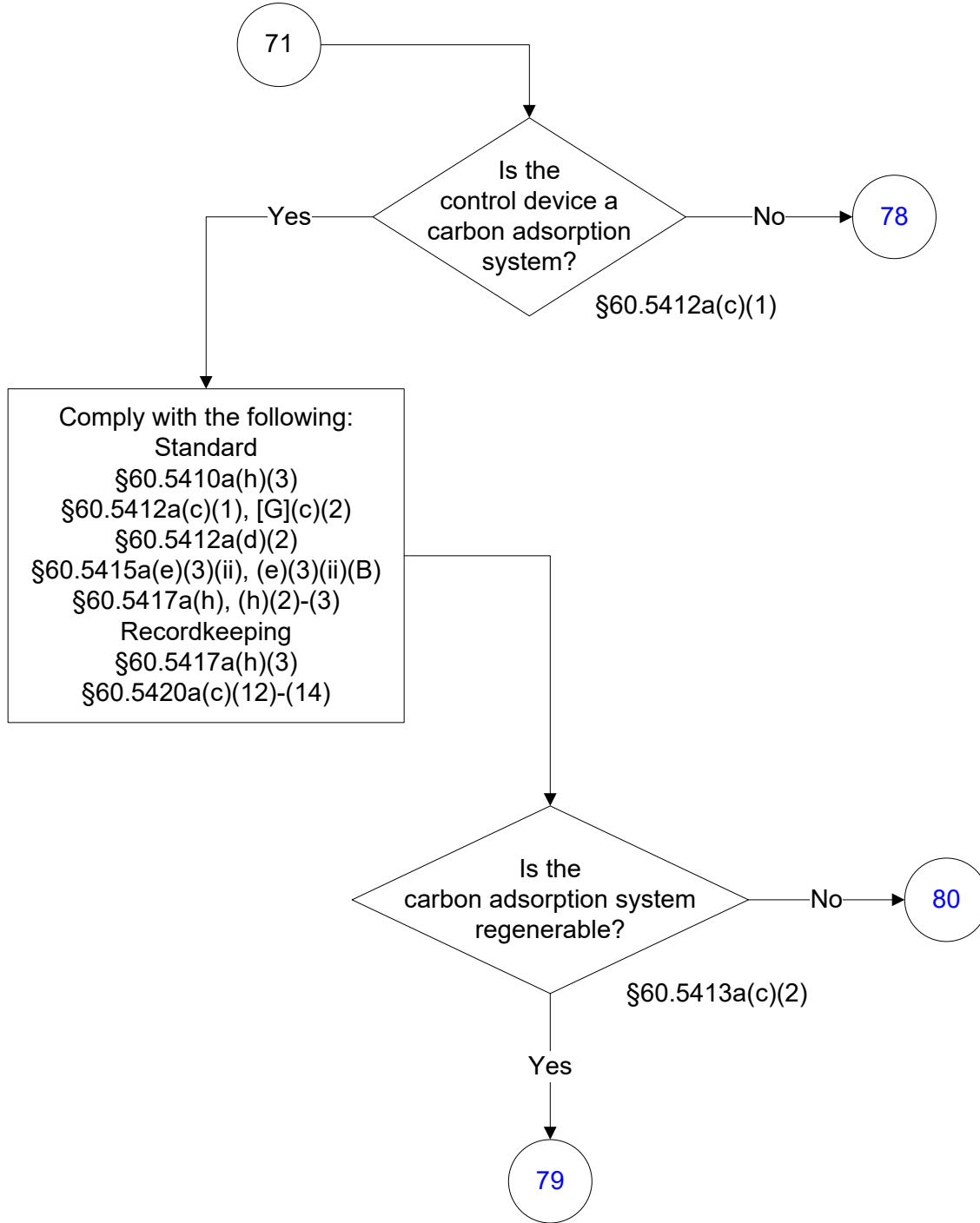

40 CFR Part 60, Subpart OOOOa
(77 of 82)

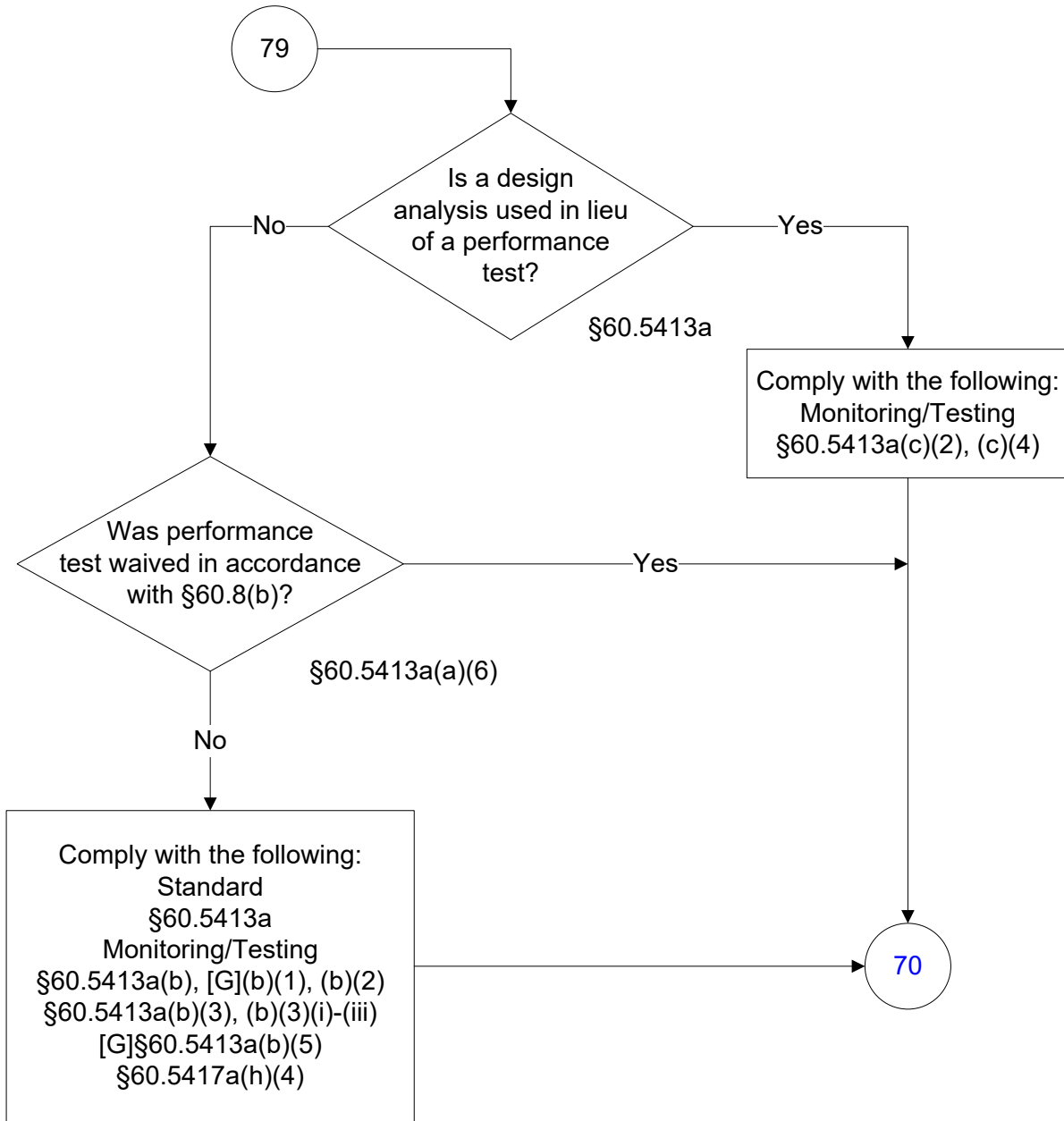

40 CFR Part 60, Subpart OOOOa
(78 of 82)

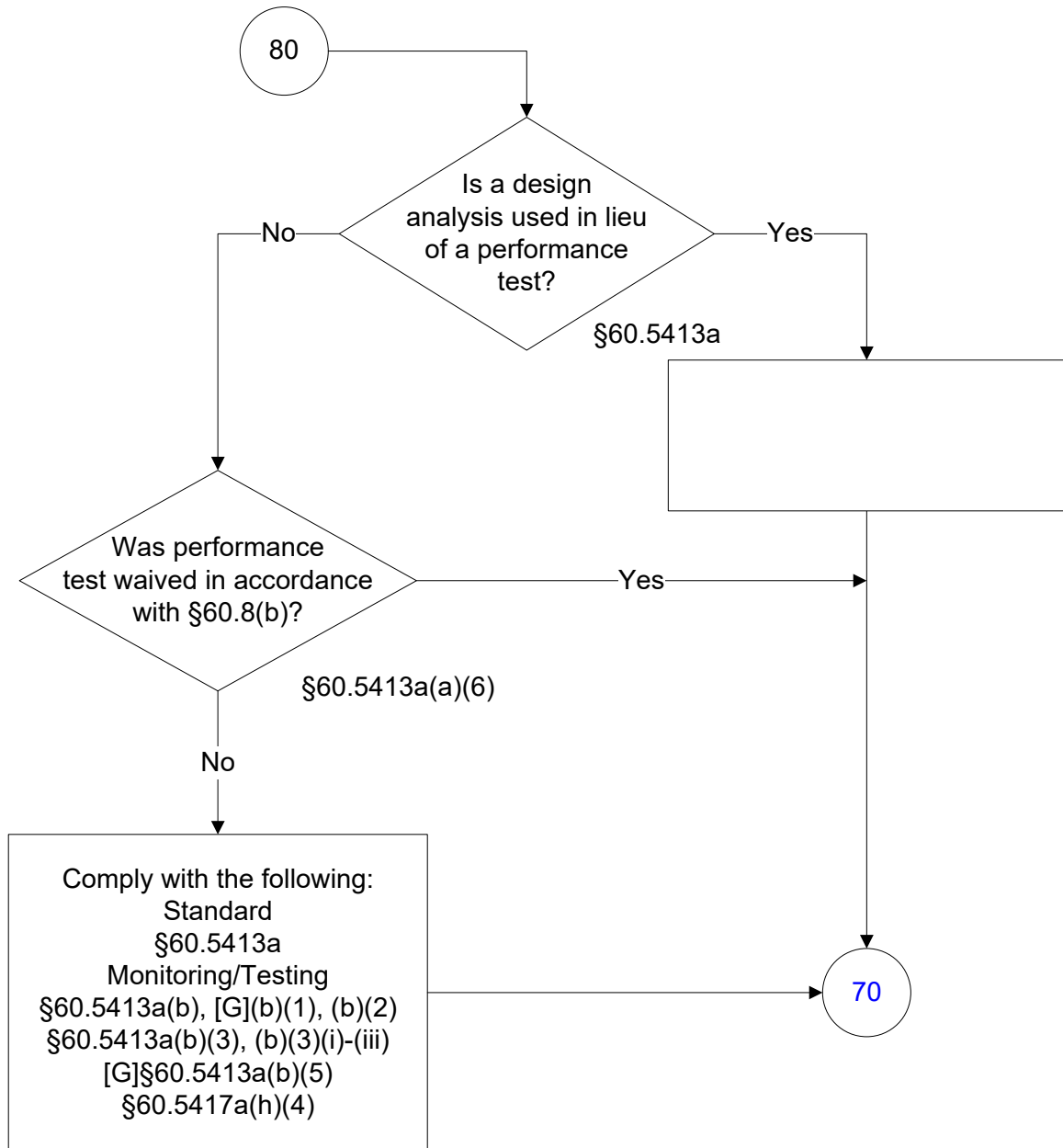

40 CFR Part 60, Subpart OOOOa
(79 of 82)

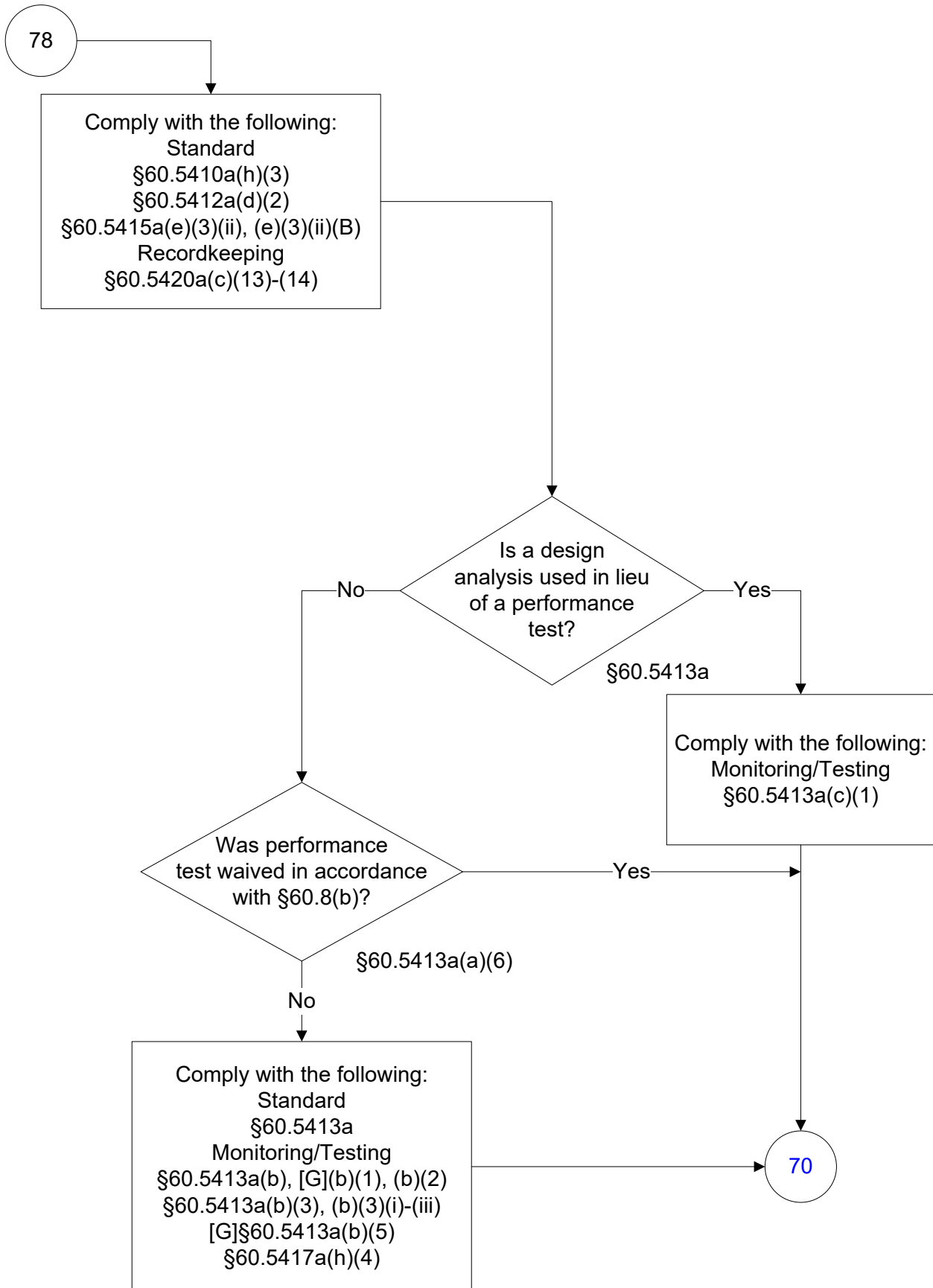

40 CFR Part 60, Subpart OOOOa
(80 of 82)

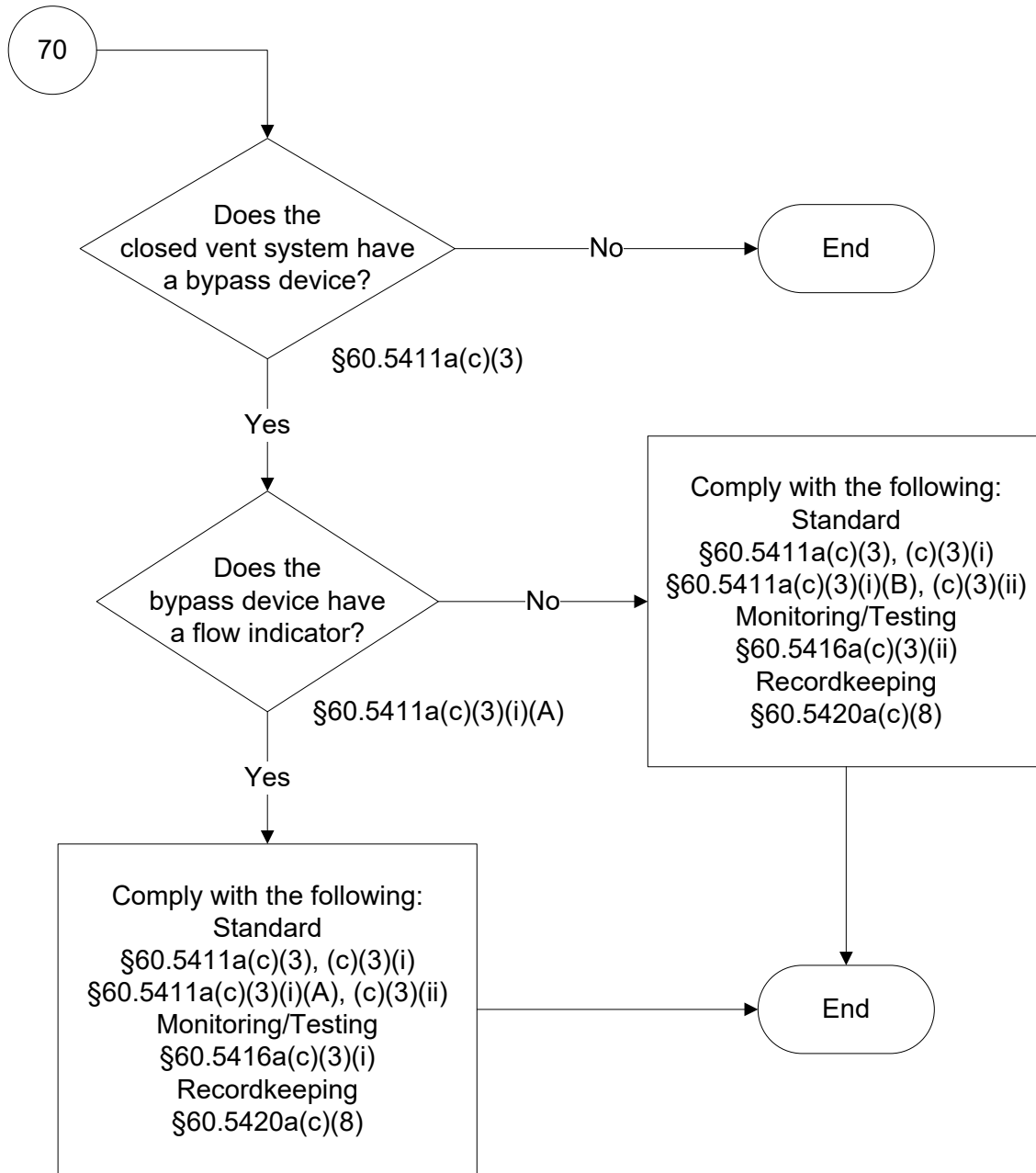

40 CFR Part 60, Subpart OOOOa
(81 of 82)

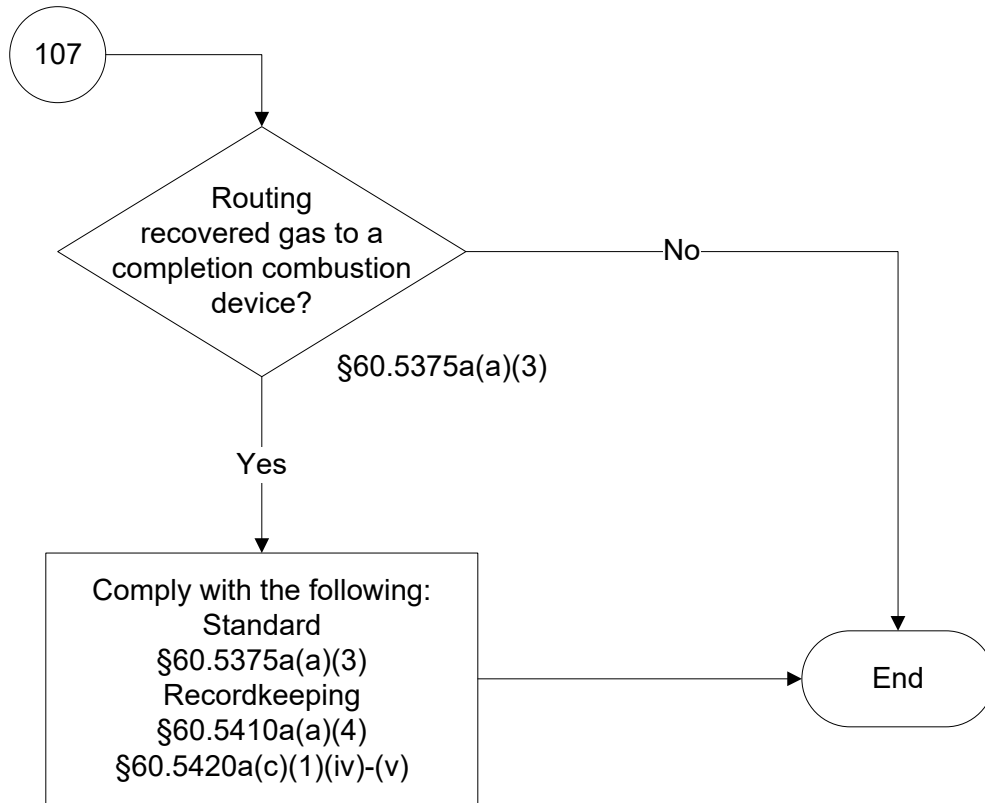

40 CFR Part 60, Subpart OOOOa
(82 of 82)

