



Below is a flowchart describing 40 CFR Part 63, Subpart DDDDD.

For the text of the statute/rule, please go to

[40 CFR Part 63, Subpart DDDDD](#)

(1 of 242)

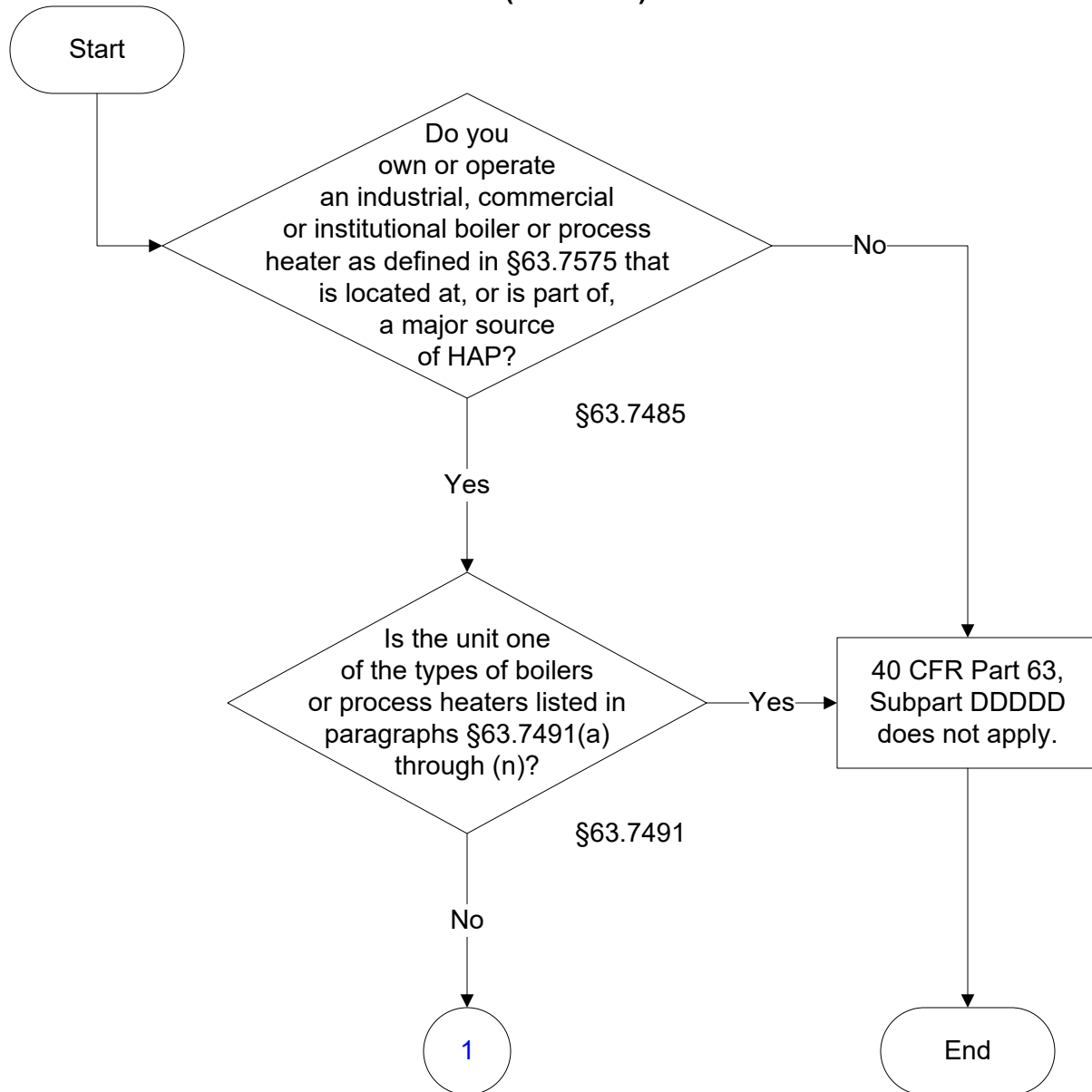

40 CFR Part 63, Subpart DDDDD (2 of 242)

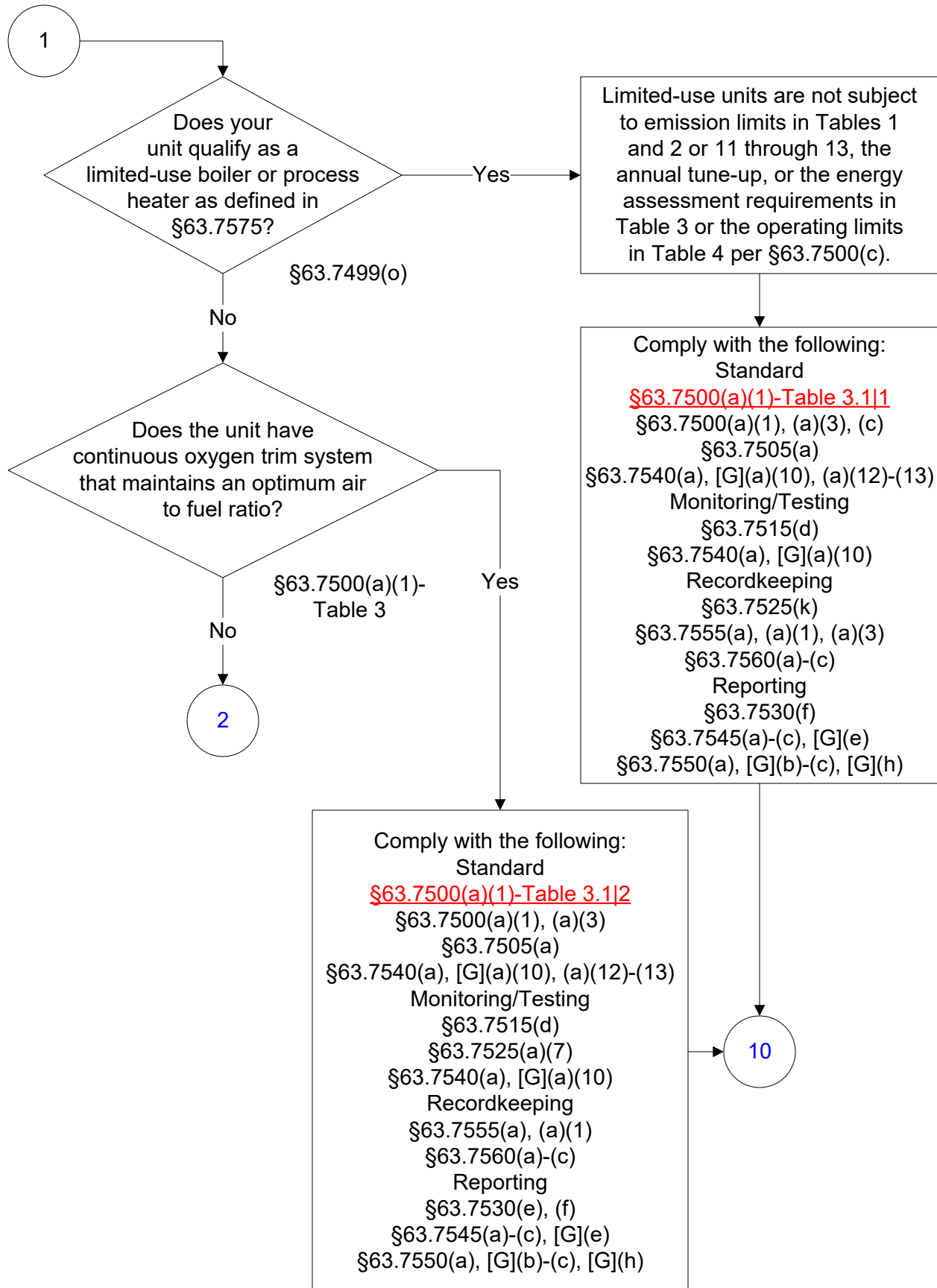

40 CFR Part 63, Subpart DDDDD (3 of 242)

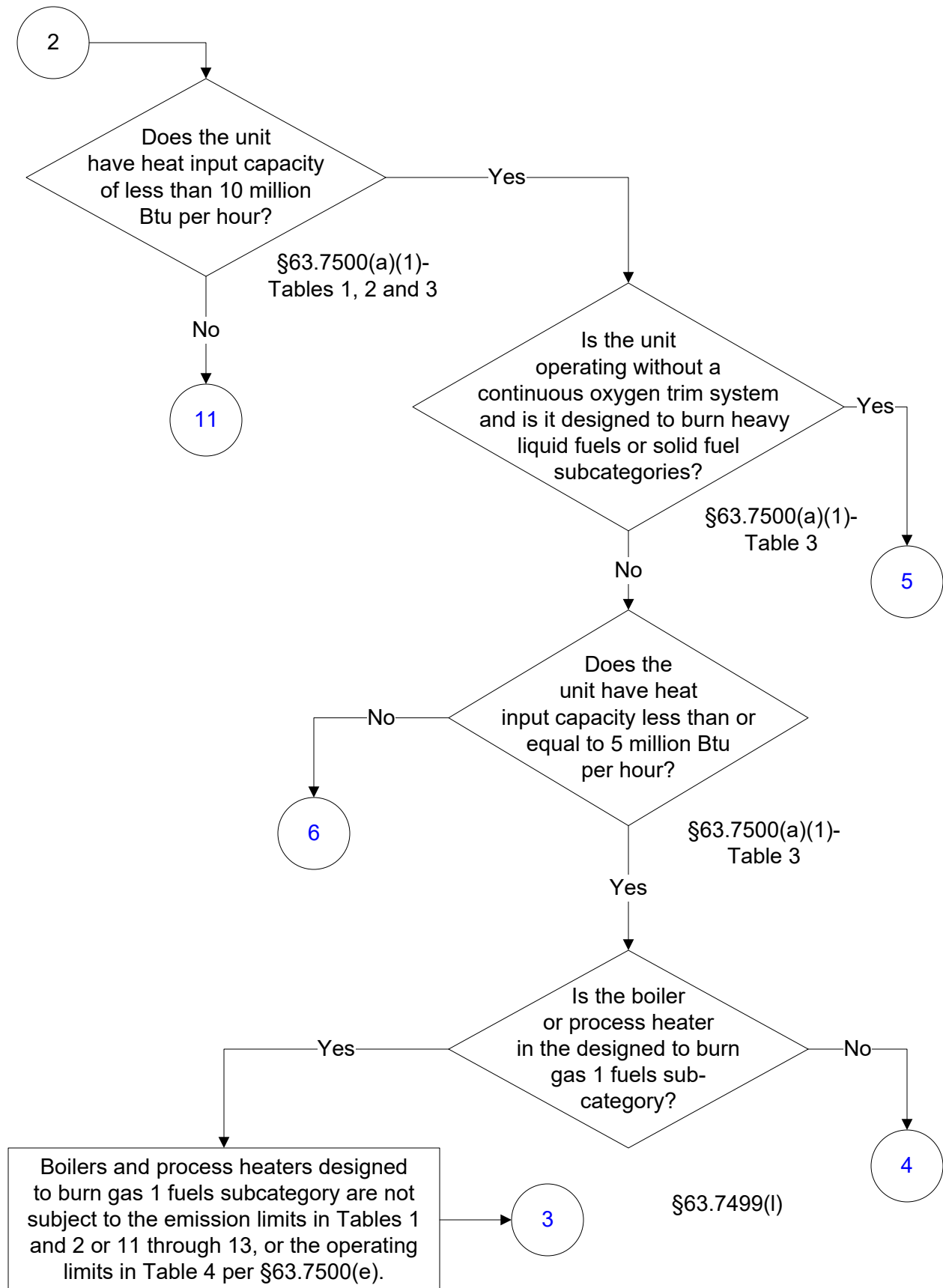

40 CFR Part 63, Subpart DDDDD (4 of 242)

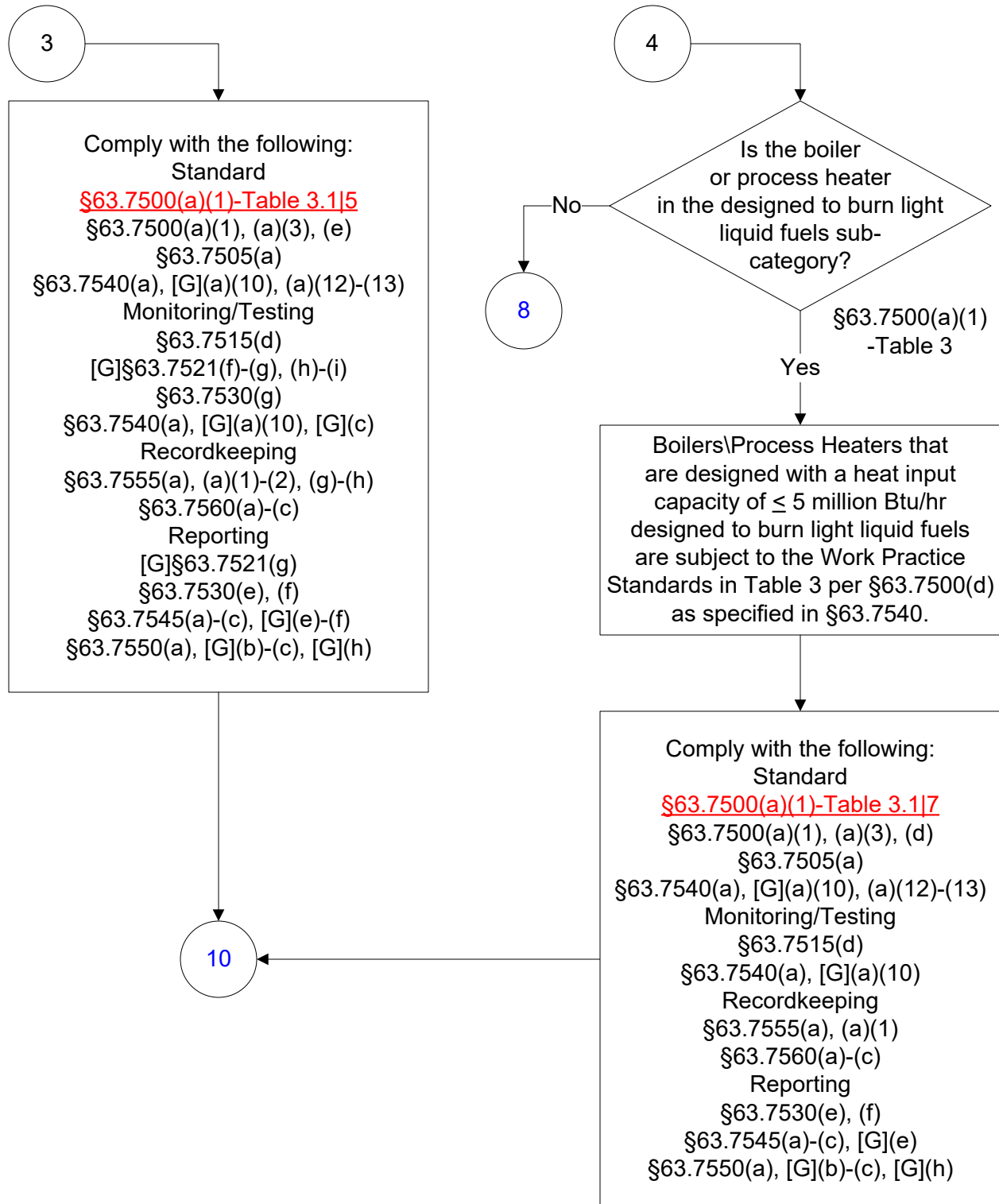

40 CFR Part 63, Subpart DDDDD (5 of 242)

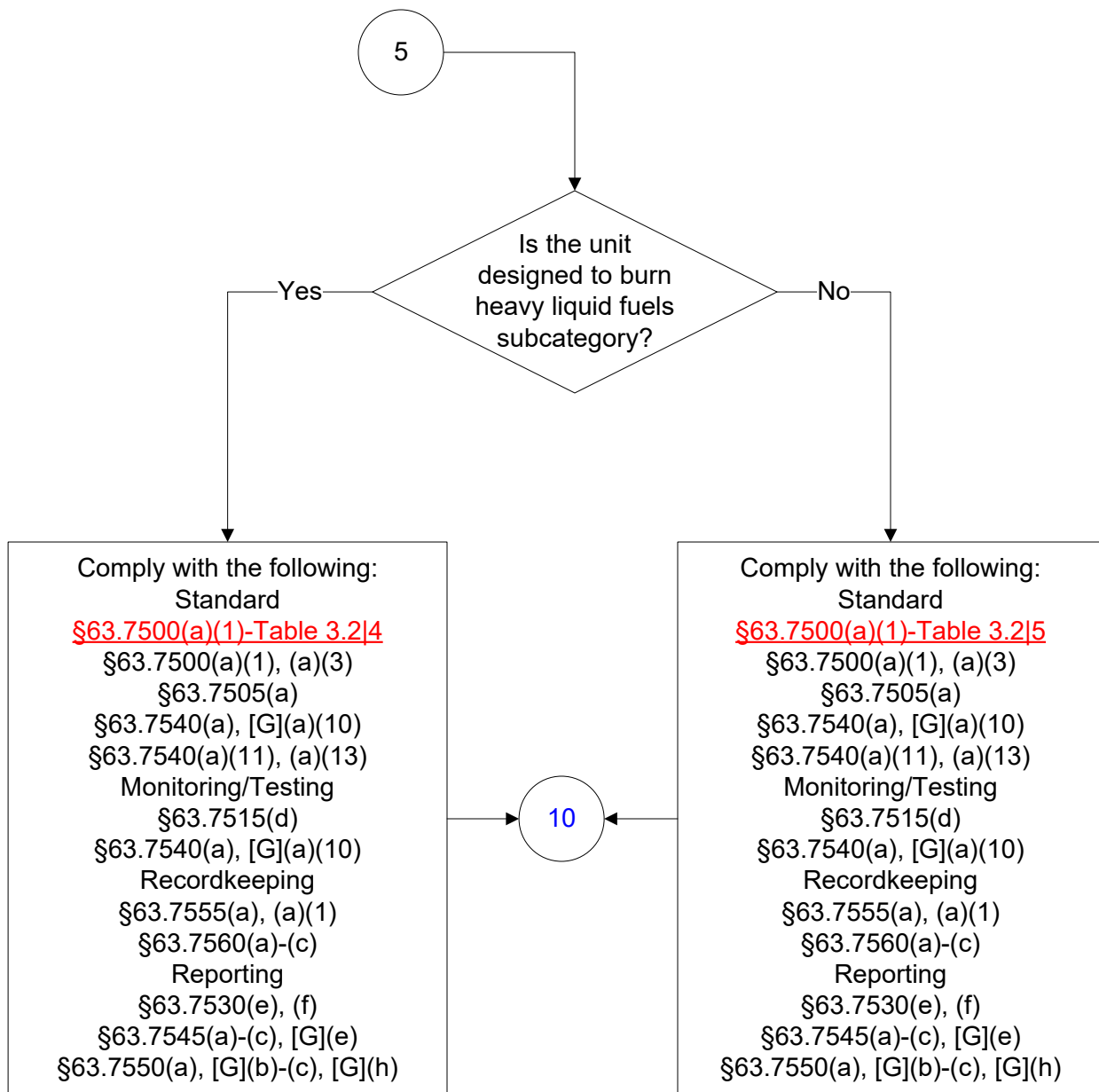

40 CFR Part 63, Subpart DDDDD (6 of 242)

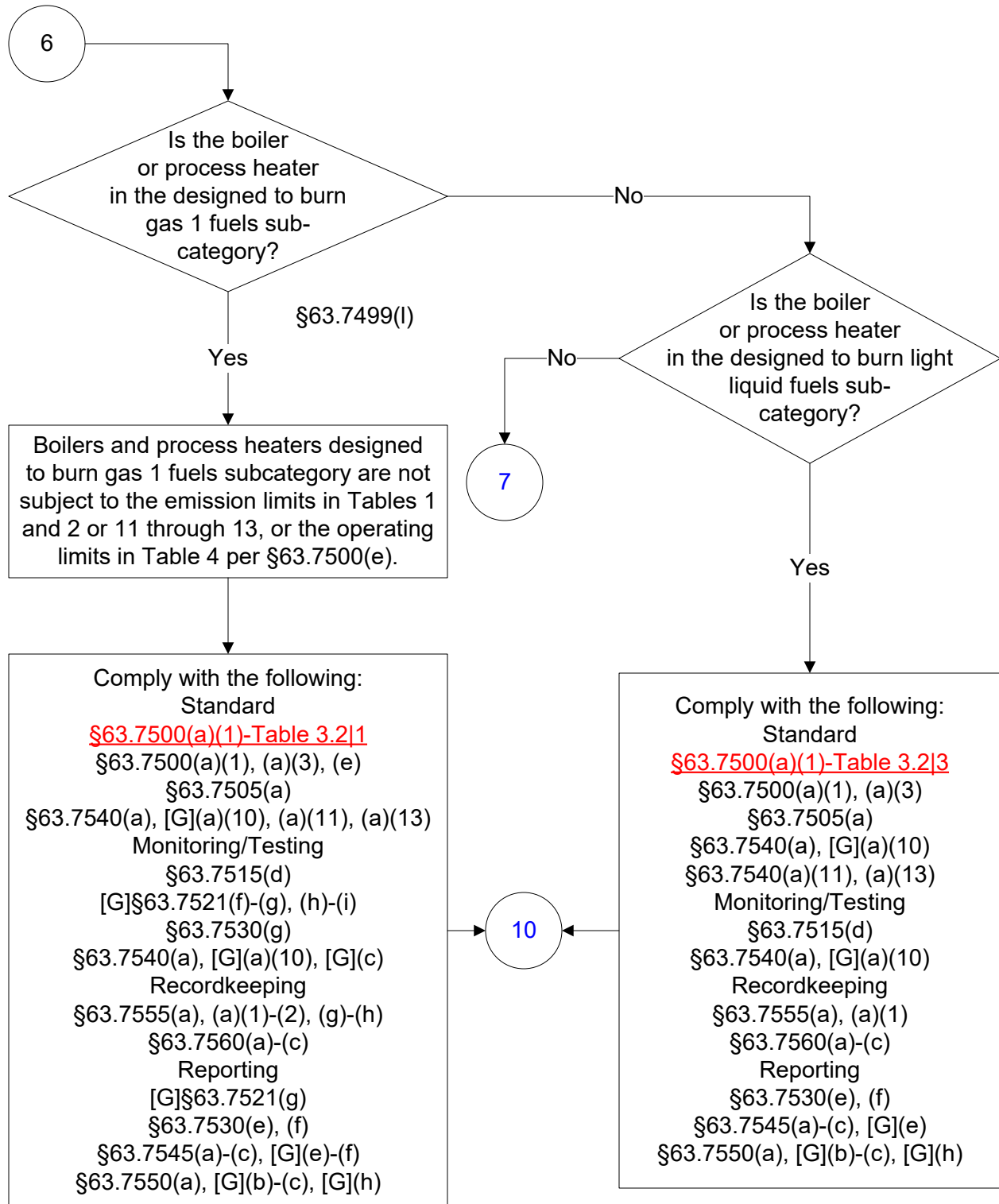

40 CFR Part 63, Subpart DDDDD (7 of 242)

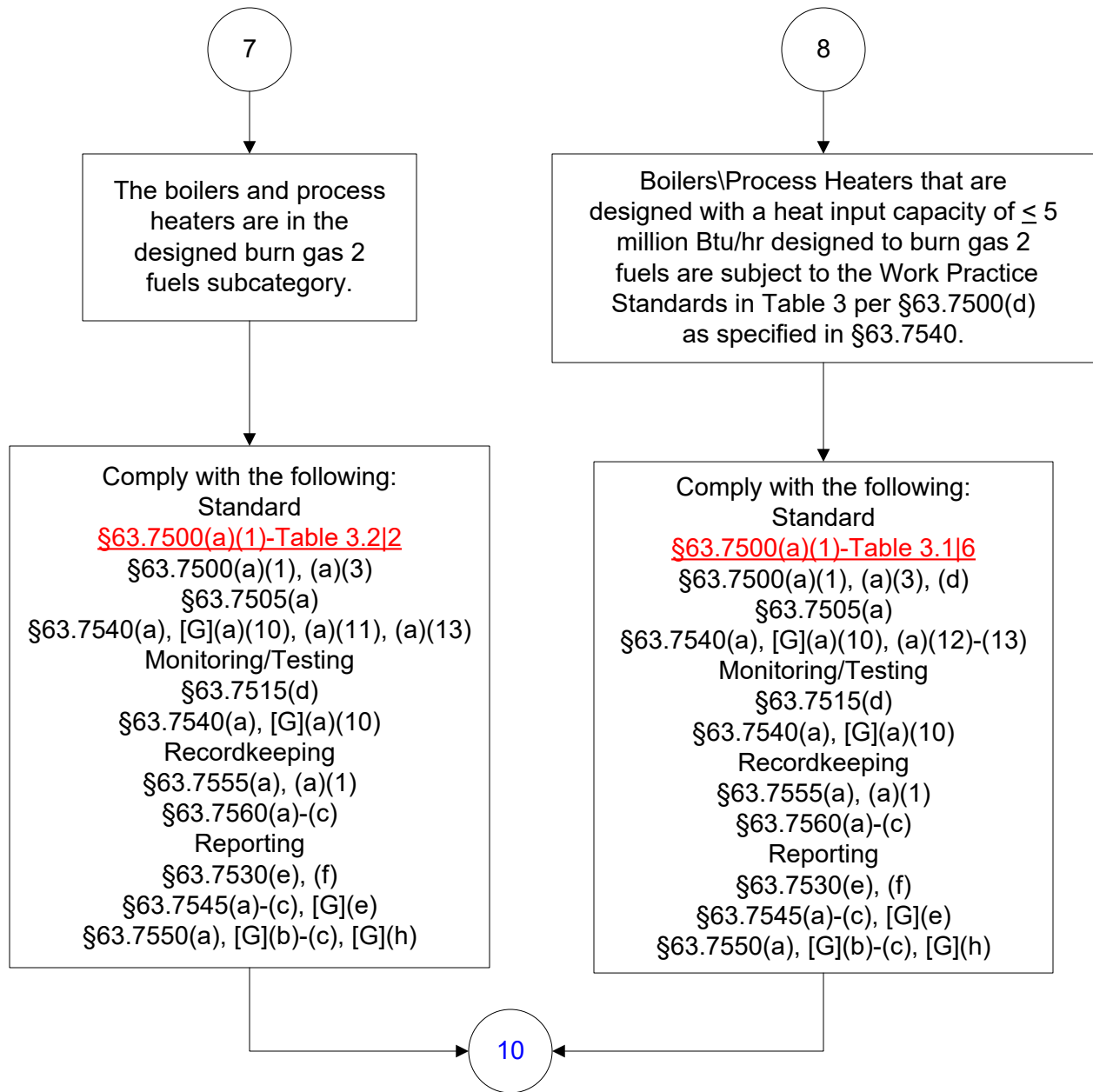

40 CFR Part 63, Subpart DDDDD (8 of 242)

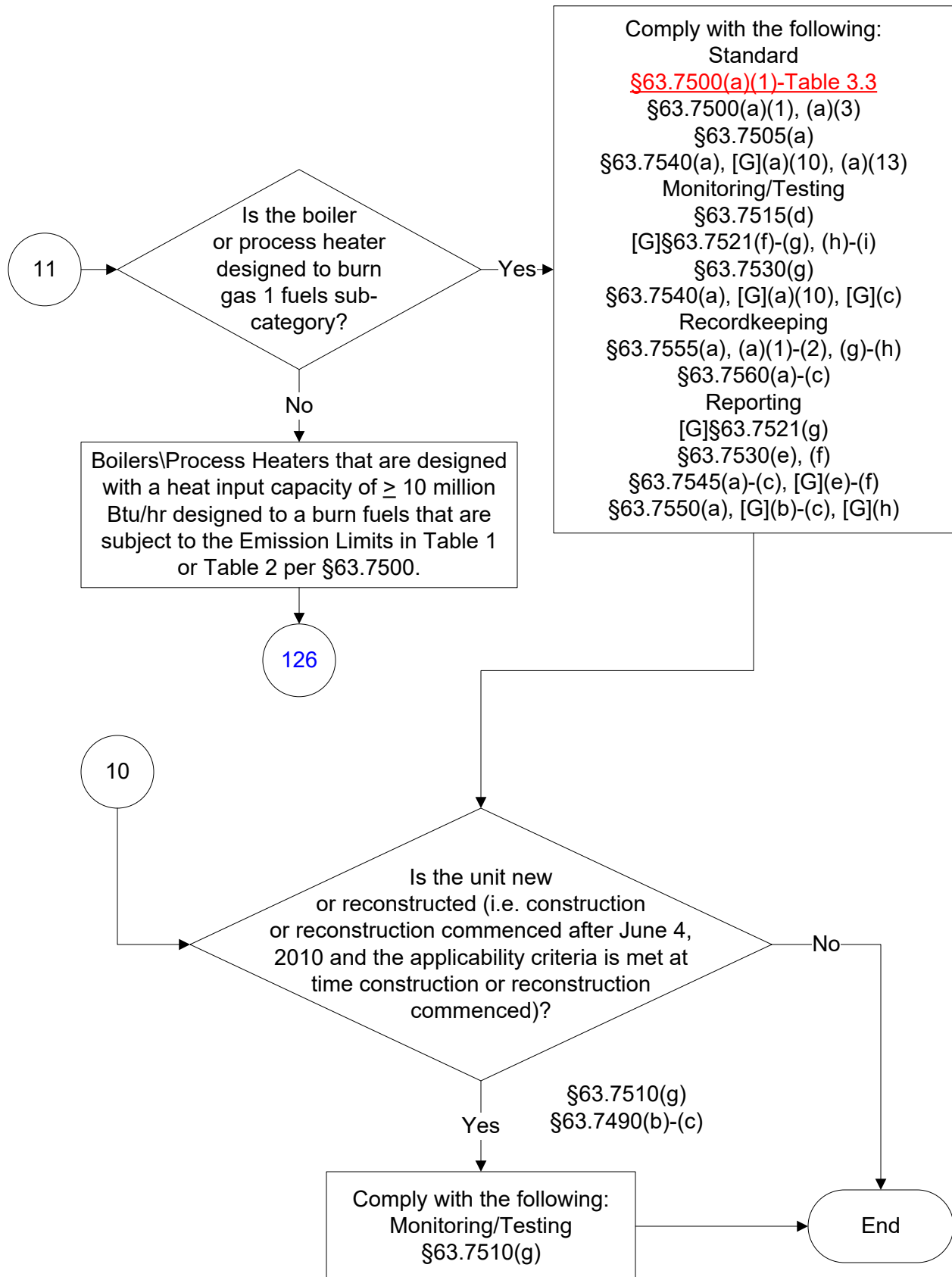

**40 CFR Part 63, Subpart DDDDD
(9 of 242)**

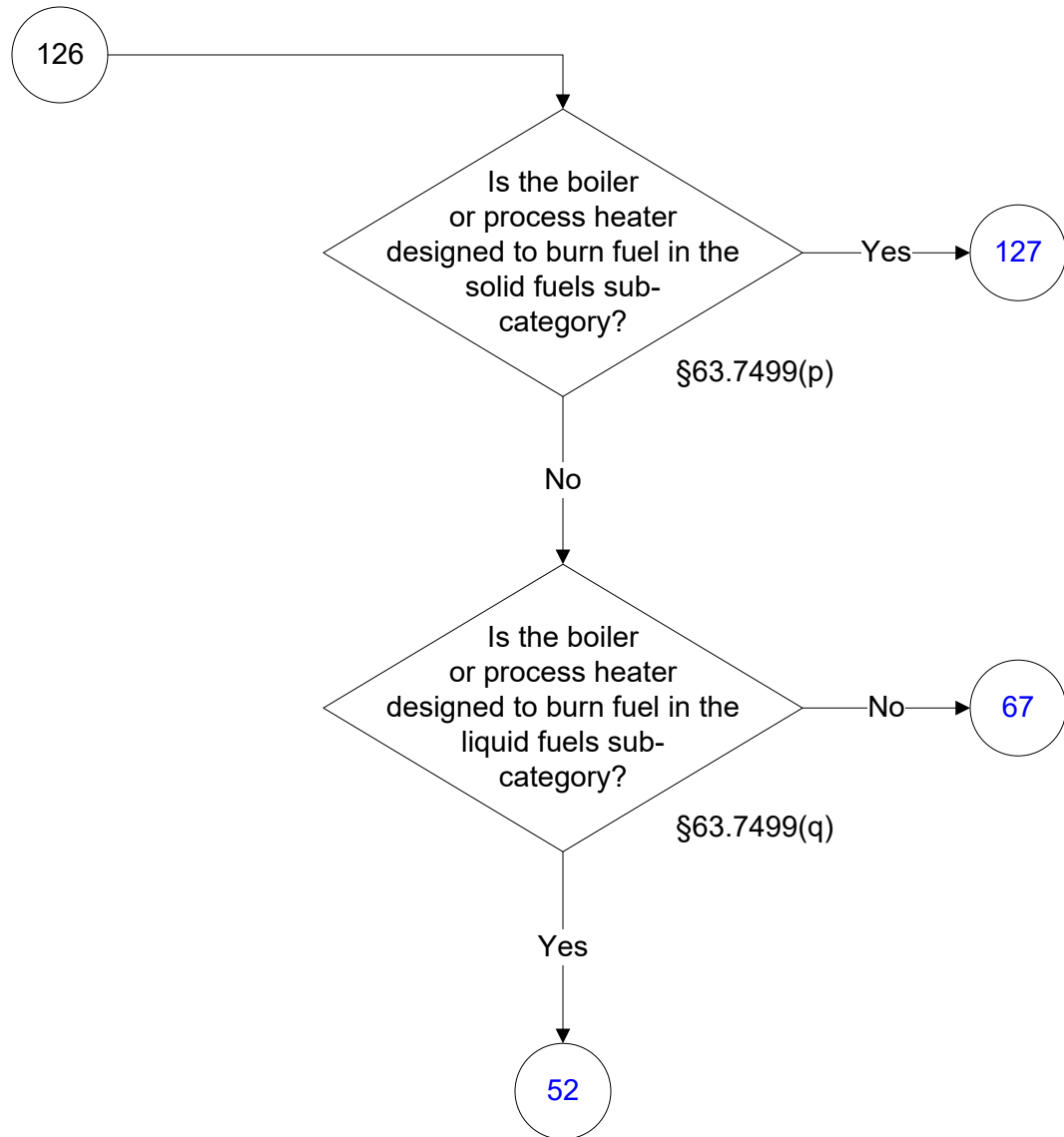

40 CFR Part 63, Subpart DDDDD (10 of 242)

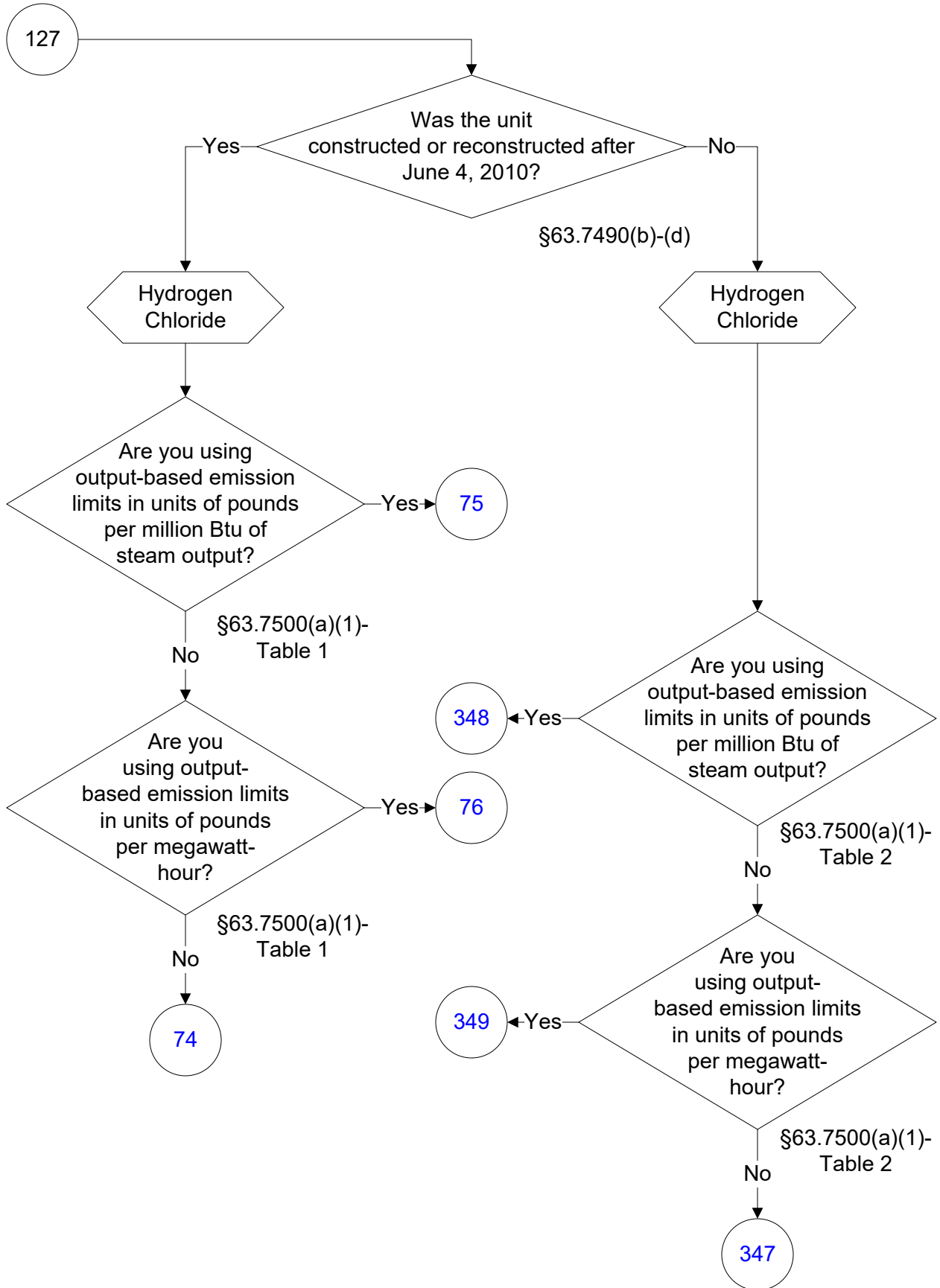

40 CFR Part 63, Subpart DDDDD (11 of 242)

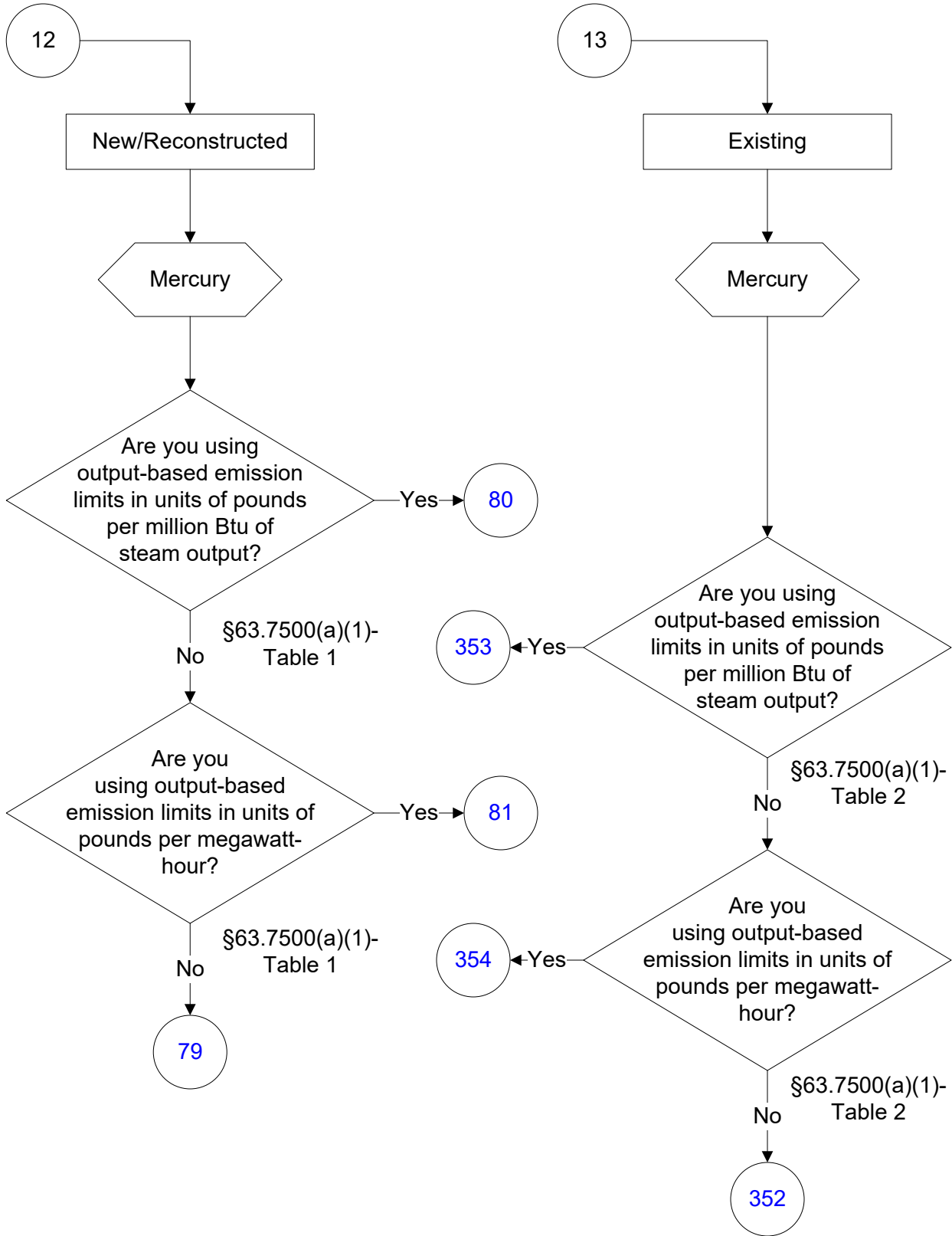

40 CFR Part 63, Subpart DDDDD (12 of 242)

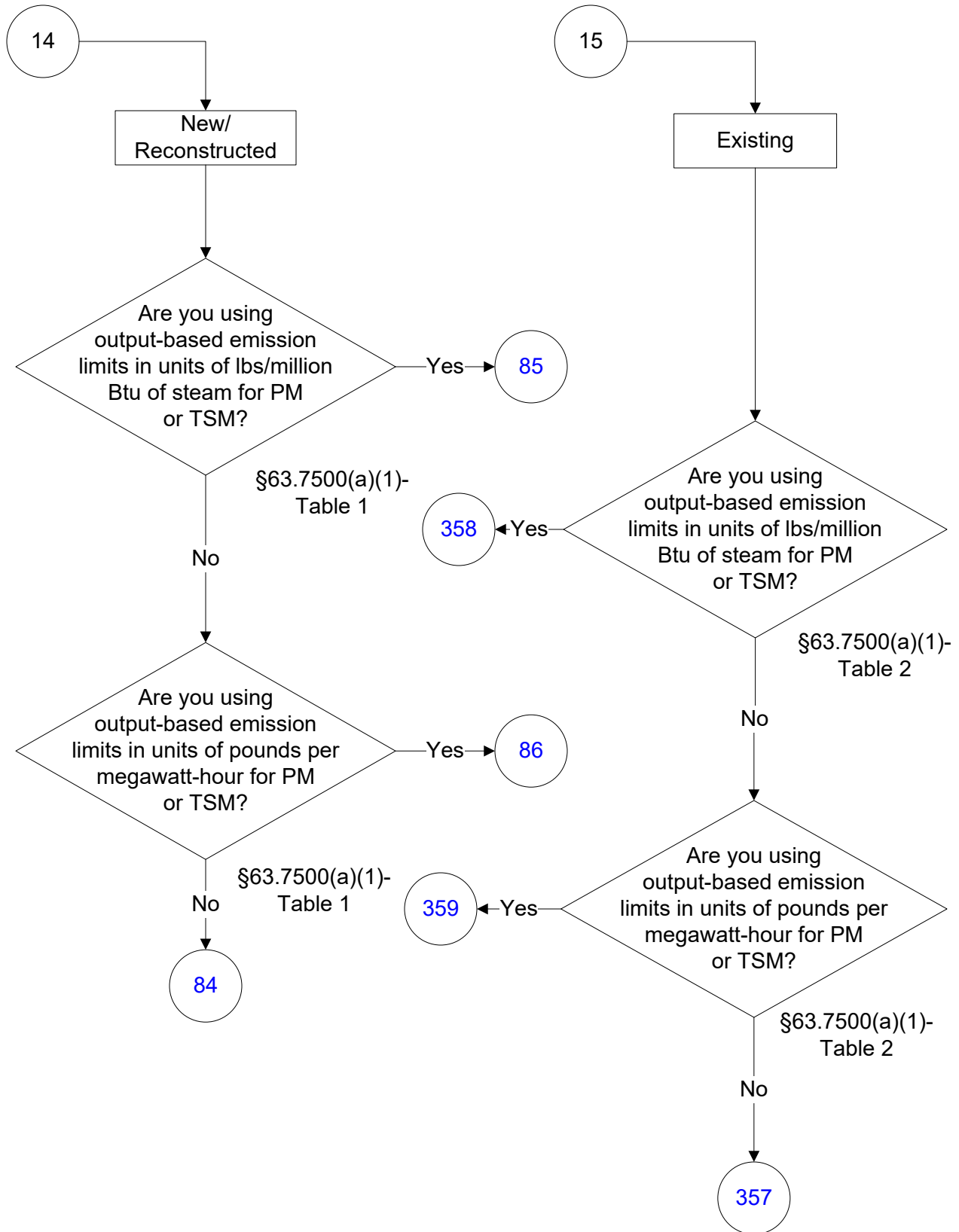

40 CFR Part 63, Subpart DDDDD (13 of 242)

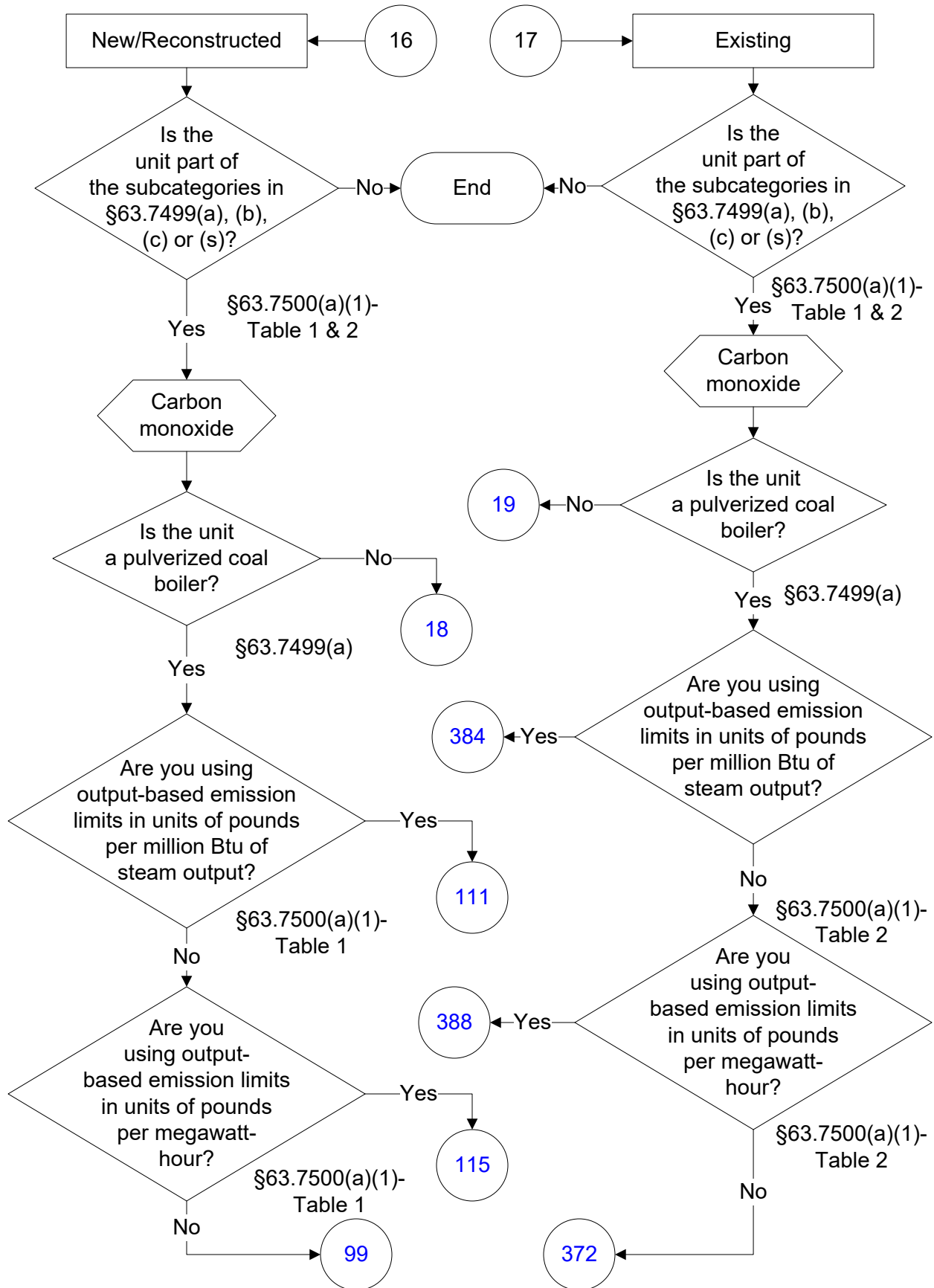

40 CFR Part 63, Subpart DDDDD (14 of 242)

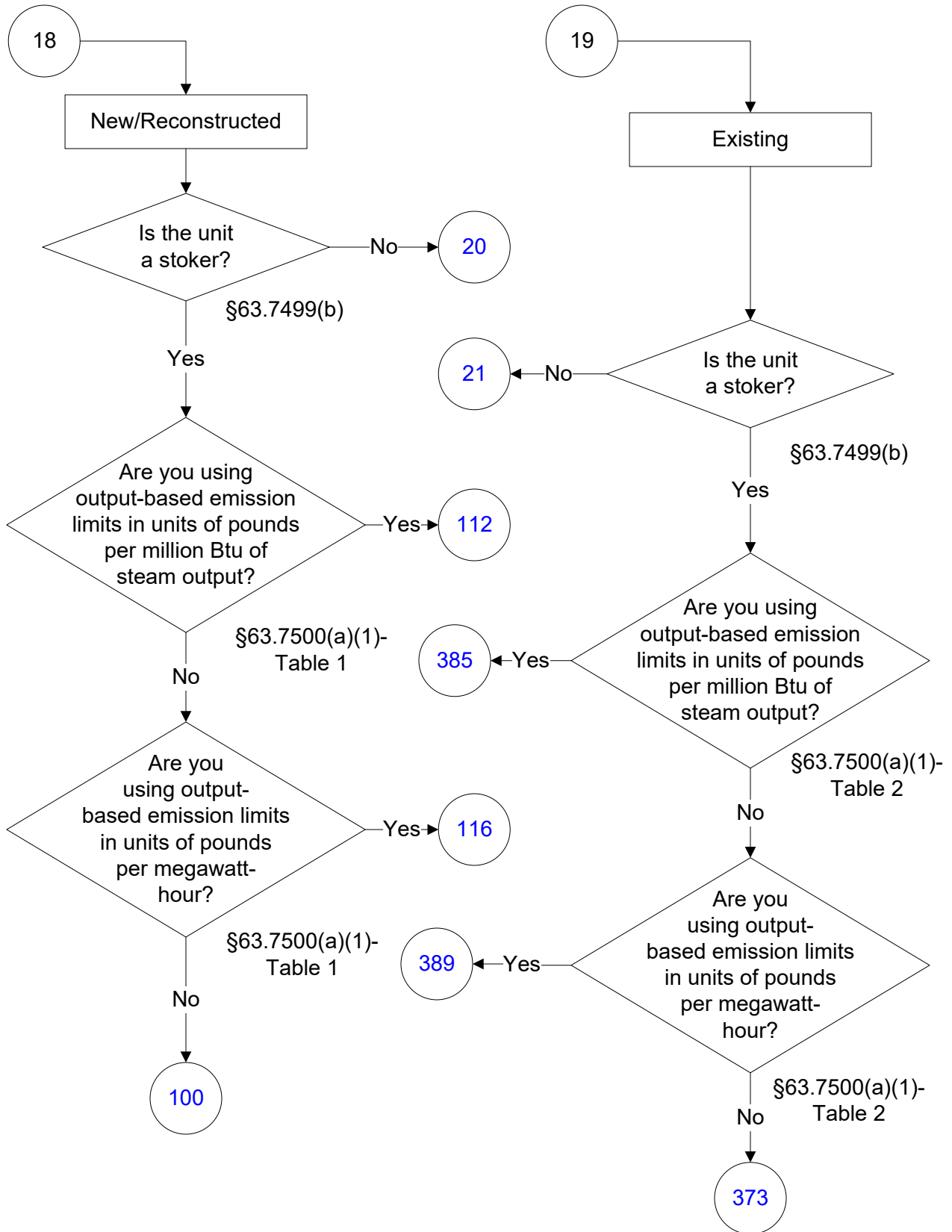

40 CFR Part 63, Subpart DDDDD (15 of 242)

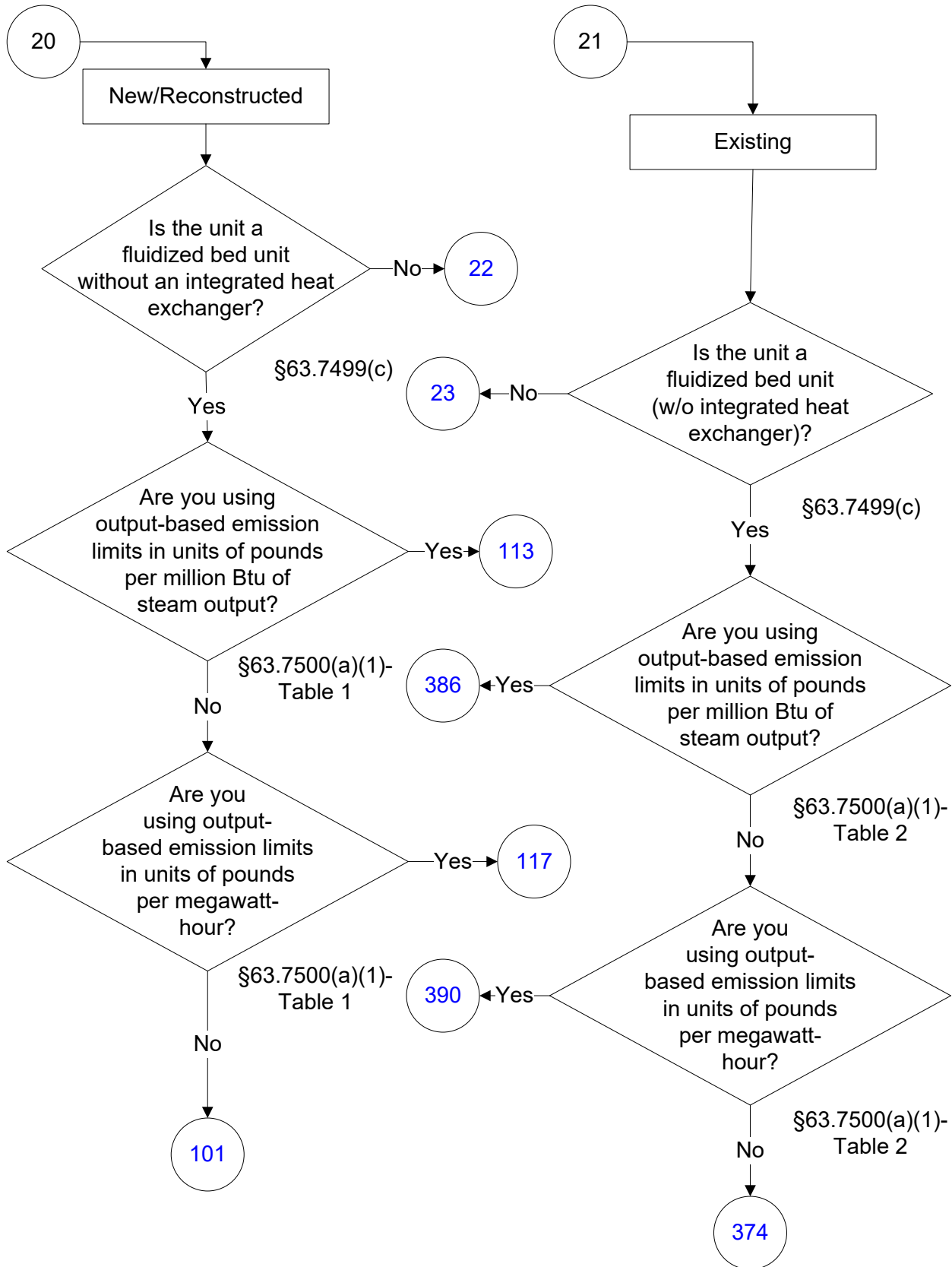

40 CFR Part 63, Subpart DDDDD (16 of 242)

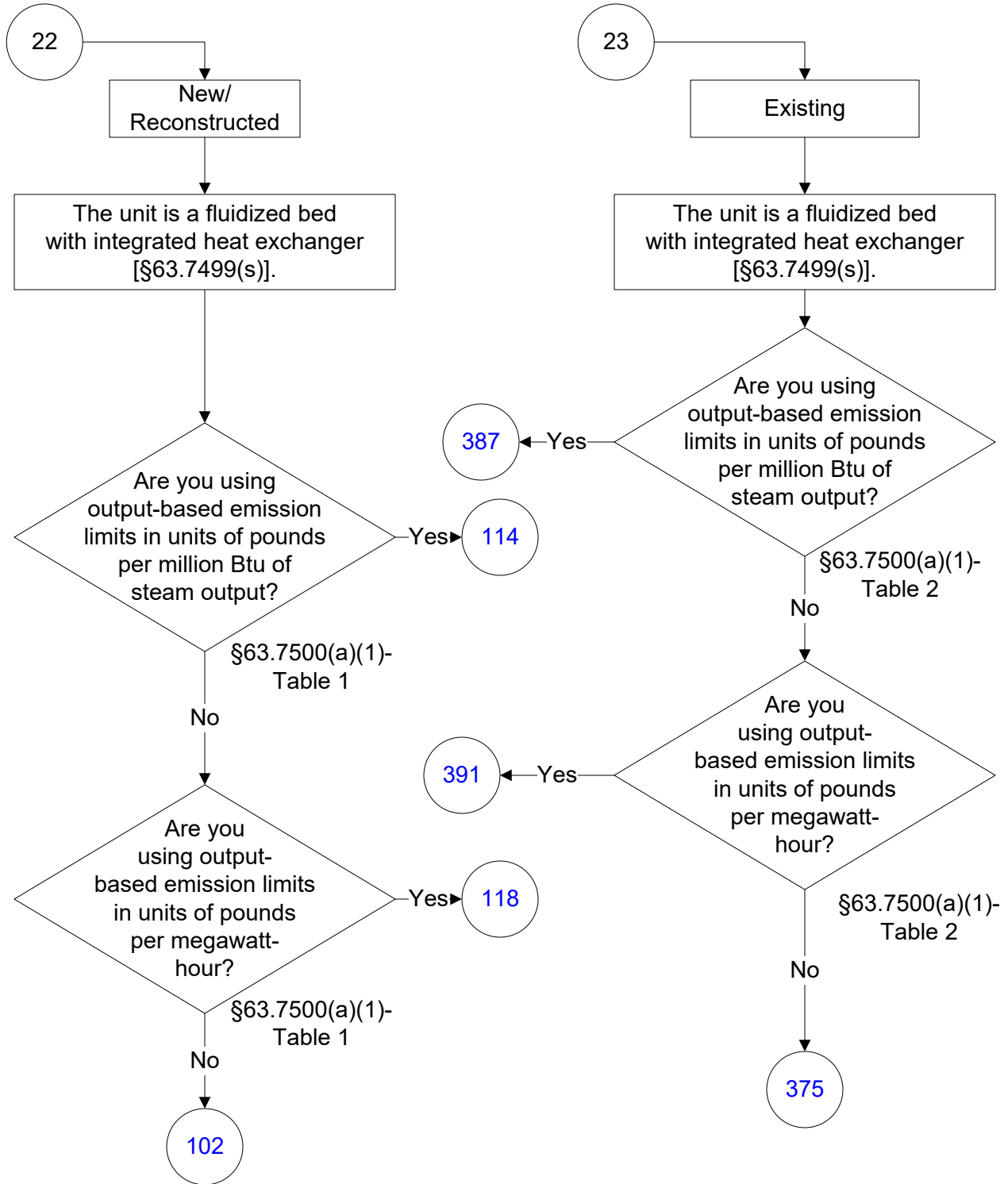

40 CFR Part 63, Subpart DDDDD (17 of 242)

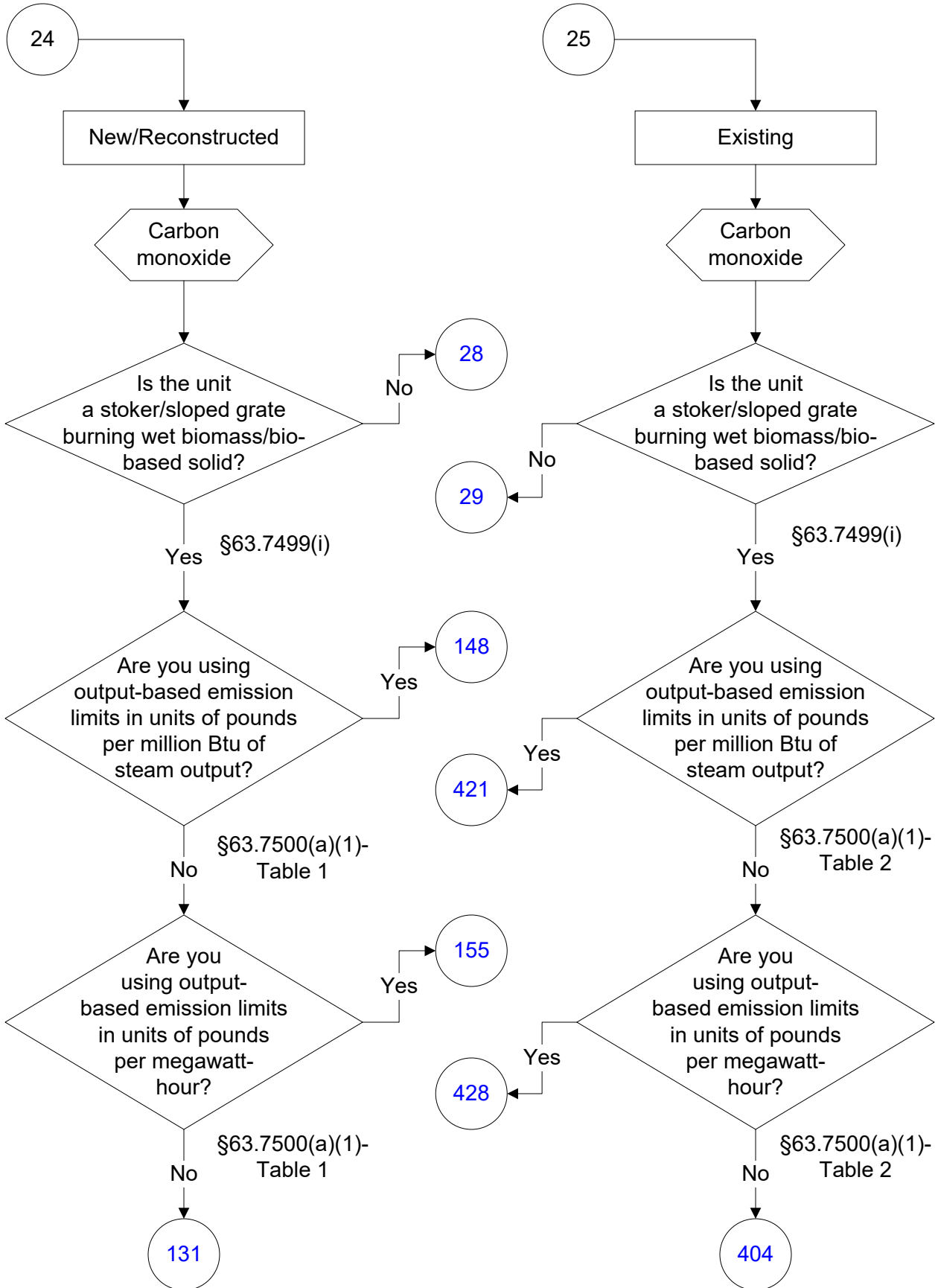

40 CFR Part 63, Subpart DDDDD (18 of 242)

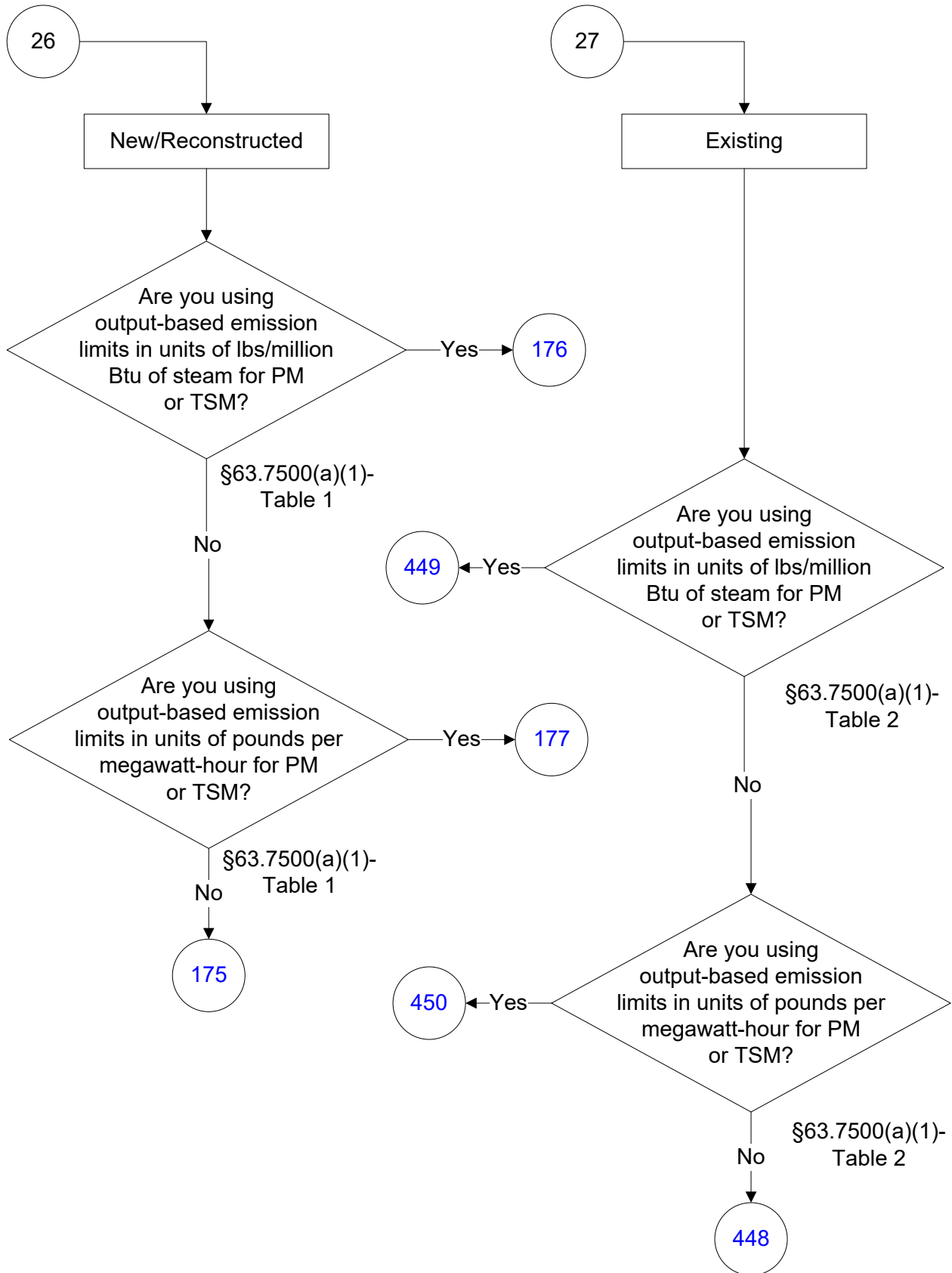

40 CFR Part 63, Subpart DDDDD (19 of 242)

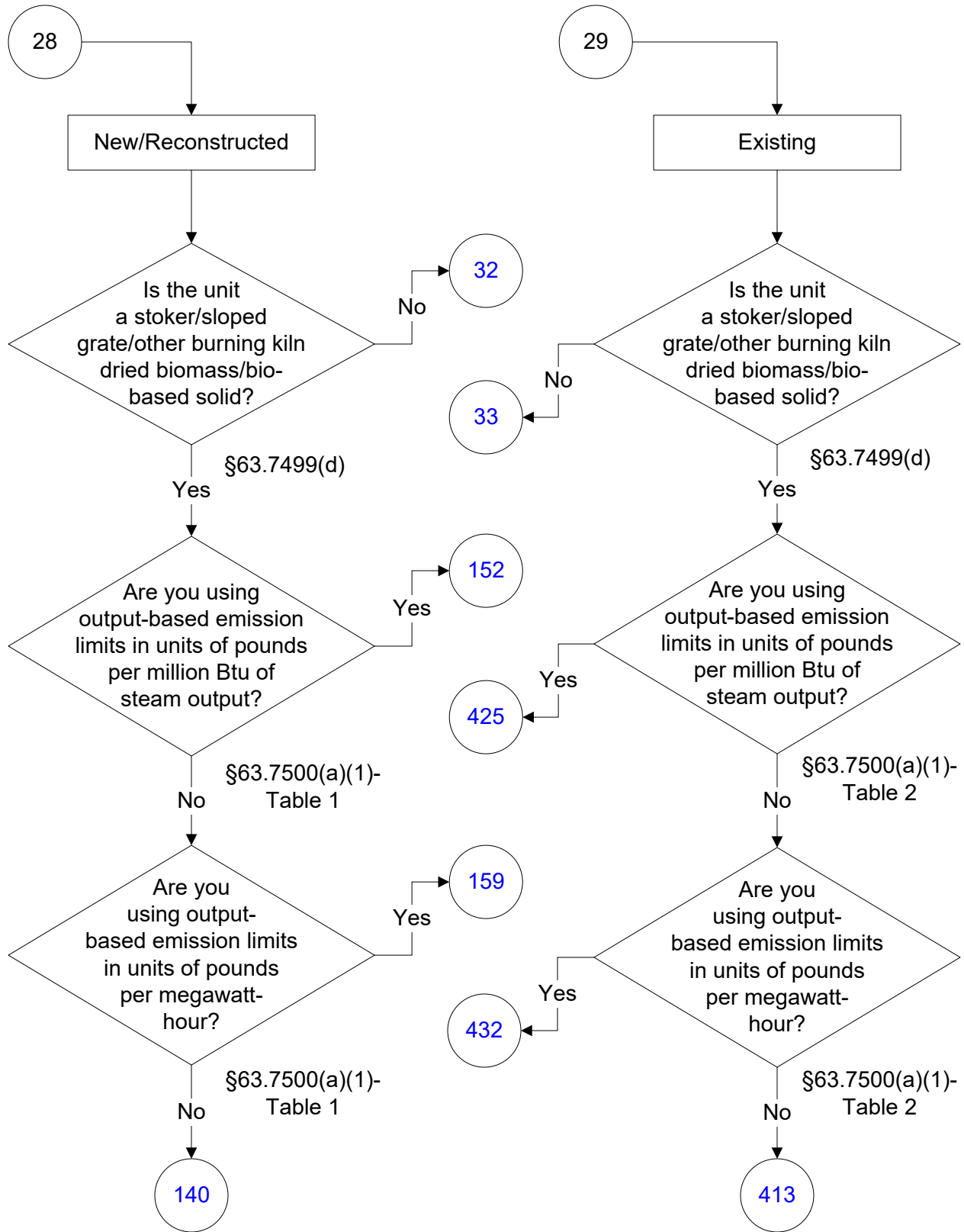

40 CFR Part 63, Subpart DDDDD (20 of 242)

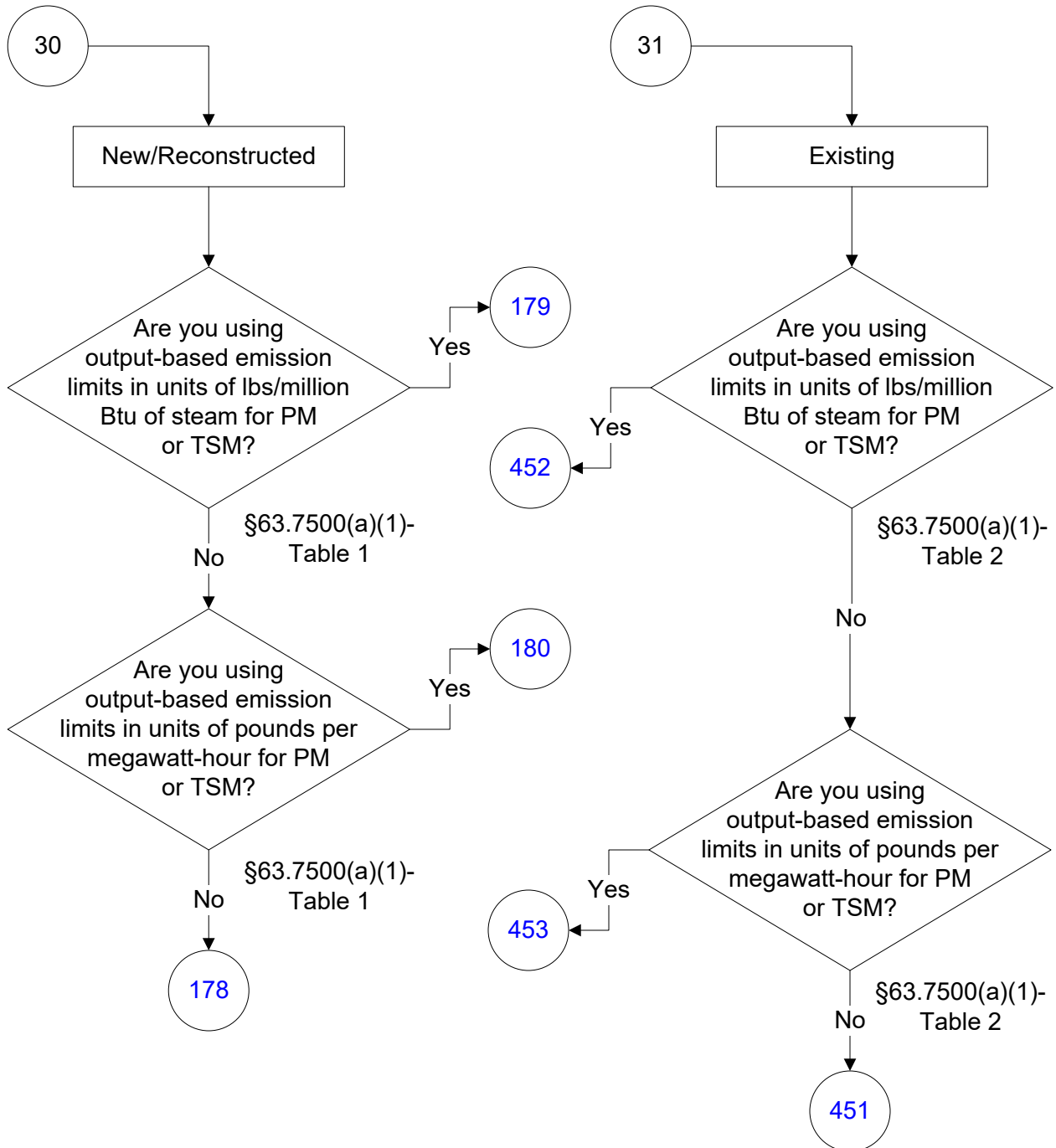

40 CFR Part 63, Subpart DDDDD (21 of 242)

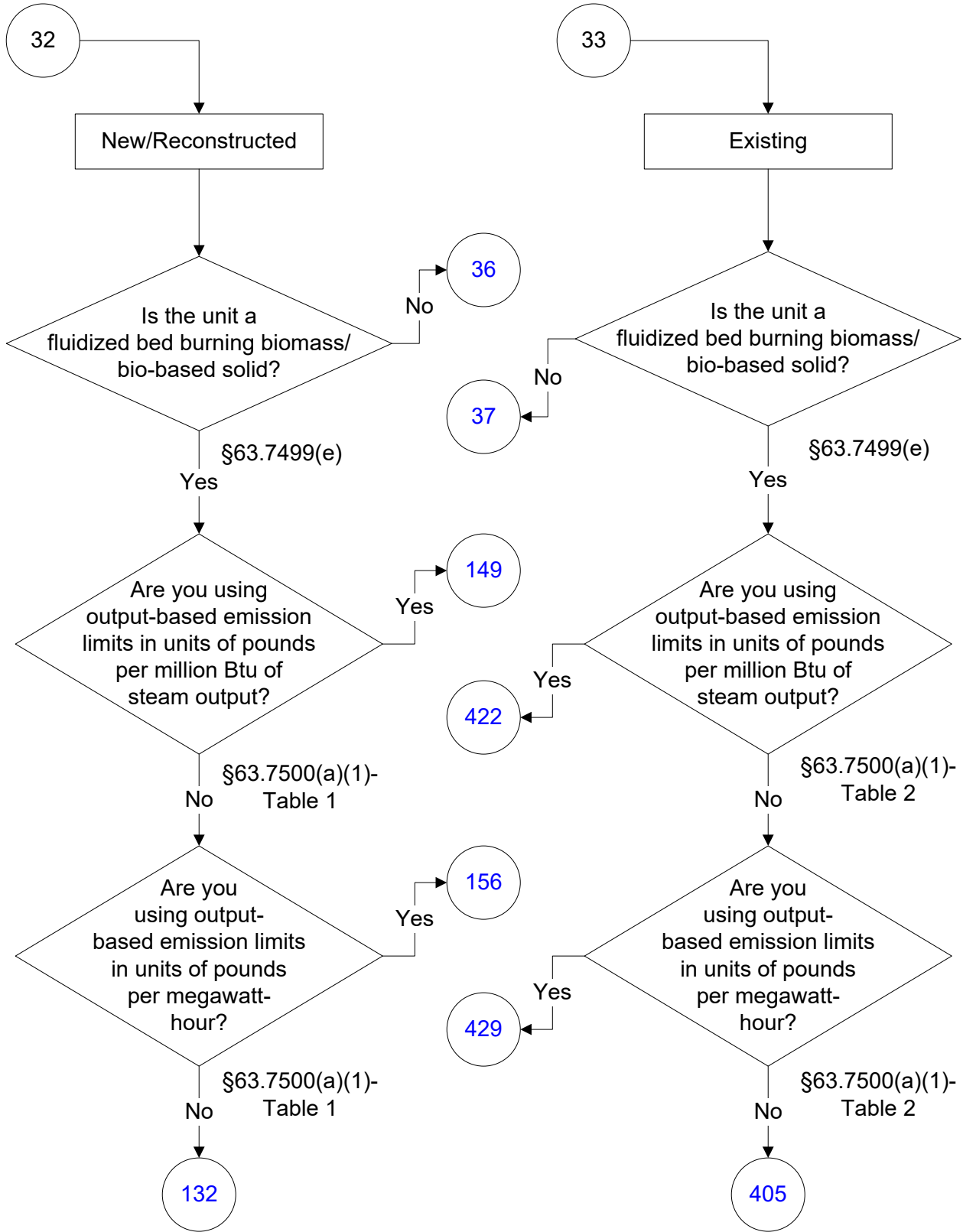

40 CFR Part 63, Subpart DDDDD (22 of 242)

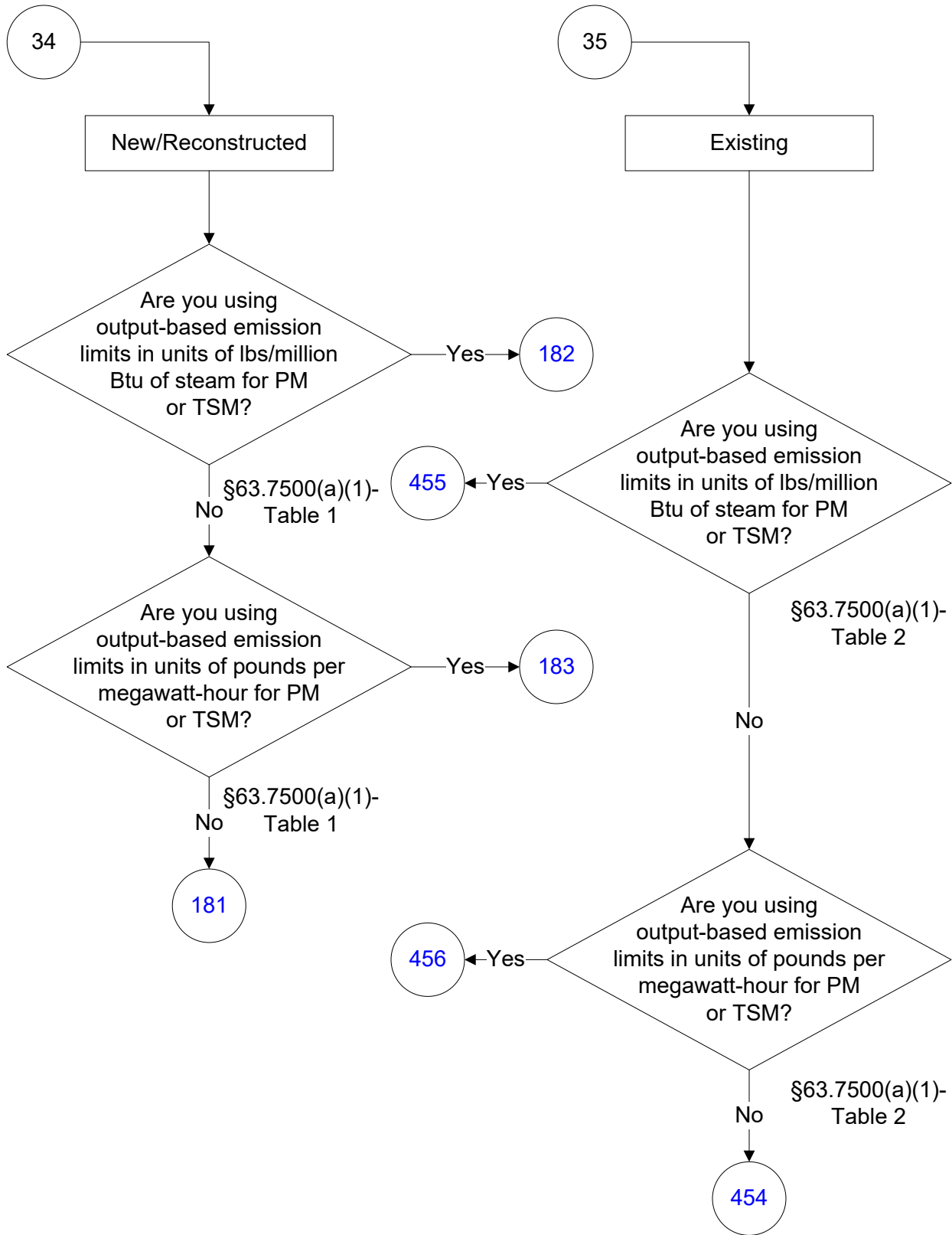

40 CFR Part 63, Subpart DDDDD (23 of 242)

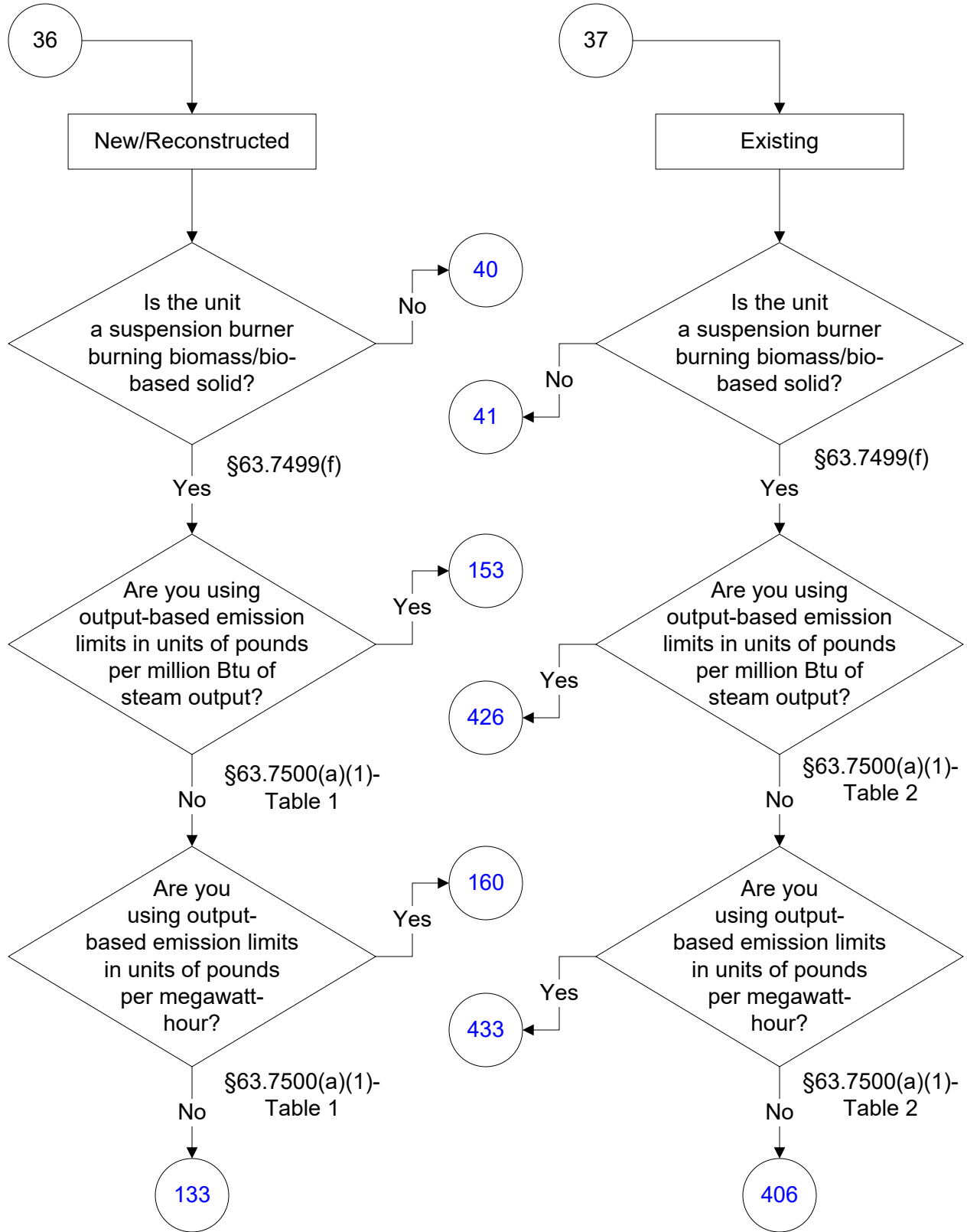

40 CFR Part 63, Subpart DDDDD (24 of 242)

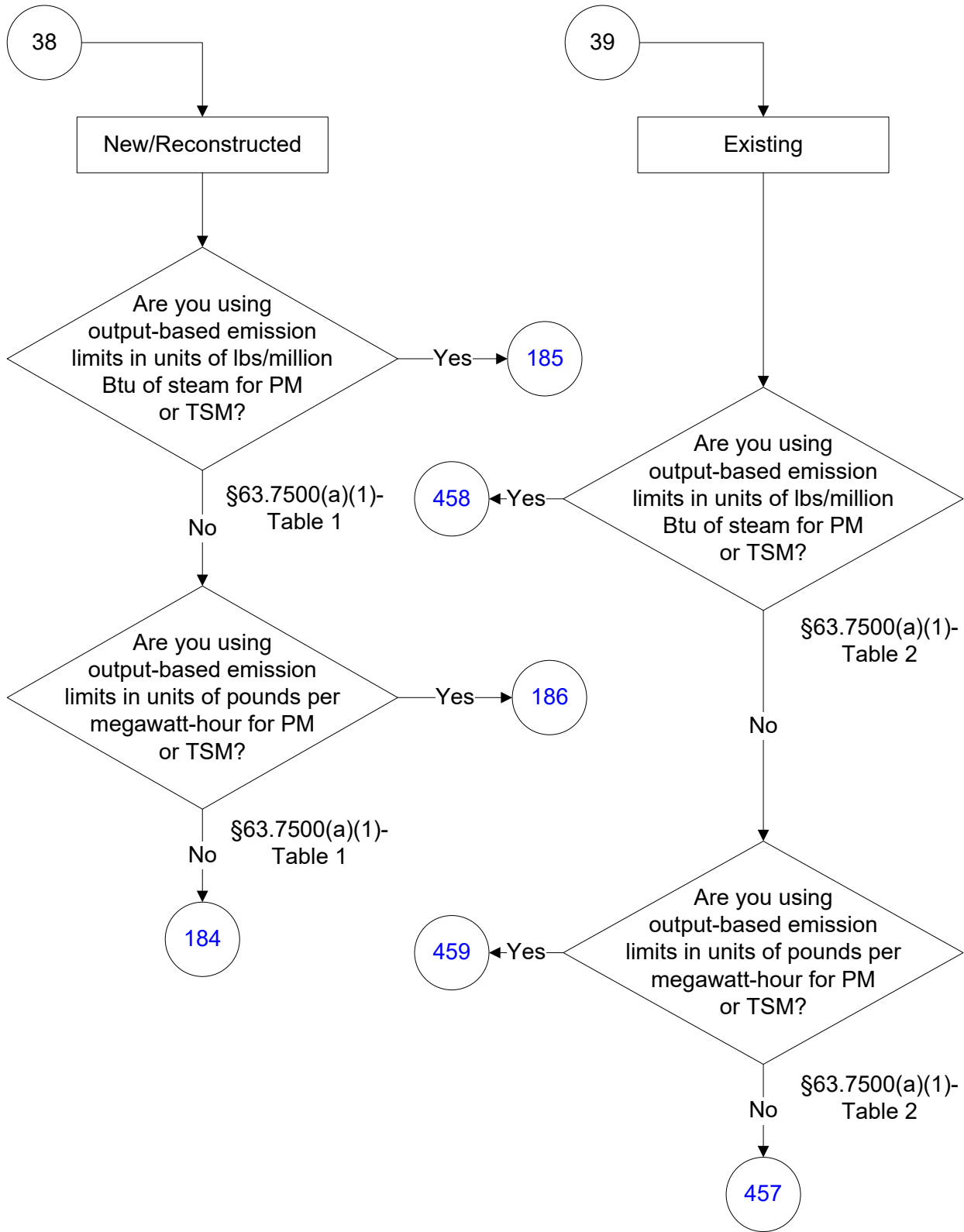

40 CFR Part 63, Subpart DDDDD (25 of 242)

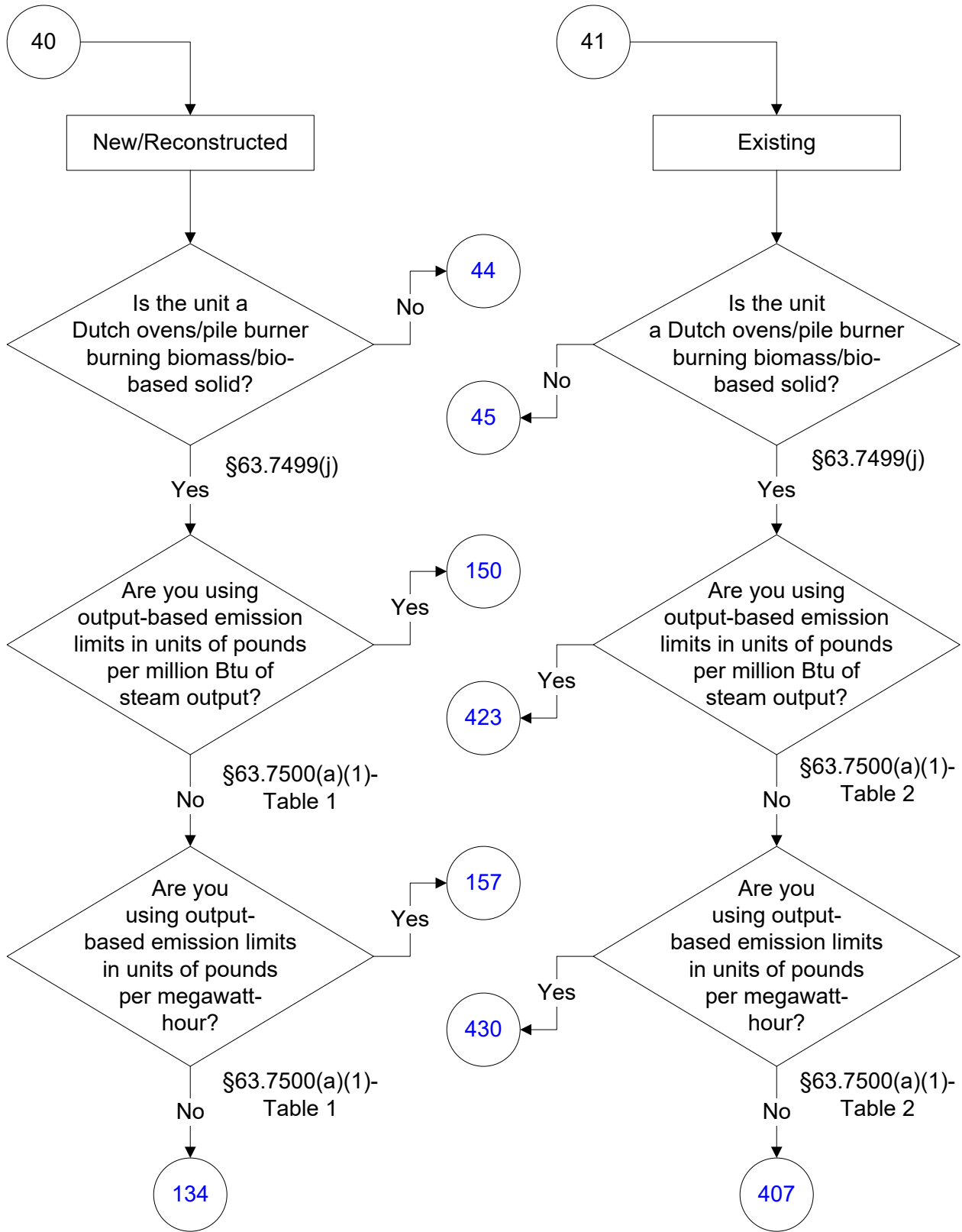

40 CFR Part 63, Subpart DDDDD (26 of 242)

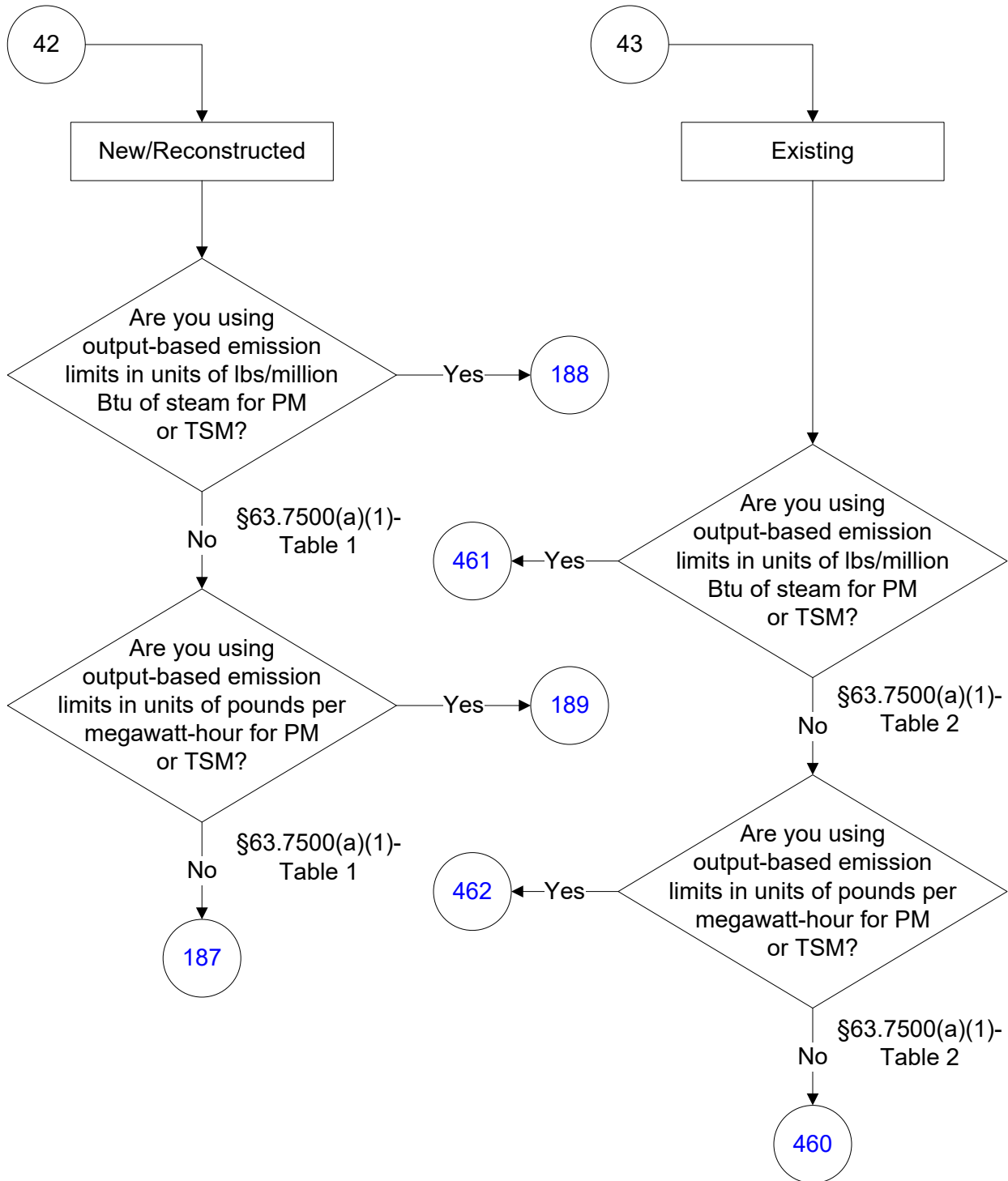

40 CFR Part 63, Subpart DDDDD (27 of 242)

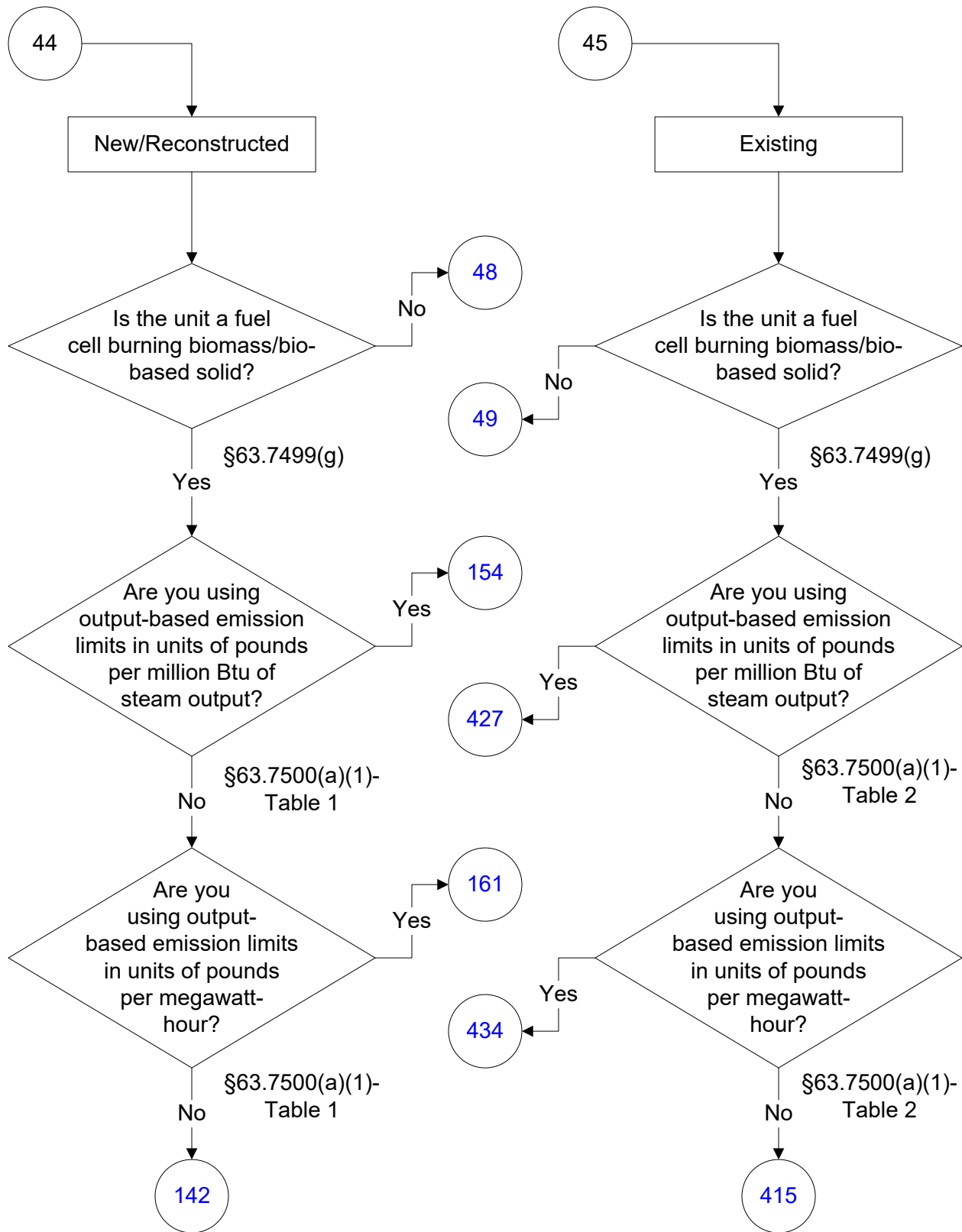

40 CFR Part 63, Subpart DDDDD (28 of 242)

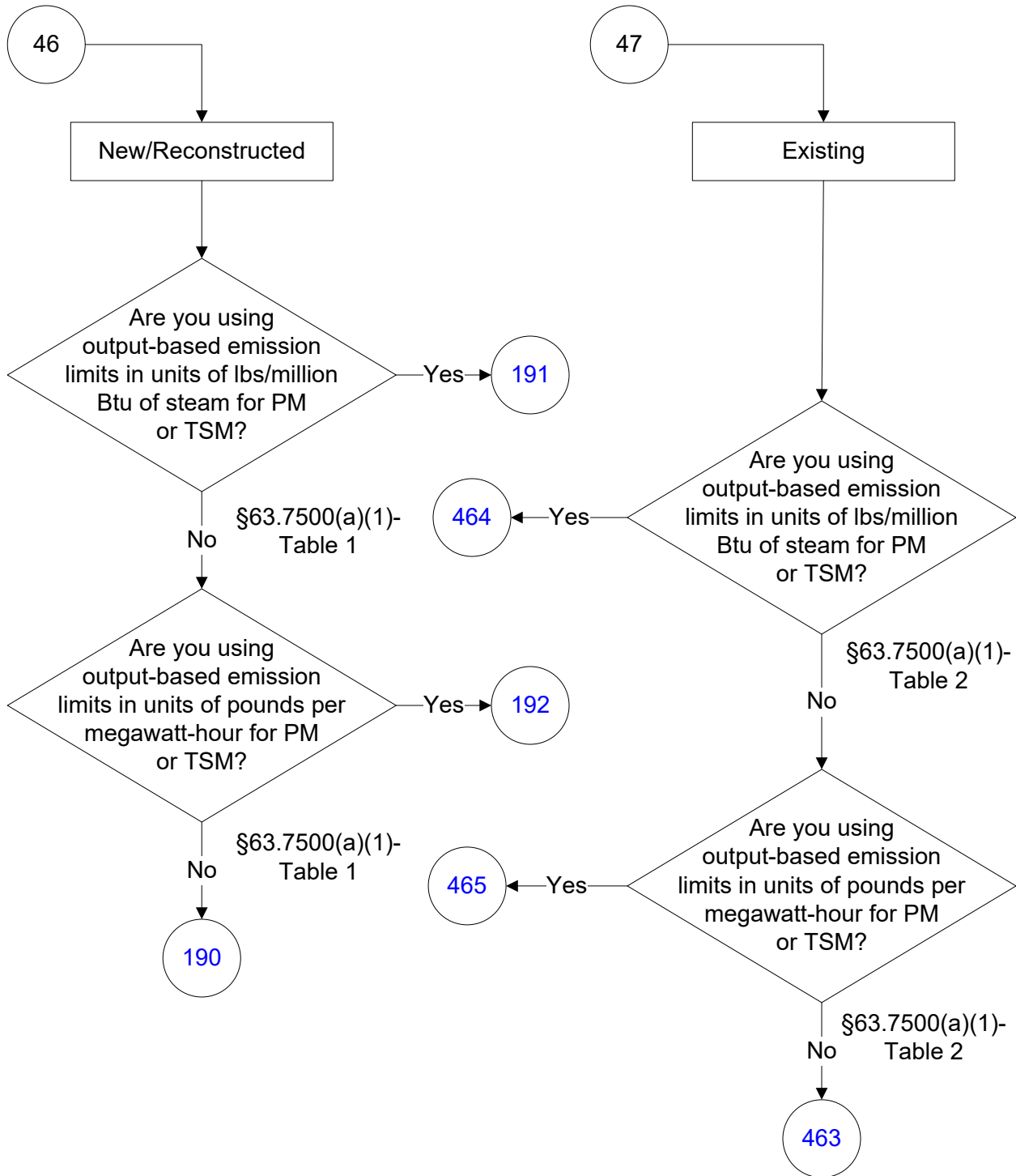

40 CFR Part 63, Subpart DDDDD (29 of 242)

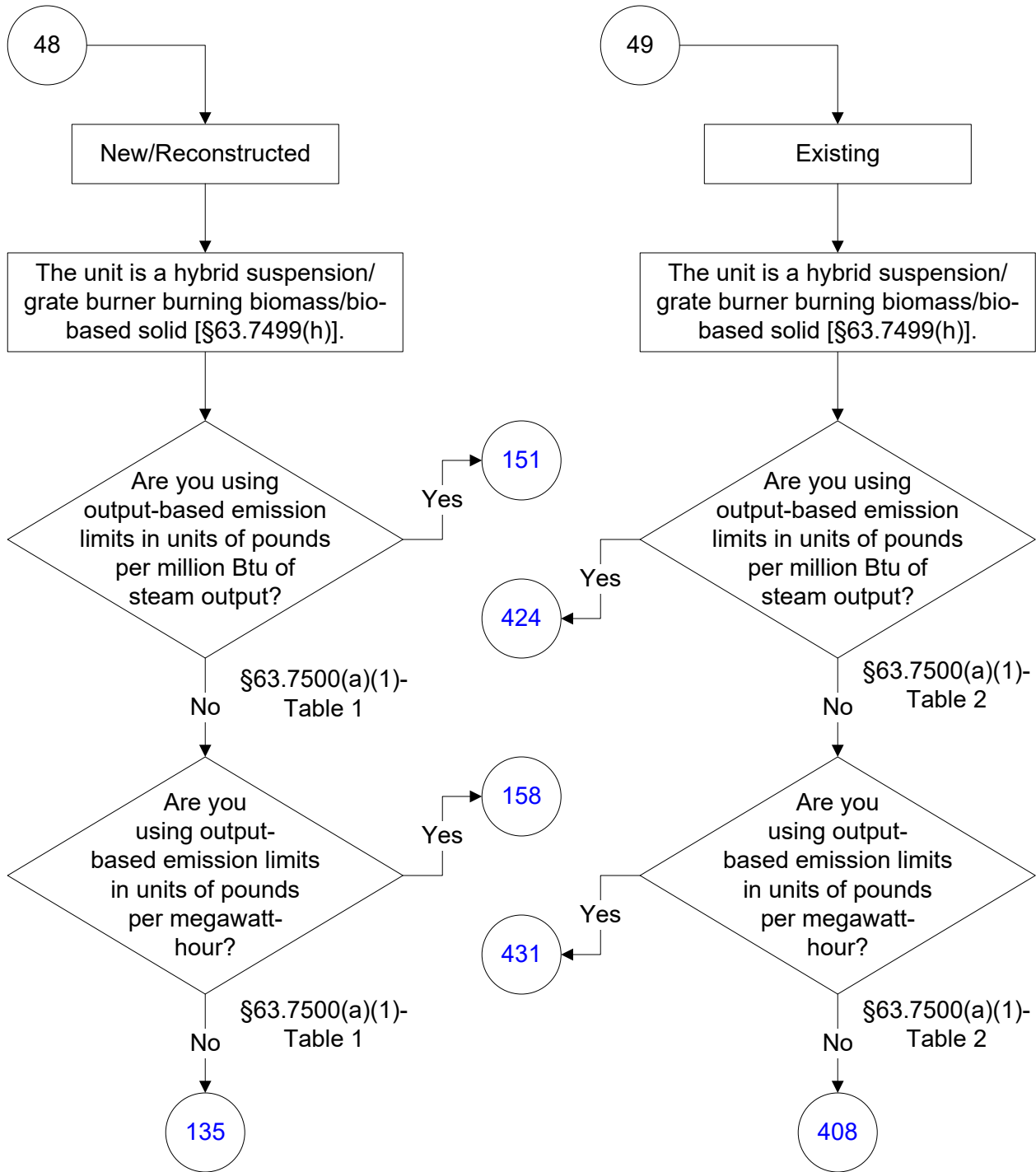

40 CFR Part 63, Subpart DDDDD (30 of 242)

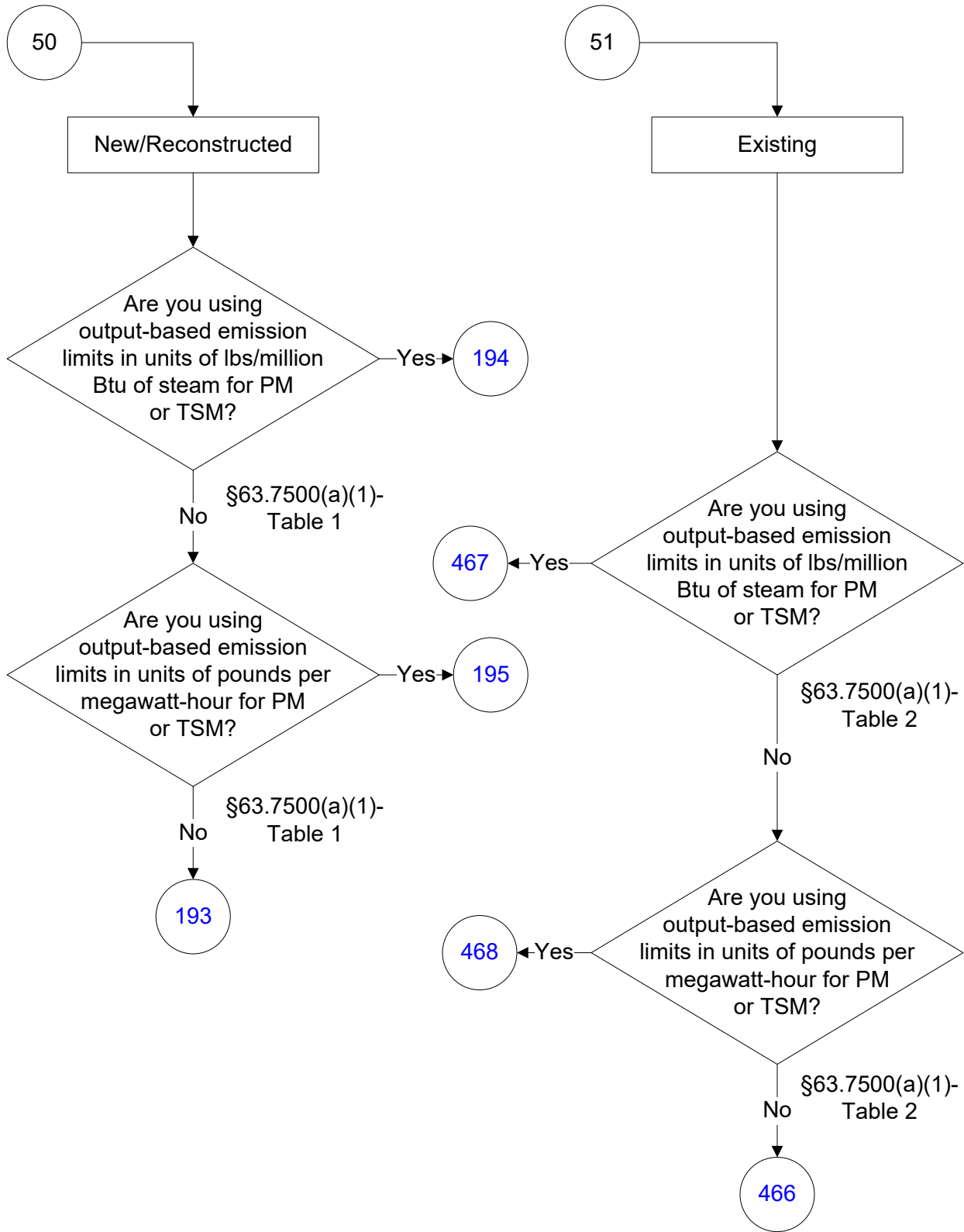

40 CFR Part 63, Subpart DDDDD (31 of 242)

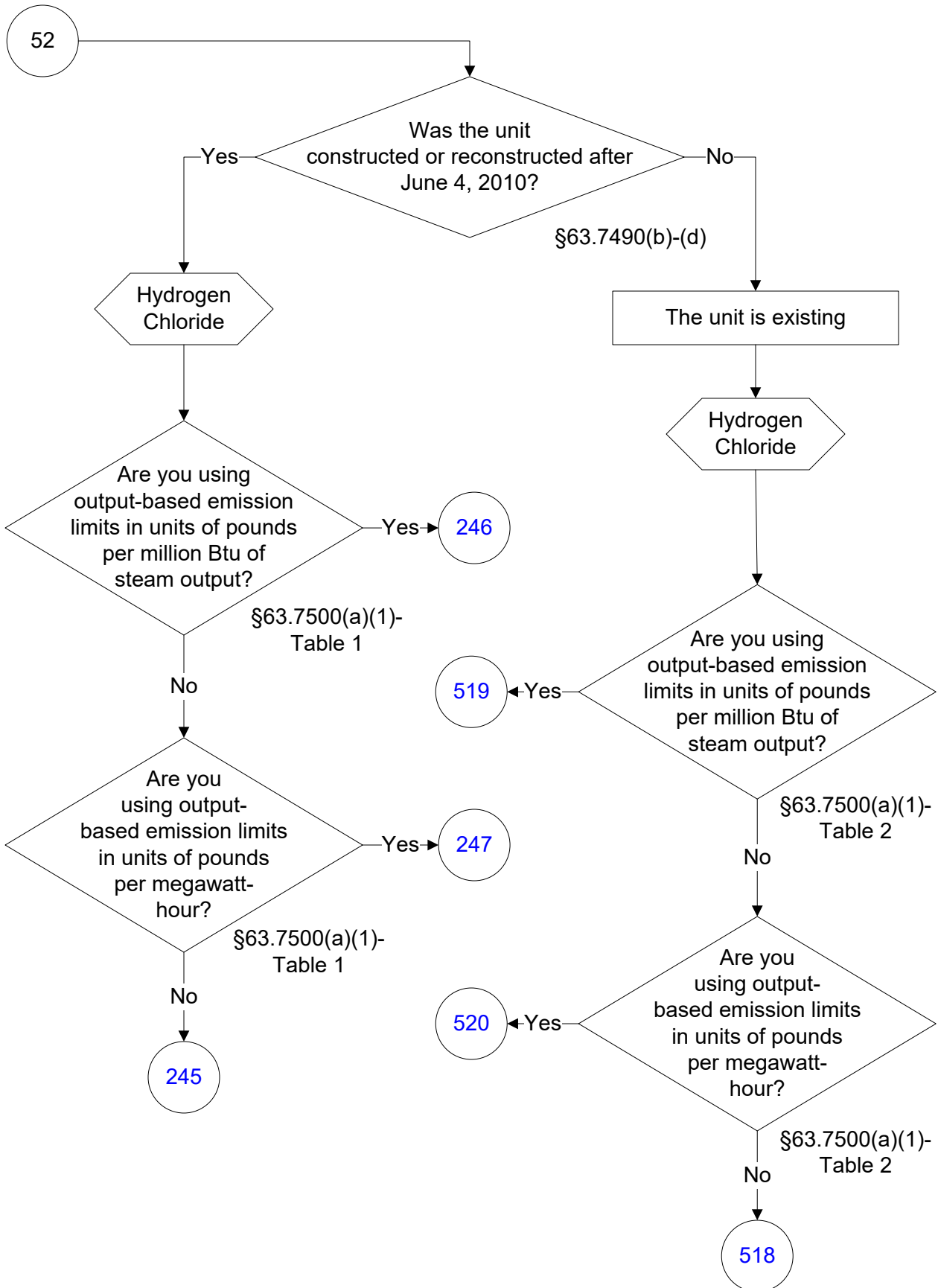

40 CFR Part 63, Subpart DDDDD (32 of 242)

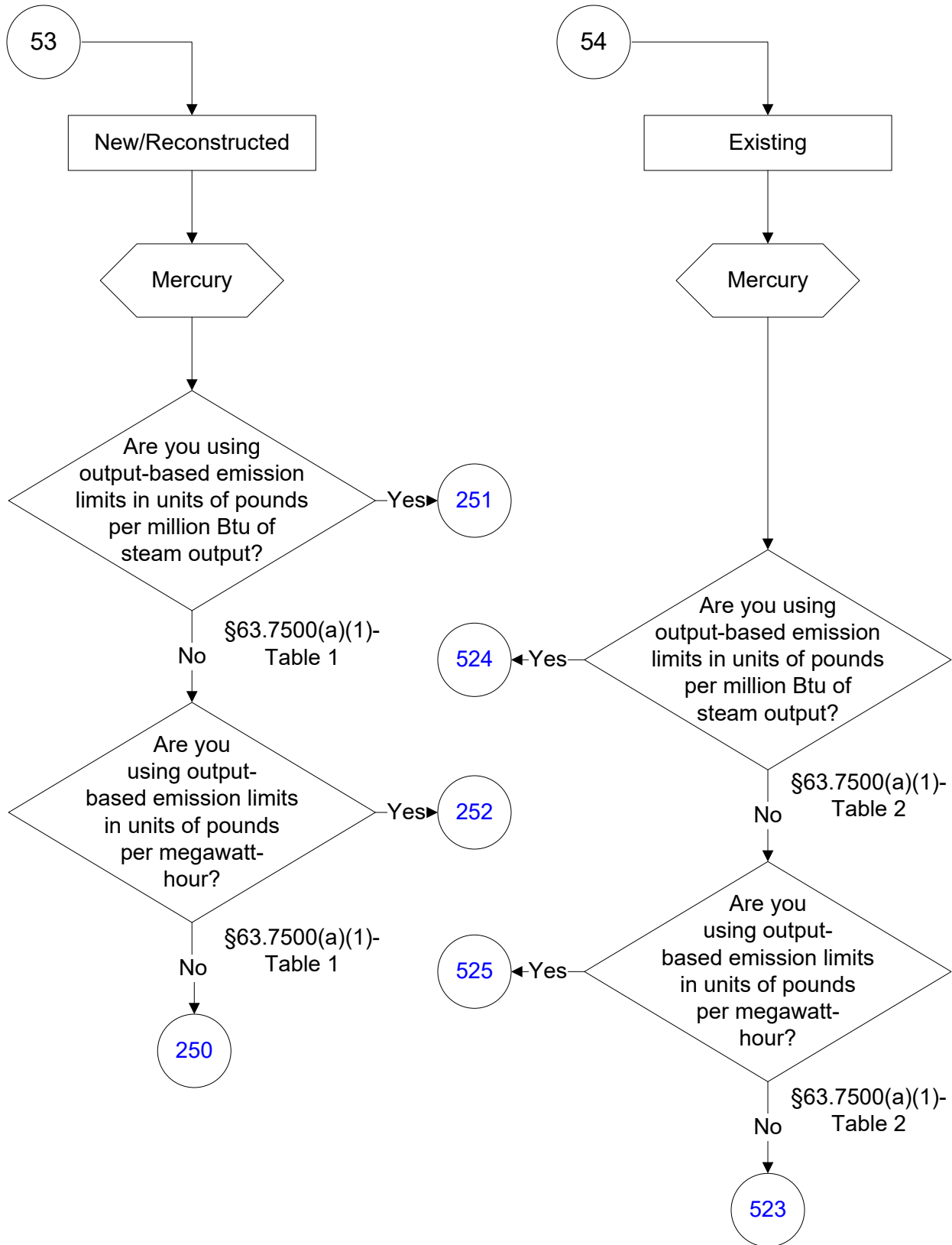

40 CFR Part 63, Subpart DDDDD (33 of 242)

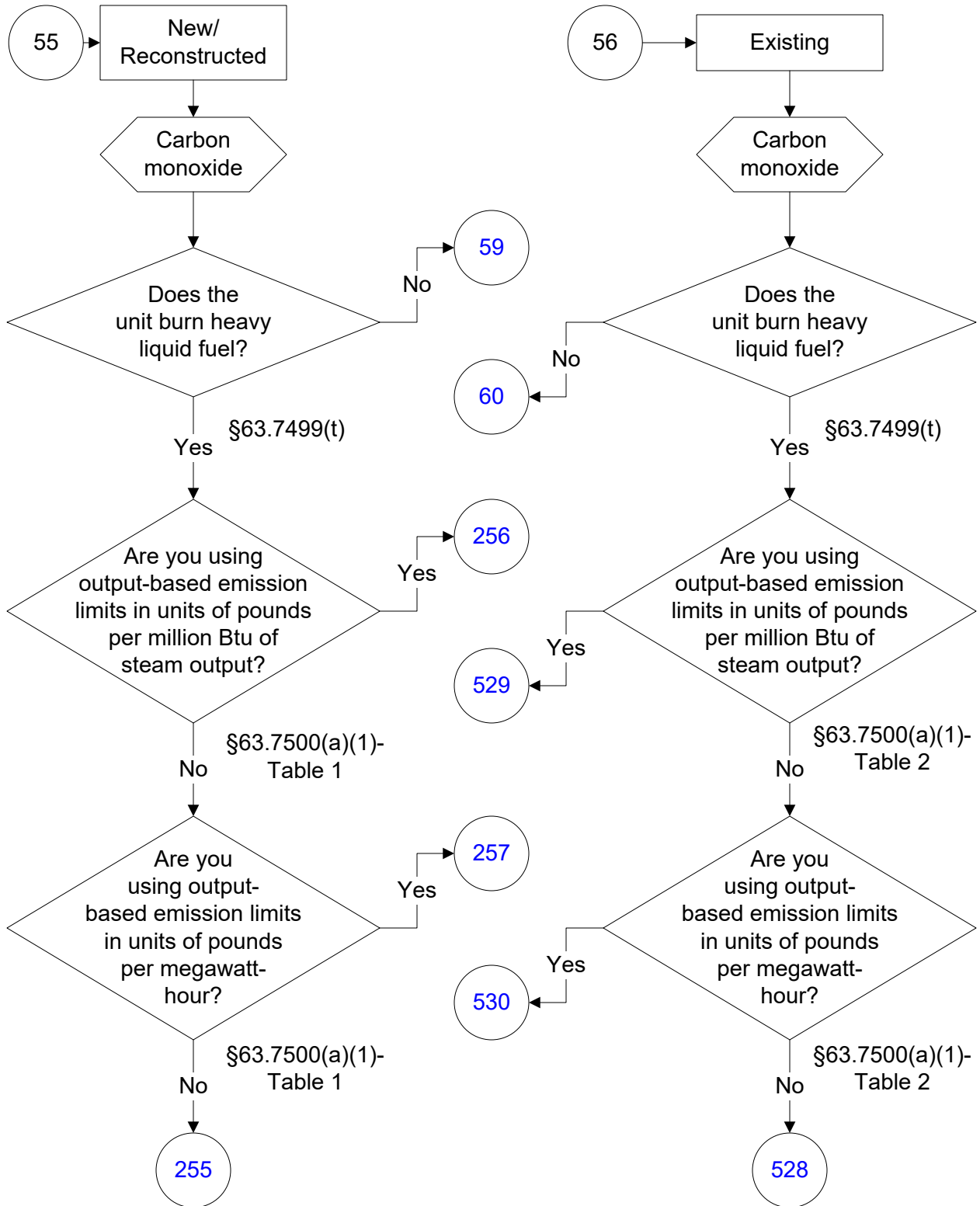

40 CFR Part 63, Subpart DDDDD (34 of 242)

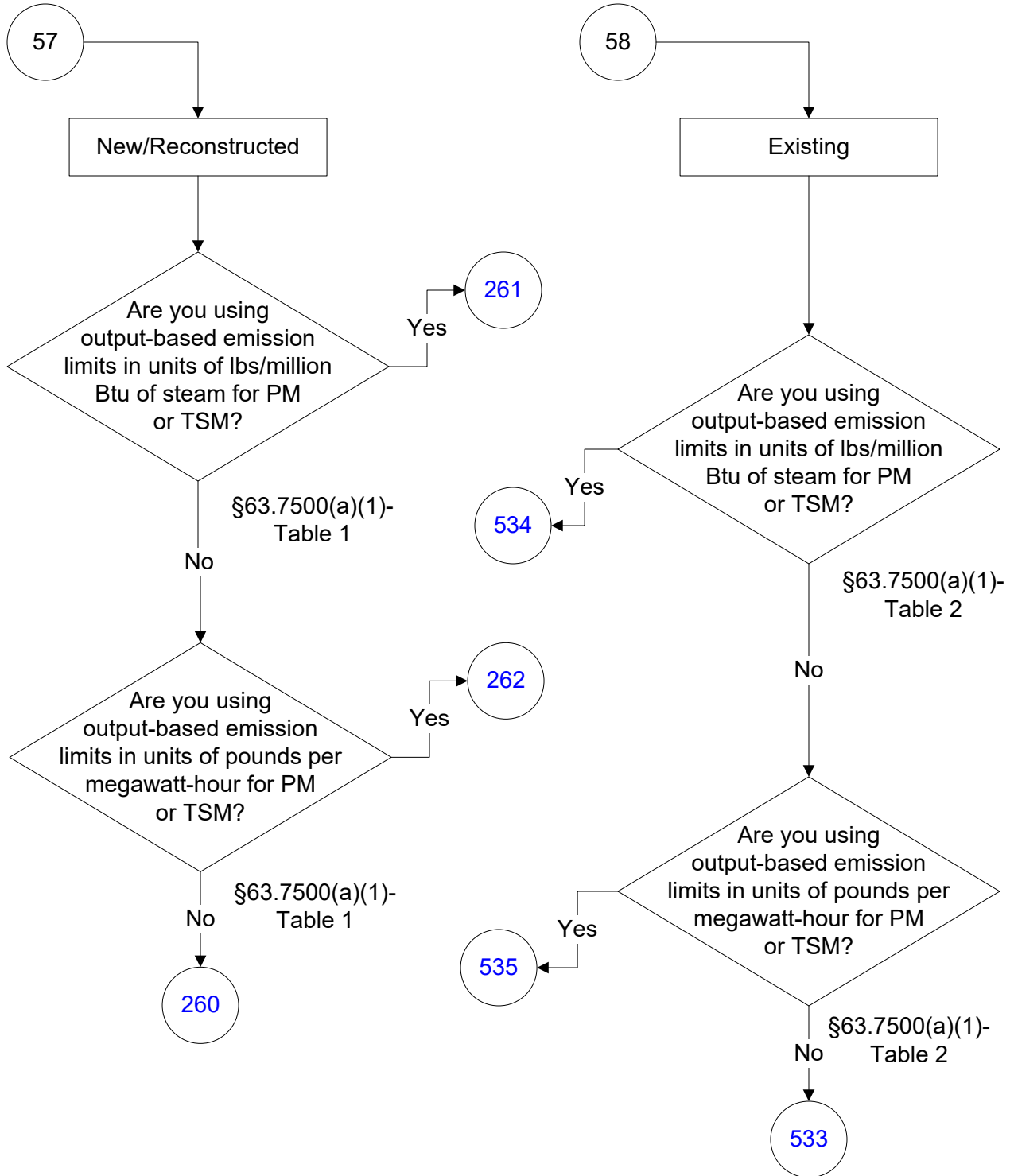

40 CFR Part 63, Subpart DDDDD (35 of 242)

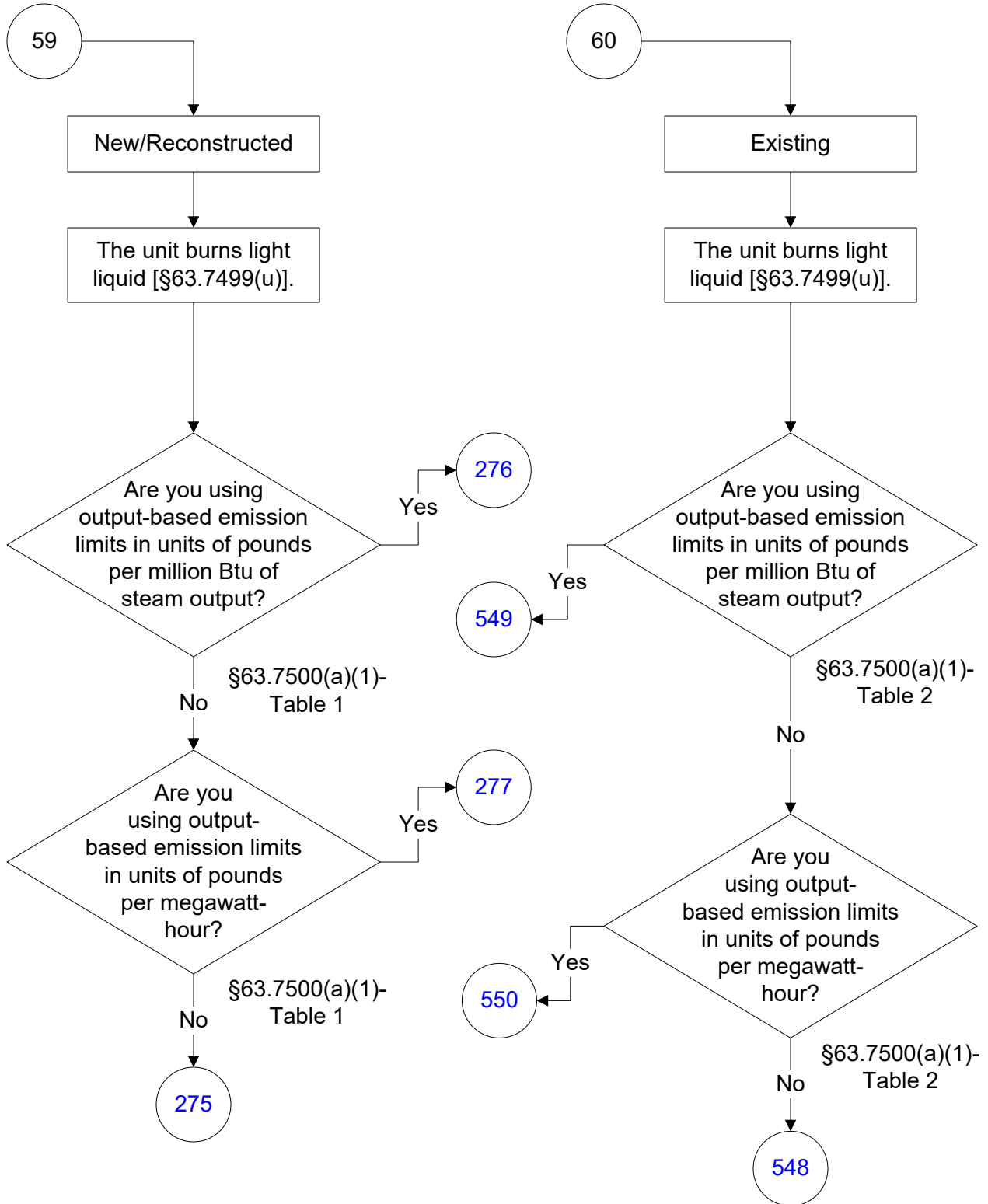

40 CFR Part 63, Subpart DDDDD (36 of 242)

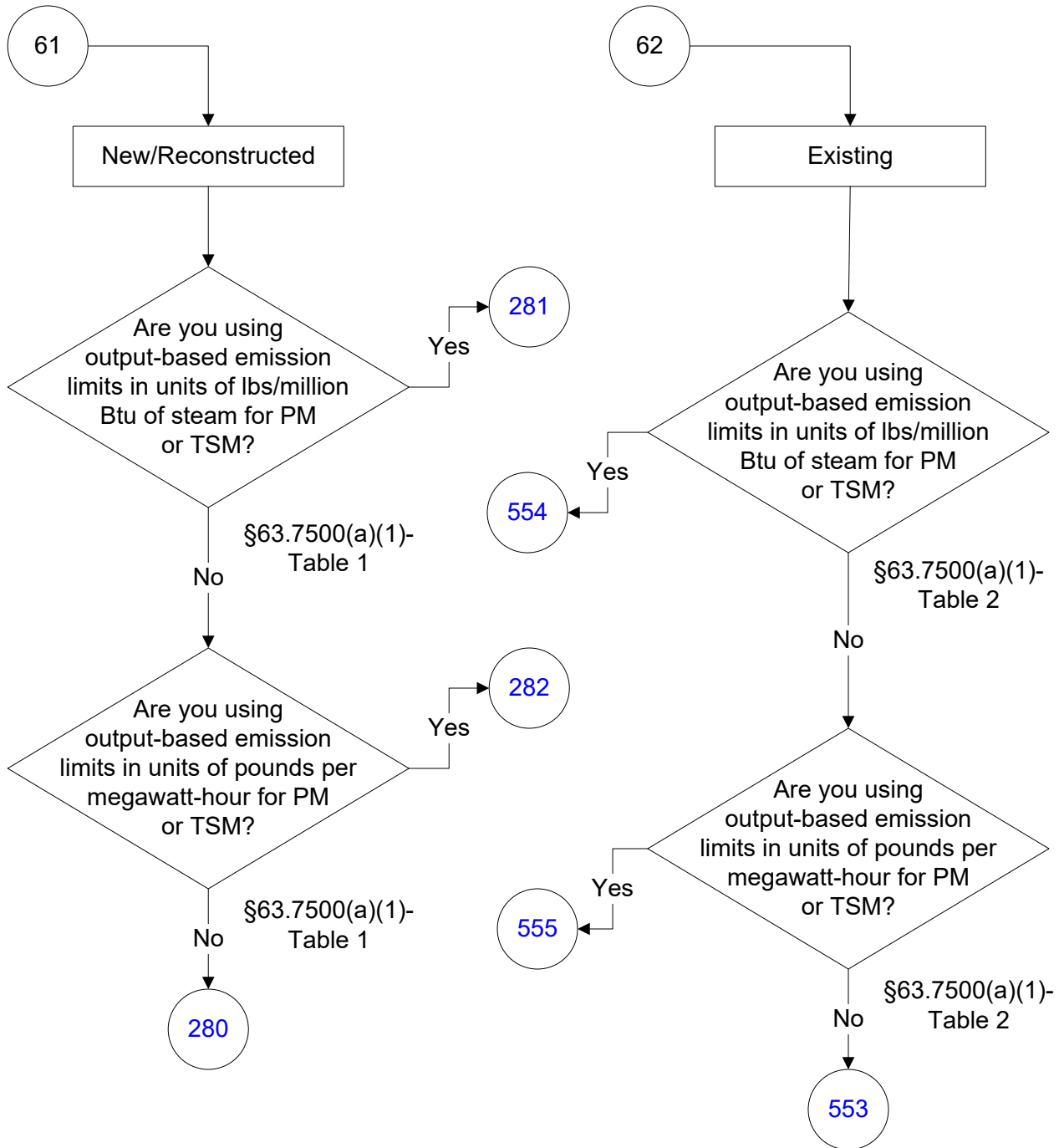

40 CFR Part 63, Subpart DDDDD (37 of 242)

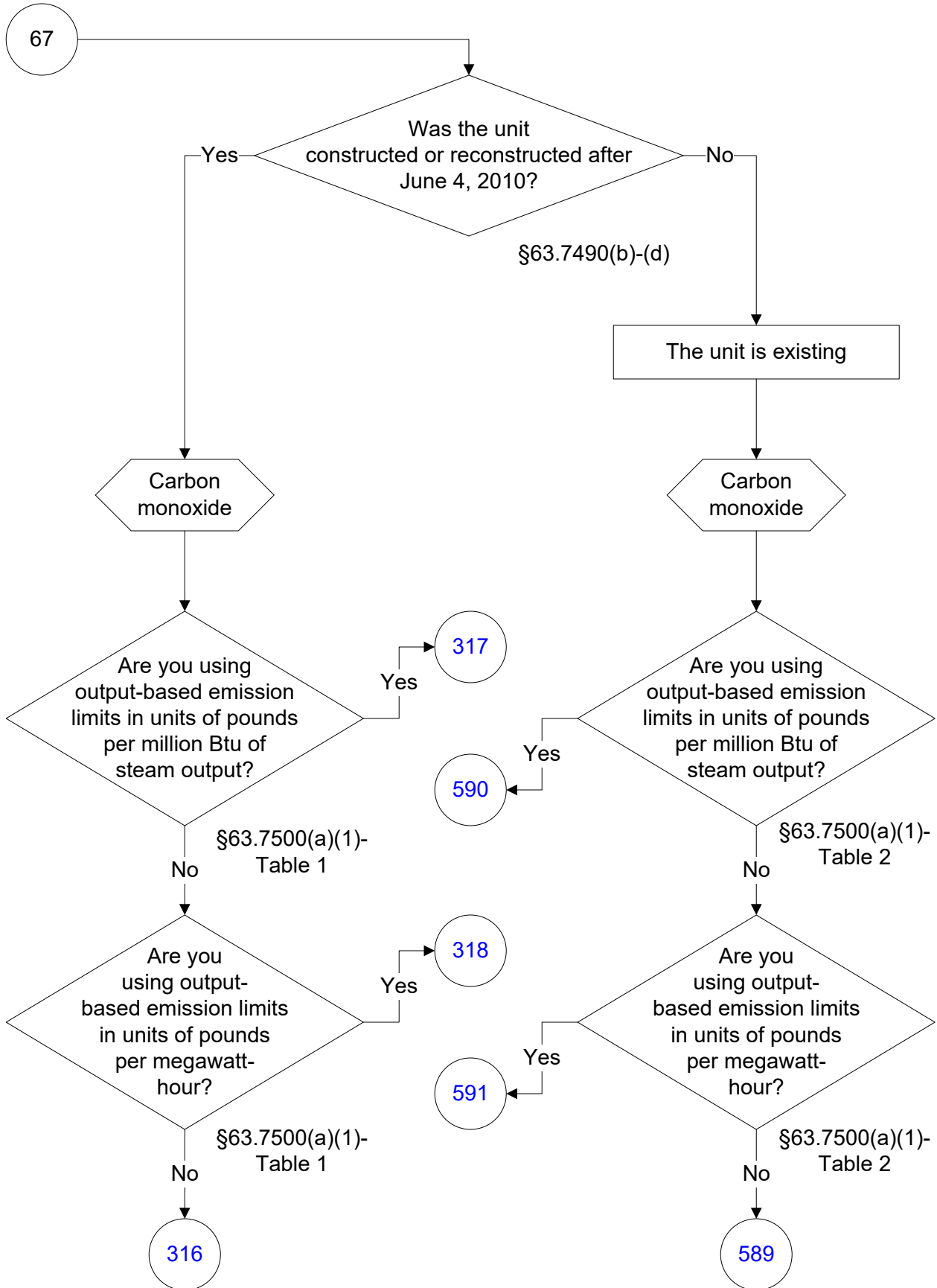

40 CFR Part 63, Subpart DDDDD (38 of 242)

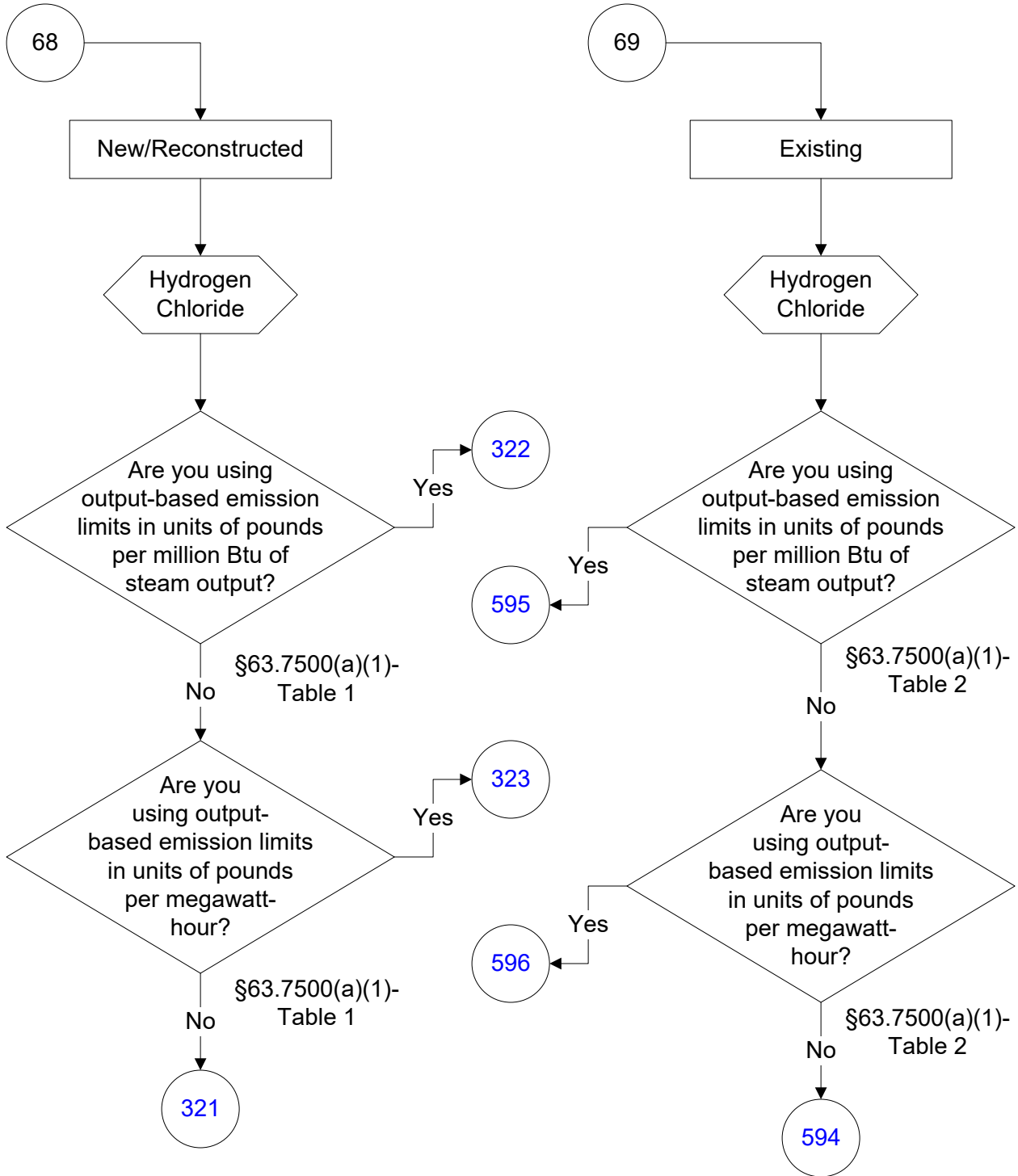

40 CFR Part 63, Subpart DDDDD (39 of 242)

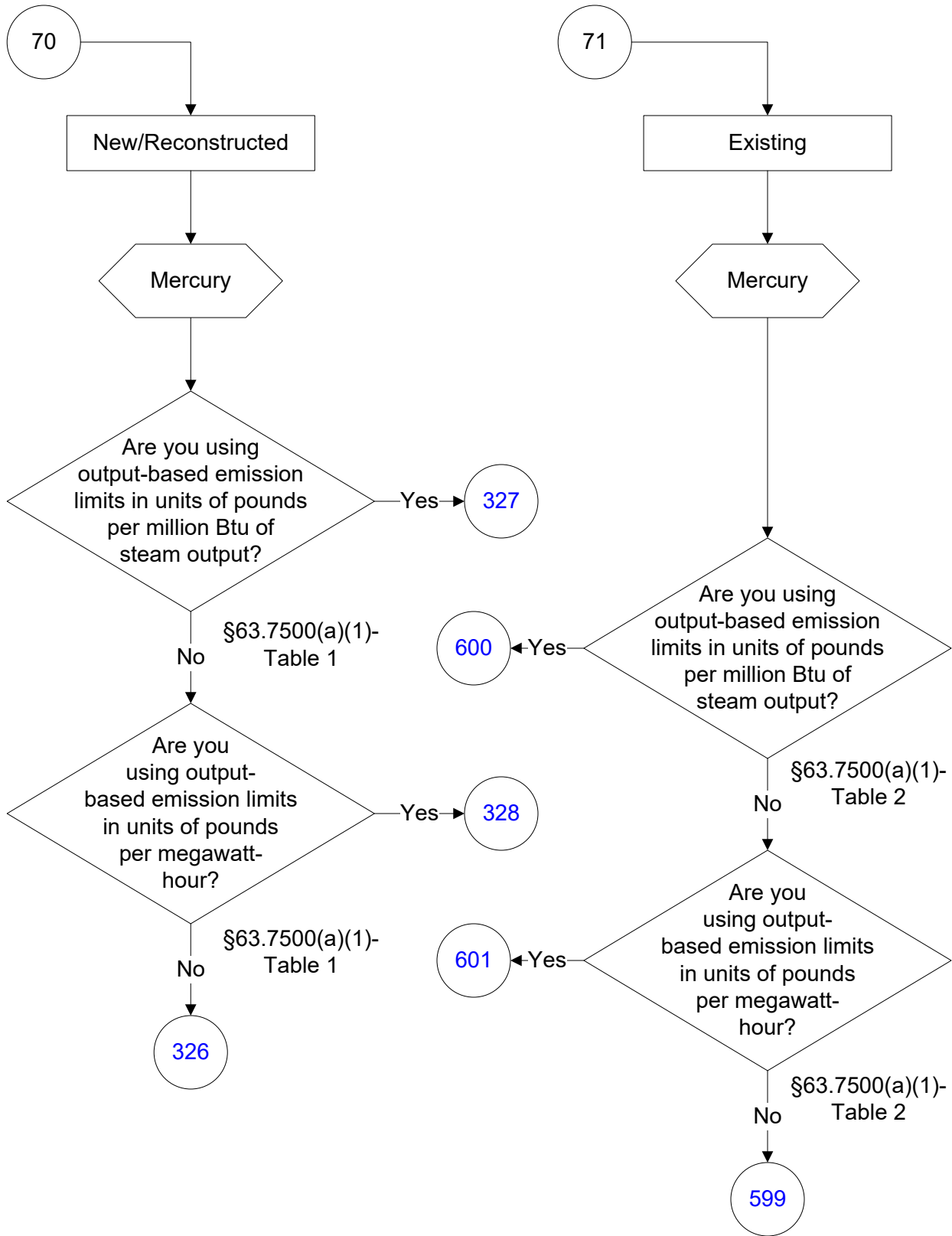

40 CFR Part 63, Subpart DDDDD (40 of 242)

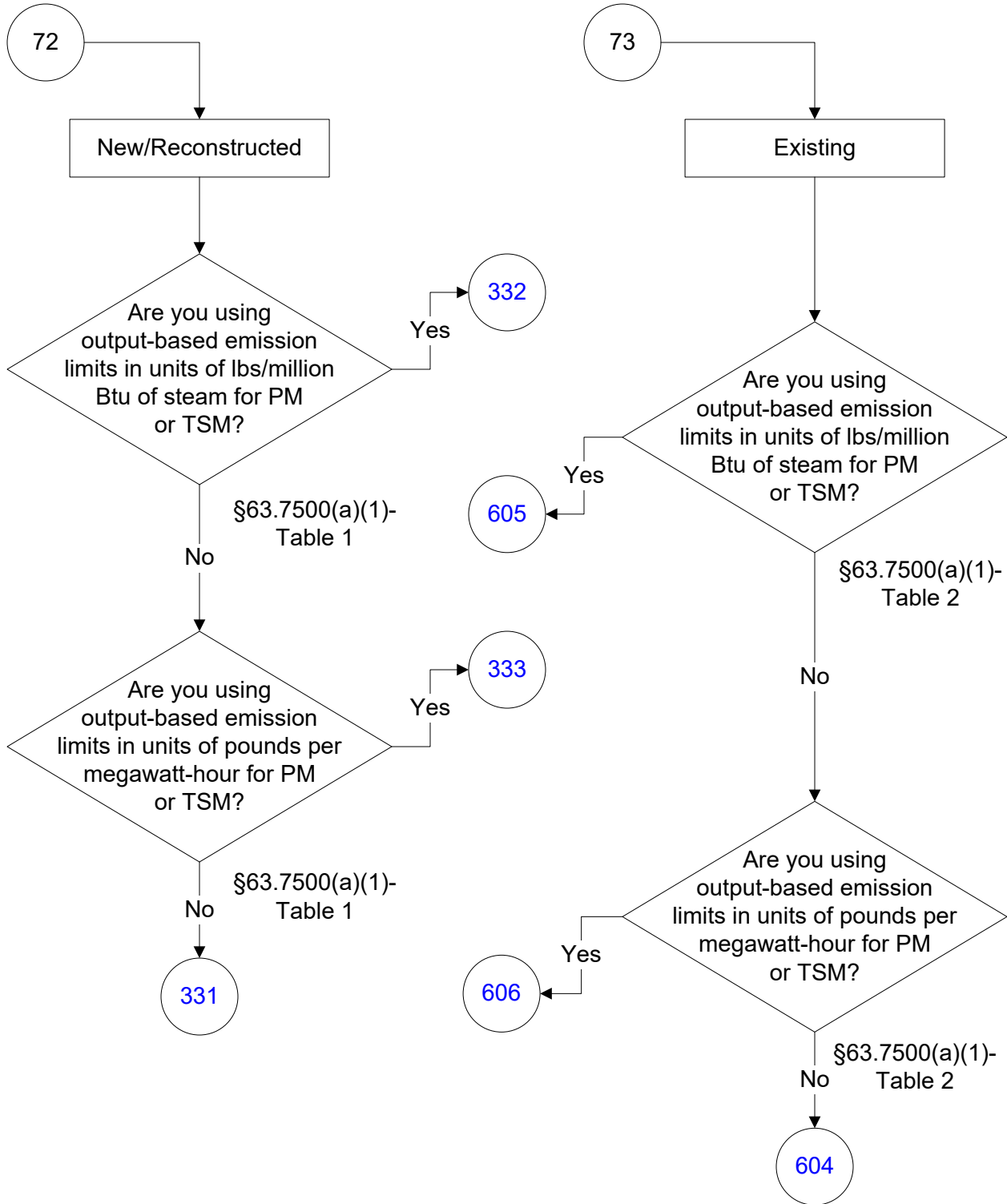

40 CFR Part 63, Subpart DDDDD (41 of 242)

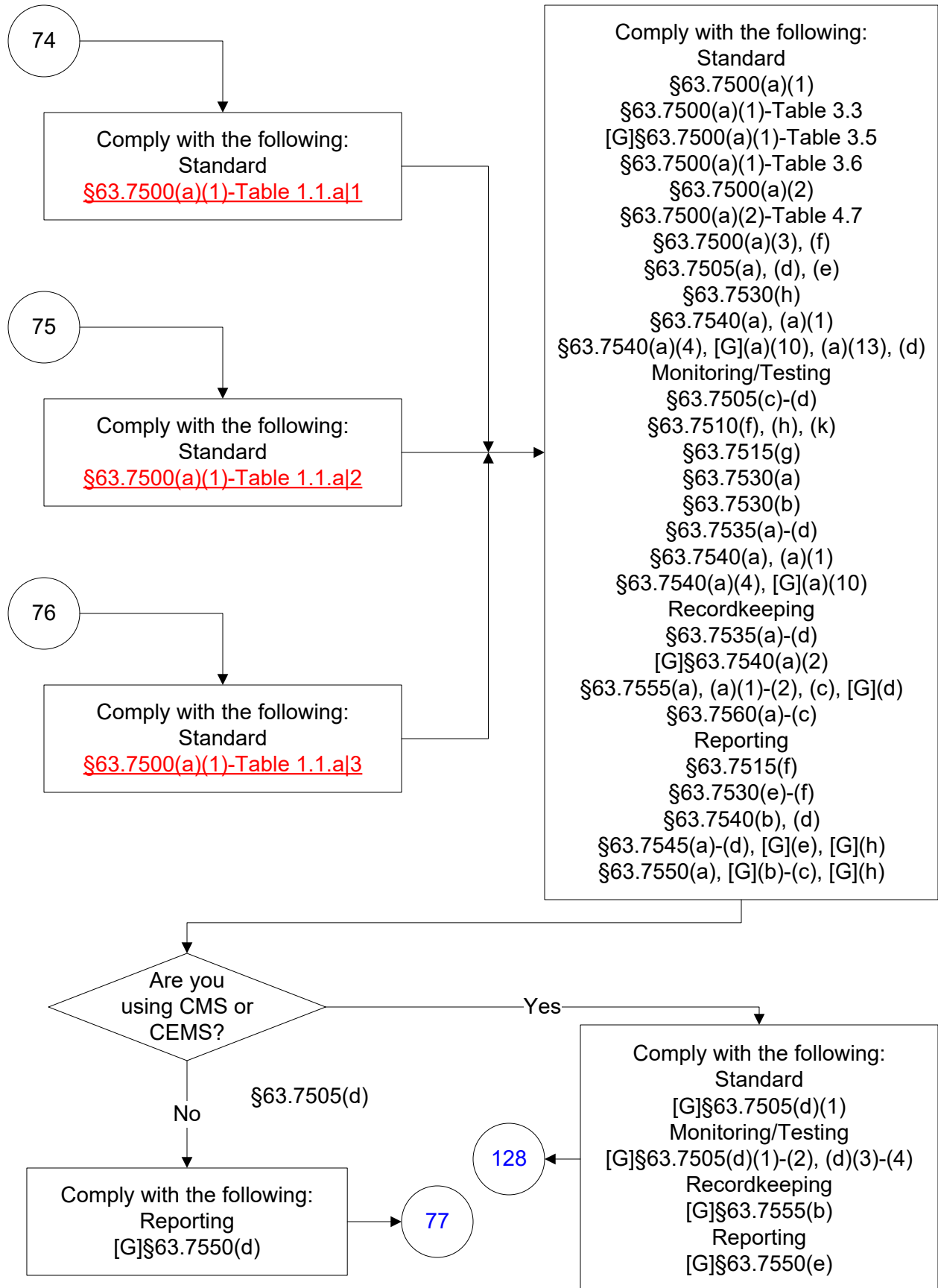

40 CFR Part 63, Subpart DDDDD (42 of 242)

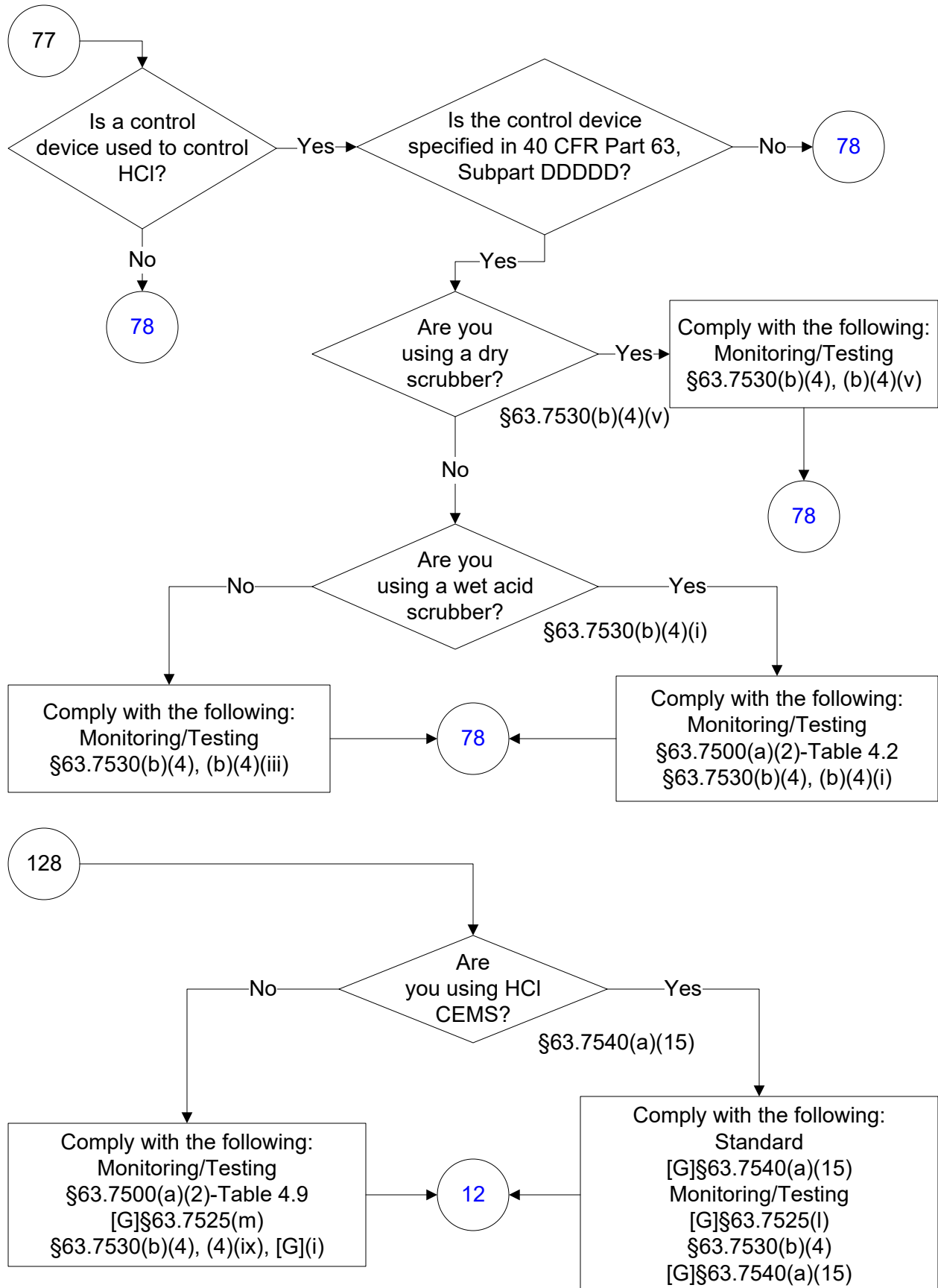

40 CFR Part 63, Subpart DDDDD (43 of 242)

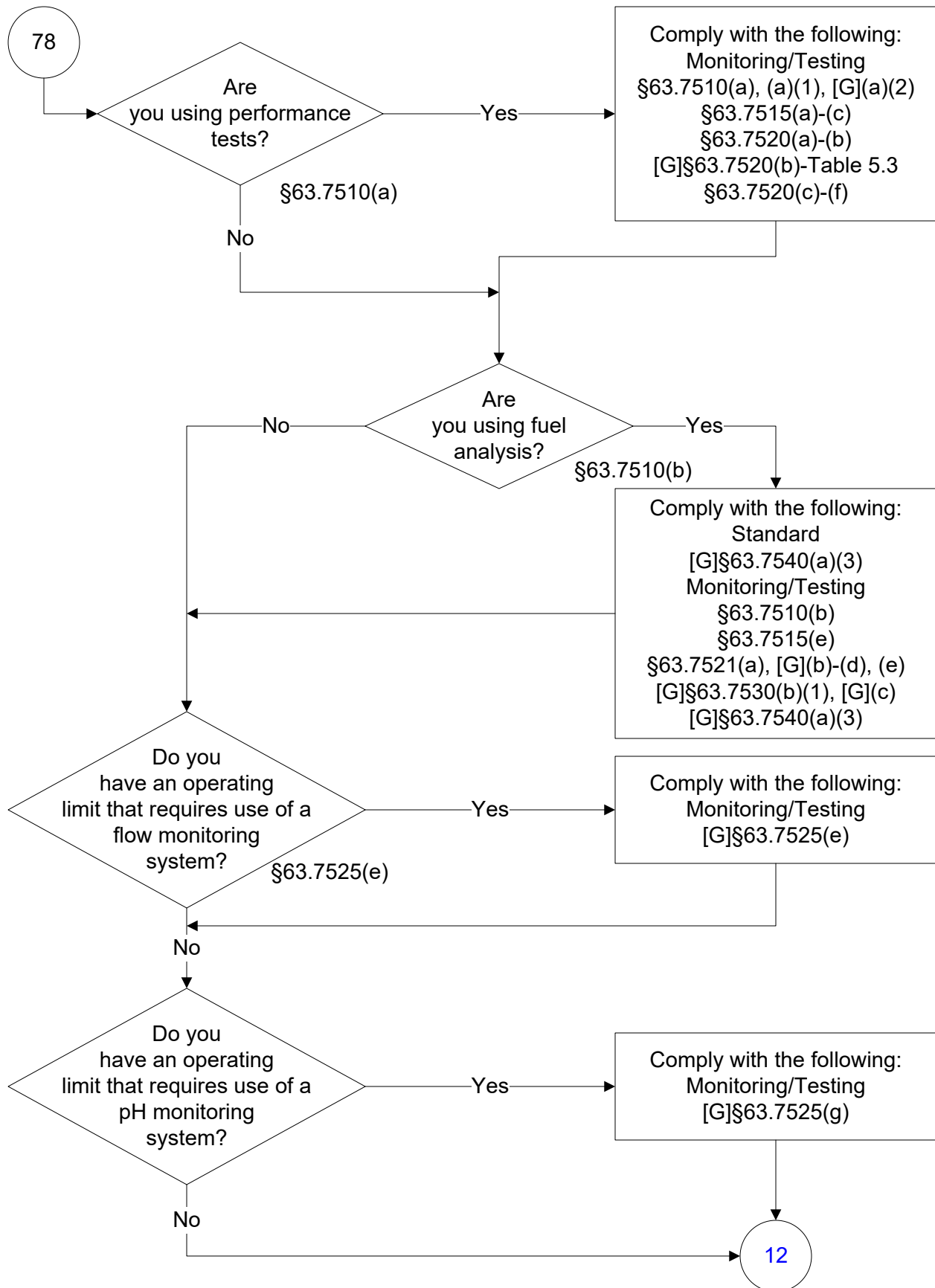

40 CFR Part 63, Subpart DDDDD (44 of 242)

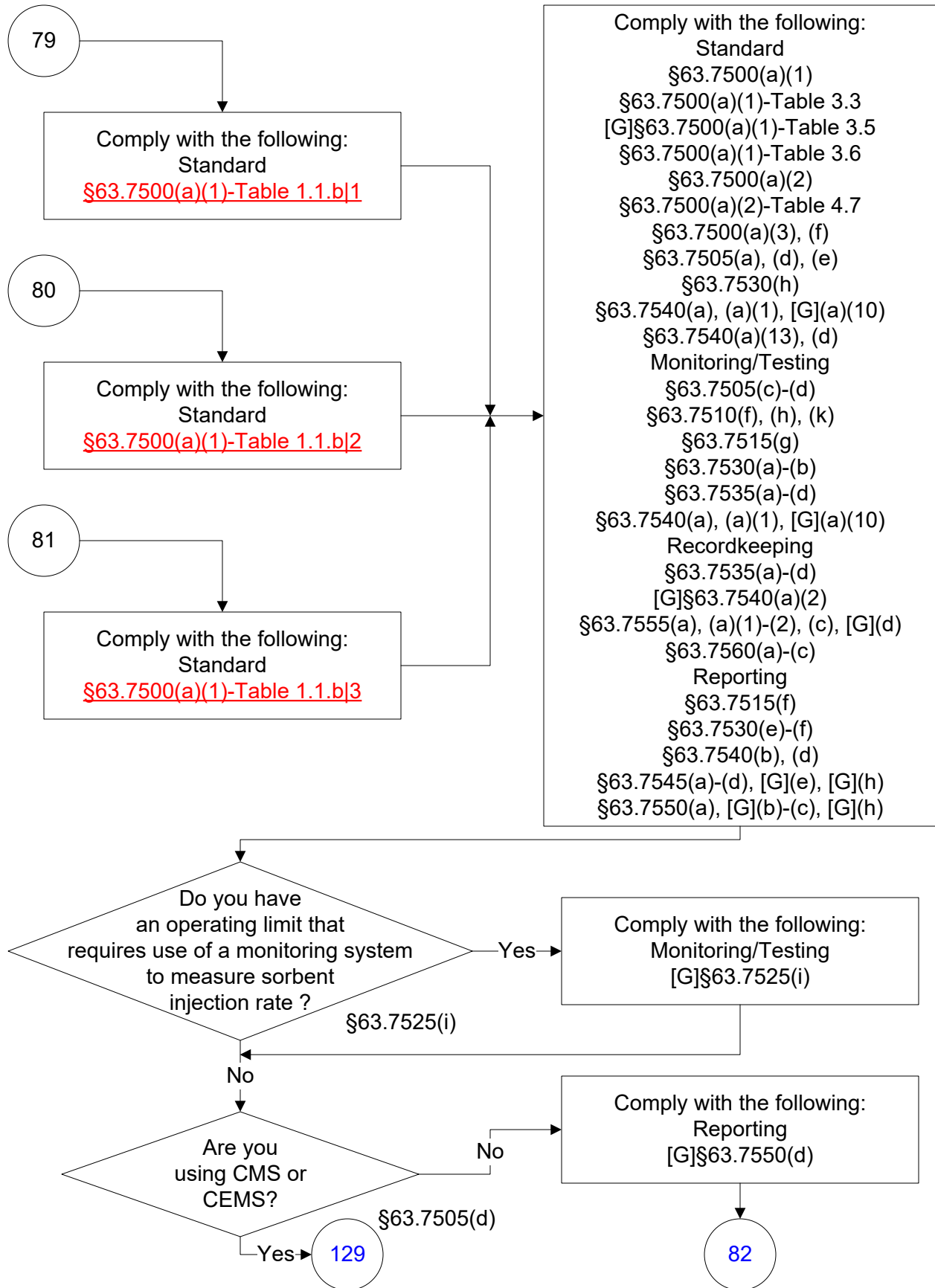

40 CFR Part 63, Subpart DDDDD (45 of 242)

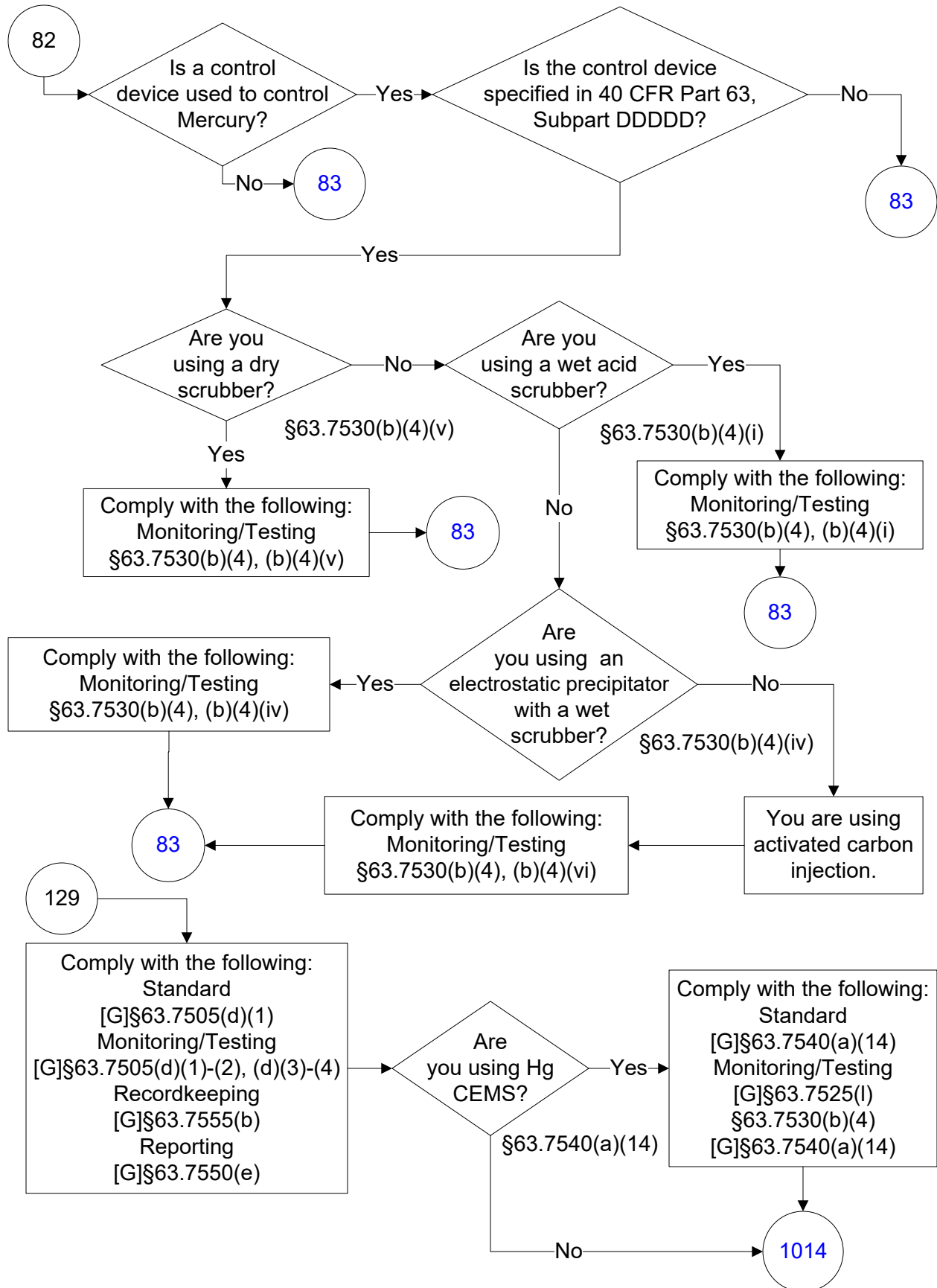

40 CFR Part 63, Subpart DDDDD (46 of 242)

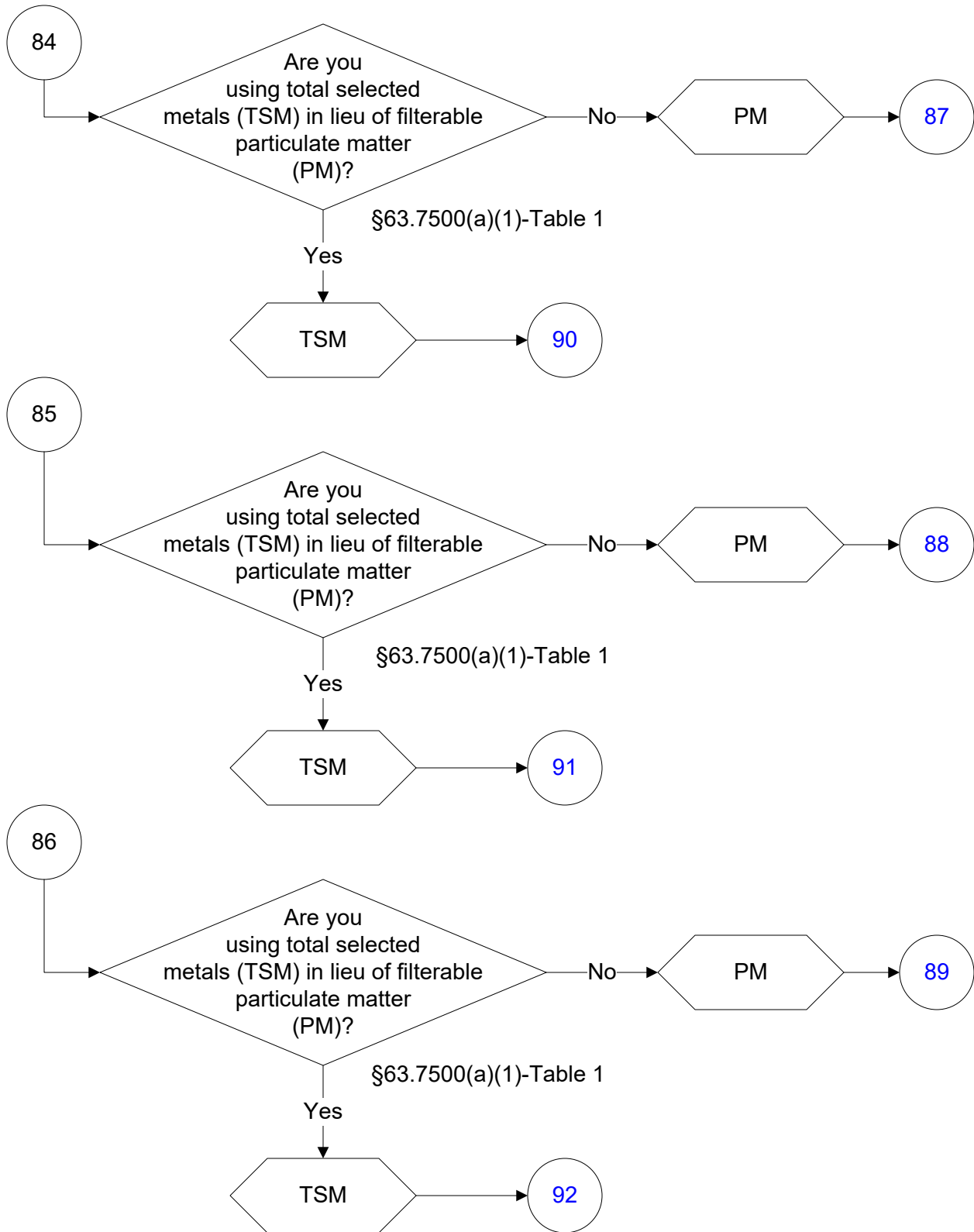

40 CFR Part 63, Subpart DDDDD (47 of 242)

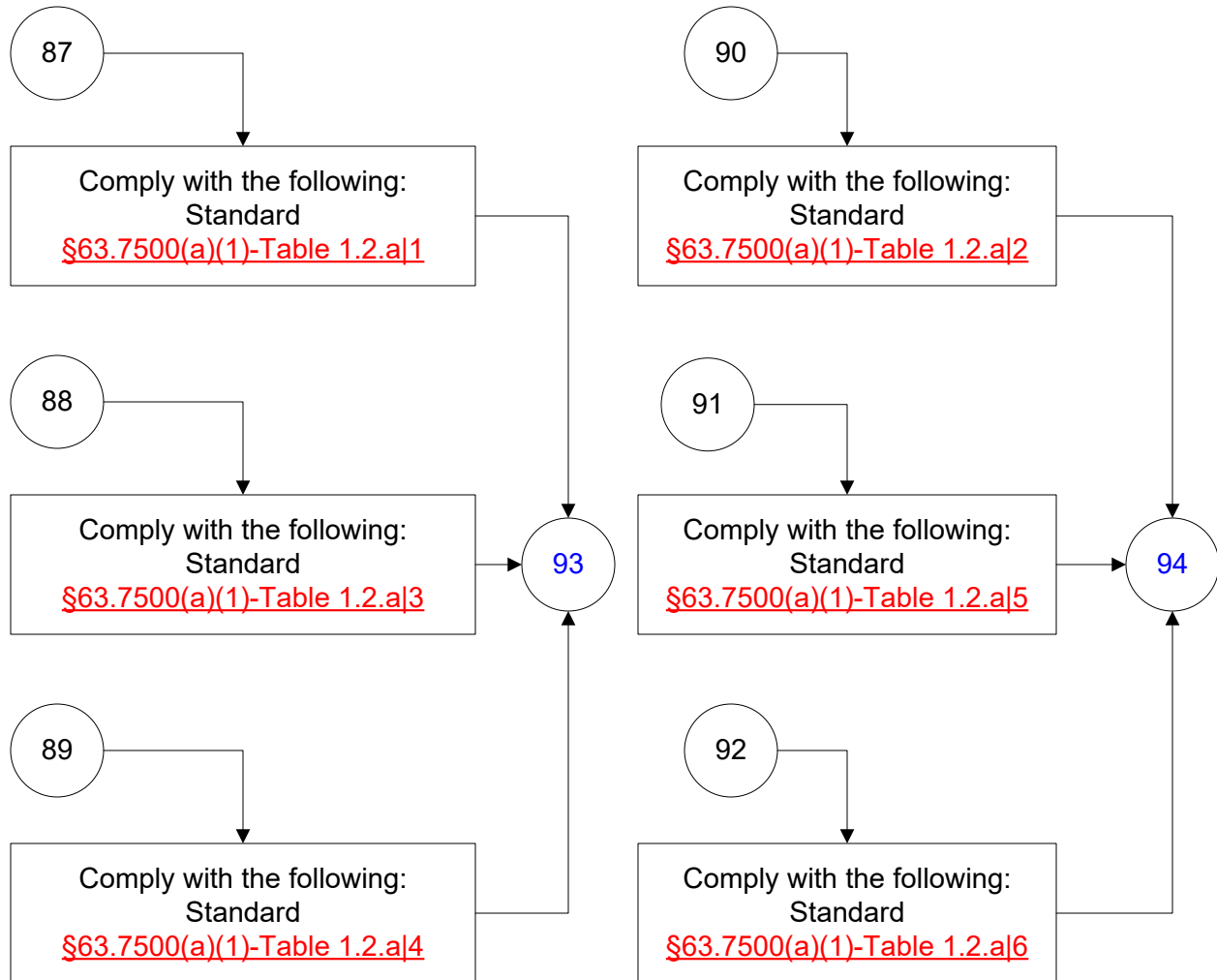

40 CFR Part 63, Subpart DDDDD (48 of 242)

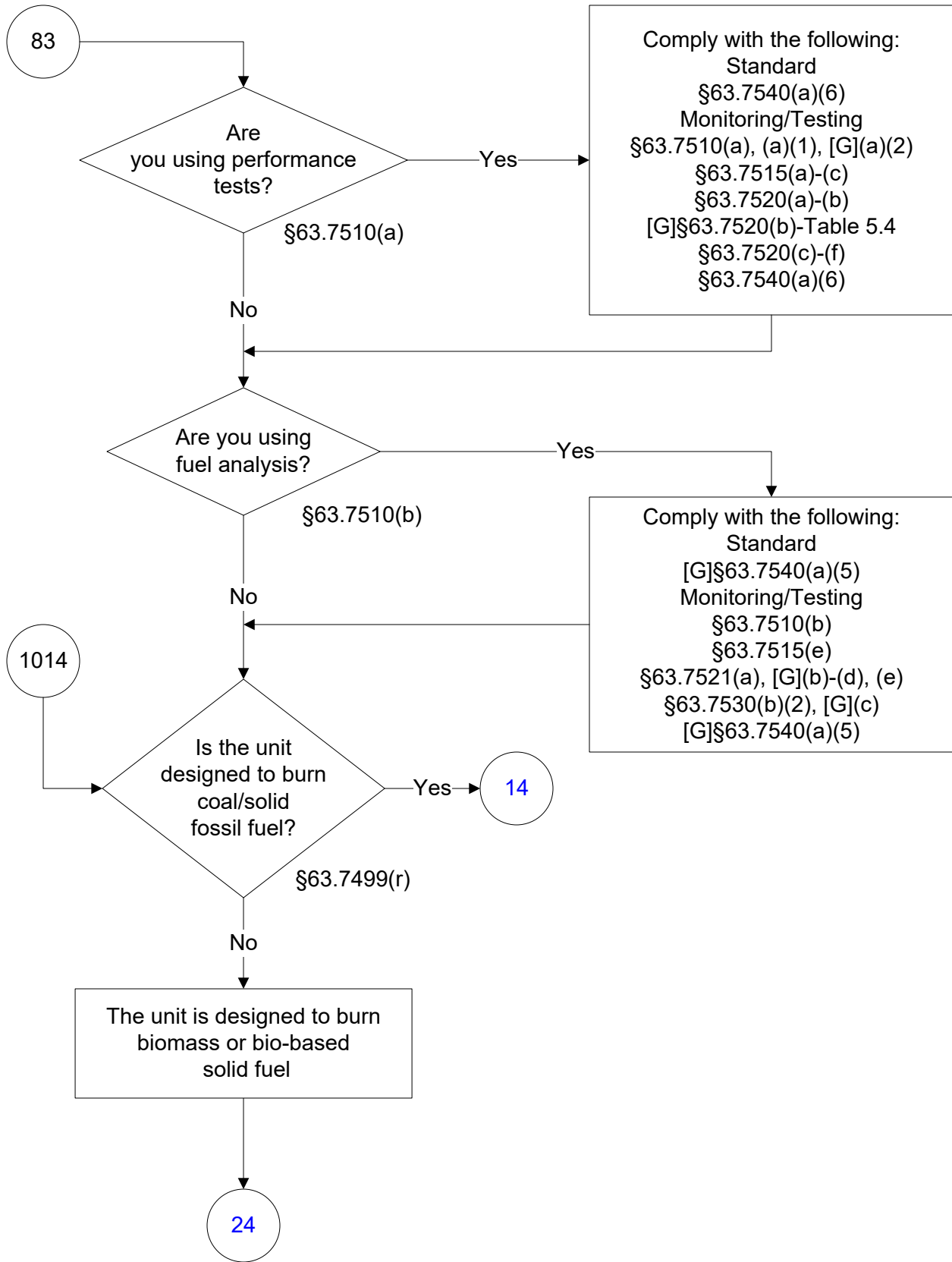

40 CFR Part 63, Subpart DDDDD
(49 of 242)

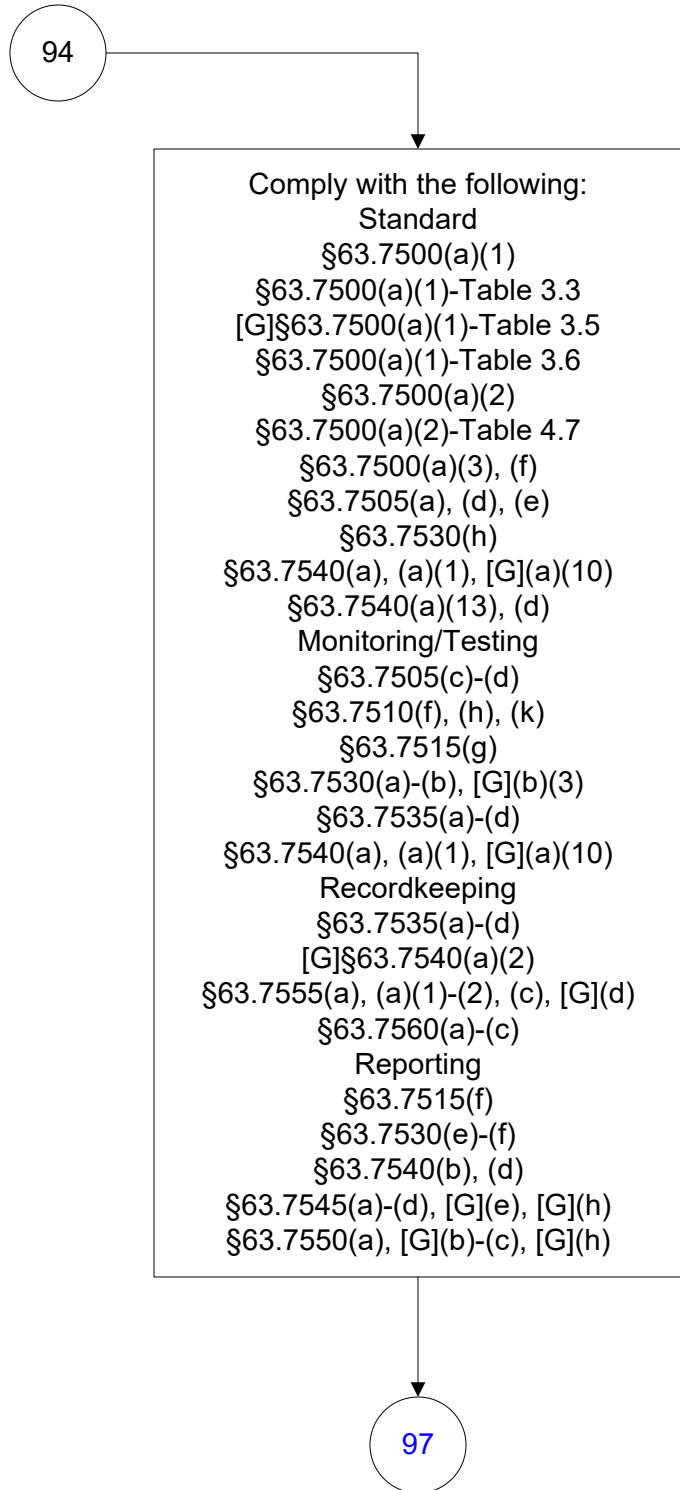
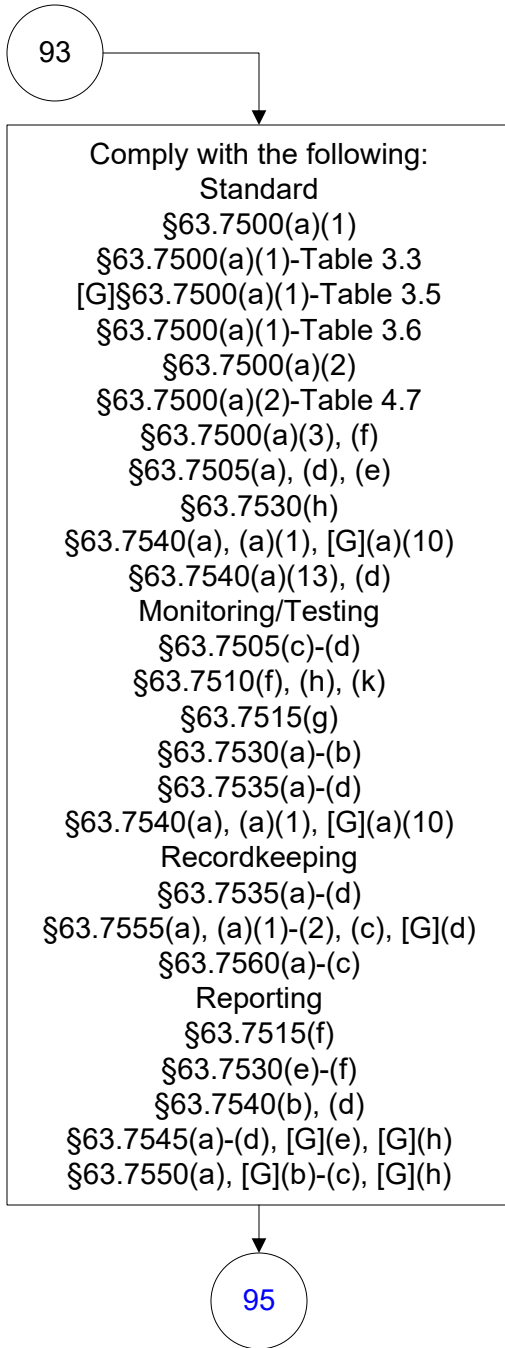

40 CFR Part 63, Subpart DDDDD (50 of 242)

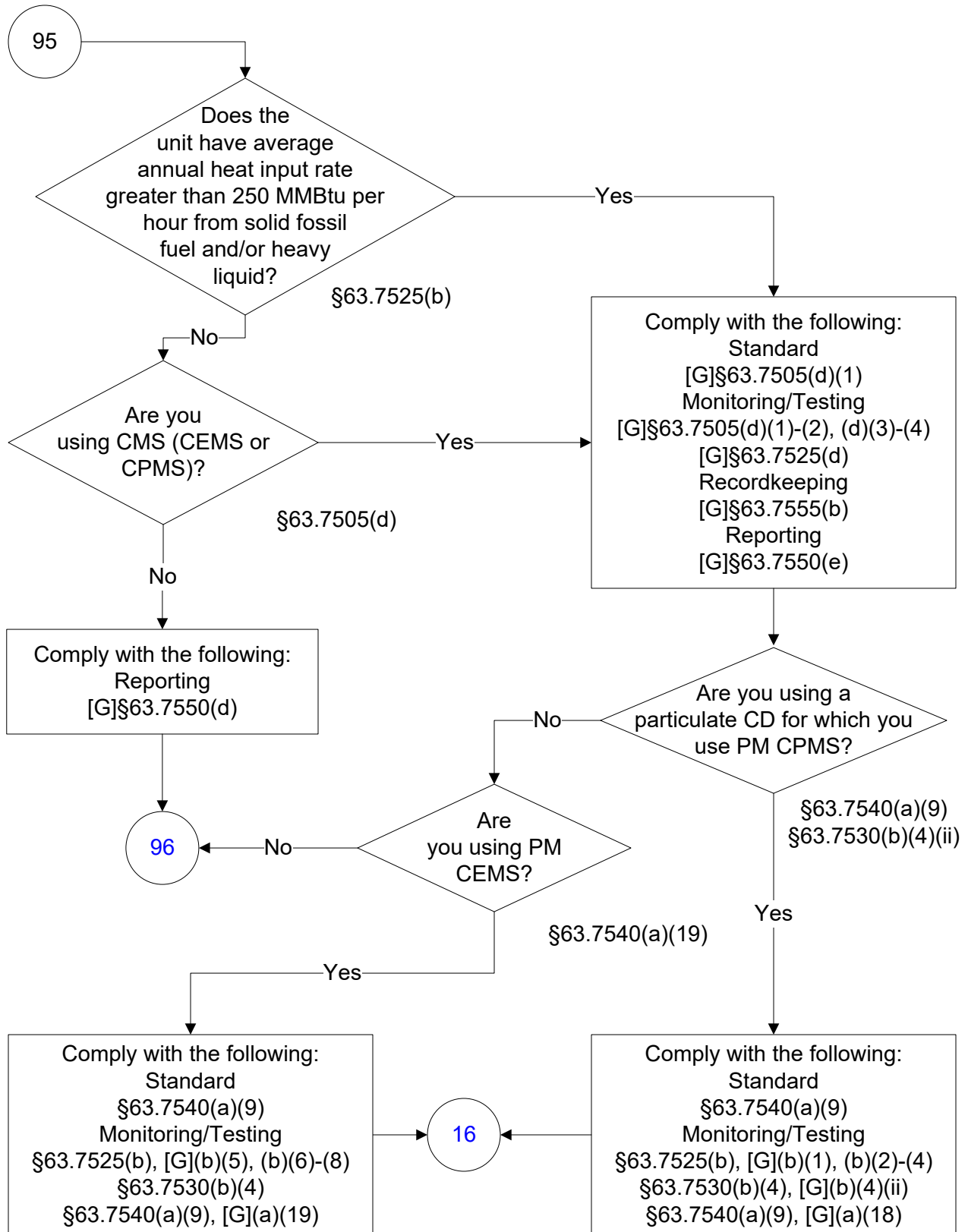

40 CFR Part 63, Subpart DDDDD (51 of 242)

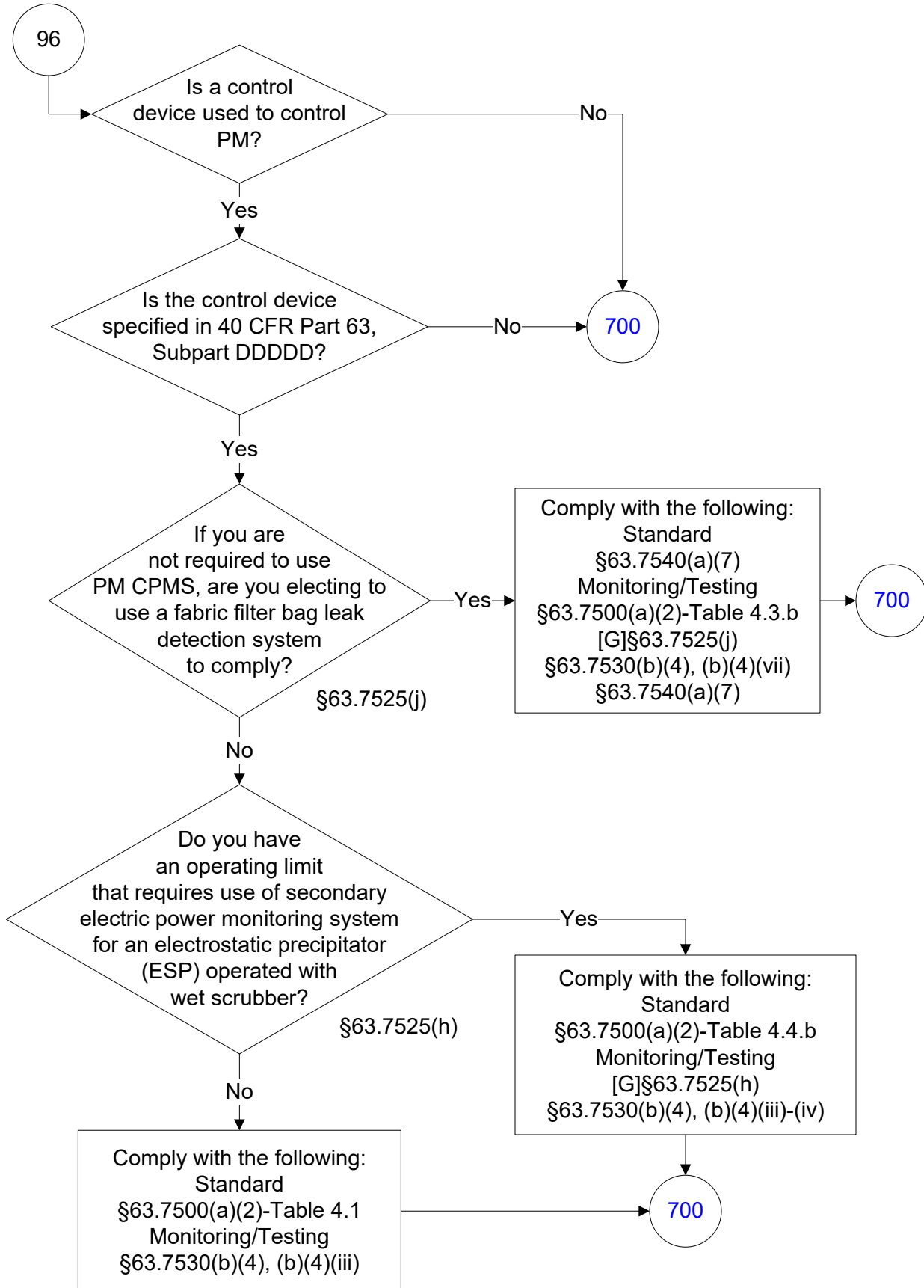

**40 CFR Part 63, Subpart DDDDD
(52 of 242)**

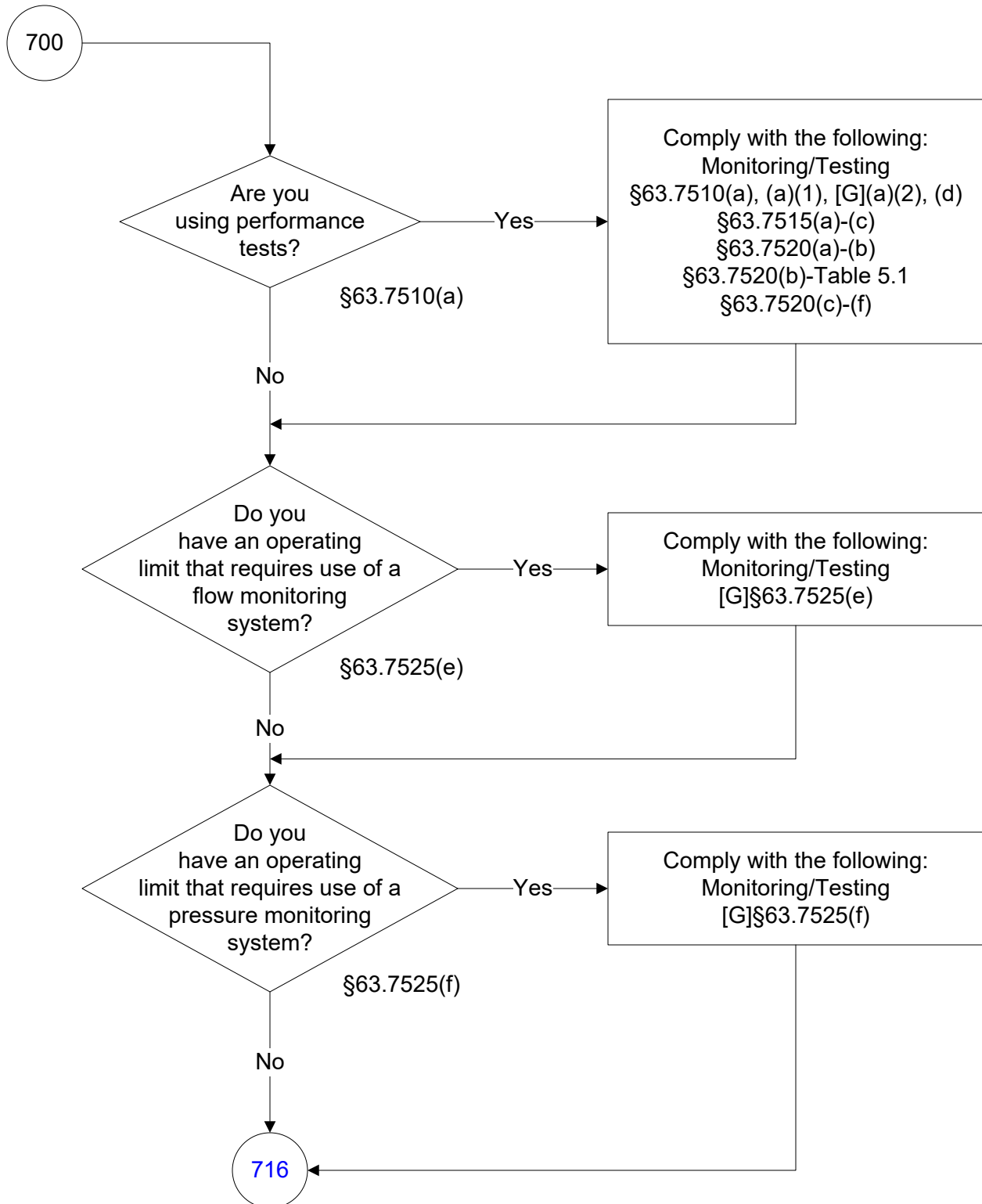

**40 CFR Part 63, Subpart DDDDD
(53 of 242)**

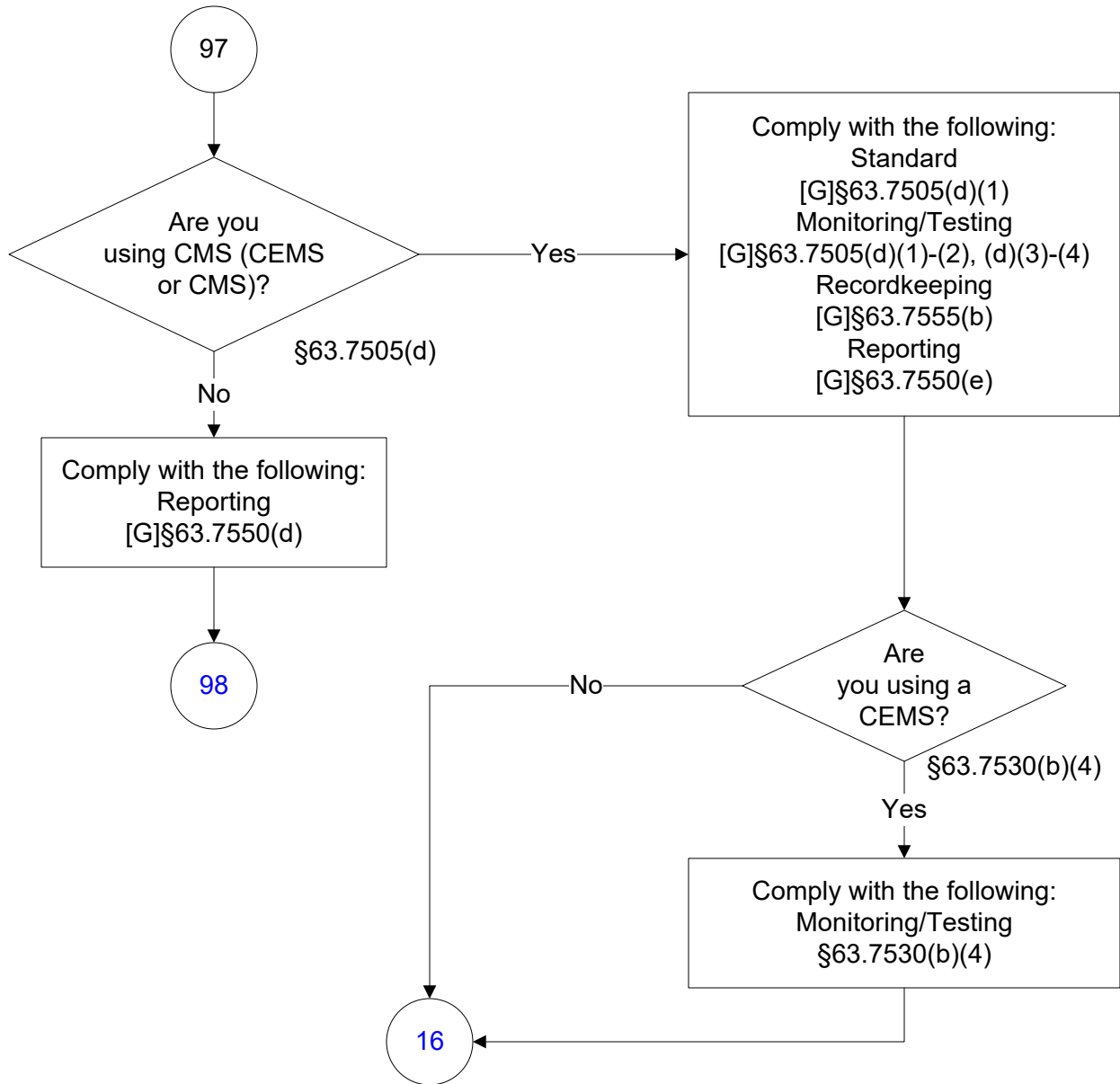

40 CFR Part 63, Subpart DDDDD (54 of 242)

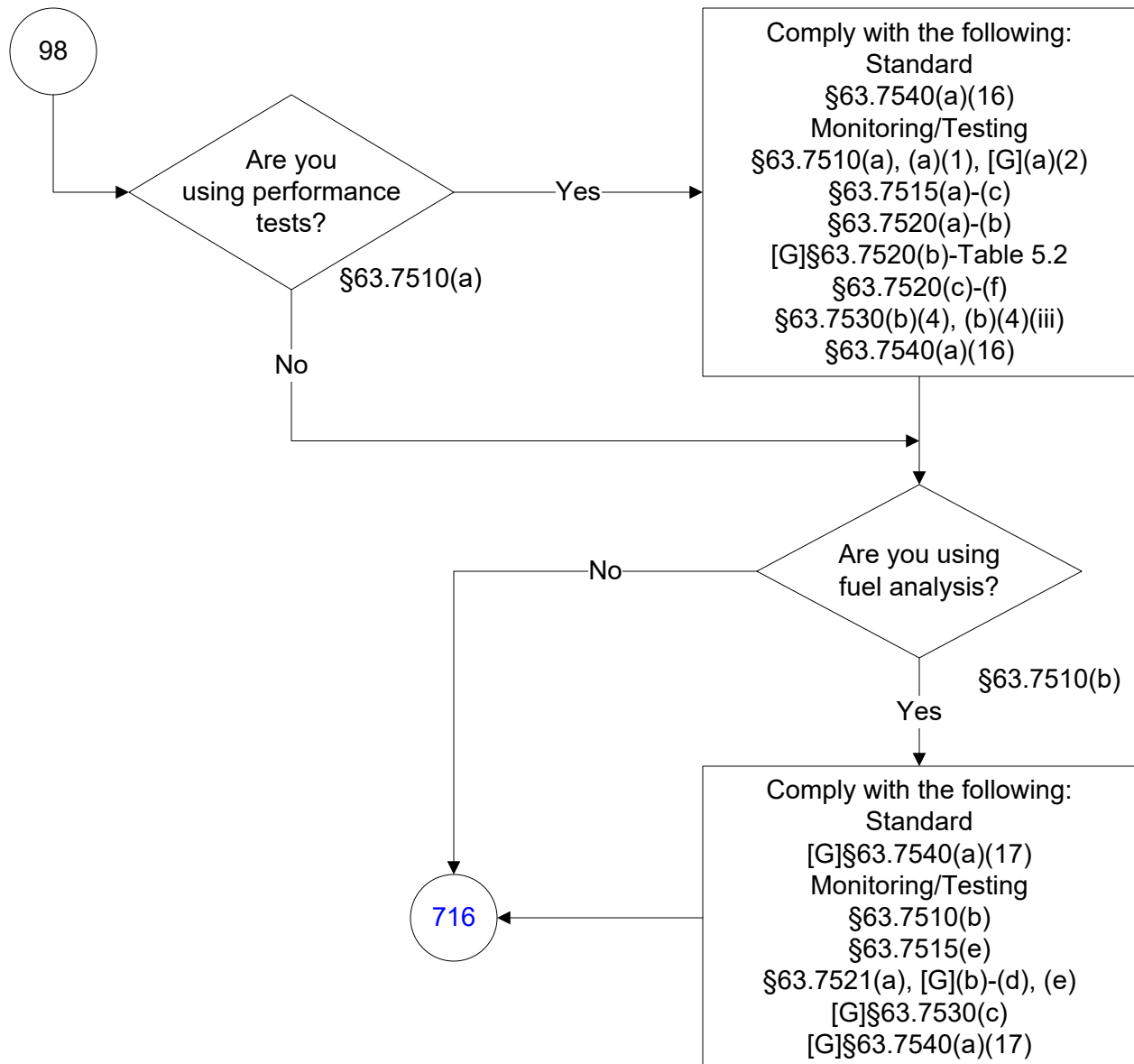

40 CFR Part 63, Subpart DDDDD (55 of 242)

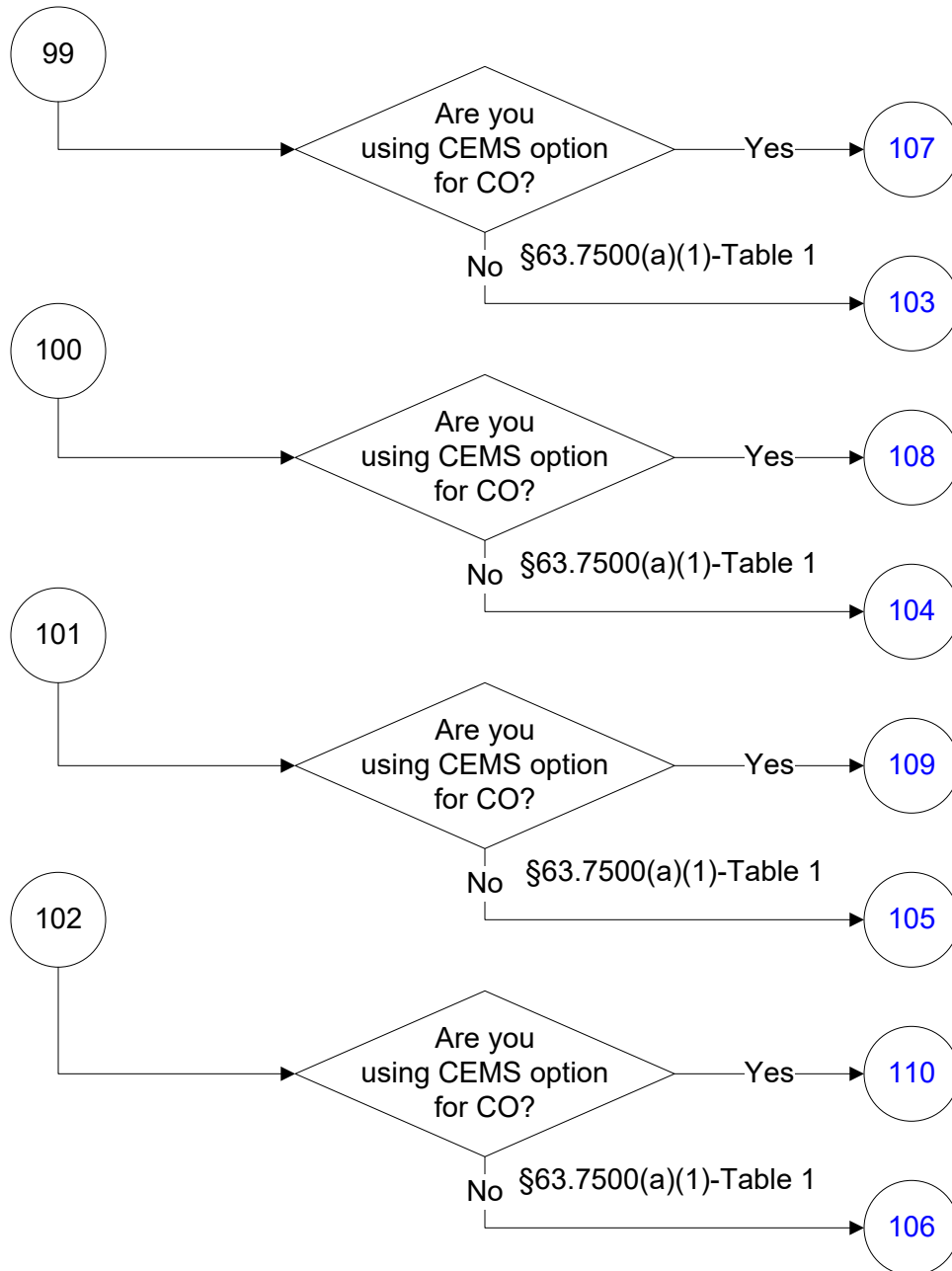

40 CFR Part 63, Subpart DDDDD (56 of 242)

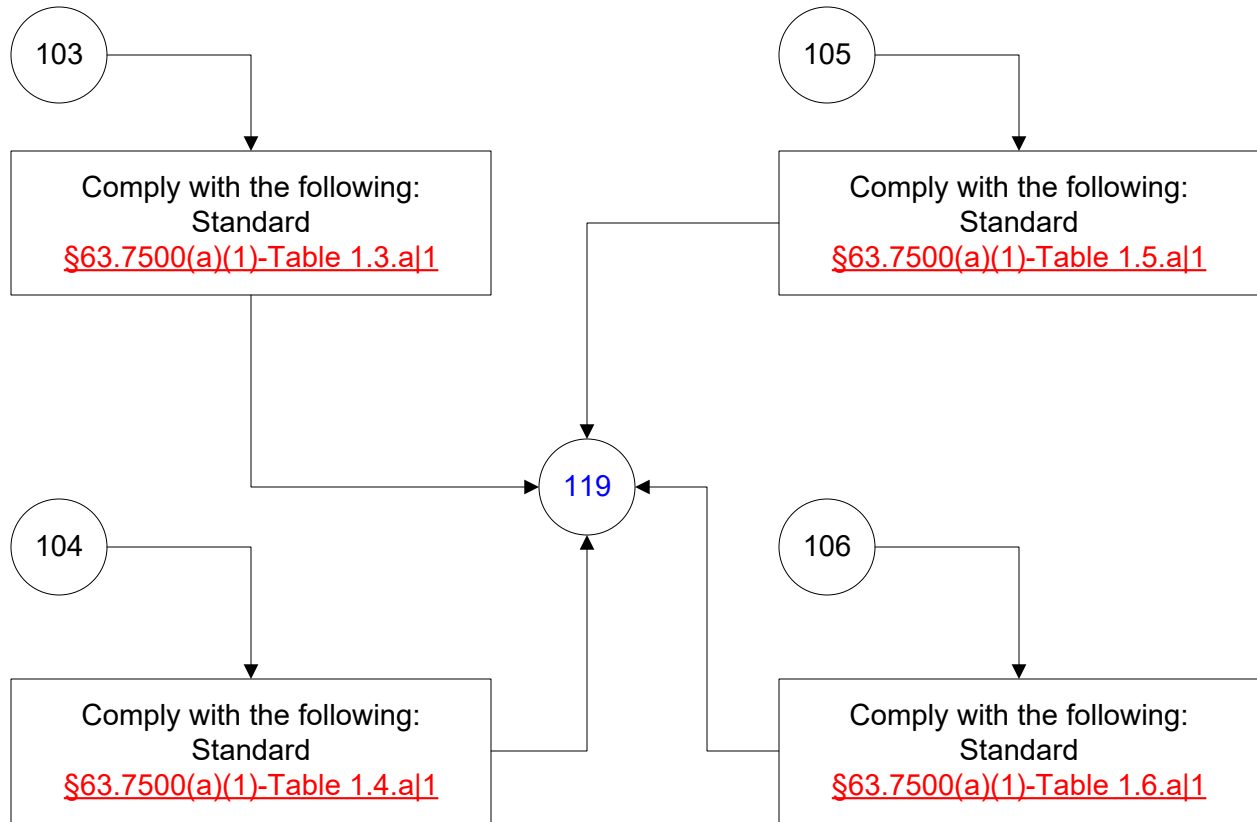

40 CFR Part 63, Subpart DDDDD (57 of 242)

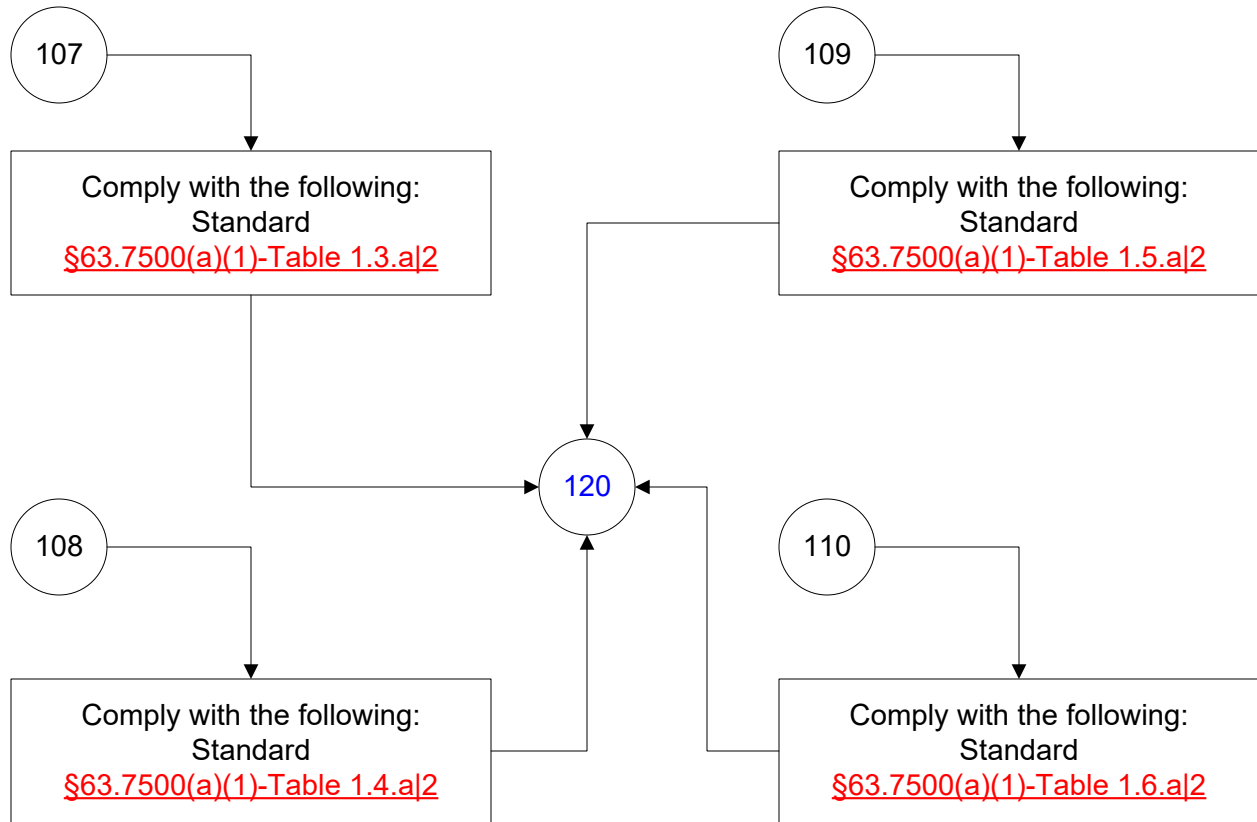

40 CFR Part 63, Subpart DDDDD (58 of 242)

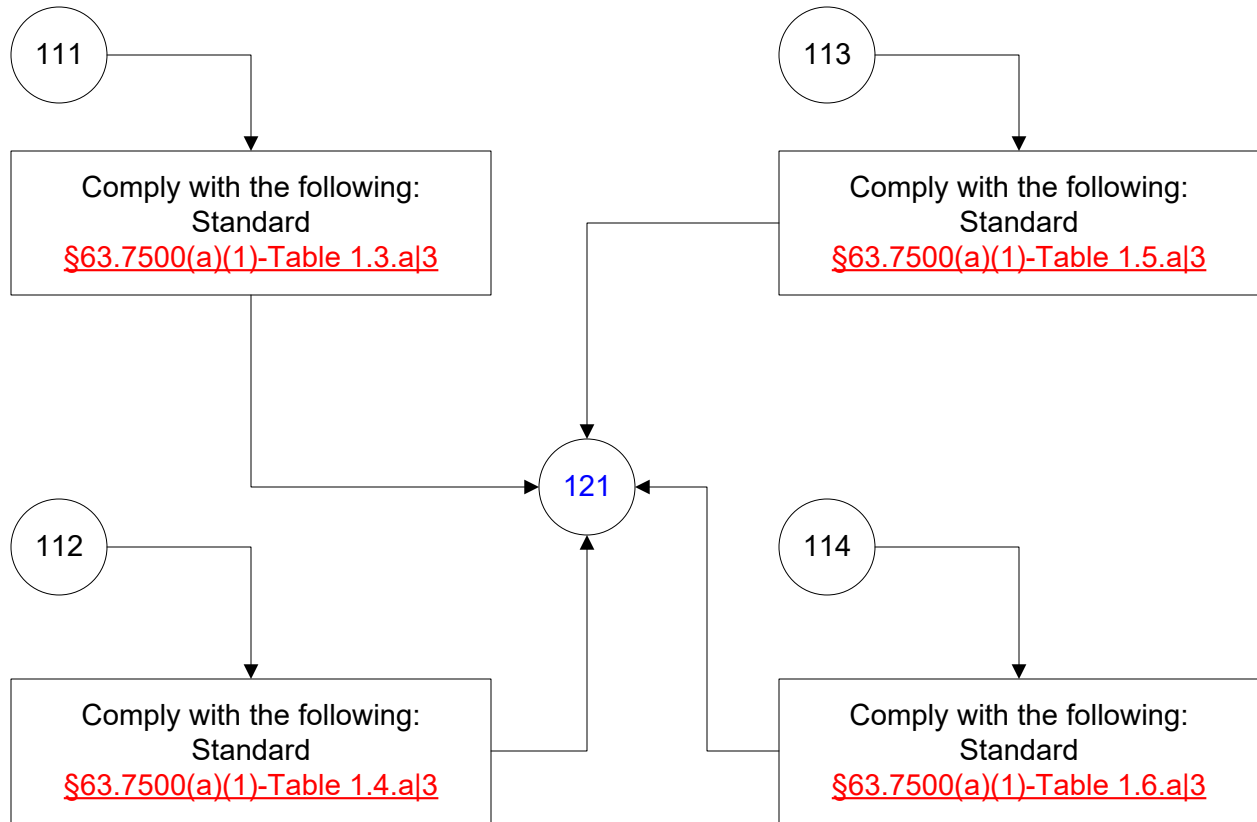

40 CFR Part 63, Subpart DDDDD (59 of 242)

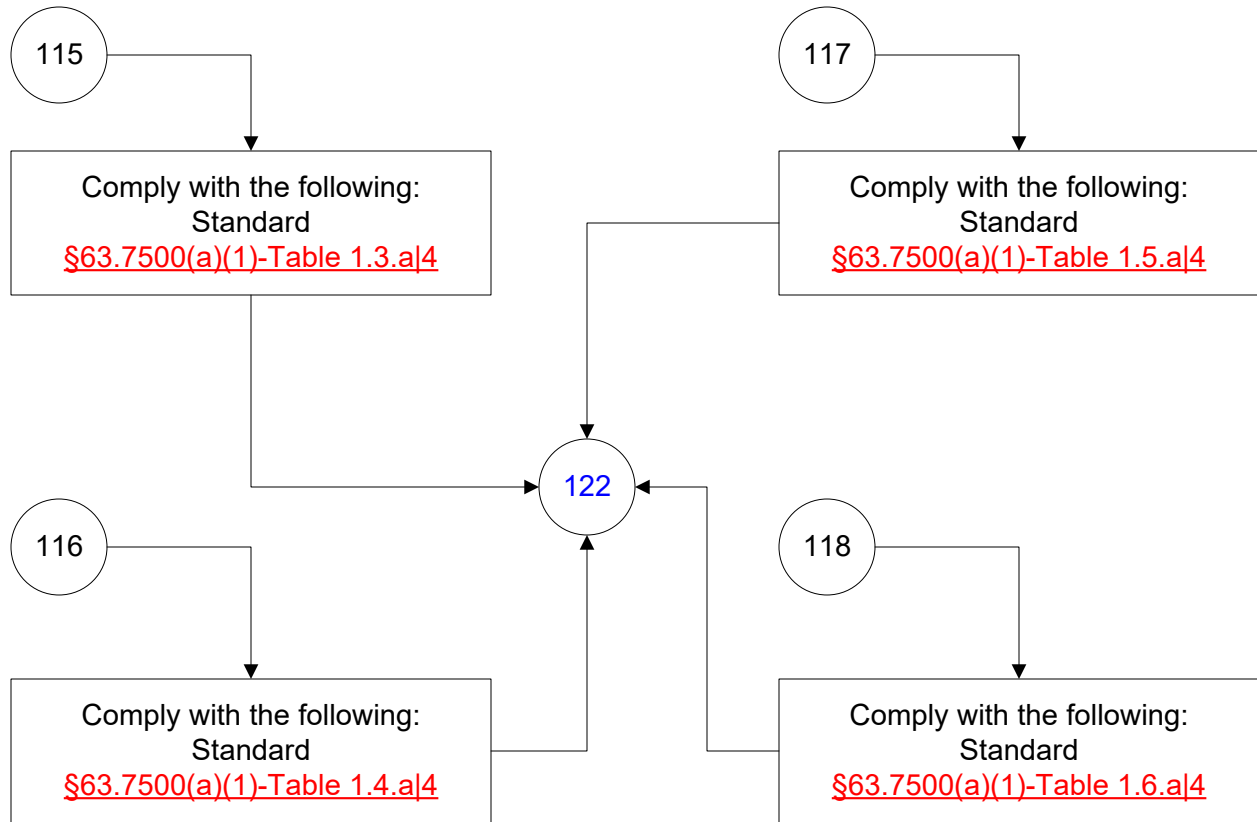

**40 CFR Part 63, Subpart DDDDD
(60 of 242)**

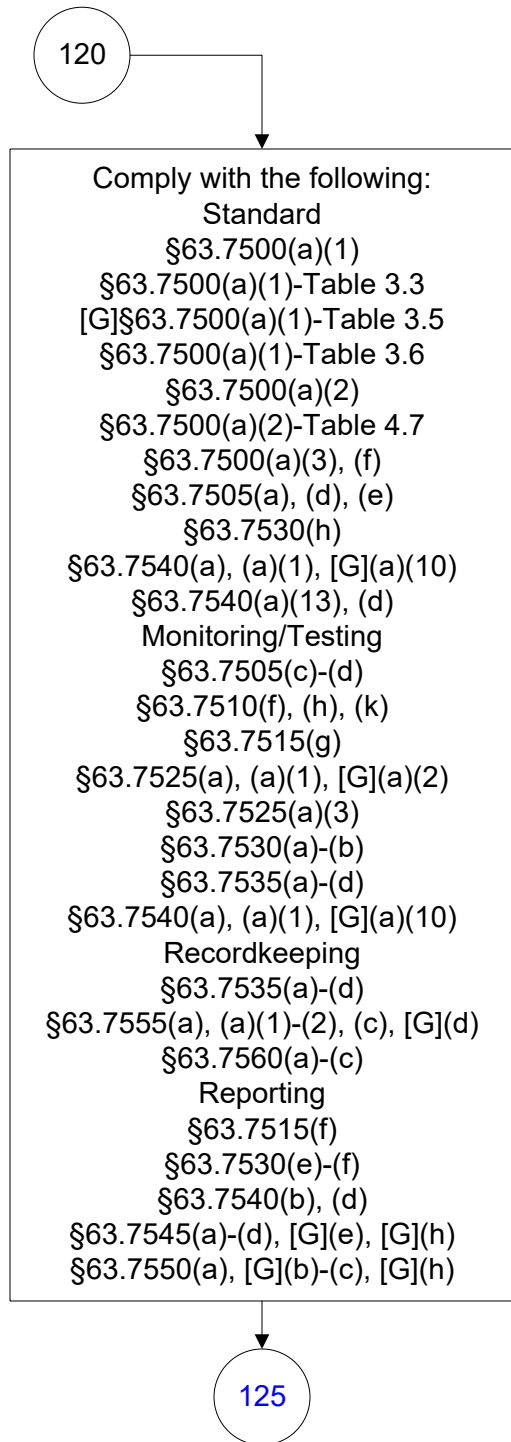
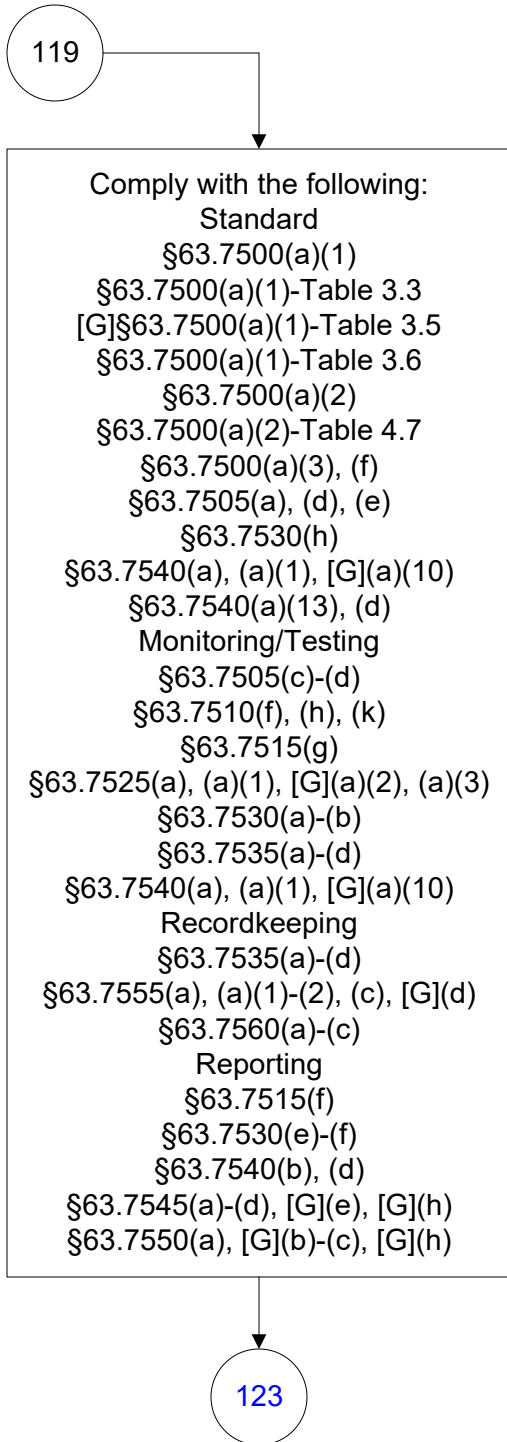

40 CFR Part 63, Subpart DDDDD
(61 of 242)

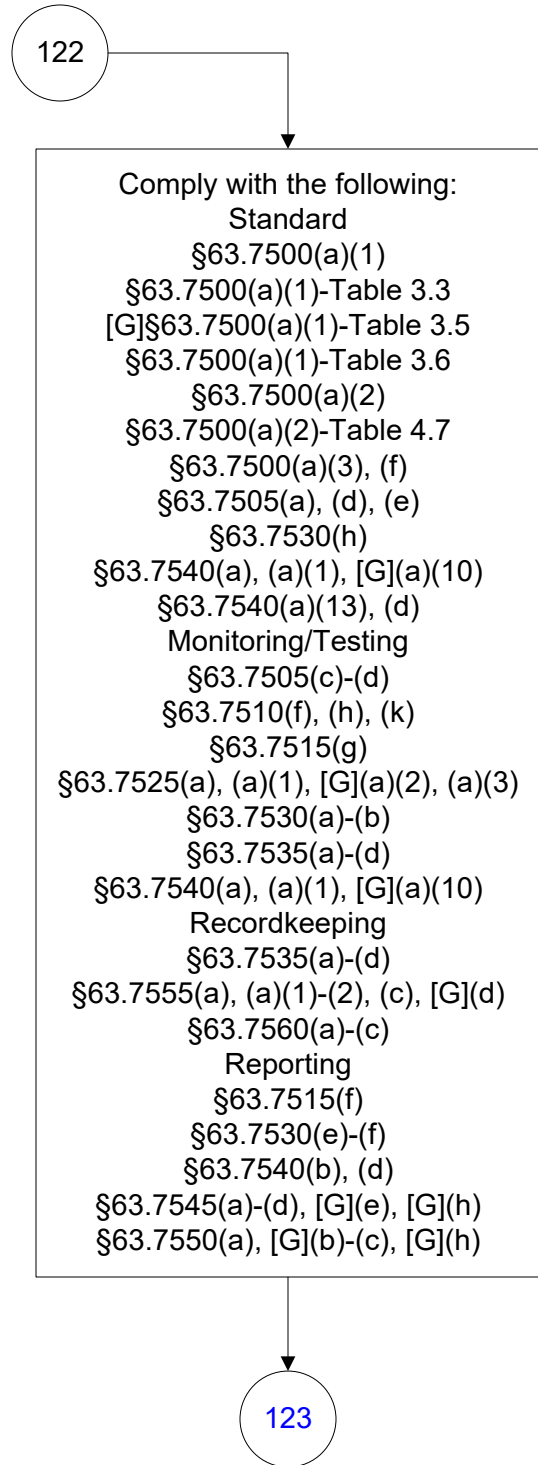
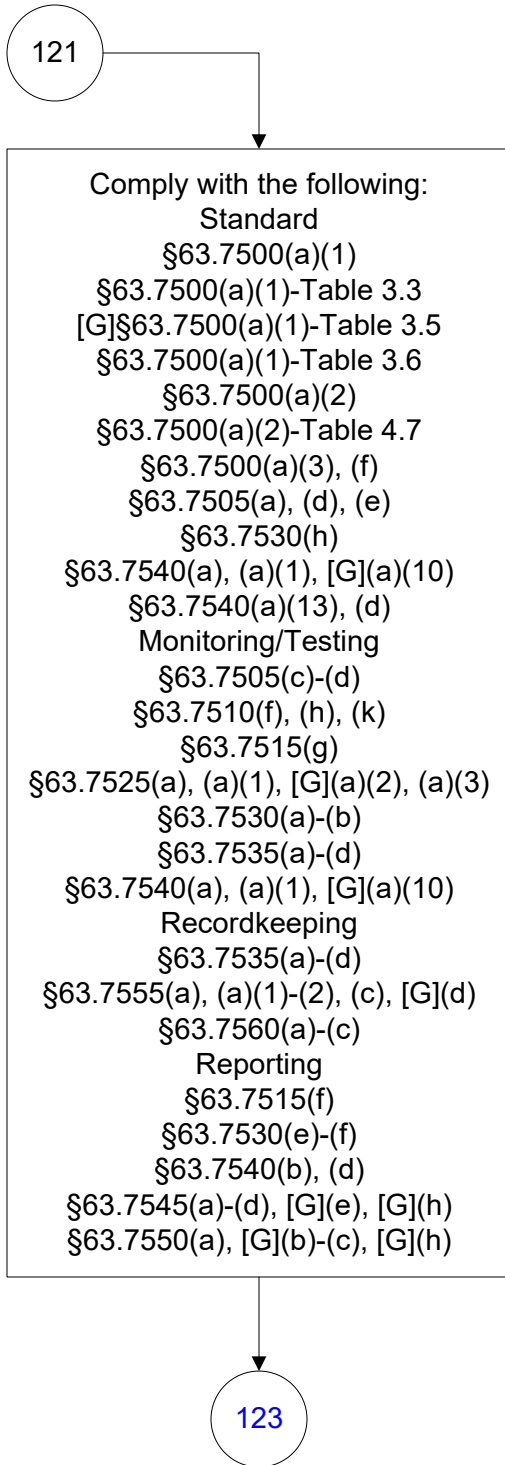

**40 CFR Part 63, Subpart DDDDD
(62 of 242)**

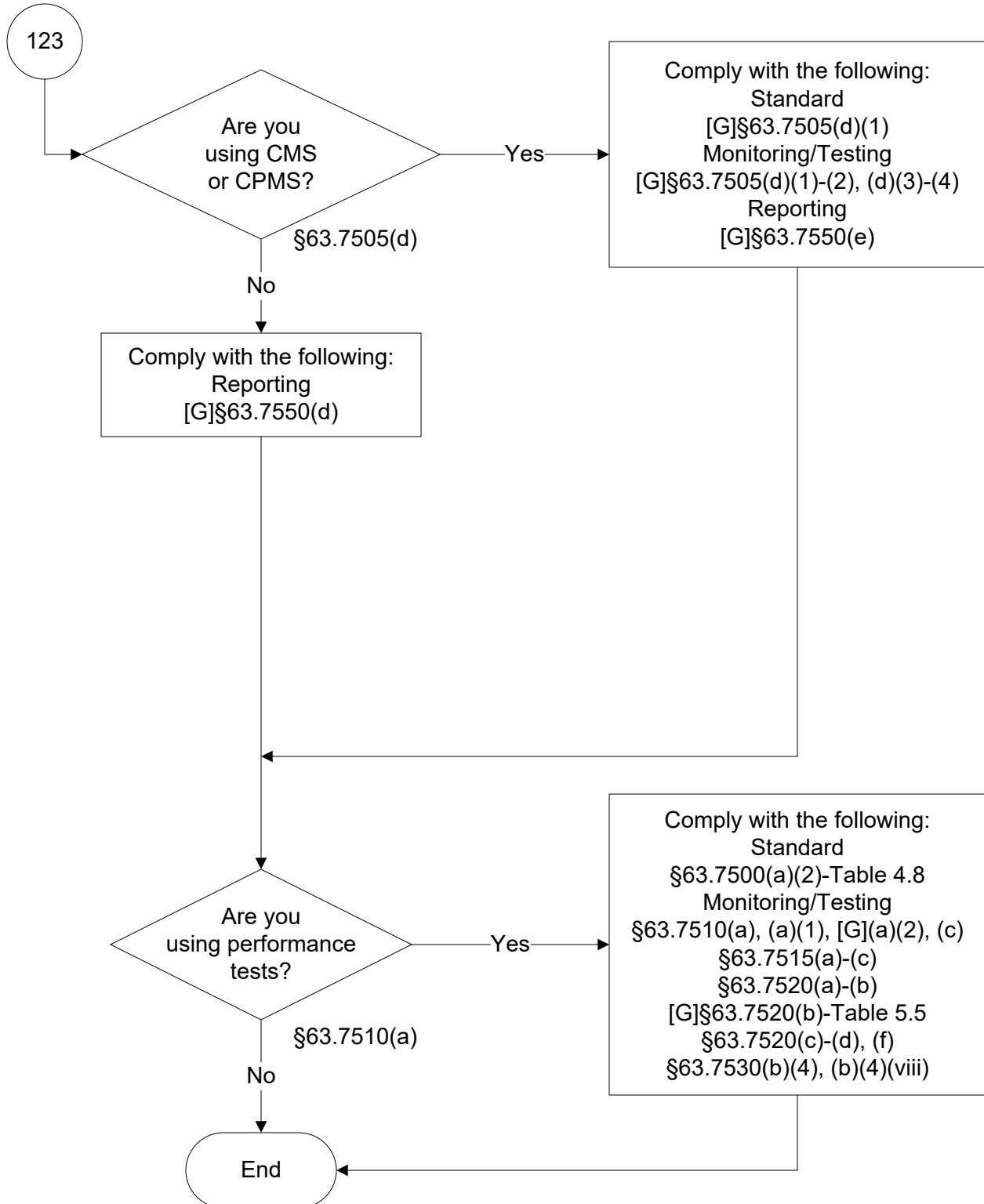

**40 CFR Part 63, Subpart DDDDD
(63 of 242)**

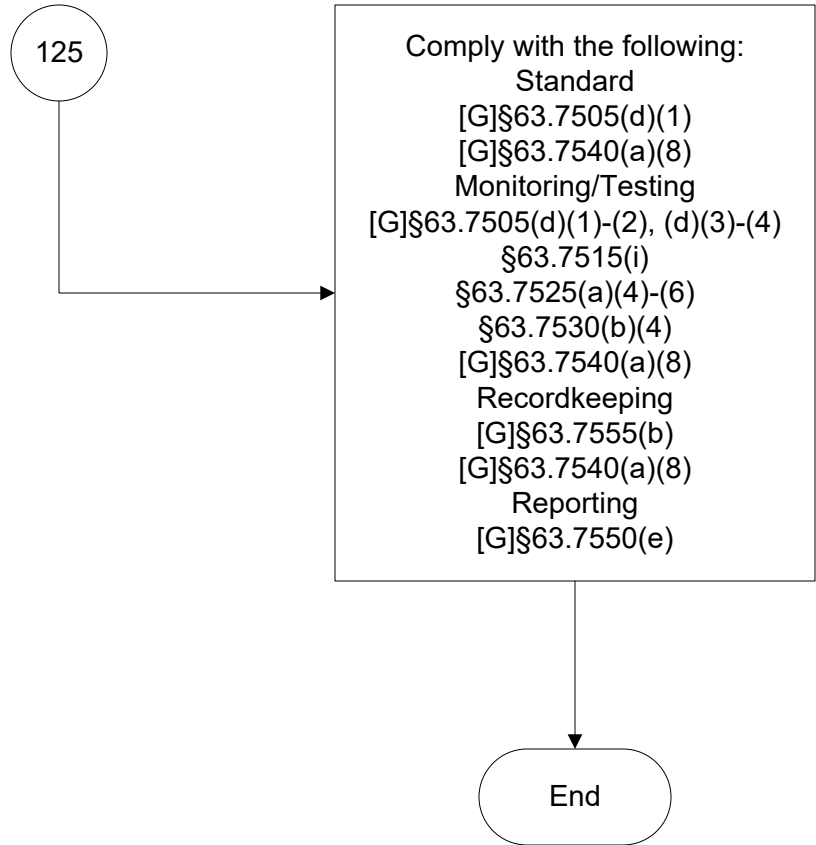

40 CFR Part 63, Subpart DDDDD (64 of 242)

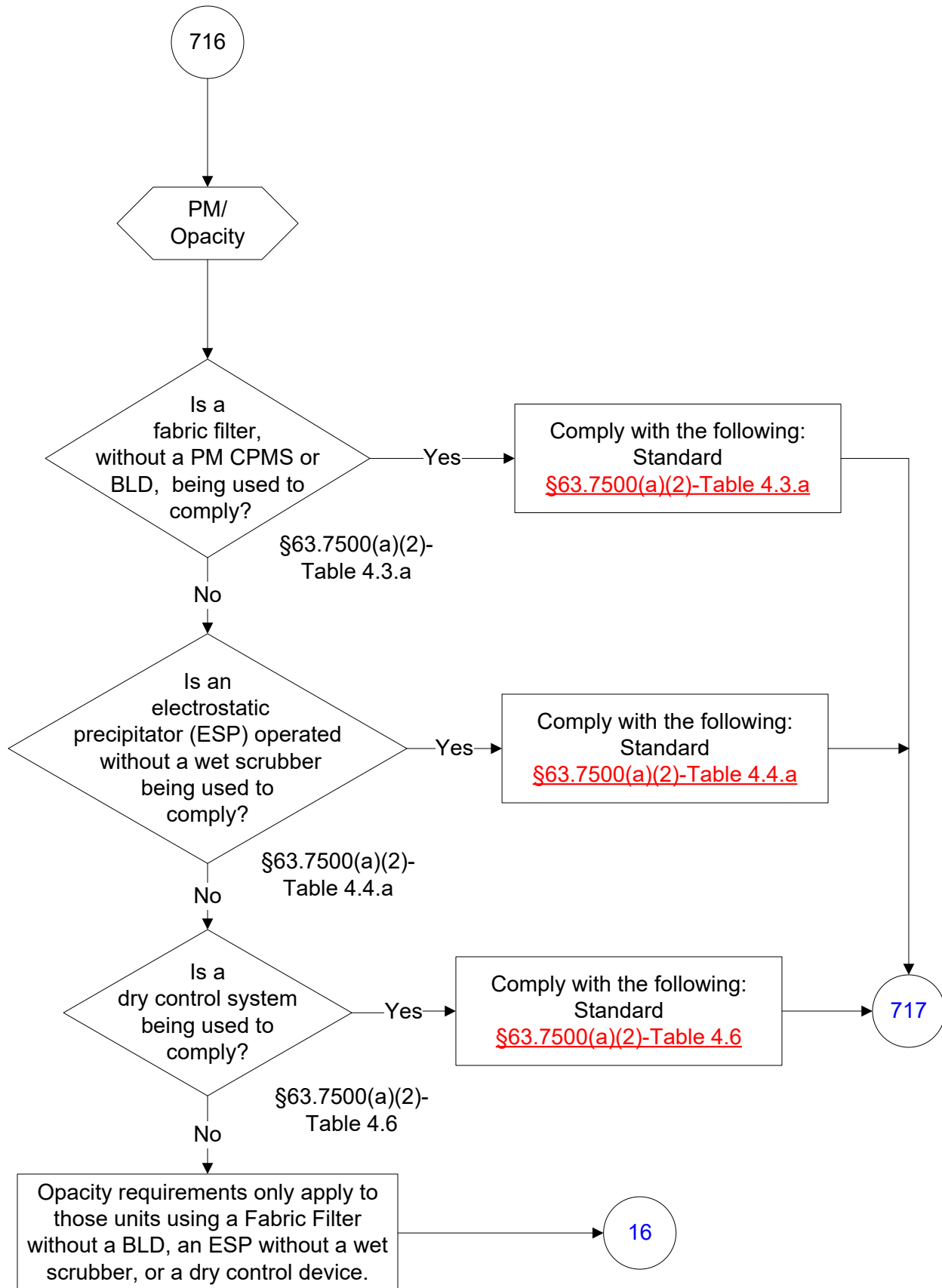

40 CFR Part 63, Subpart DDDDD (65 of 242)

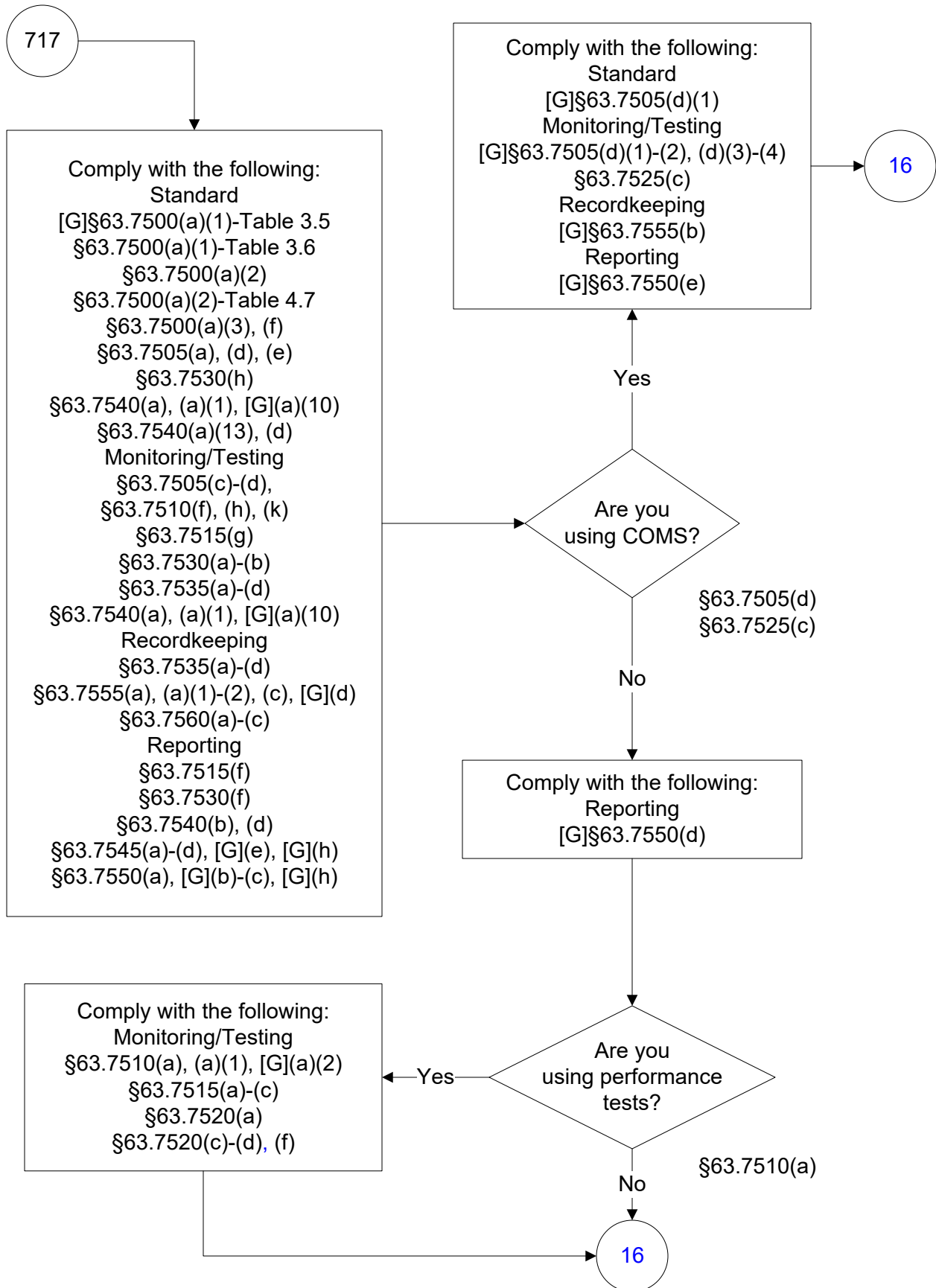

40 CFR Part 63, Subpart DDDDD (66 of 242)

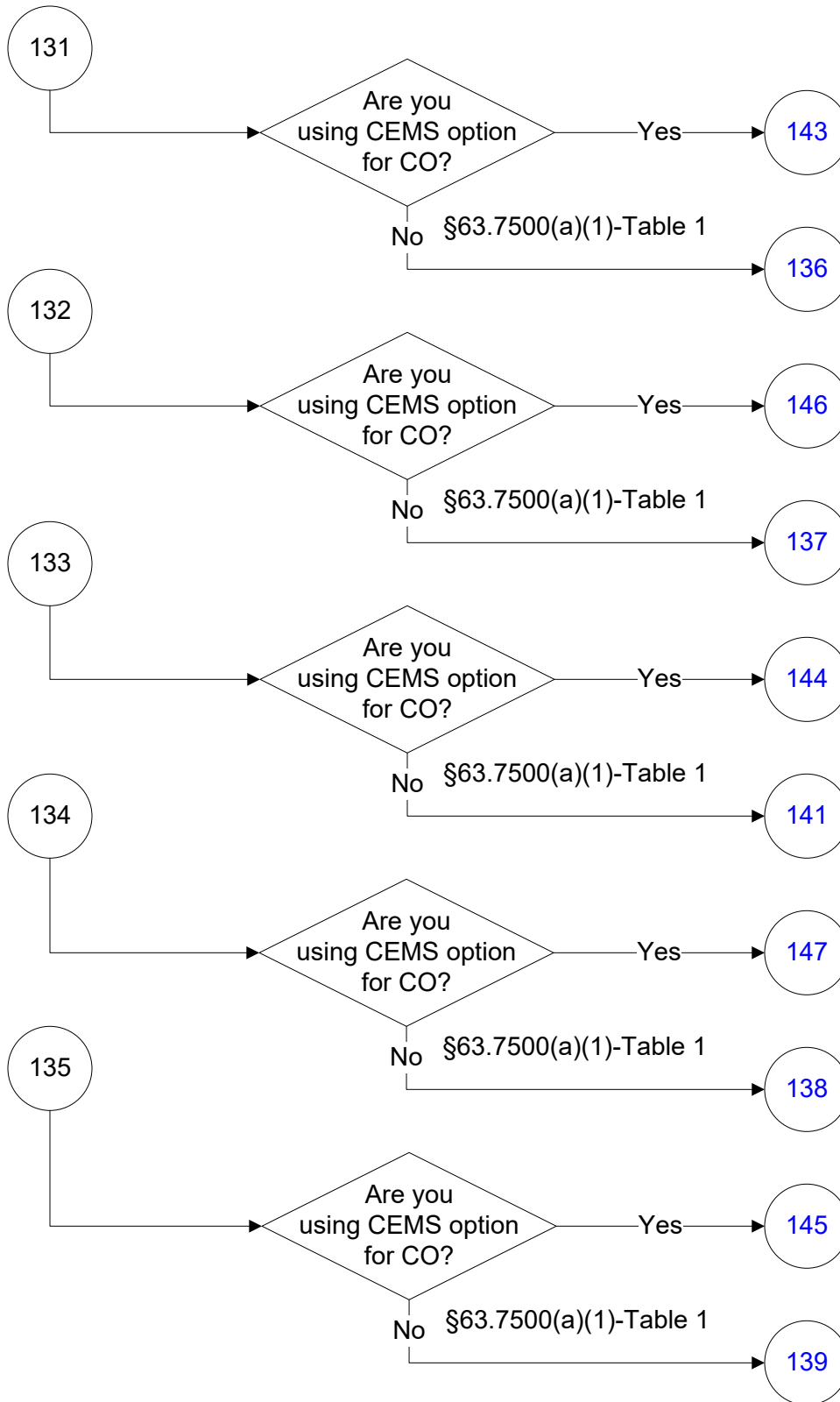

40 CFR Part 63, Subpart DDDDD (67 of 242)

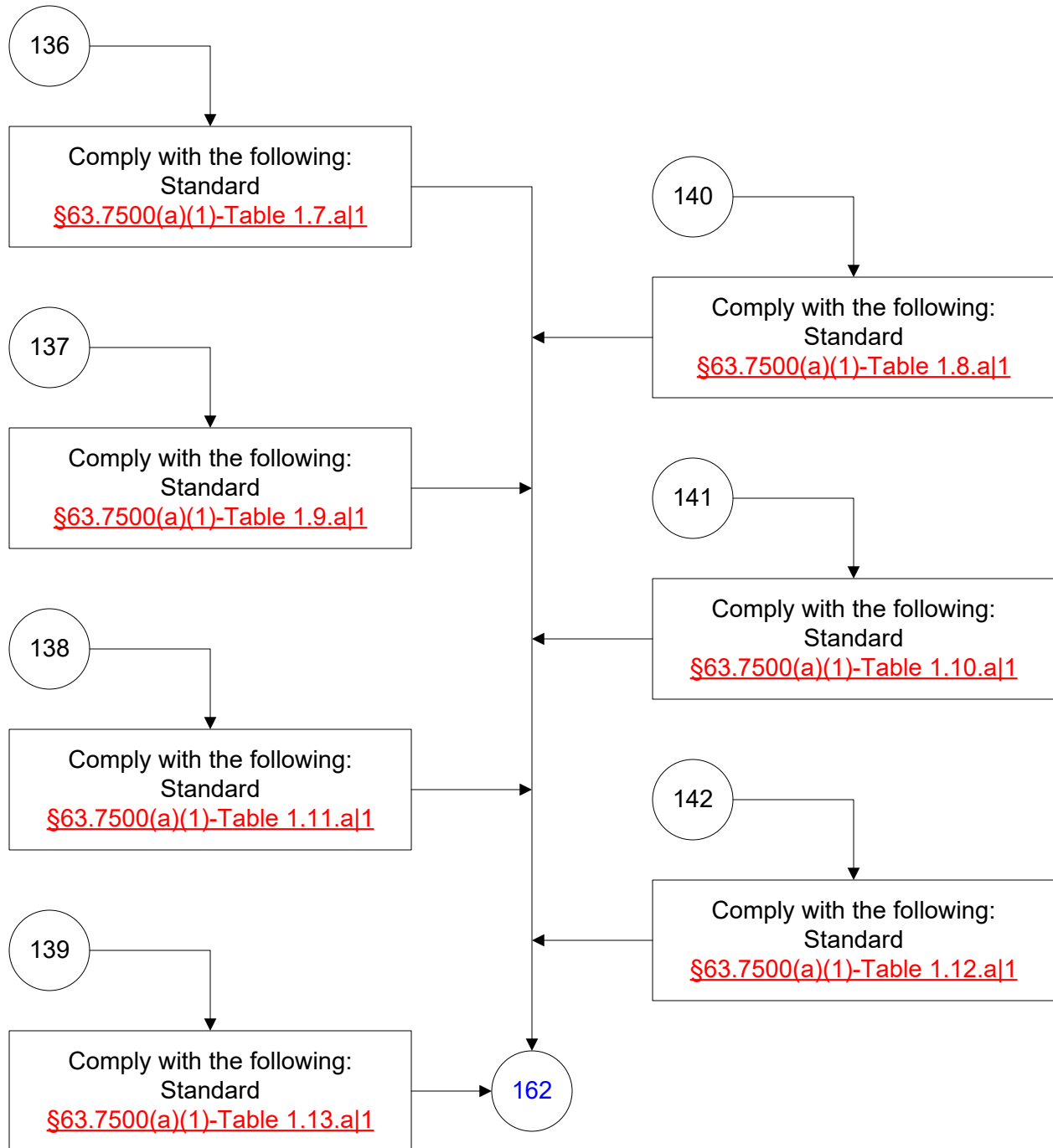

40 CFR Part 63, Subpart DDDDD (68 of 242)

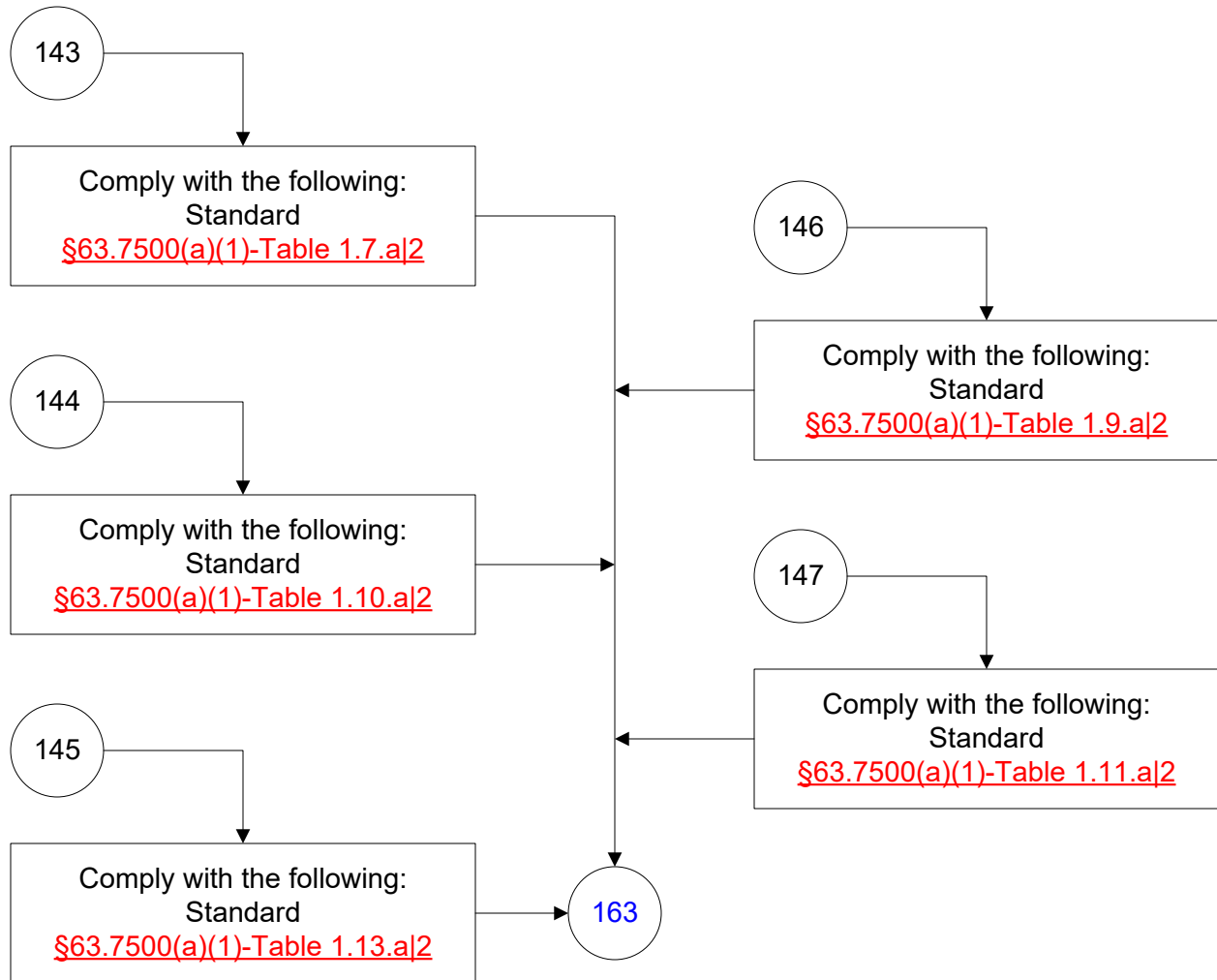

40 CFR Part 63, Subpart DDDDD (69 of 242)



40 CFR Part 63, Subpart DDDDD (70 of 242)

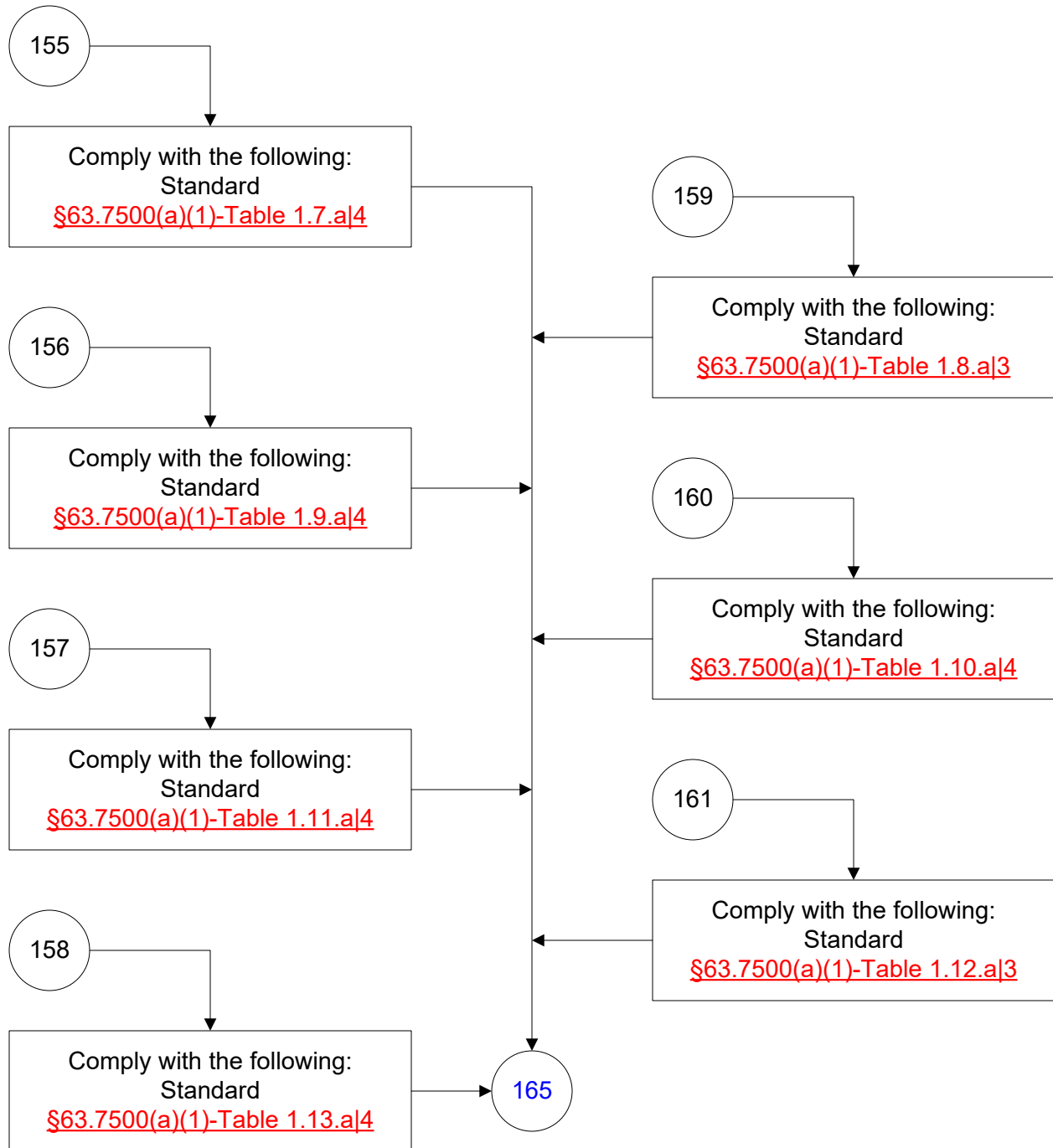

40 CFR Part 63, Subpart DDDDD
(71 of 242)

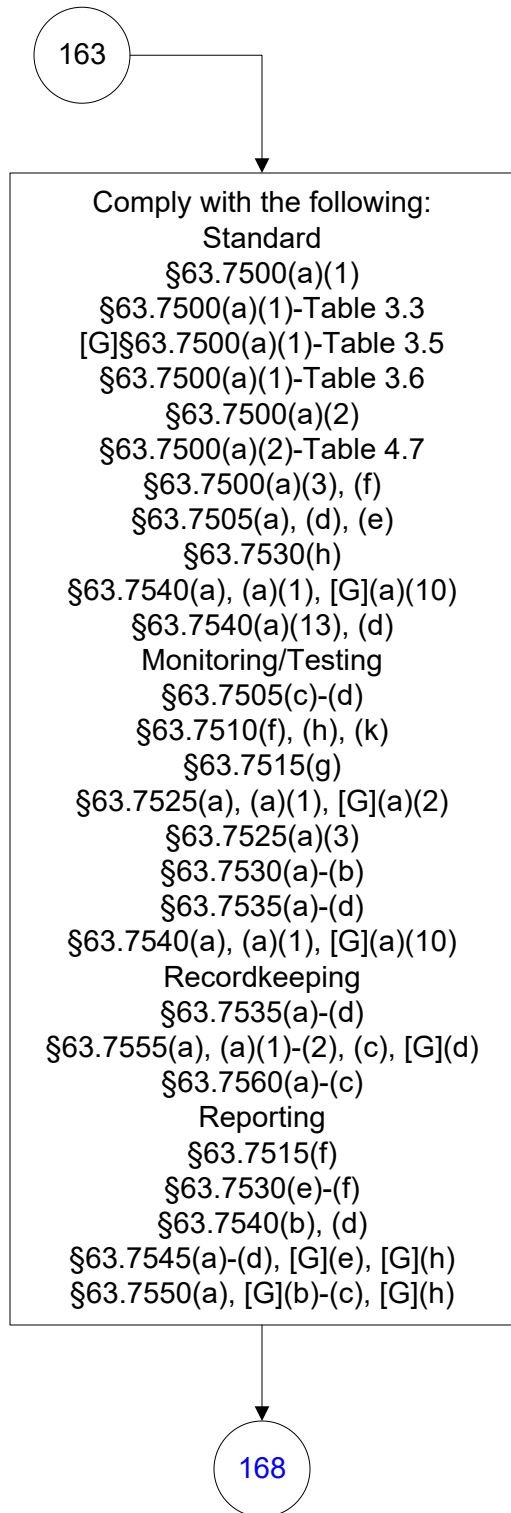
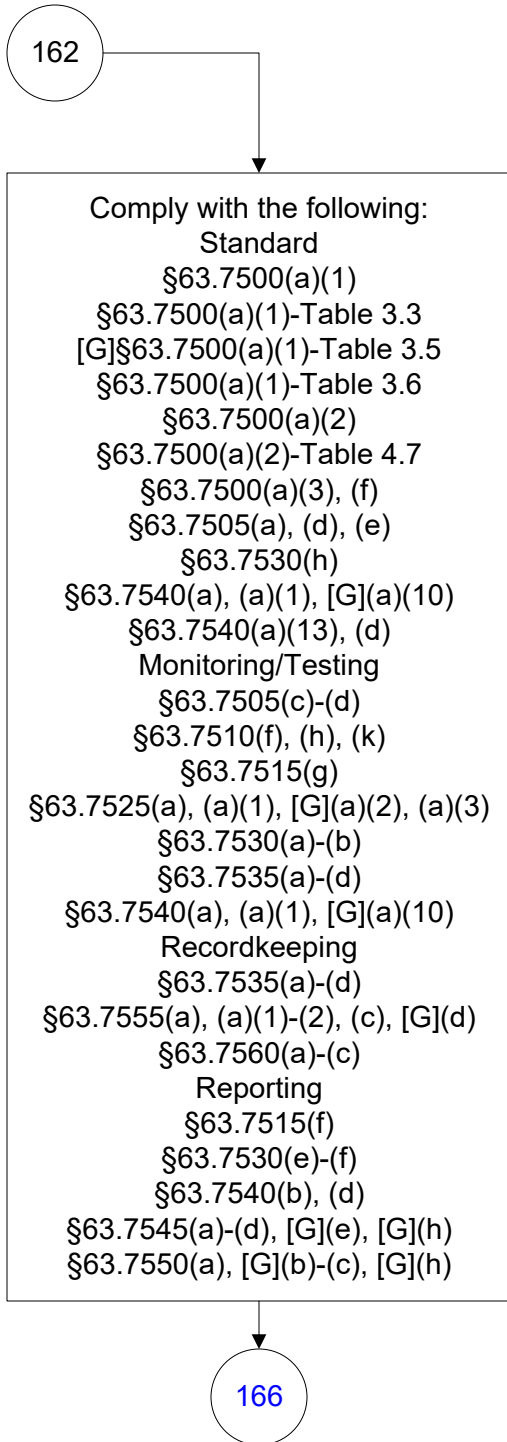

**40 CFR Part 63, Subpart DDDDD
(72 of 242)**

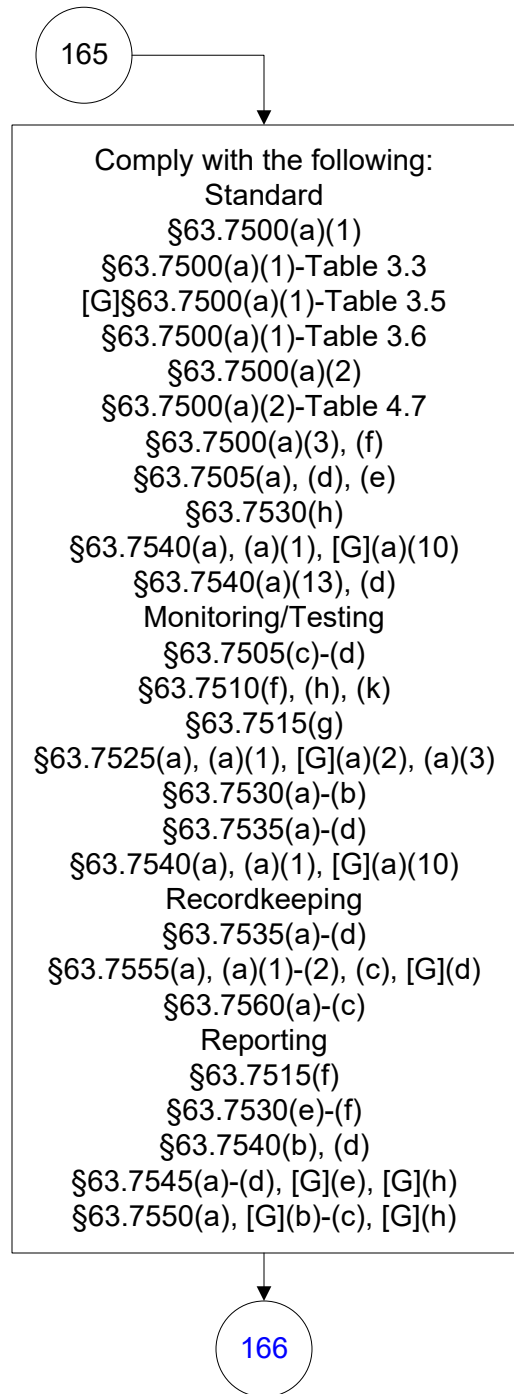
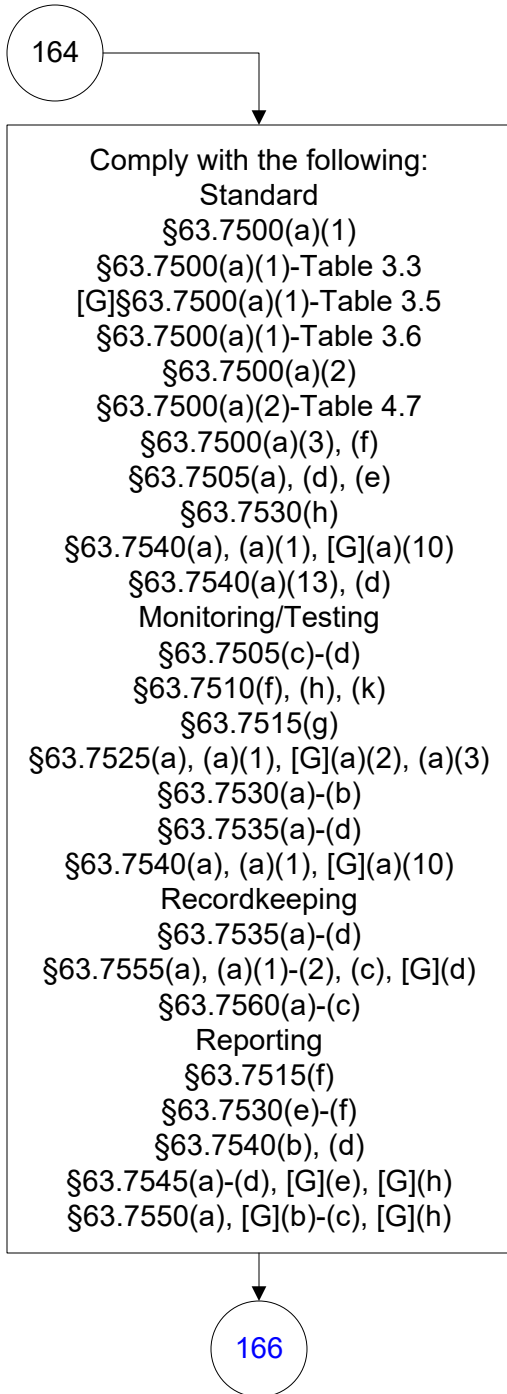

40 CFR Part 63, Subpart DDDDD (73 of 242)

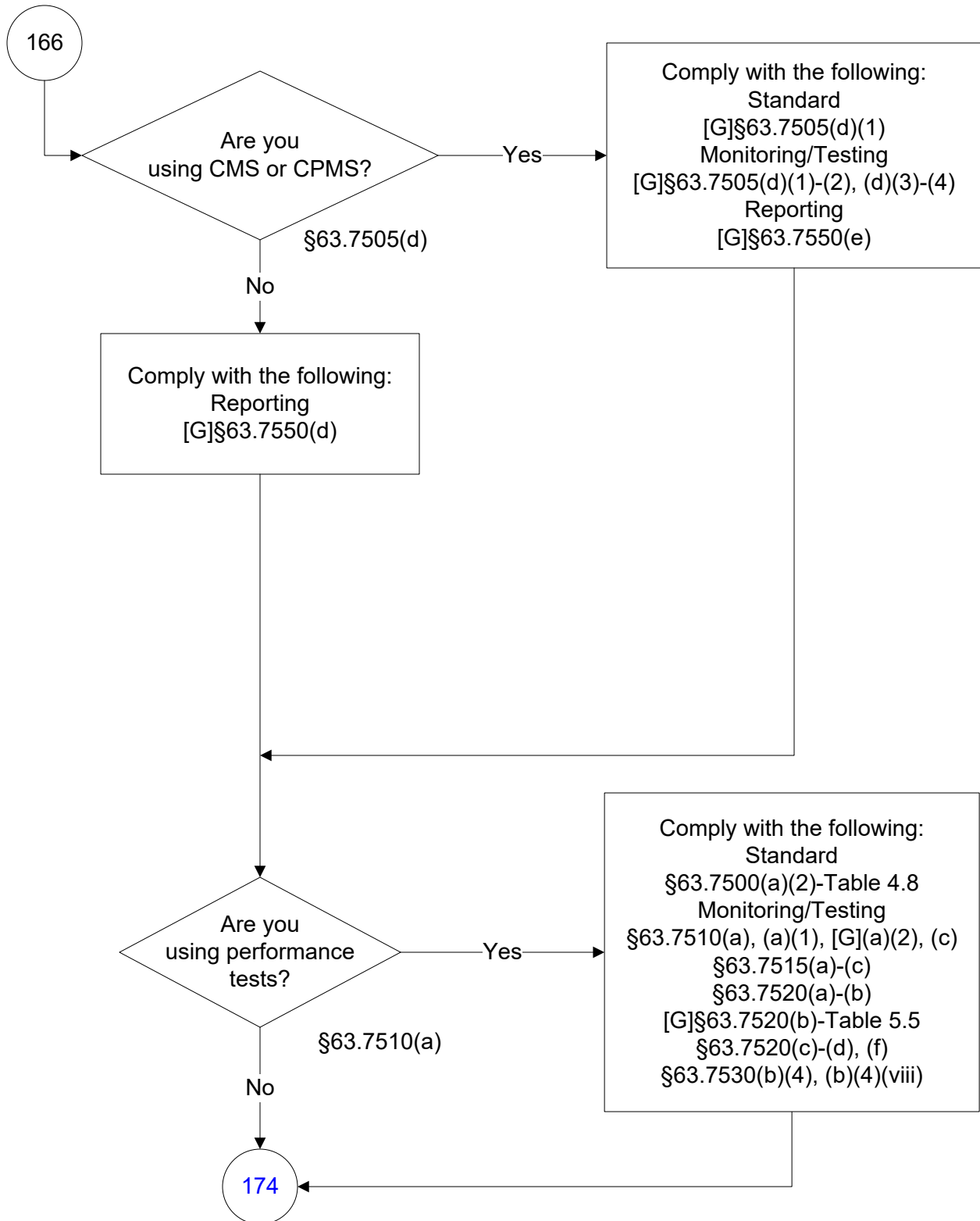

**40 CFR Part 63, Subpart DDDDD
(74 of 242)**

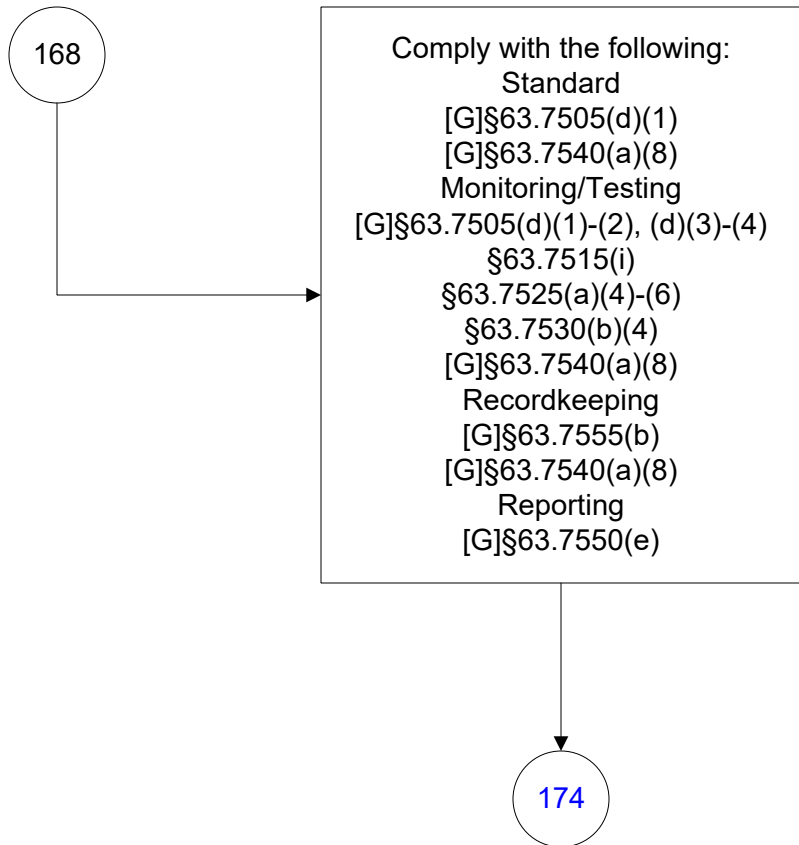

40 CFR Part 63, Subpart DDDDD (75 of 242)

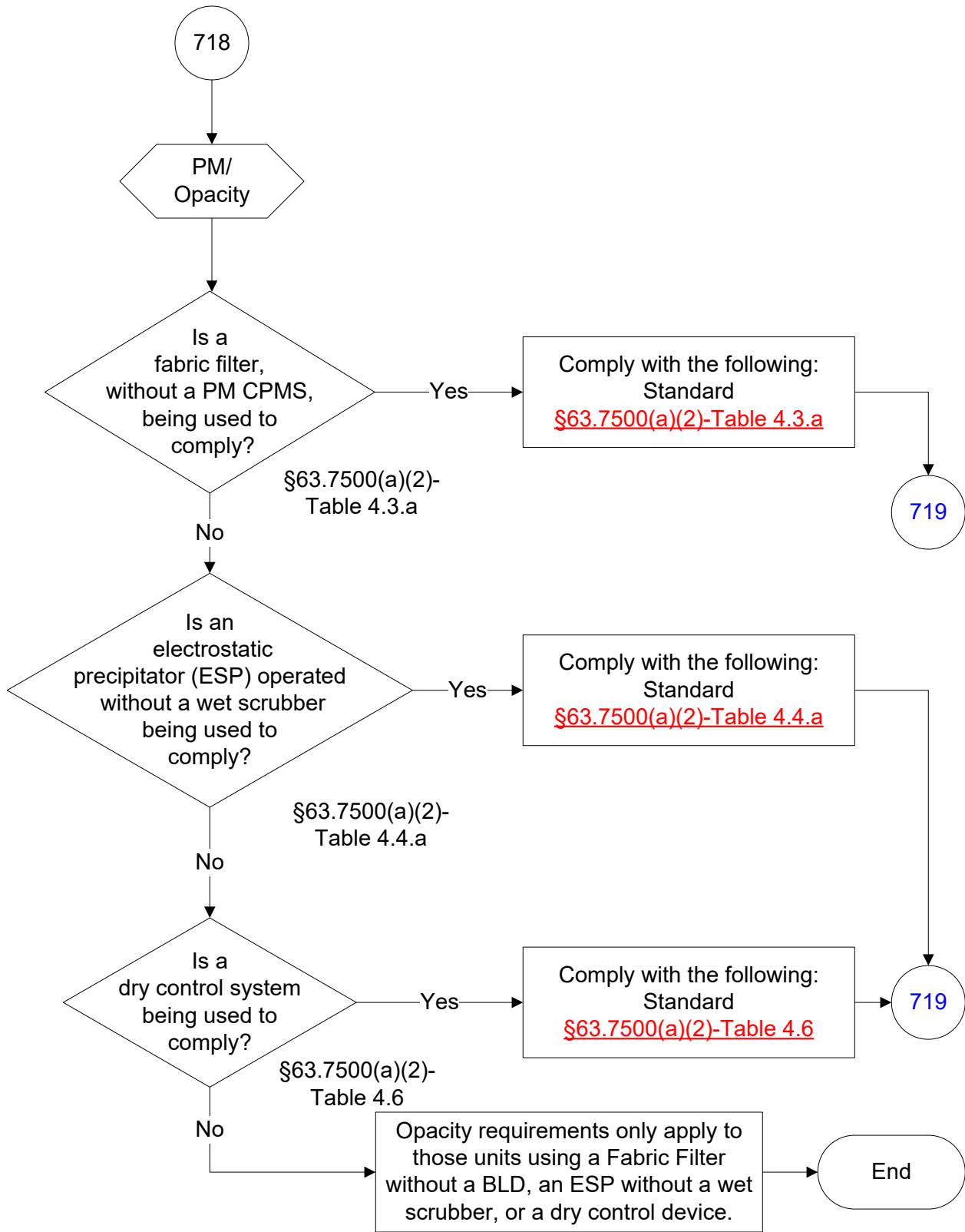

40 CFR Part 63, Subpart DDDDD (76 of 242)

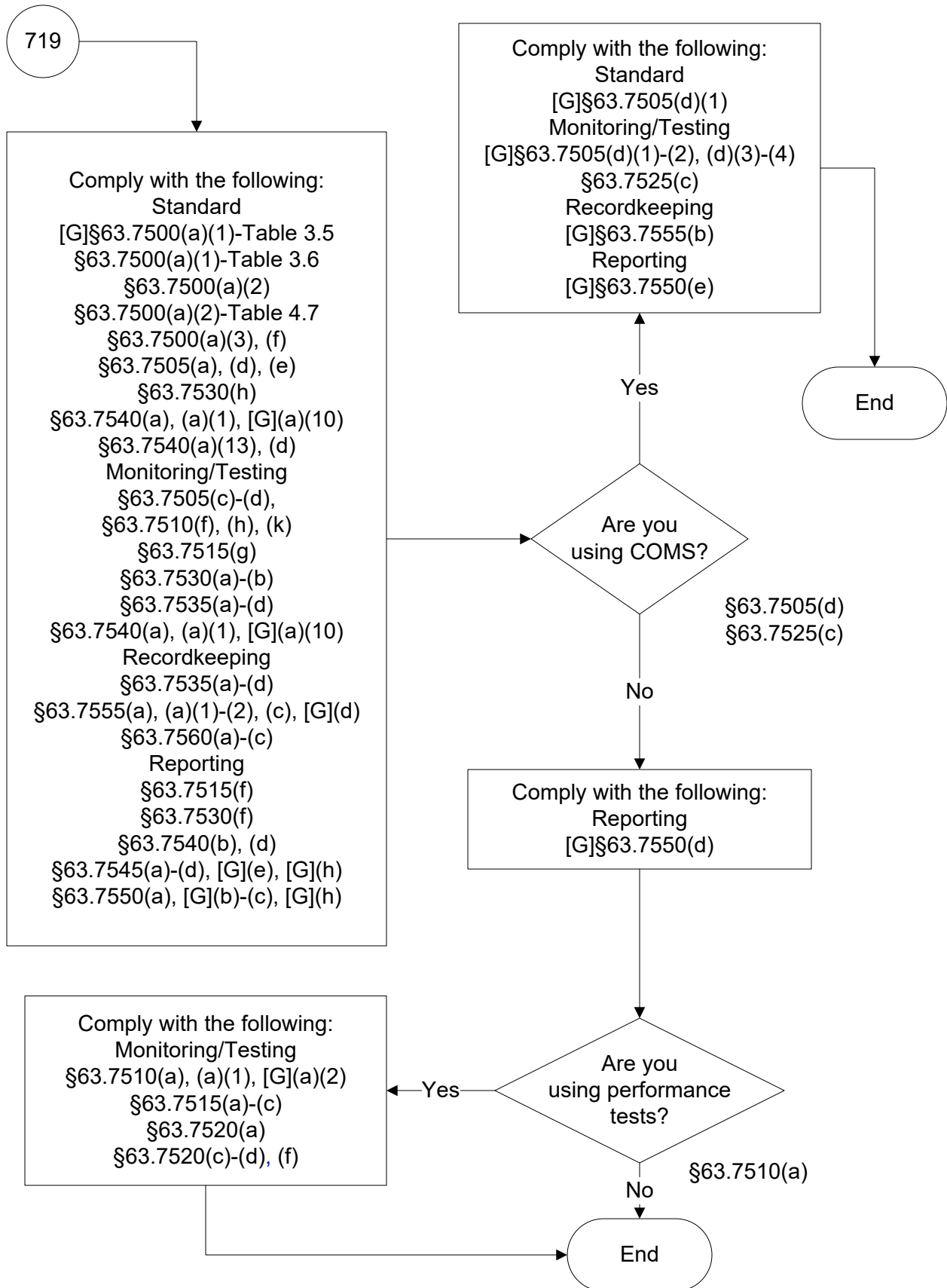

40 CFR Part 63, Subpart DDDDD (77 of 242)

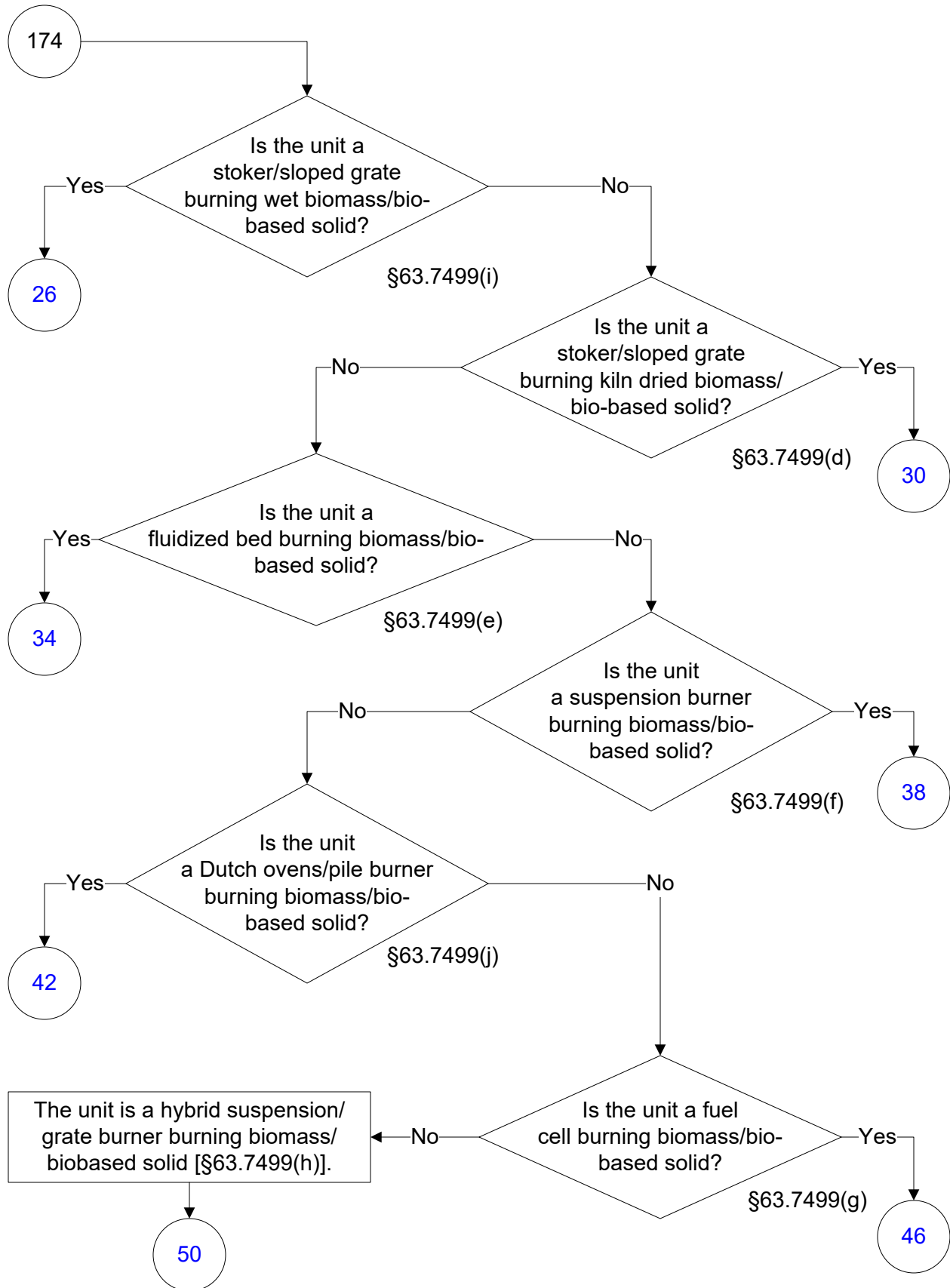

40 CFR Part 63, Subpart DDDDD (78 of 242)

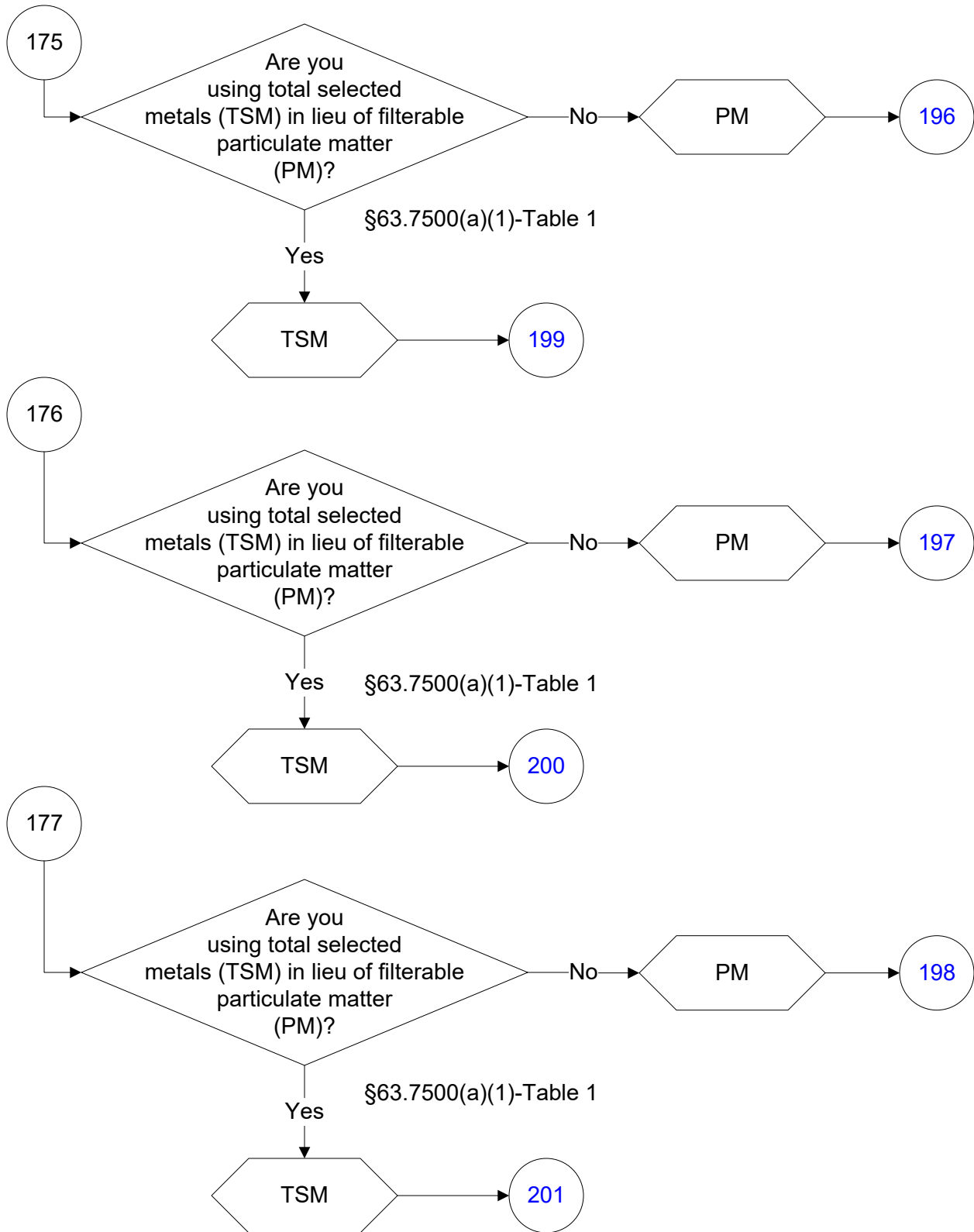

40 CFR Part 63, Subpart DDDDD (79 of 242)

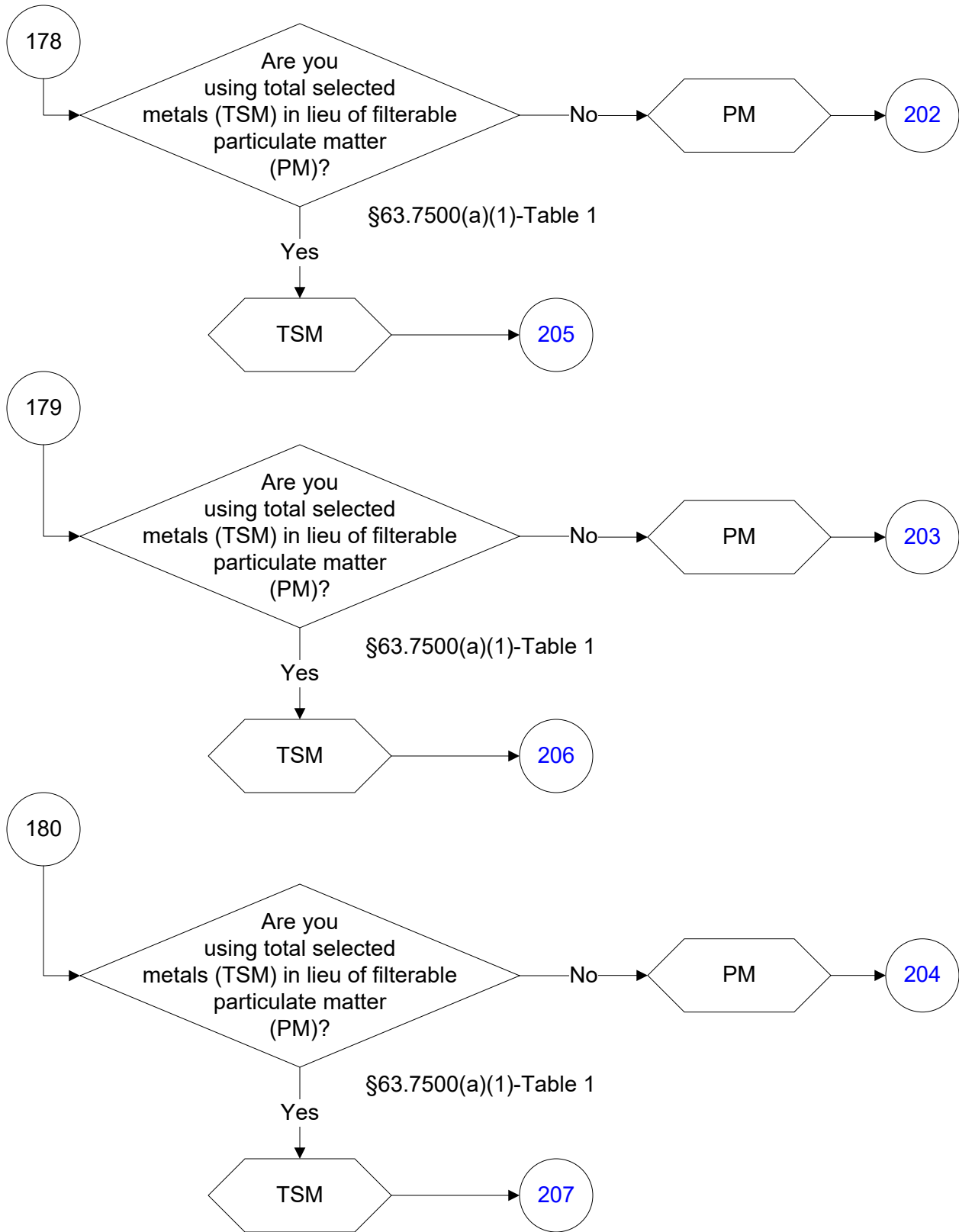

40 CFR Part 63, Subpart DDDDD (80 of 242)

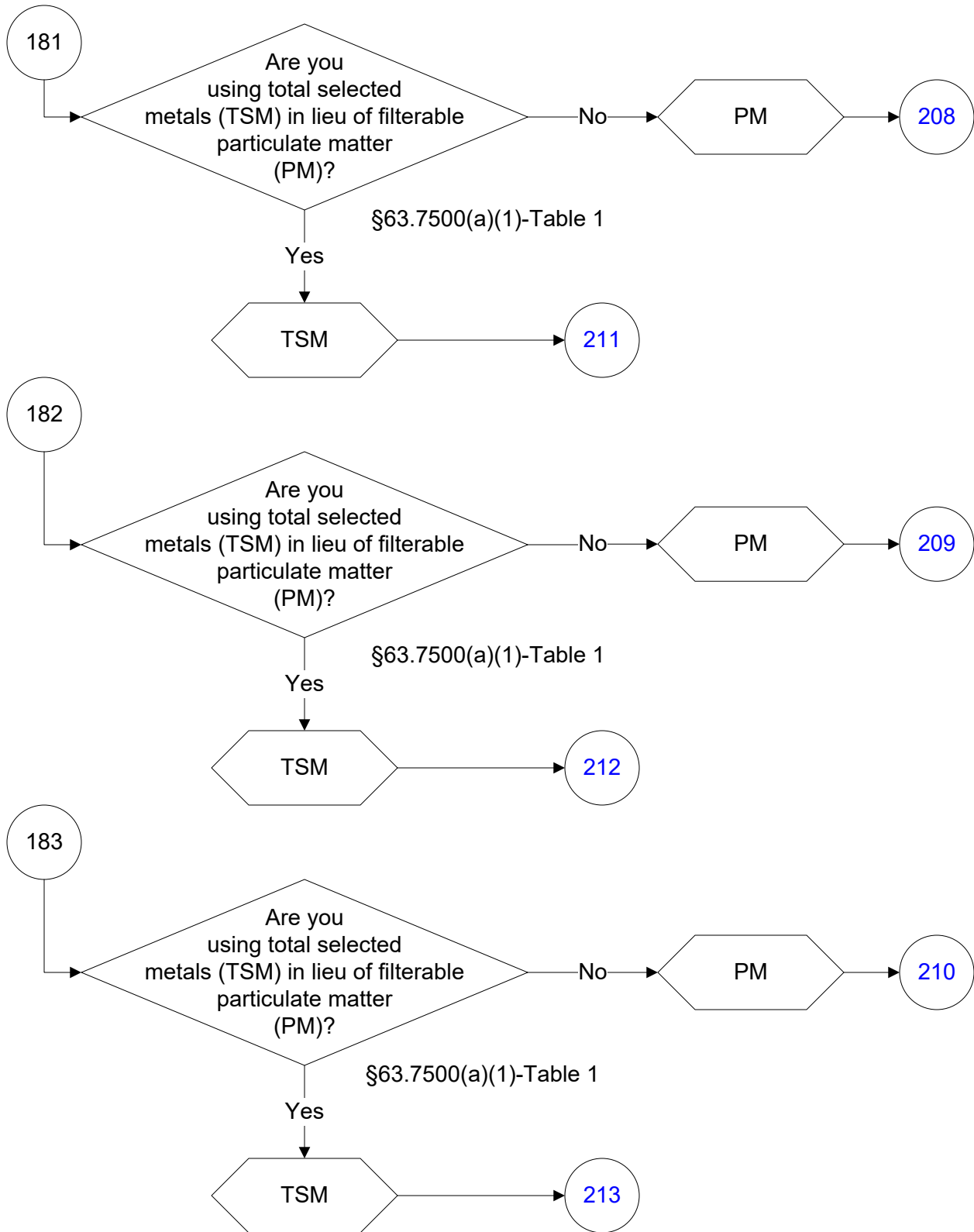

40 CFR Part 63, Subpart DDDDD (81 of 242)

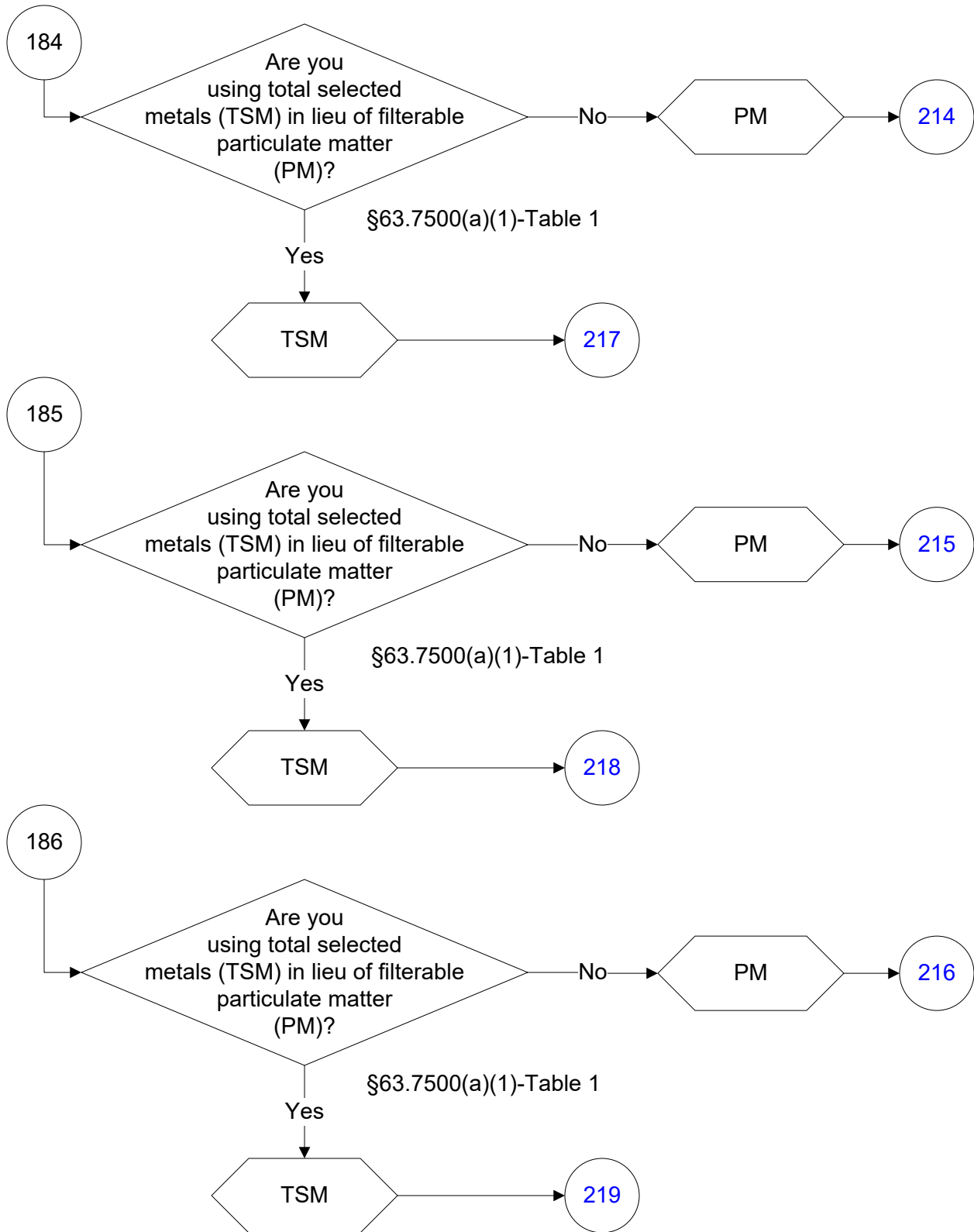

40 CFR Part 63, Subpart DDDDD (82 of 242)

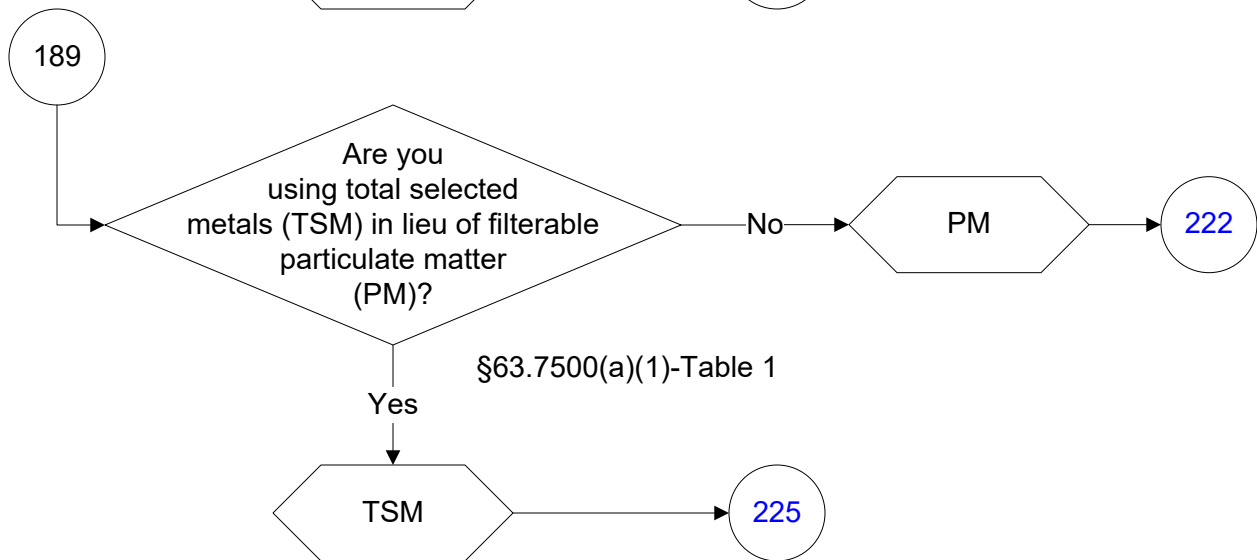
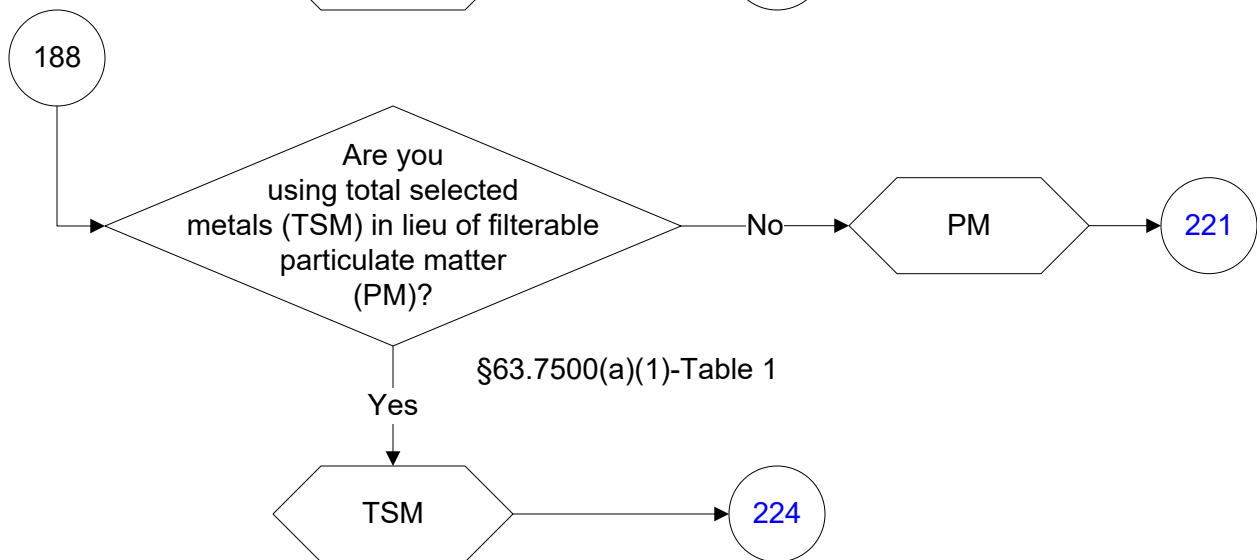
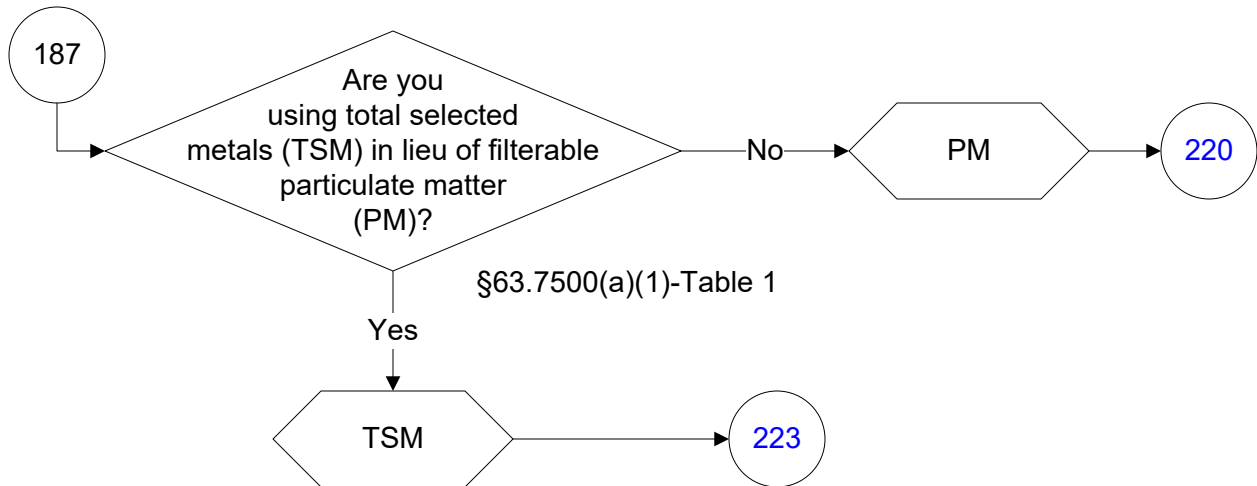

40 CFR Part 63, Subpart DDDDD (83 of 242)

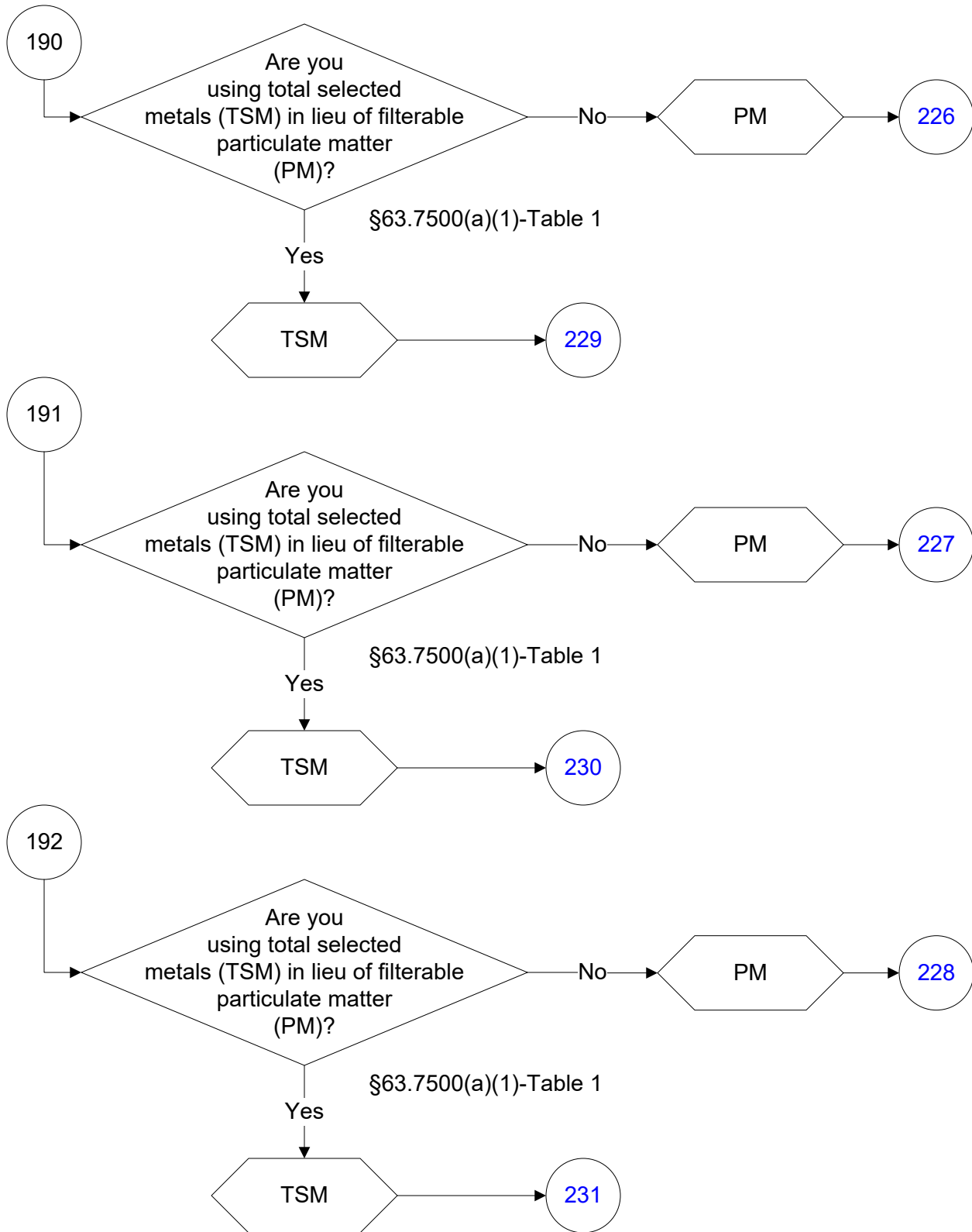

40 CFR Part 63, Subpart DDDDD (84 of 242)

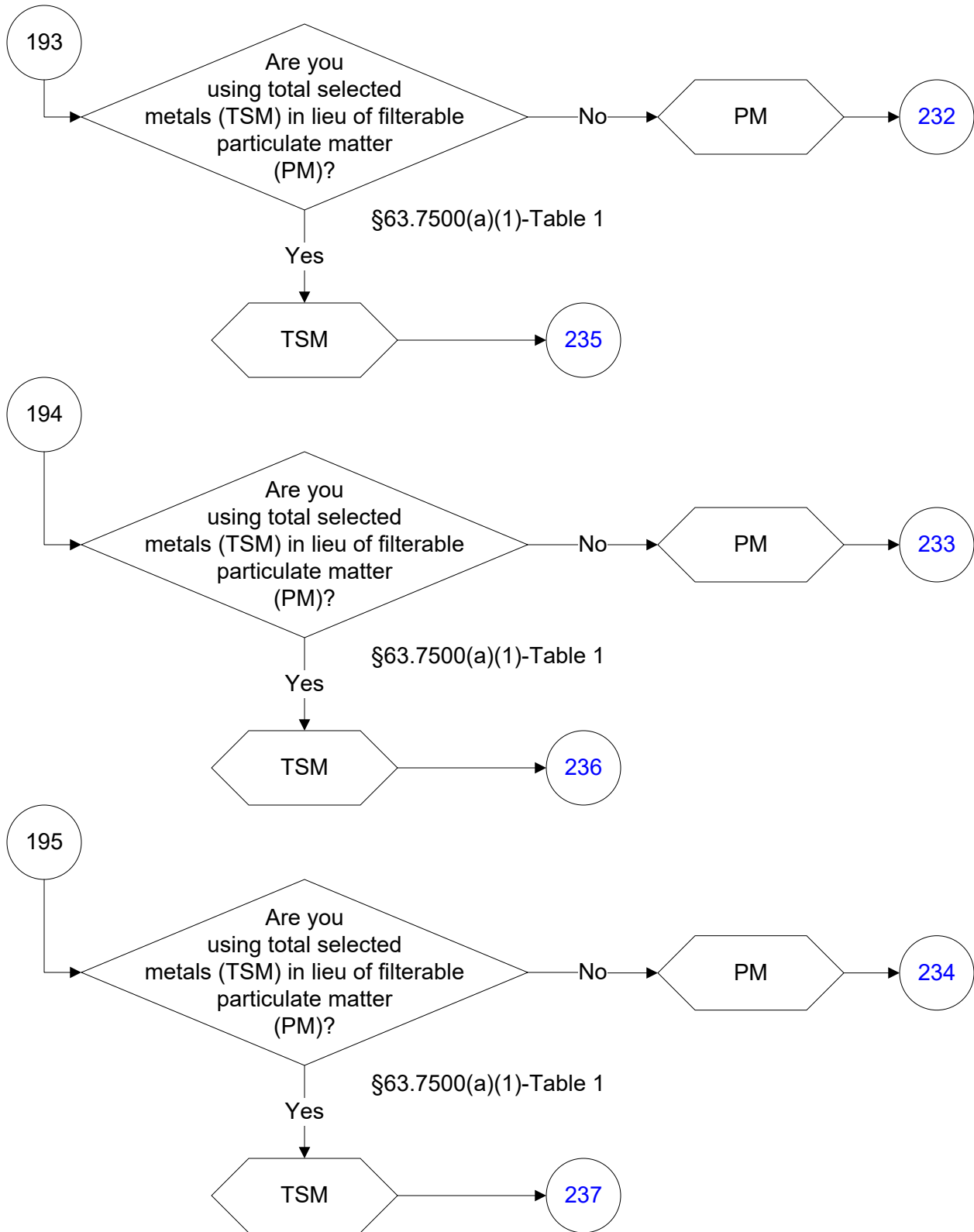

40 CFR Part 63, Subpart DDDDD (85 of 242)

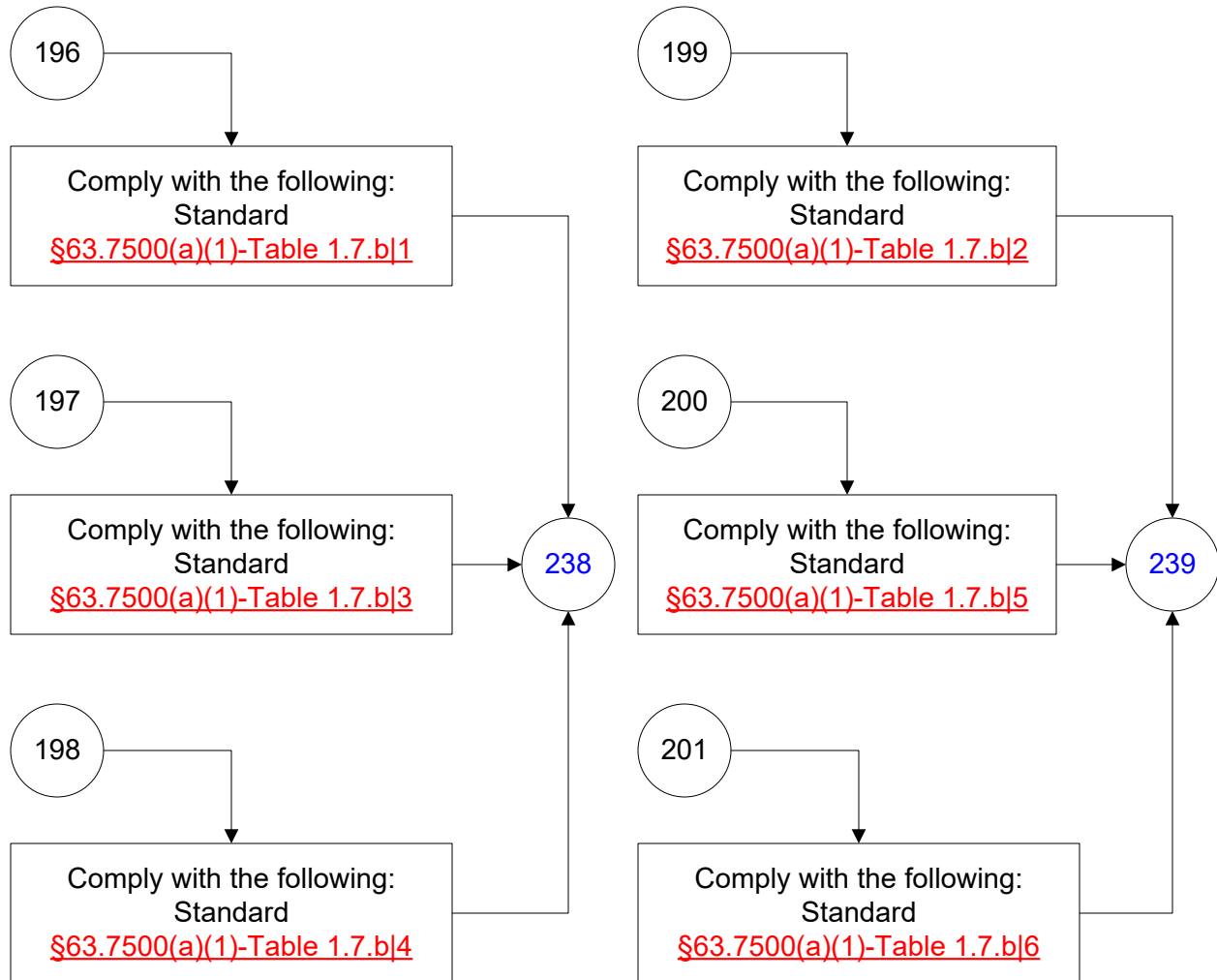

40 CFR Part 63, Subpart DDDDD (86 of 242)

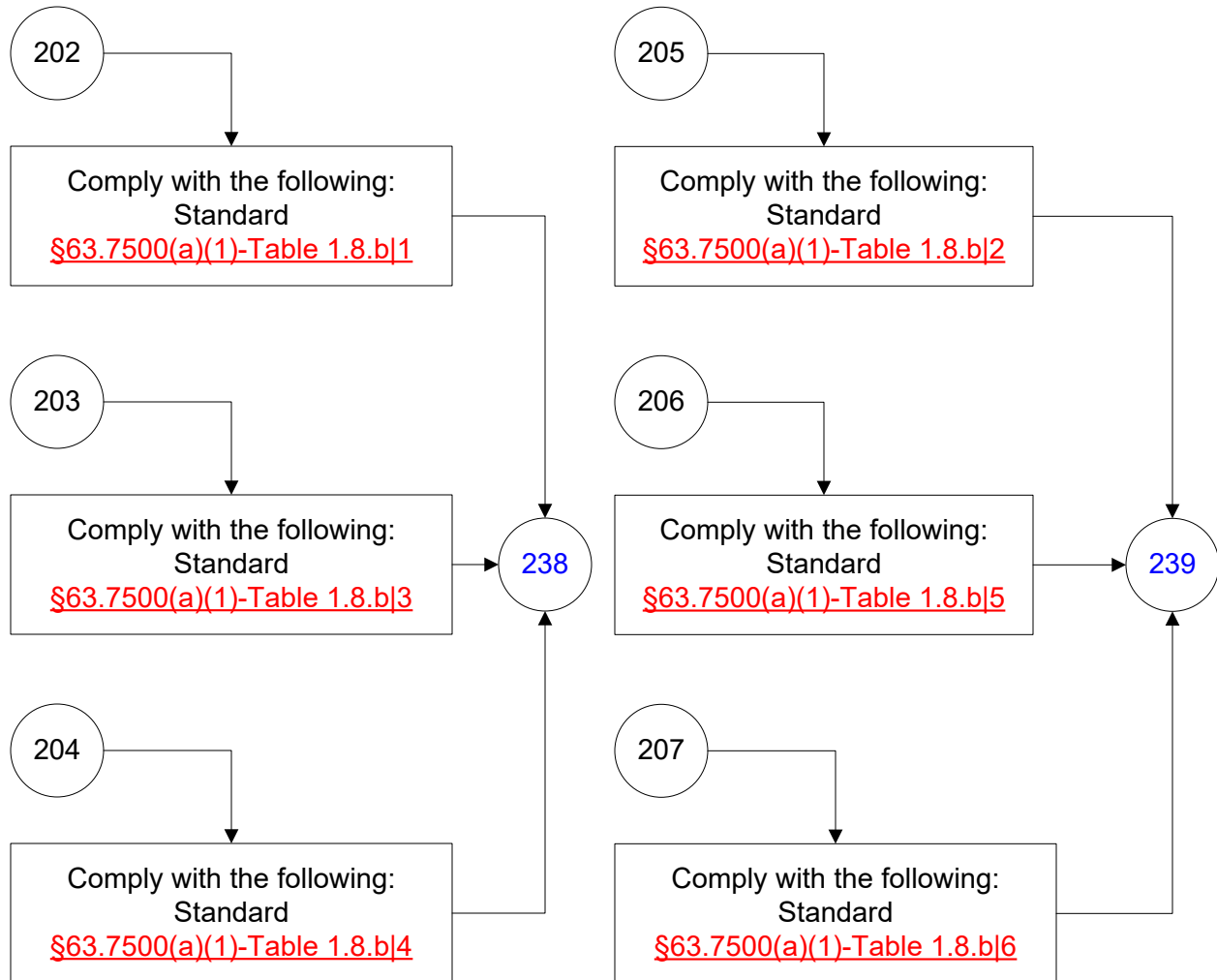

40 CFR Part 63, Subpart DDDDD (87 of 242)

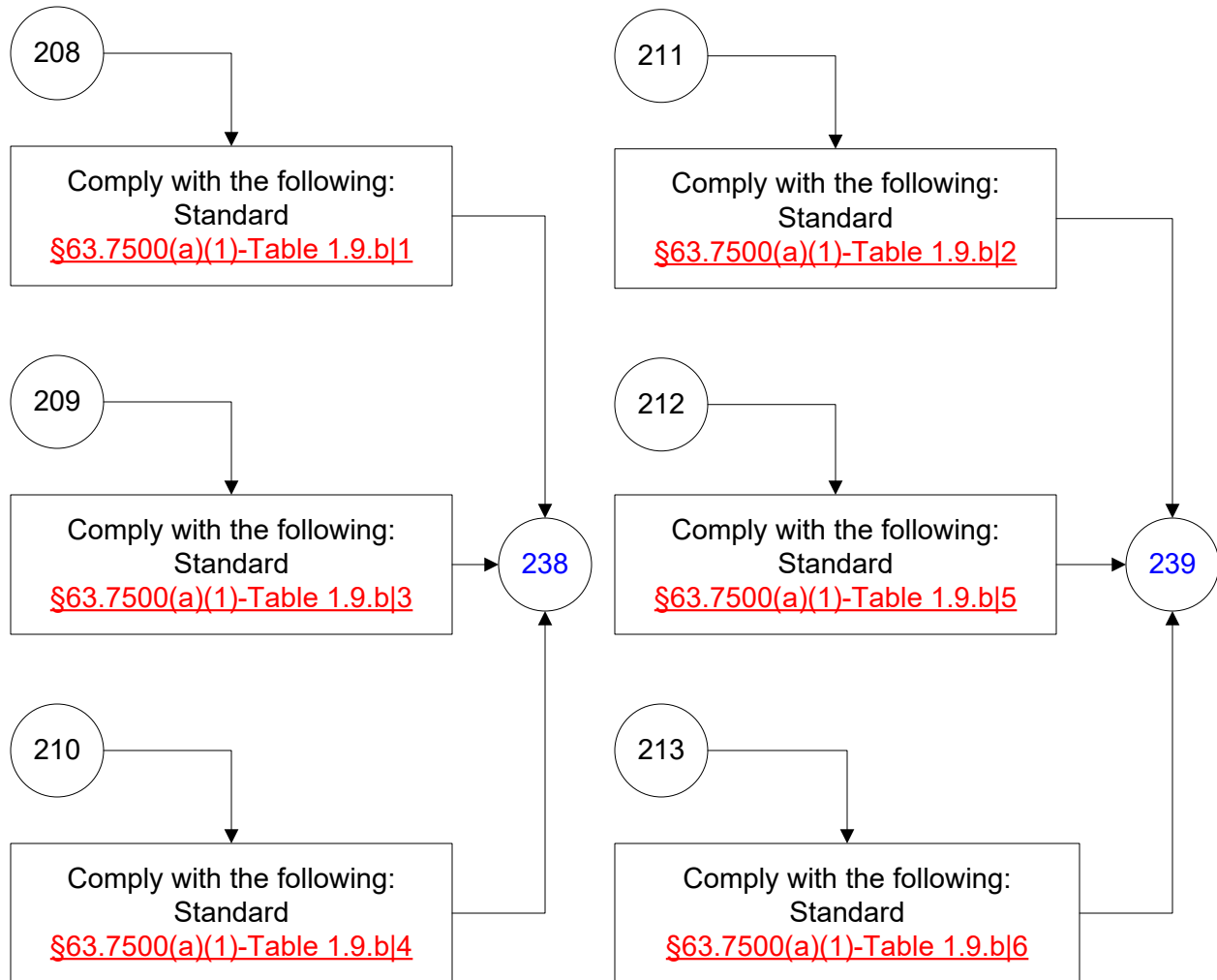

40 CFR Part 63, Subpart DDDDD (88 of 242)

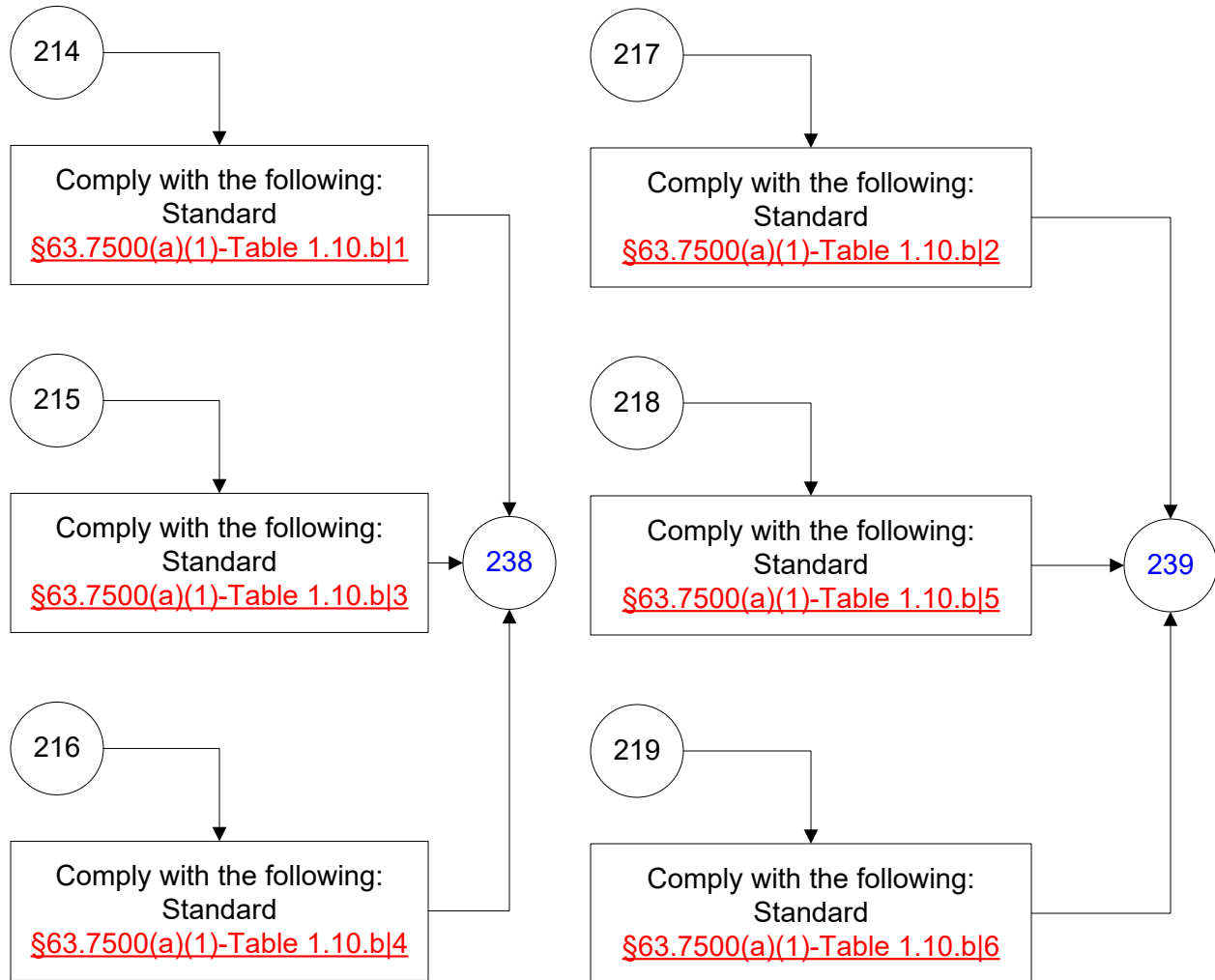

40 CFR Part 63, Subpart DDDDD (89 of 242)

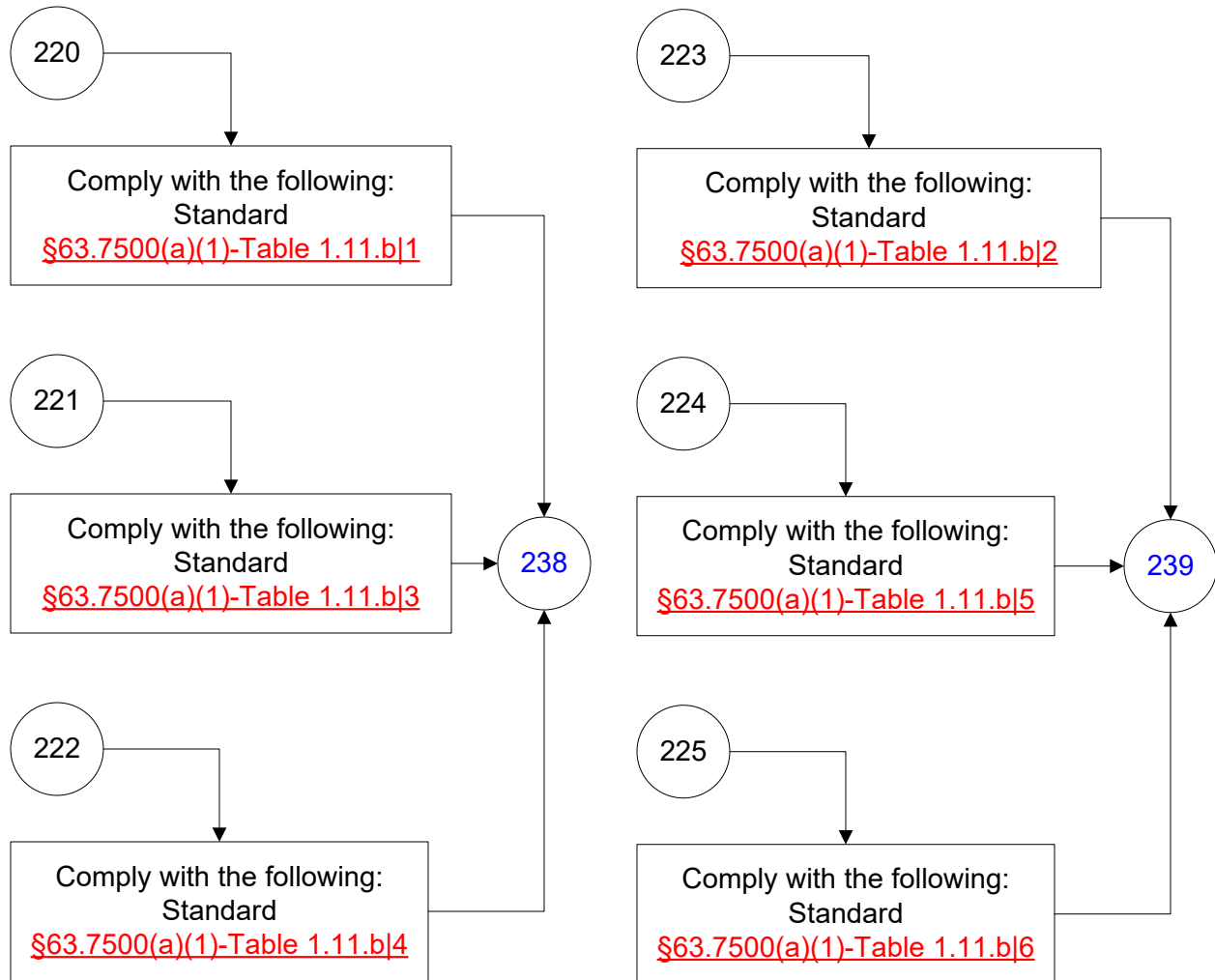

40 CFR Part 63, Subpart DDDDD (90 of 242)

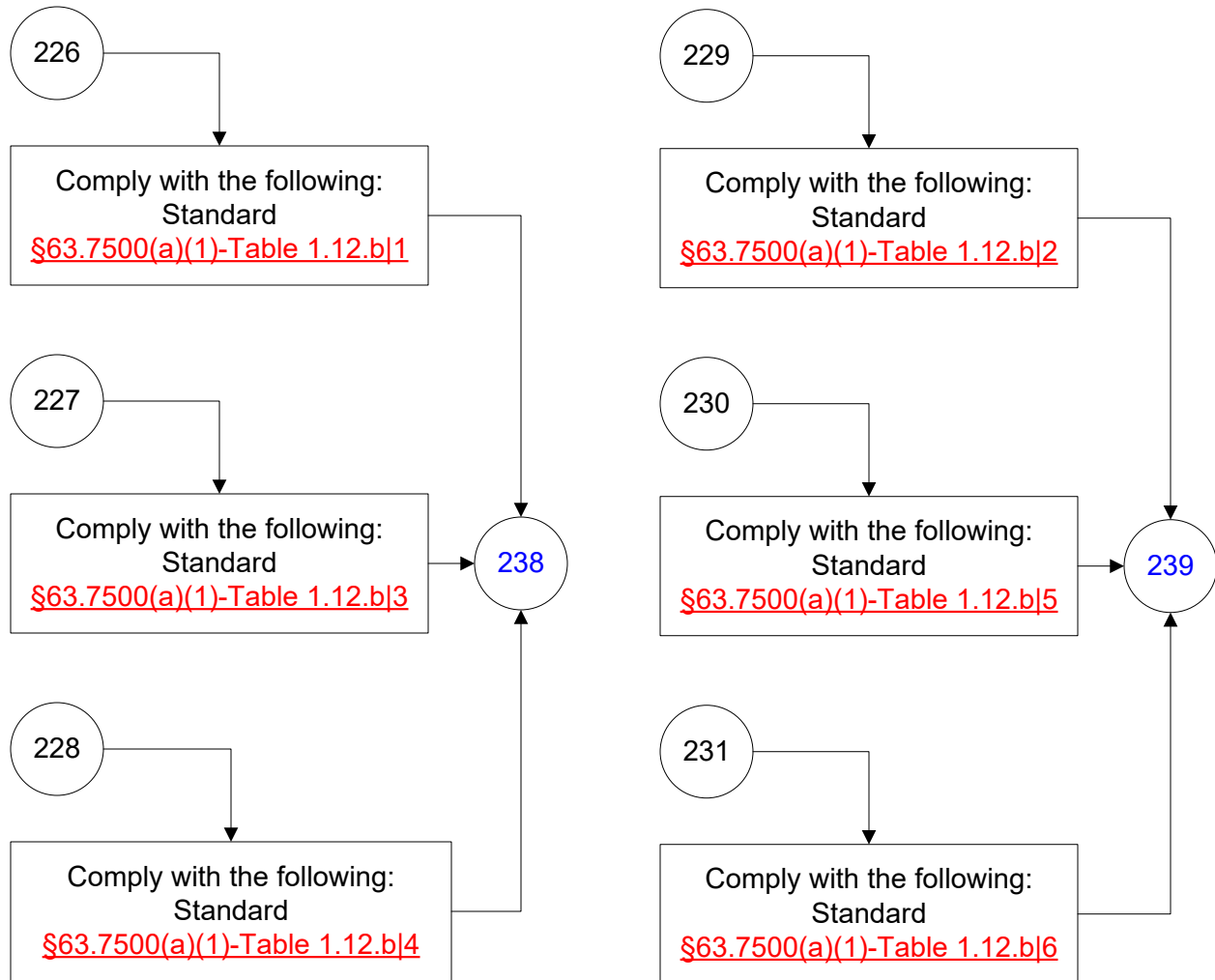

40 CFR Part 63, Subpart DDDDD (91 of 242)

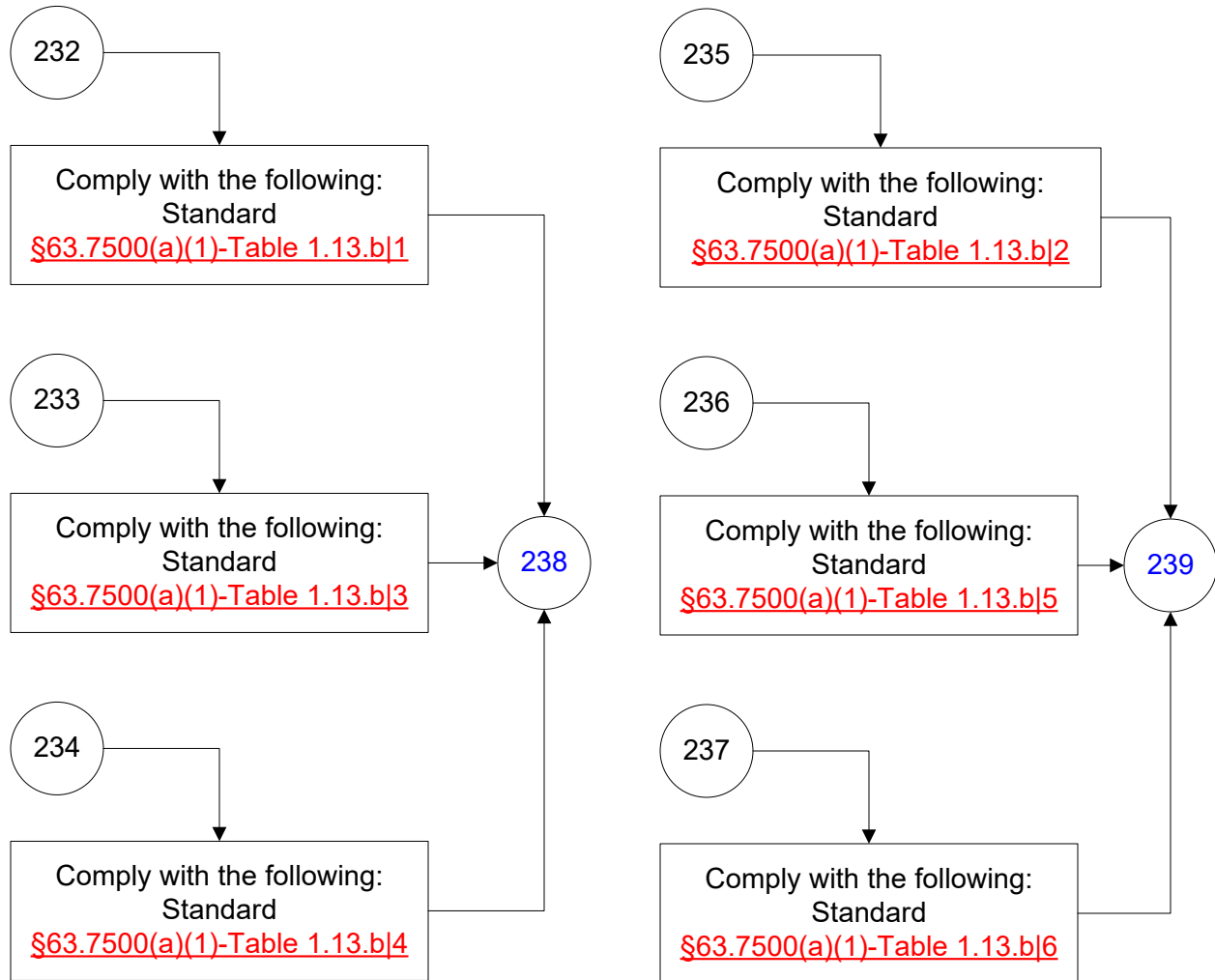

40 CFR Part 63, Subpart DDDDD
(92 of 242)

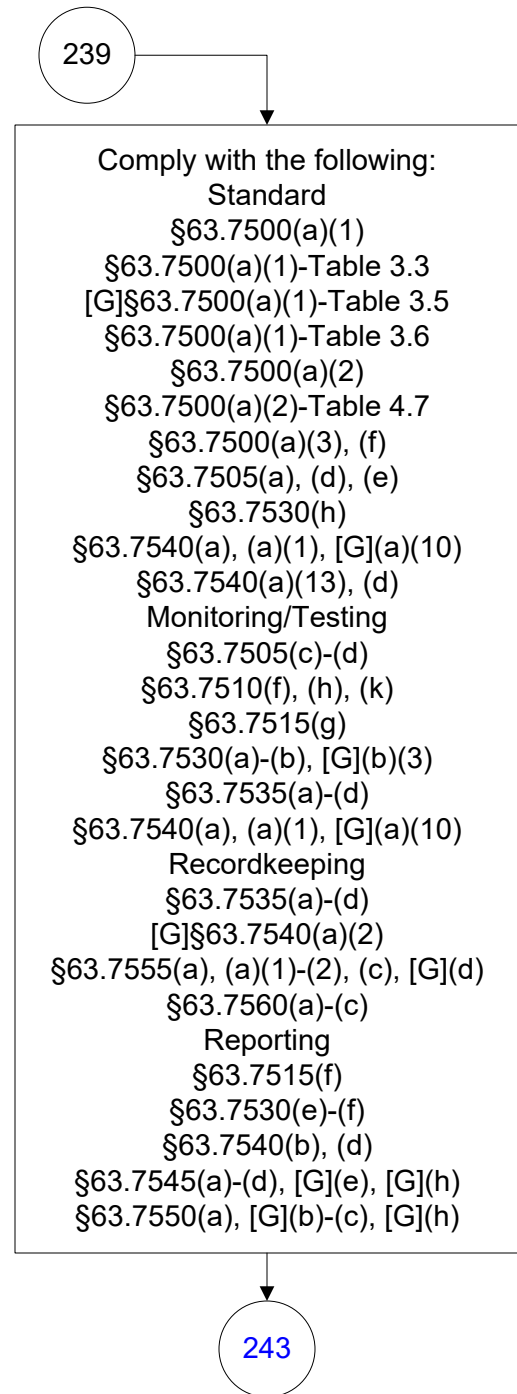
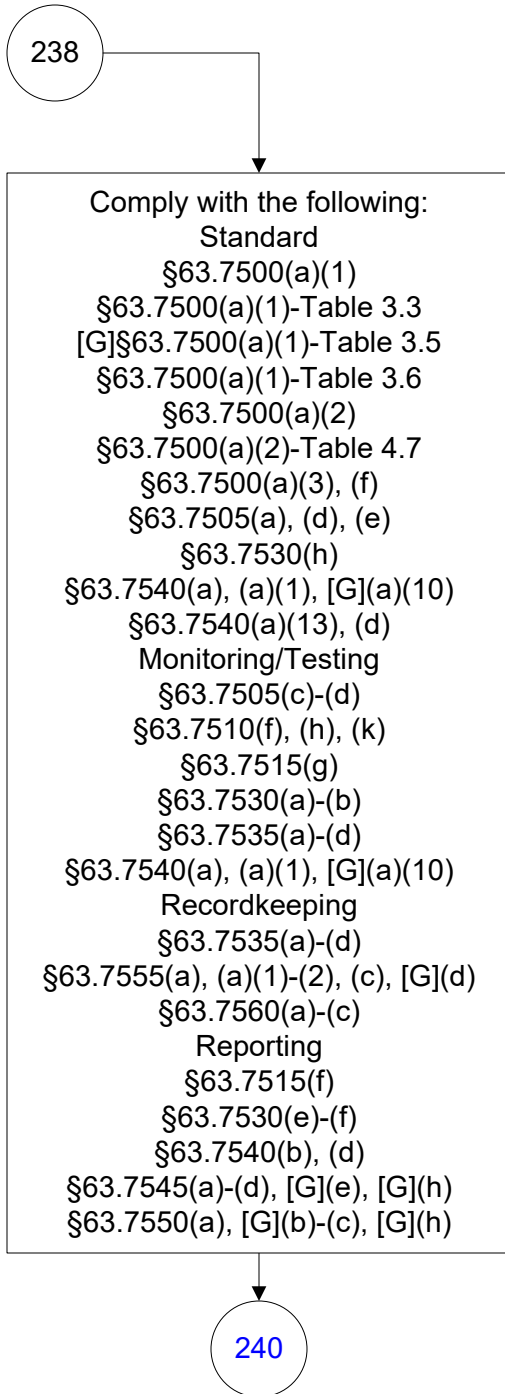

40 CFR Part 63, Subpart DDDDD (93 of 242)

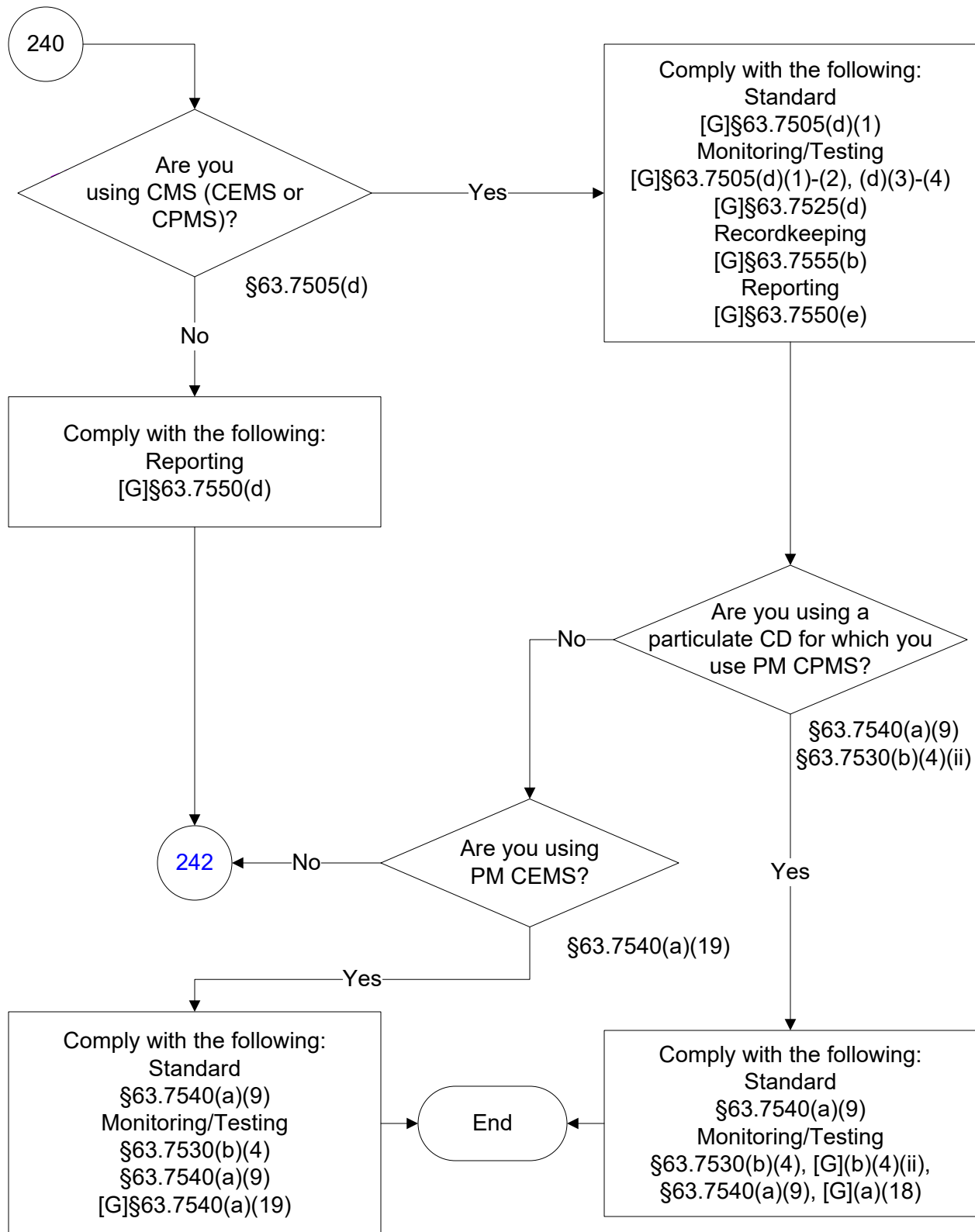

40 CFR Part 63, Subpart DDDDD (94 of 242)

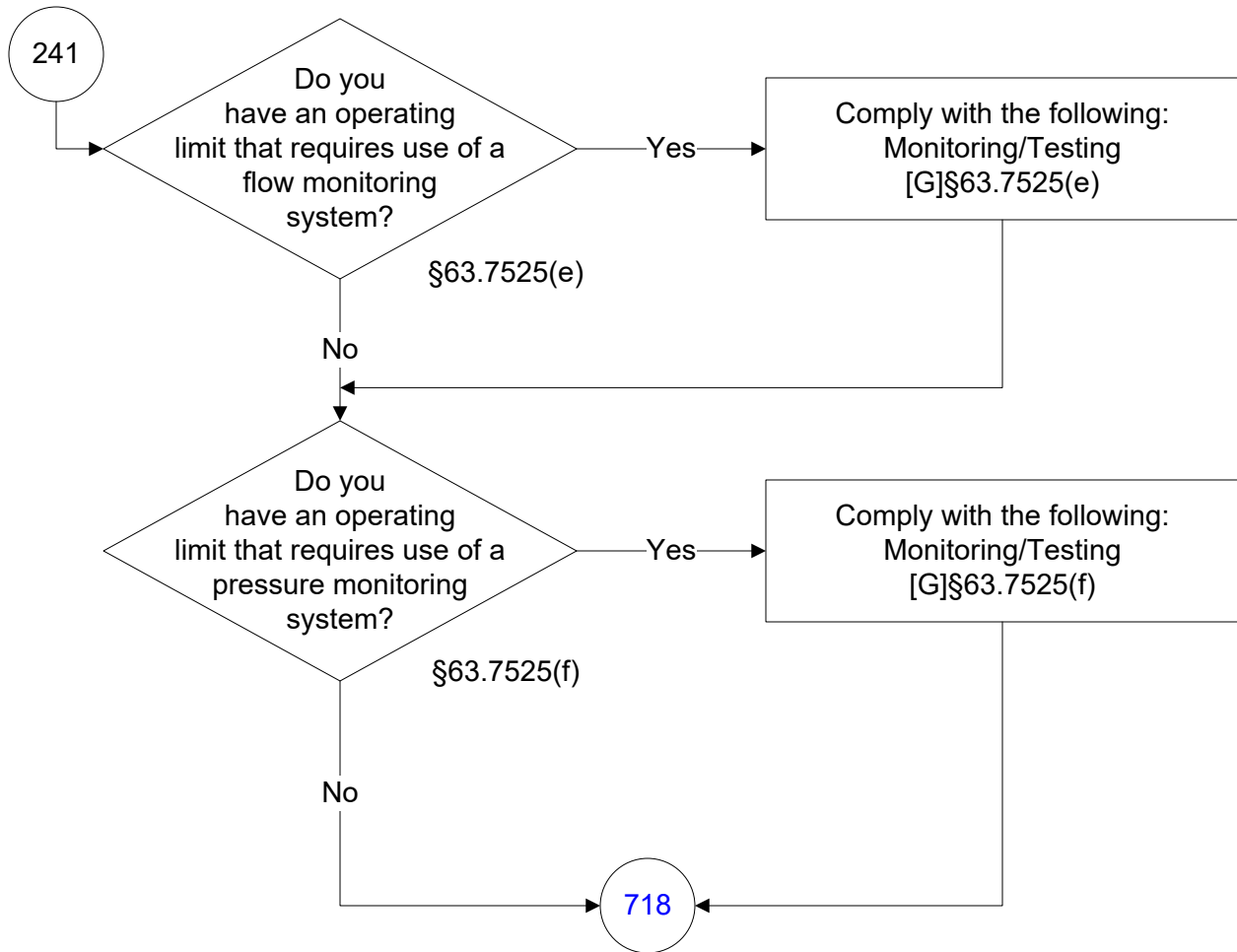

40 CFR Part 63, Subpart DDDDD (95 of 242)

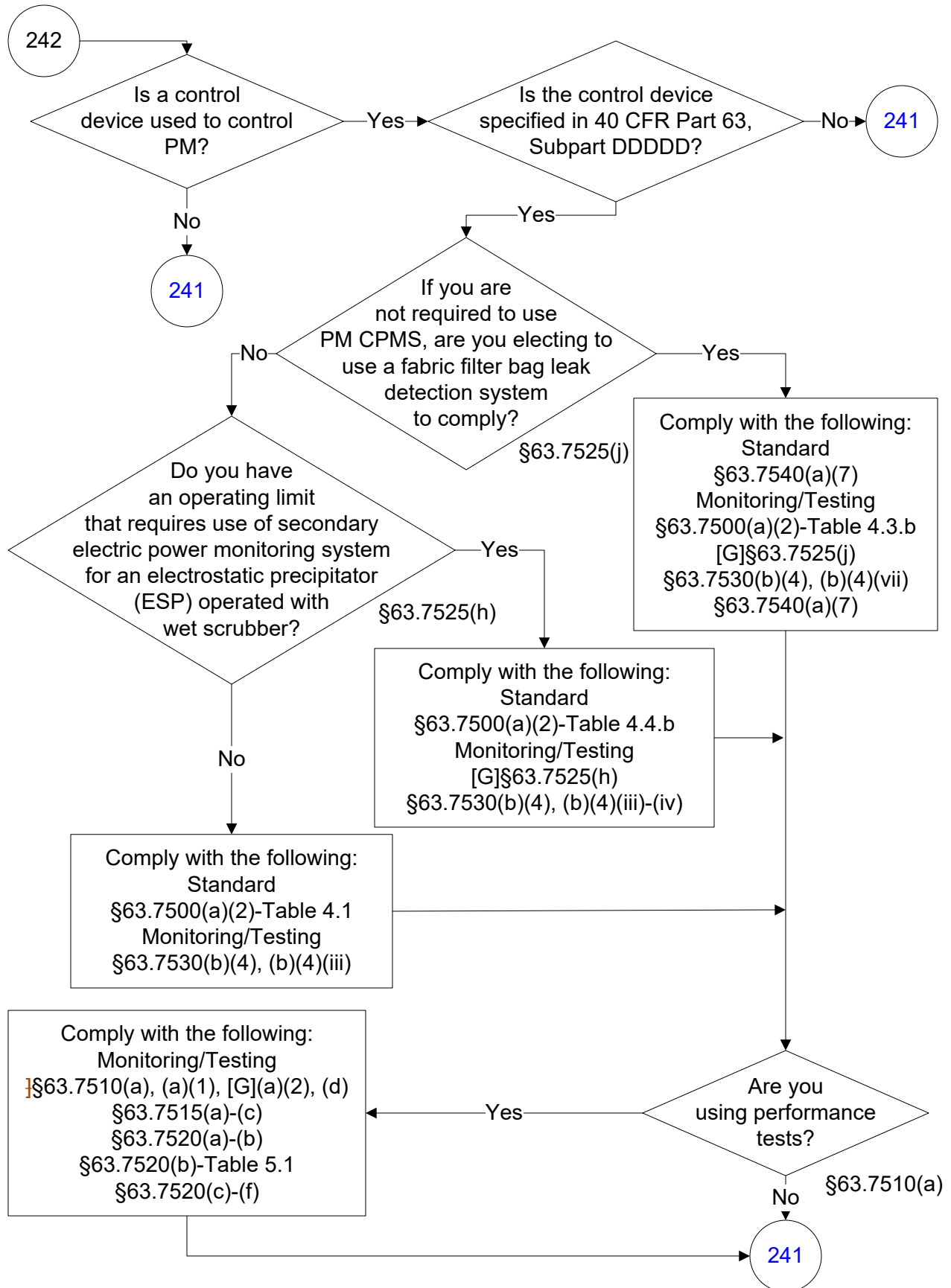

40 CFR Part 63, Subpart DDDDD (96 of 242)

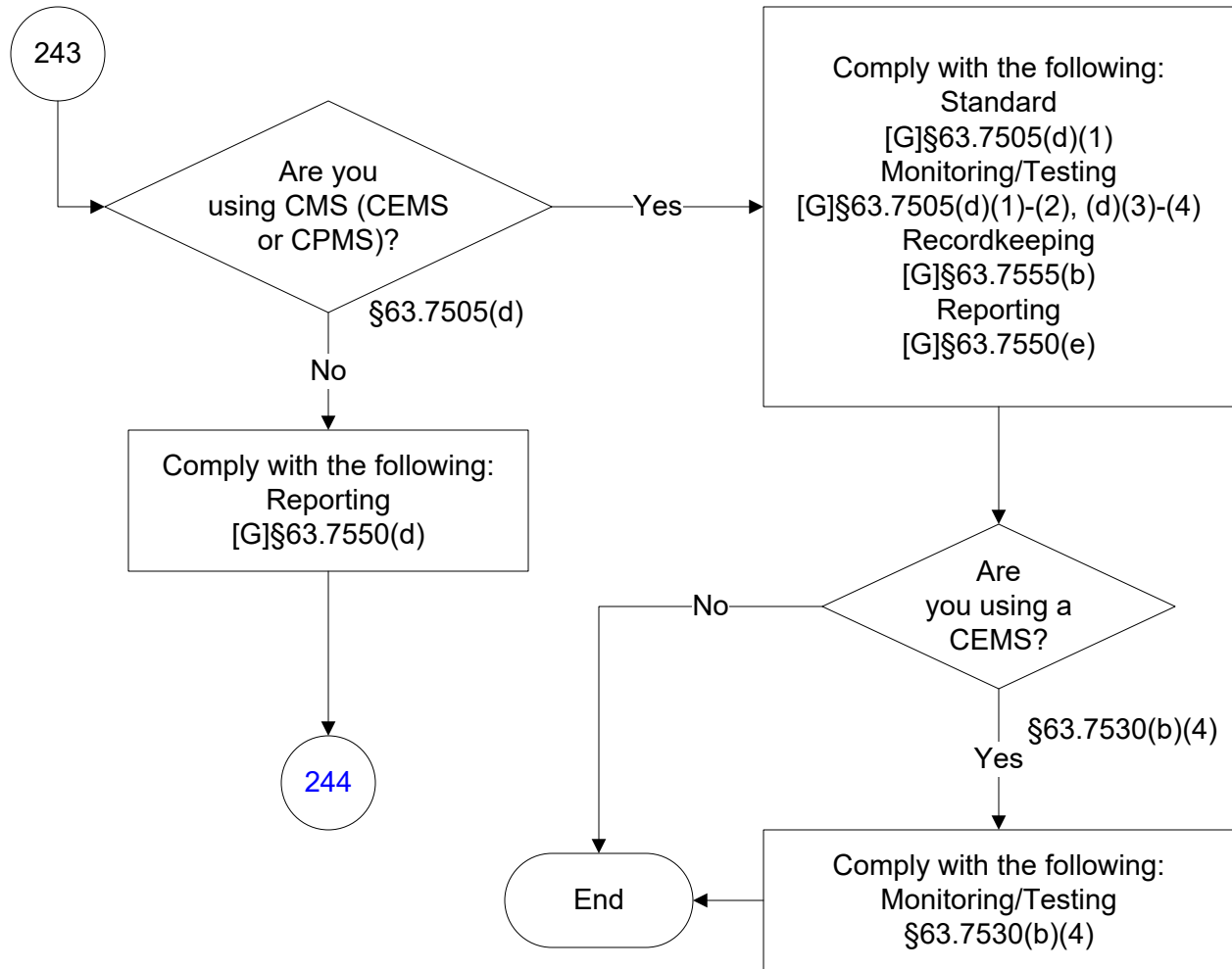

40 CFR Part 63, Subpart DDDDD (97 of 242)

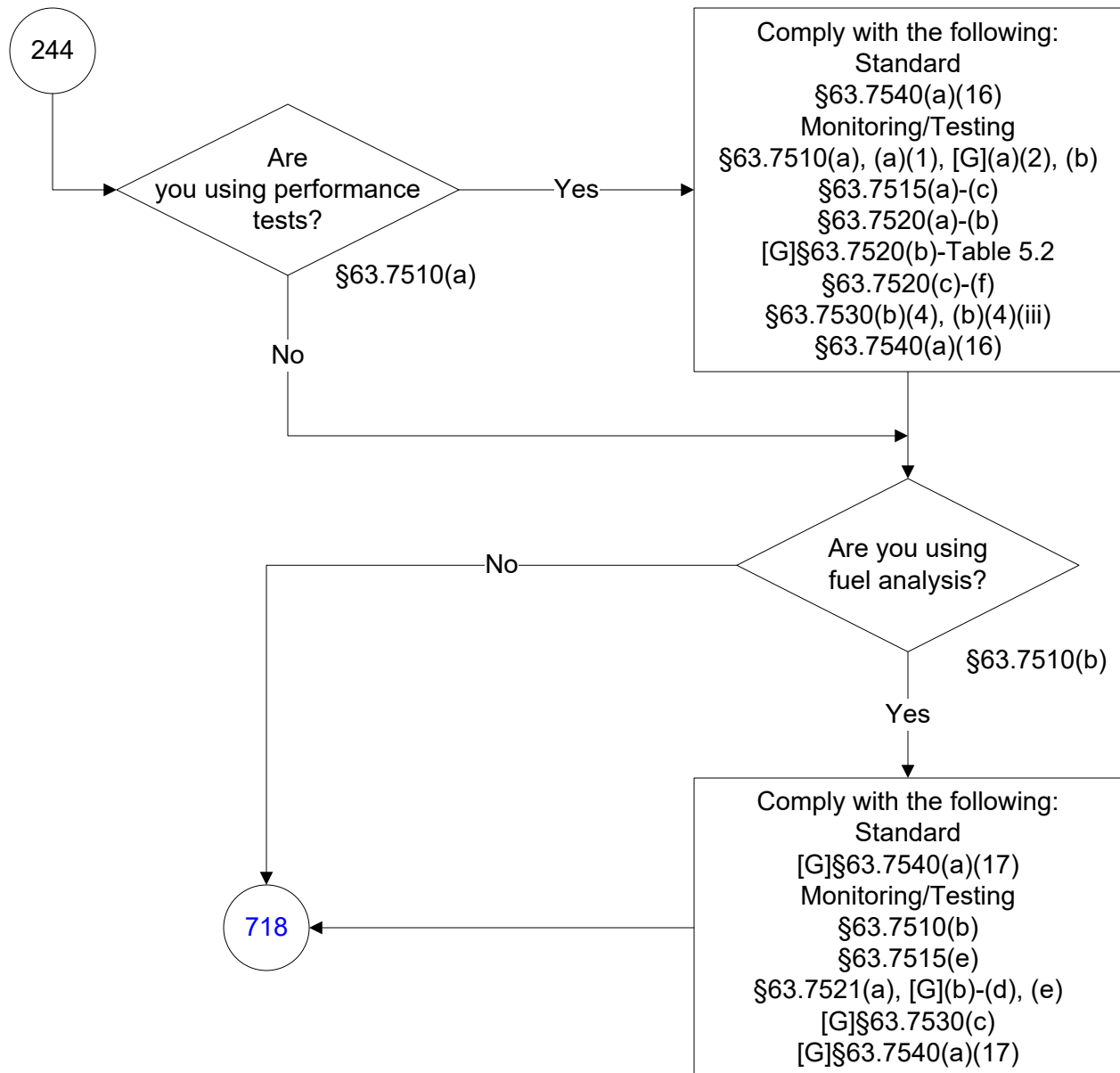

40 CFR Part 63, Subpart DDDDD (98 of 242)

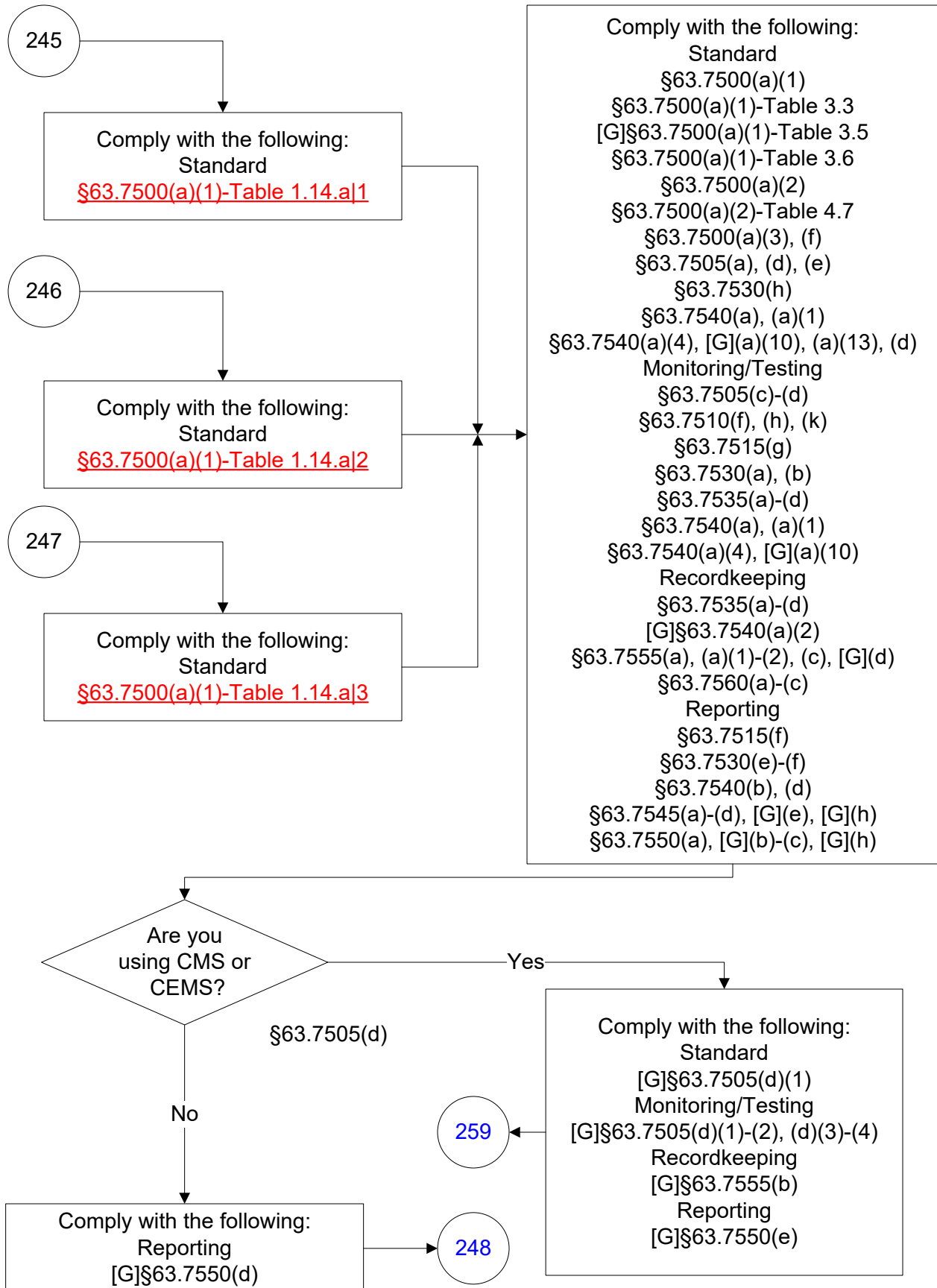

40 CFR Part 63, Subpart DDDDD (99 of 242)

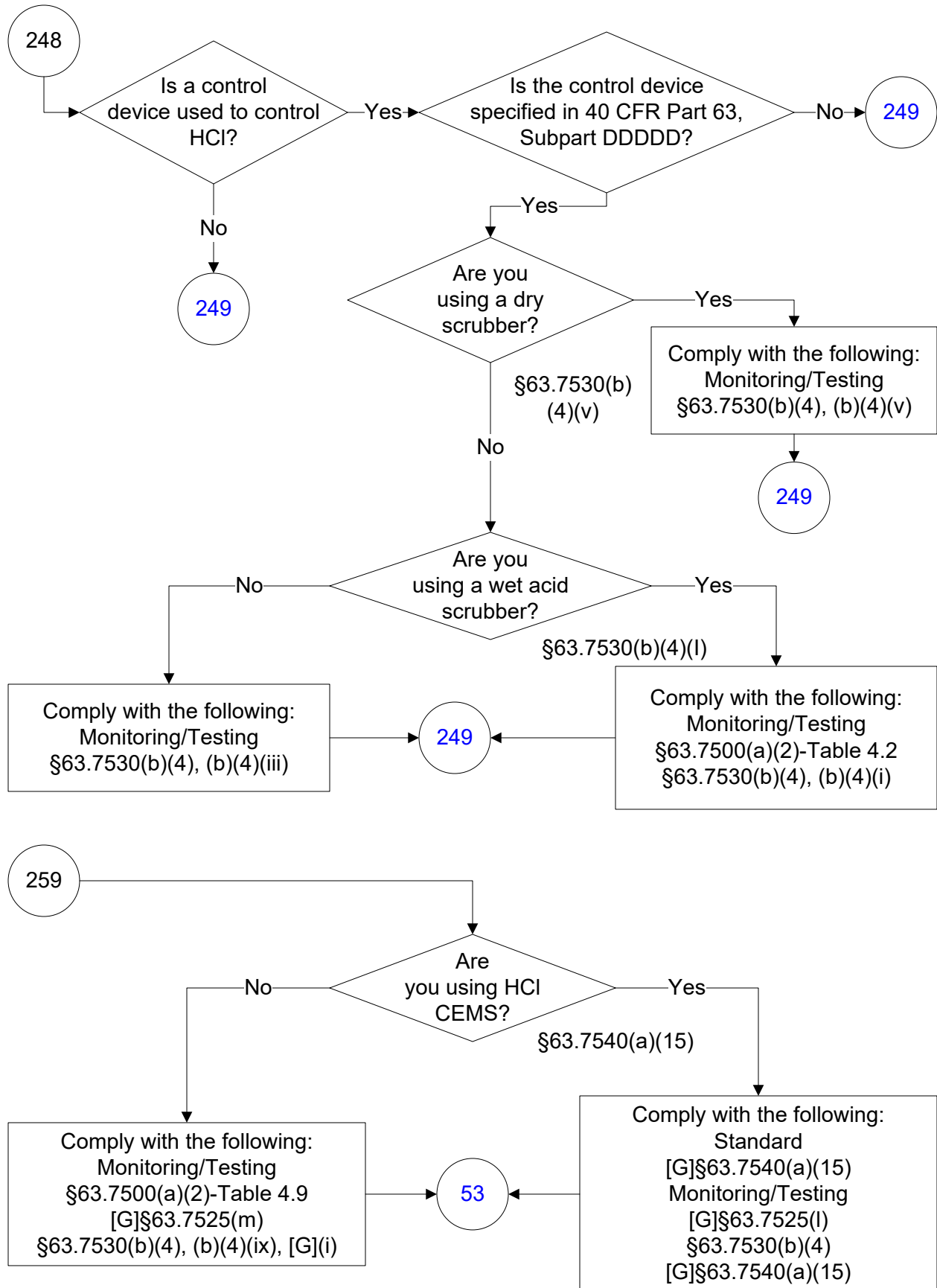

40 CFR Part 63, Subpart DDDDD (100 of 242)

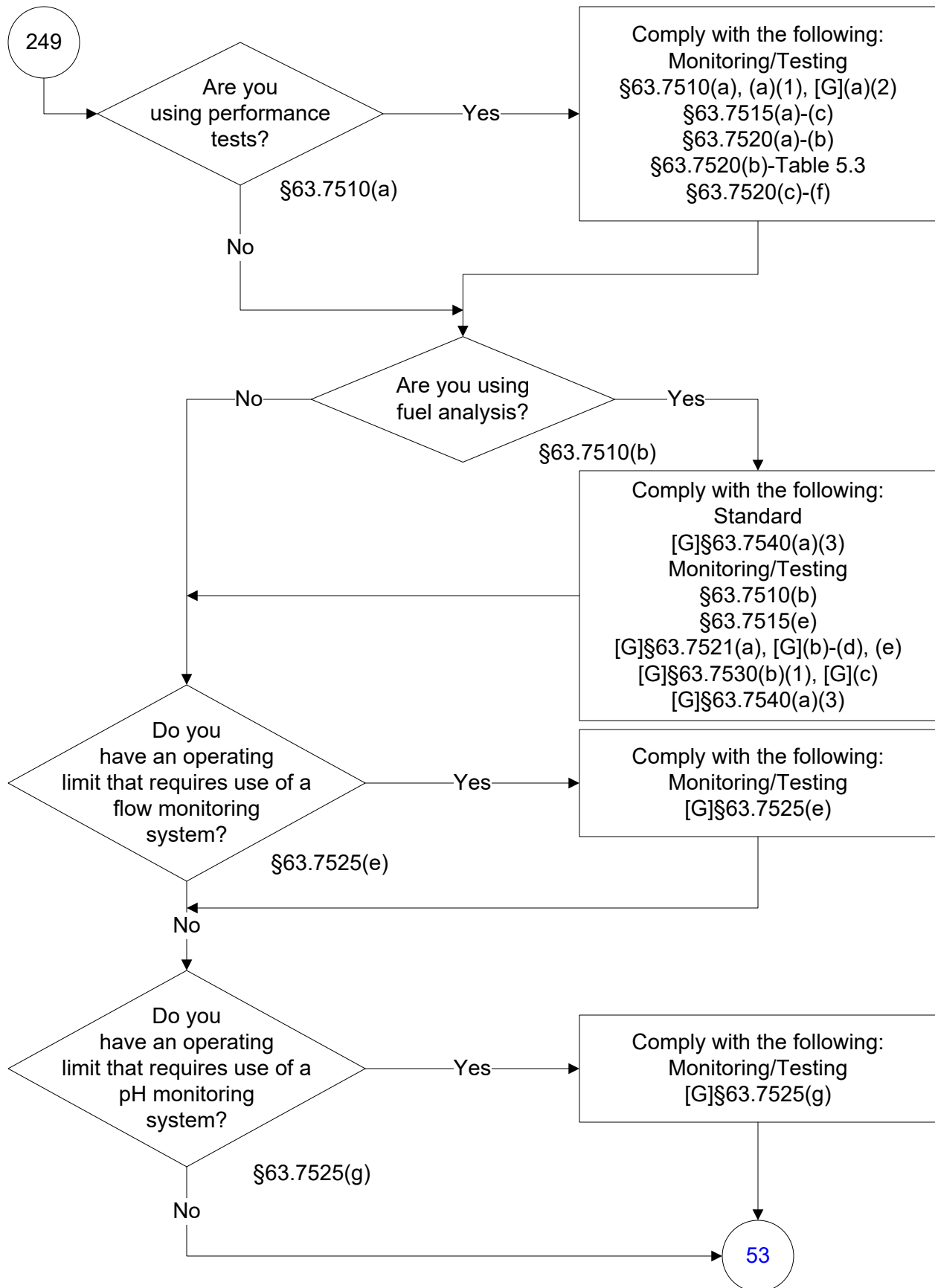

40 CFR Part 63, Subpart DDDDD (101 of 242)

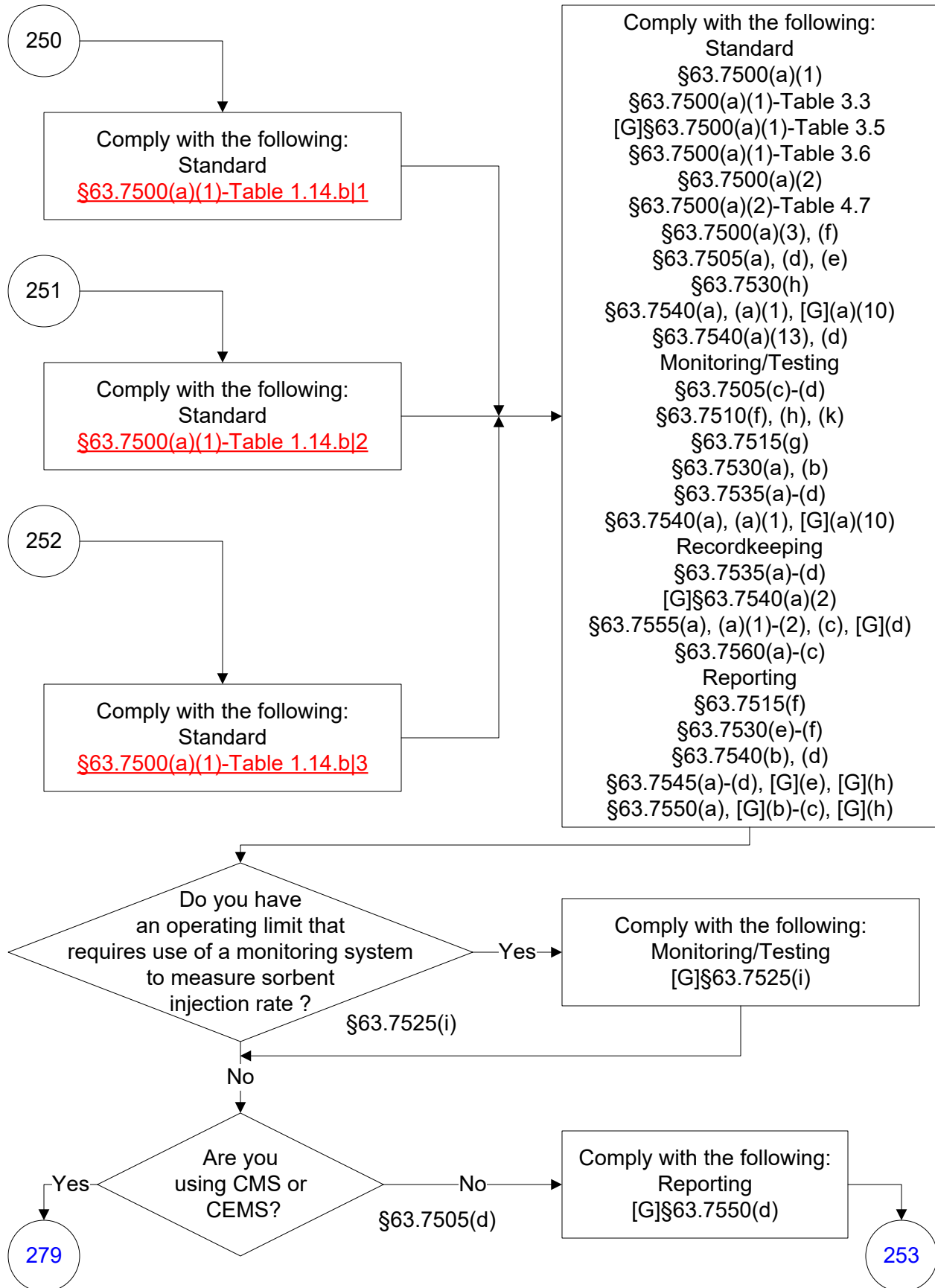

40 CFR Part 63, Subpart DDDDD (102 of 242)

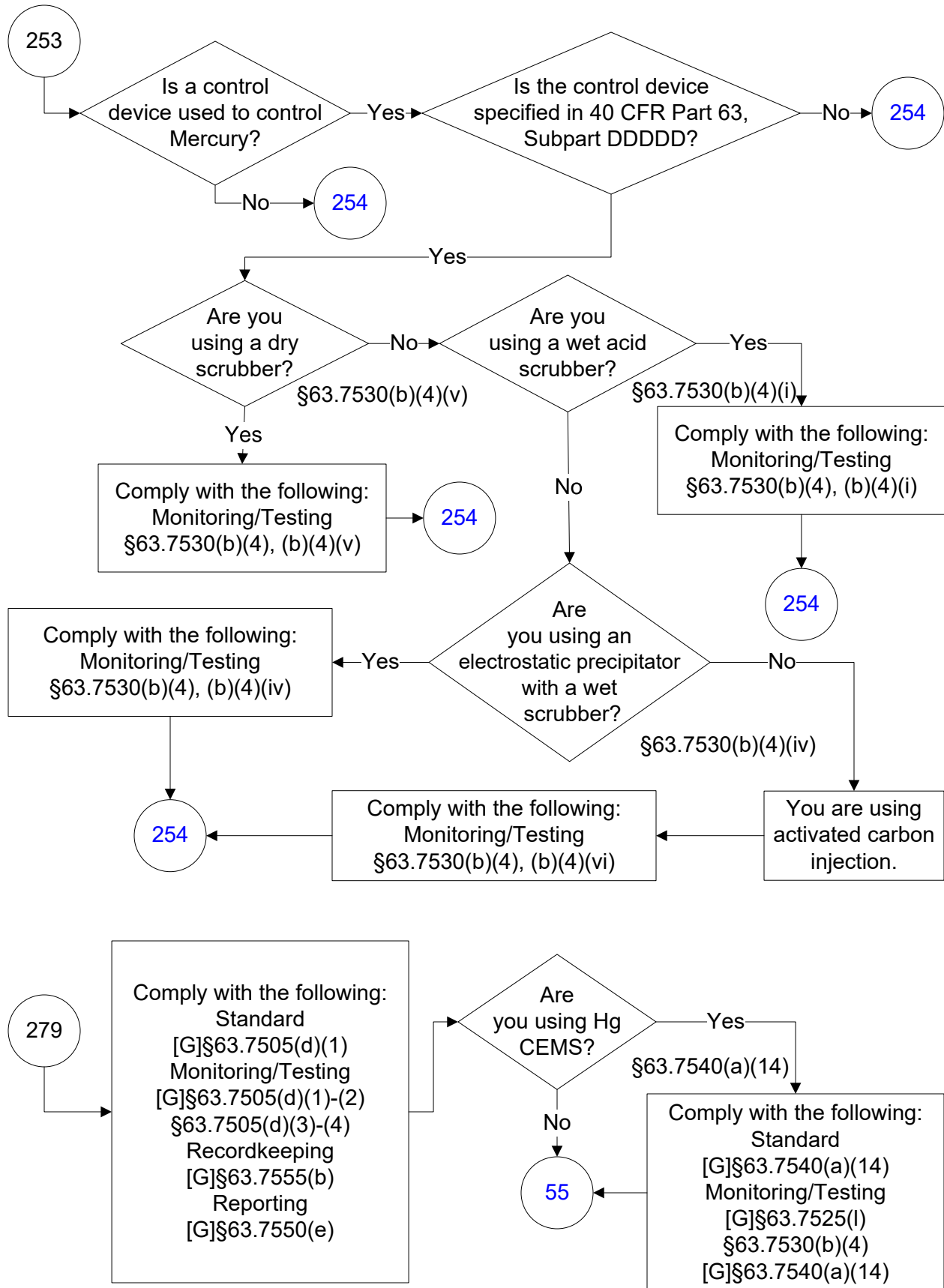

40 CFR Part 63, Subpart DDDDD (103 of 242)

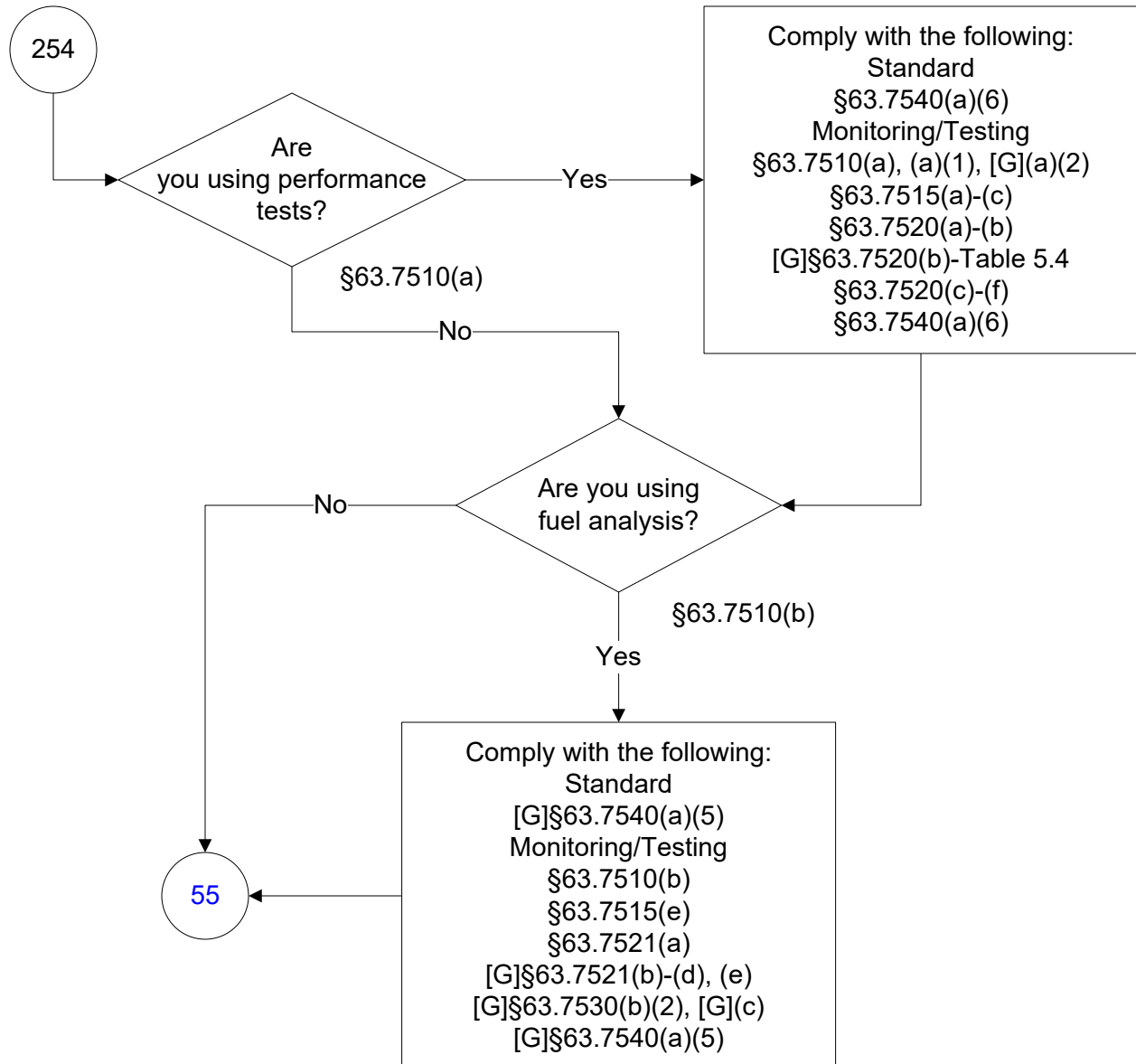

40 CFR Part 63, Subpart DDDDD
(104 of 242)

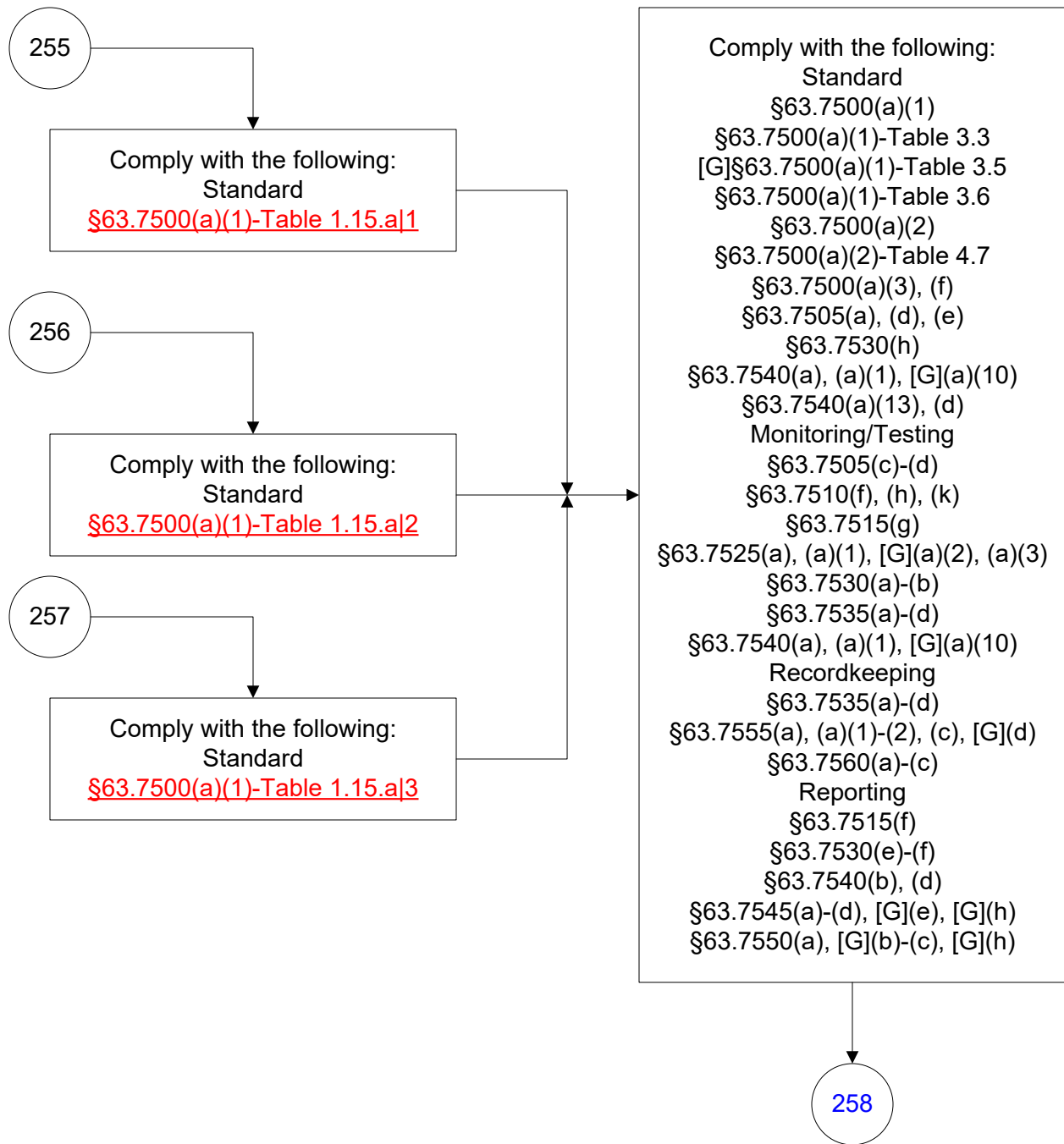

40 CFR Part 63, Subpart DDDDD (105 of 242)

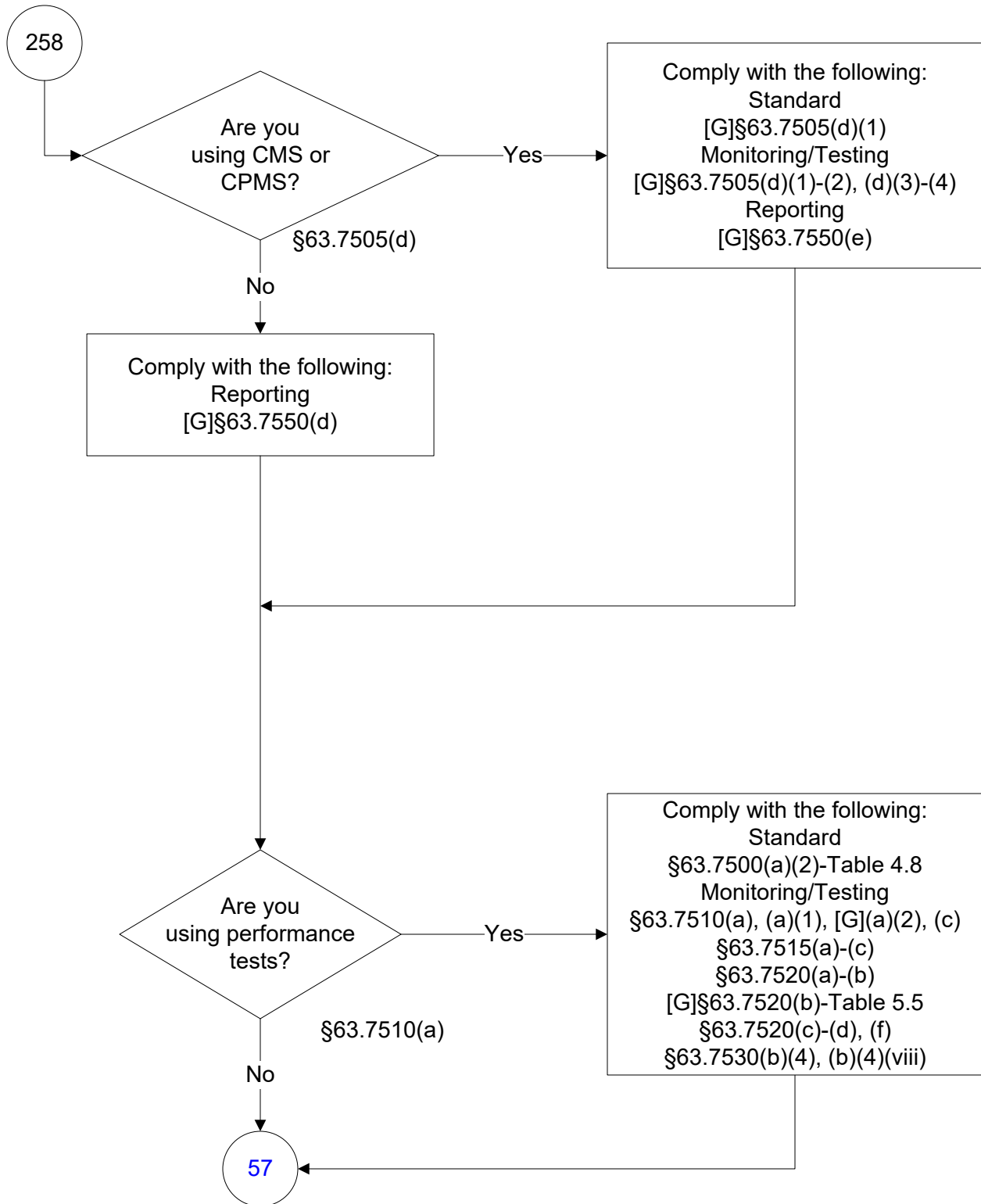

40 CFR Part 63, Subpart DDDDD (106 of 242)

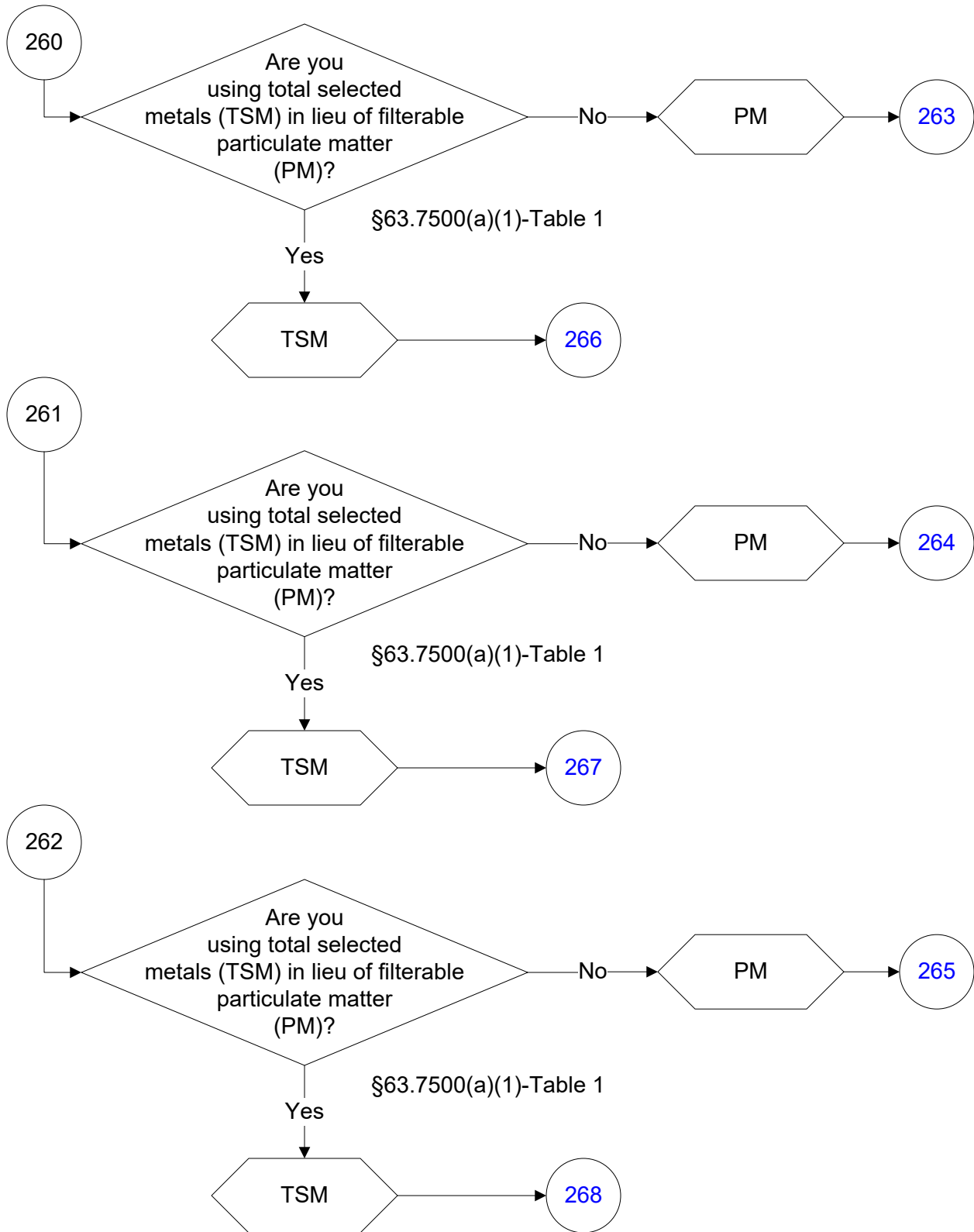

40 CFR Part 63, Subpart DDDDD (107 of 242)

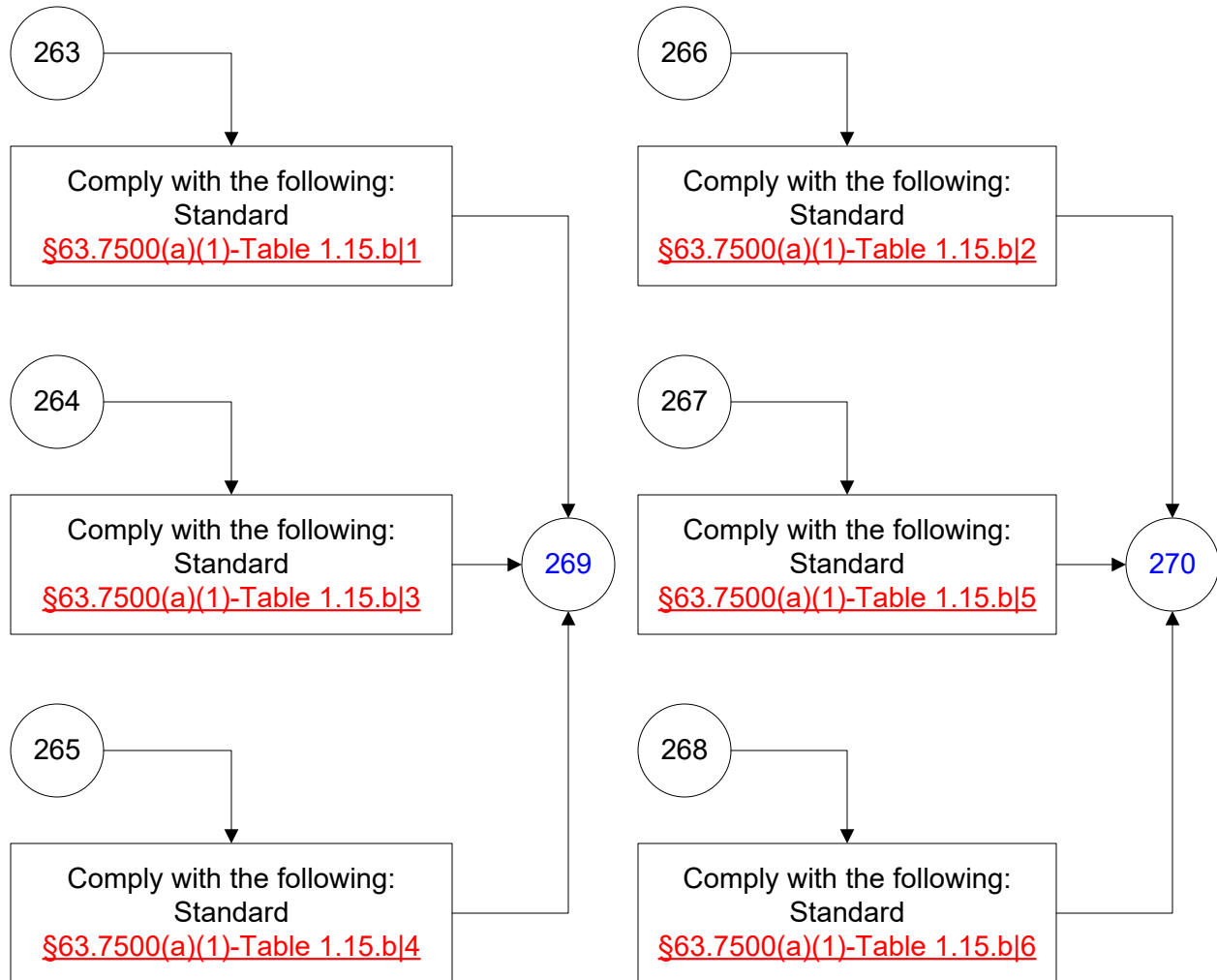

40 CFR Part 63, Subpart DDDDD
(108 of 242)

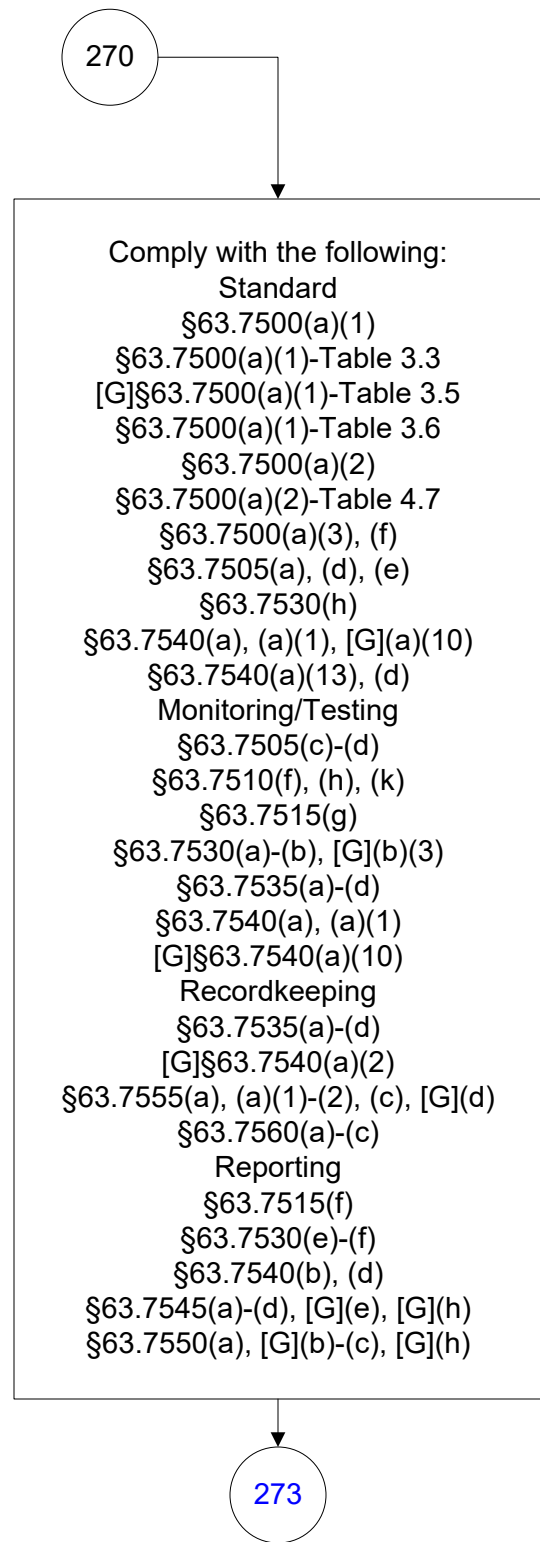
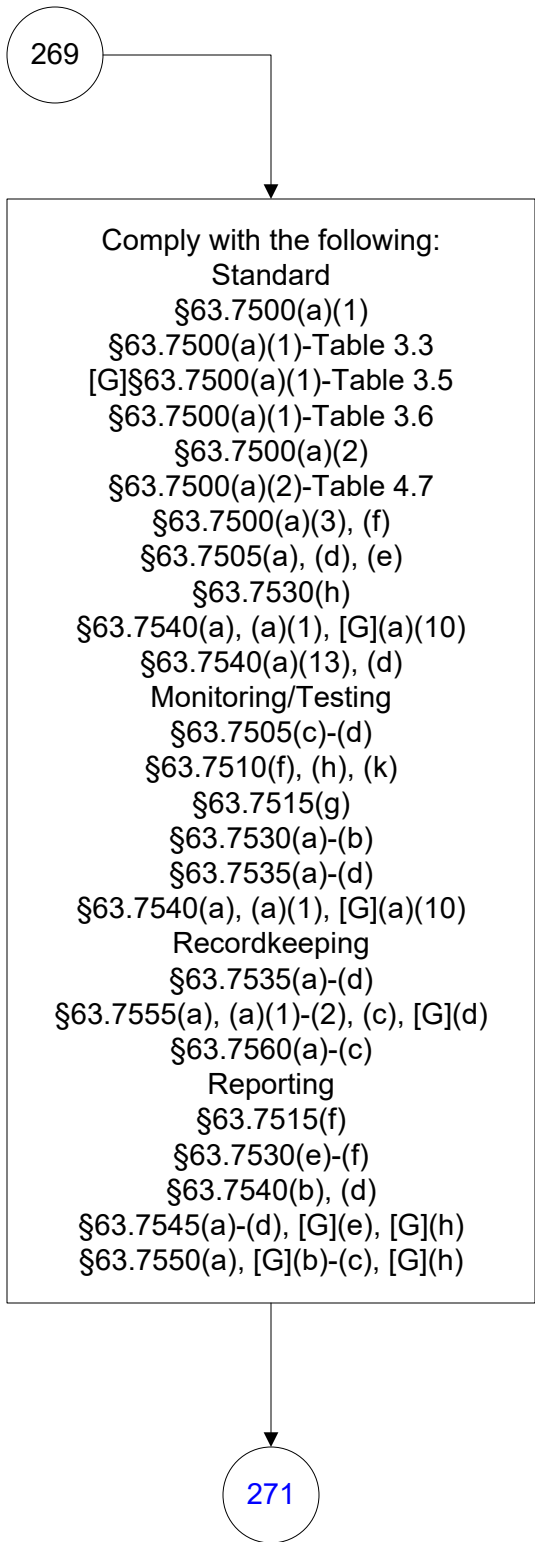

40 CFR Part 63, Subpart DDDDD (109 of 242)

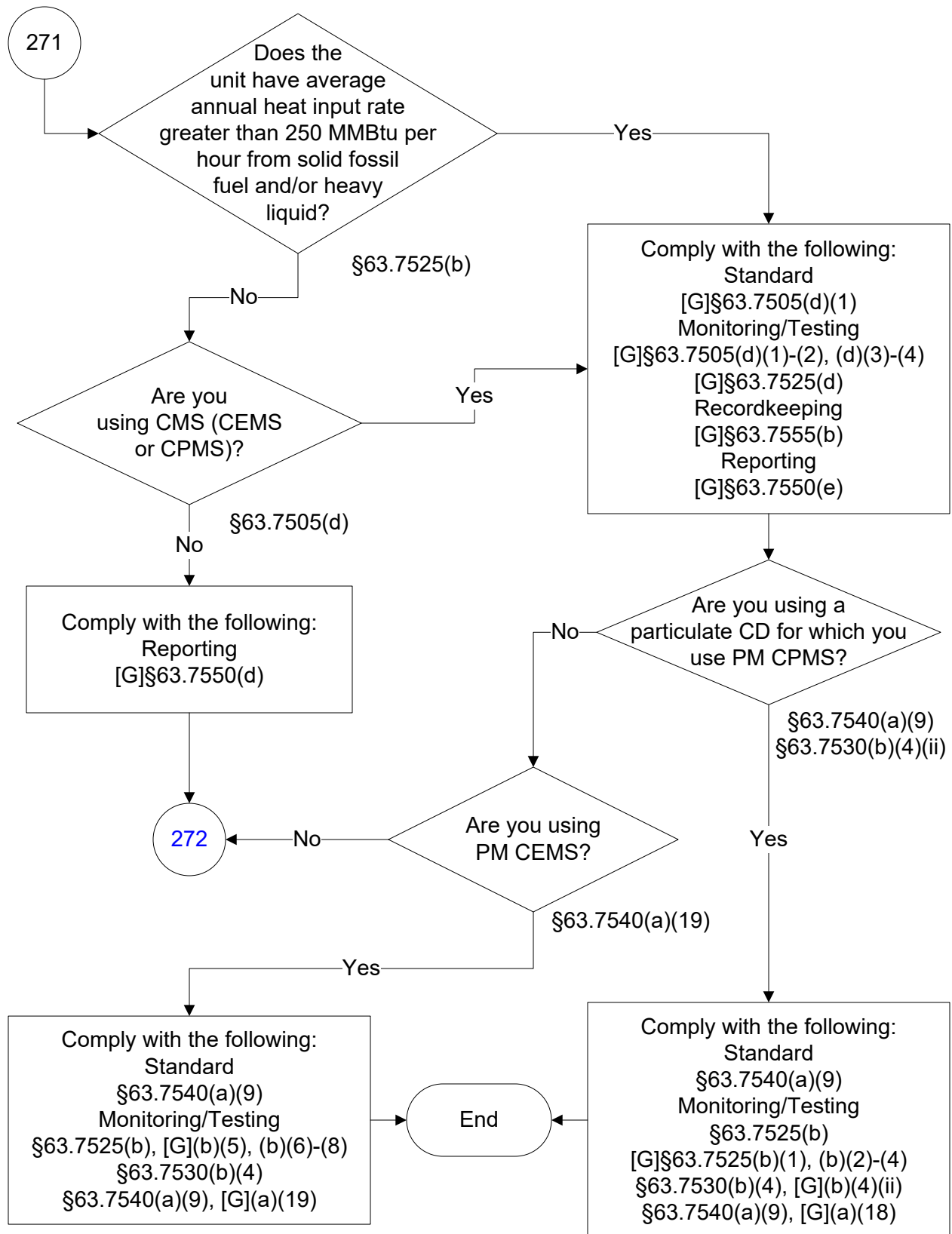

40 CFR Part 63, Subpart DDDDD (110 of 242)

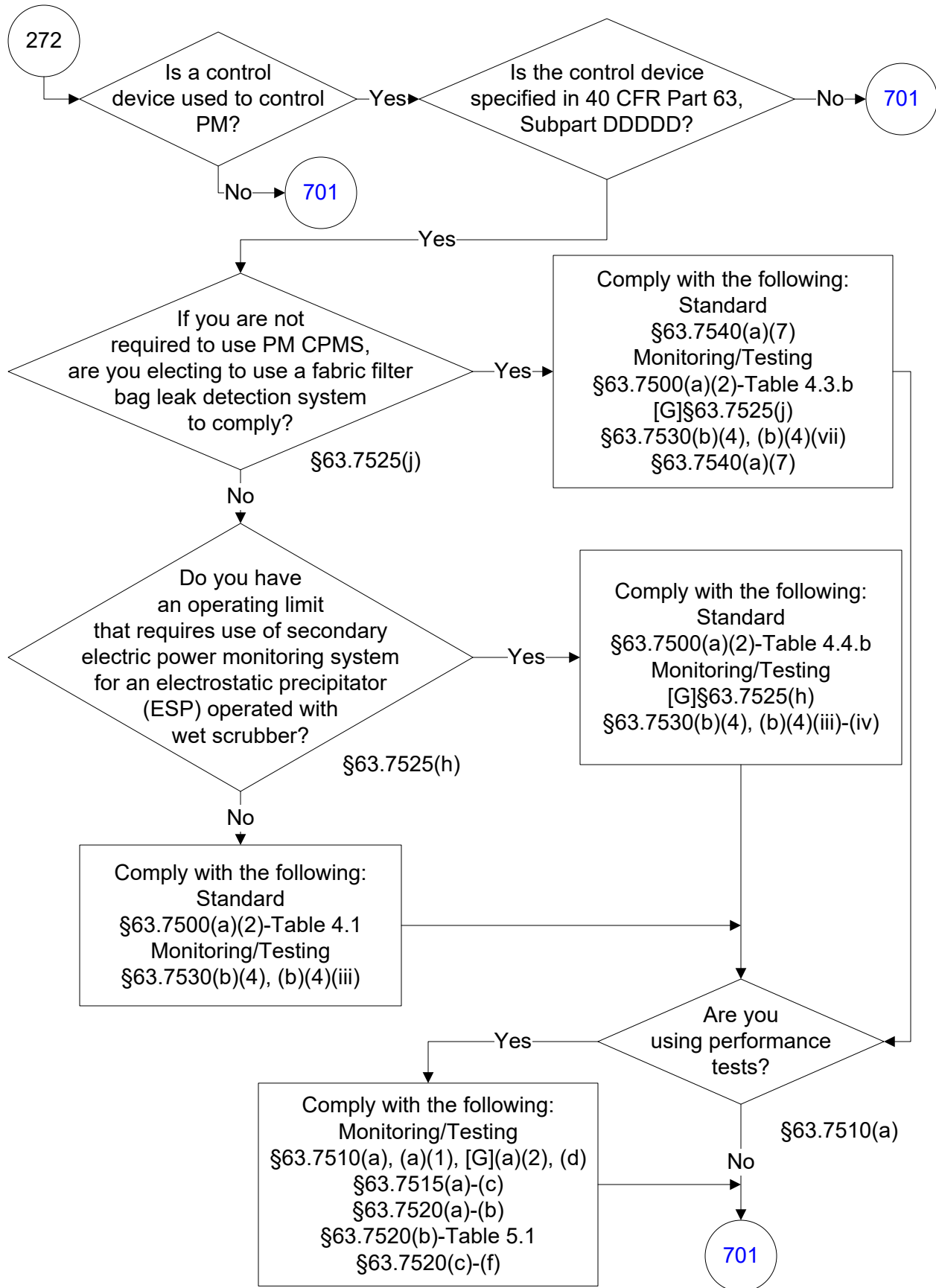

40 CFR Part 63, Subpart DDDDD (111 of 242)

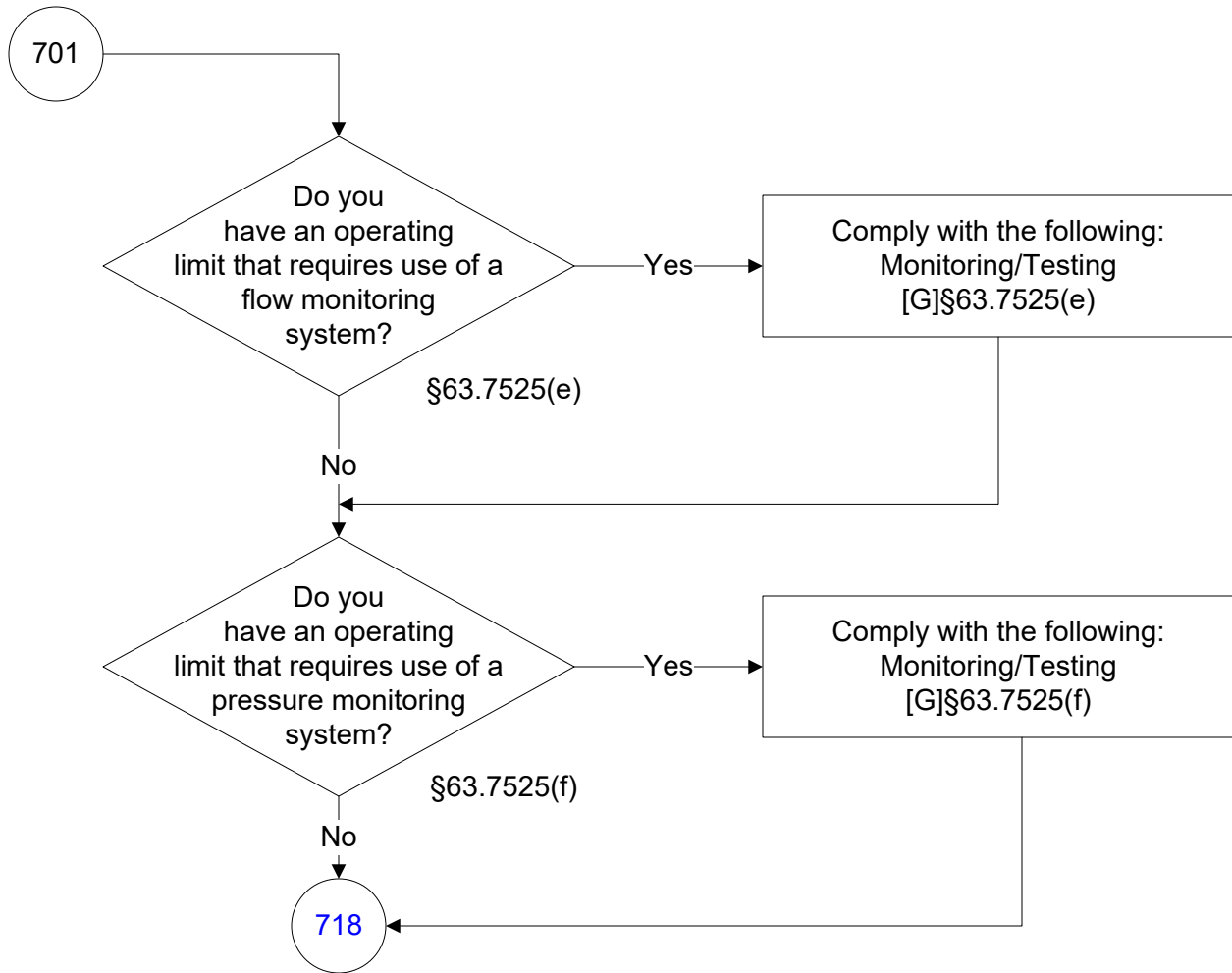

40 CFR Part 63, Subpart DDDDD (112 of 242)

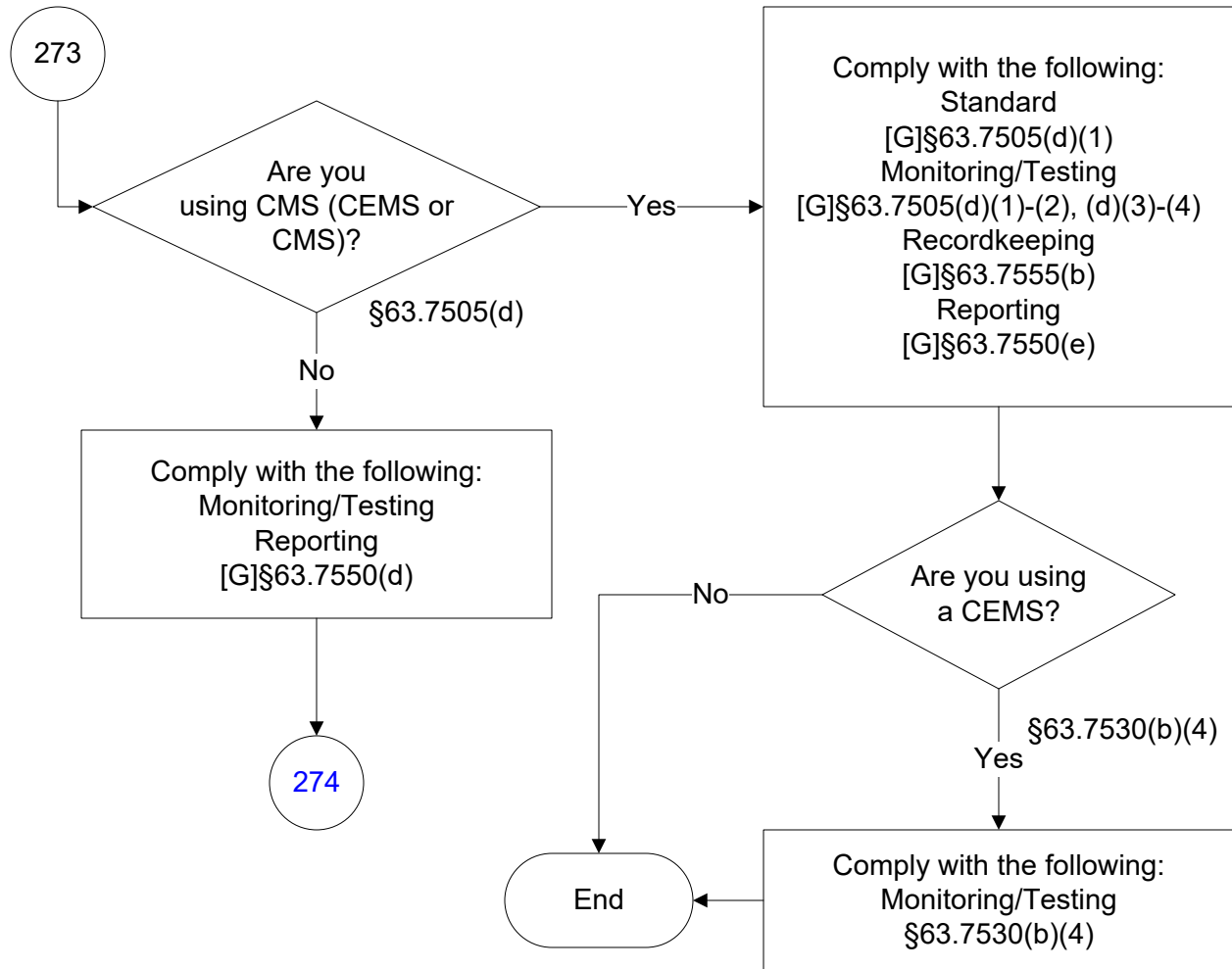

40 CFR Part 63, Subpart DDDDD (113 of 242)

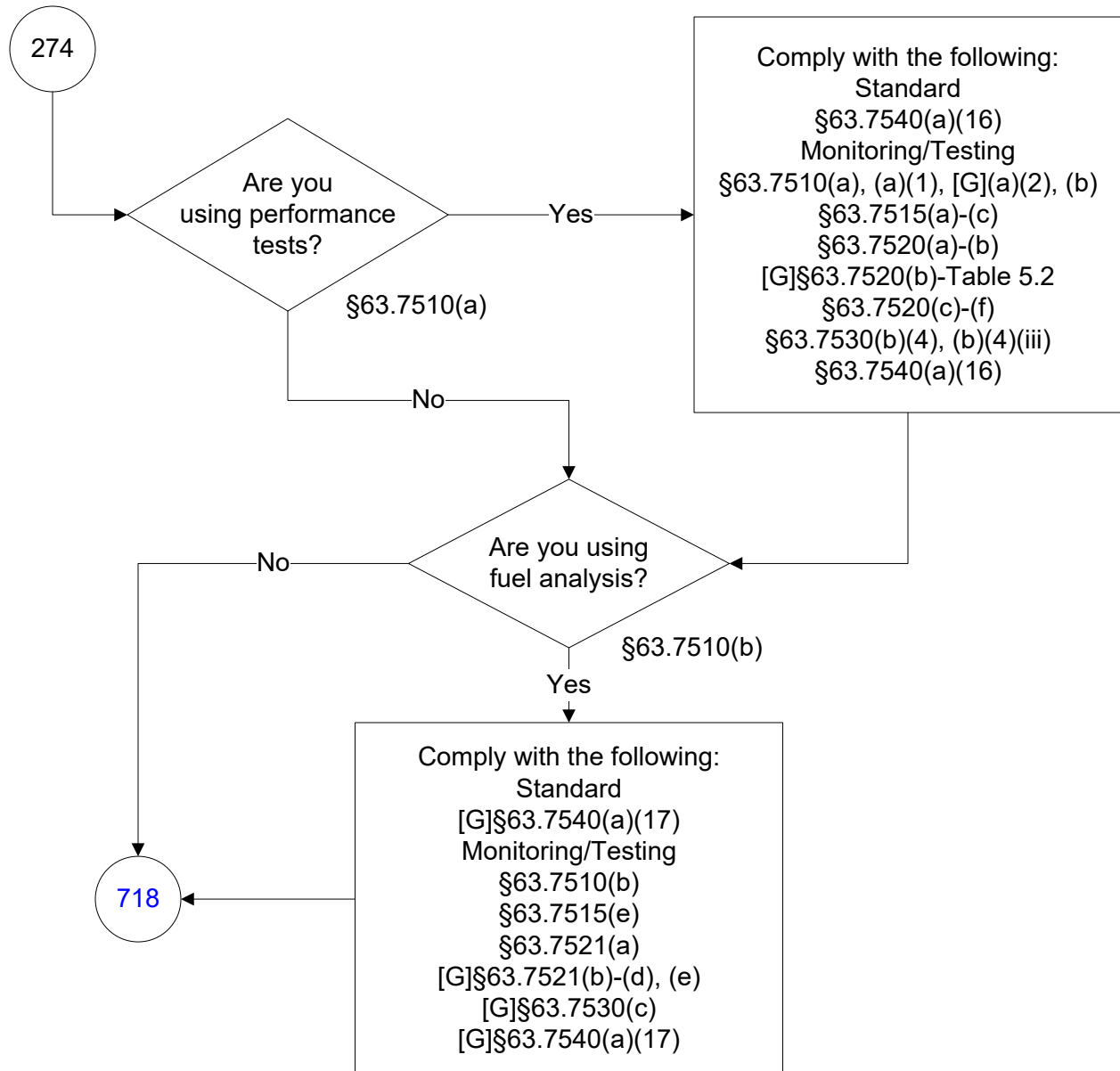

40 CFR Part 63, Subpart DDDDD (114 of 242)

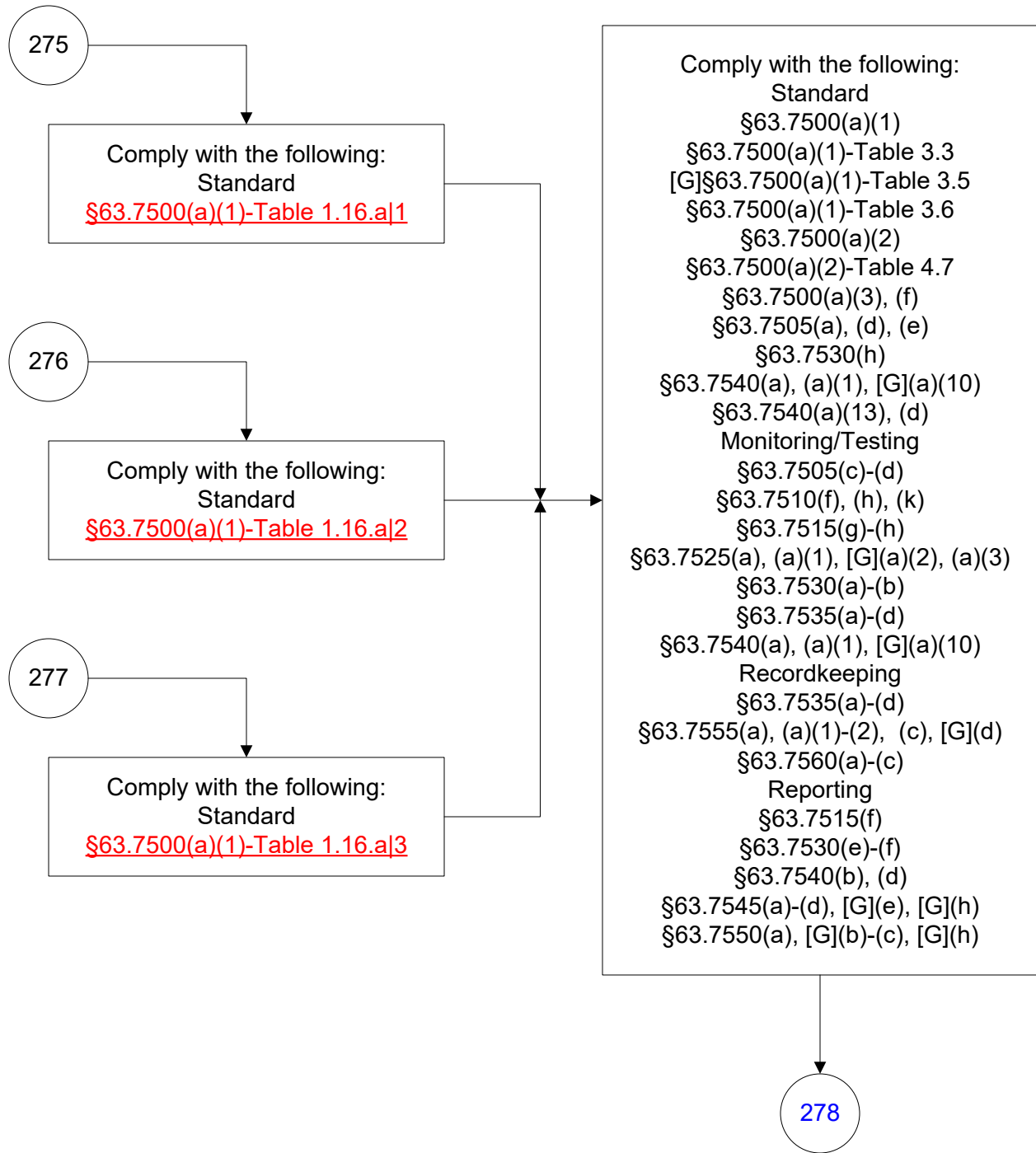

40 CFR Part 63, Subpart DDDDD (115 of 242)

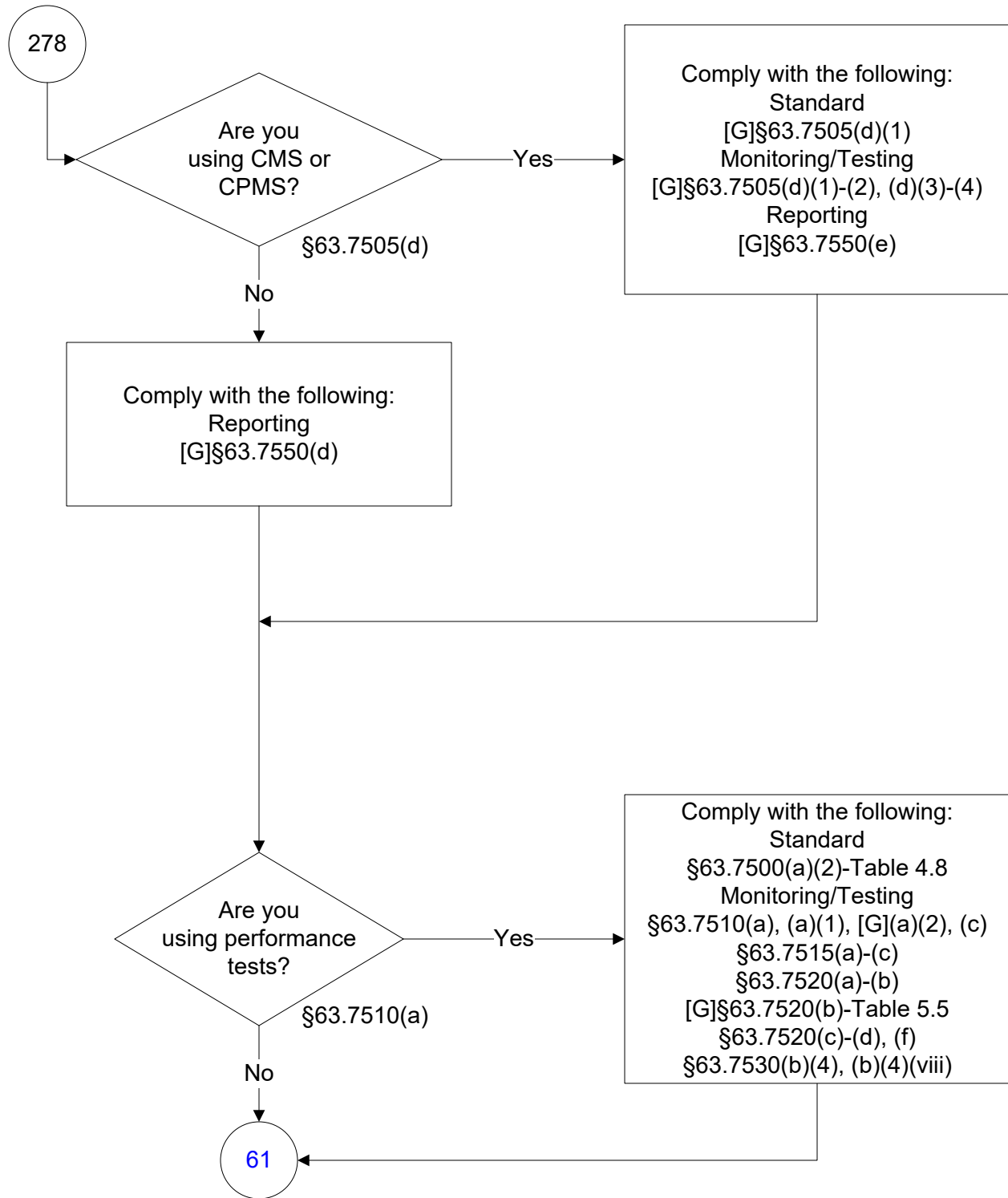

40 CFR Part 63, Subpart DDDDD (116 of 242)



40 CFR Part 63, Subpart DDDDD (117 of 242)

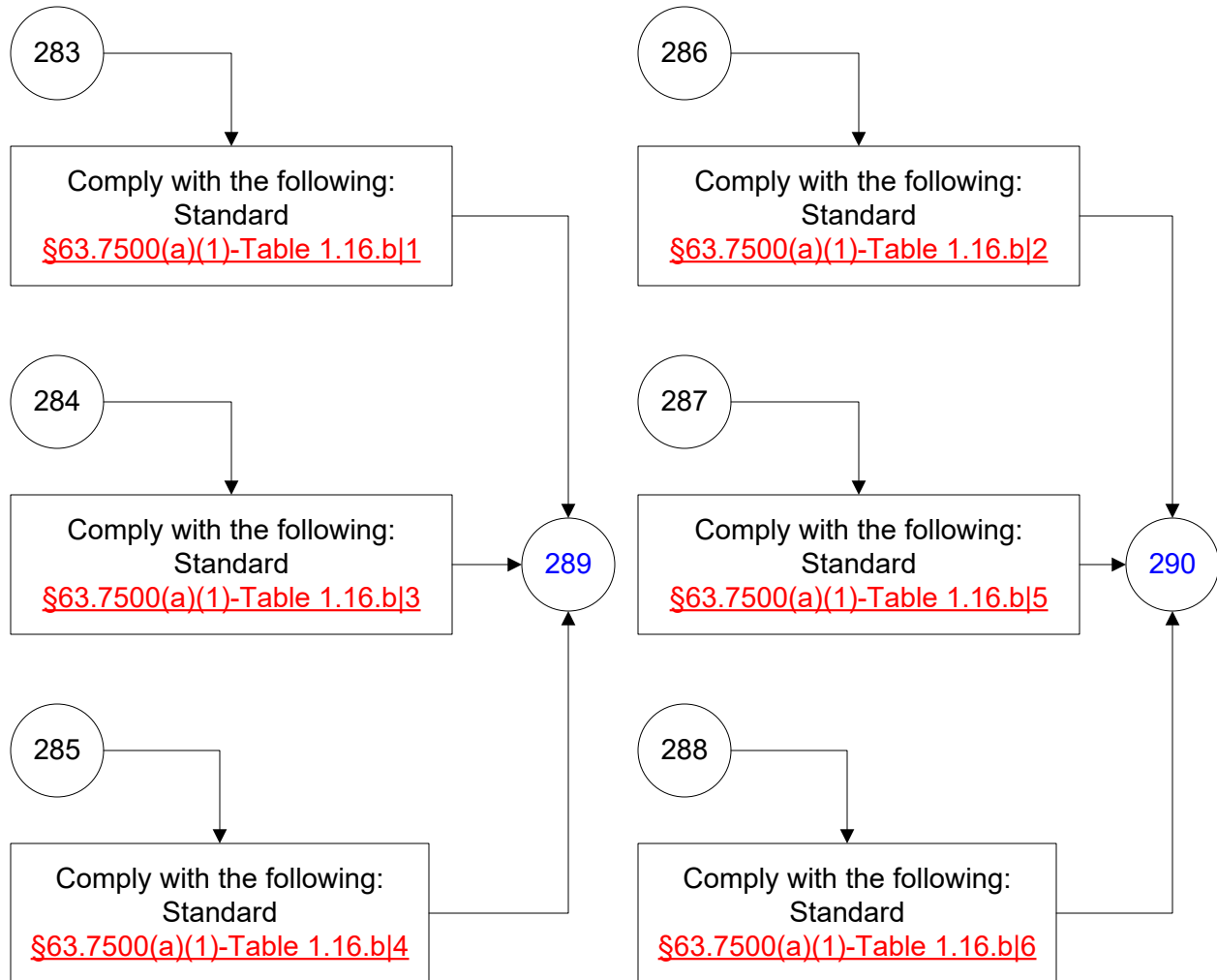

40 CFR Part 63, Subpart DDDDD
(118 of 242)

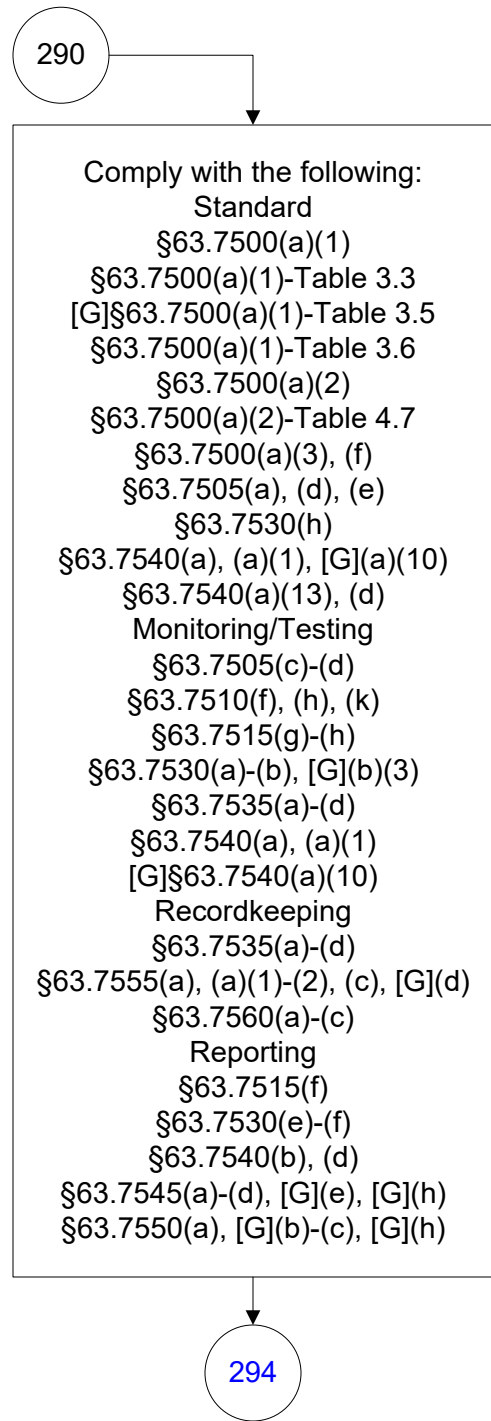
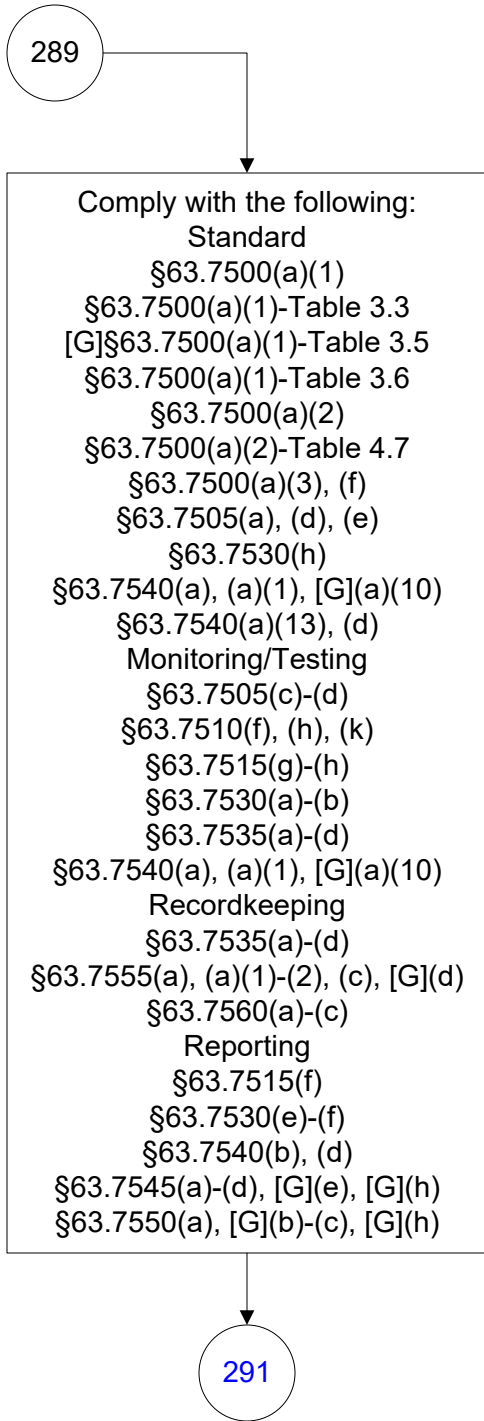

40 CFR Part 63, Subpart DDDDD (119 of 242)

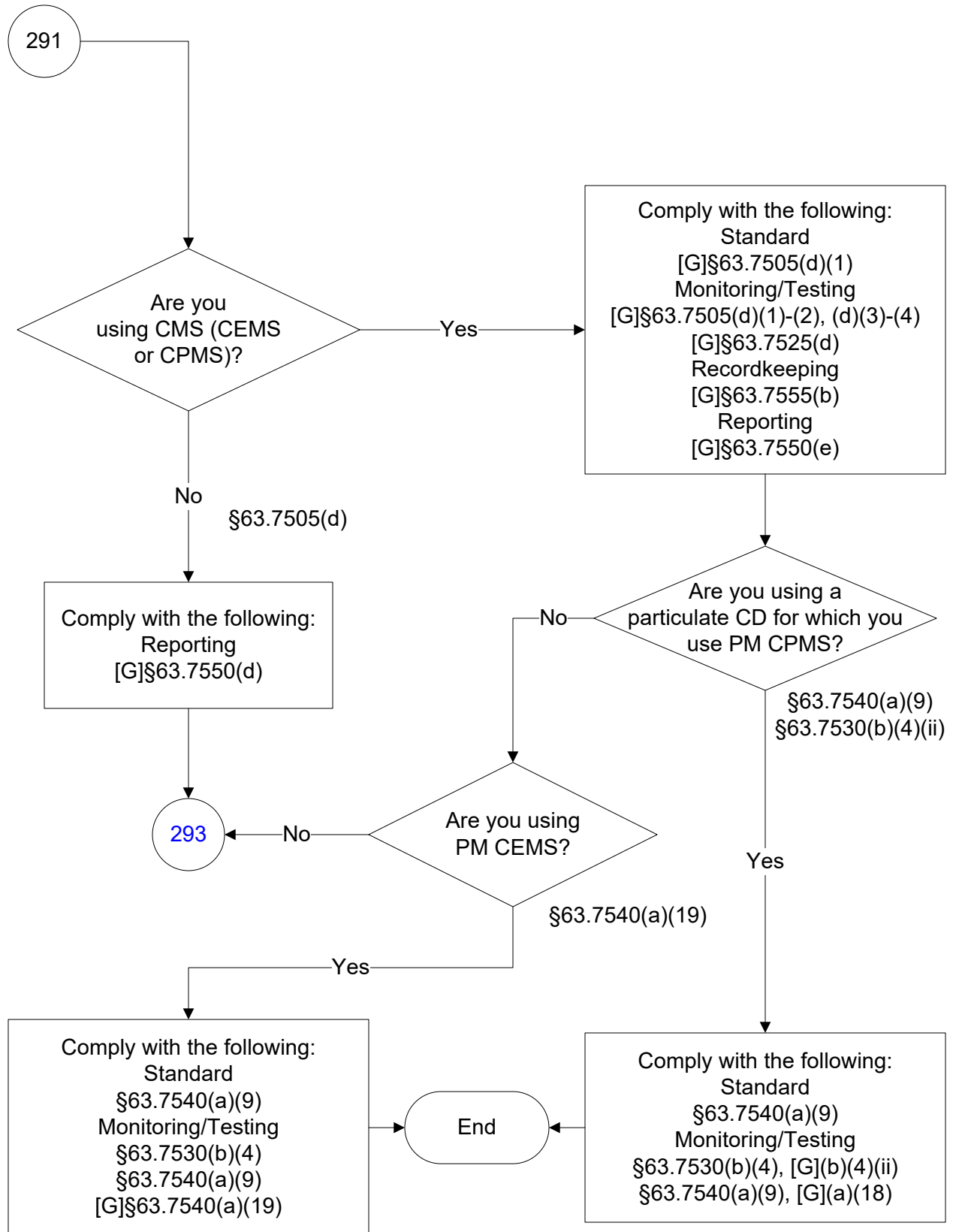

40 CFR Part 63, Subpart DDDDD (120 of 242)

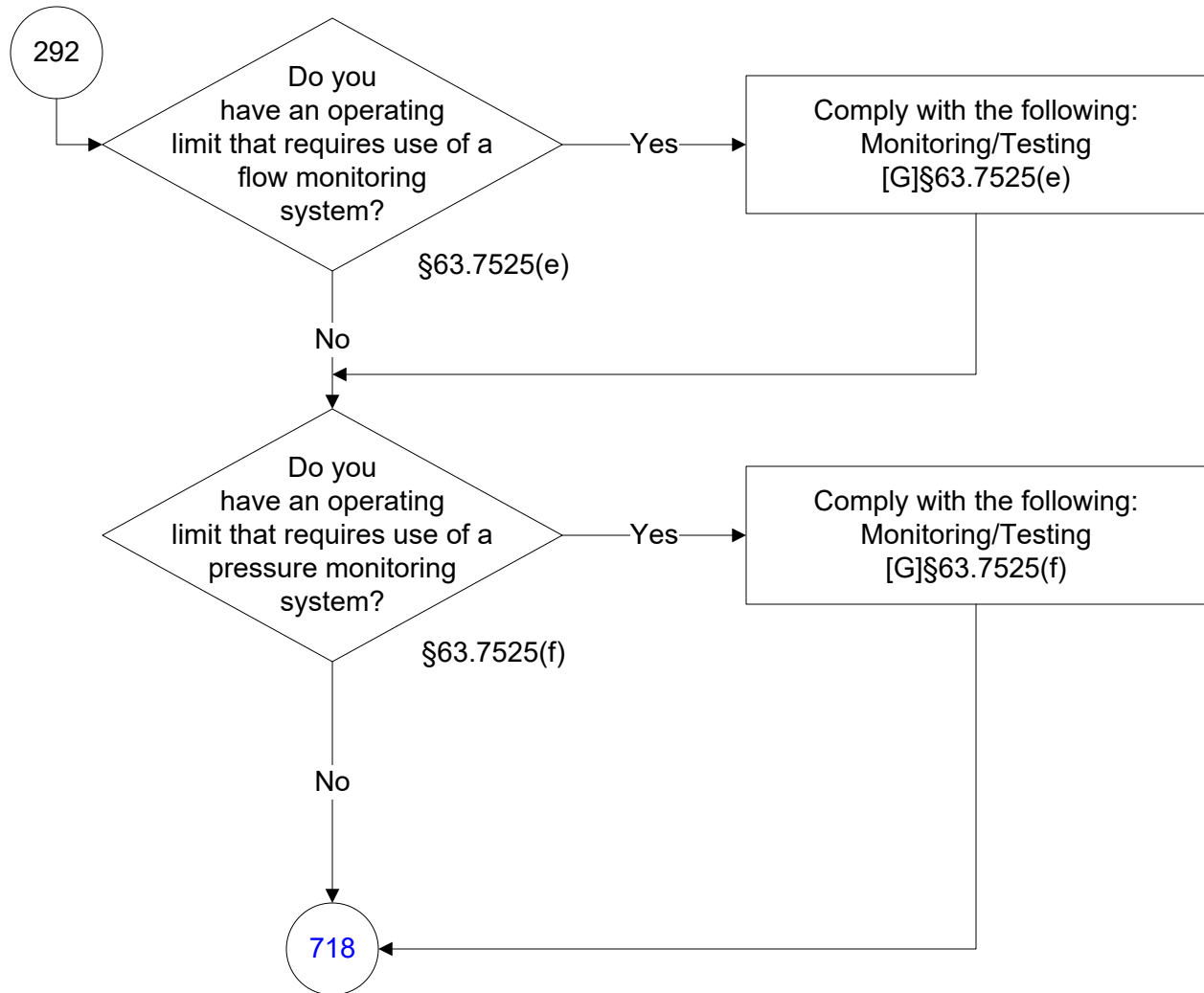

40 CFR Part 63, Subpart DDDDD (121 of 242)

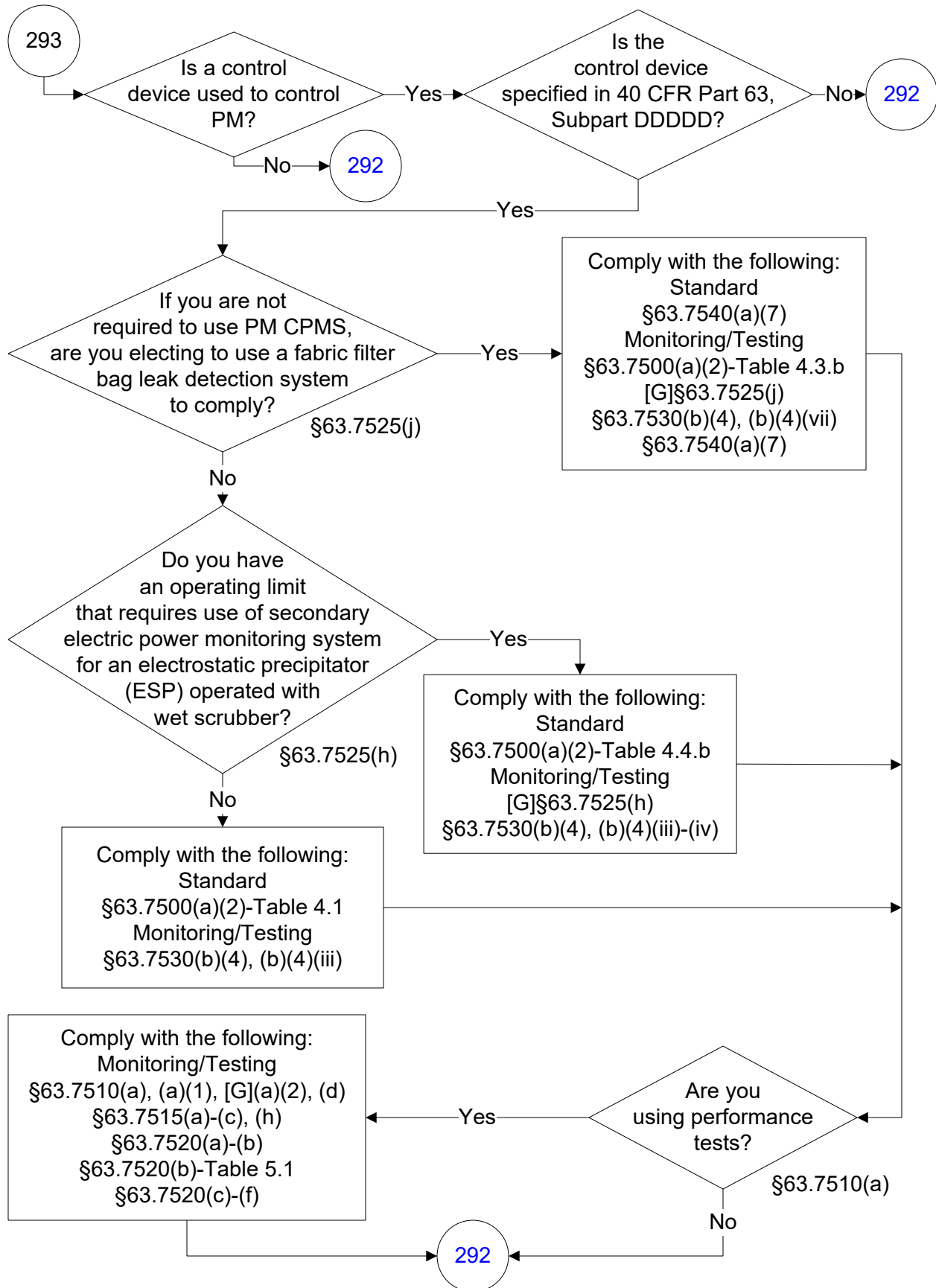

40 CFR Part 63, Subpart DDDDD (122 of 242)

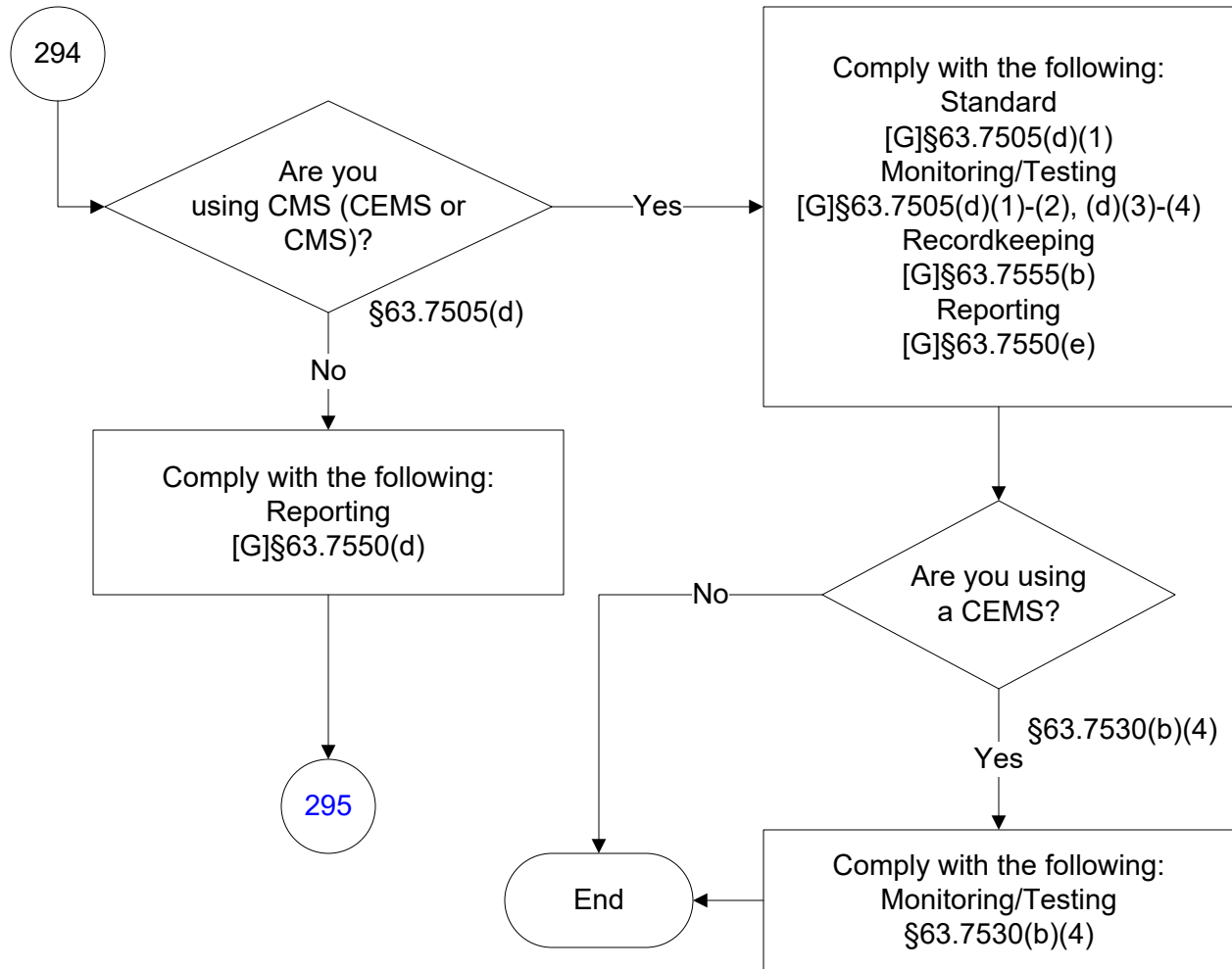

40 CFR Part 63, Subpart DDDDD (123 of 242)

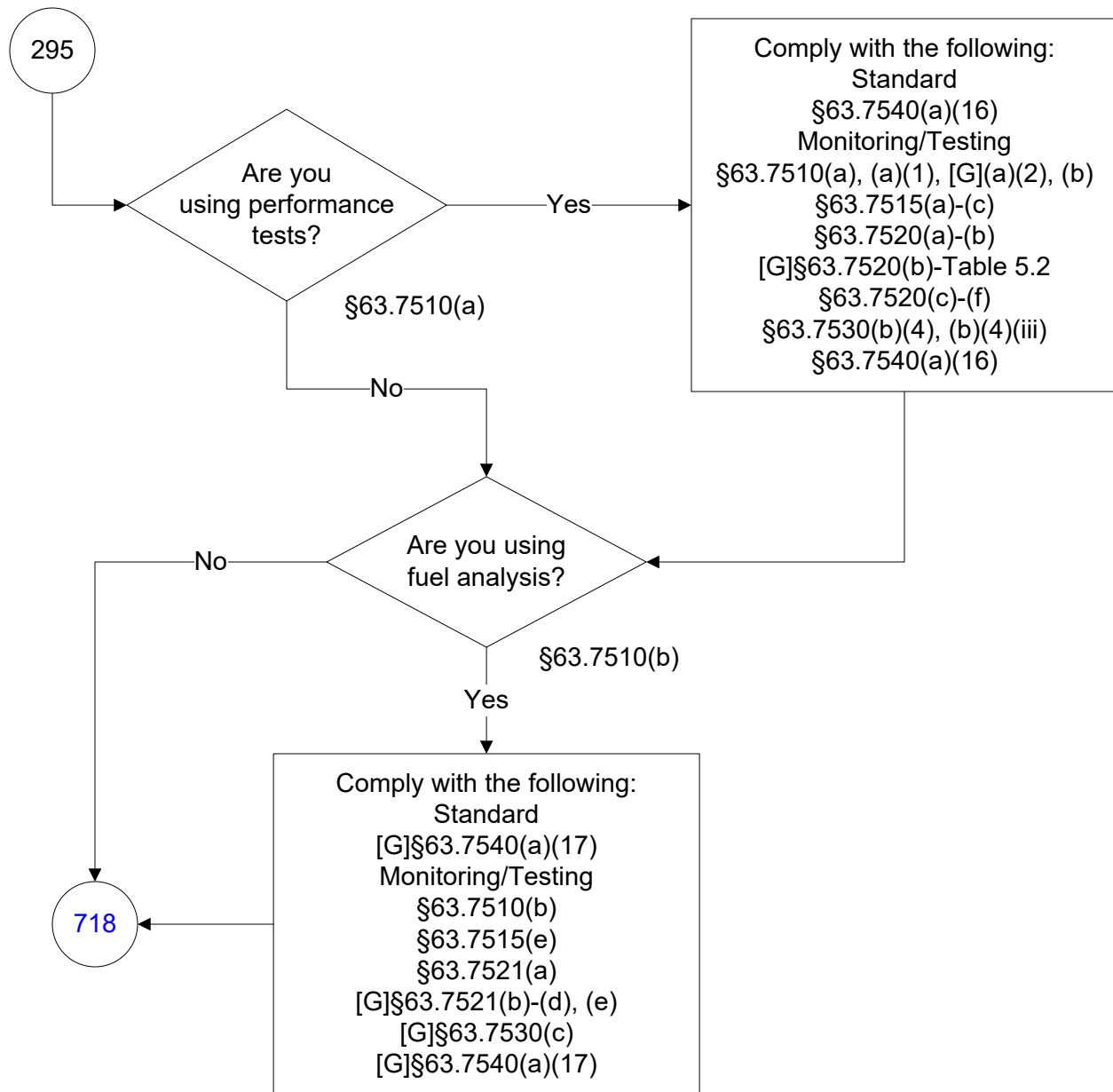

40 CFR Part 63, Subpart DDDDD (124 of 242)

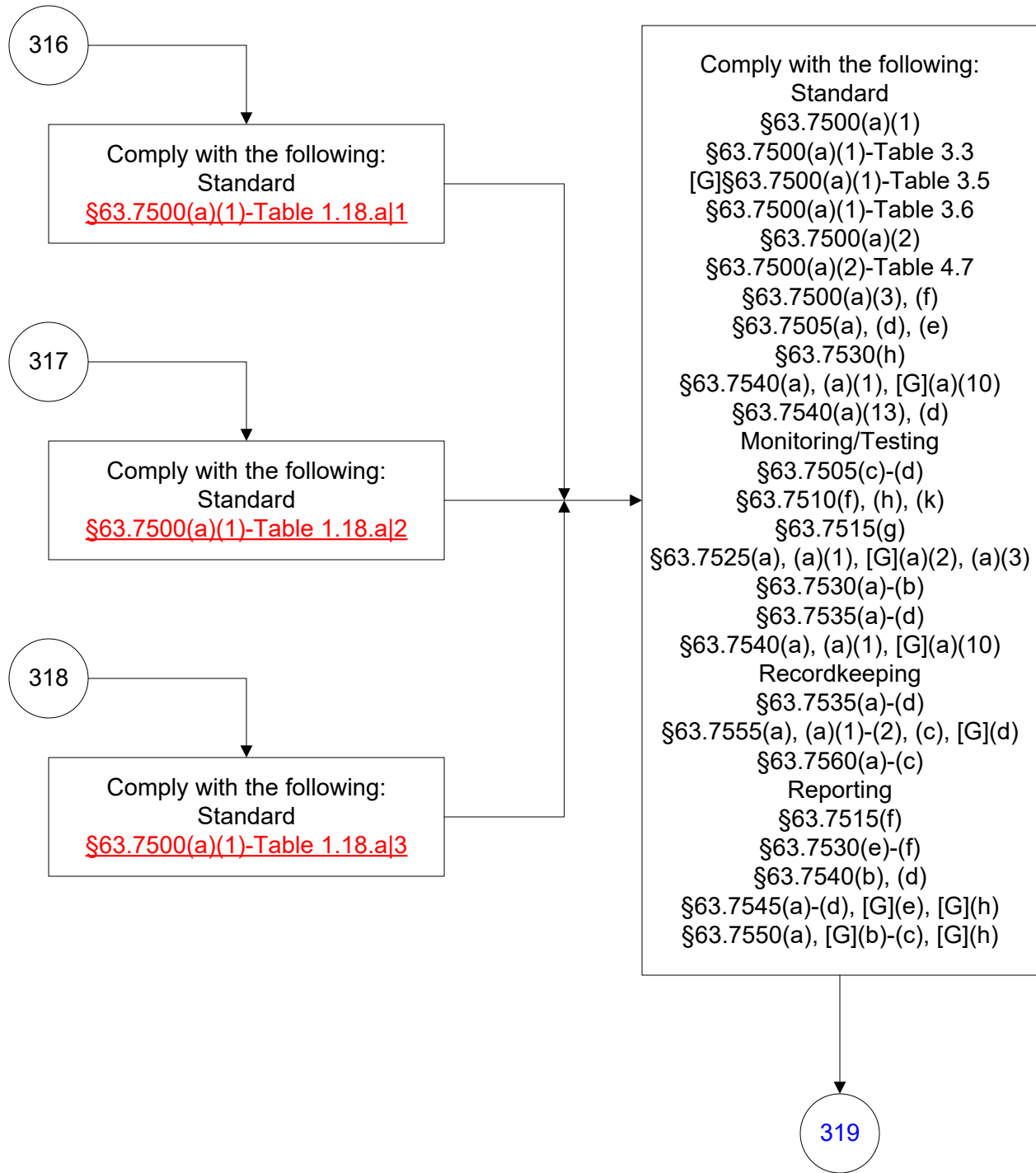

40 CFR Part 63, Subpart DDDDD (125 of 242)

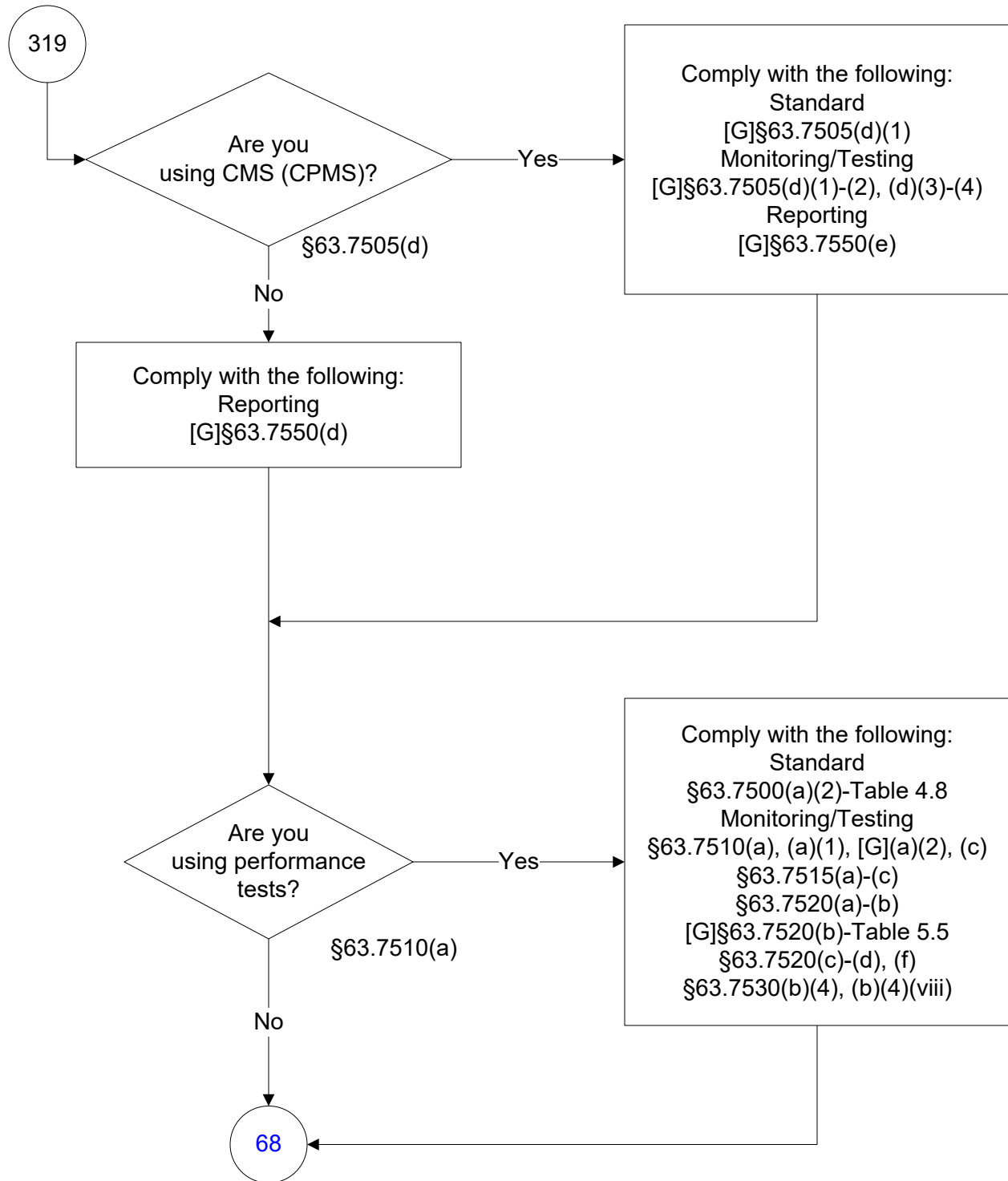

40 CFR Part 63, Subpart DDDDD (126 of 242)

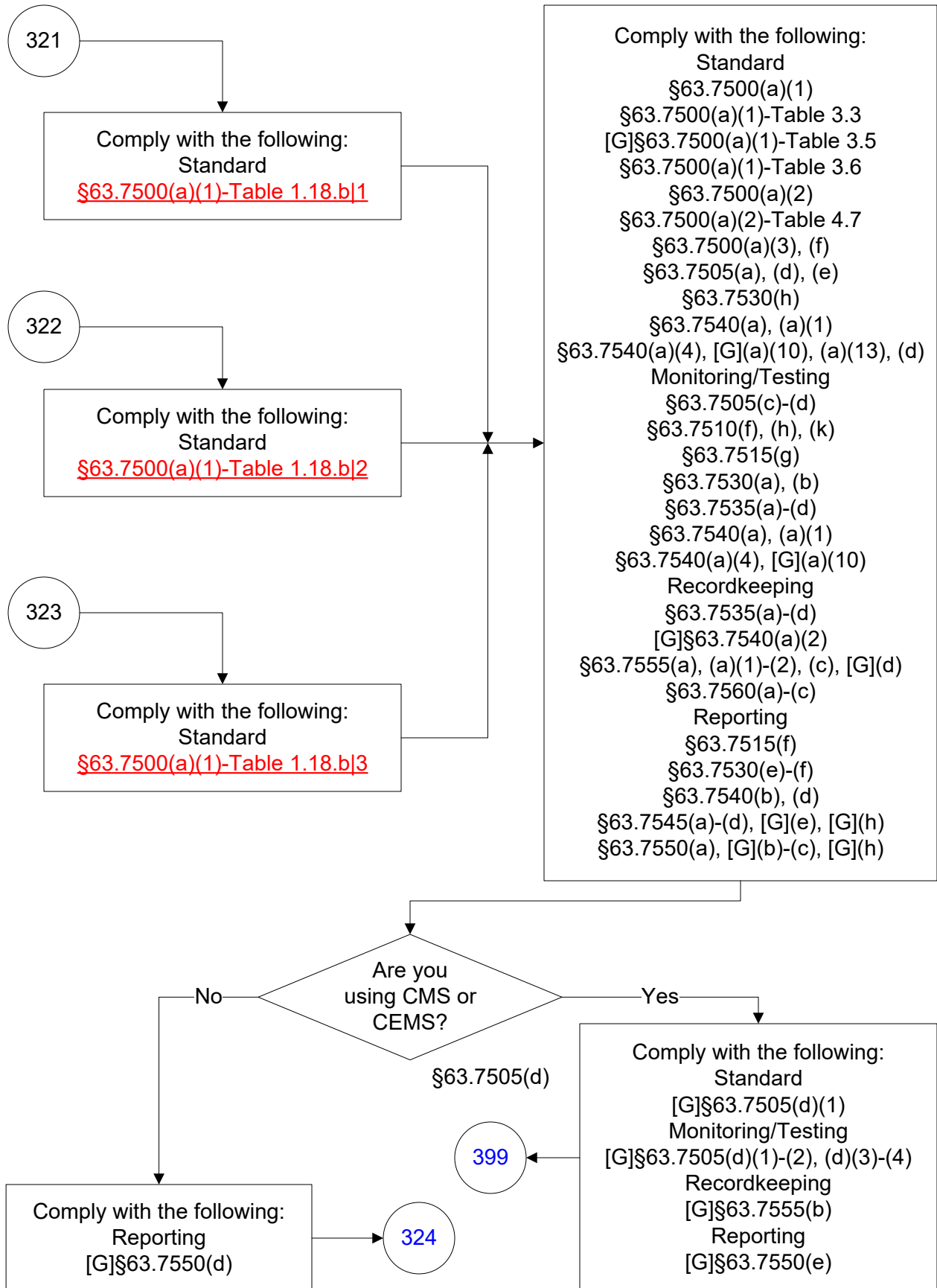

40 CFR Part 63, Subpart DDDDD (127 of 242)

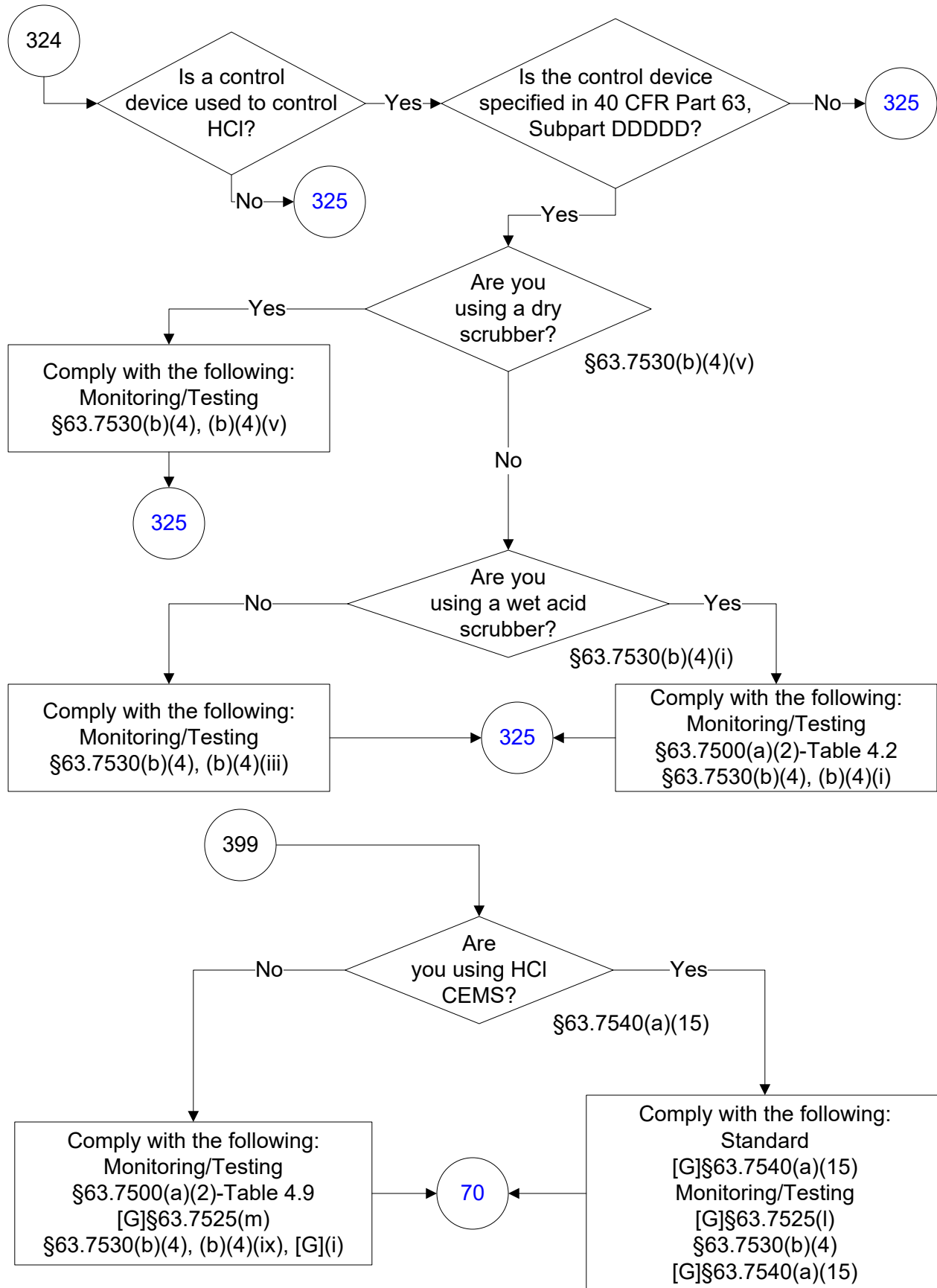

40 CFR Part 63, Subpart DDDDD (128 of 242)

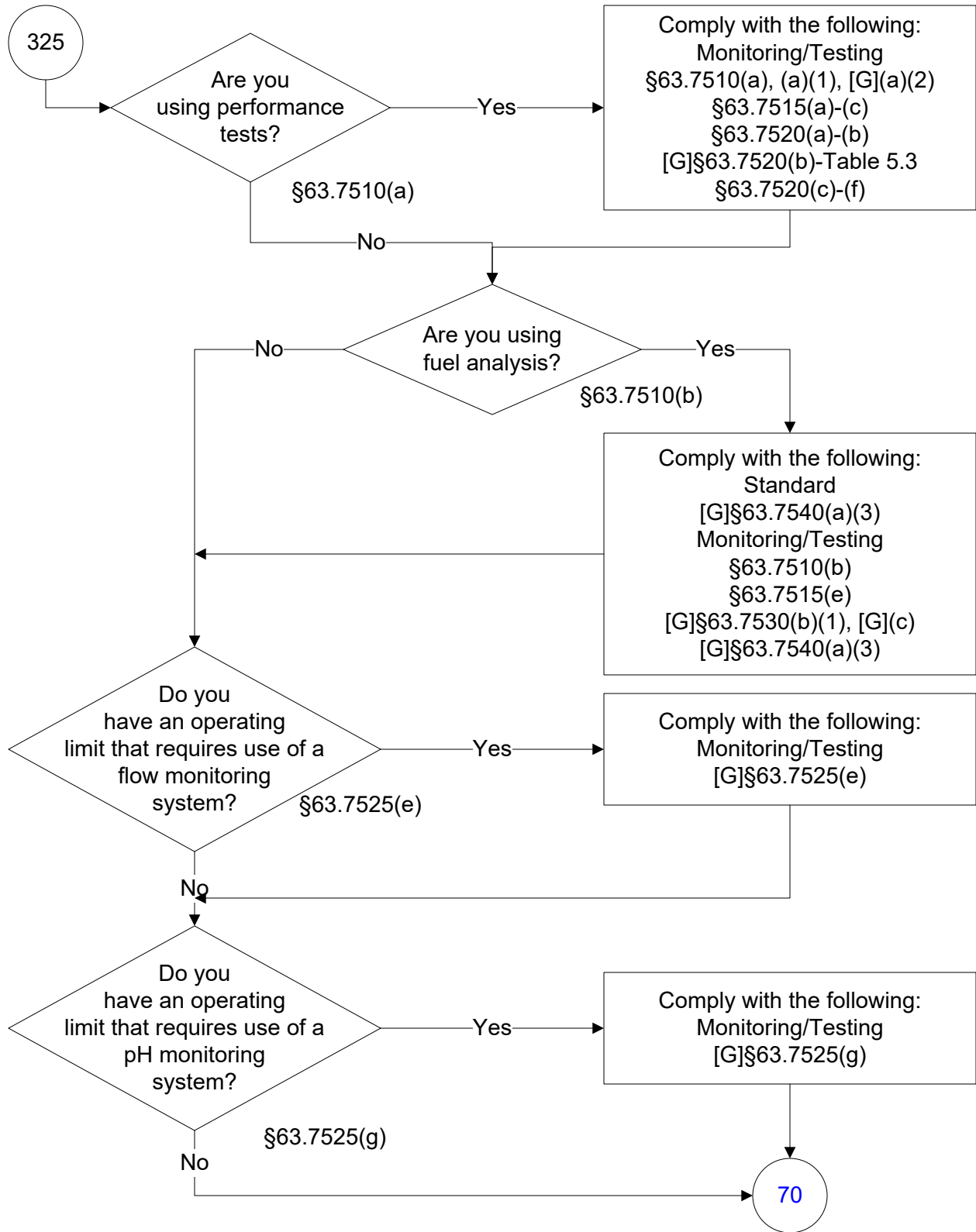

40 CFR Part 63, Subpart DDDDD (129 of 242)

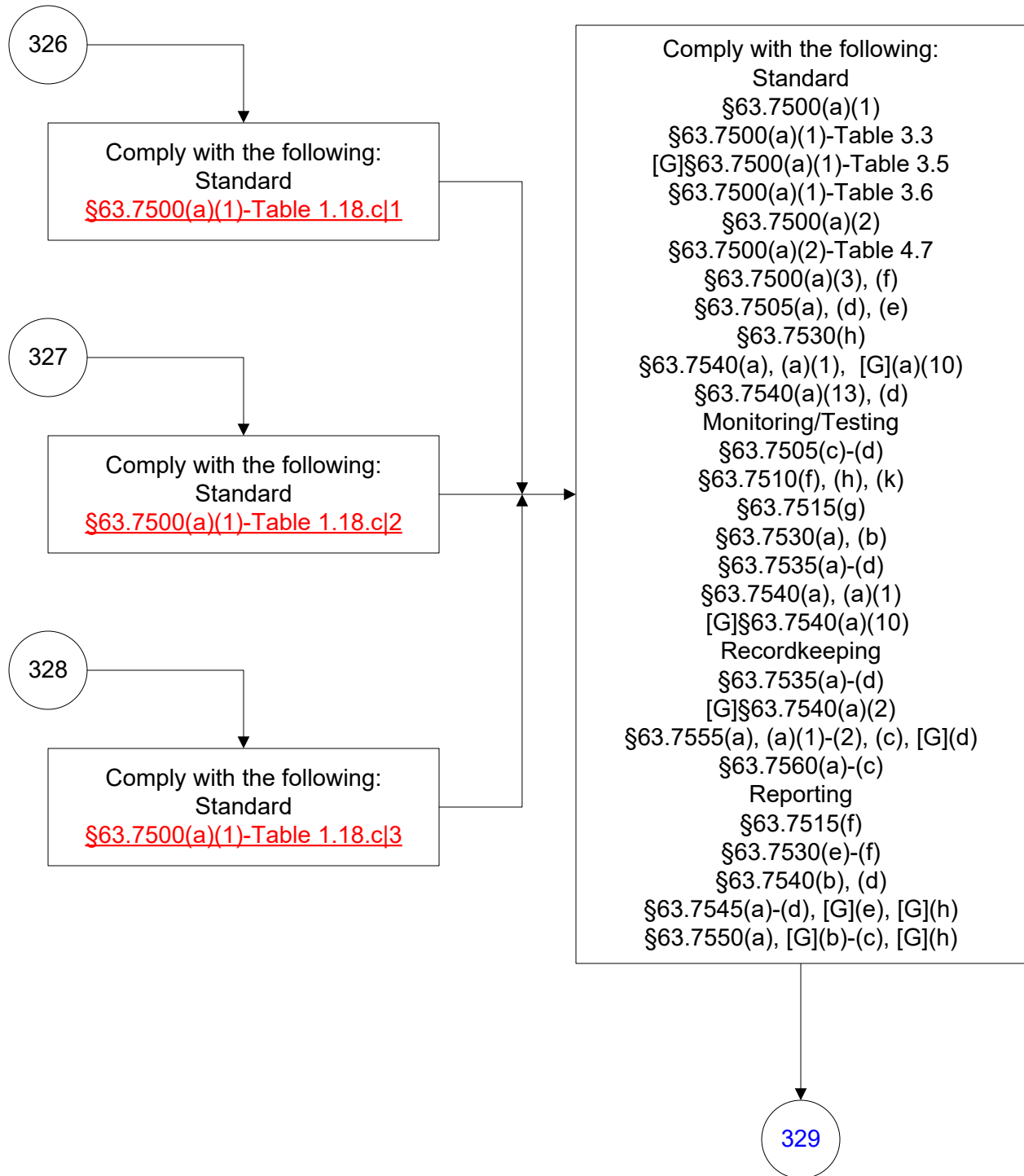

40 CFR Part 63, Subpart DDDDD (130 of 242)

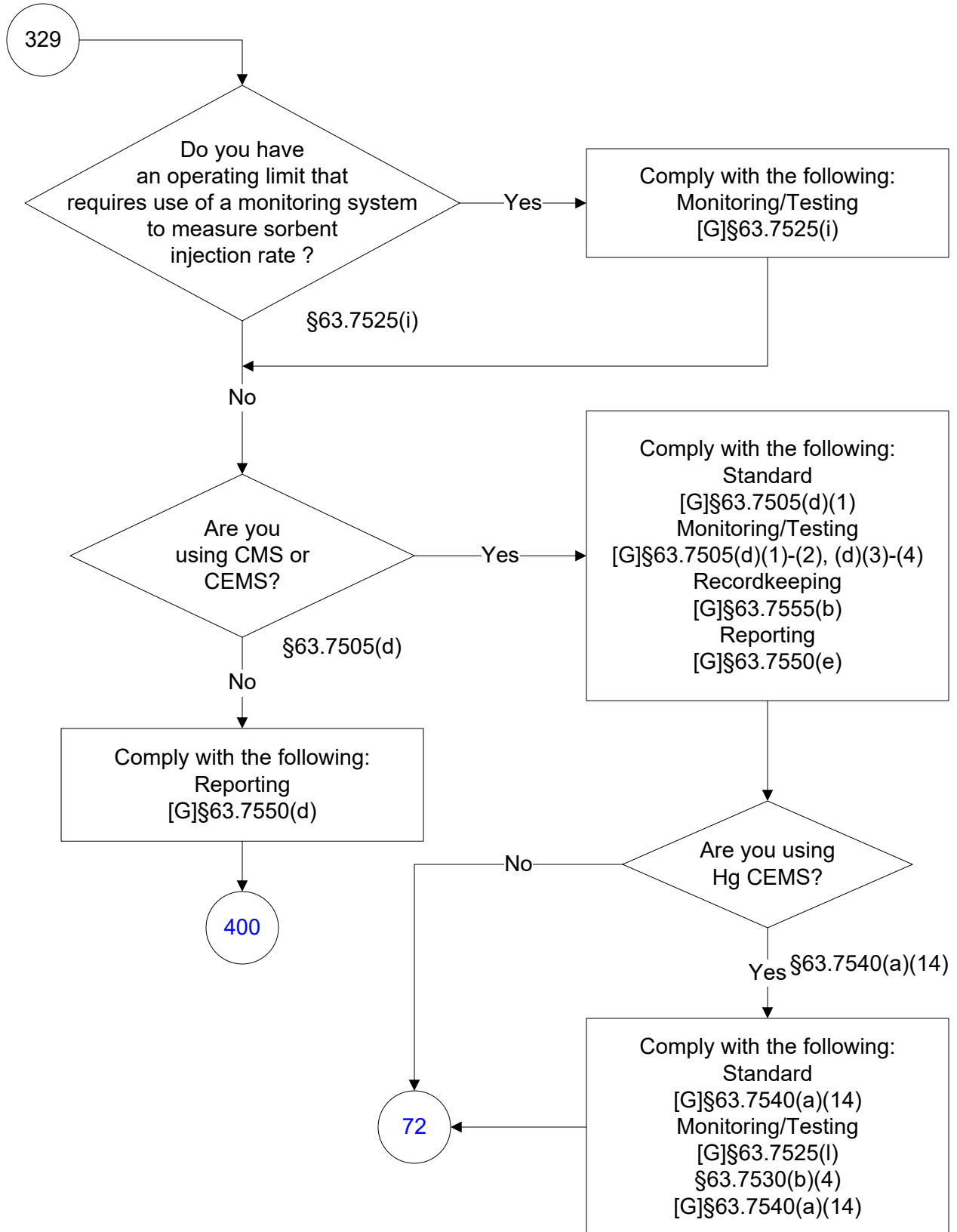

40 CFR Part 63, Subpart DDDDD (131 of 242)

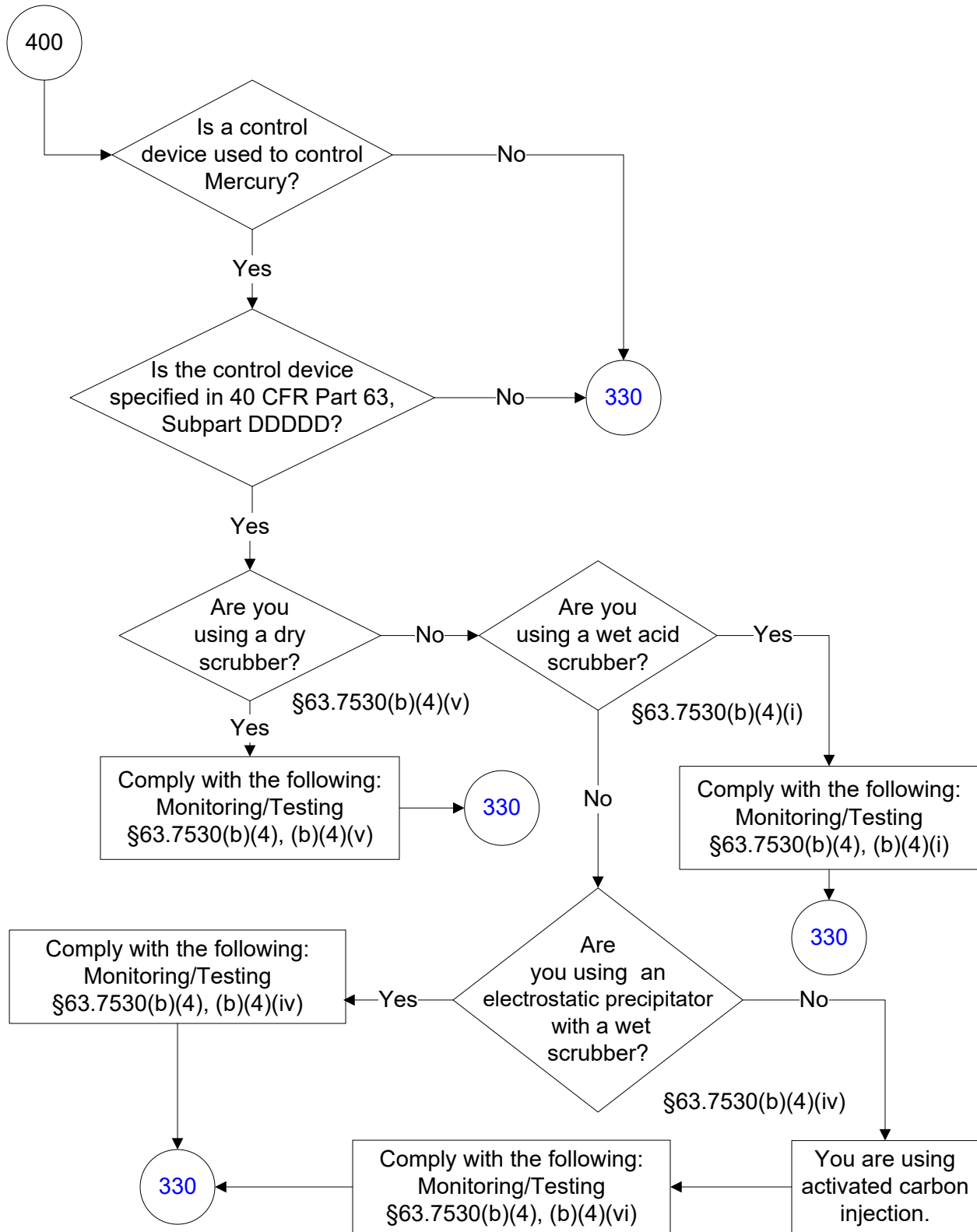

40 CFR Part 63, Subpart DDDDD (132 of 242)

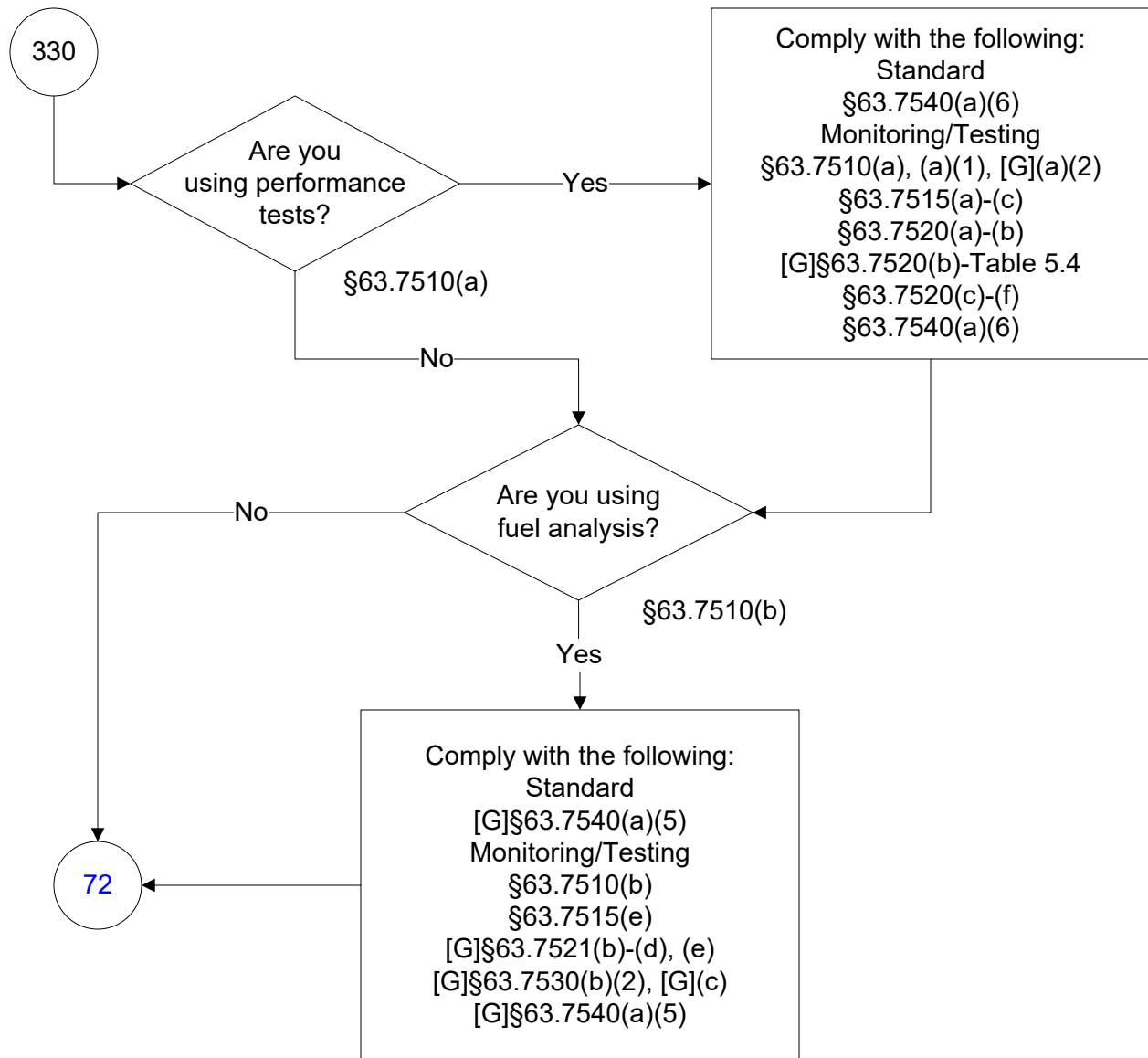

40 CFR Part 63, Subpart DDDDD (133 of 242)



40 CFR Part 63, Subpart DDDDD (134 of 242)

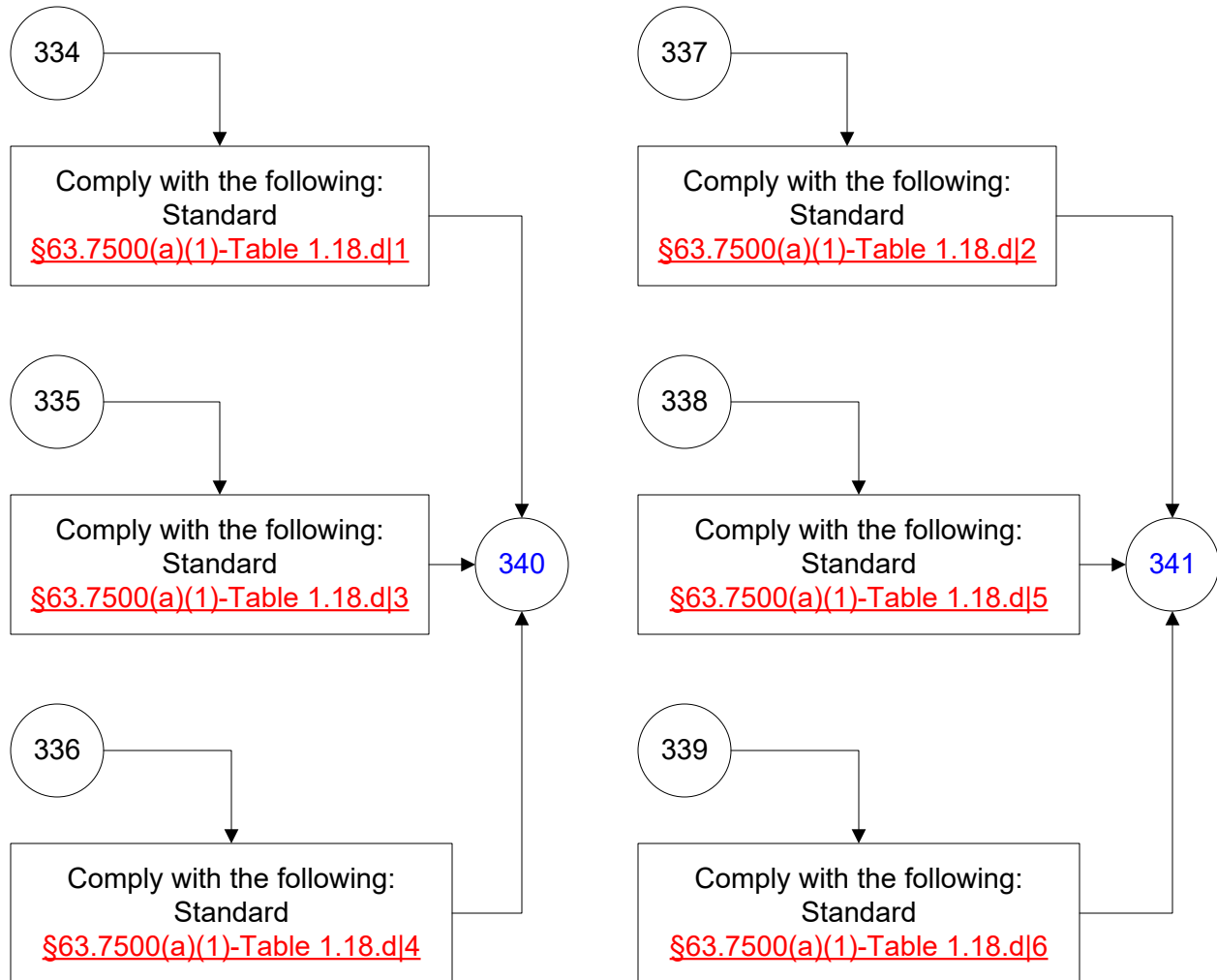

40 CFR Part 63, Subpart DDDDD
(135 of 242)

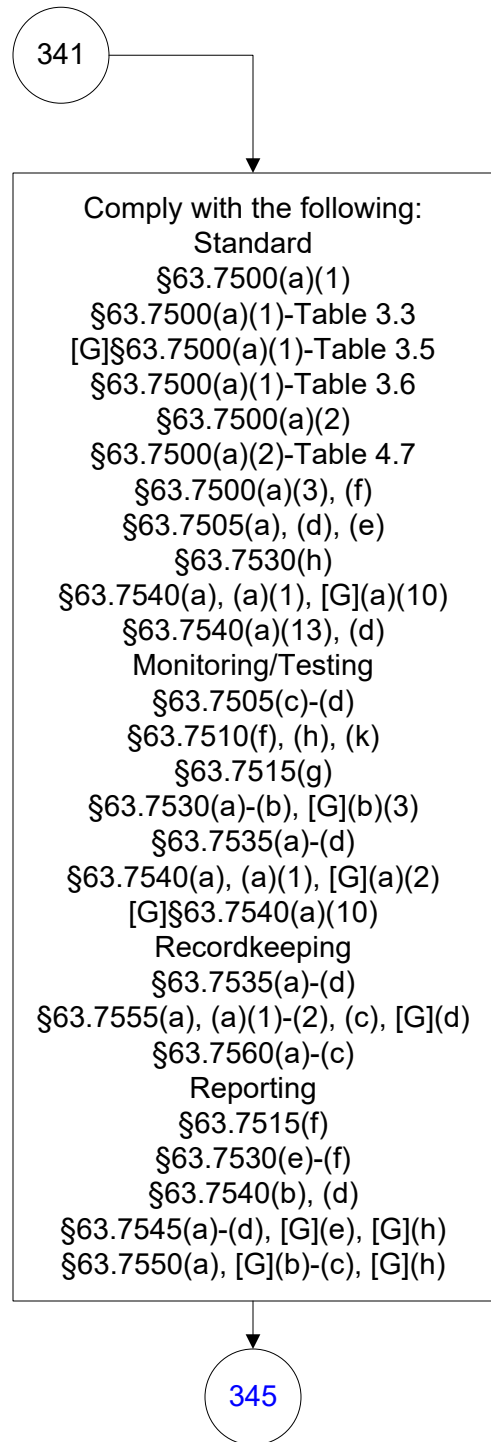
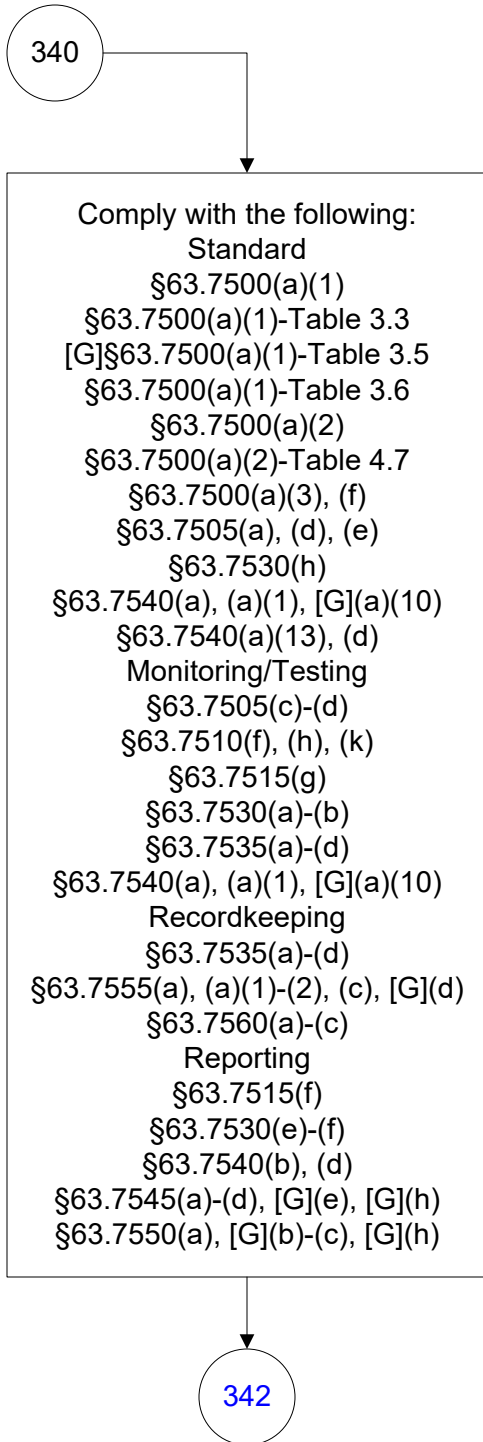

40 CFR Part 63, Subpart DDDDD (136 of 242)

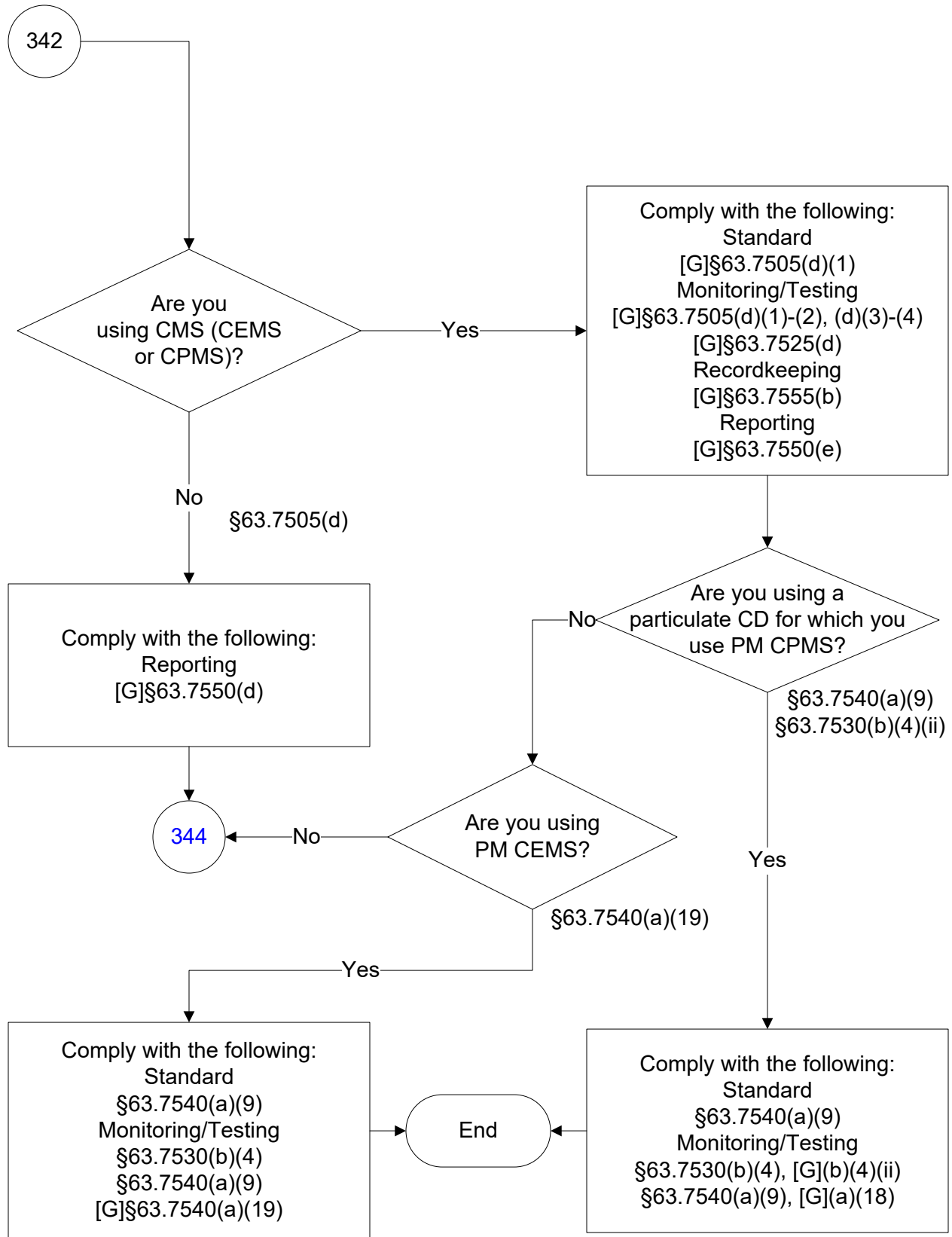

40 CFR Part 63, Subpart DDDDD (137 of 242)

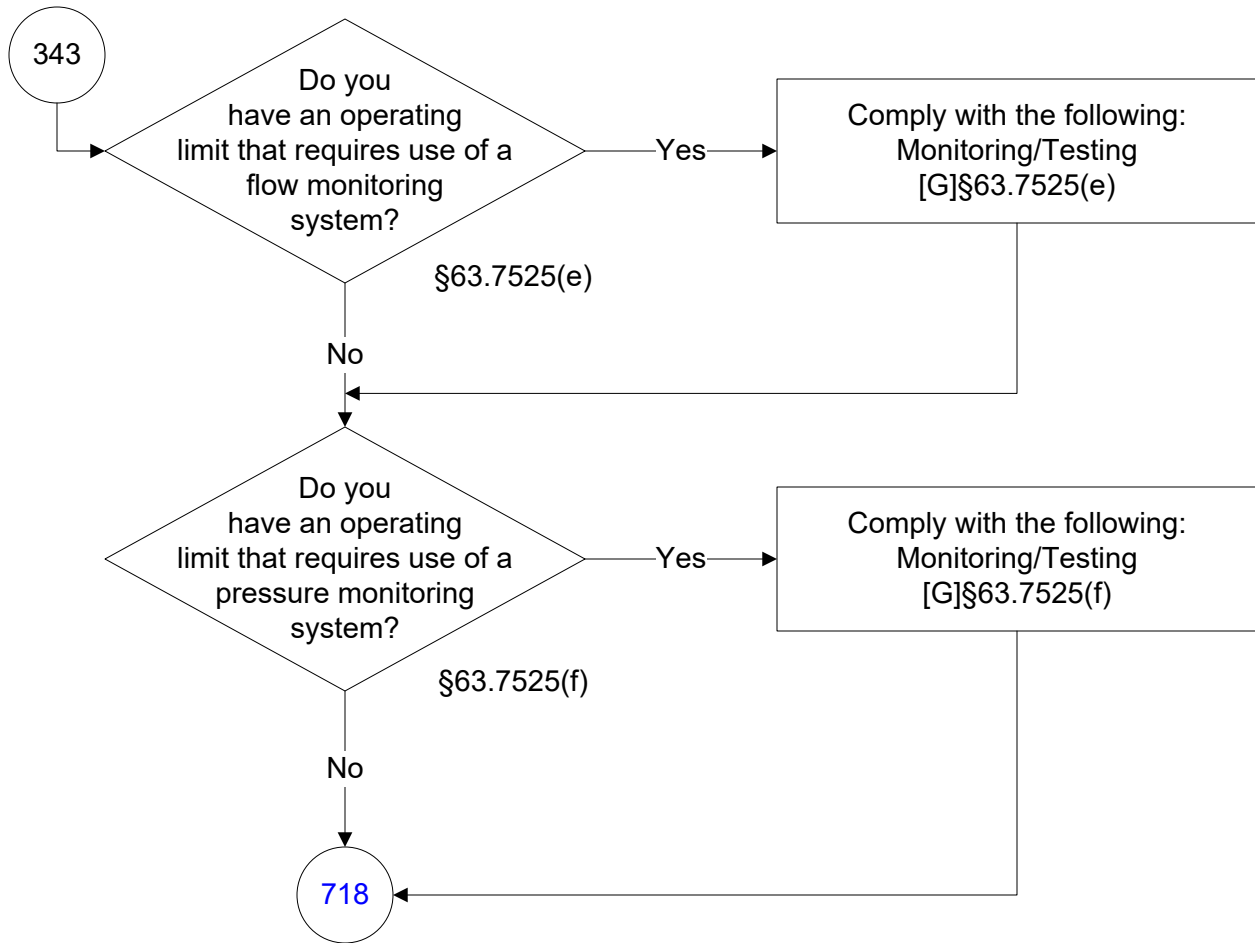

40 CFR Part 63, Subpart DDDDD (138 of 242)

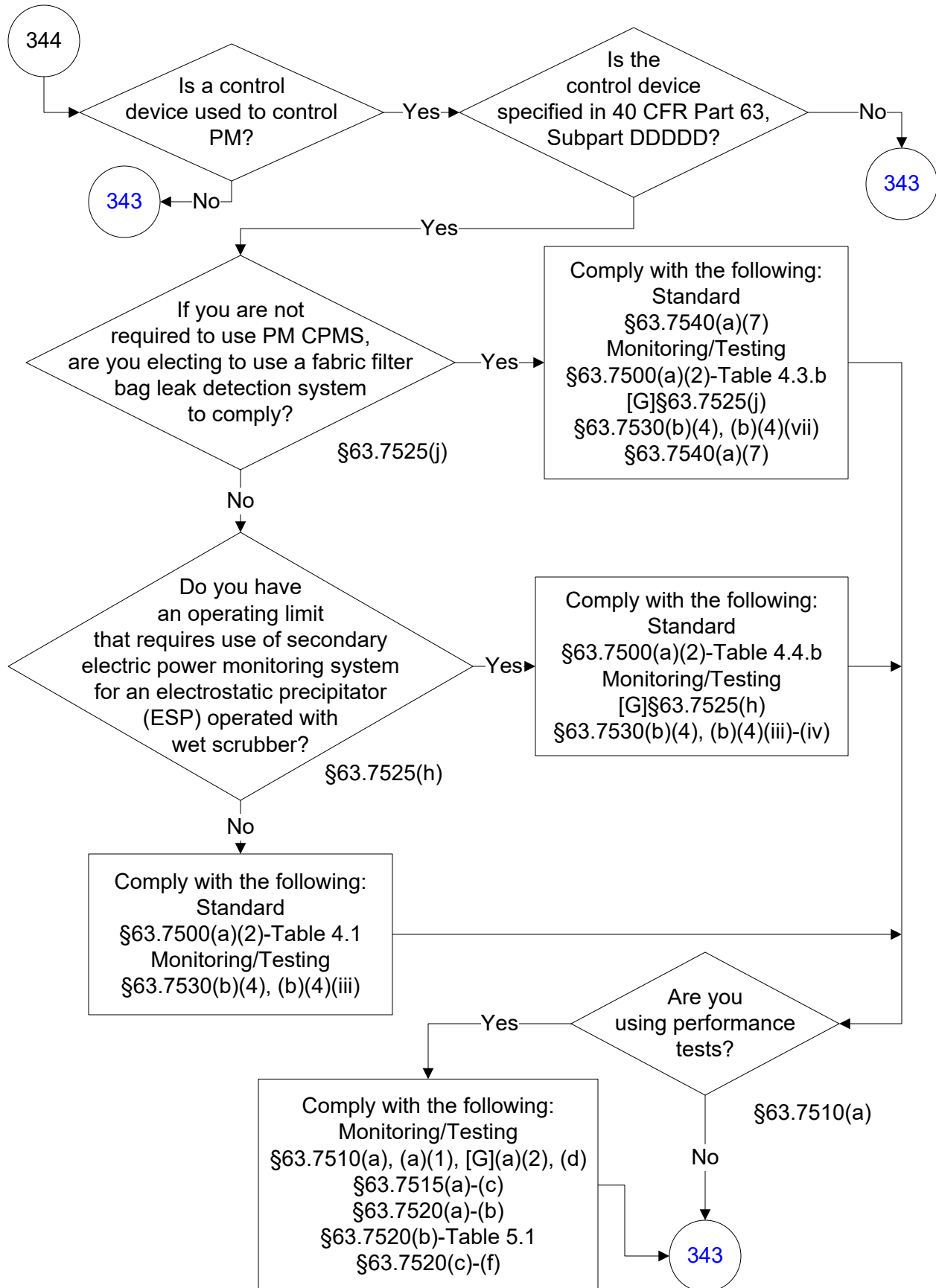

40 CFR Part 63, Subpart DDDDD (139 of 242)

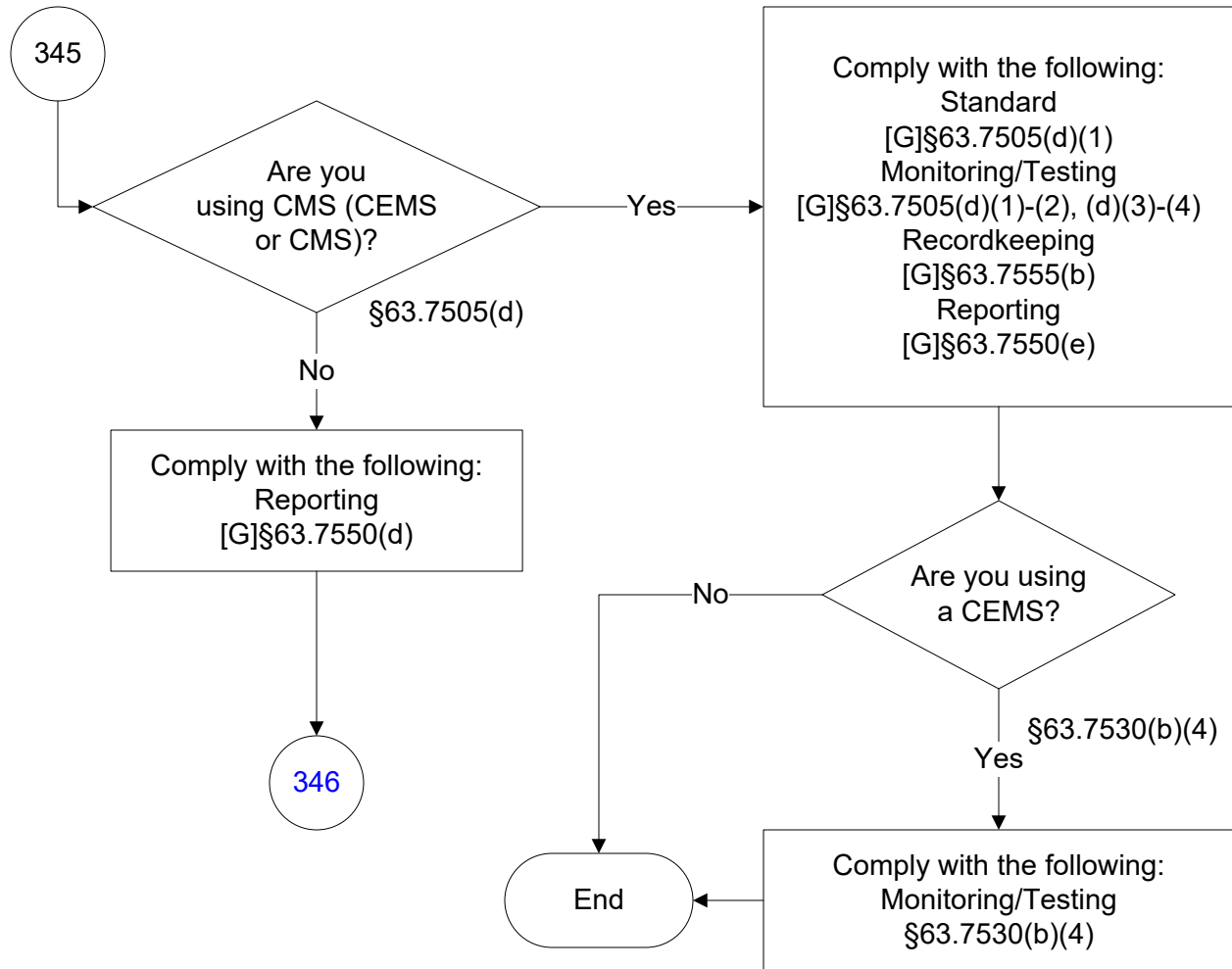

40 CFR Part 63, Subpart DDDDD (140 of 242)

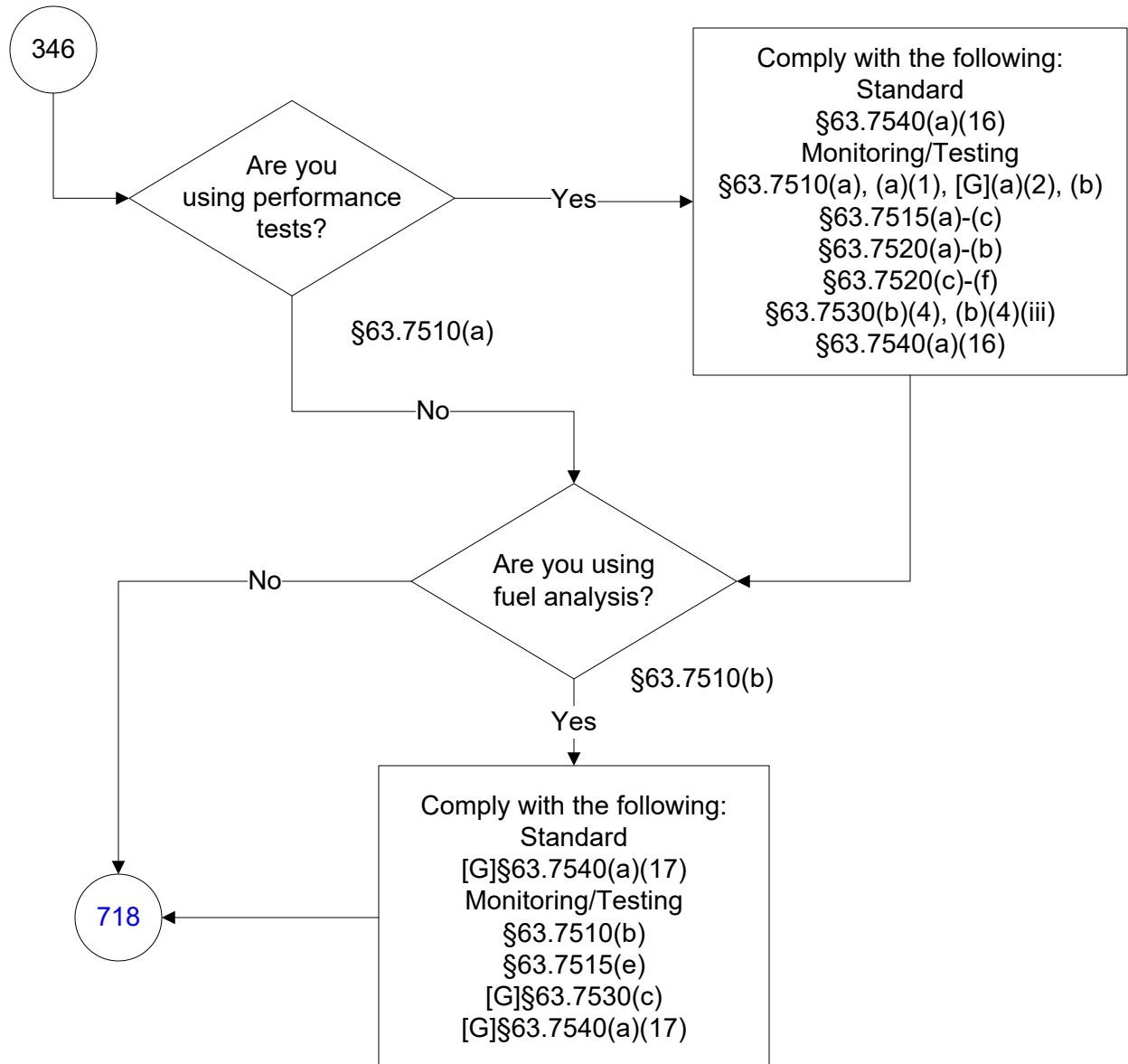

40 CFR Part 63, Subpart DDDDD (141 of 242)

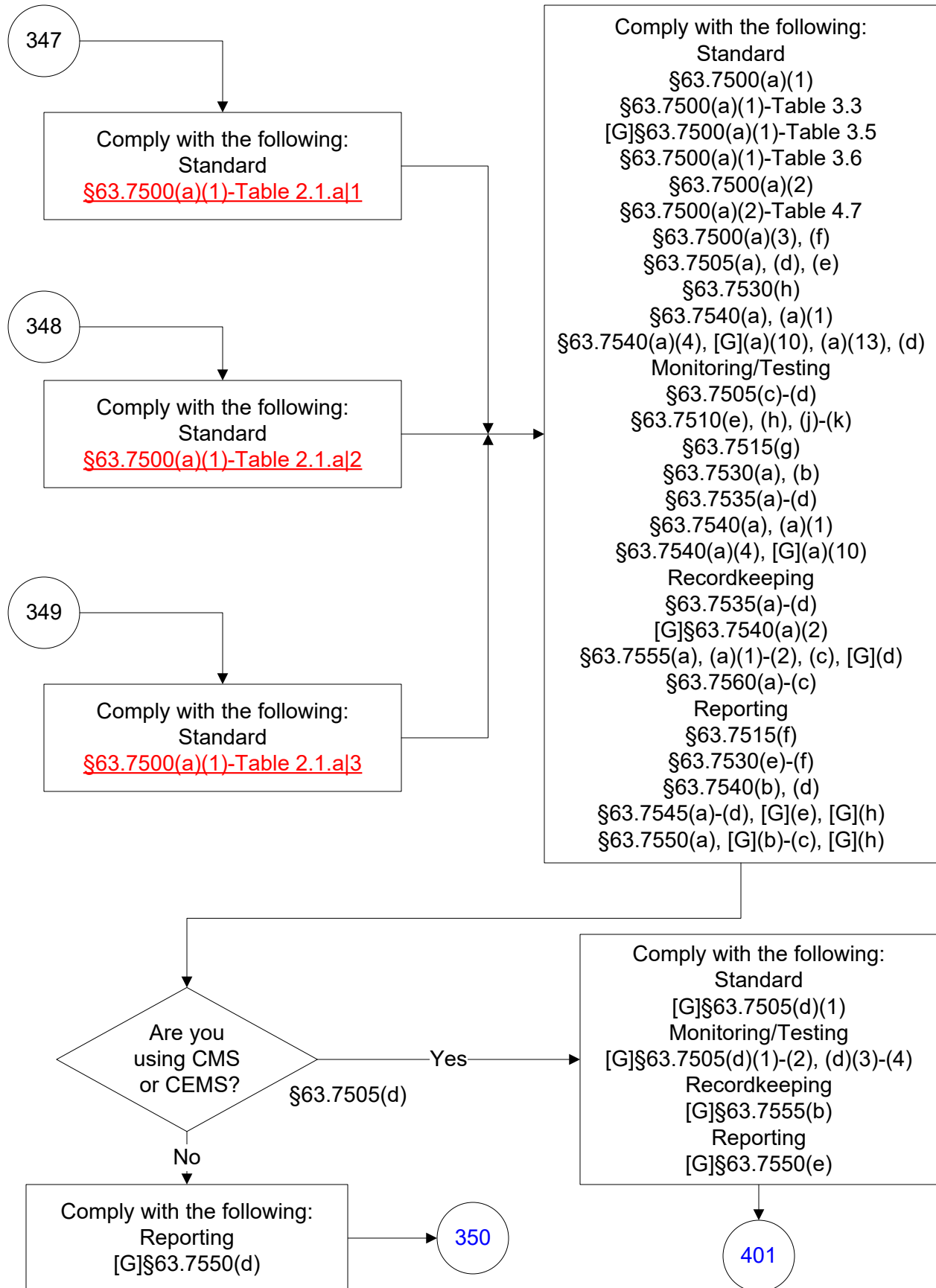

40 CFR Part 63, Subpart DDDDD (142 of 242)

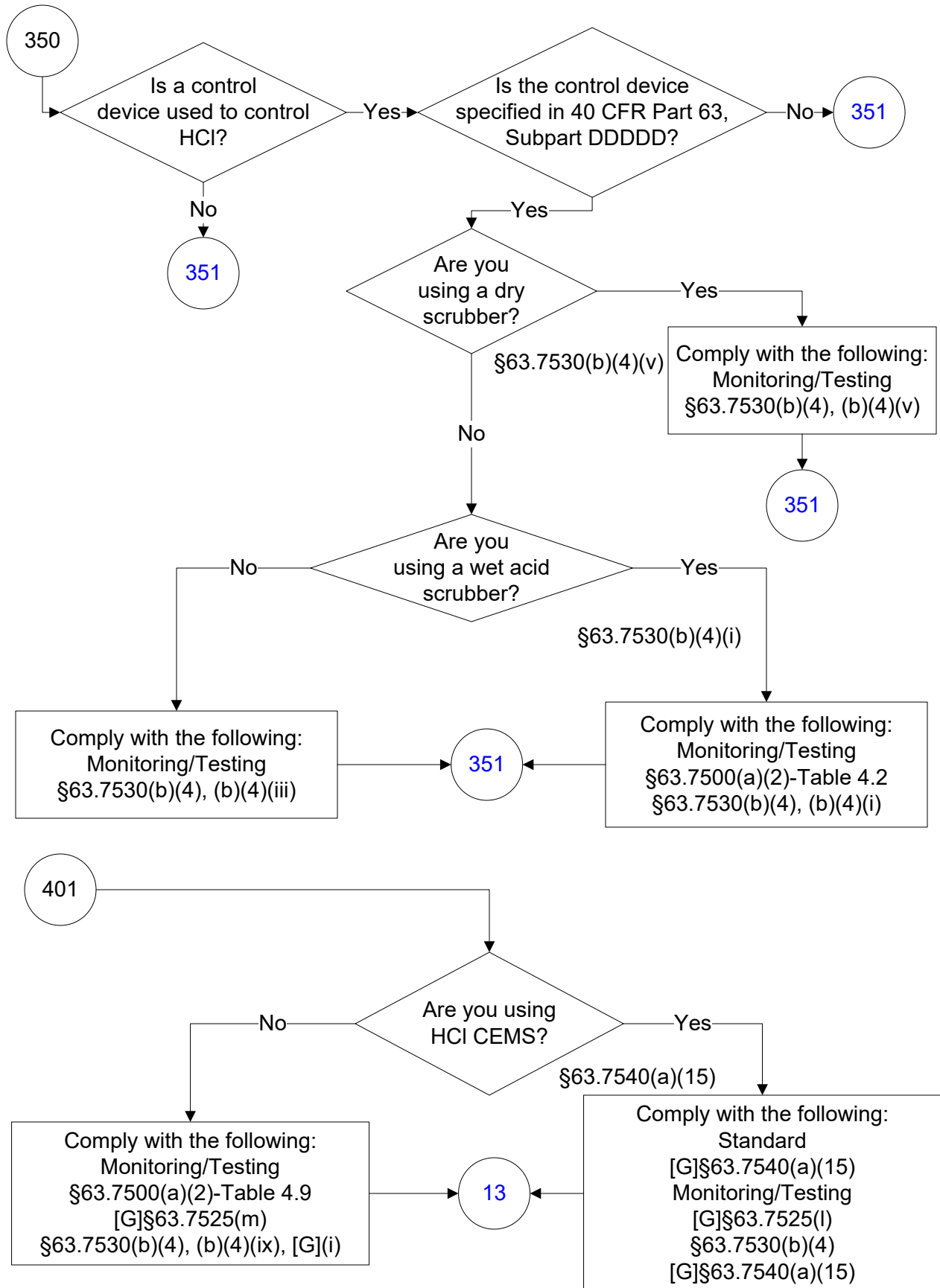

40 CFR Part 63, Subpart DDDDD (143 of 242)

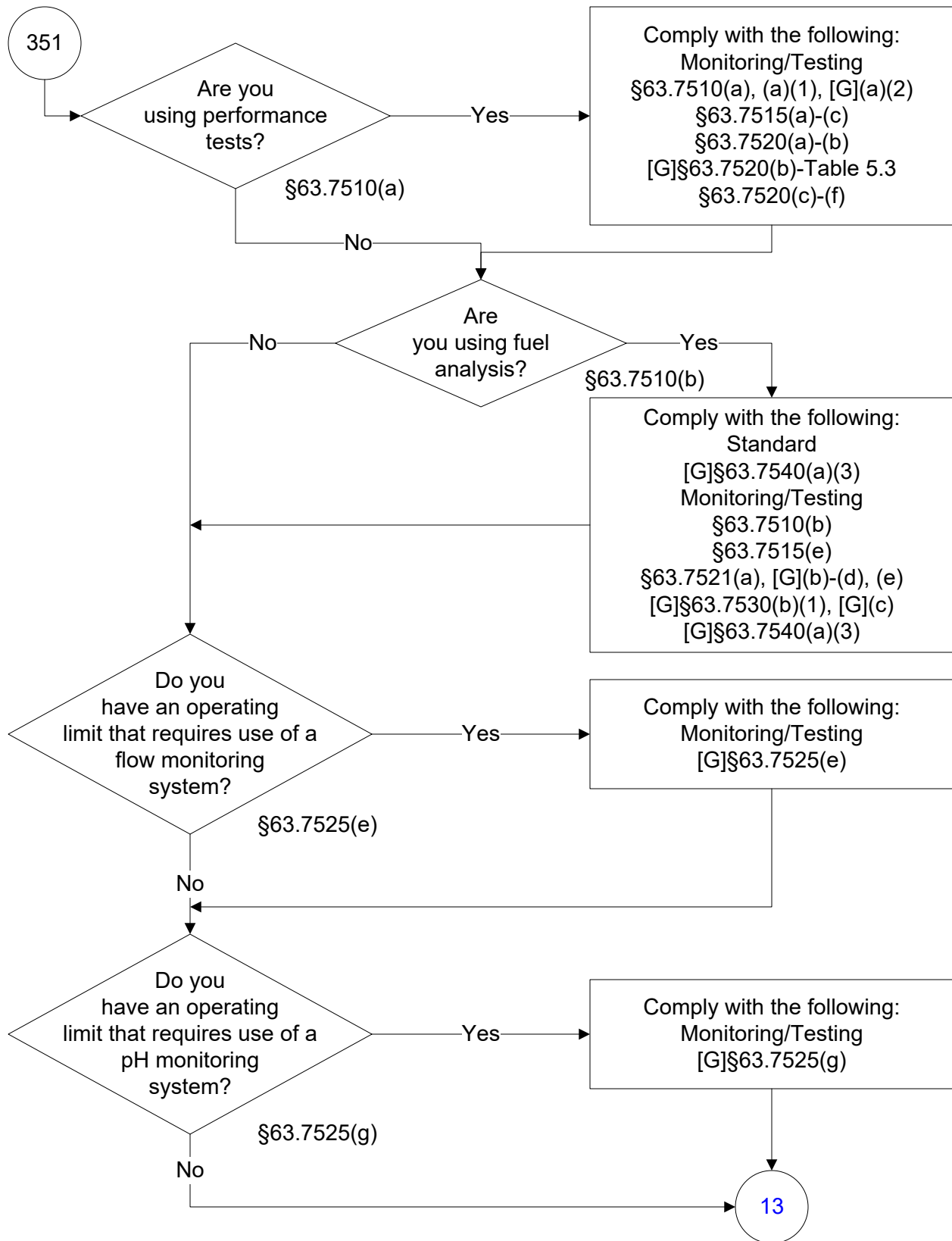

40 CFR Part 63, Subpart DDDDD (144 of 242)

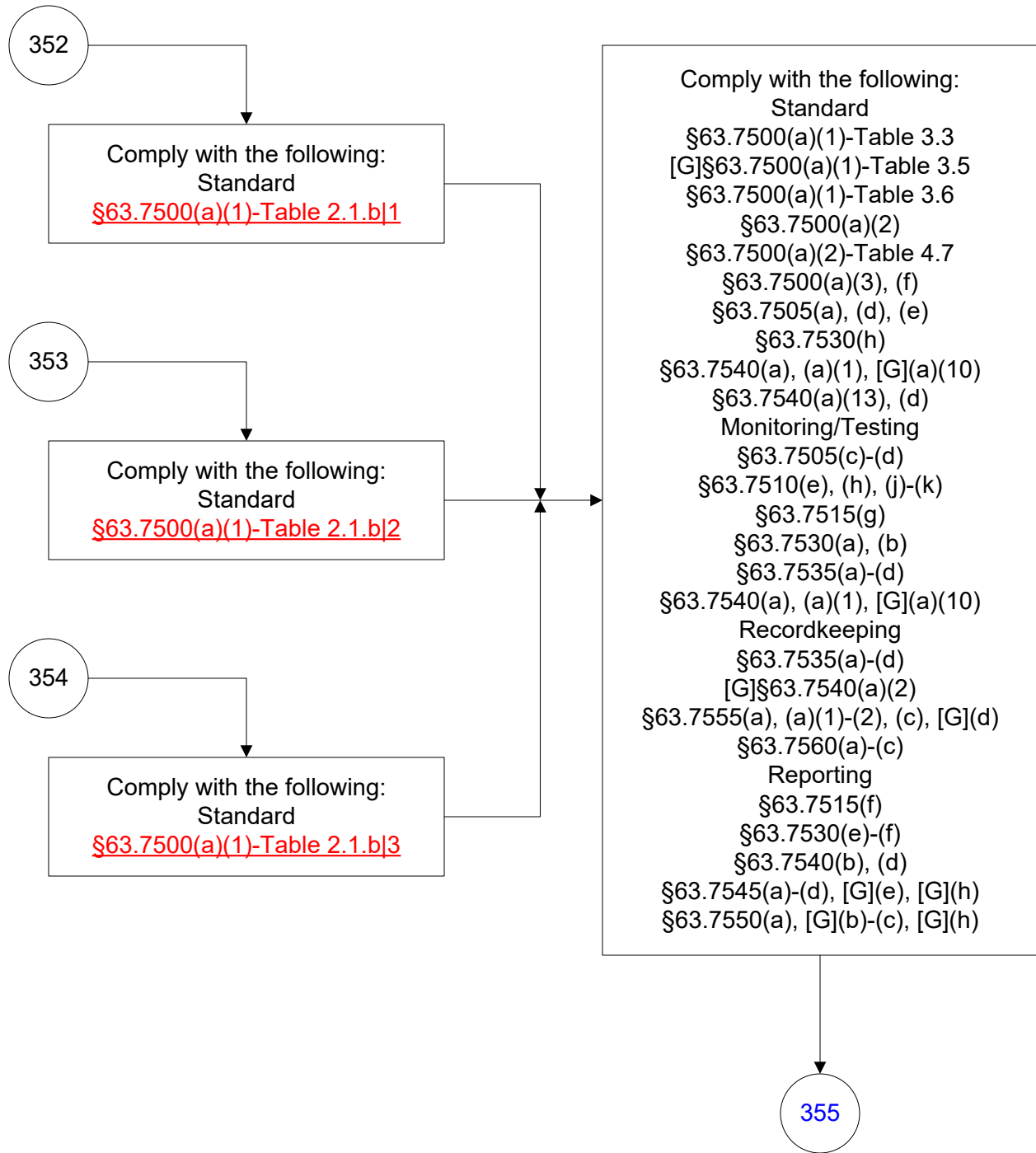

40 CFR Part 63, Subpart DDDDD (145 of 242)

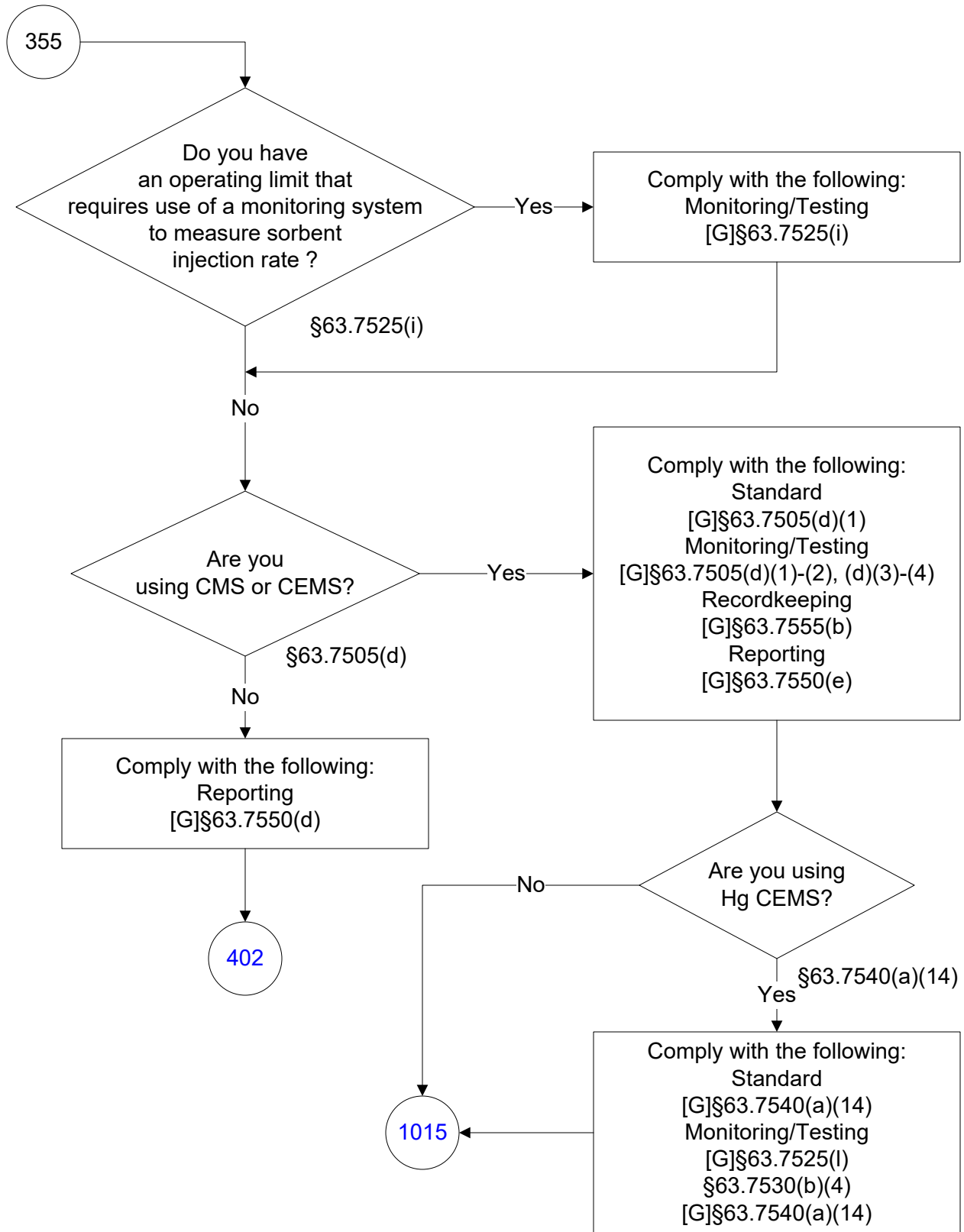

40 CFR Part 63, Subpart DDDDD (146 of 242)

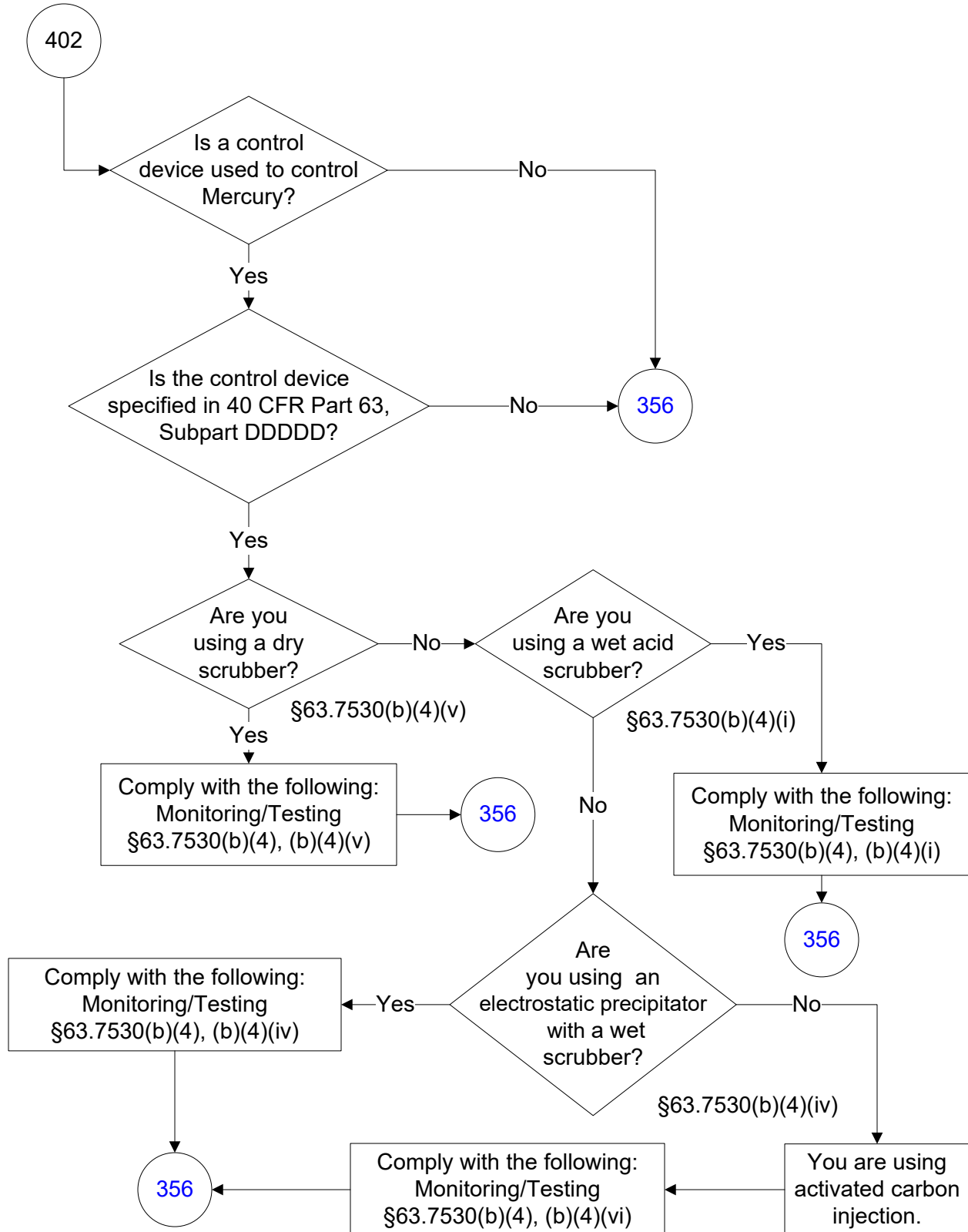

40 CFR Part 63, Subpart DDDDD (147 of 242)

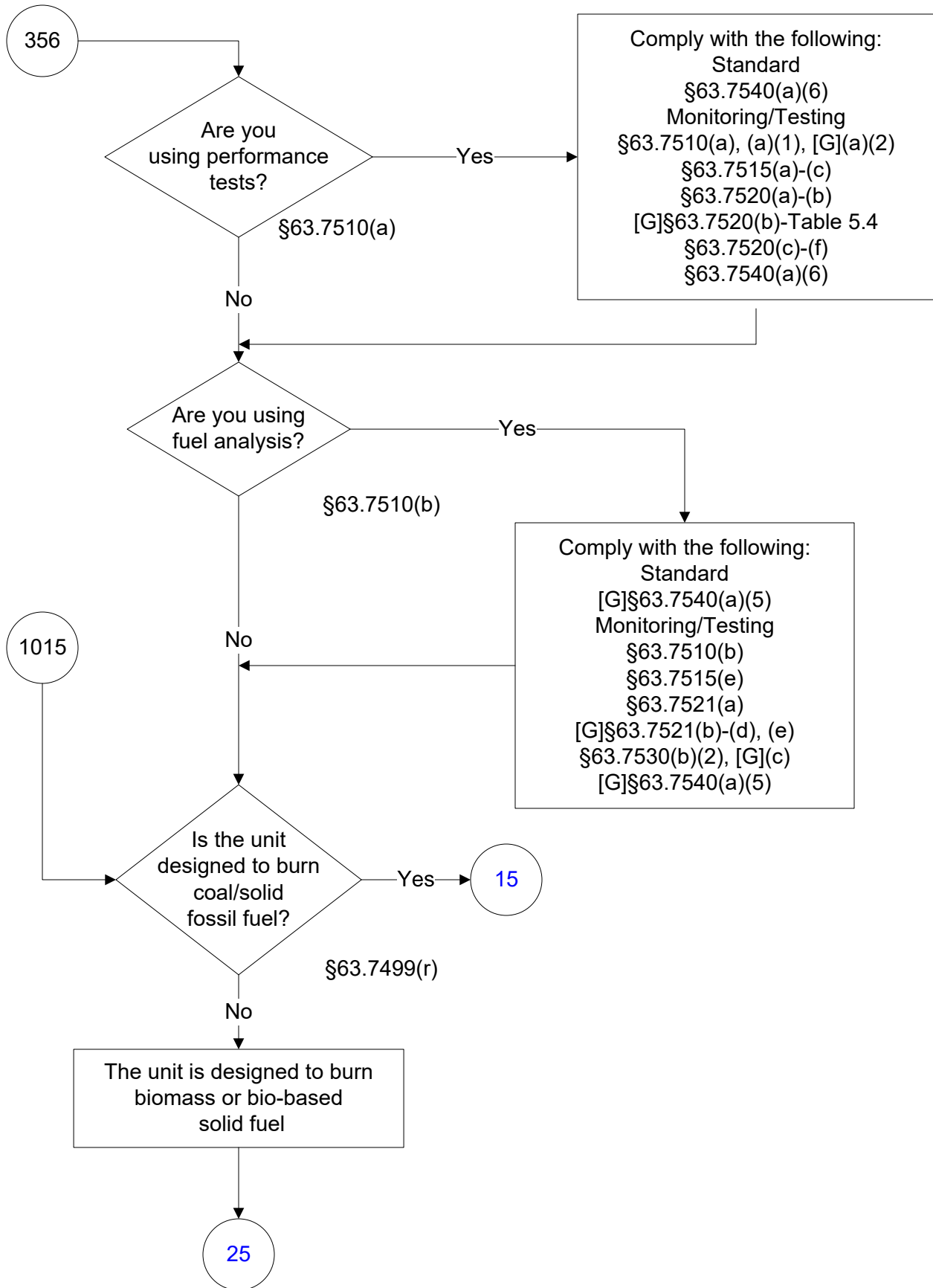

40 CFR Part 63, Subpart DDDDD (148 of 242)

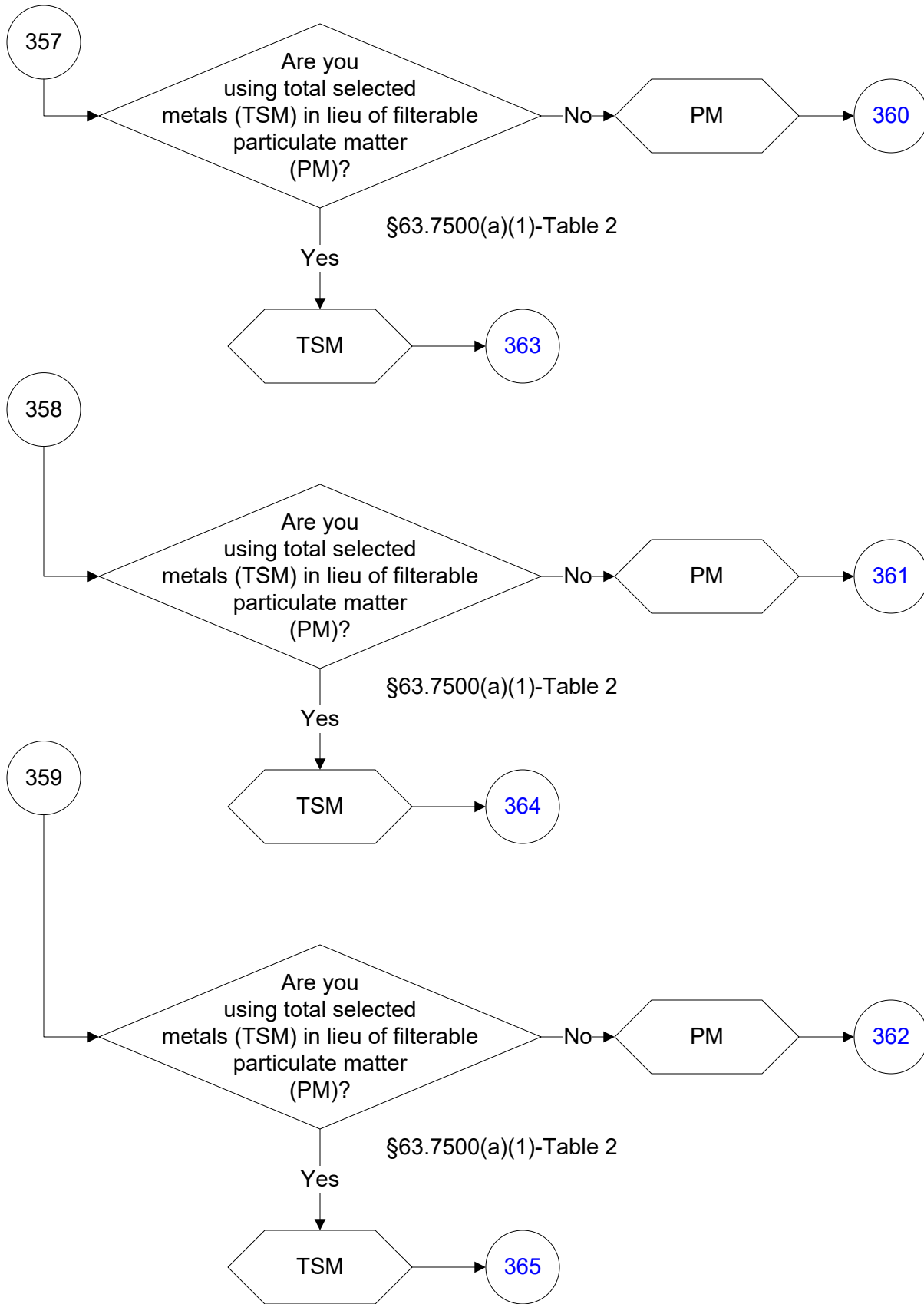

40 CFR Part 63, Subpart DDDDD (149 of 242)

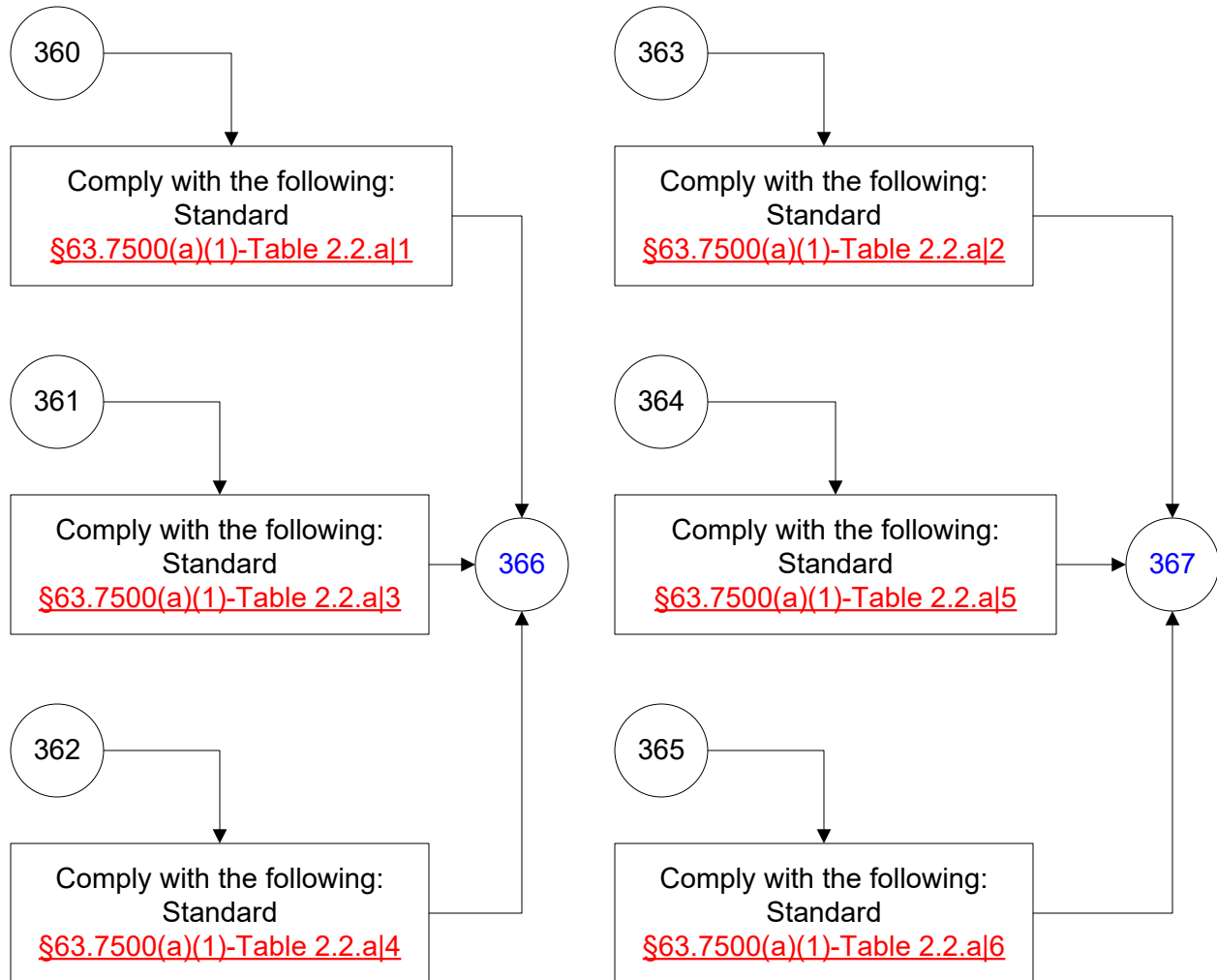

**40 CFR Part 63, Subpart DDDDD
(150 of 242)**

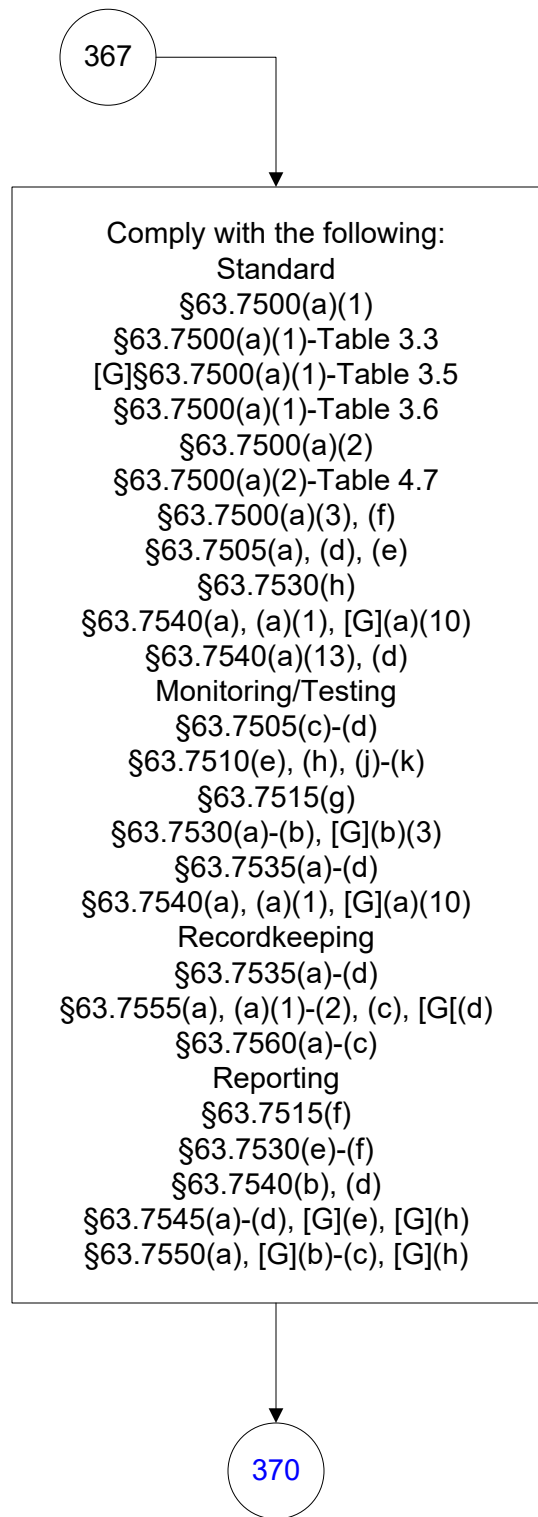
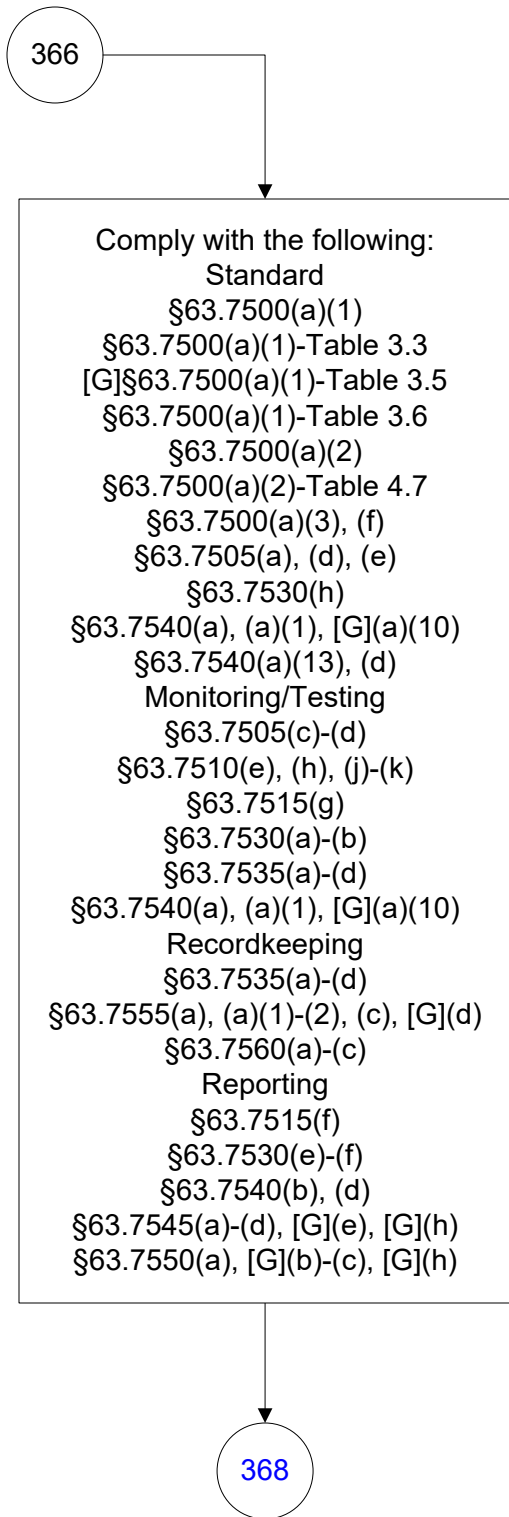

40 CFR Part 63, Subpart DDDDD (151 of 242)

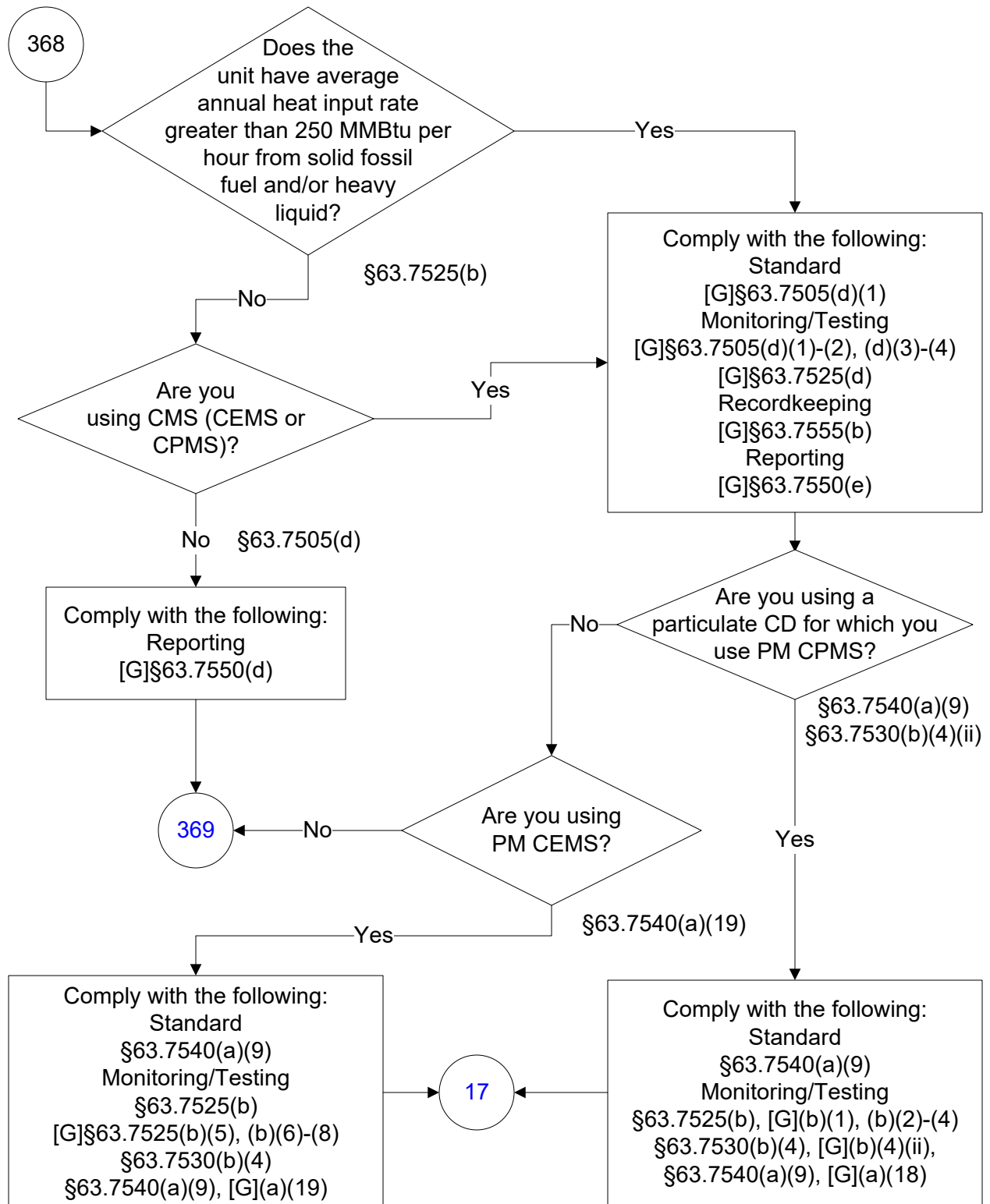

40 CFR Part 63, Subpart DDDDD (152 of 242)

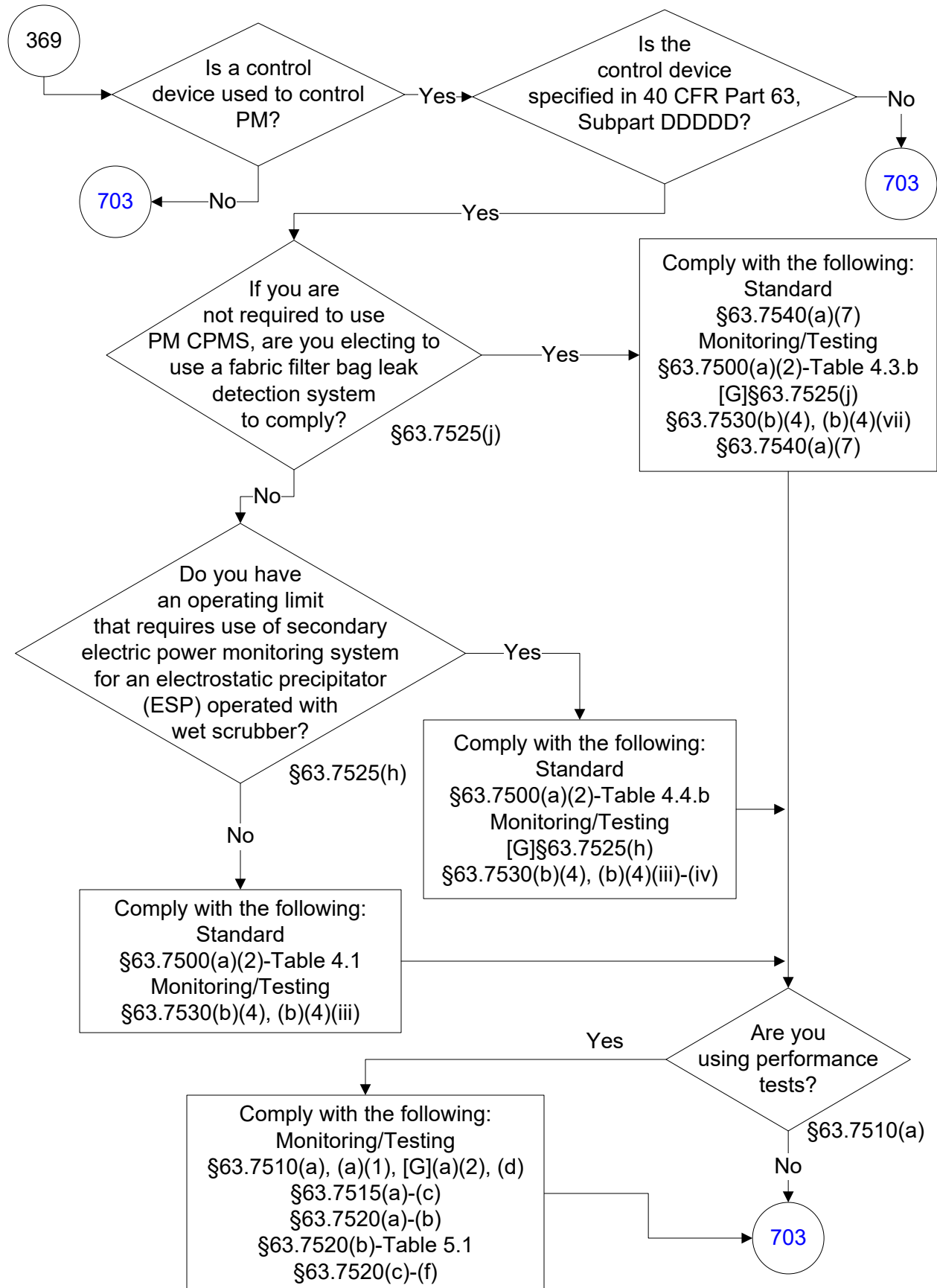

40 CFR Part 63, Subpart DDDDD (153 of 242)

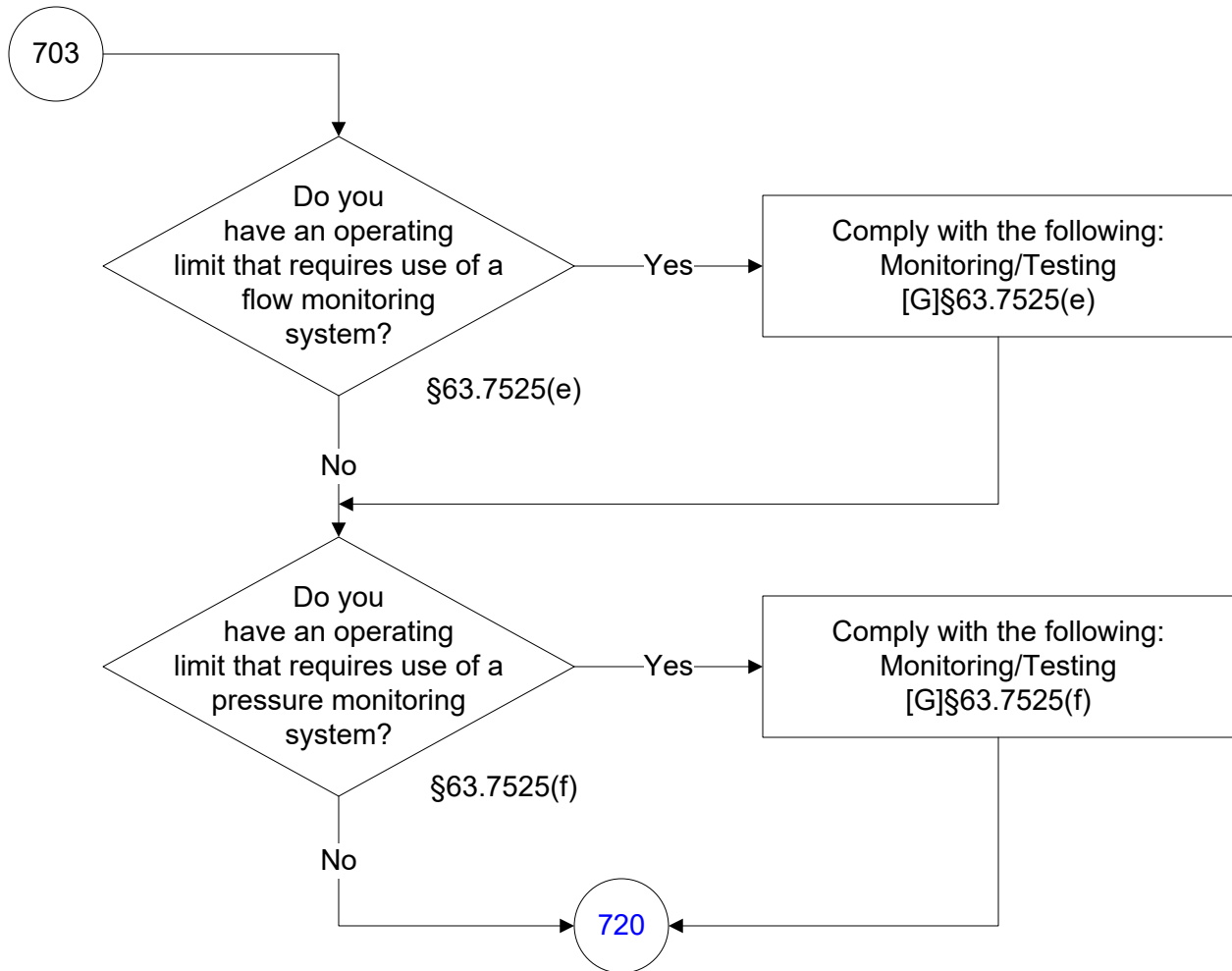

40 CFR Part 63, Subpart DDDDD (154 of 242)

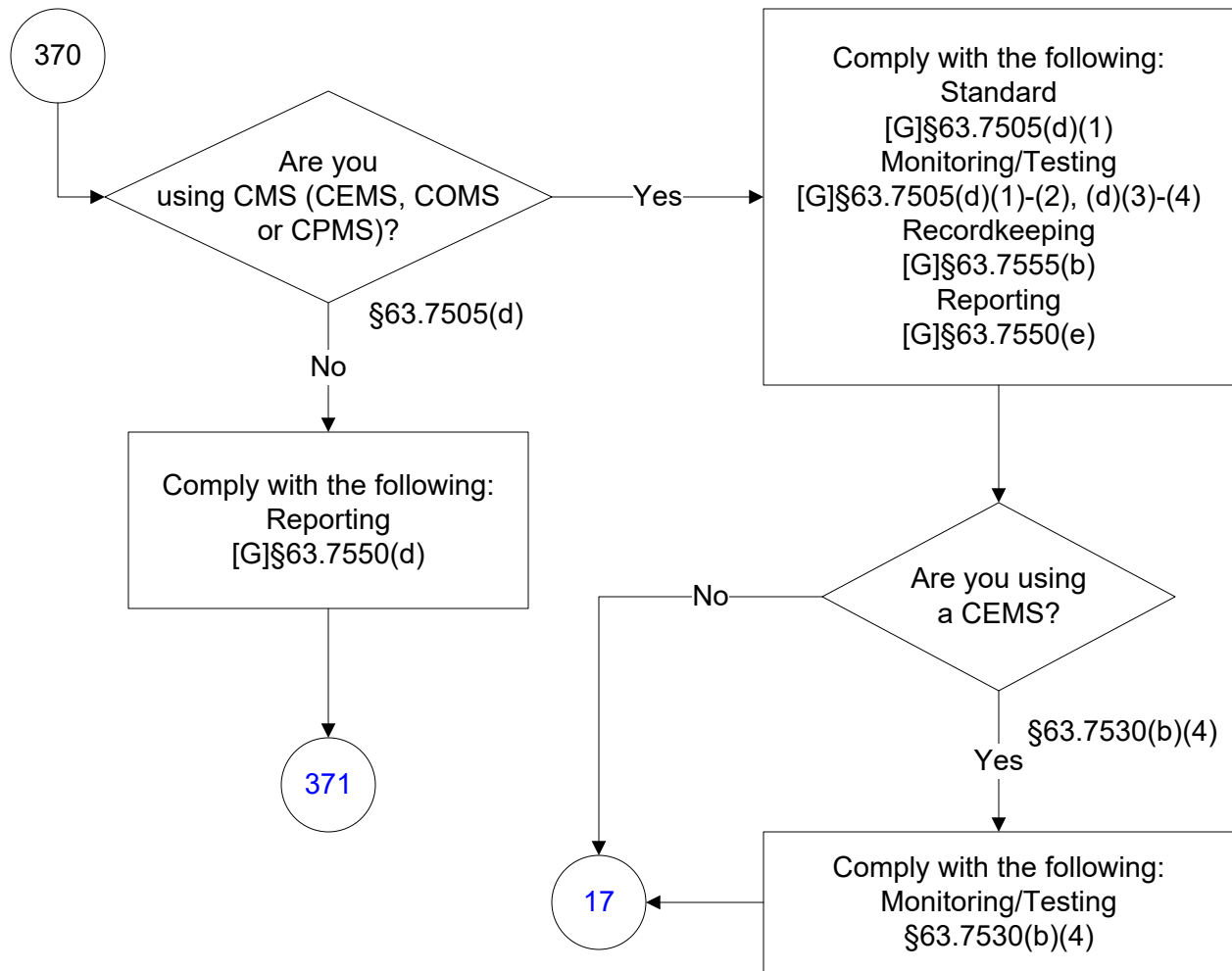

40 CFR Part 63, Subpart DDDDD (155 of 242)

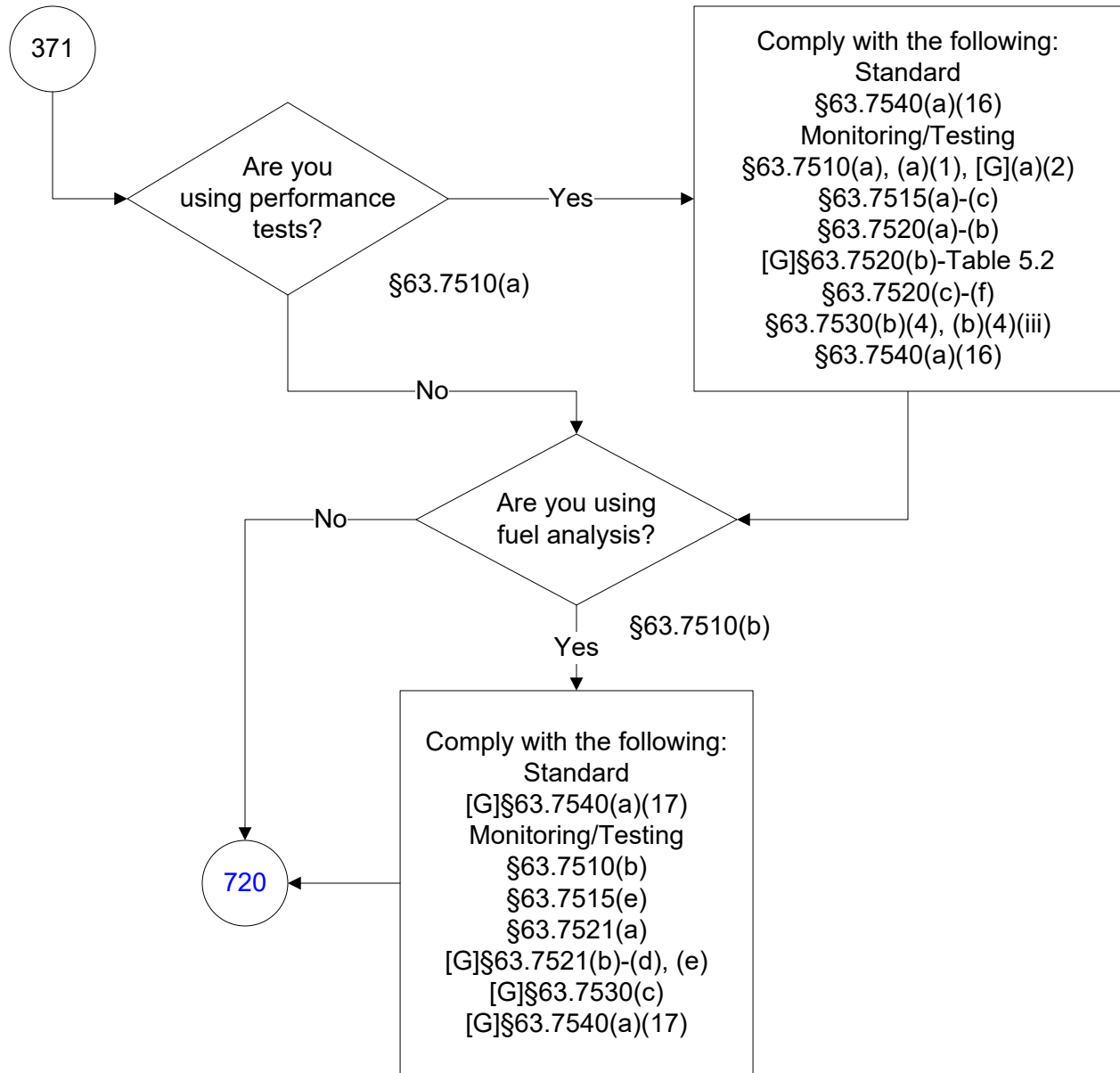

40 CFR Part 63, Subpart DDDDD (156 of 242)

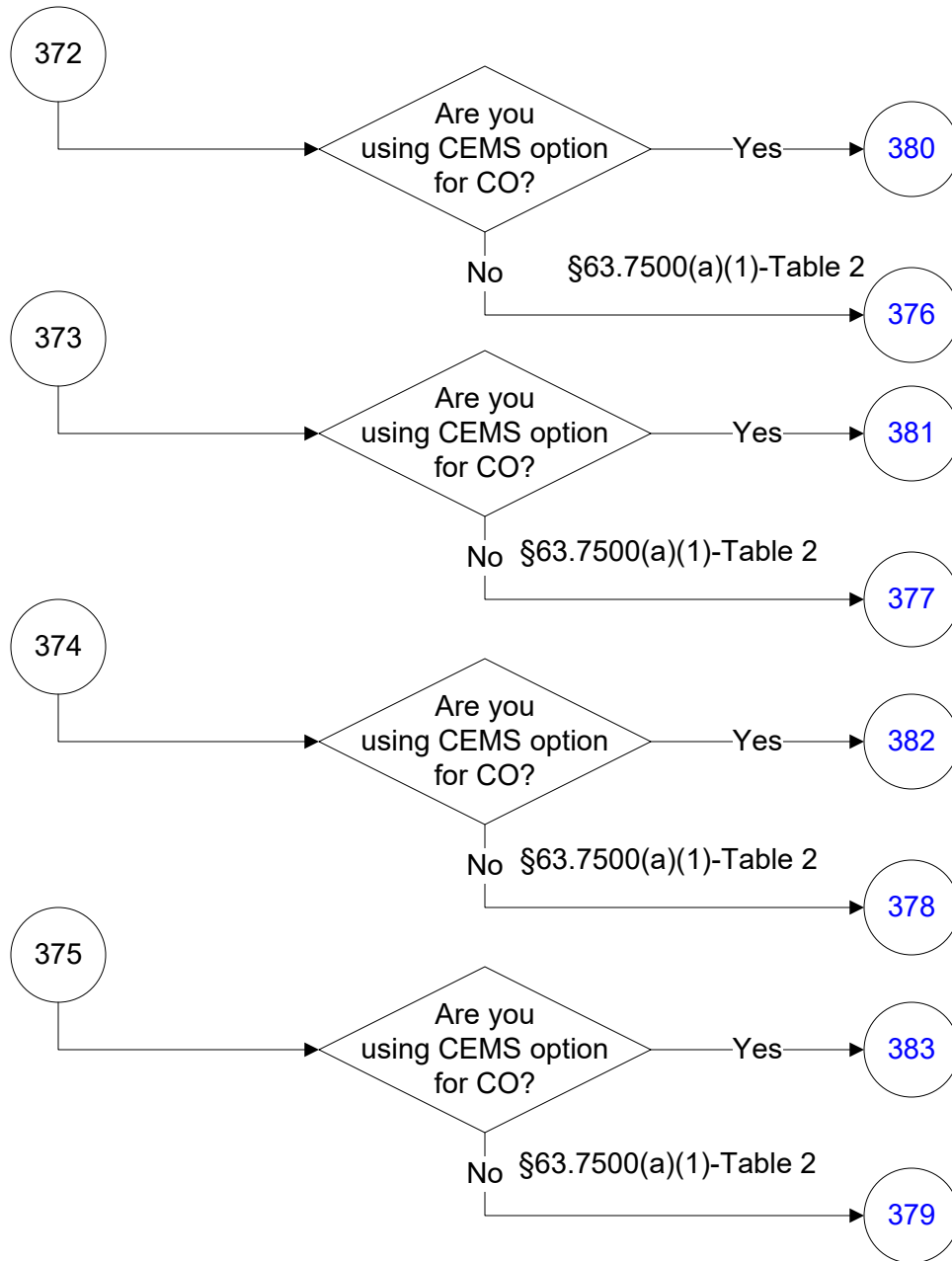

40 CFR Part 63, Subpart DDDDD (157 of 242)

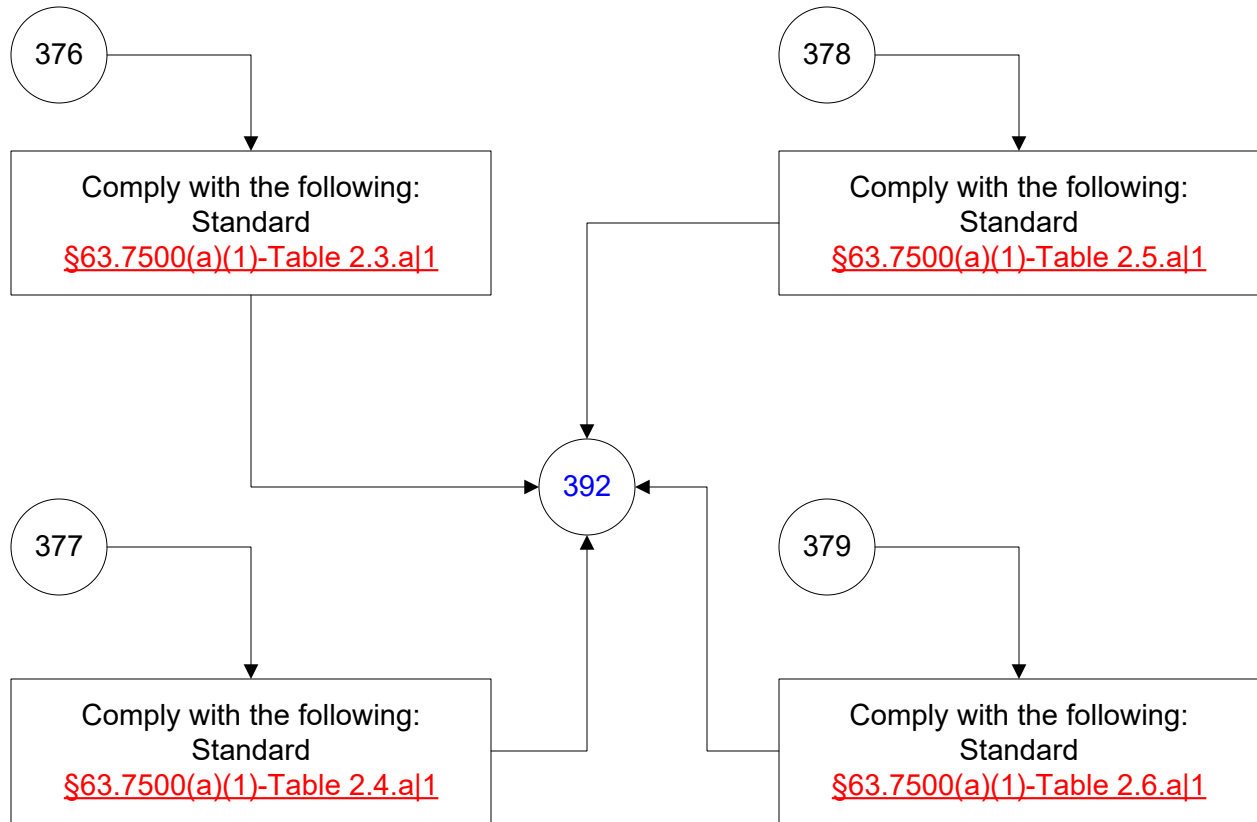

40 CFR Part 63, Subpart DDDDD (158 of 242)

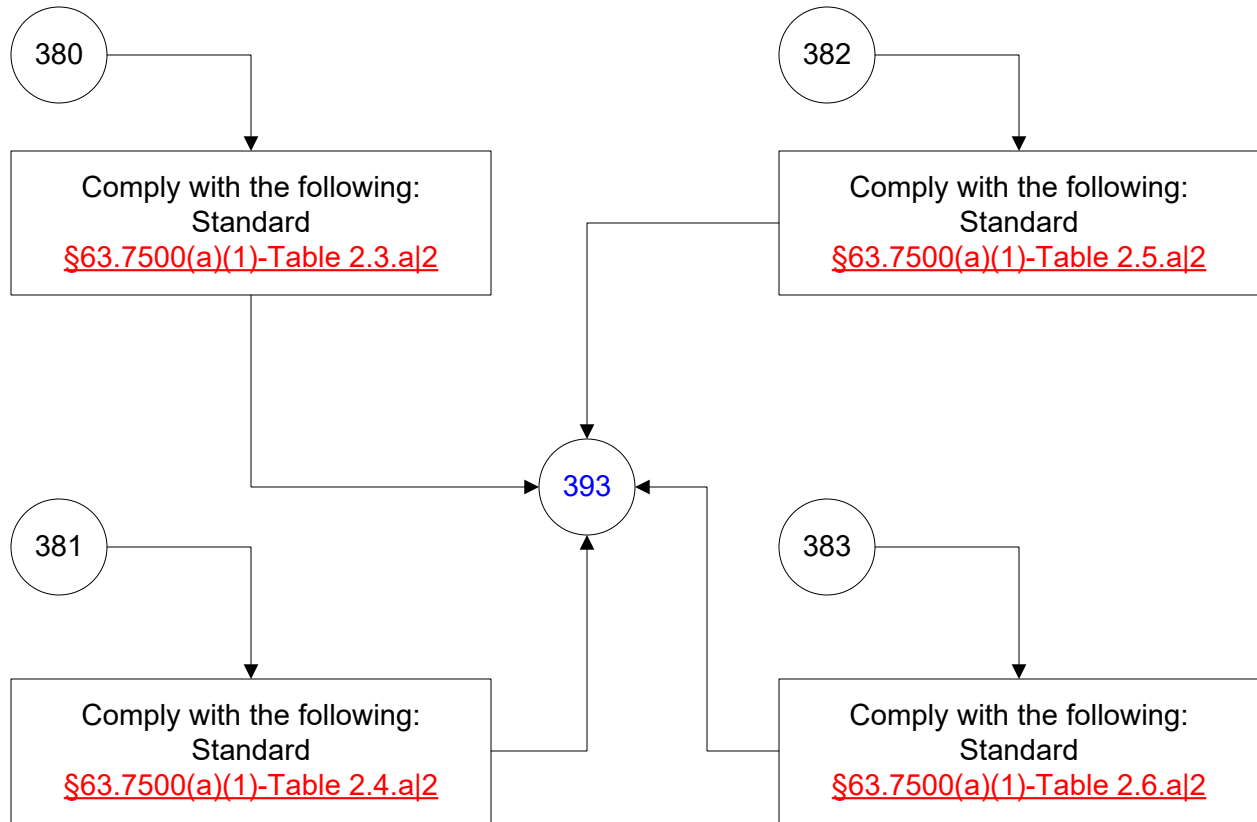

40 CFR Part 63, Subpart DDDDD (159 of 242)

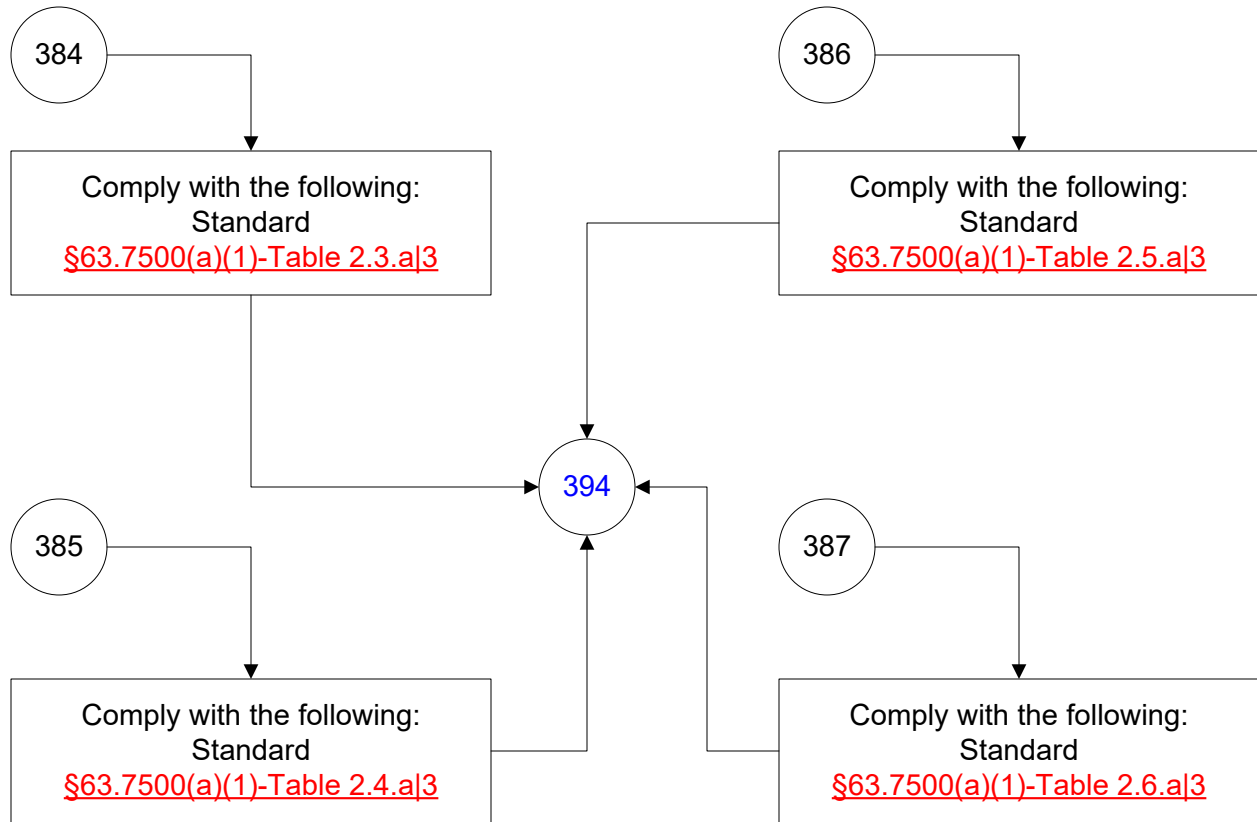

40 CFR Part 63, Subpart DDDDD (160 of 242)

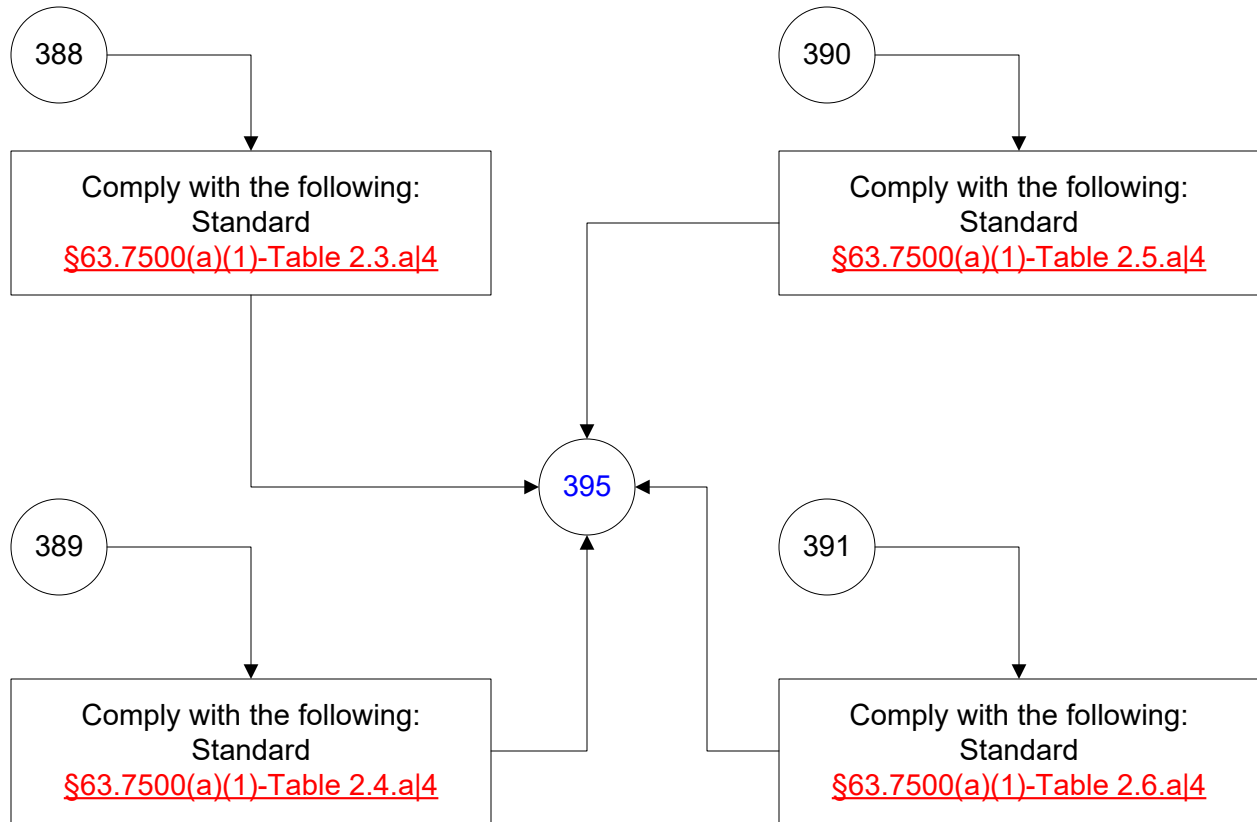

**40 CFR Part 63, Subpart DDDDD
(161 of 242)**

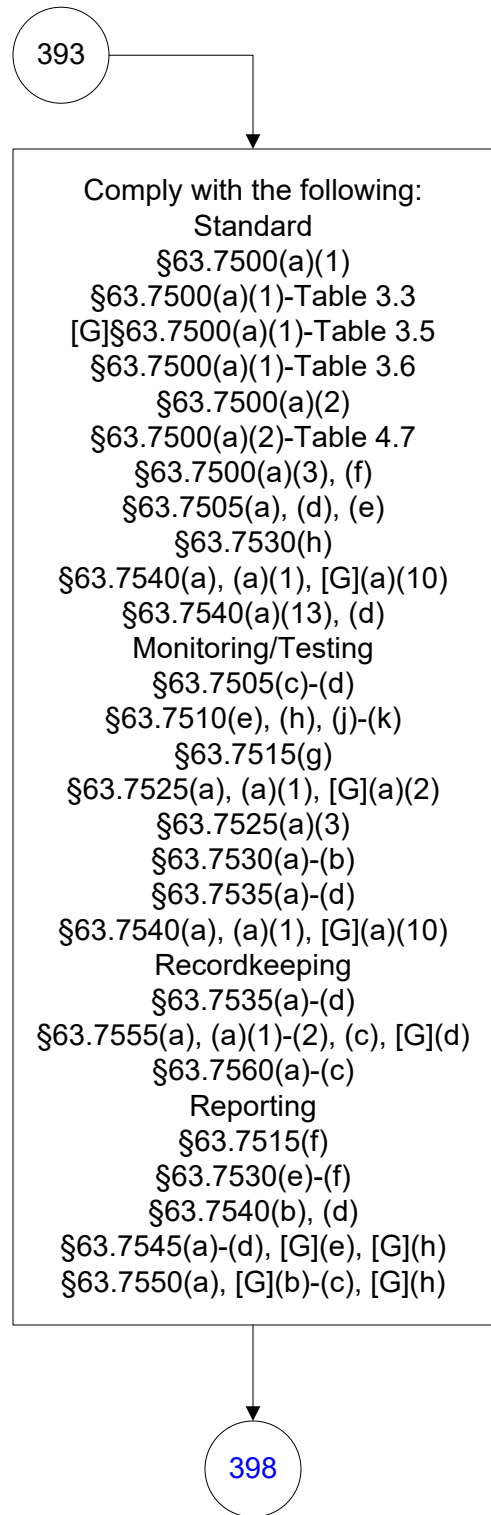
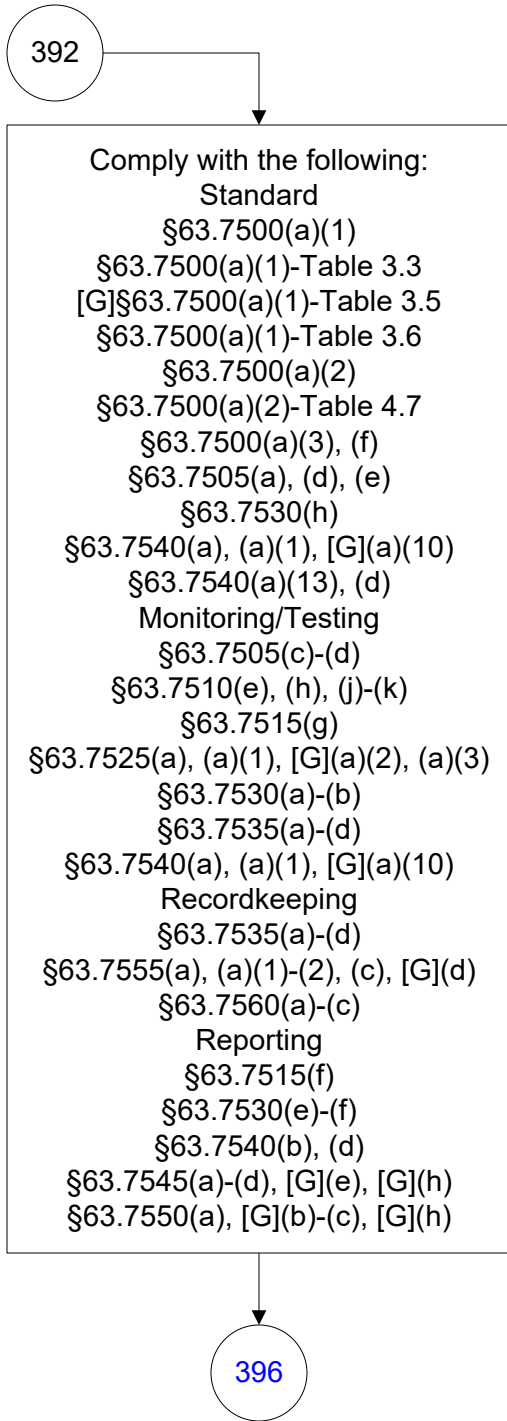

40 CFR Part 63, Subpart DDDDD
(162 of 242)

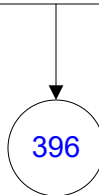
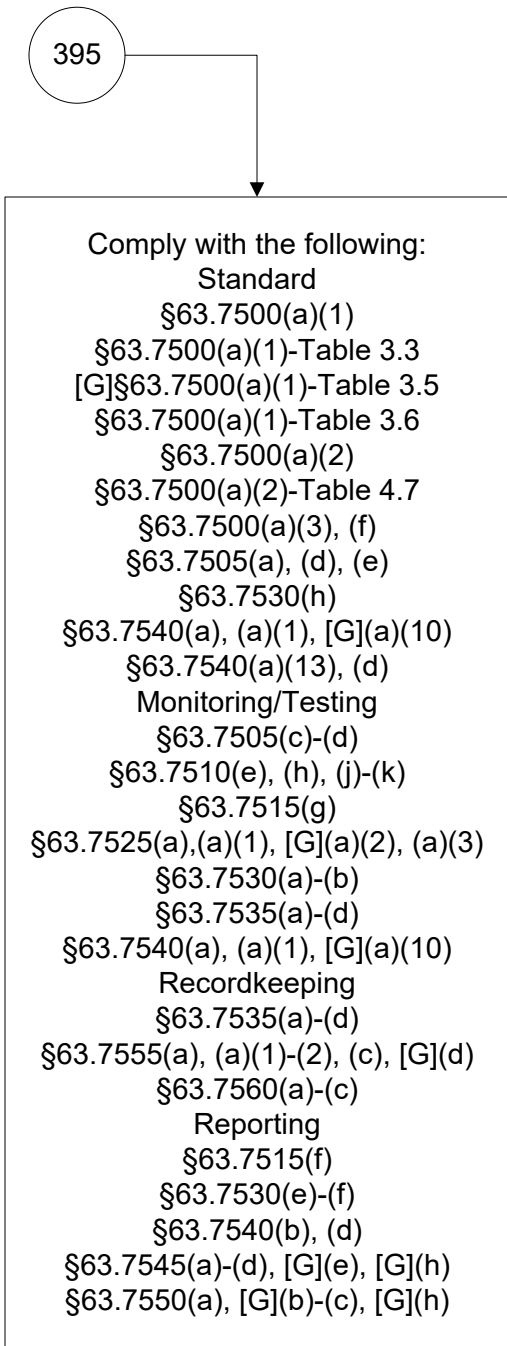
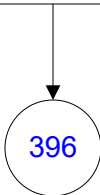
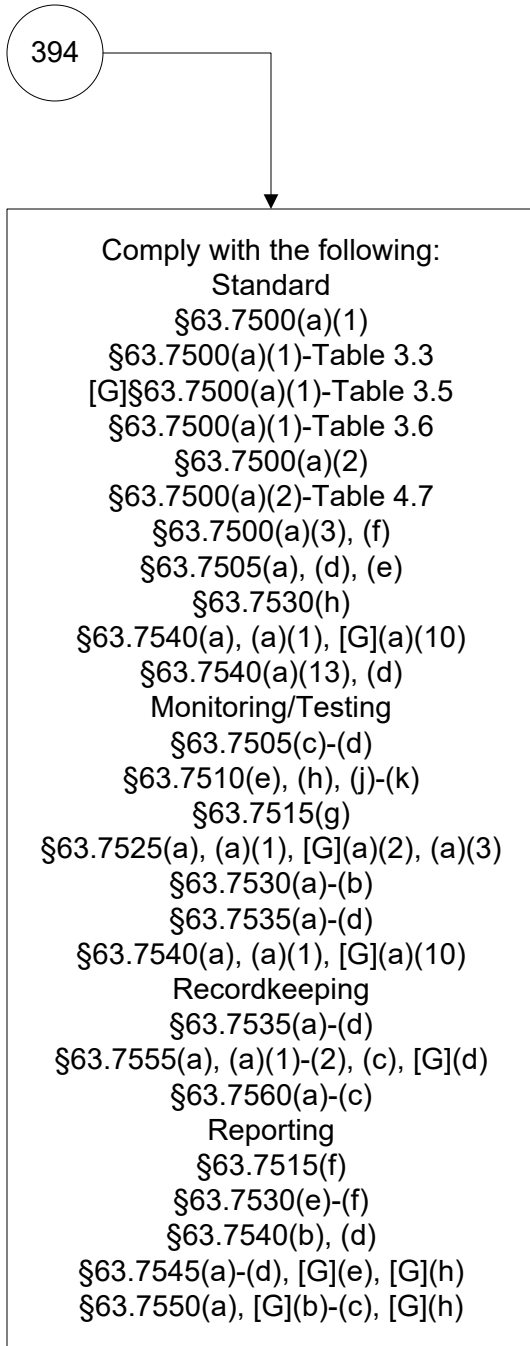

40 CFR Part 63, Subpart DDDDD (163 of 242)

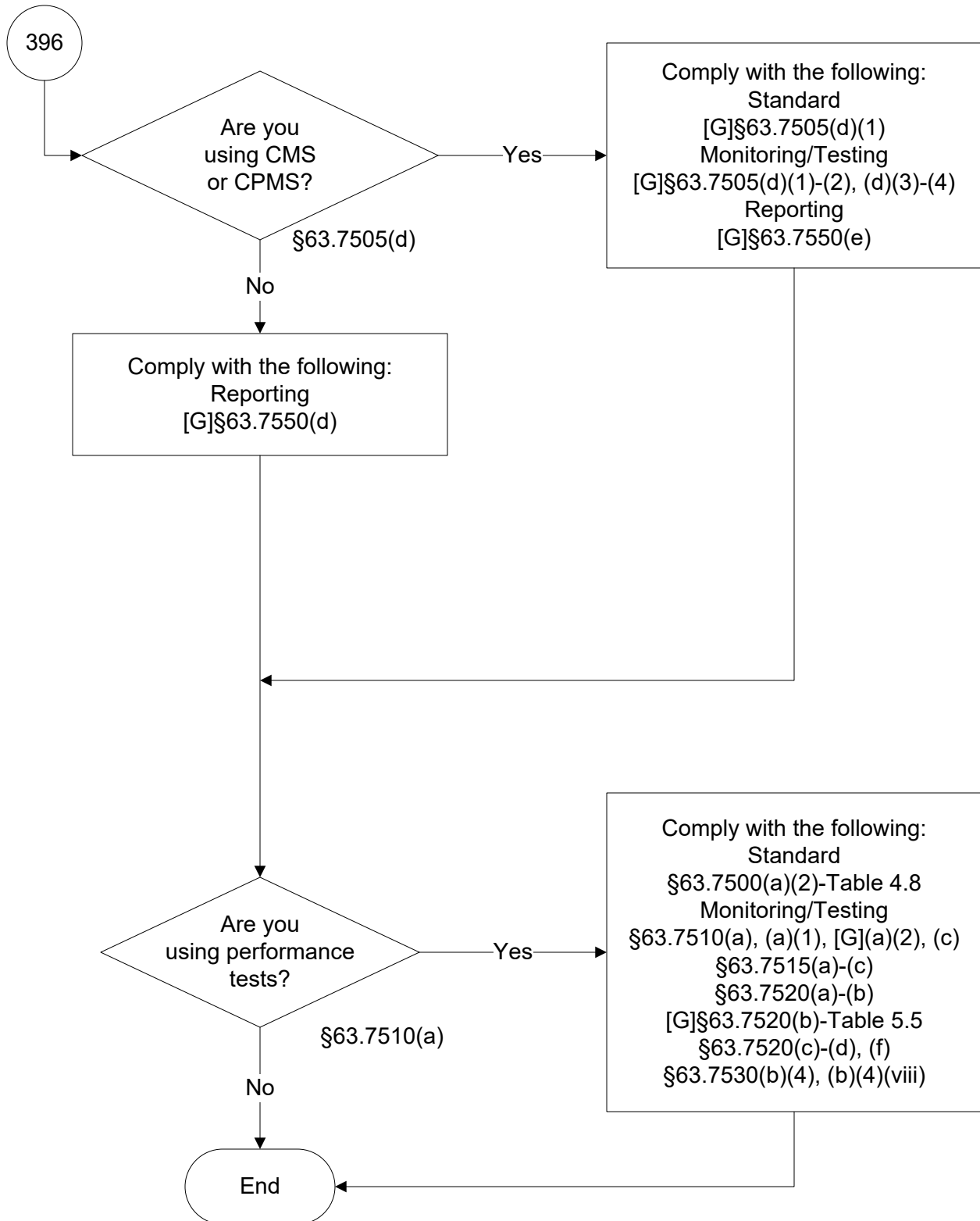

40 CFR Part 63, Subpart DDDDD (164 of 242)

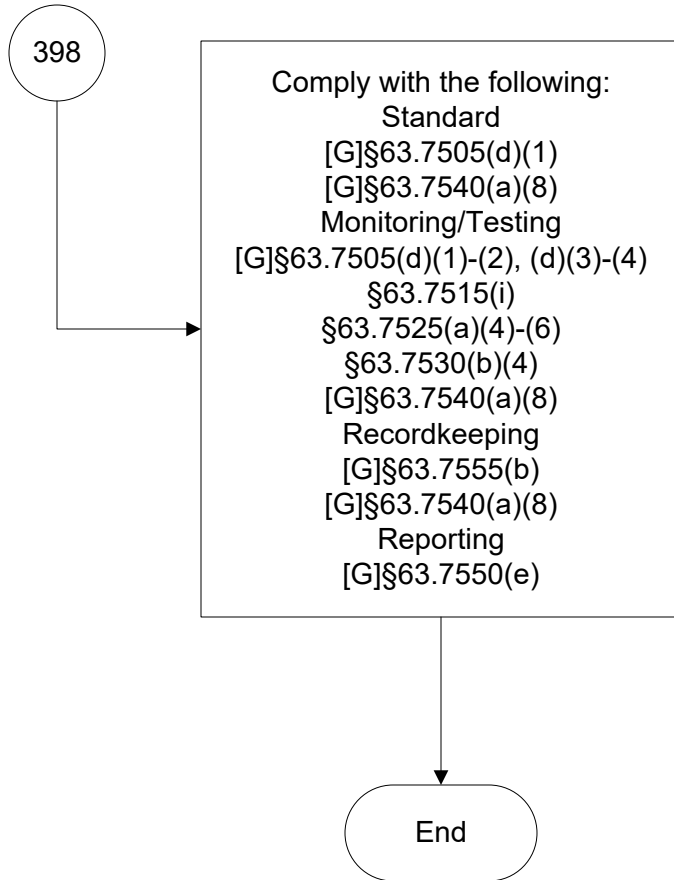

40 CFR Part 63, Subpart DDDDD (165 of 242)

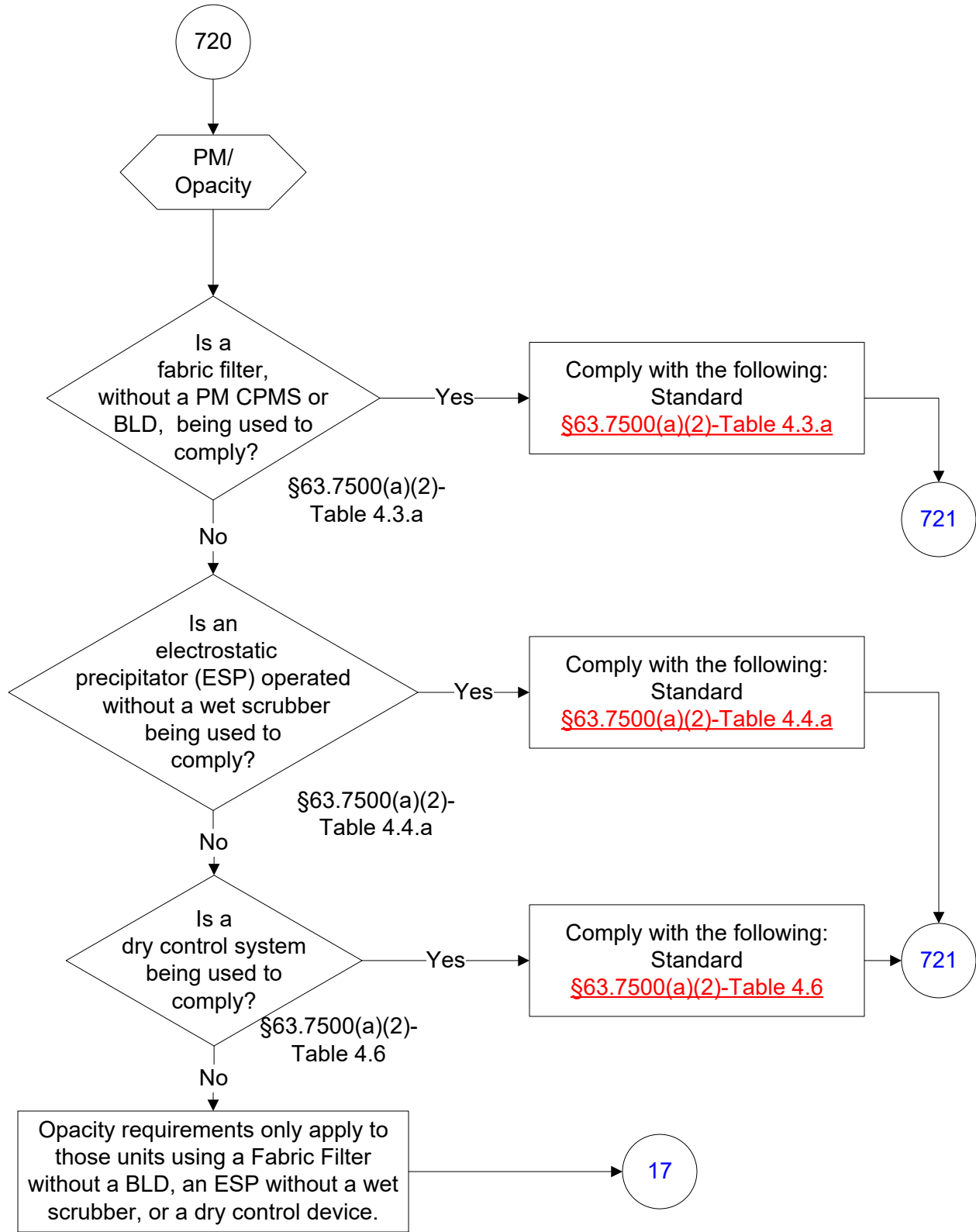

40 CFR Part 63, Subpart DDDDD (166 of 242)

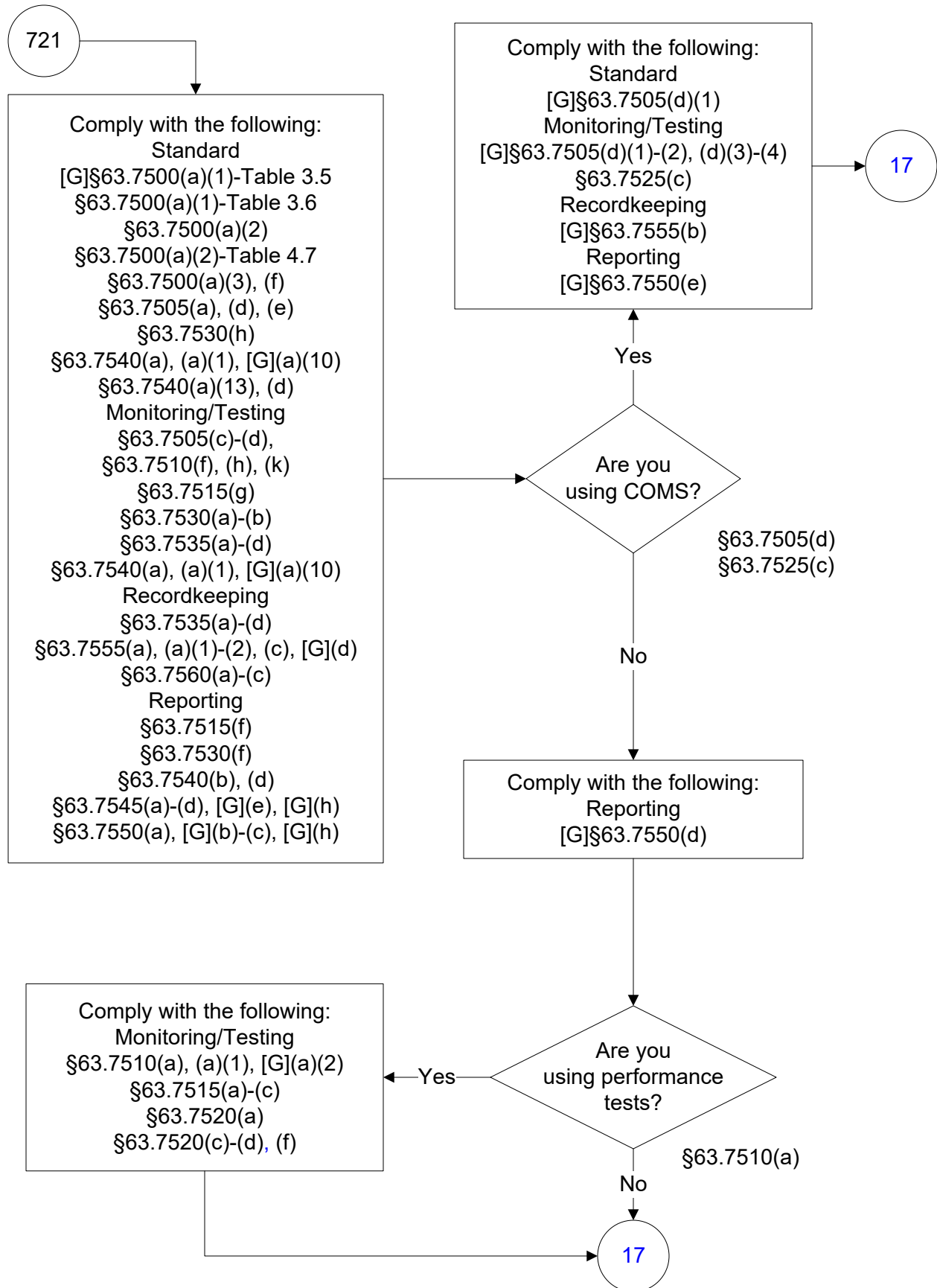

40 CFR Part 63, Subpart DDDDD (167 of 242)

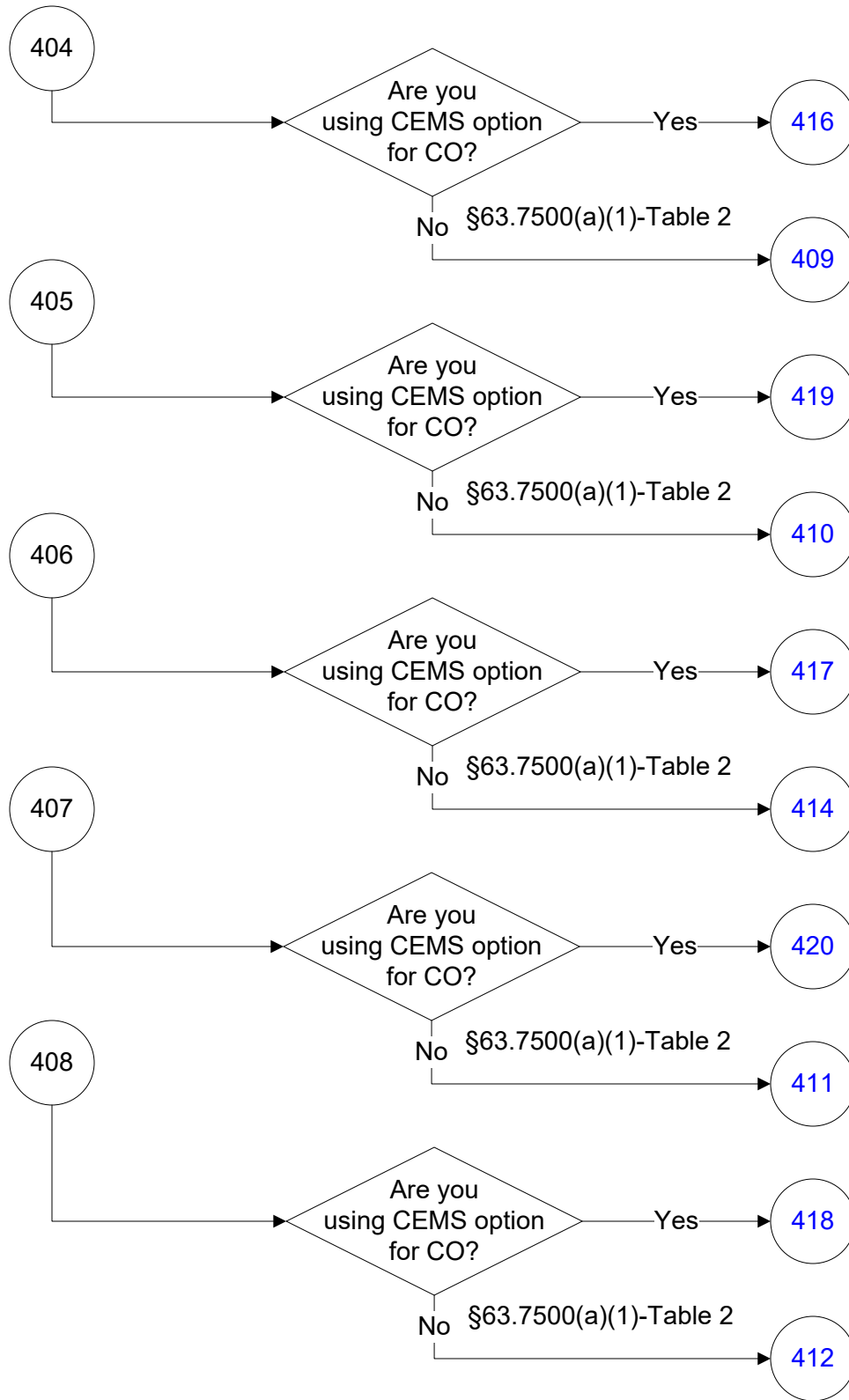

40 CFR Part 63, Subpart DDDDD (168 of 242)



40 CFR Part 63, Subpart DDDDD (169 of 242)

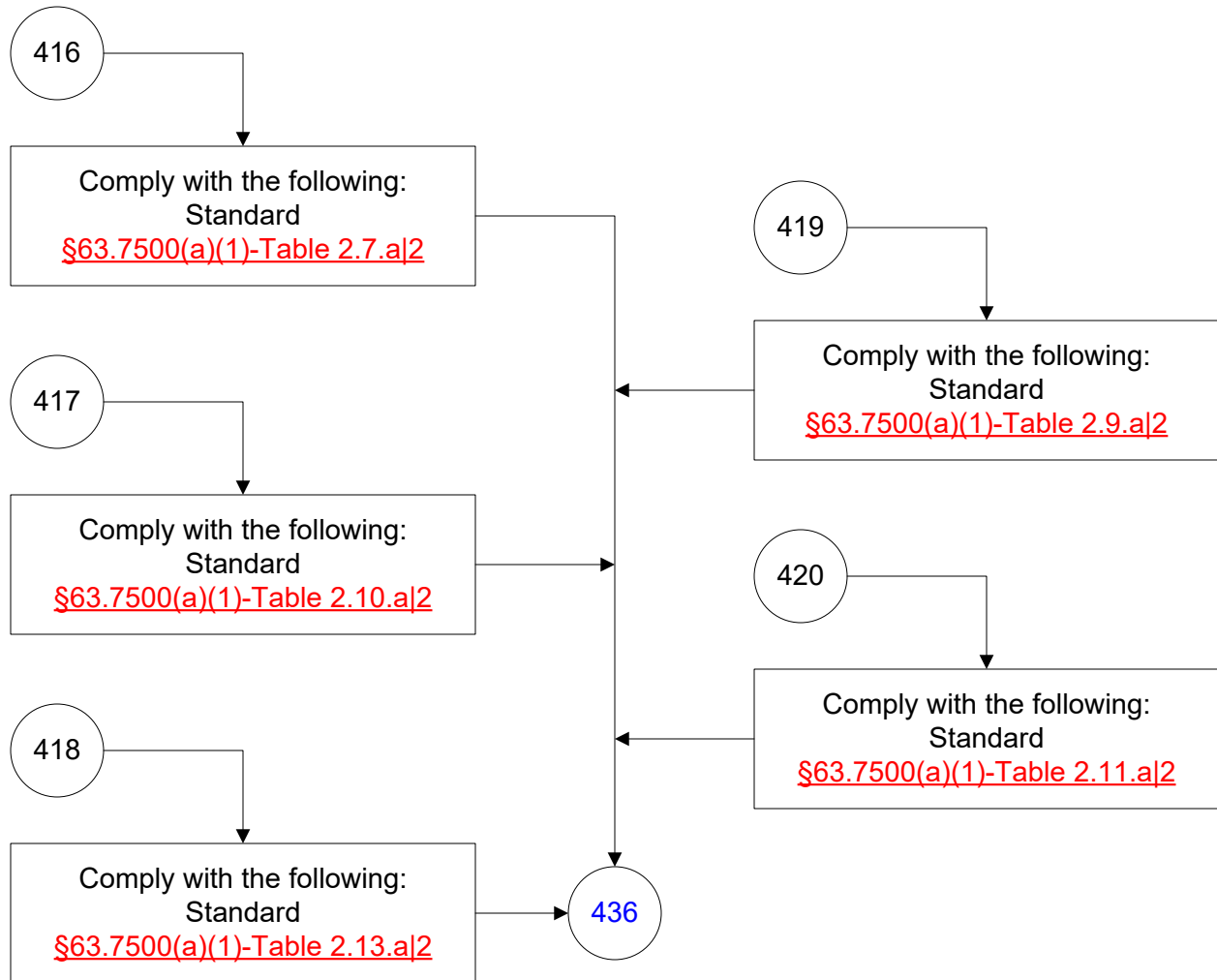

40 CFR Part 63, Subpart DDDDD (170 of 242)

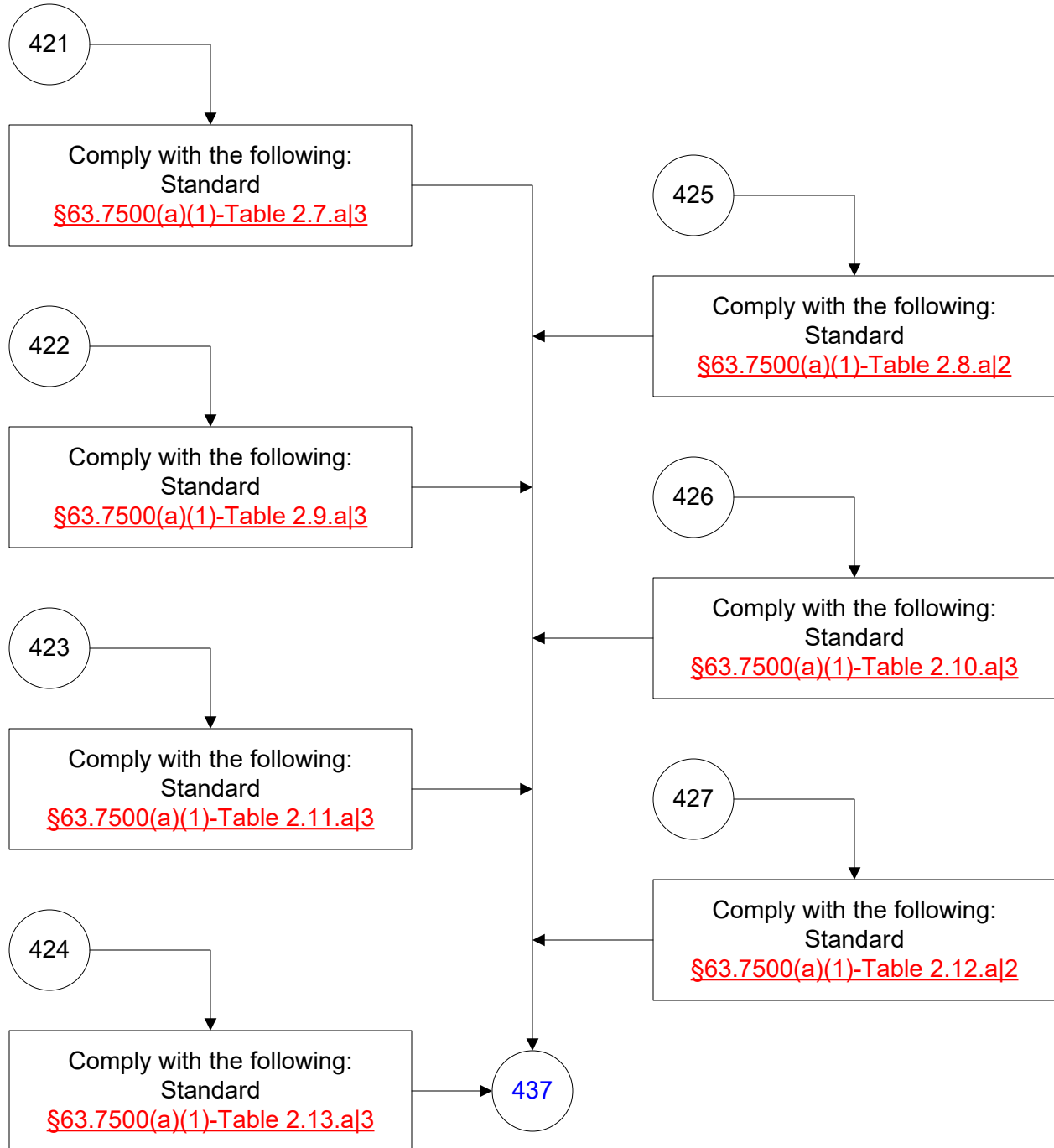

40 CFR Part 63, Subpart DDDDD (171 of 242)



**40 CFR Part 63, Subpart DDDDD
(172 of 242)**

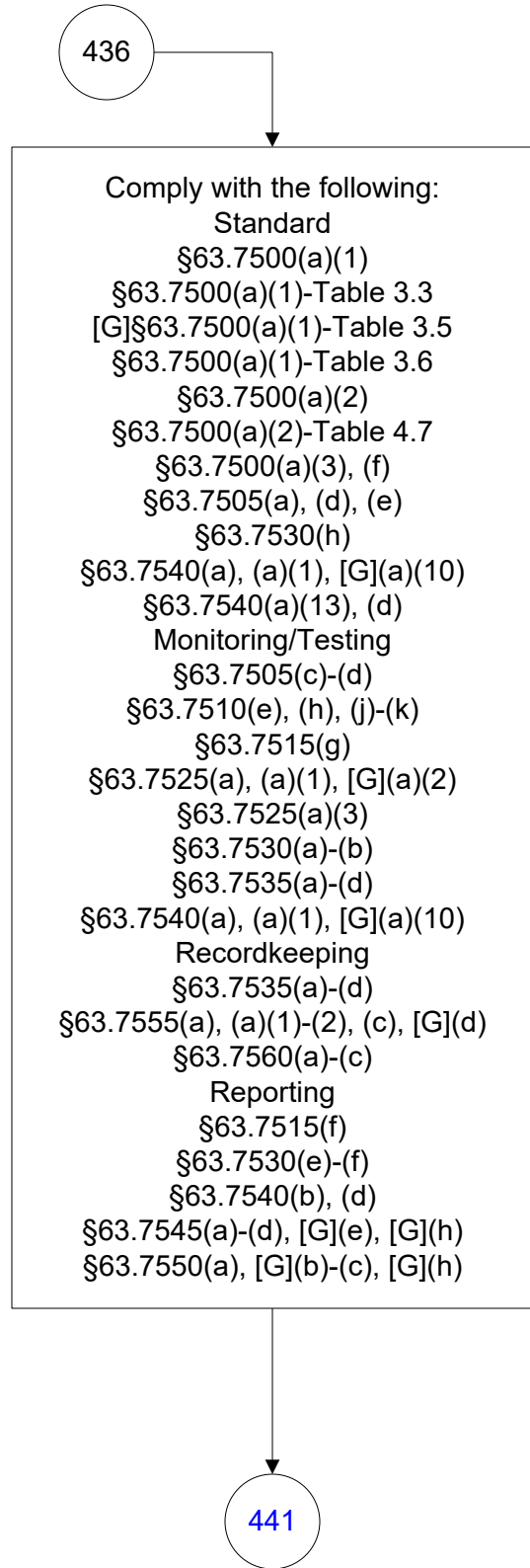
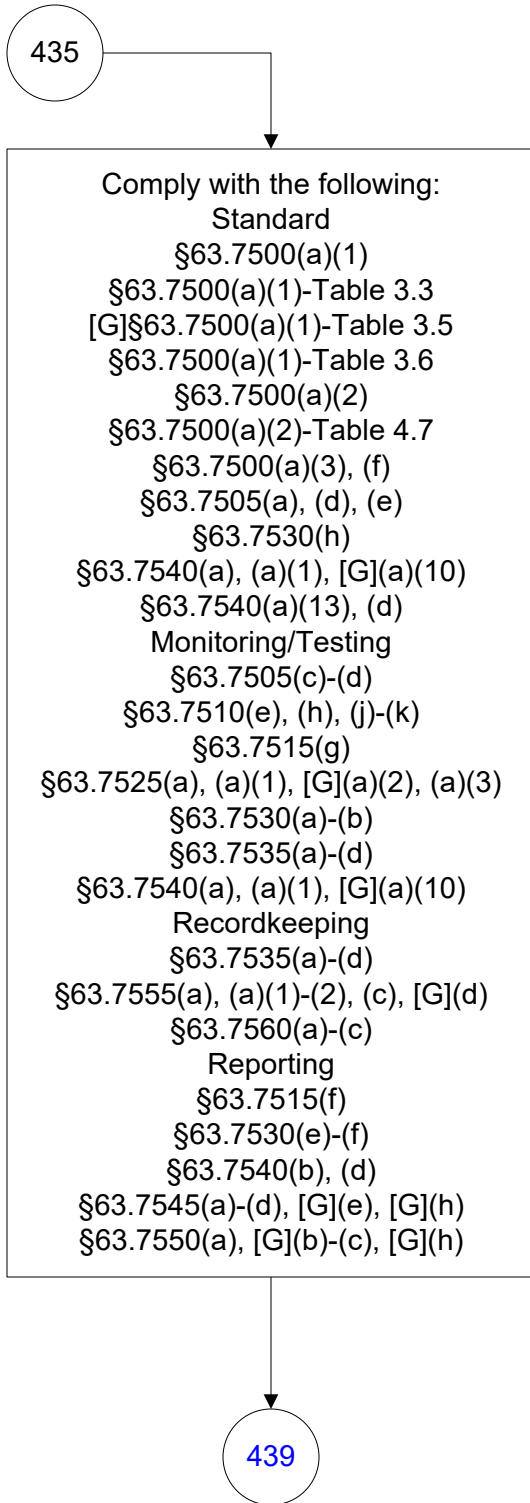

**40 CFR Part 63, Subpart DDDDD
(173 of 242)**

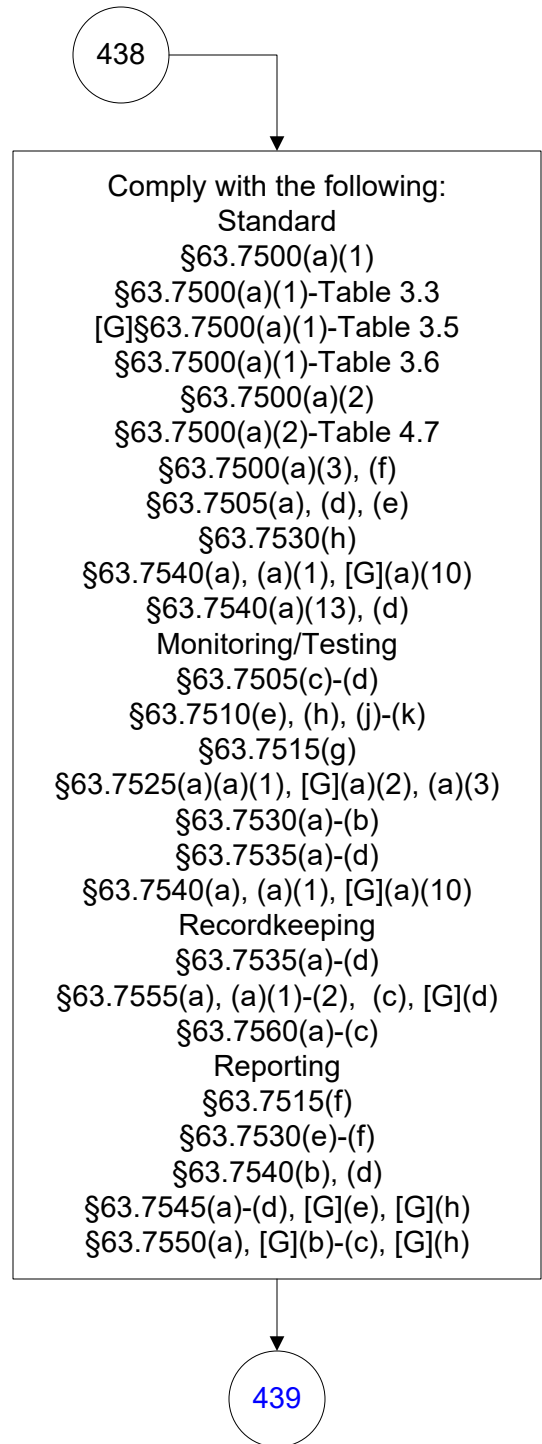
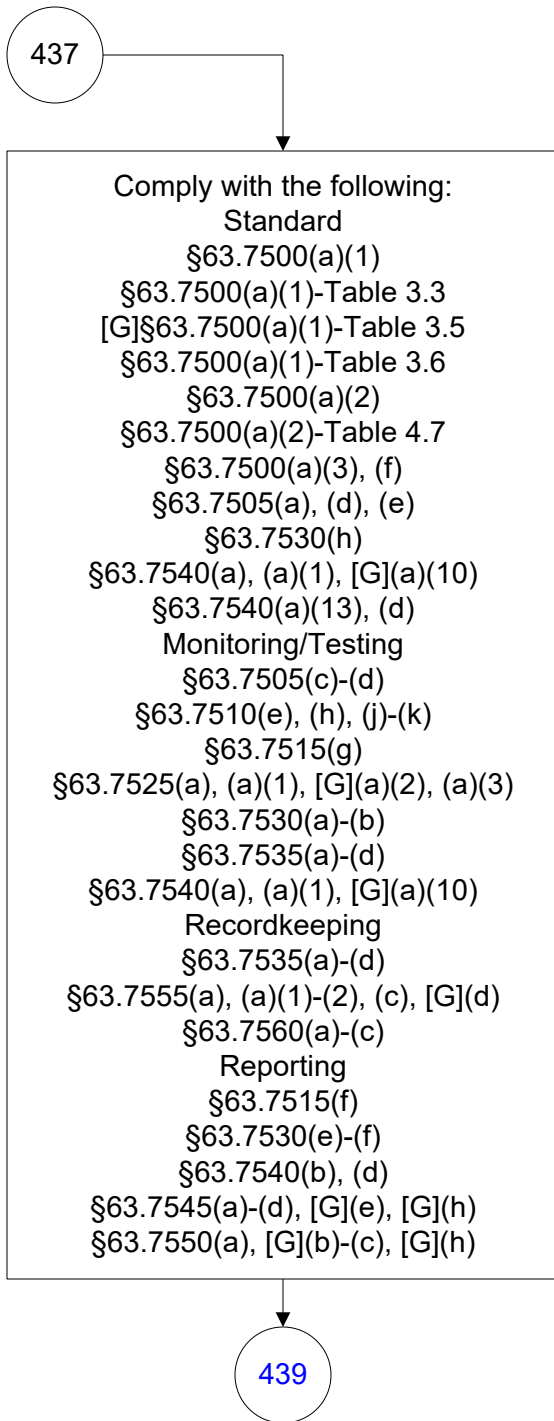

40 CFR Part 63, Subpart DDDDD (174 of 242)

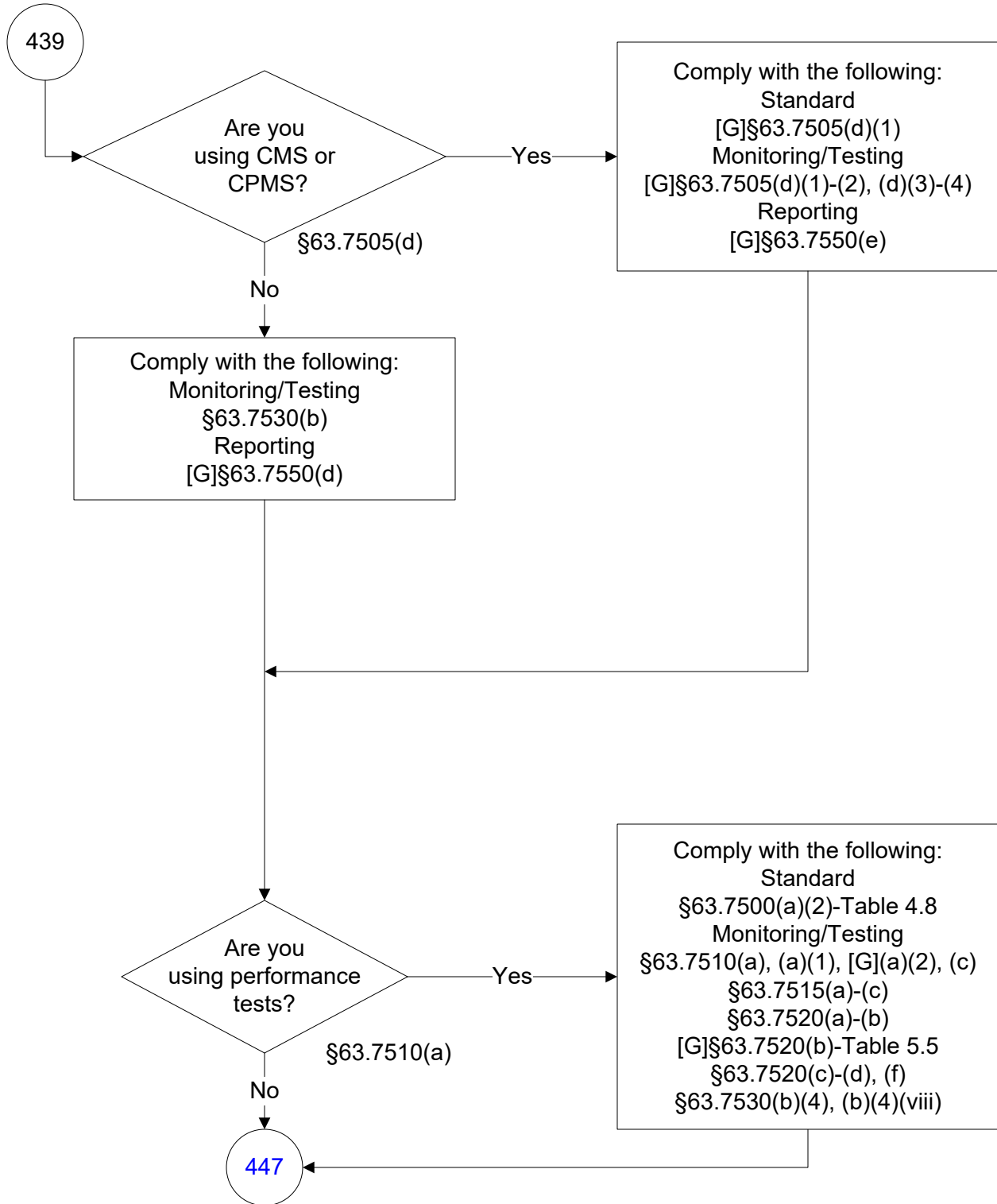

40 CFR Part 63, Subpart DDDDD (175 of 242)

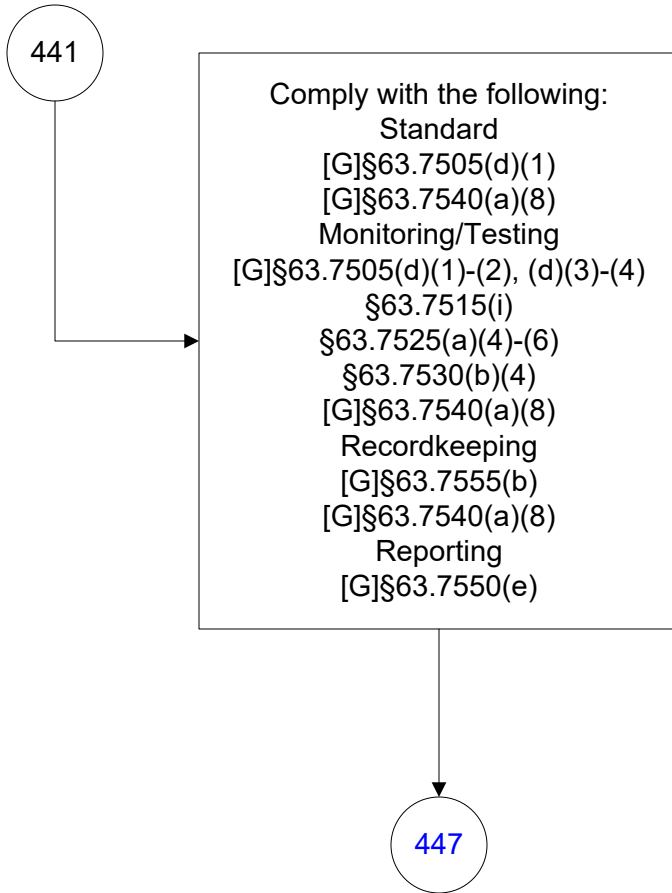

40 CFR Part 63, Subpart DDDDD (176 of 242)

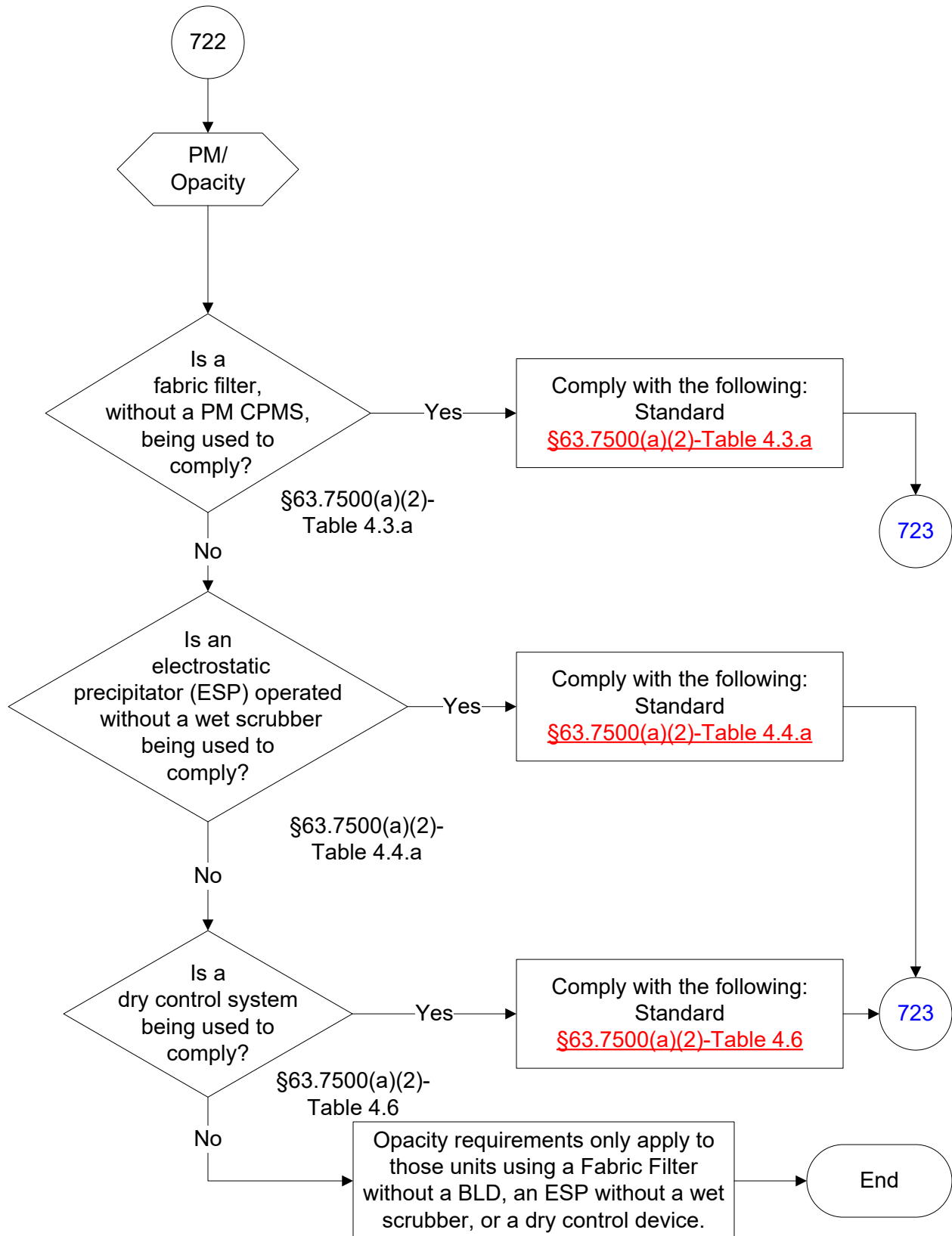

40 CFR Part 63, Subpart DDDDD (177 of 242)

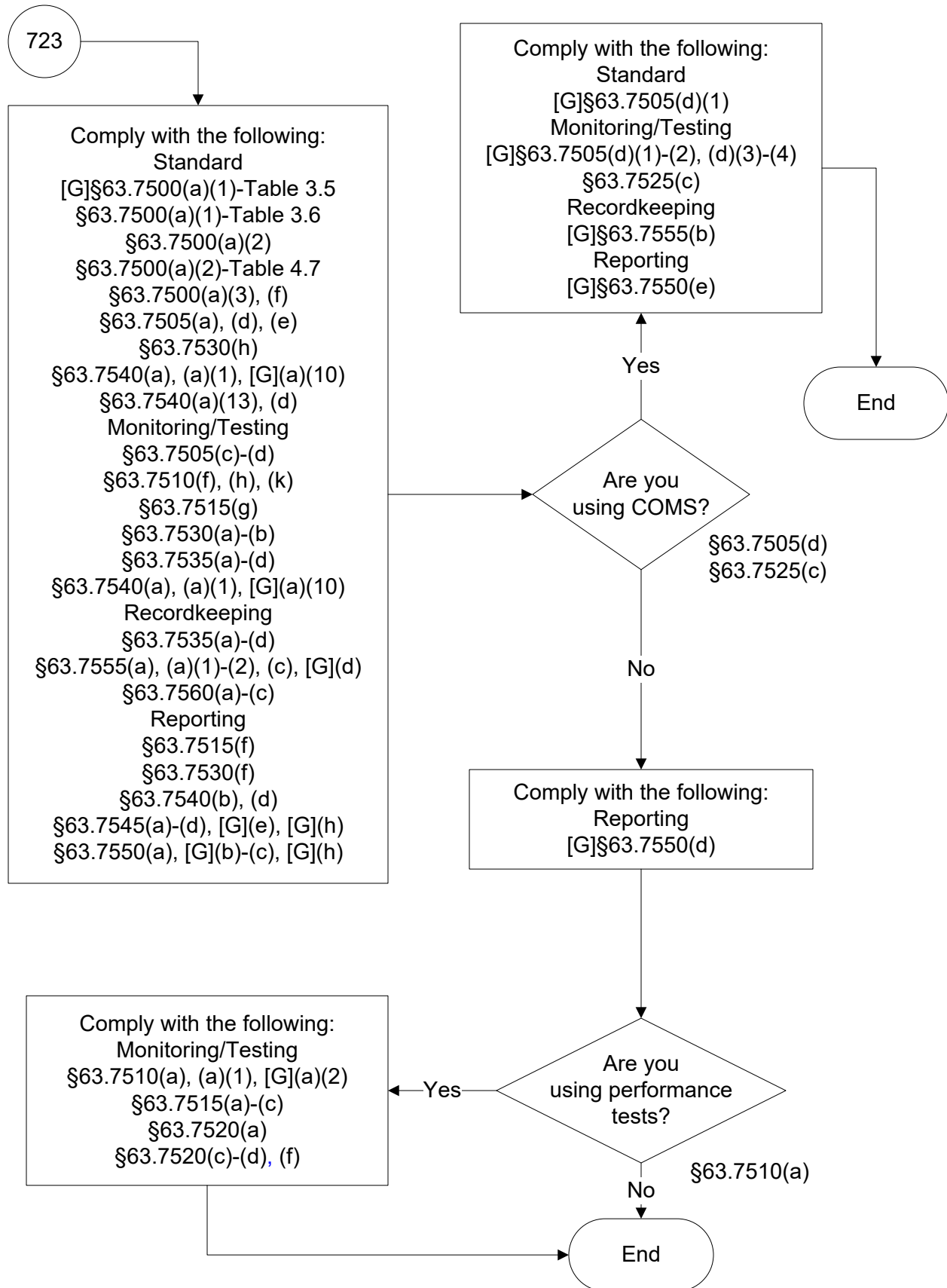

40 CFR Part 63, Subpart DDDDD (178 of 242)

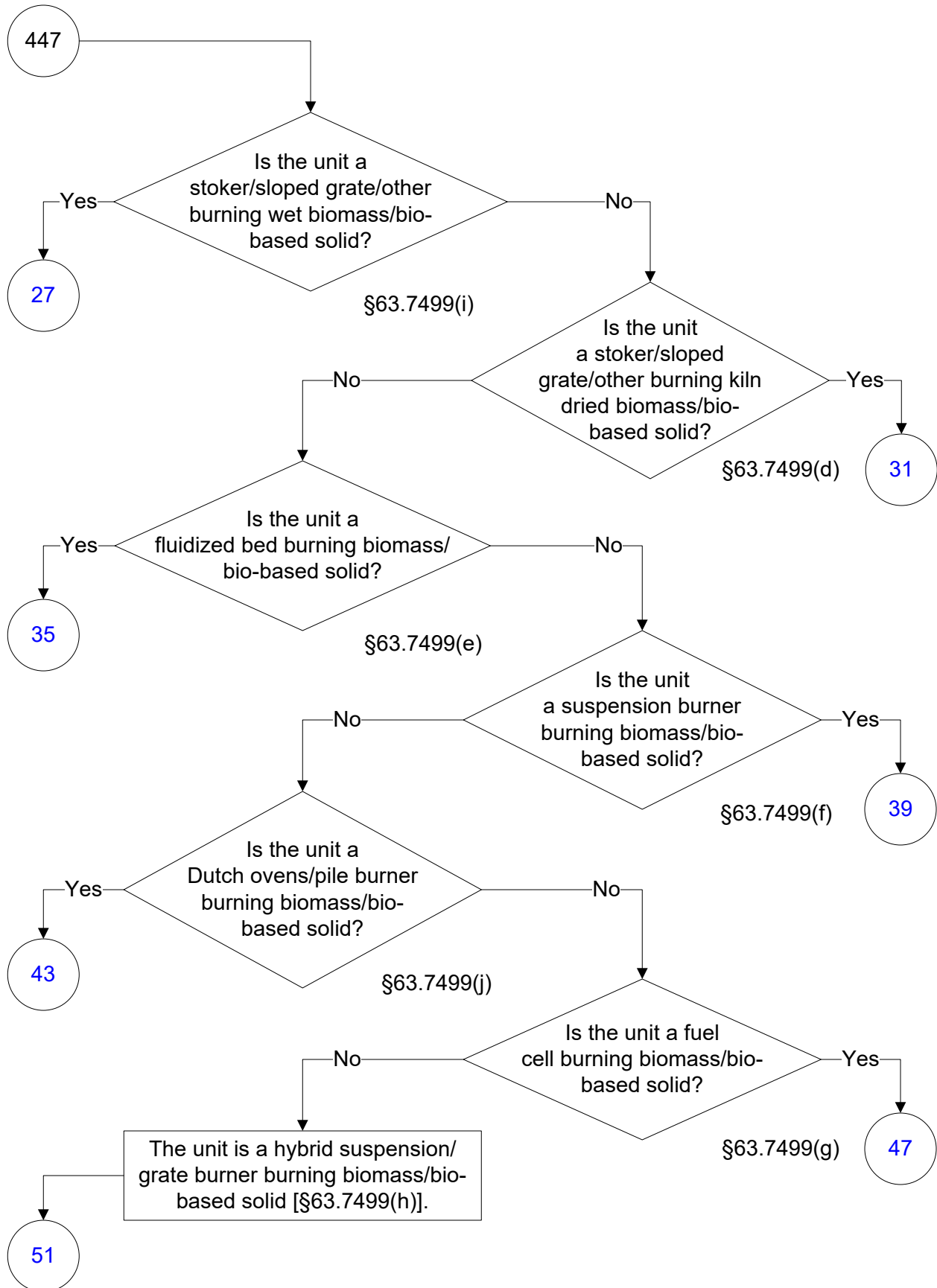

40 CFR Part 63, Subpart DDDDD (179 of 242)

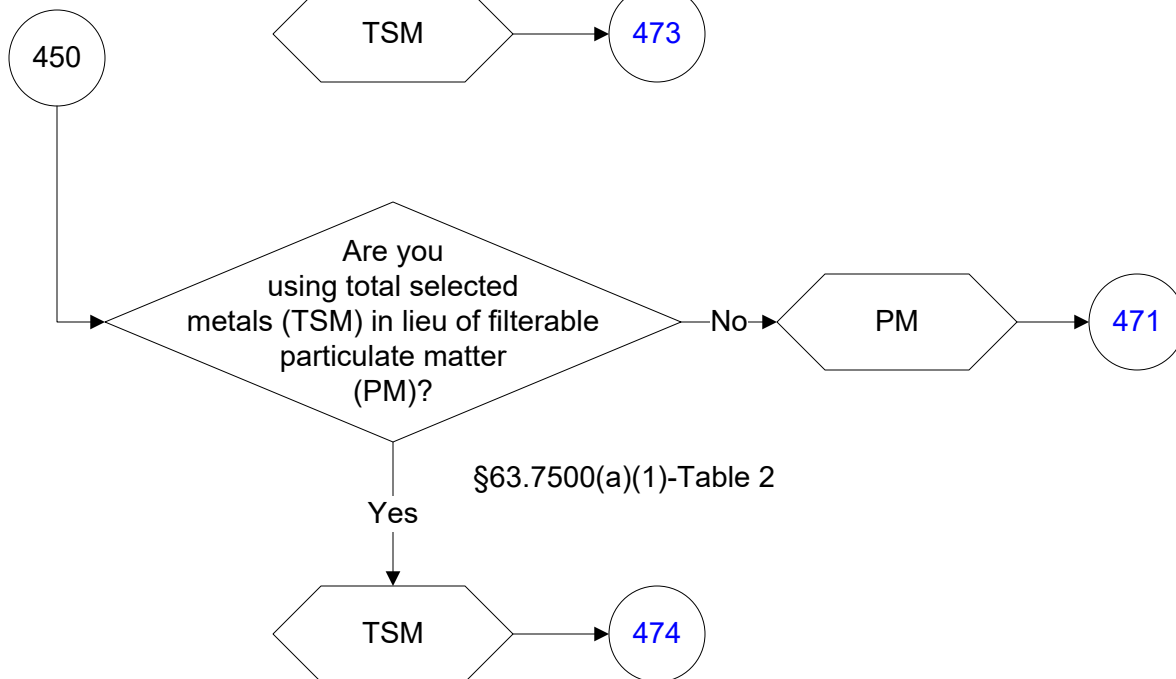
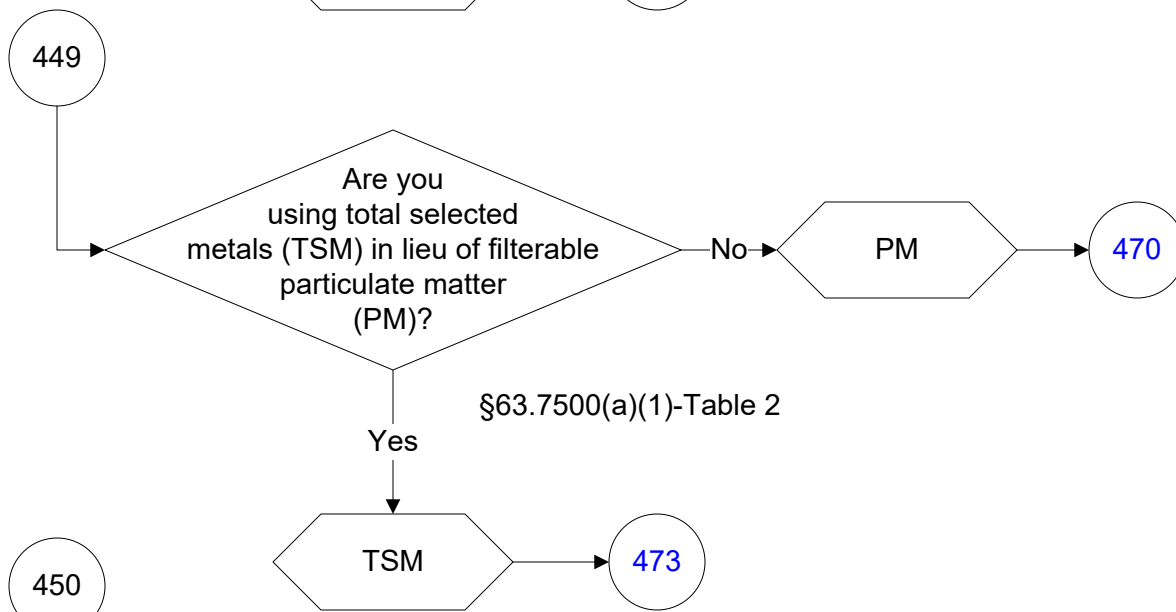
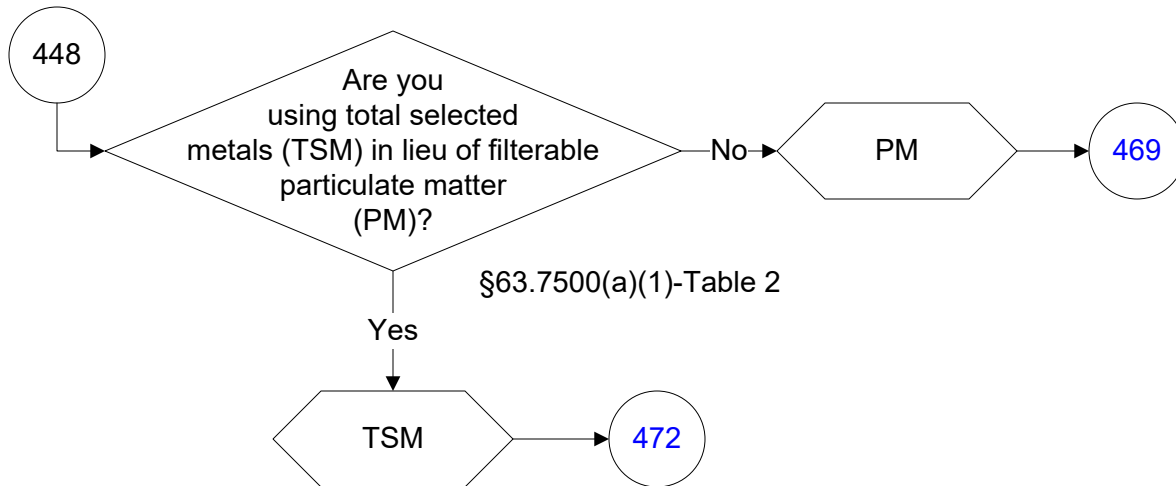

40 CFR Part 63, Subpart DDDDD (180 of 242)

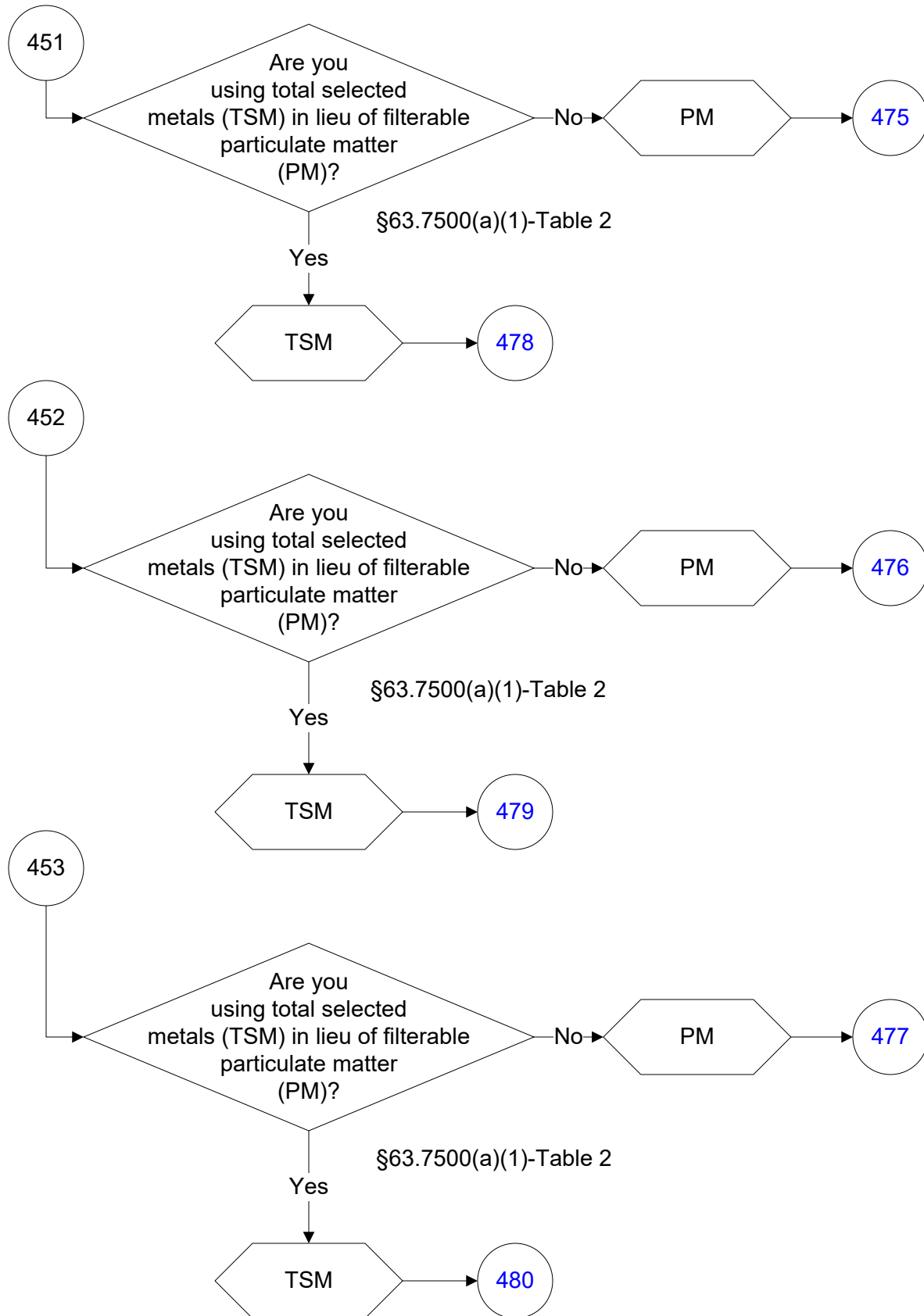

40 CFR Part 63, Subpart DDDDD (181 of 242)

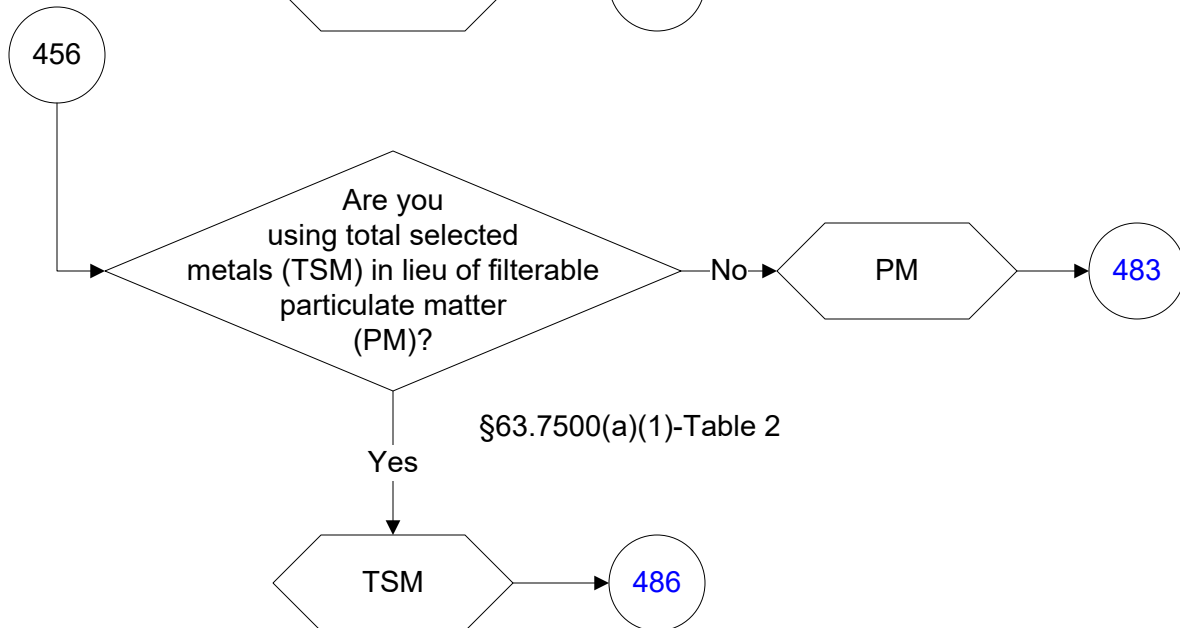
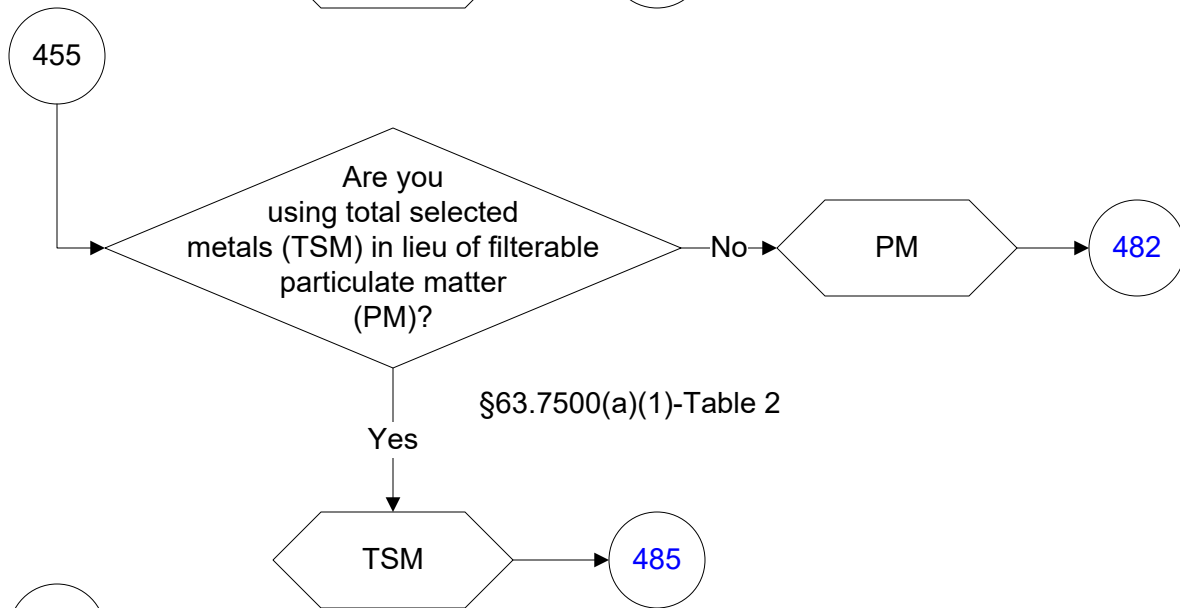
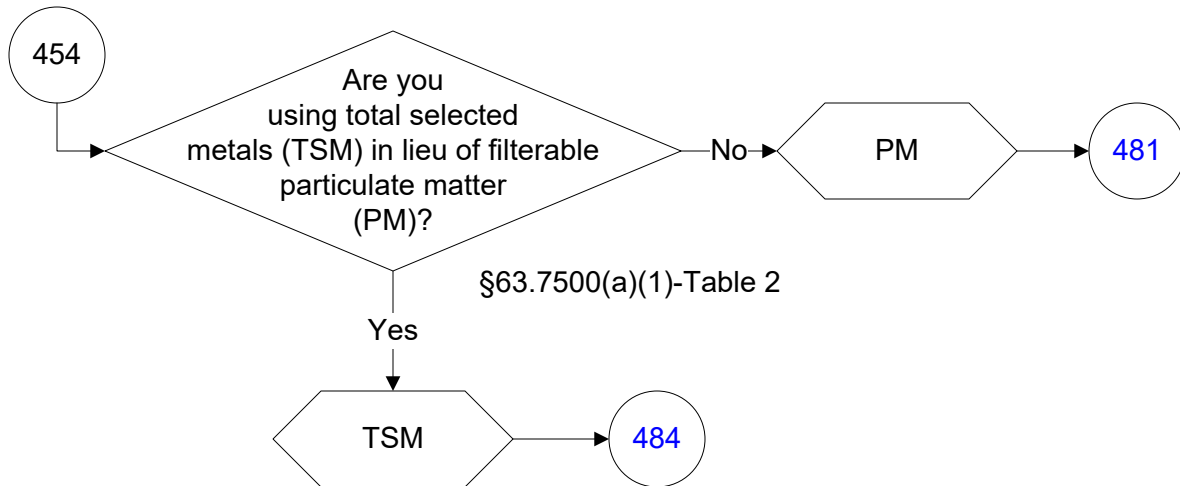

40 CFR Part 63, Subpart DDDDD (182 of 242)

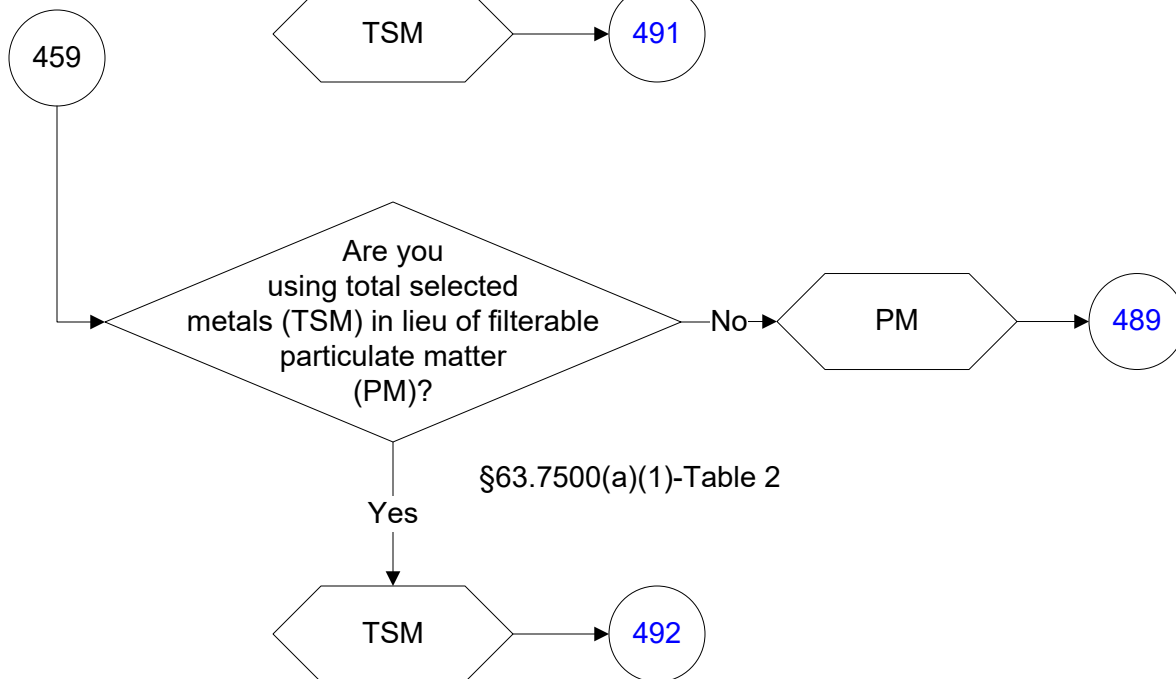
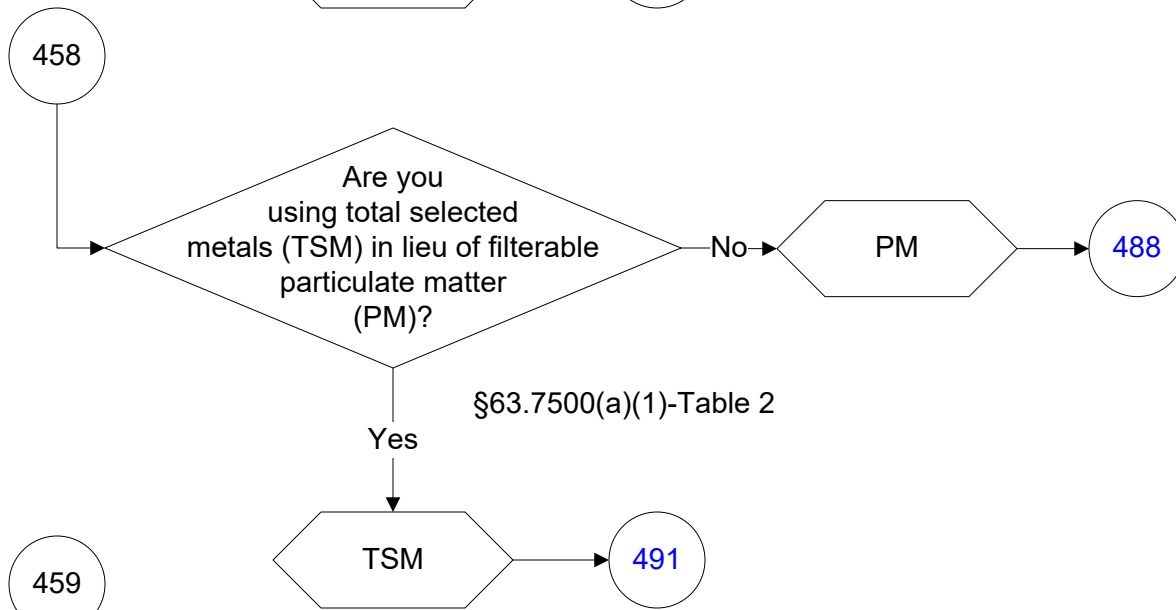
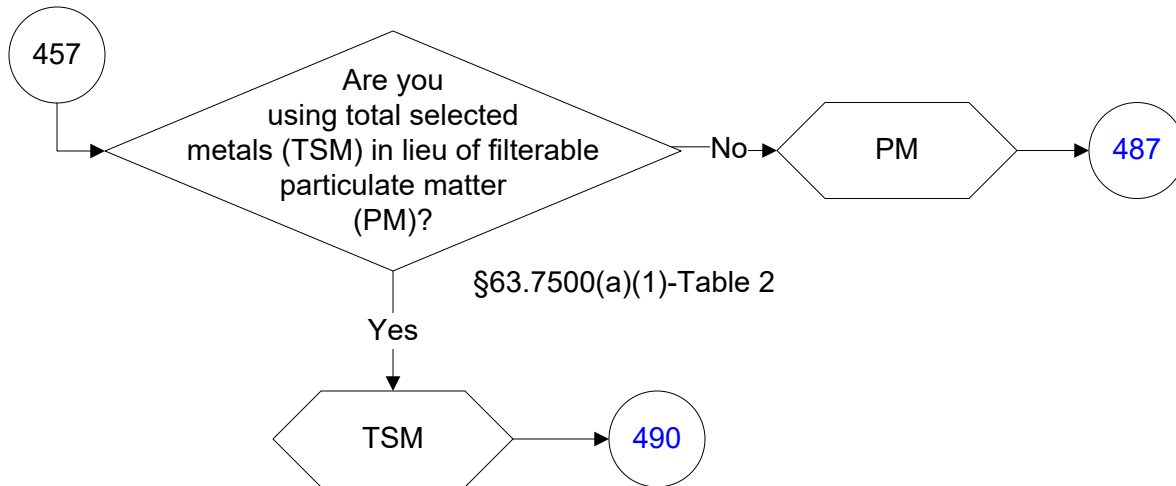

40 CFR Part 63, Subpart DDDDD (183 of 242)

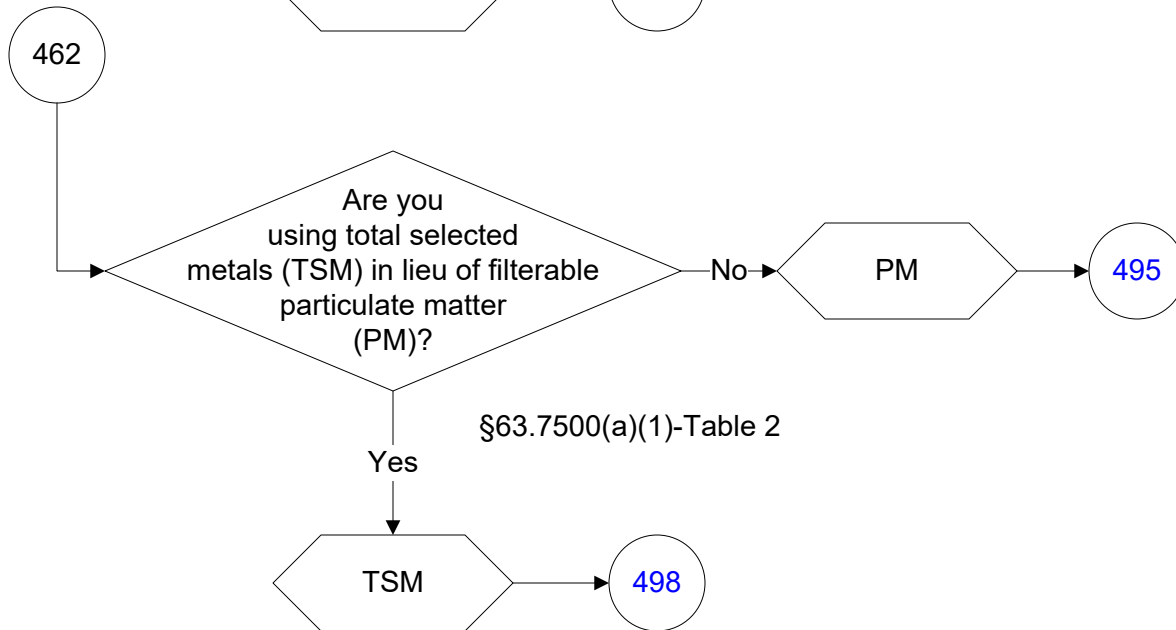
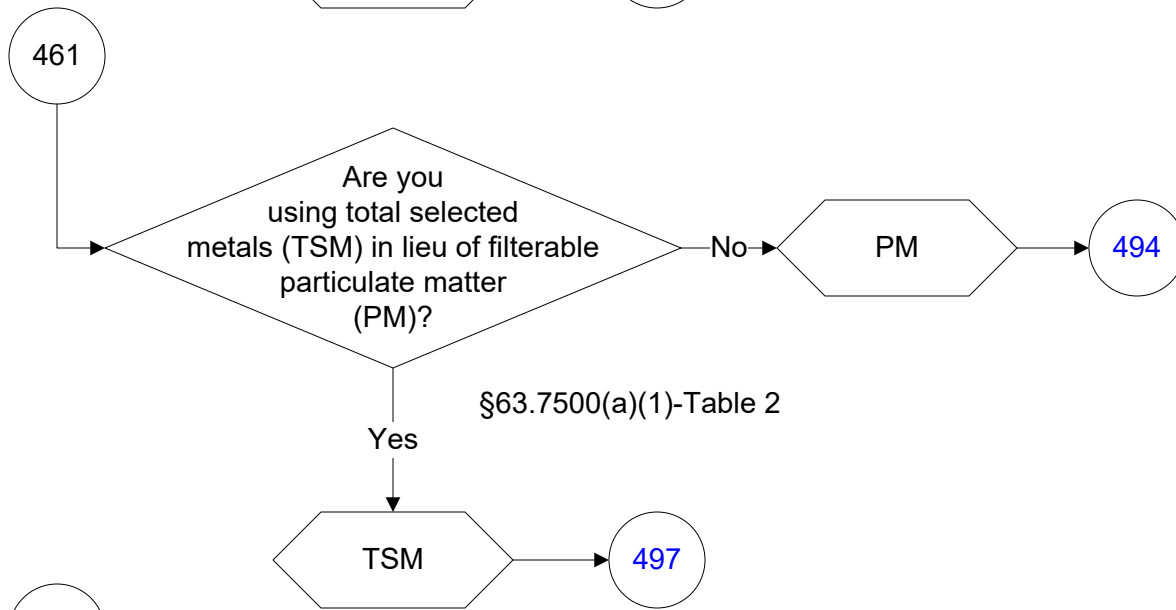
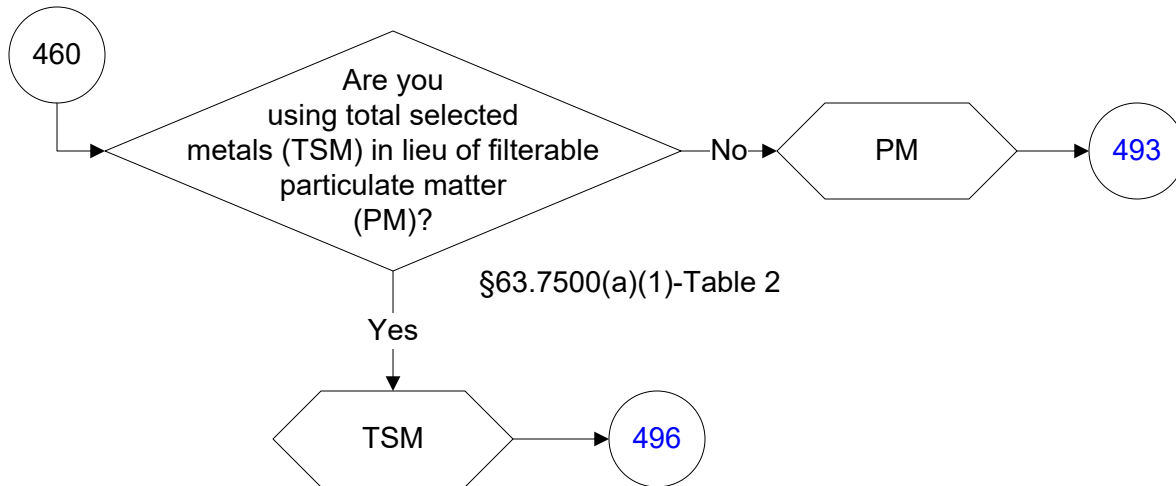

40 CFR Part 63, Subpart DDDDD (184 of 242)

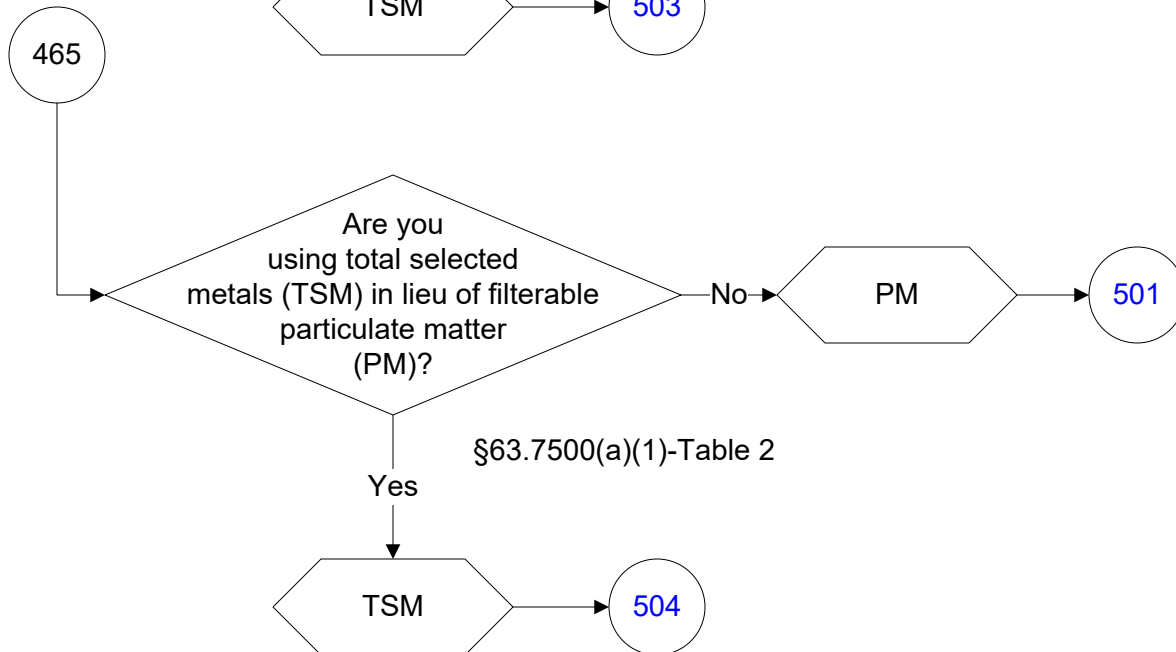
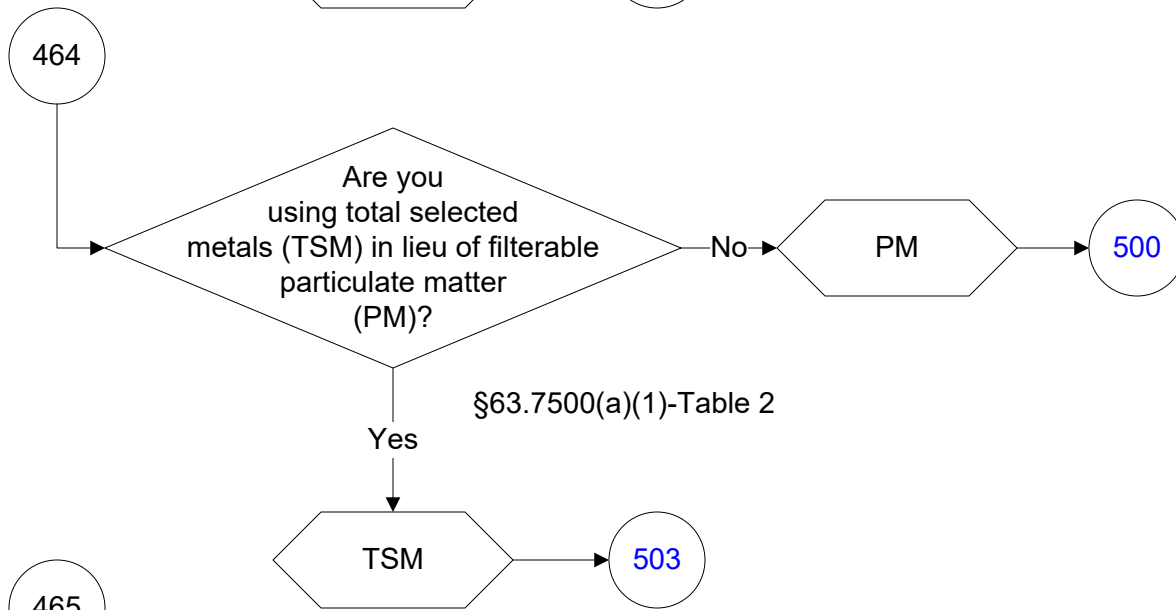
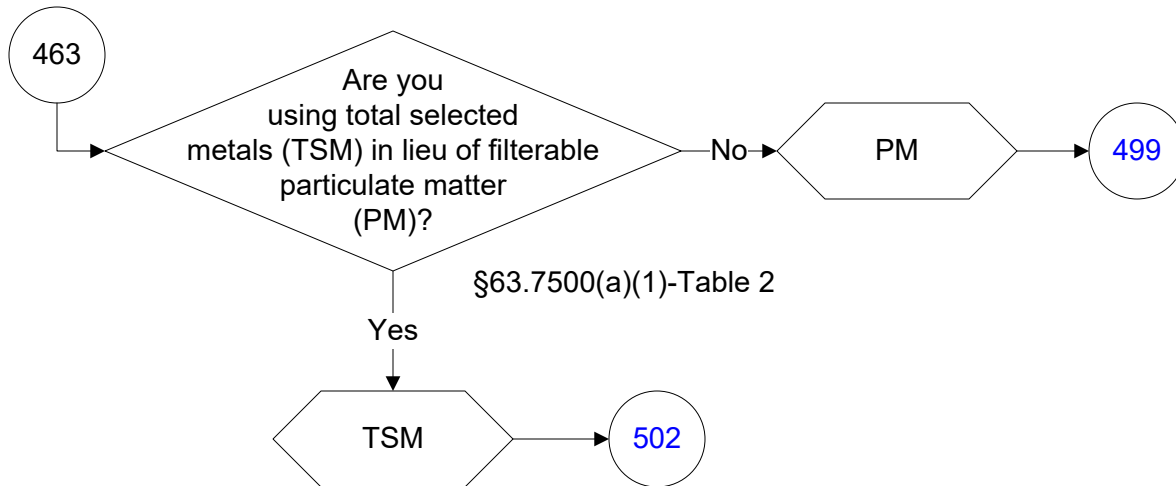

40 CFR Part 63, Subpart DDDDD (185 of 242)

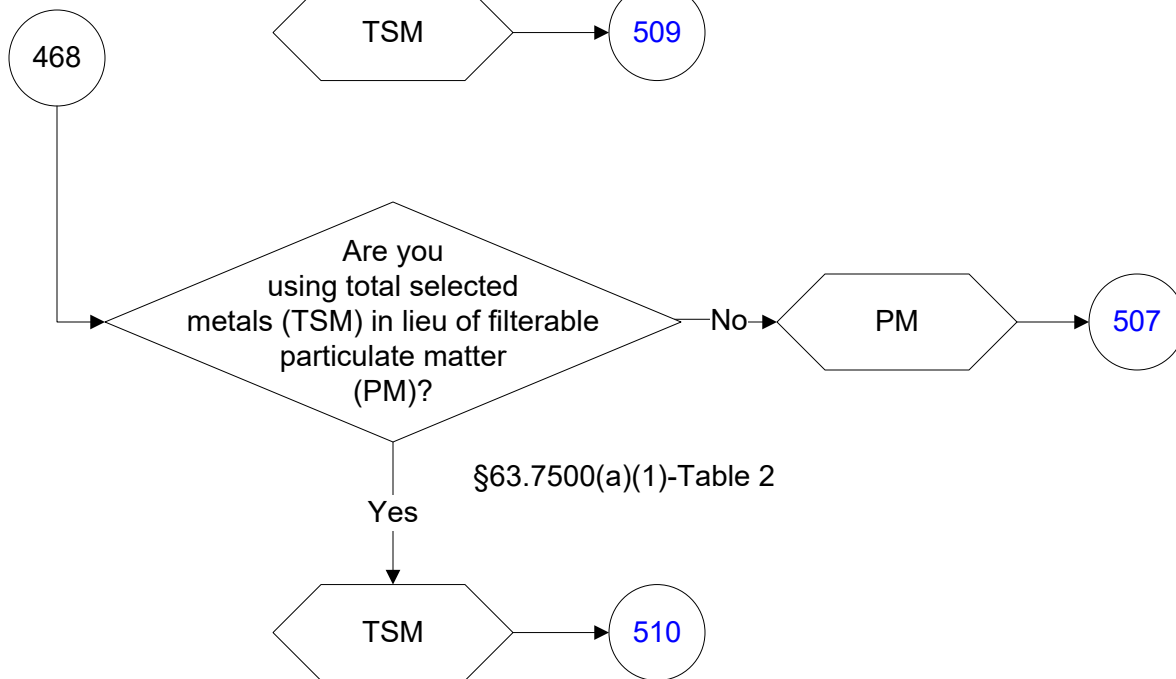
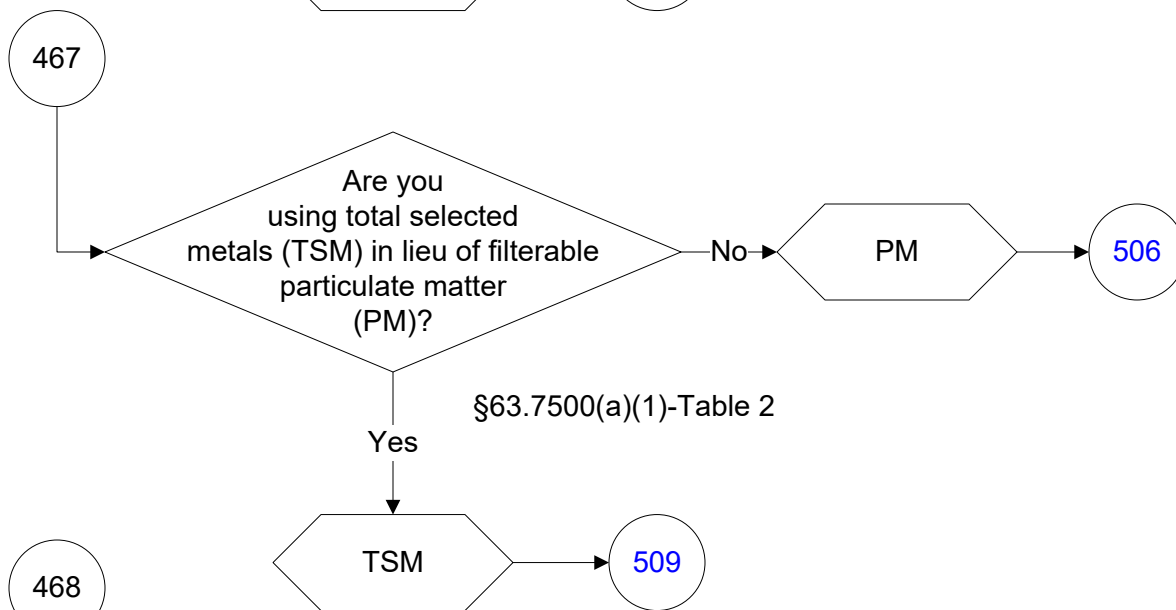
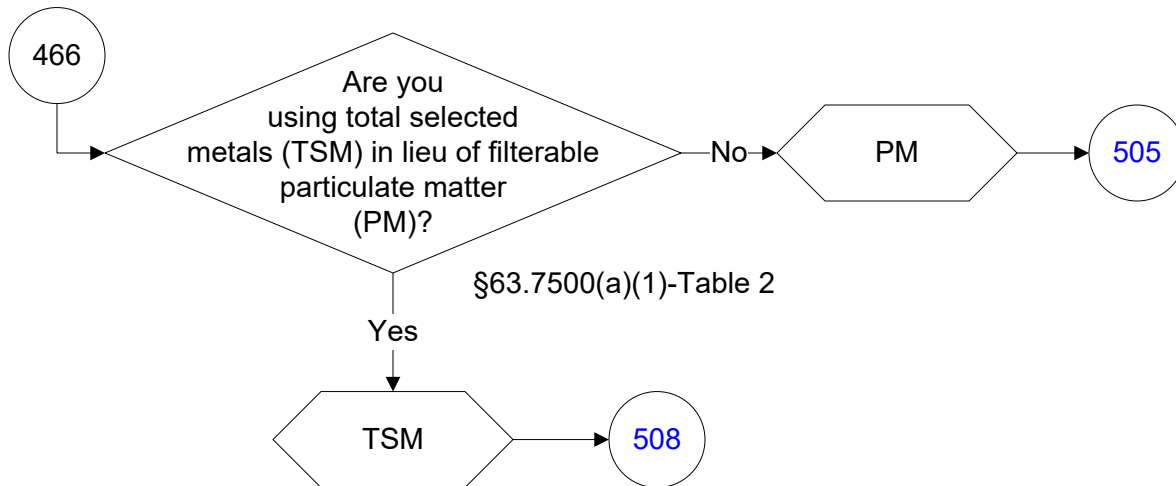

40 CFR Part 63, Subpart DDDDD (186 of 242)

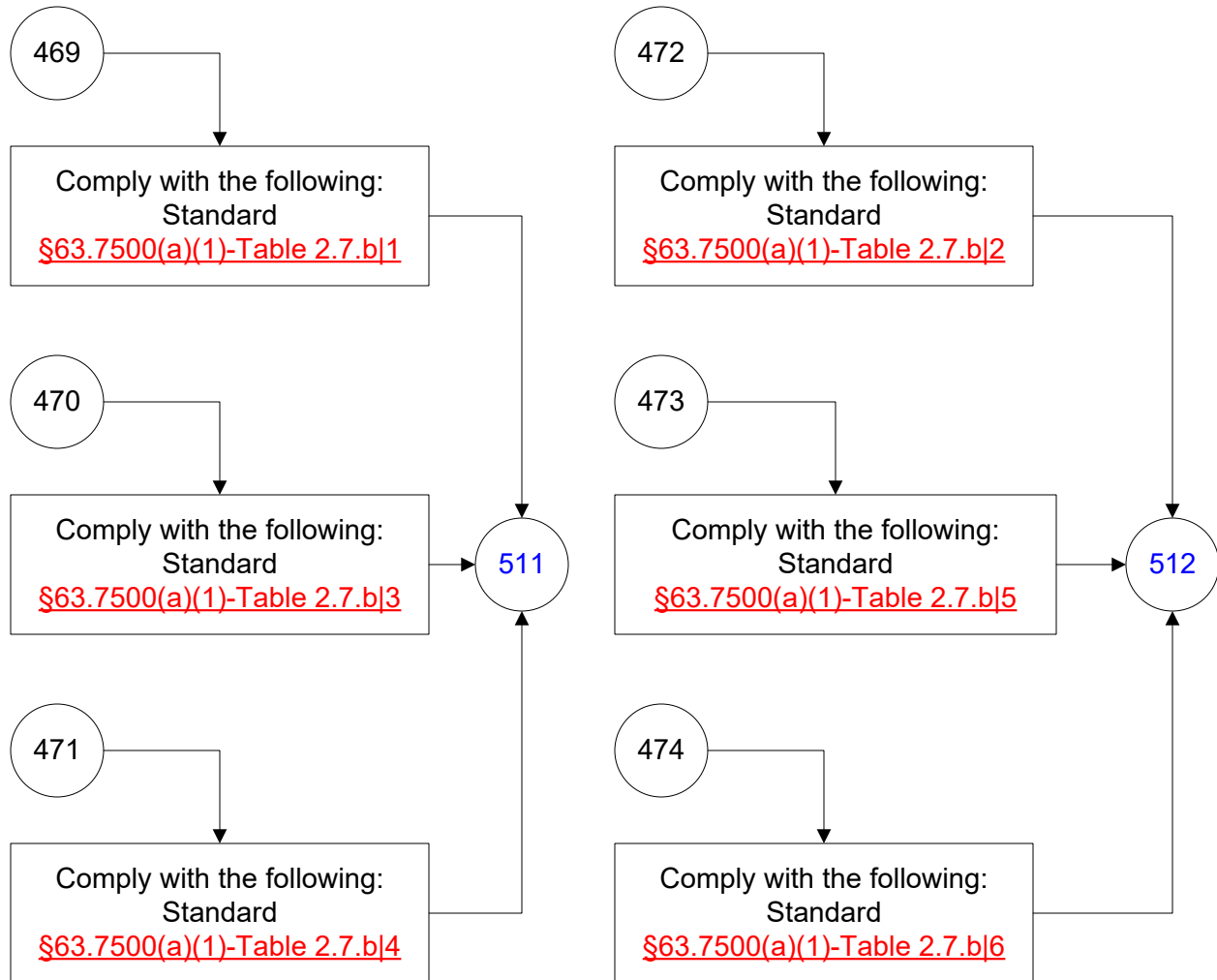

40 CFR Part 63, Subpart DDDDD (187 of 242)

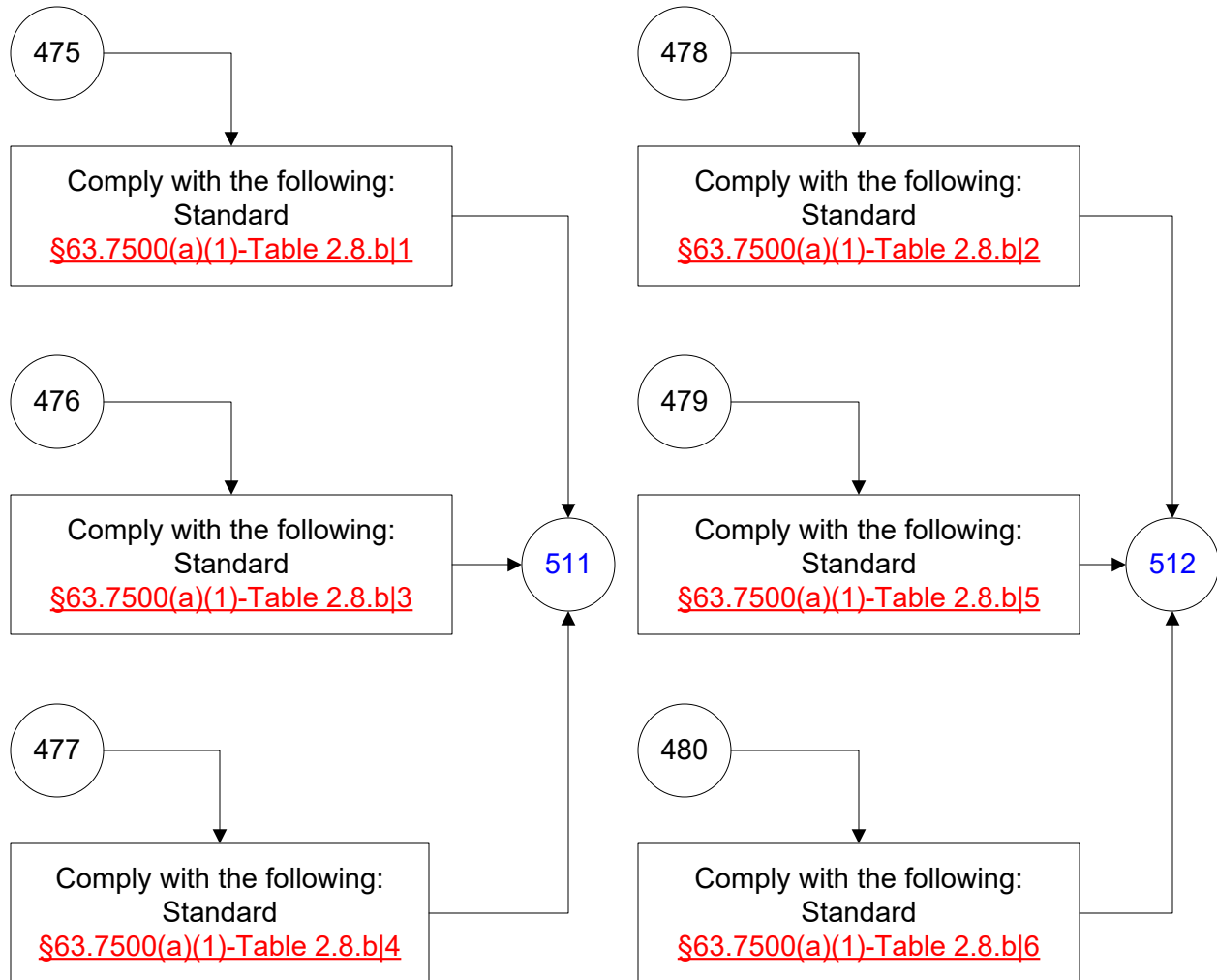

40 CFR Part 63, Subpart DDDDD (188 of 242)

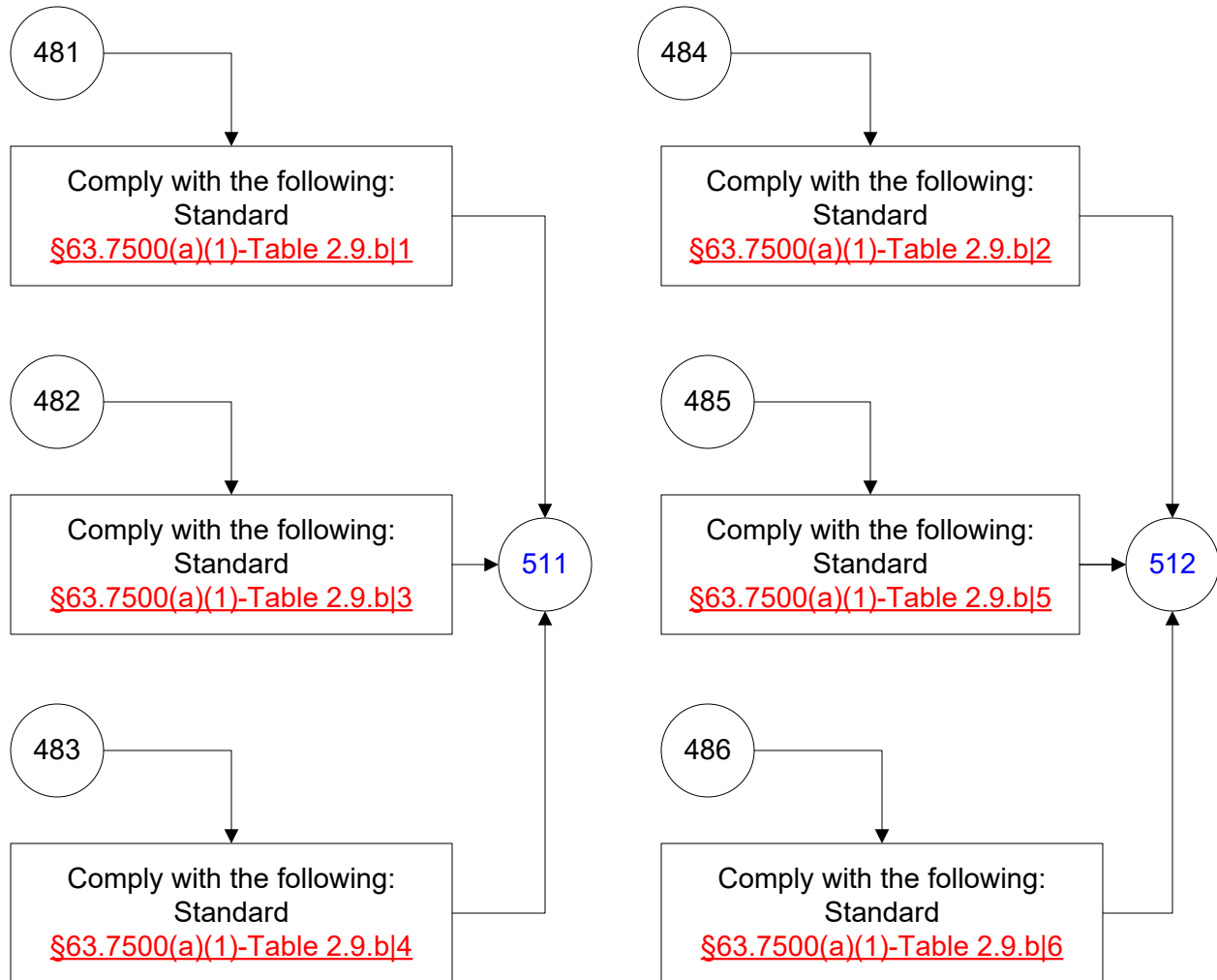

40 CFR Part 63, Subpart DDDDD (189 of 242)

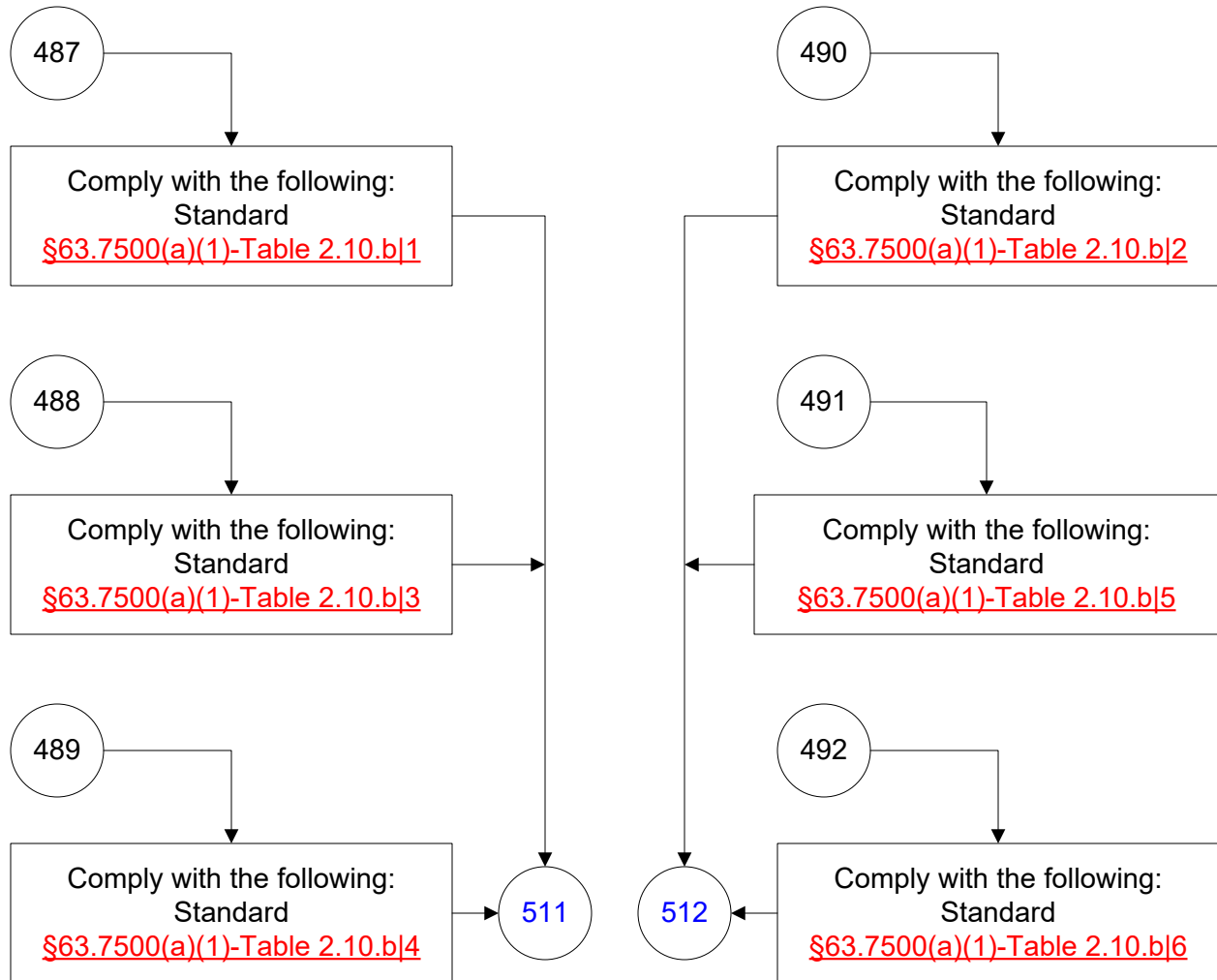

40 CFR Part 63, Subpart DDDDD (190 of 242)

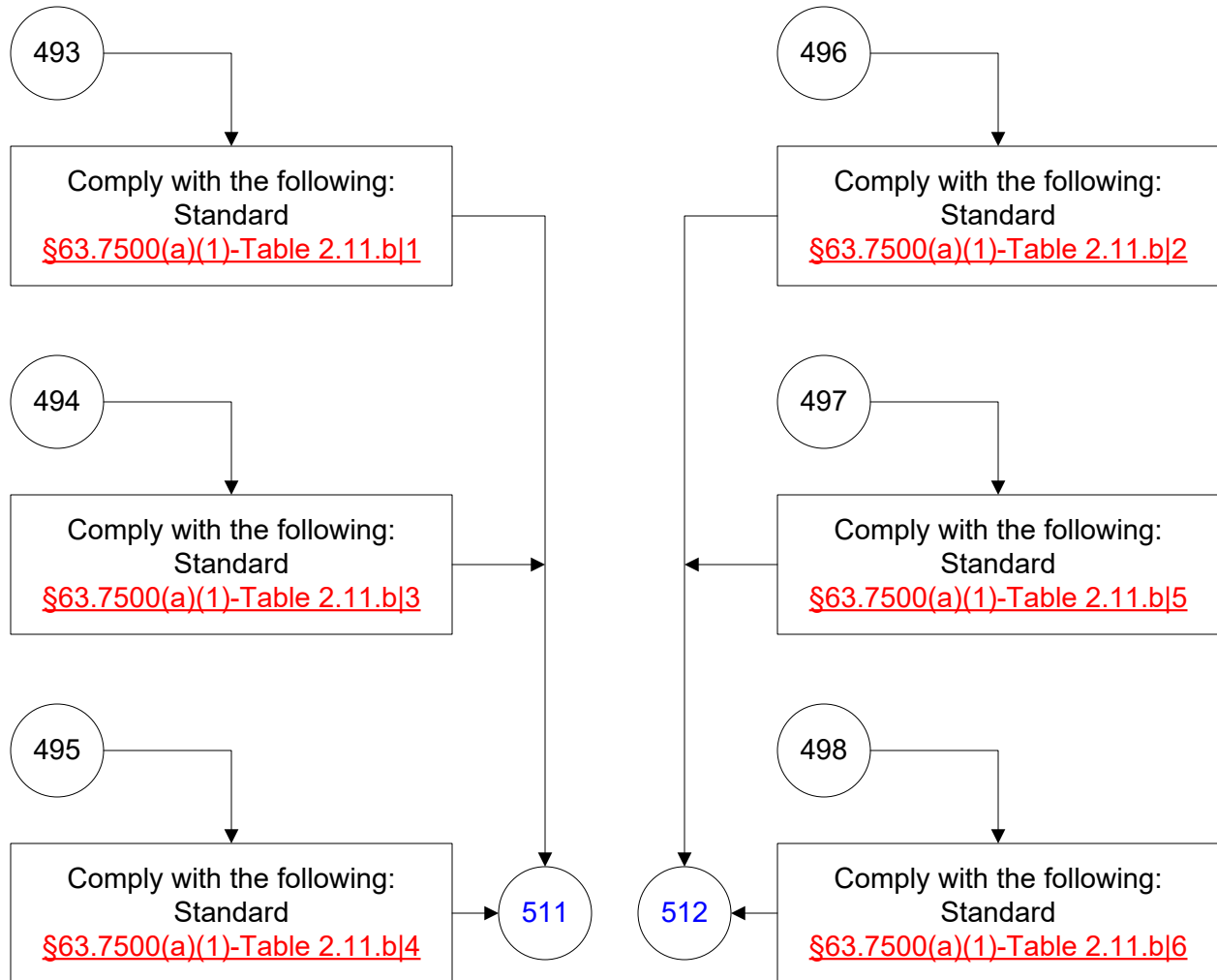

40 CFR Part 63, Subpart DDDDD (191 of 242)

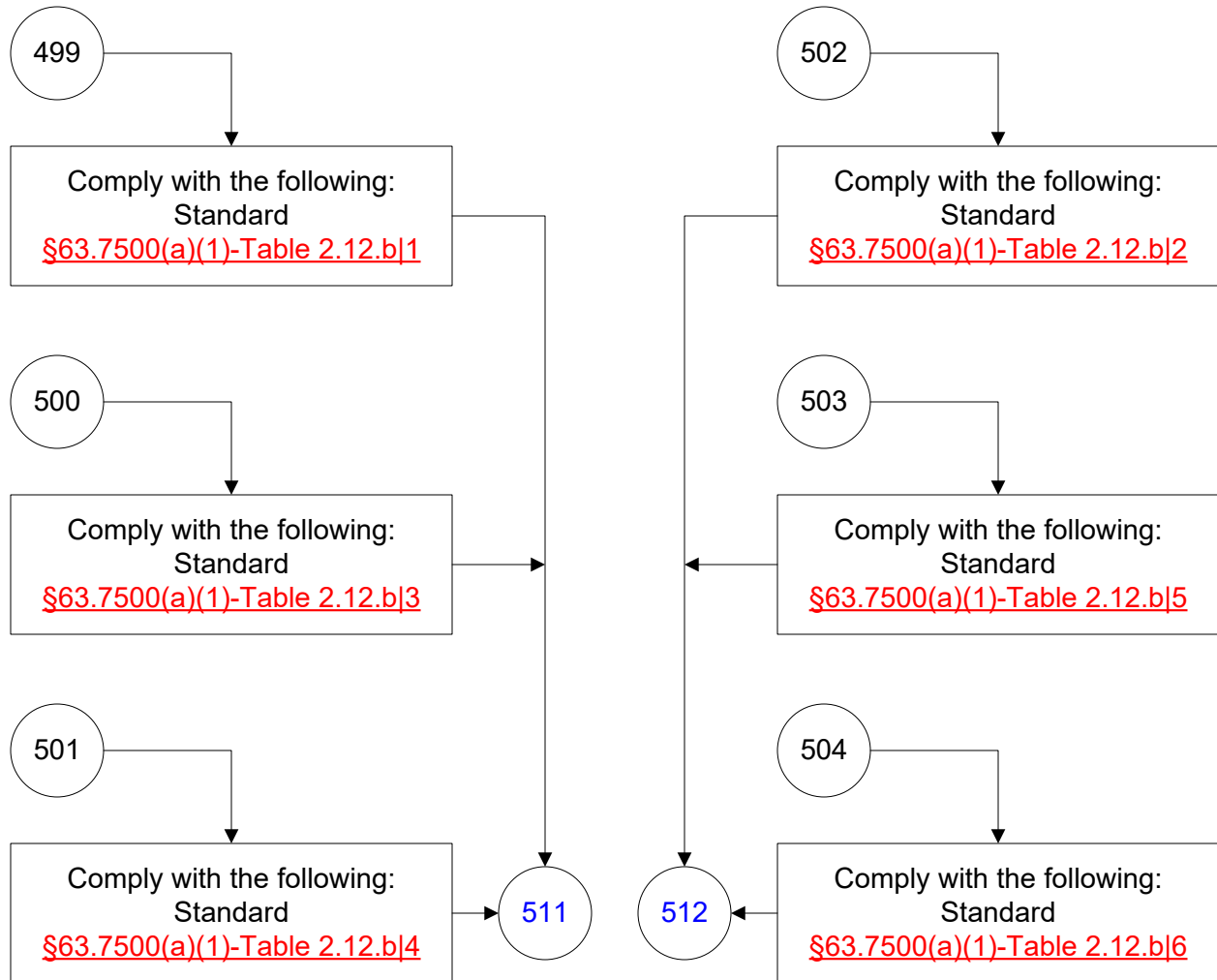

40 CFR Part 63, Subpart DDDDD (192 of 242)

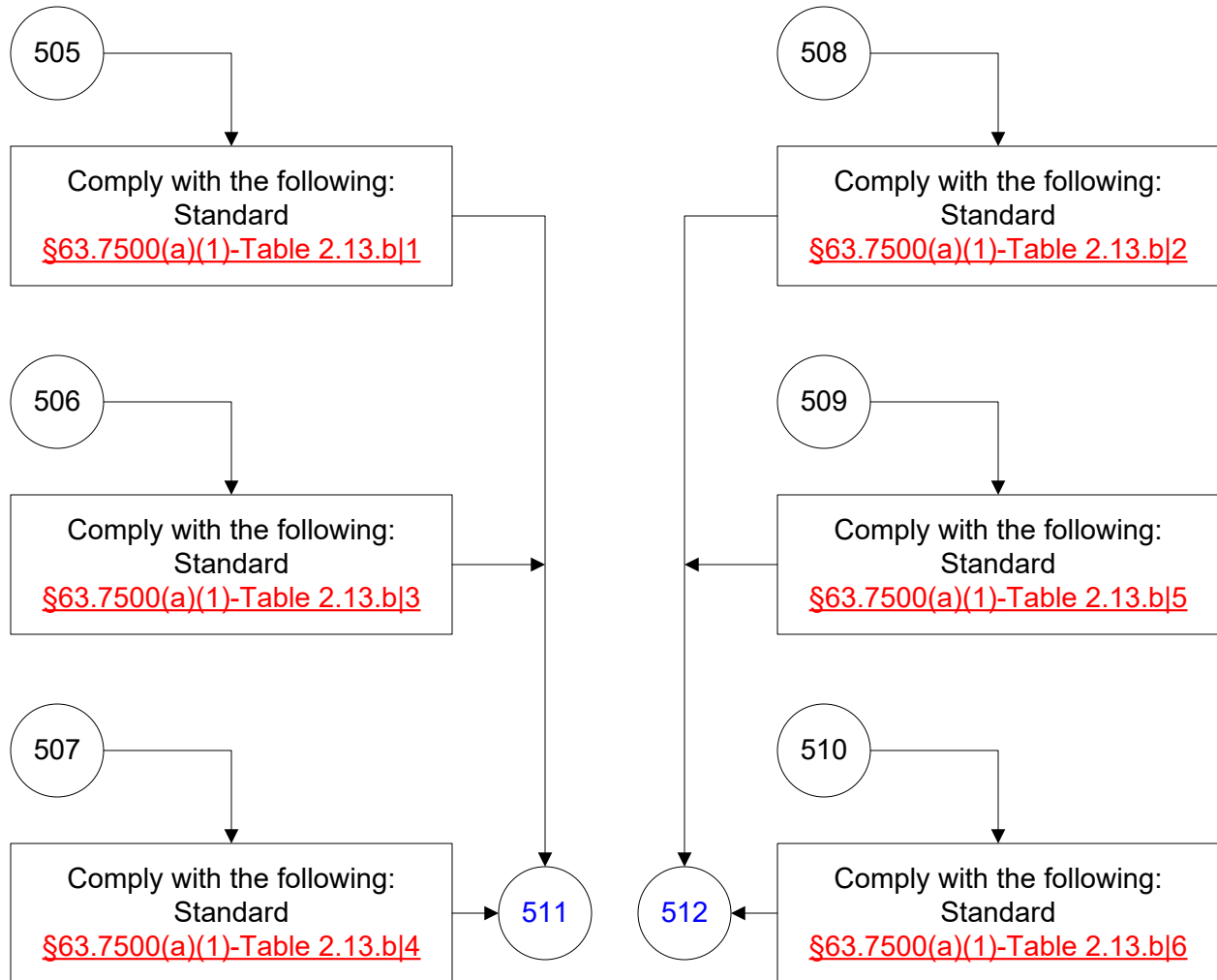

40 CFR Part 63, Subpart DDDDD
(193 of 242)

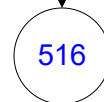
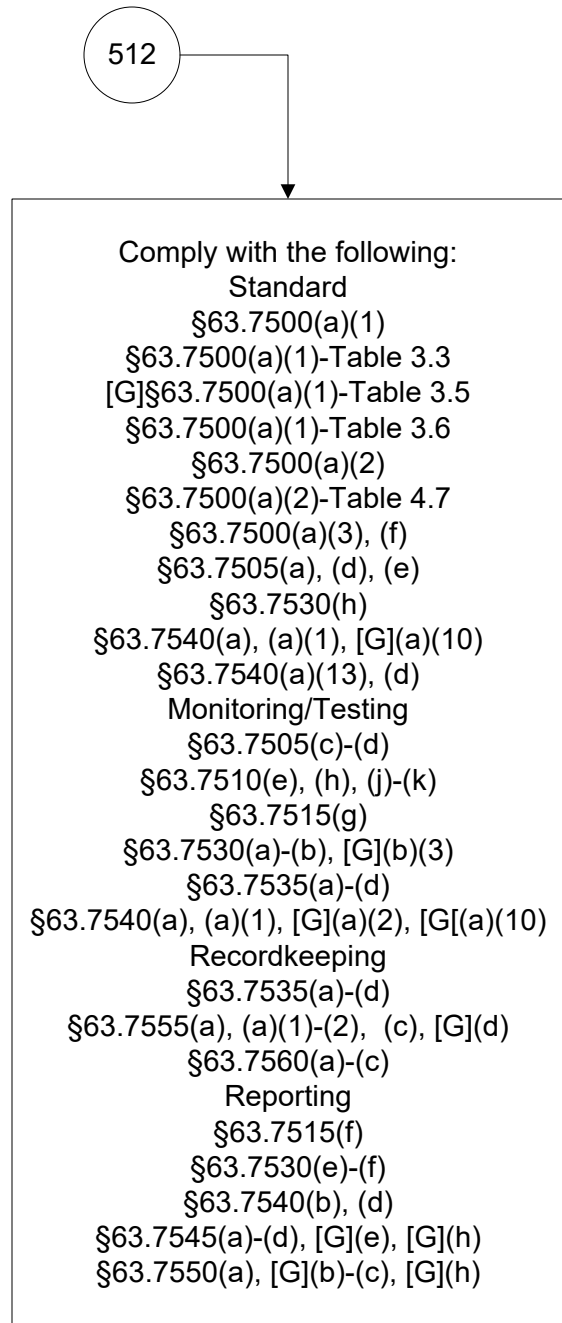
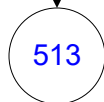
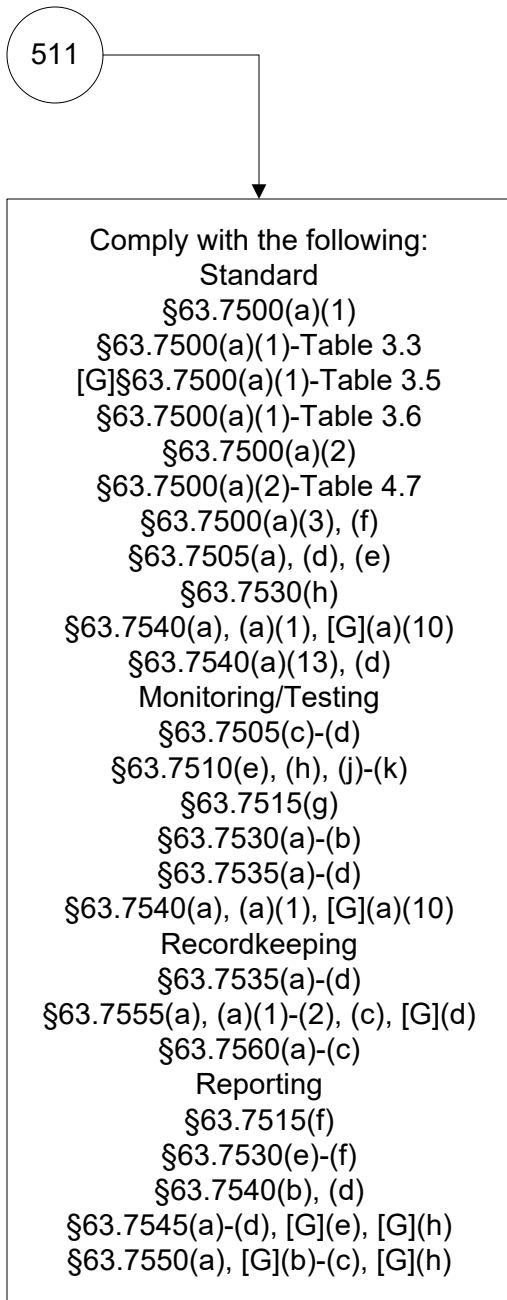

40 CFR Part 63, Subpart DDDDD (194 of 242)

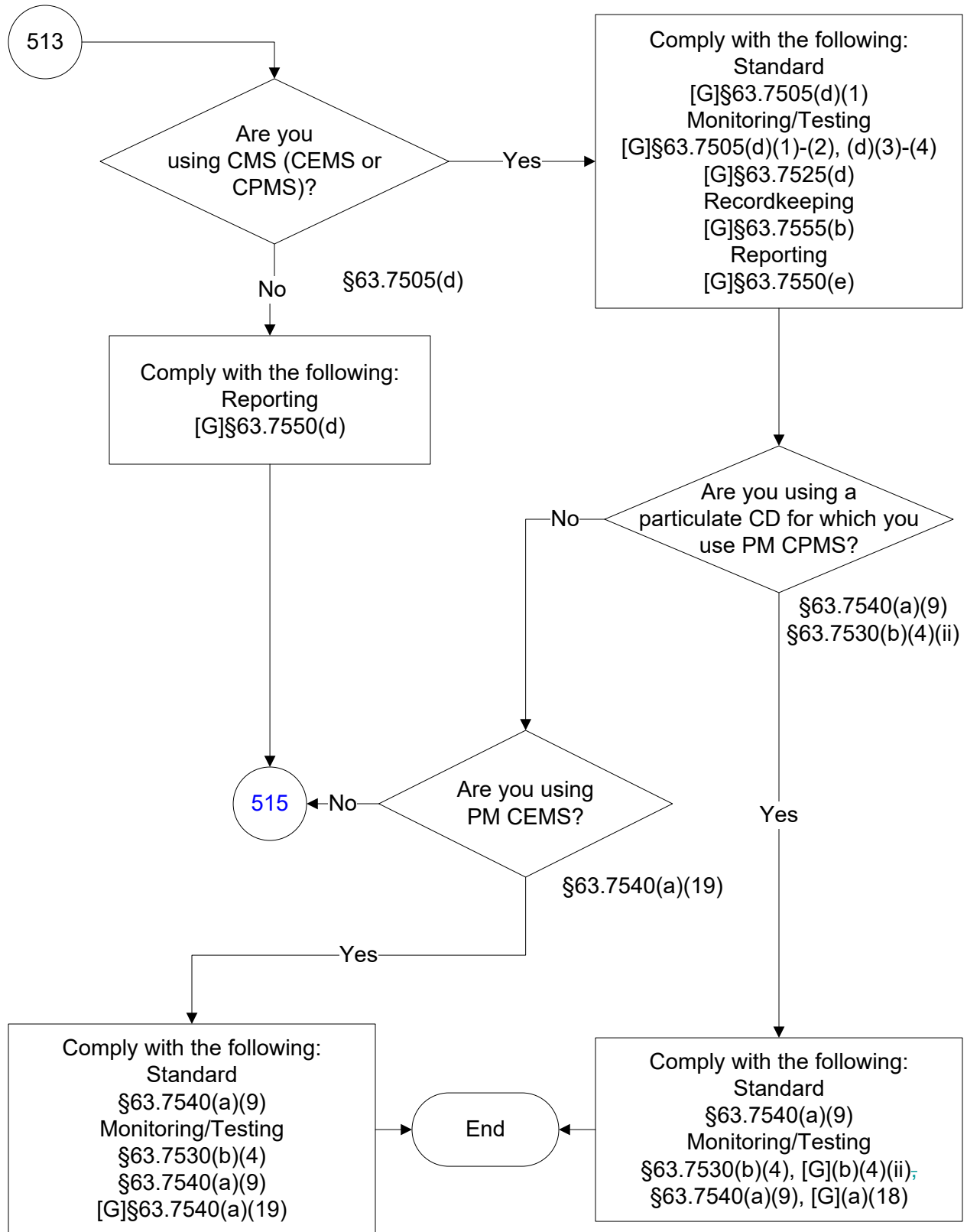

40 CFR Part 63, Subpart DDDDD (195 of 242)

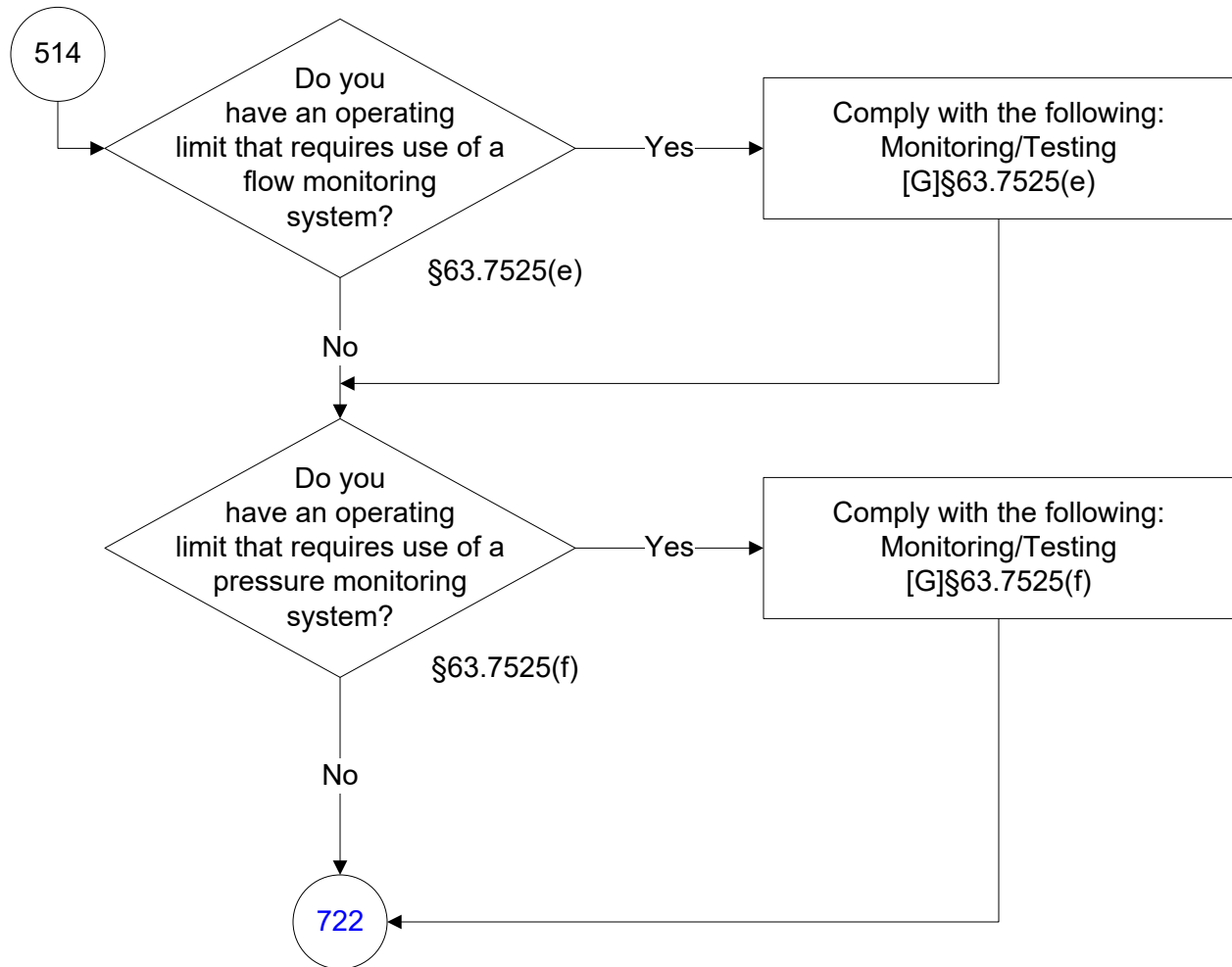

40 CFR Part 63, Subpart DDDDD (196 of 242)

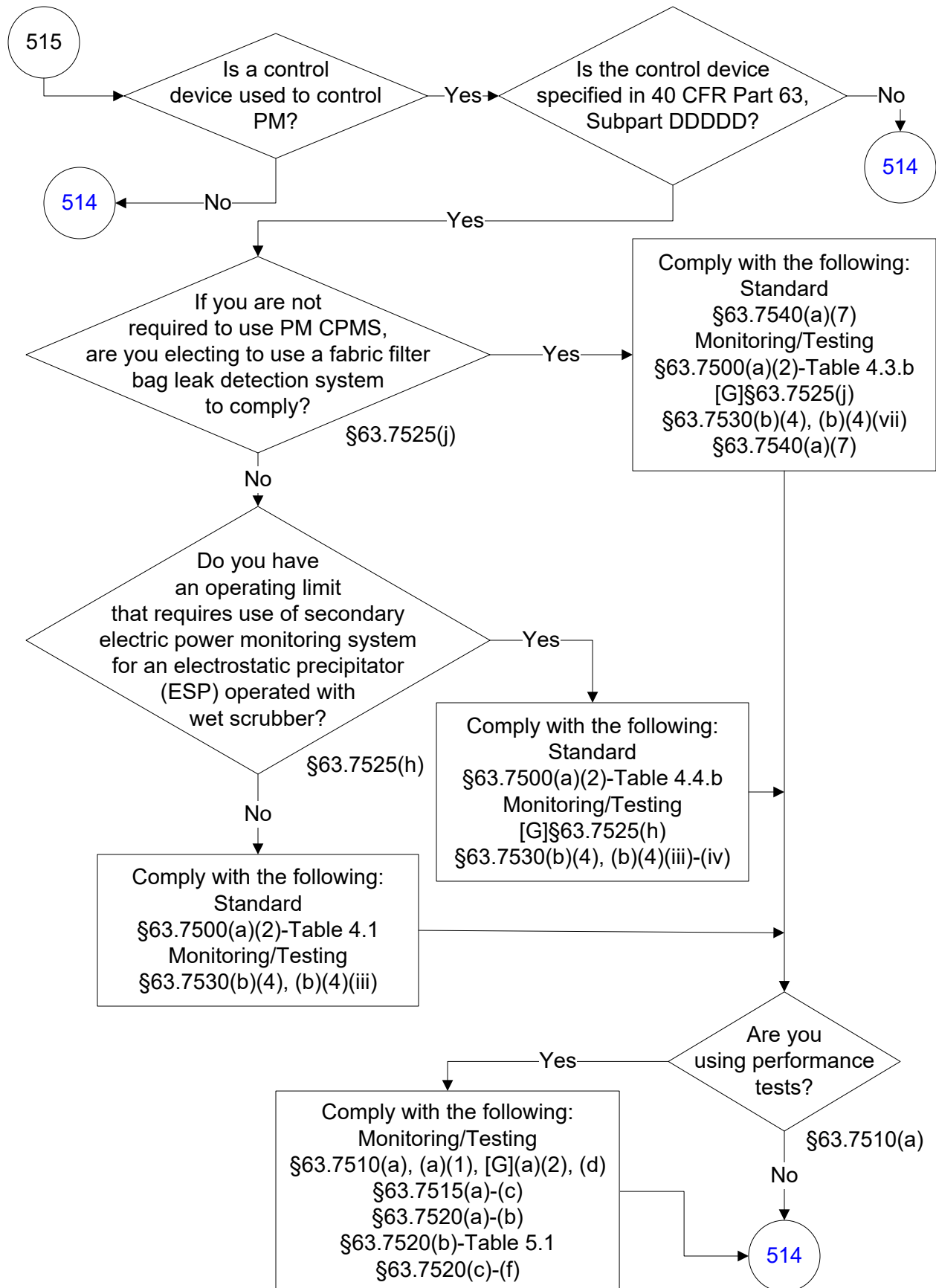

**40 CFR Part 63, Subpart DDDDD
(197 of 242)**

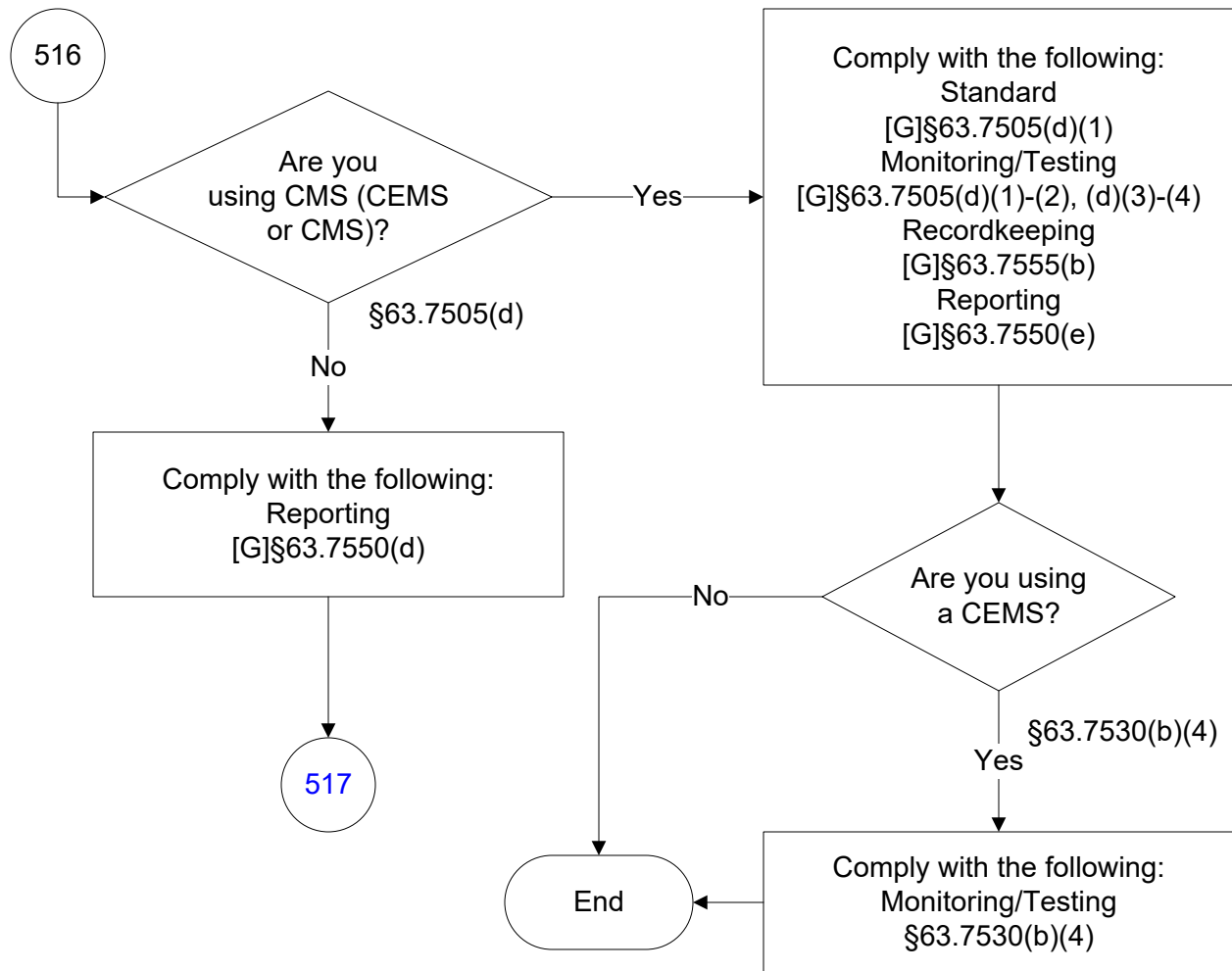

40 CFR Part 63, Subpart DDDDD (198 of 242)

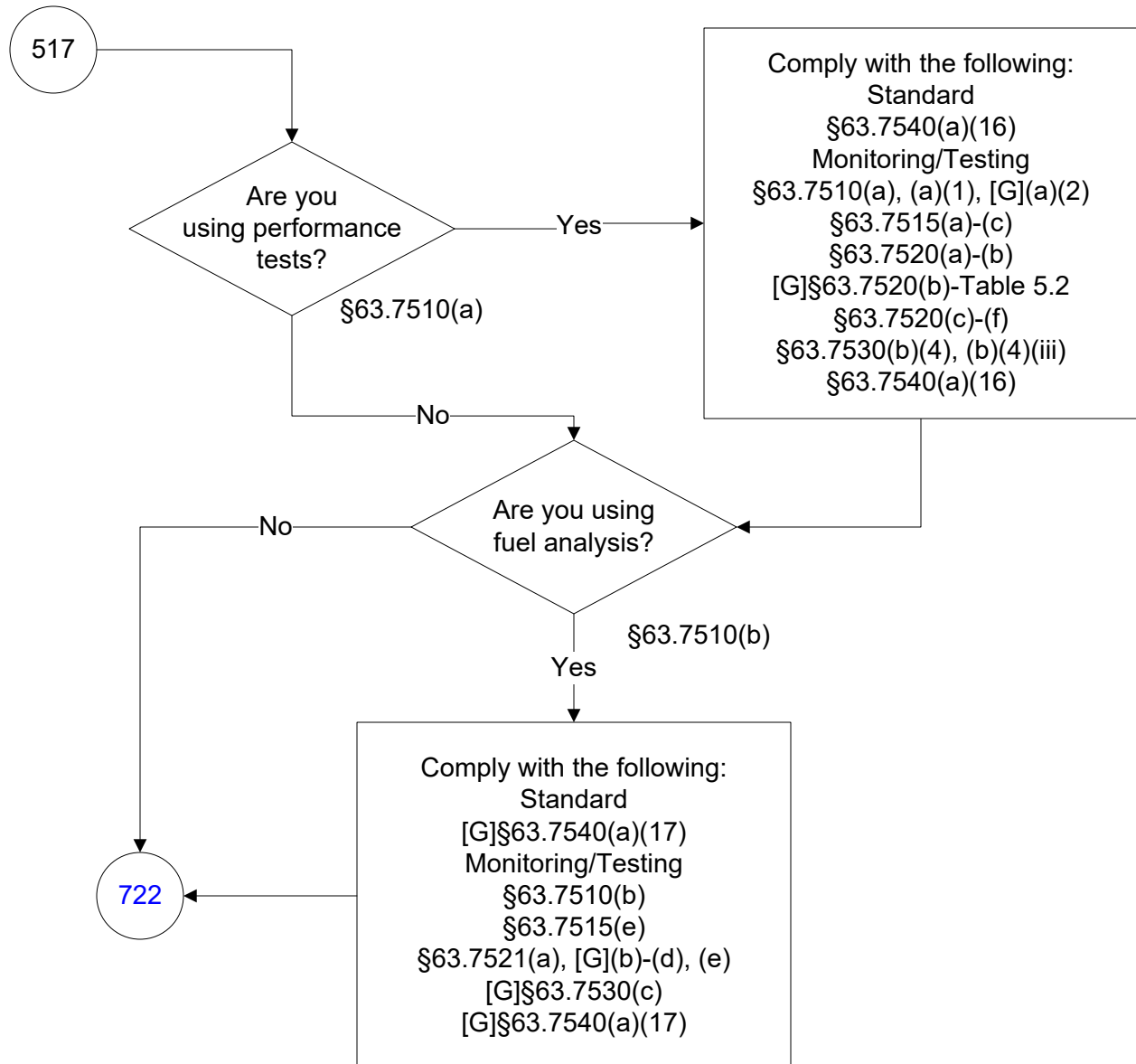

40 CFR Part 63, Subpart DDDDD (199 of 242)

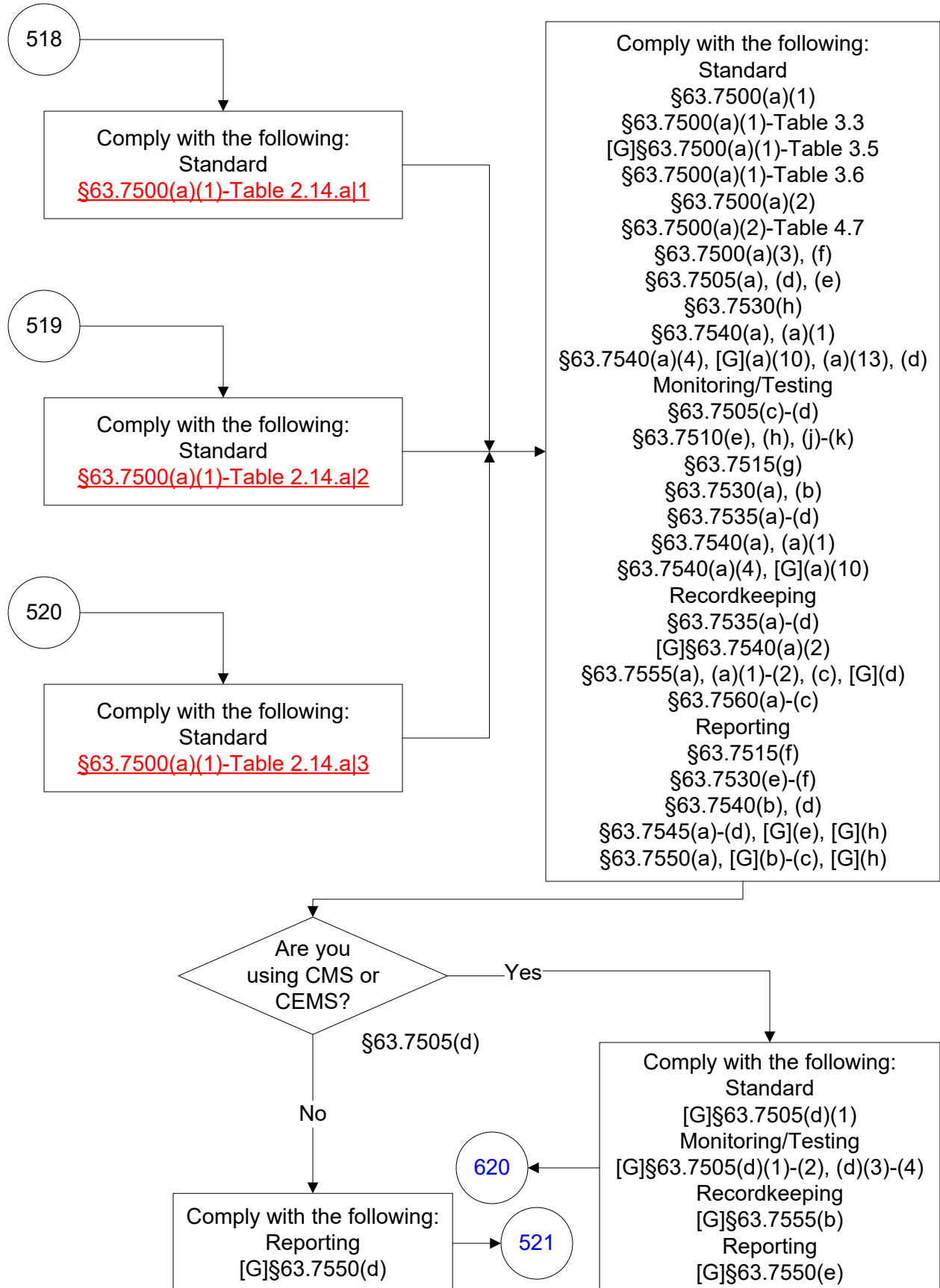

40 CFR Part 63, Subpart DDDDD (200 of 242)

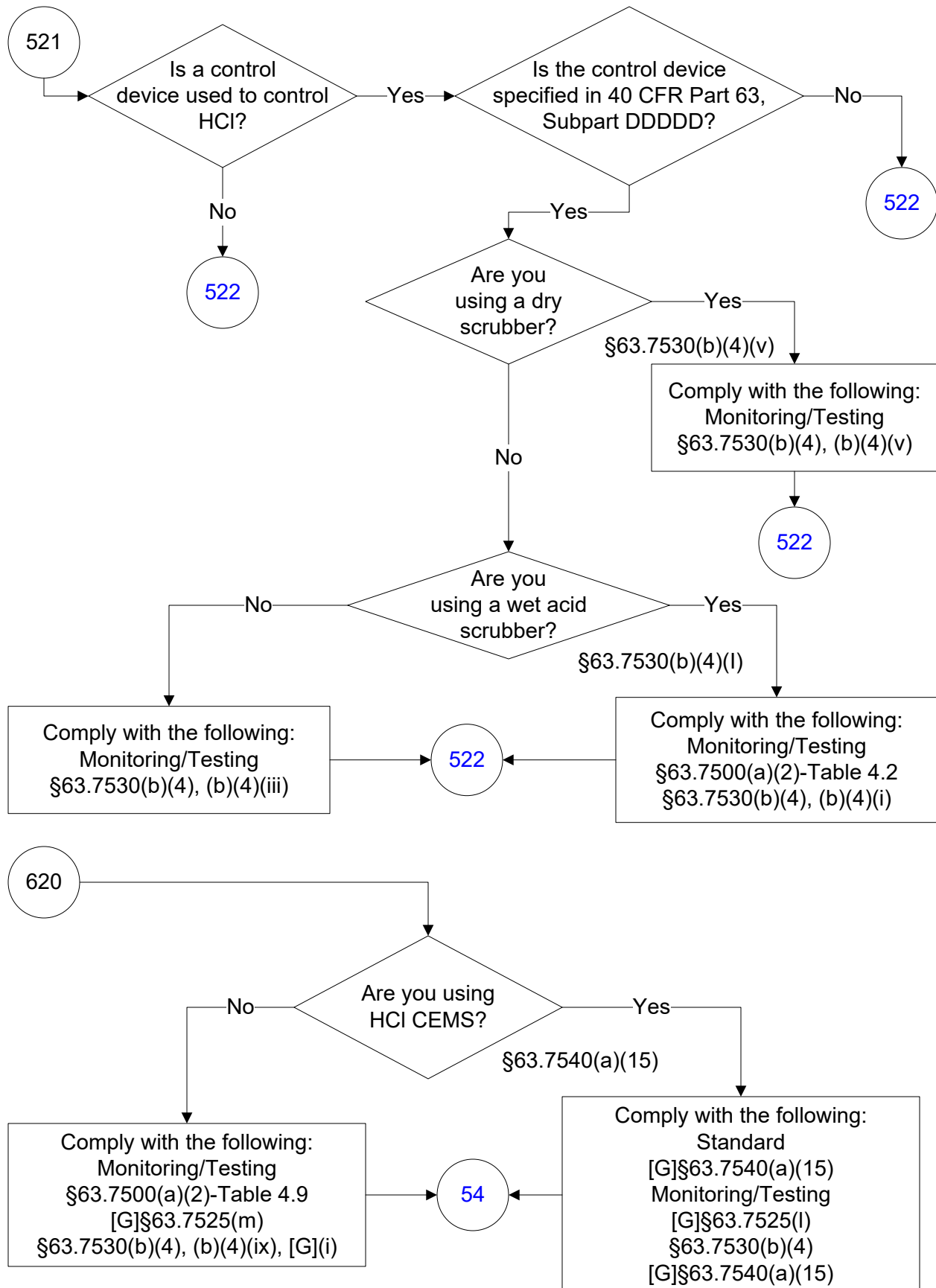

40 CFR Part 63, Subpart DDDDD (201 of 242)

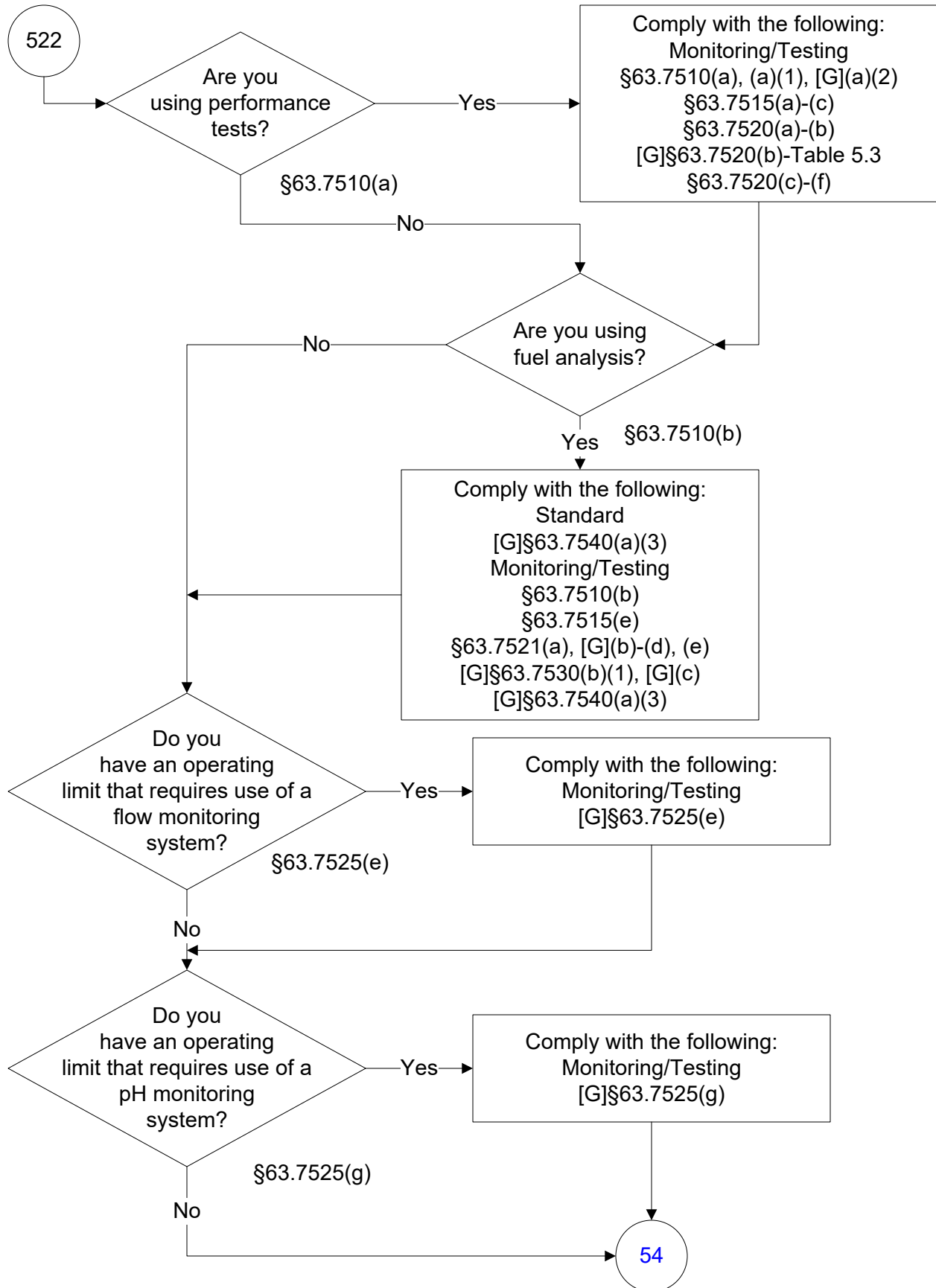

40 CFR Part 63, Subpart DDDDD (202 of 242)

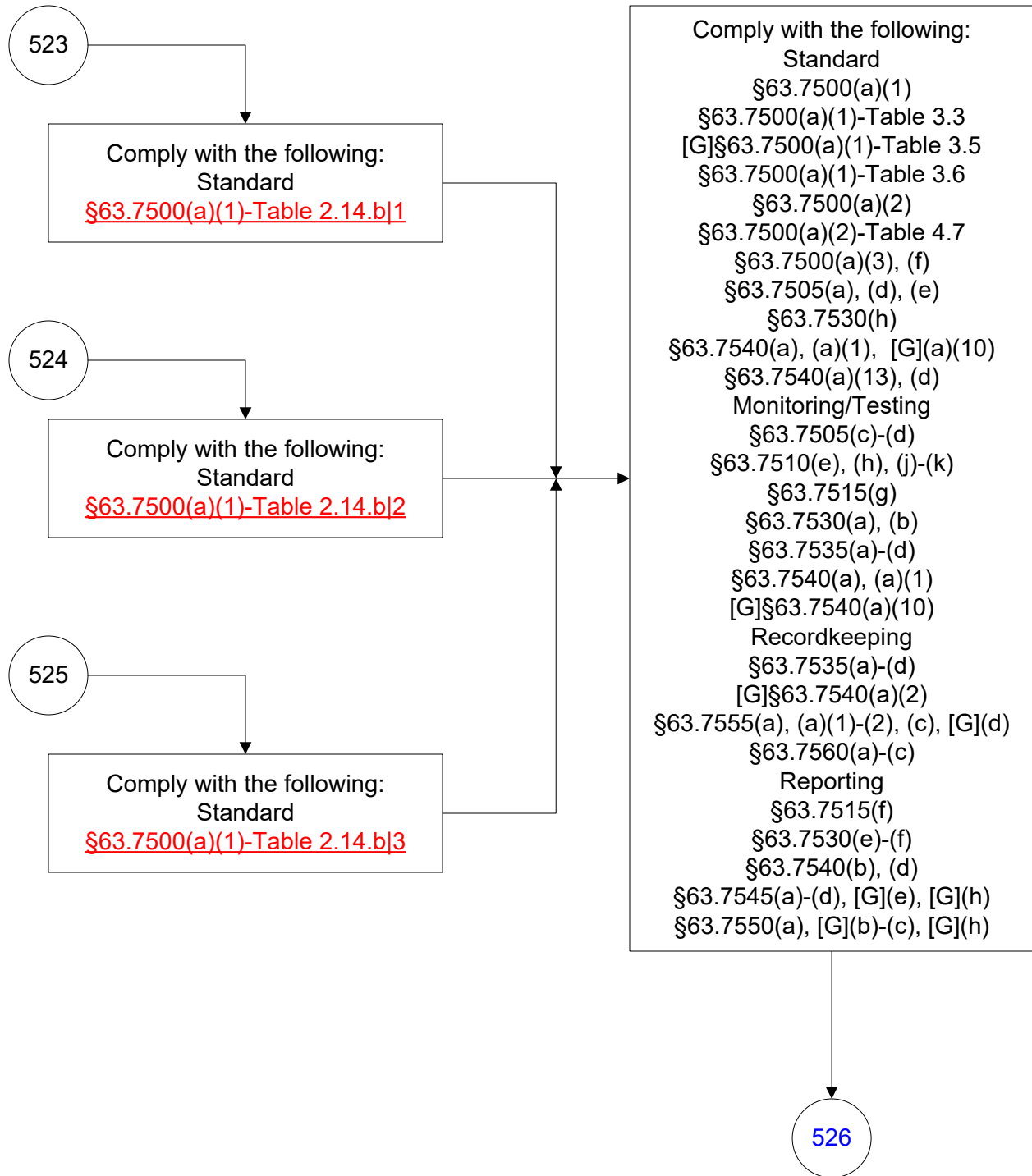

40 CFR Part 63, Subpart DDDDD (203 of 242)

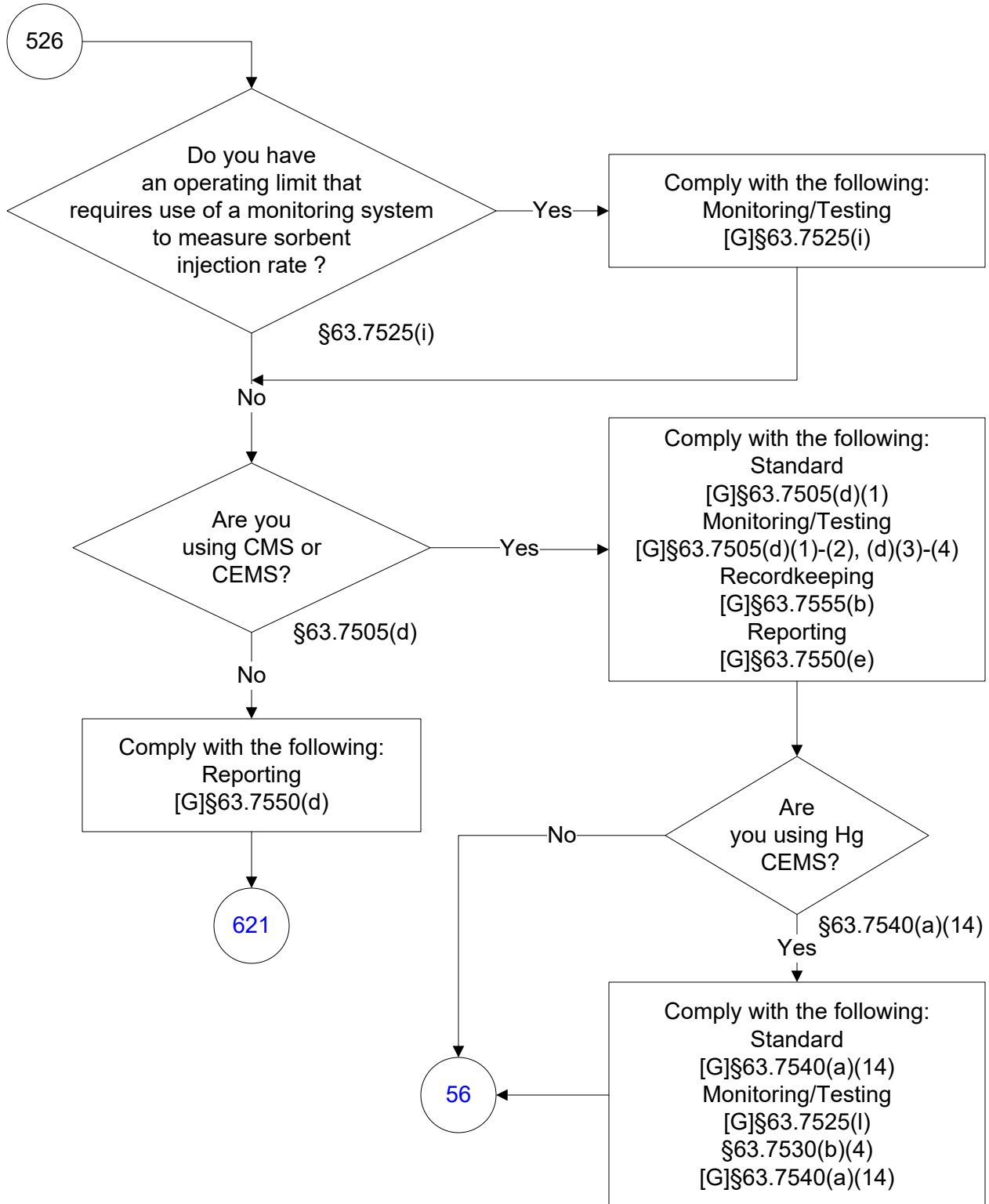

40 CFR Part 63, Subpart DDDDD (204 of 242)

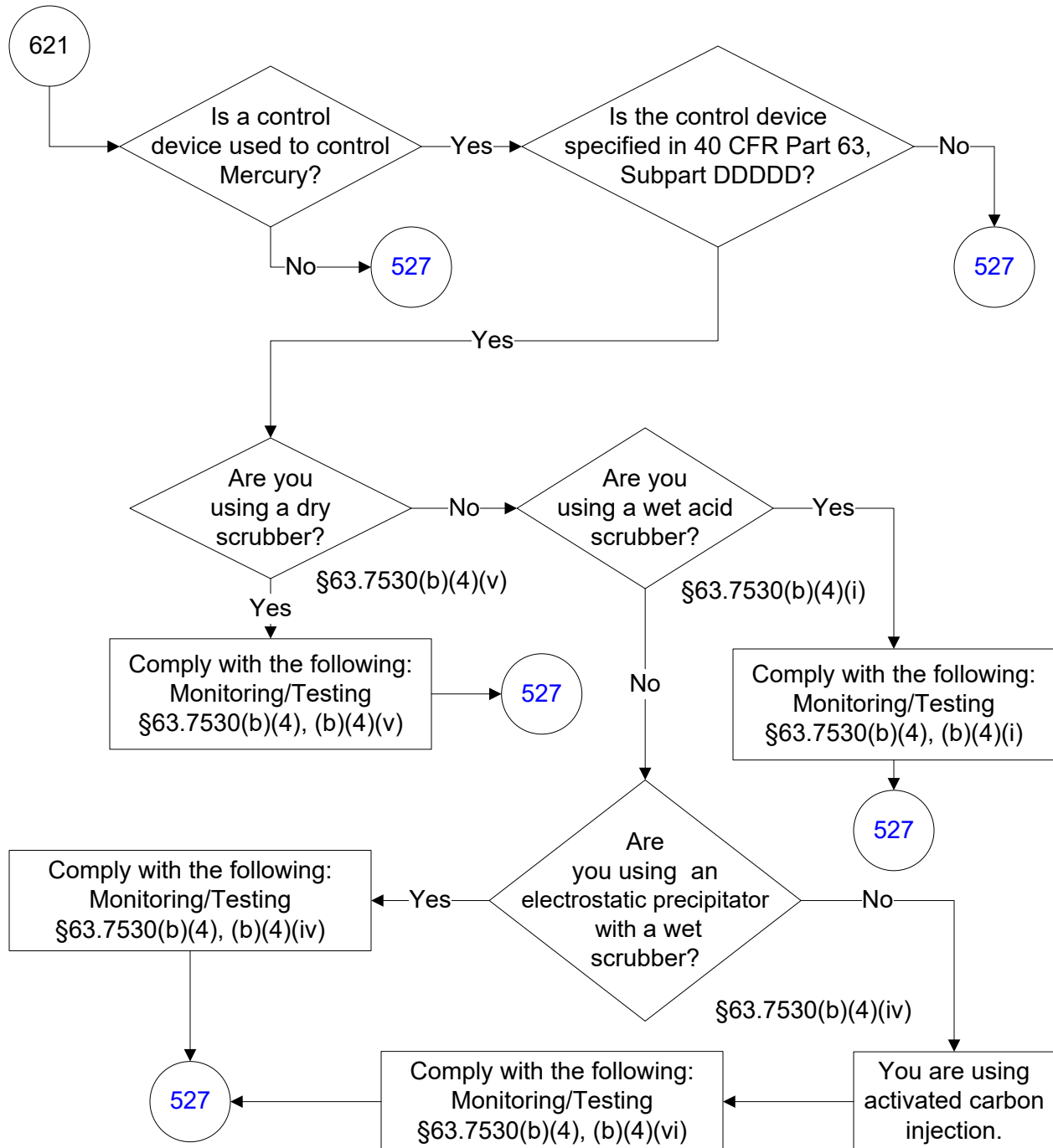

40 CFR Part 63, Subpart DDDDD (205 of 242)

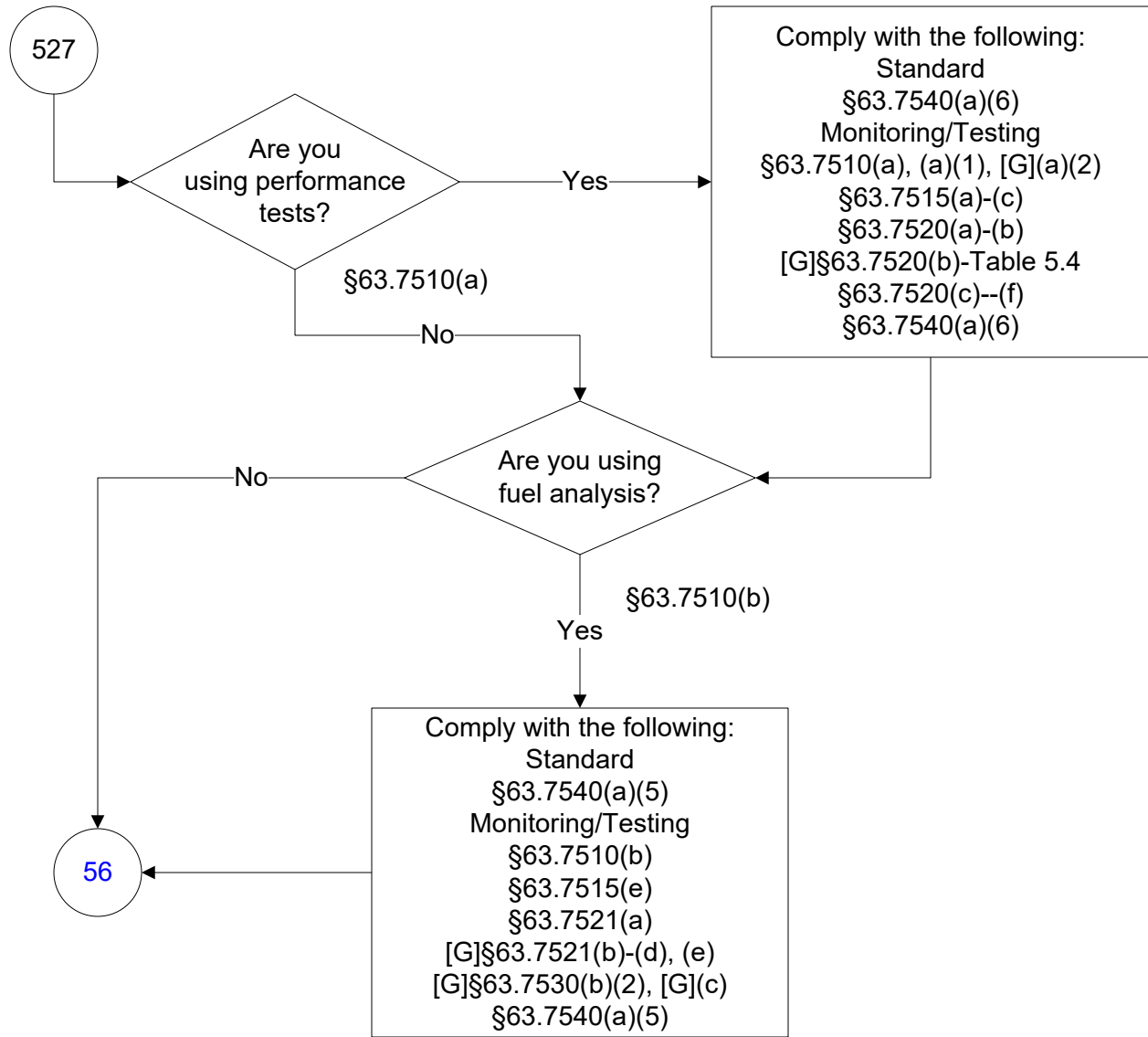

40 CFR Part 63, Subpart DDDDD
(206 of 242)

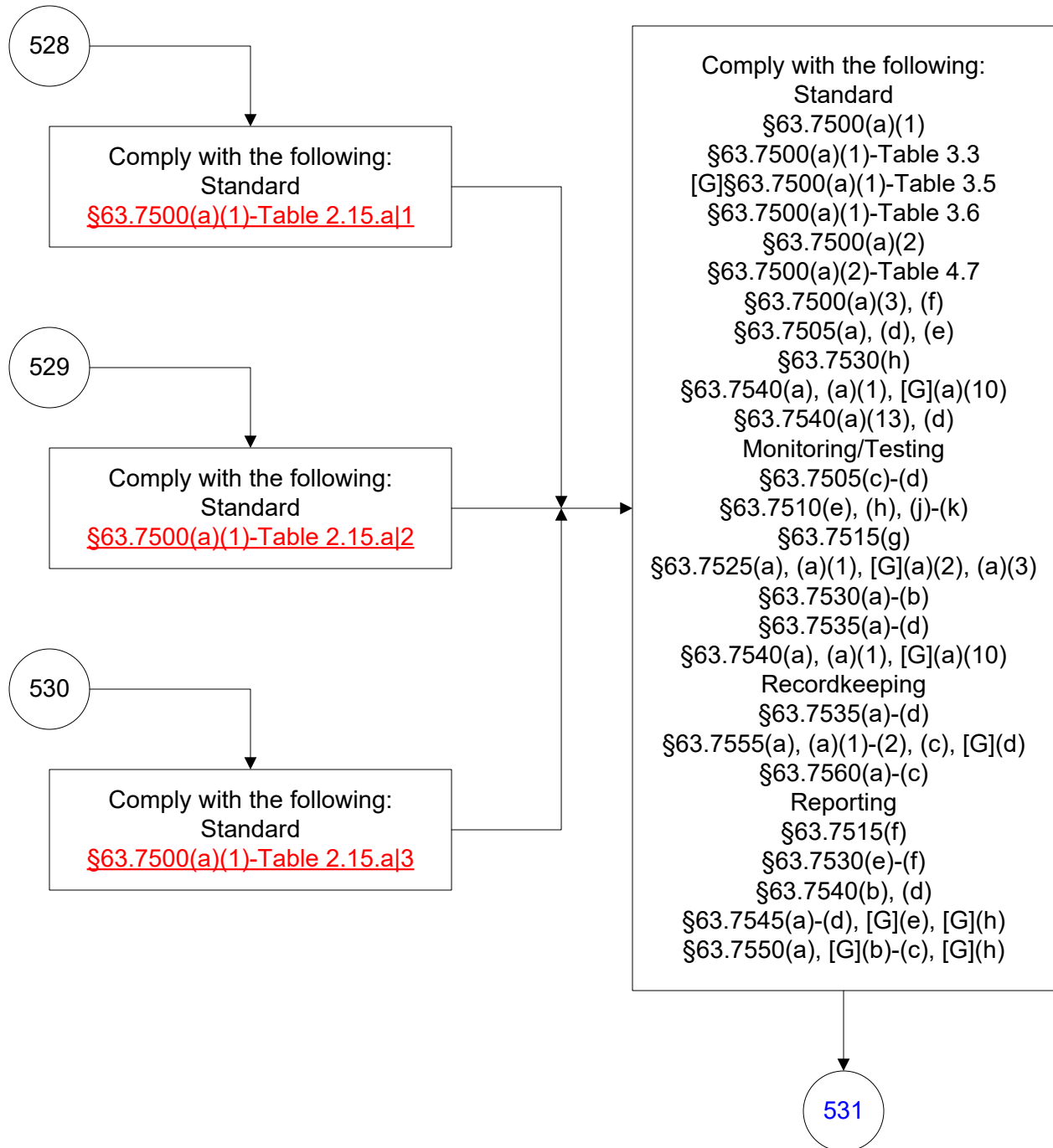

40 CFR Part 63, Subpart DDDDD (207 of 242)

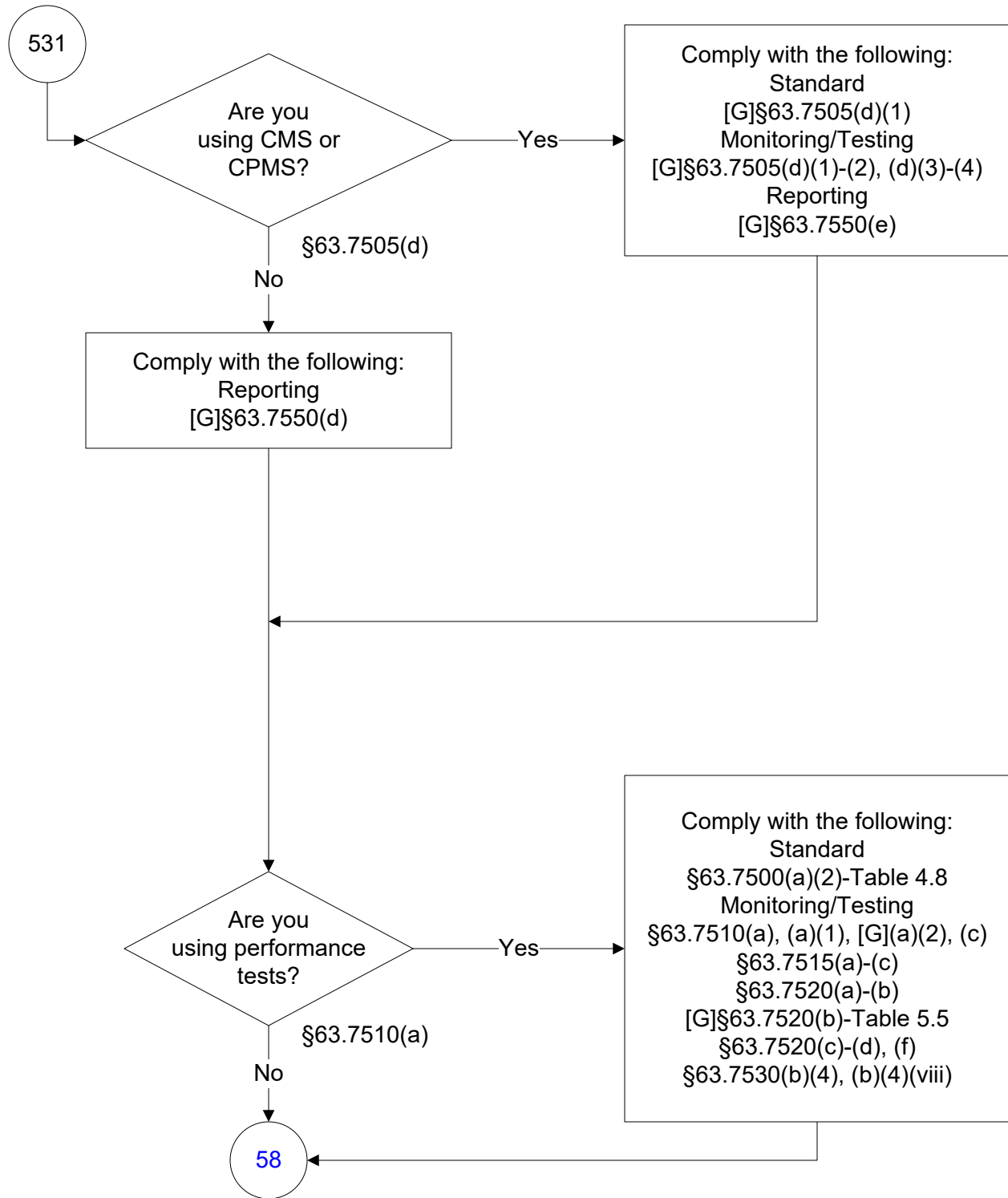

40 CFR Part 63, Subpart DDDDD (208 of 242)

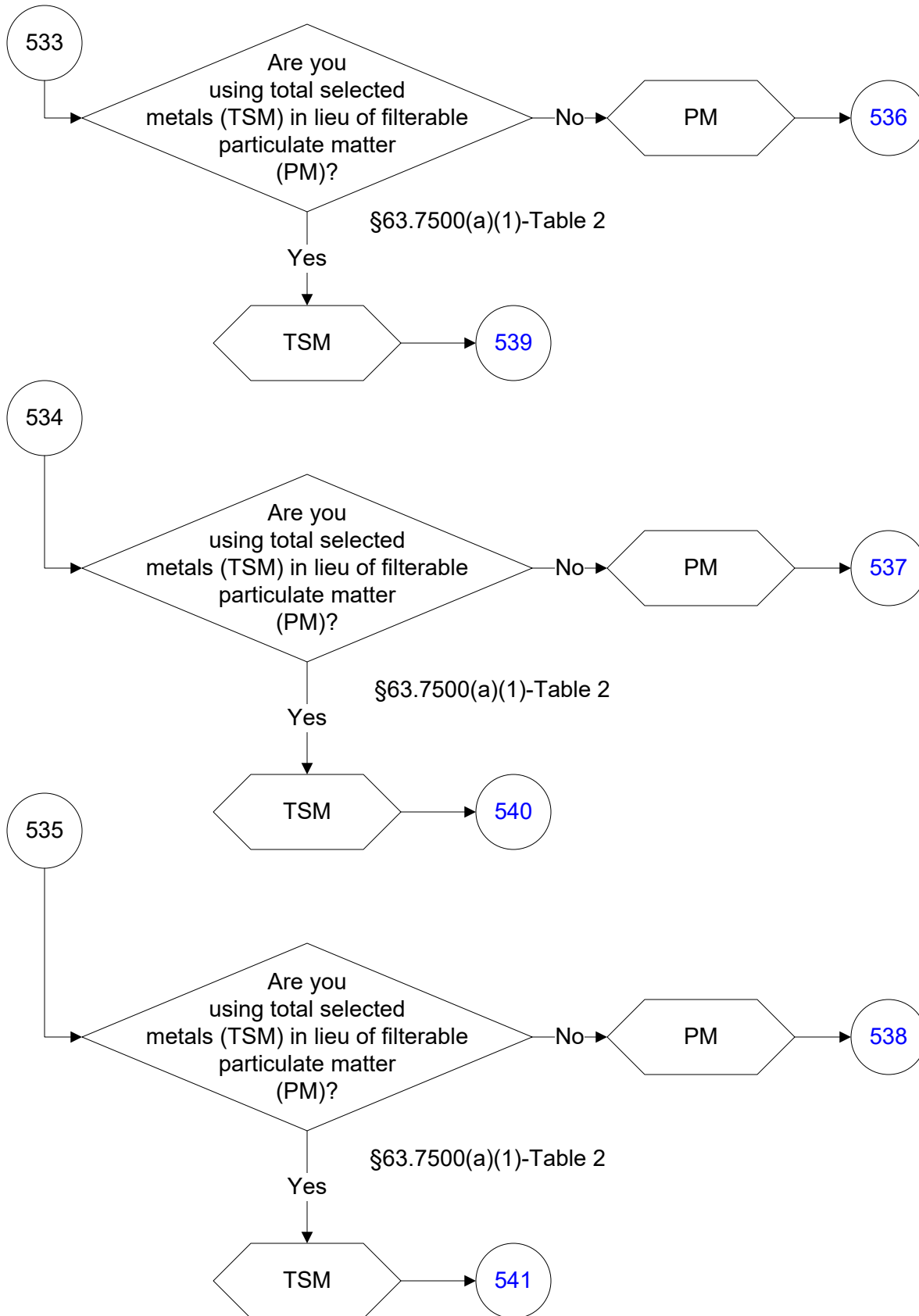

40 CFR Part 63, Subpart DDDDD (209 of 242)

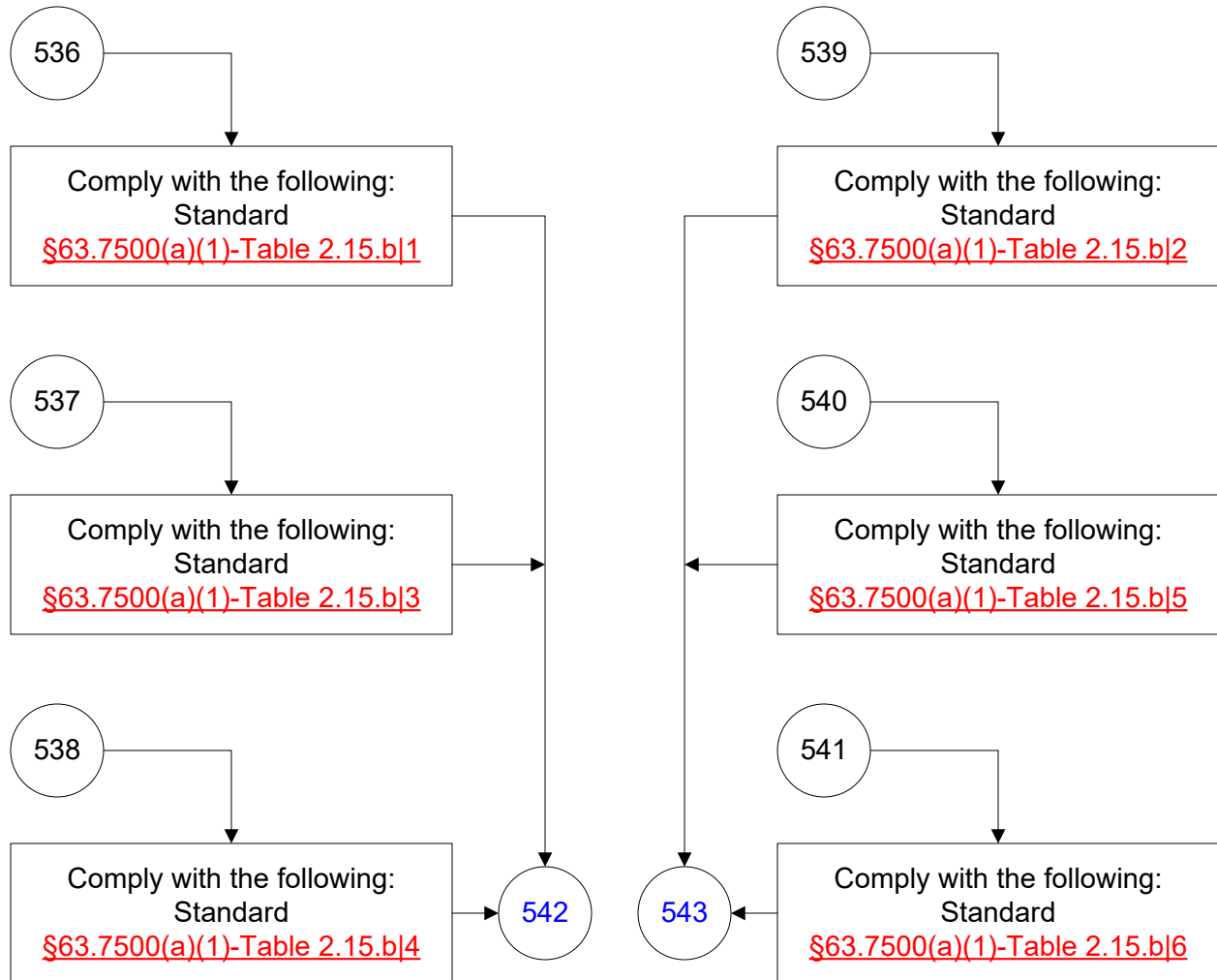

40 CFR Part 63, Subpart DDDDD
(210 of 242)

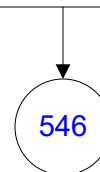
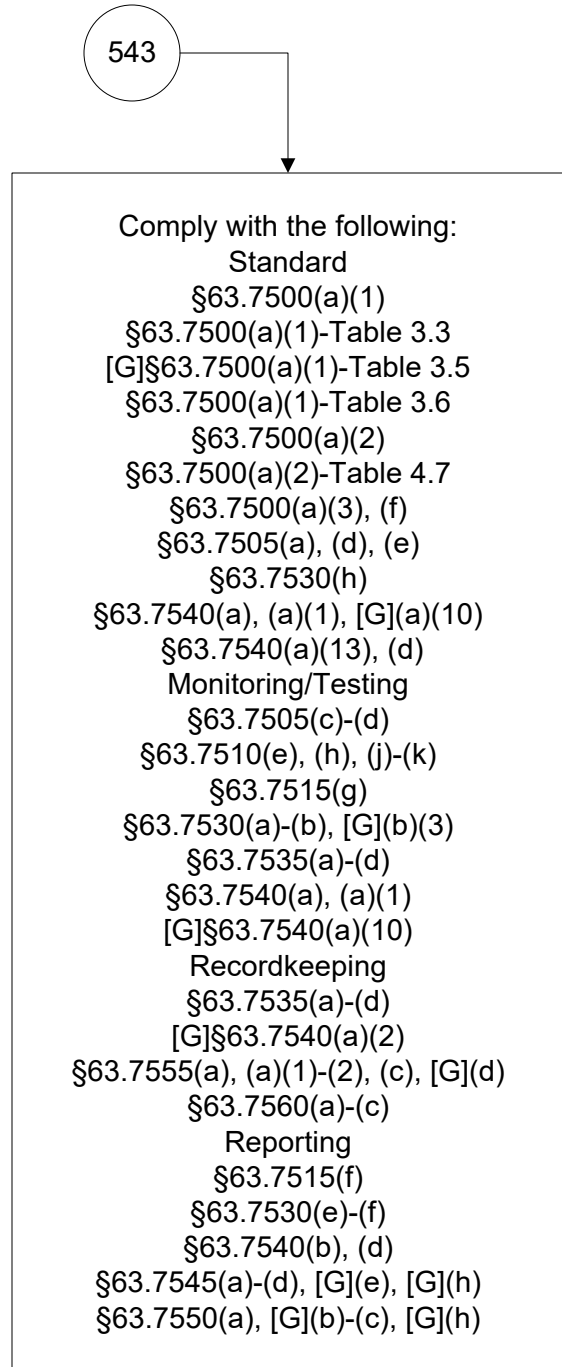
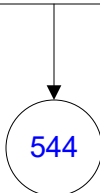
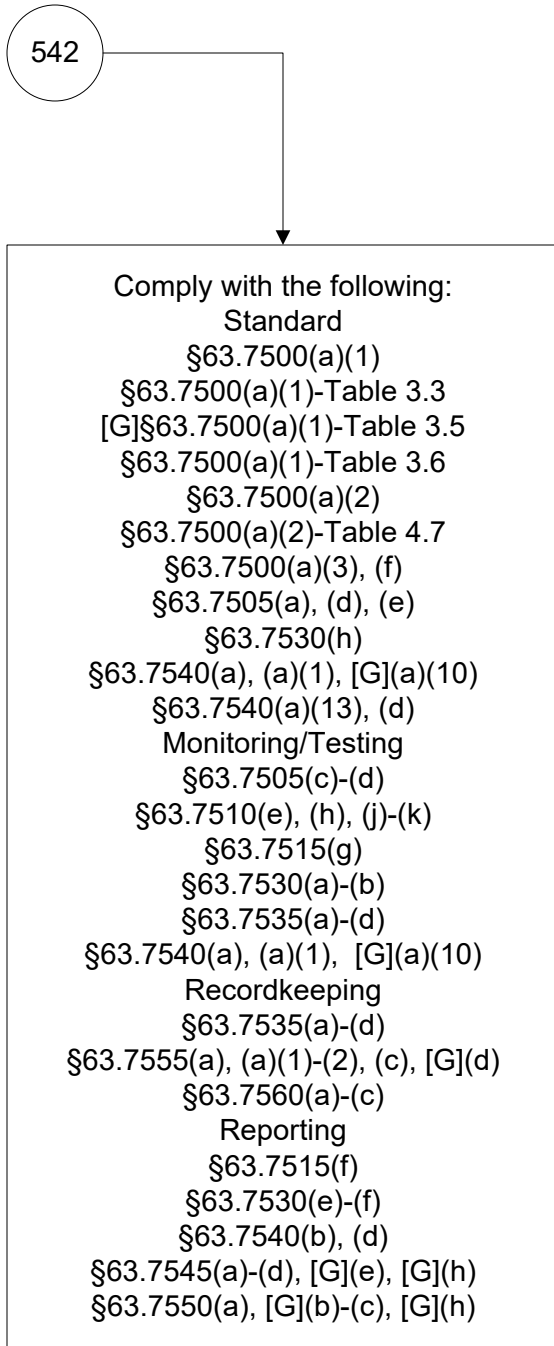

40 CFR Part 63, Subpart DDDDD (211 of 242)

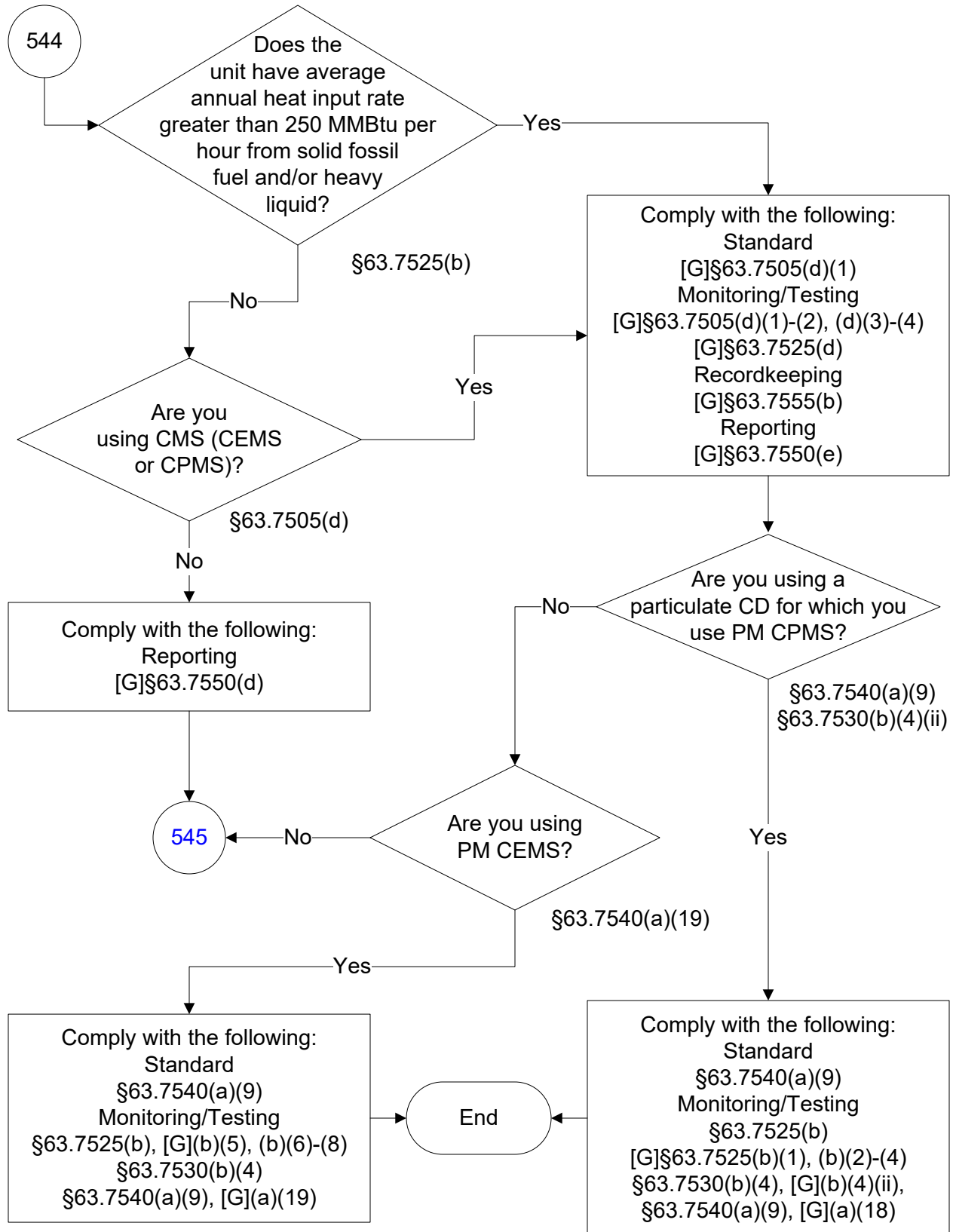

40 CFR Part 63, Subpart DDDDD (212 of 242)

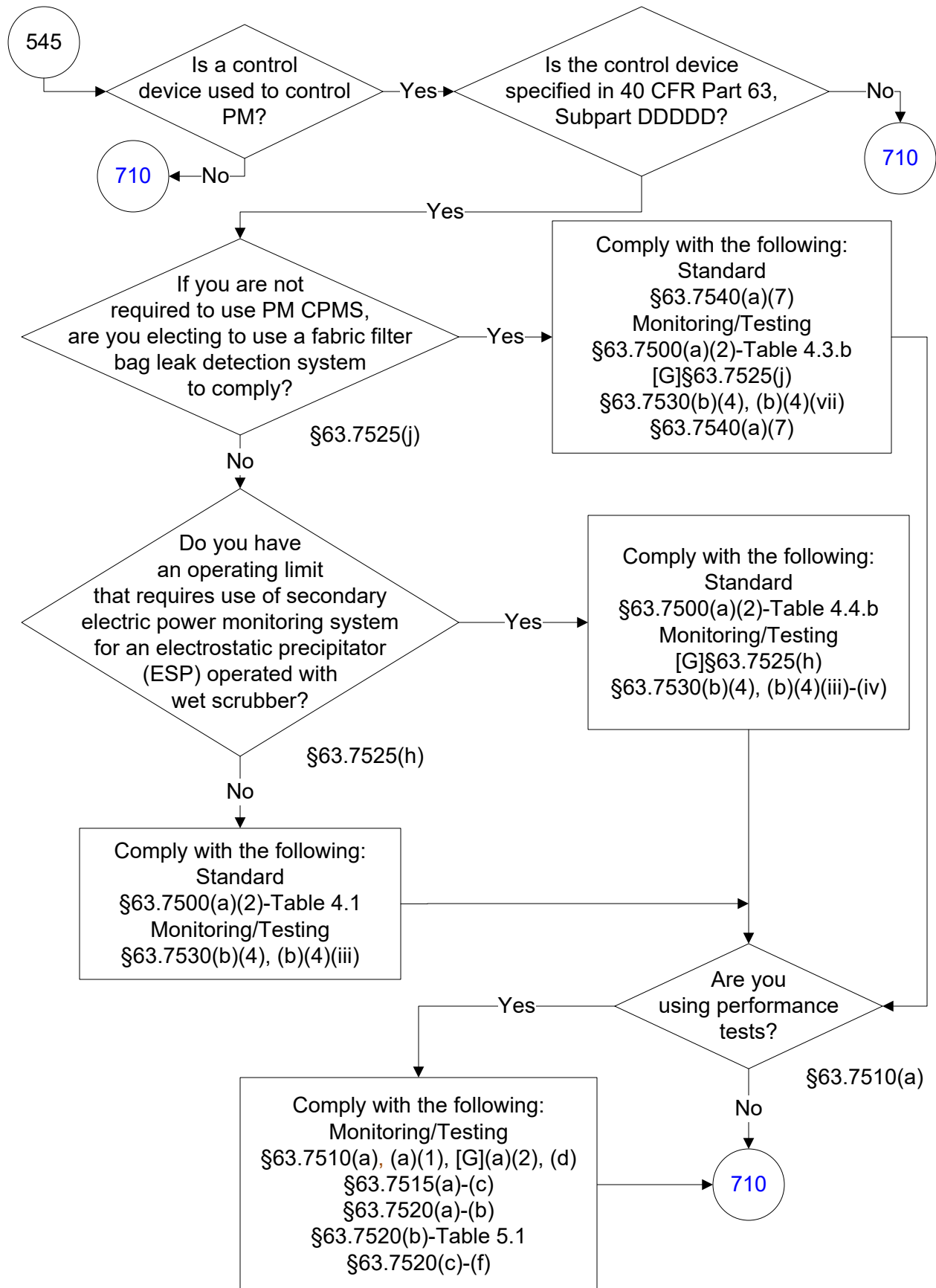

40 CFR Part 63, Subpart DDDDD (213 of 242)

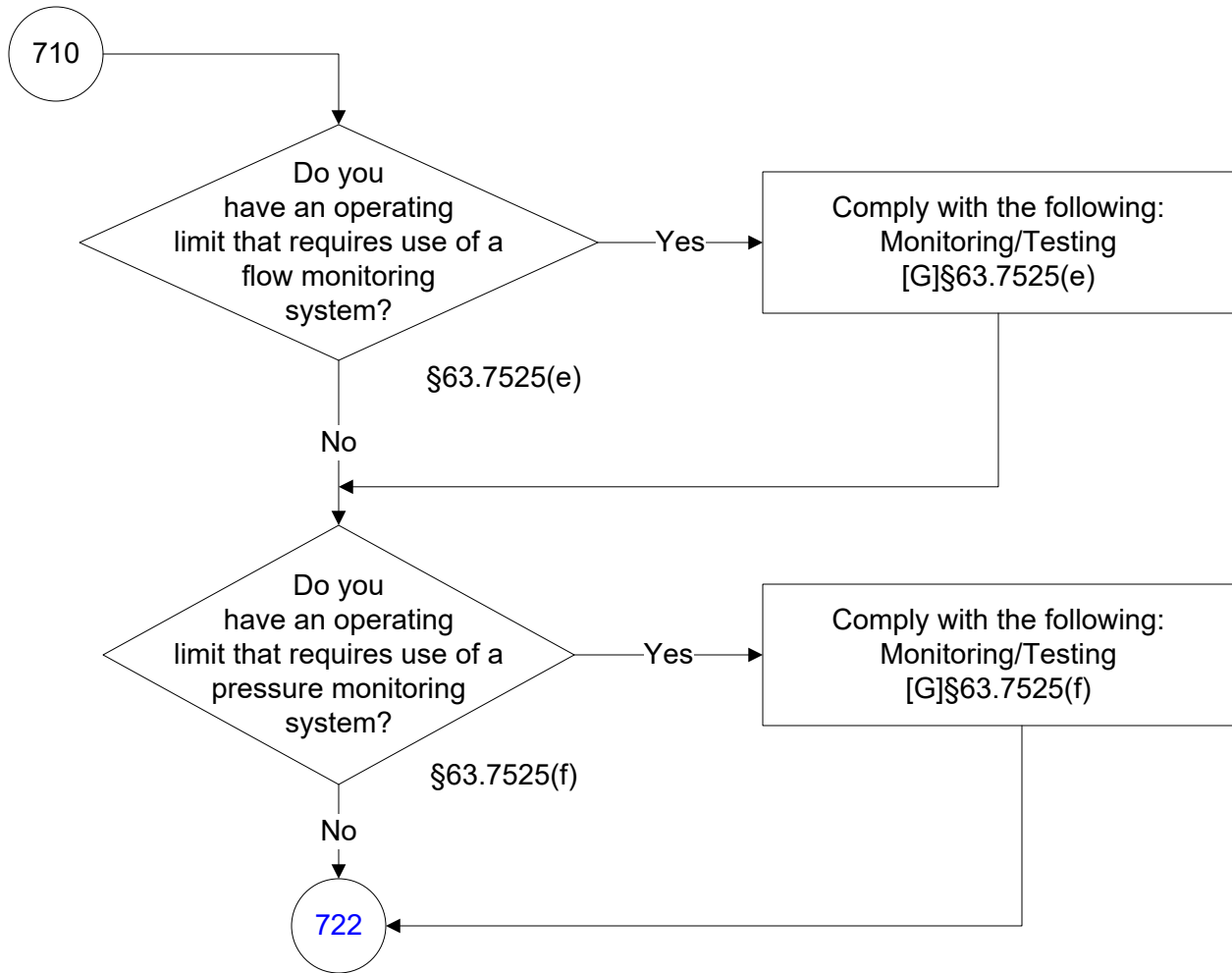

40 CFR Part 63, Subpart DDDDD (214 of 242)

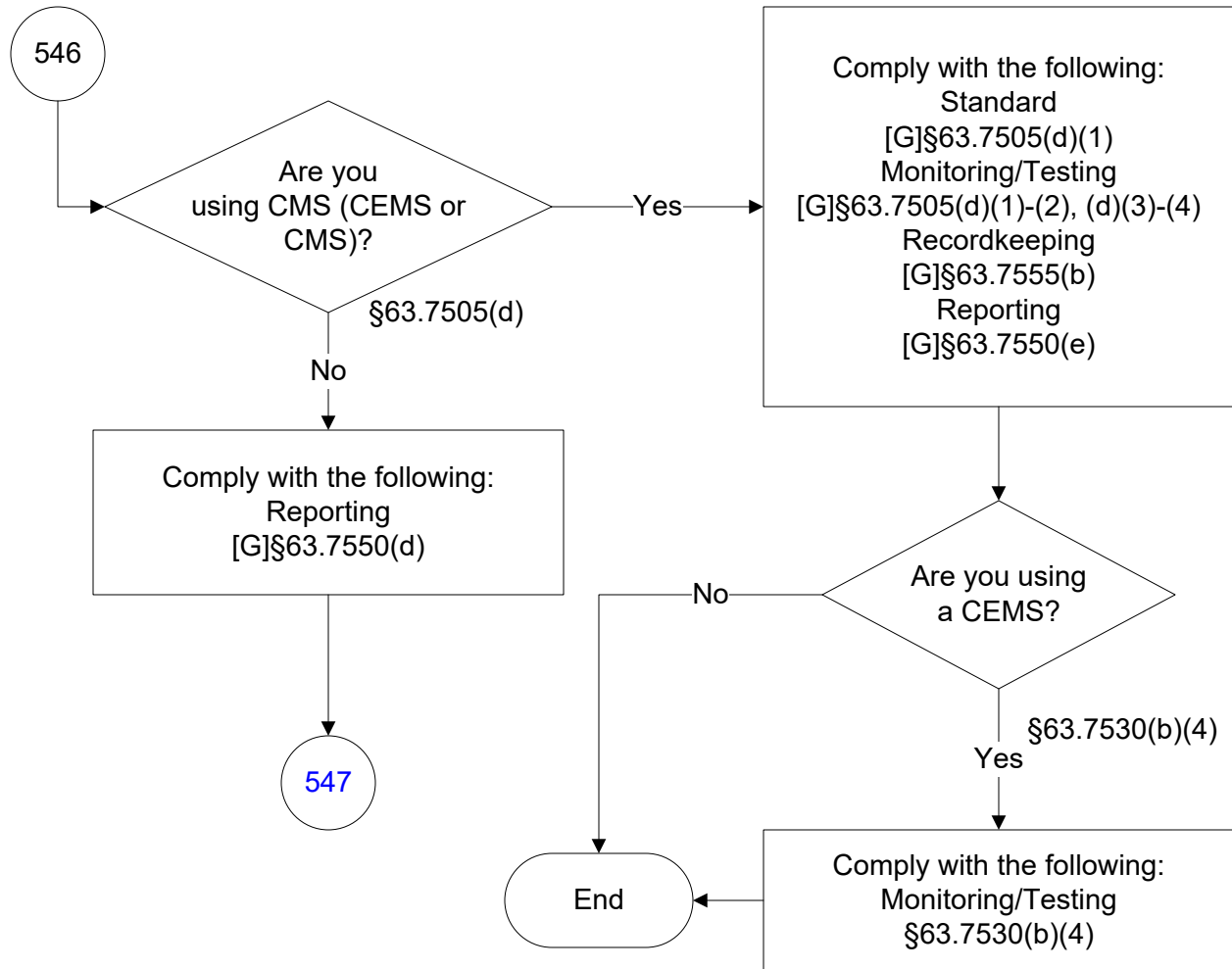

40 CFR Part 63, Subpart DDDDD (215 of 242)

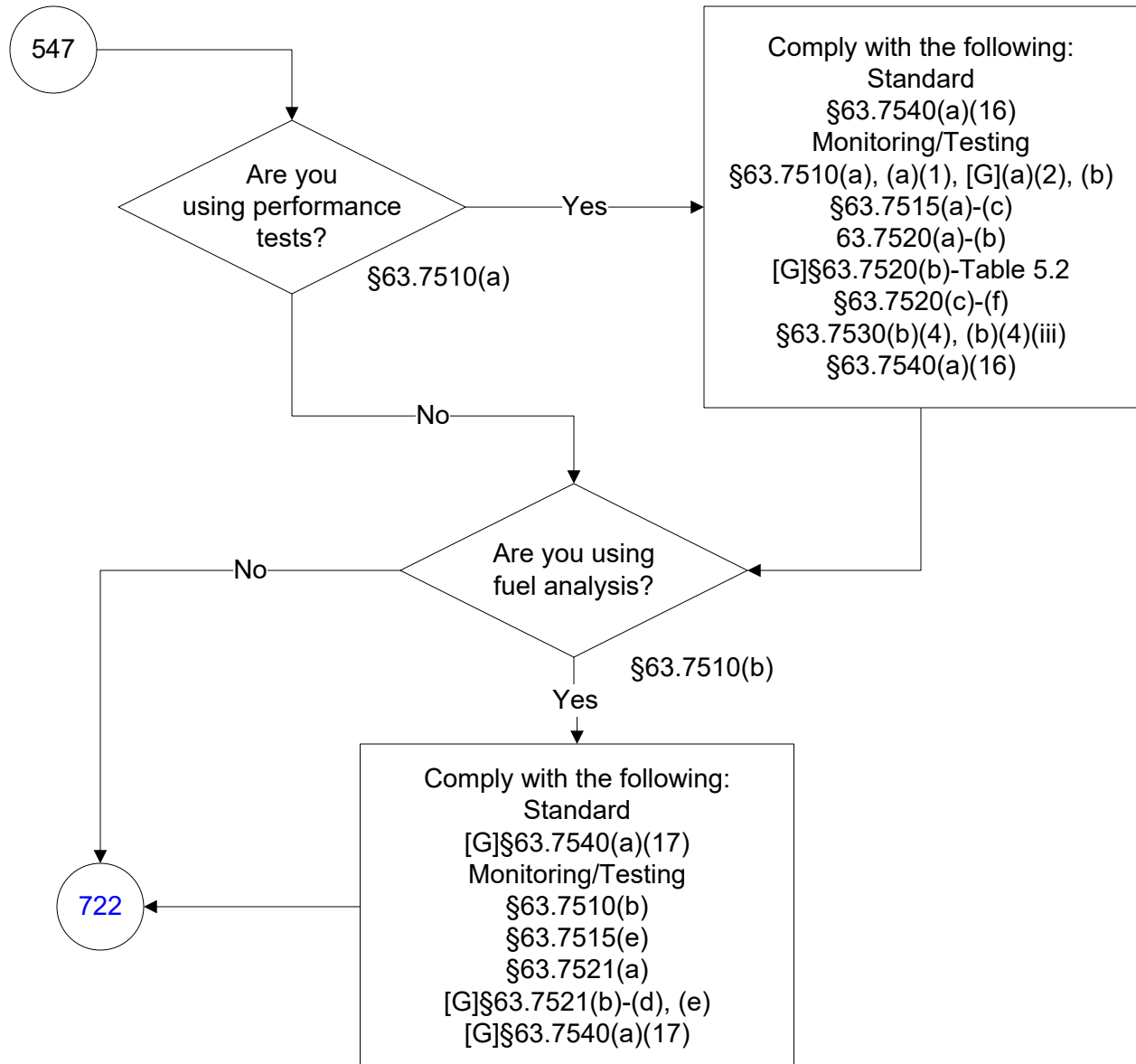

40 CFR Part 63, Subpart DDDDD (216 of 242)

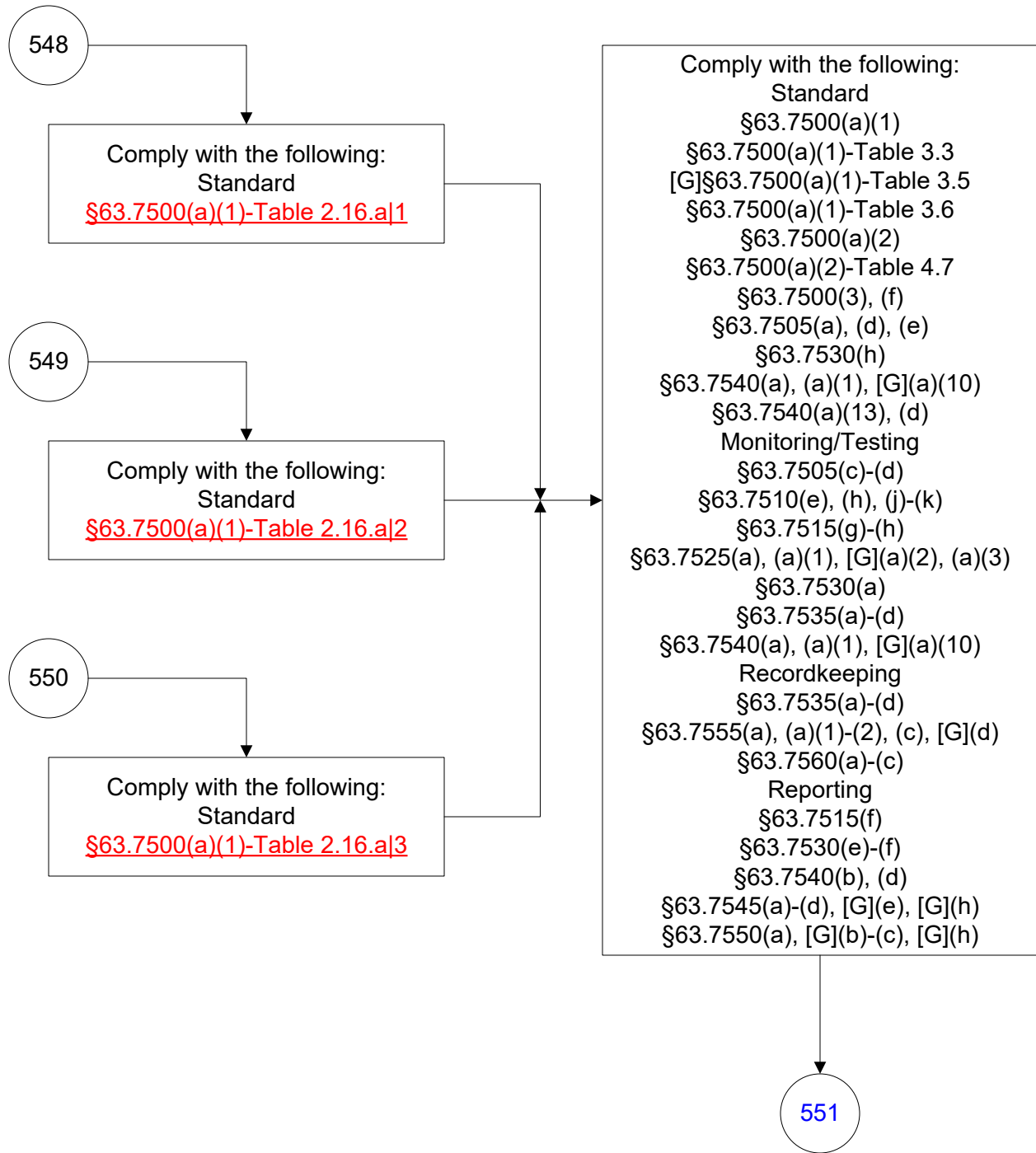

40 CFR Part 63, Subpart DDDDD (217 of 242)

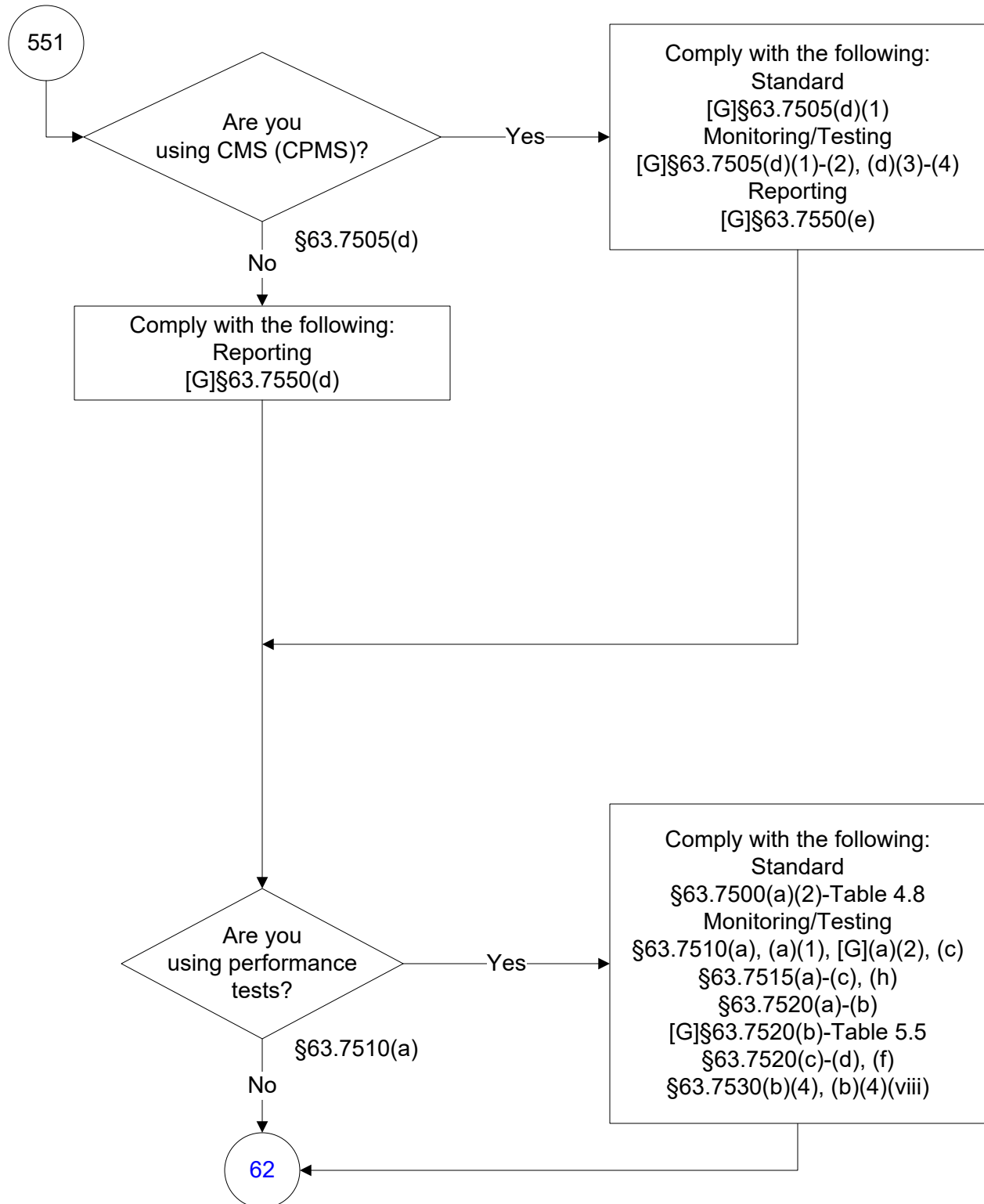

40 CFR Part 63, Subpart DDDDD (218 of 242)

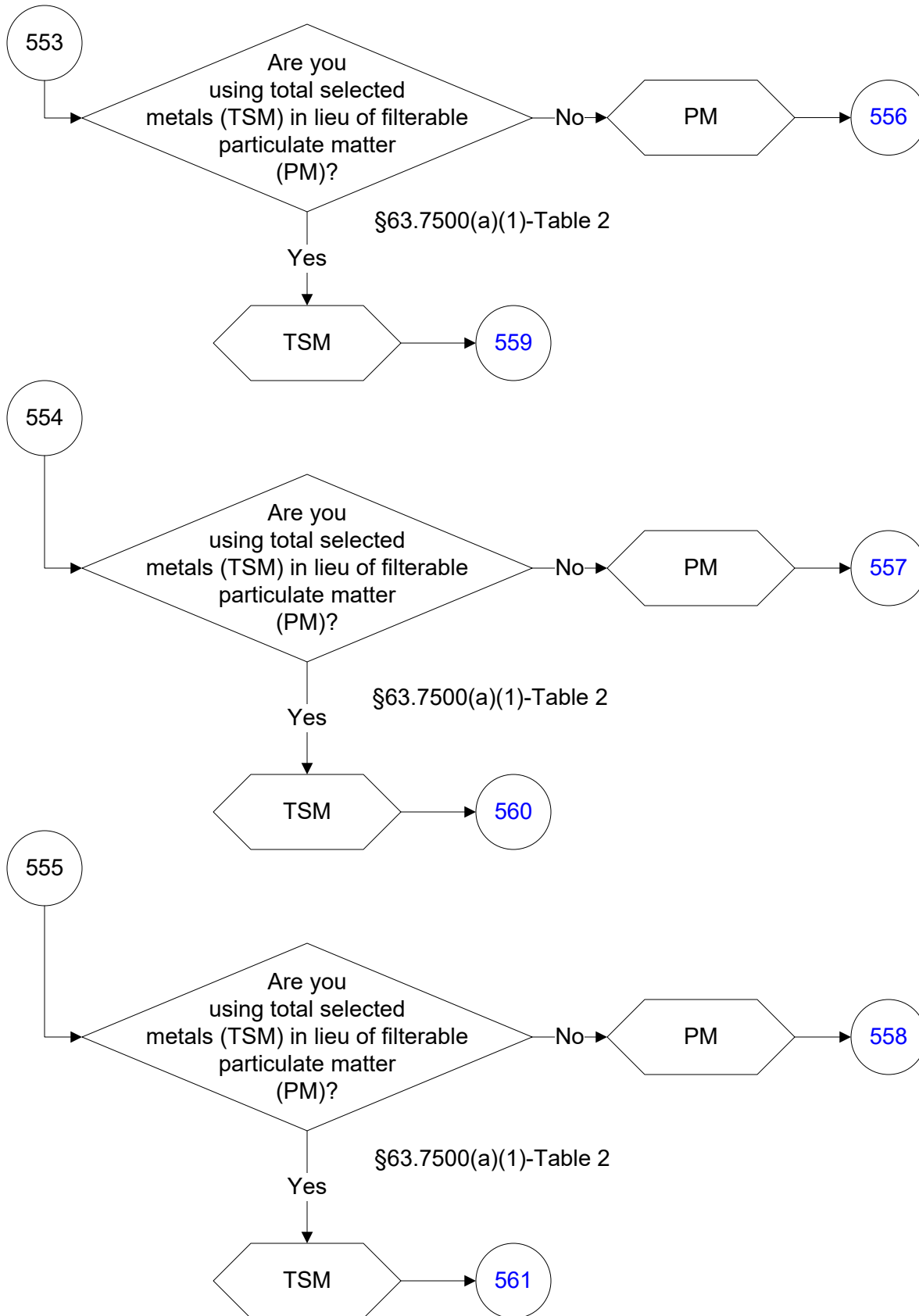

40 CFR Part 63, Subpart DDDDD (219 of 242)

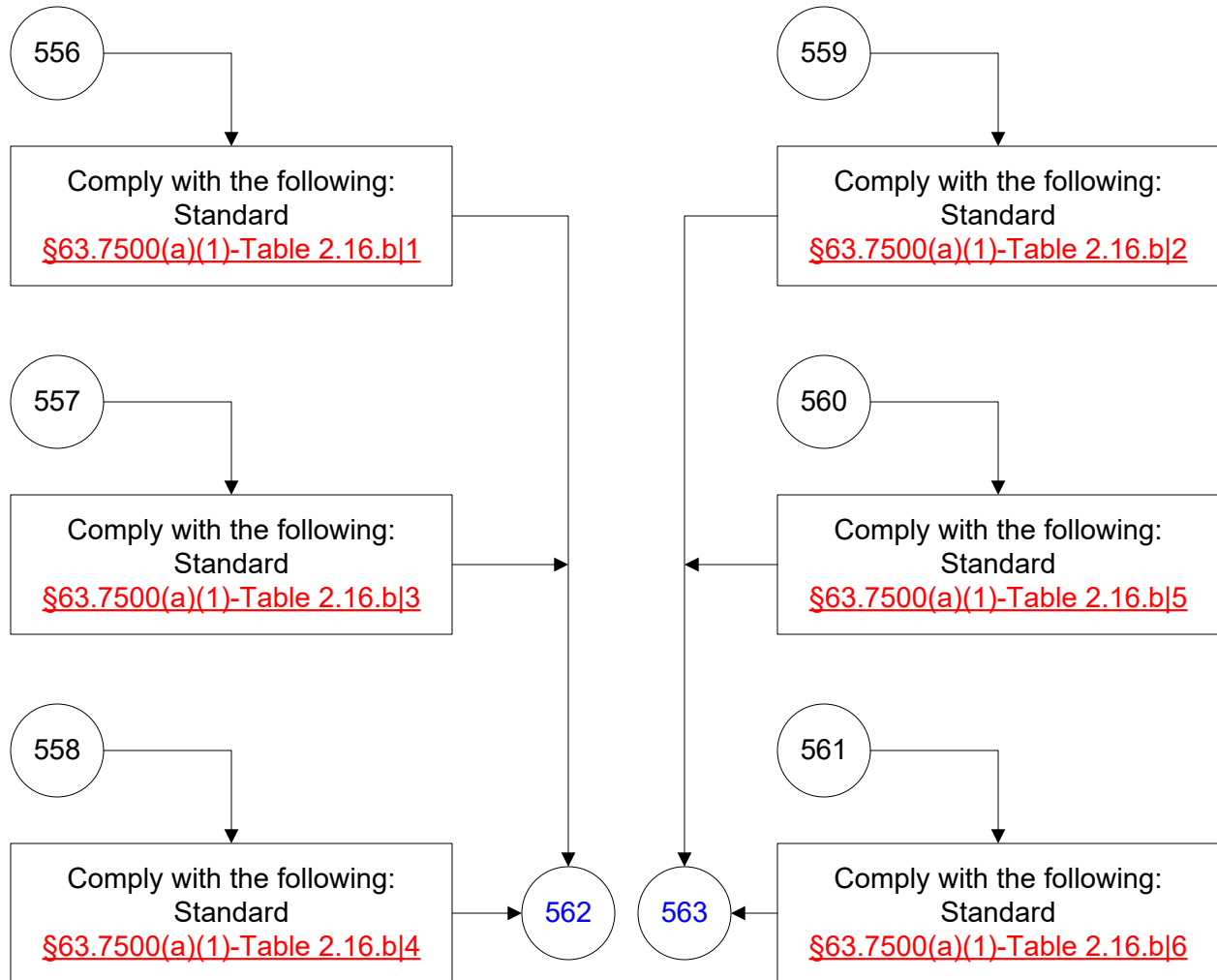

40 CFR Part 63, Subpart DDDDD
(220 of 242)

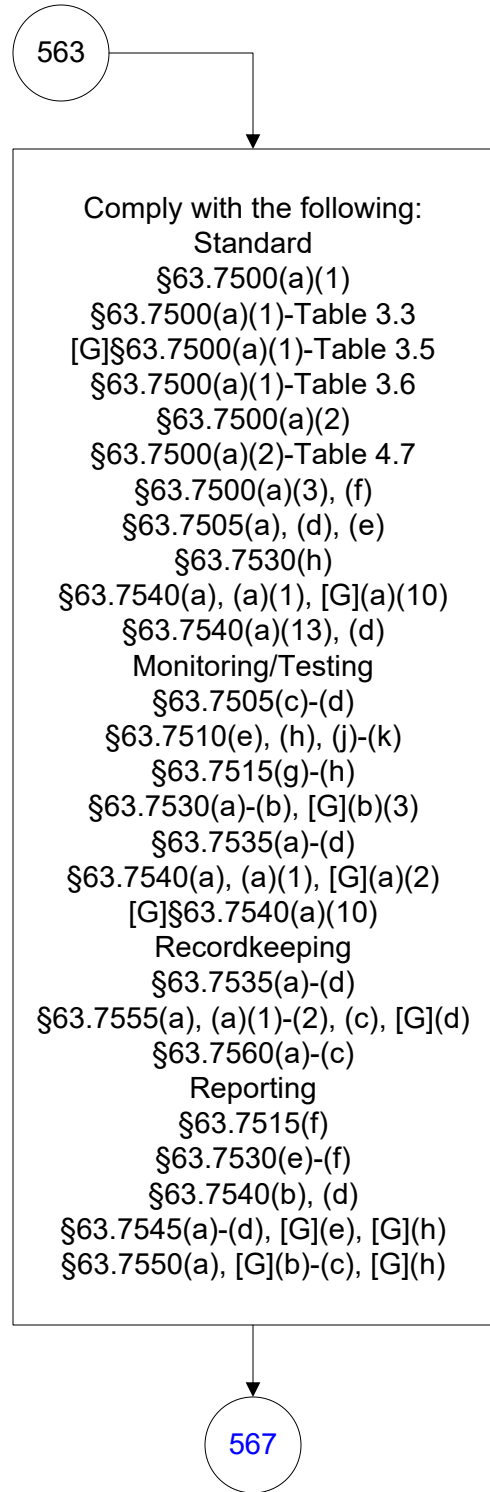
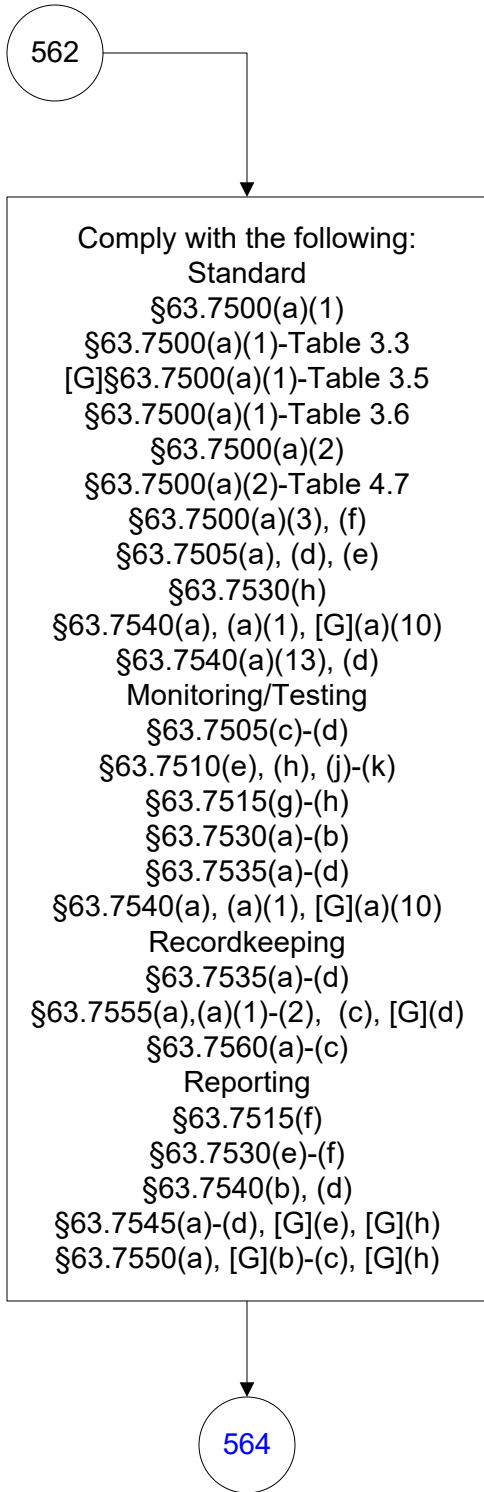

40 CFR Part 63, Subpart DDDDD (221 of 242)

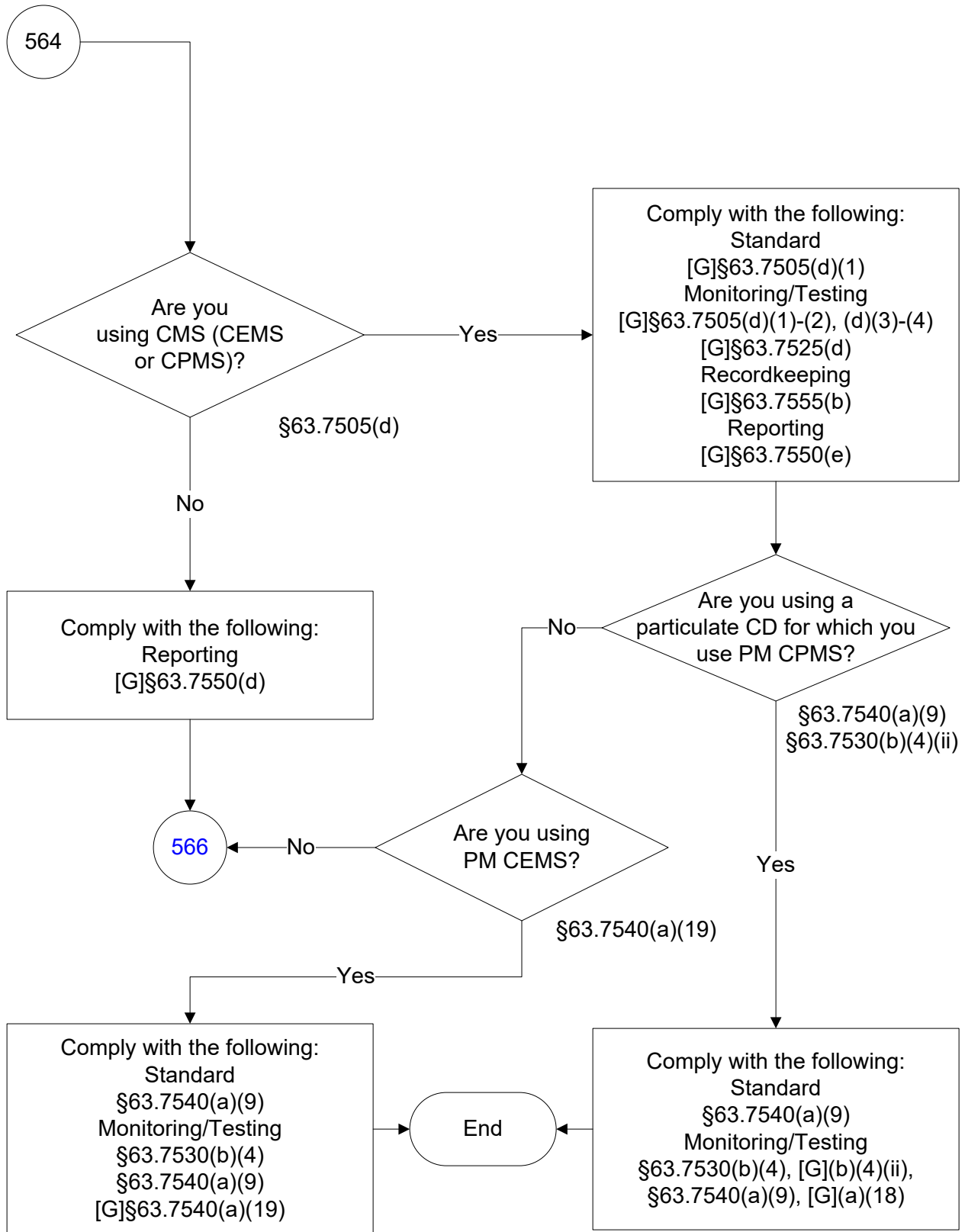

40 CFR Part 63, Subpart DDDDD (222 of 242)

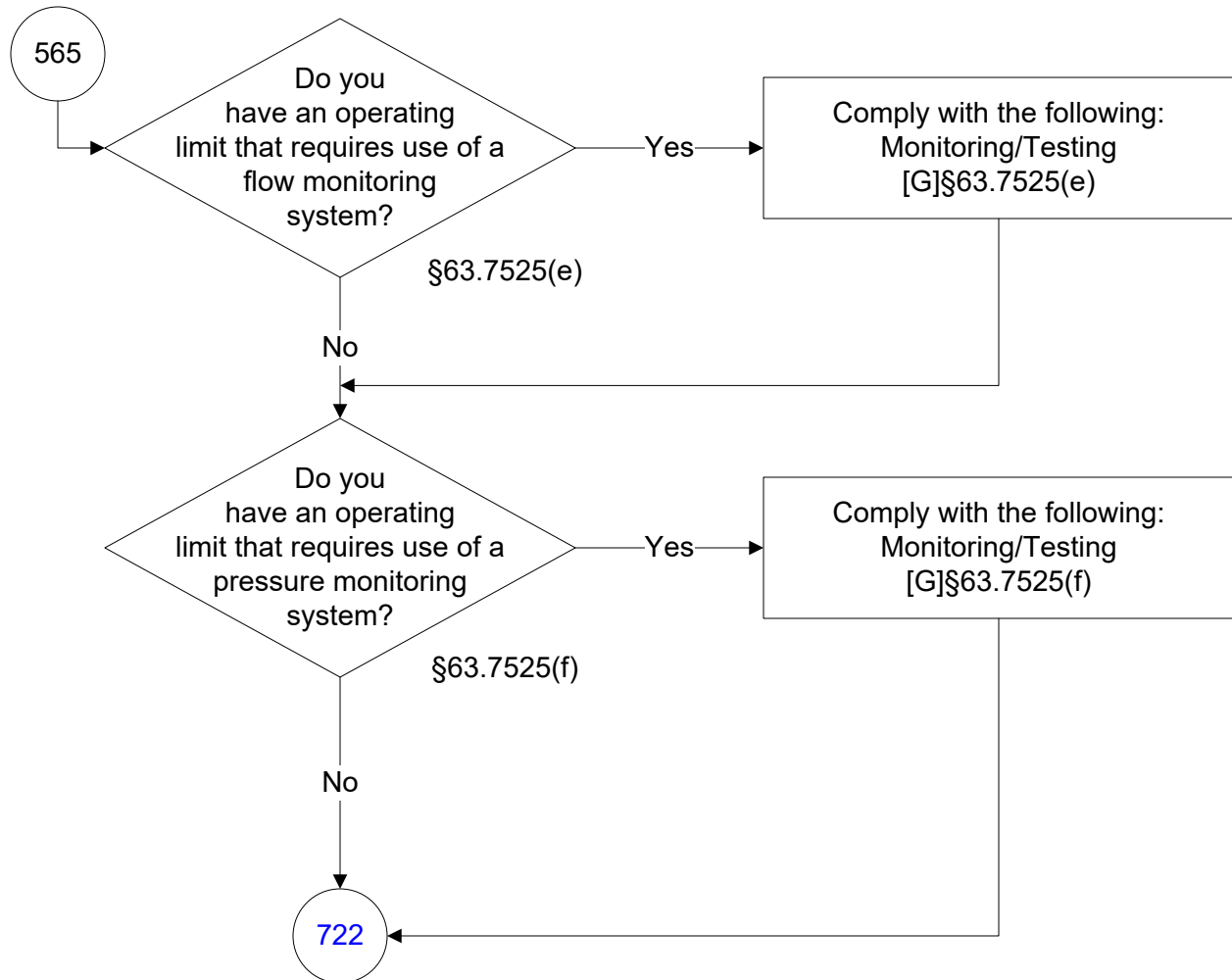

40 CFR Part 63, Subpart DDDDD (223 of 242)

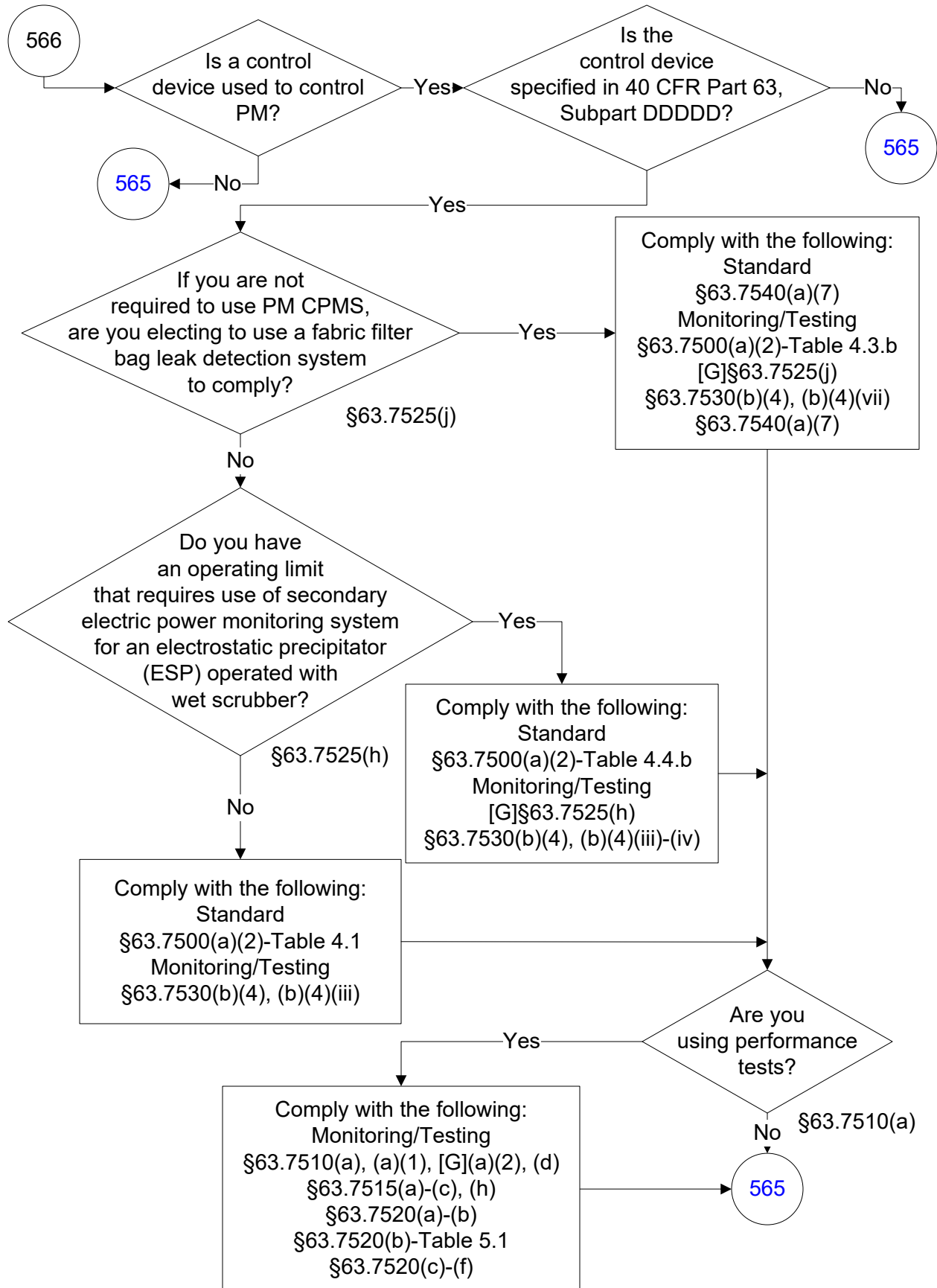

40 CFR Part 63, Subpart DDDDD (224 of 242)

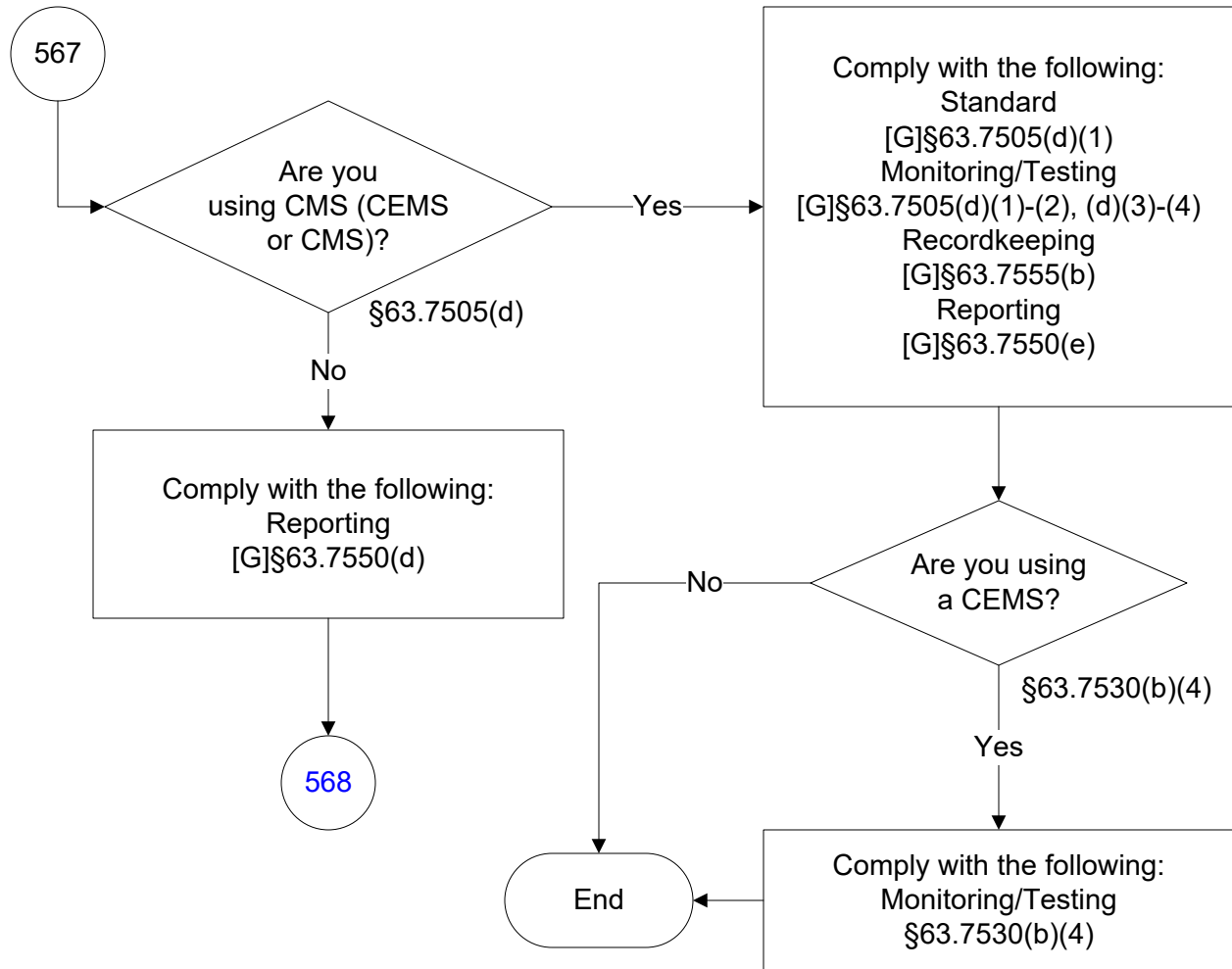

40 CFR Part 63, Subpart DDDDD (225 of 242)

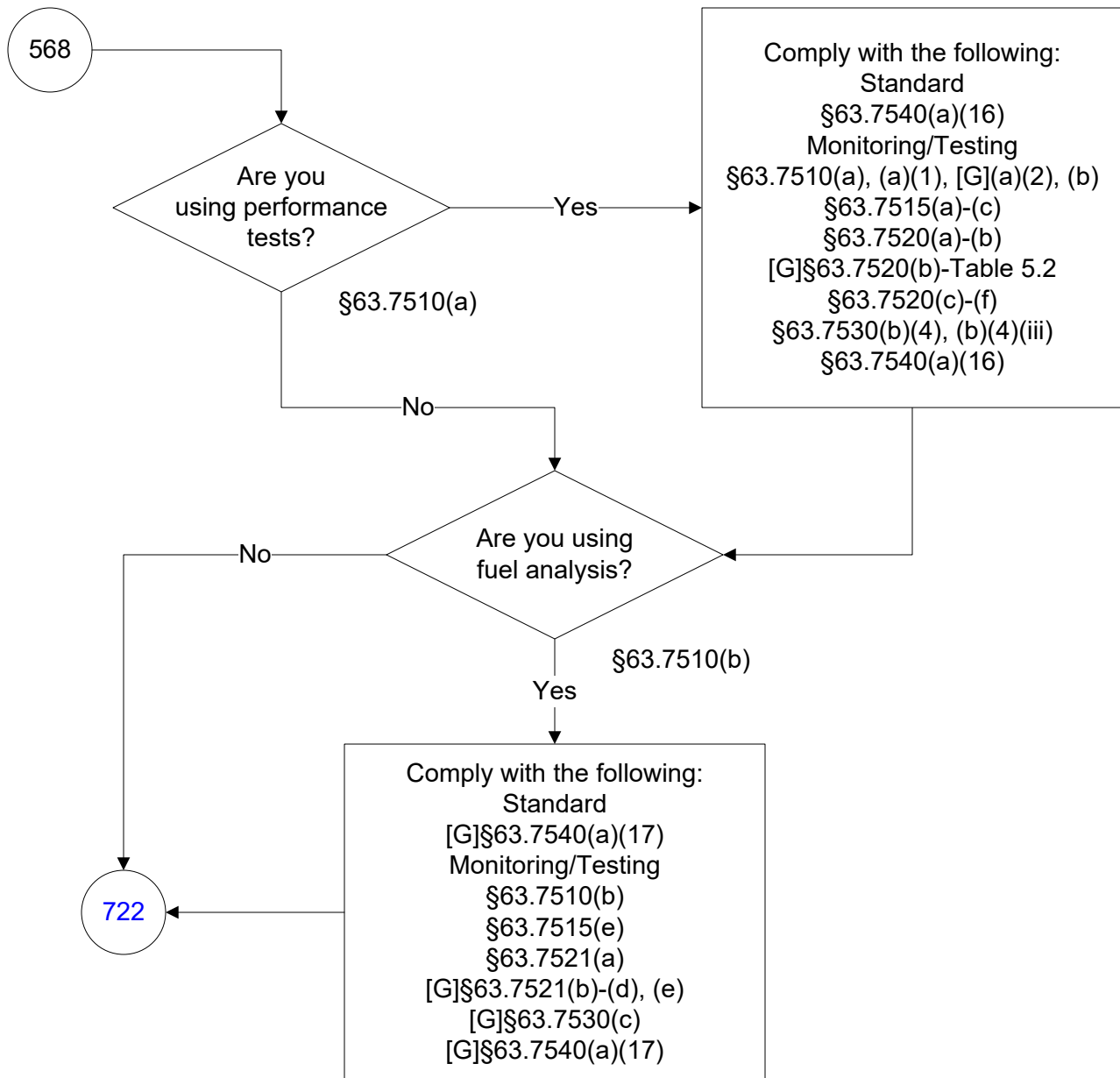

**40 CFR Part 63, Subpart DDDDD
(226 of 242)**

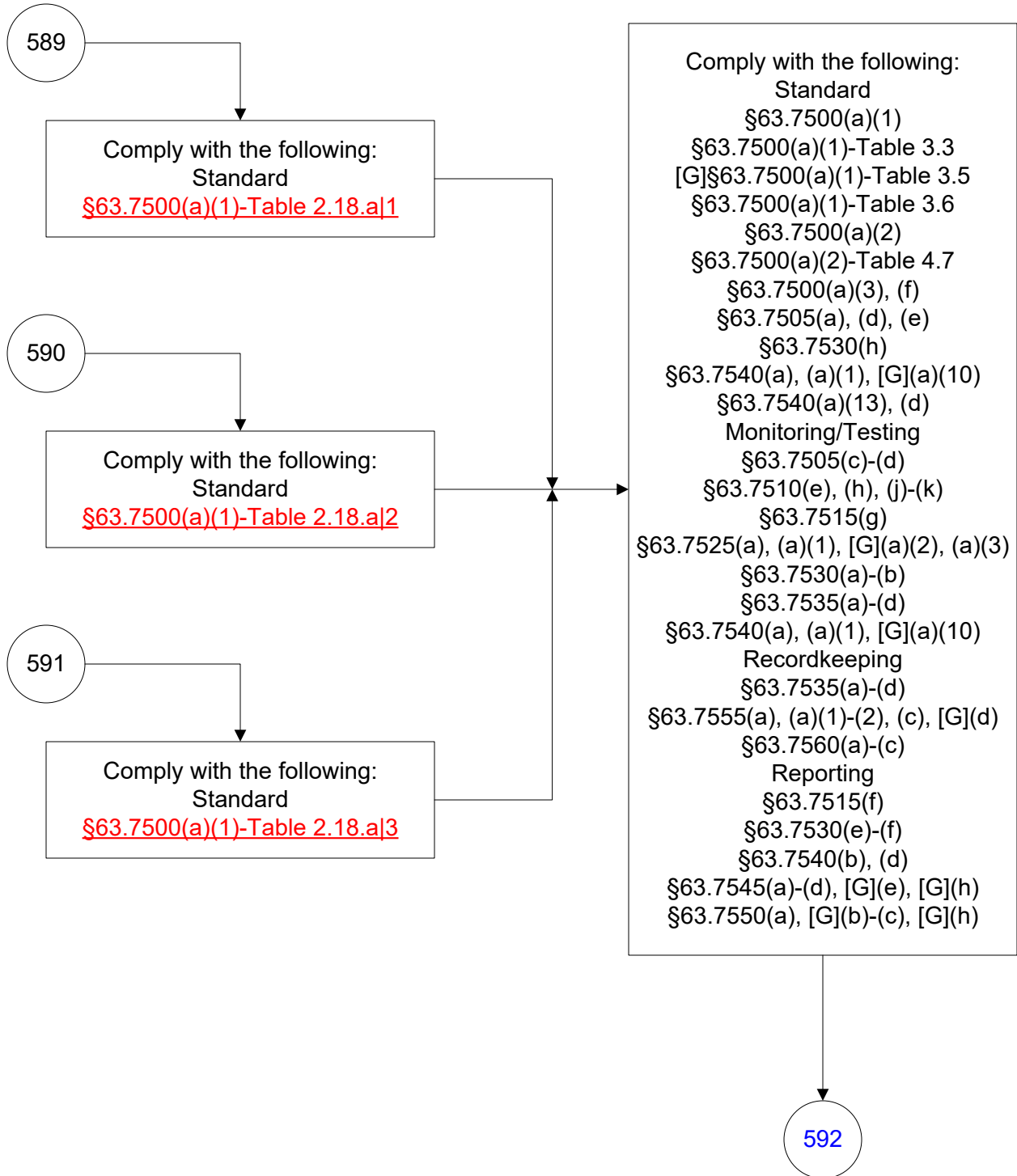

40 CFR Part 63, Subpart DDDDD (227 of 242)

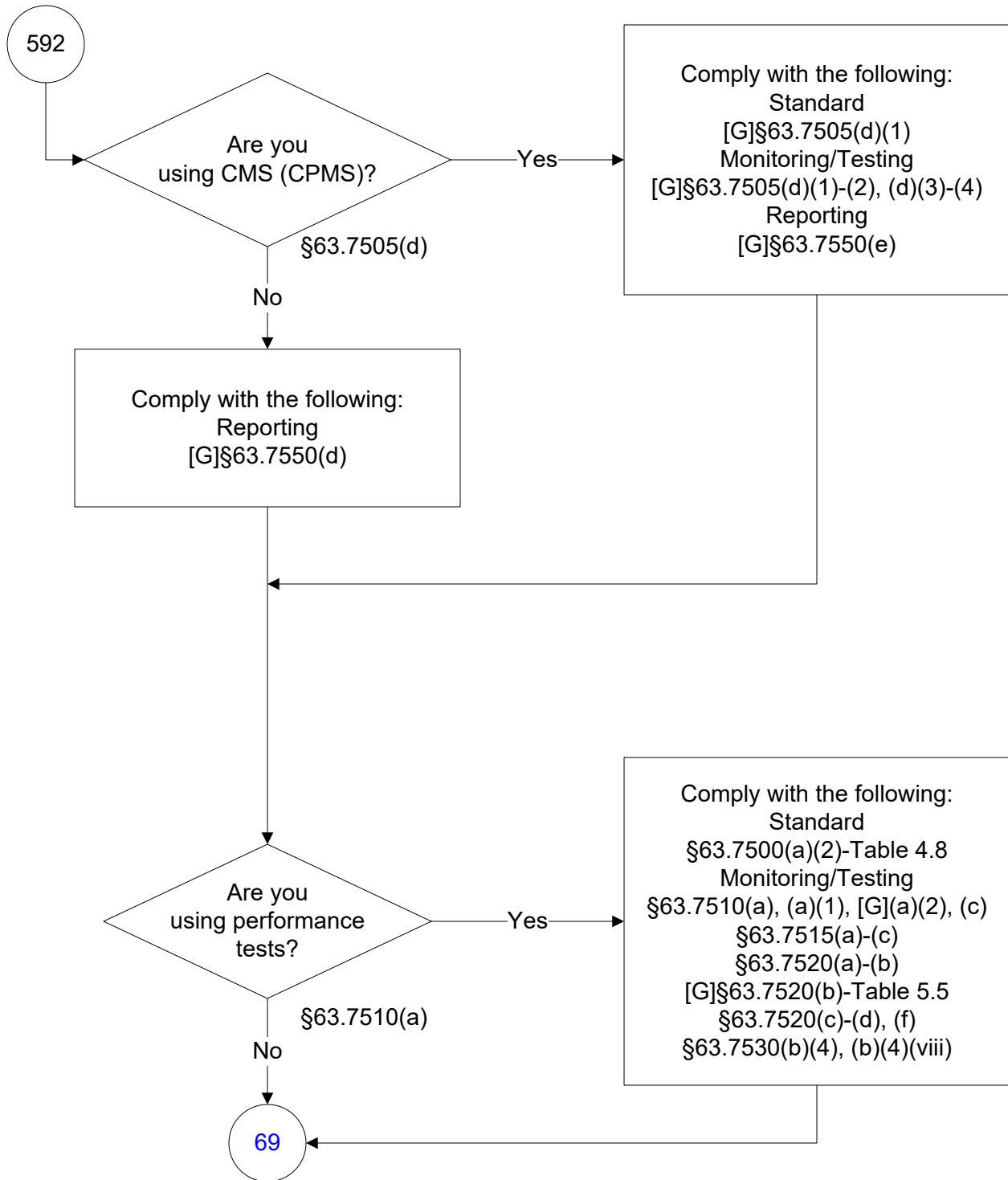

40 CFR Part 63, Subpart DDDDD (228 of 242)

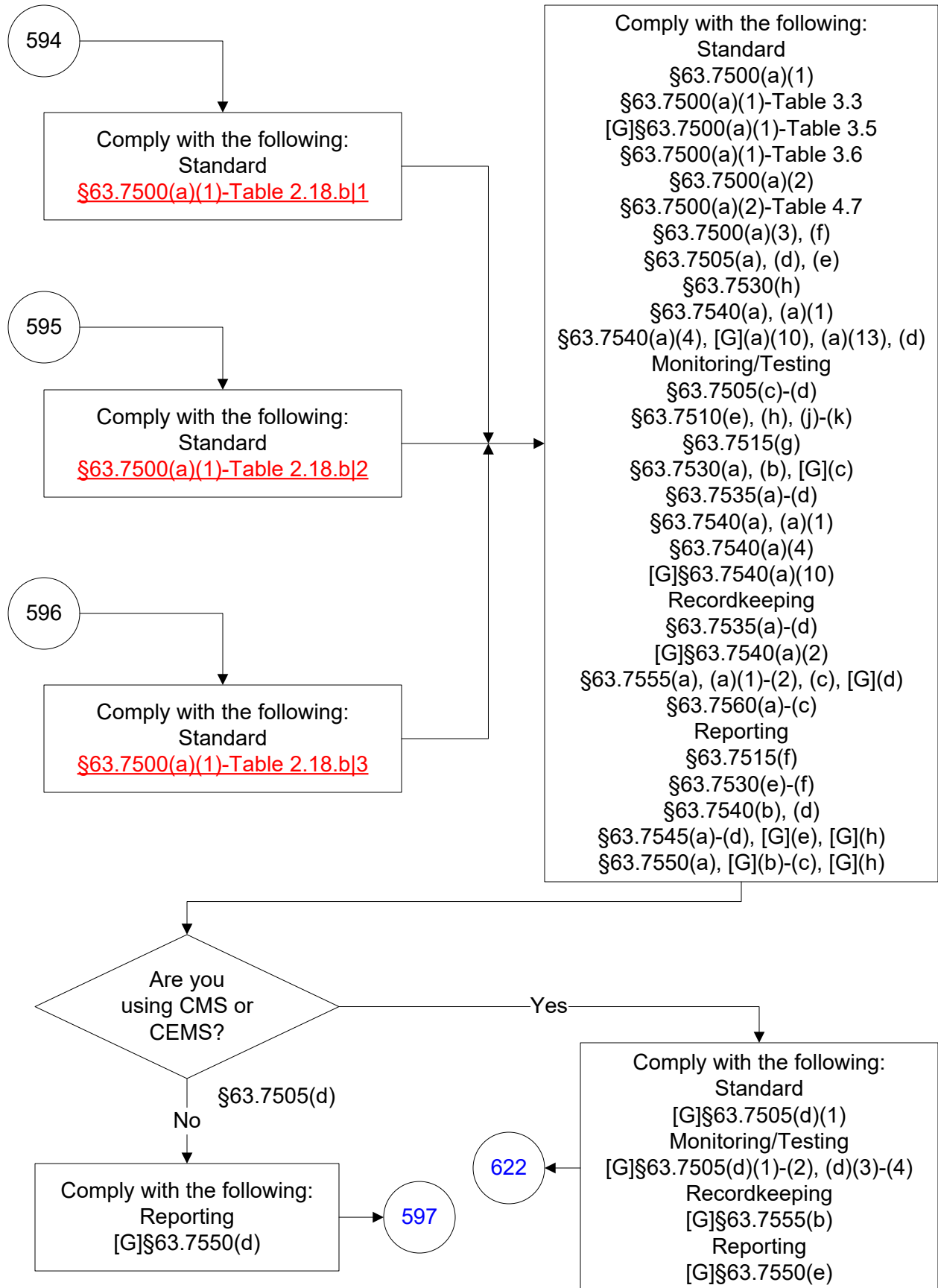

40 CFR Part 63, Subpart DDDDD (229 of 242)

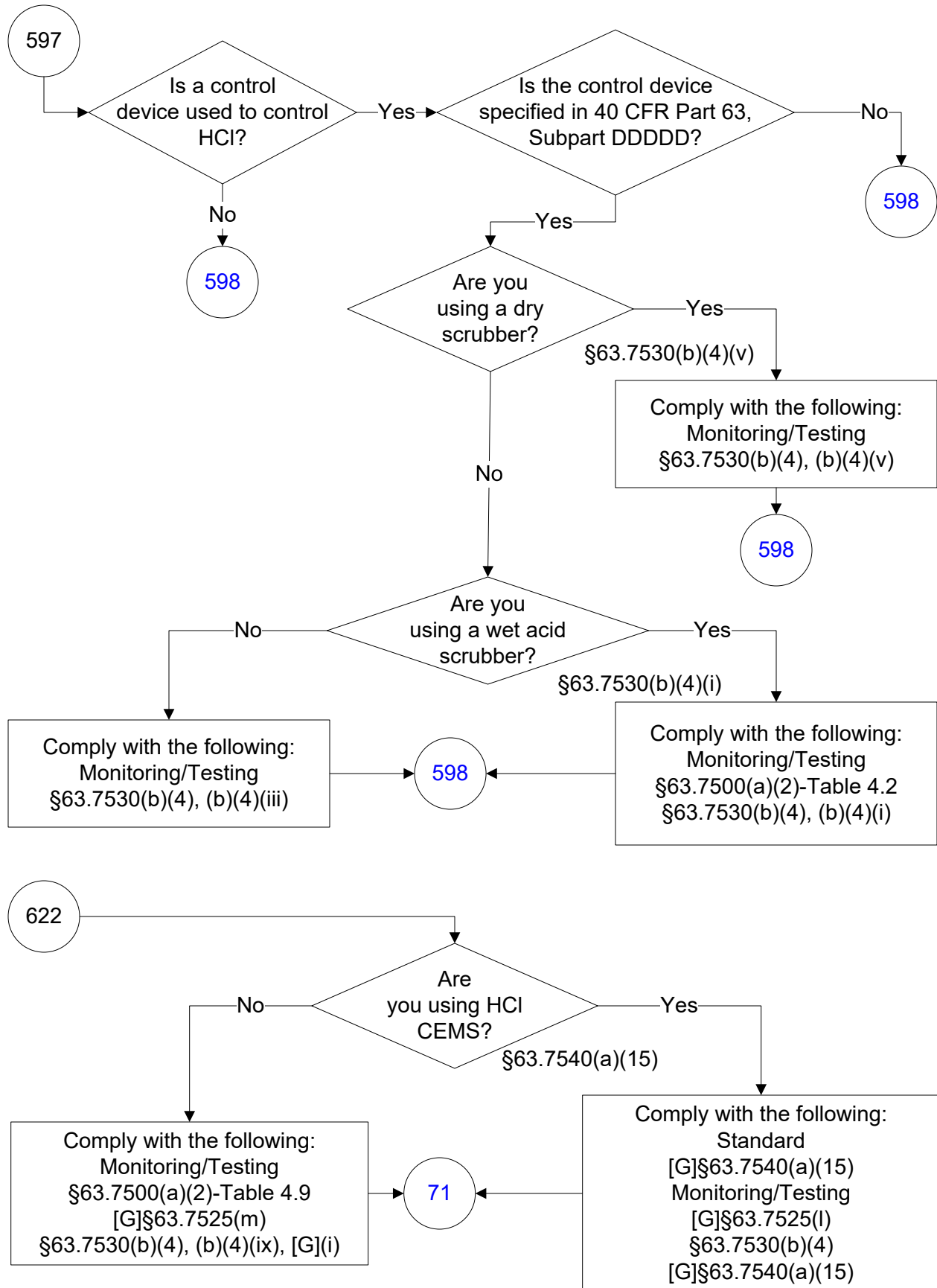

40 CFR Part 63, Subpart DDDDD (230 of 242)

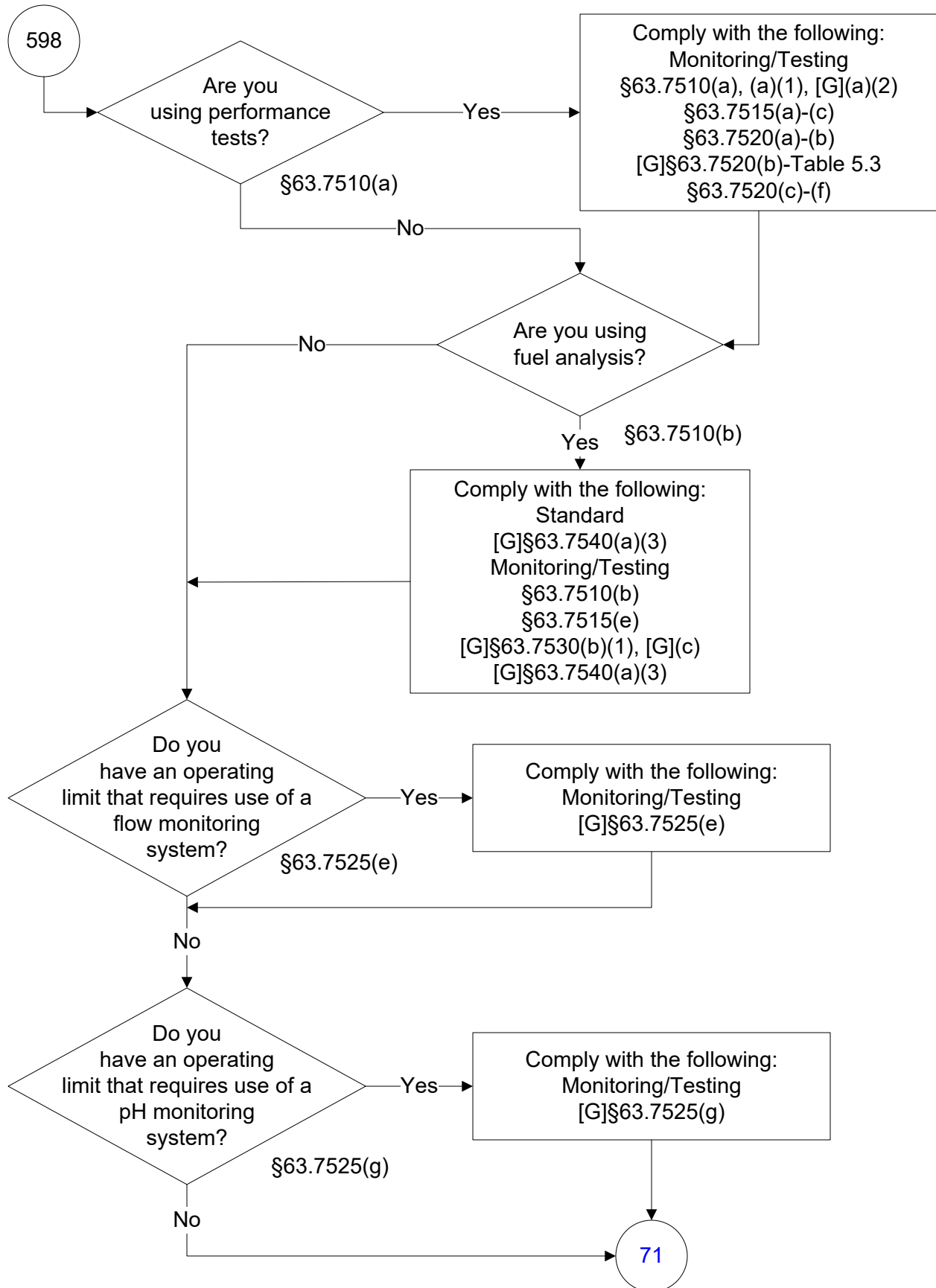

40 CFR Part 63, Subpart DDDDD (231 of 242)

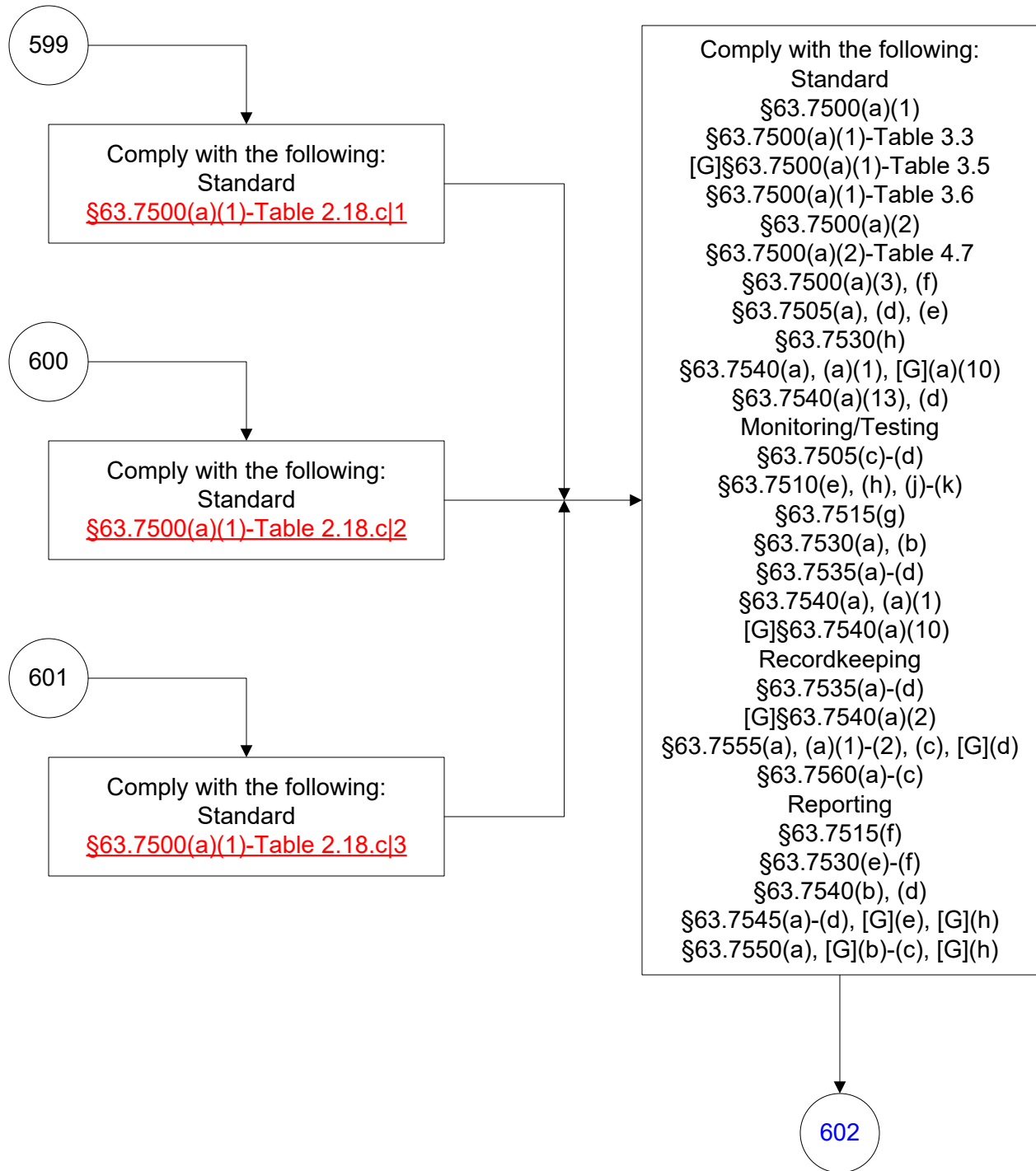

40 CFR Part 63, Subpart DDDDD (232 of 242)

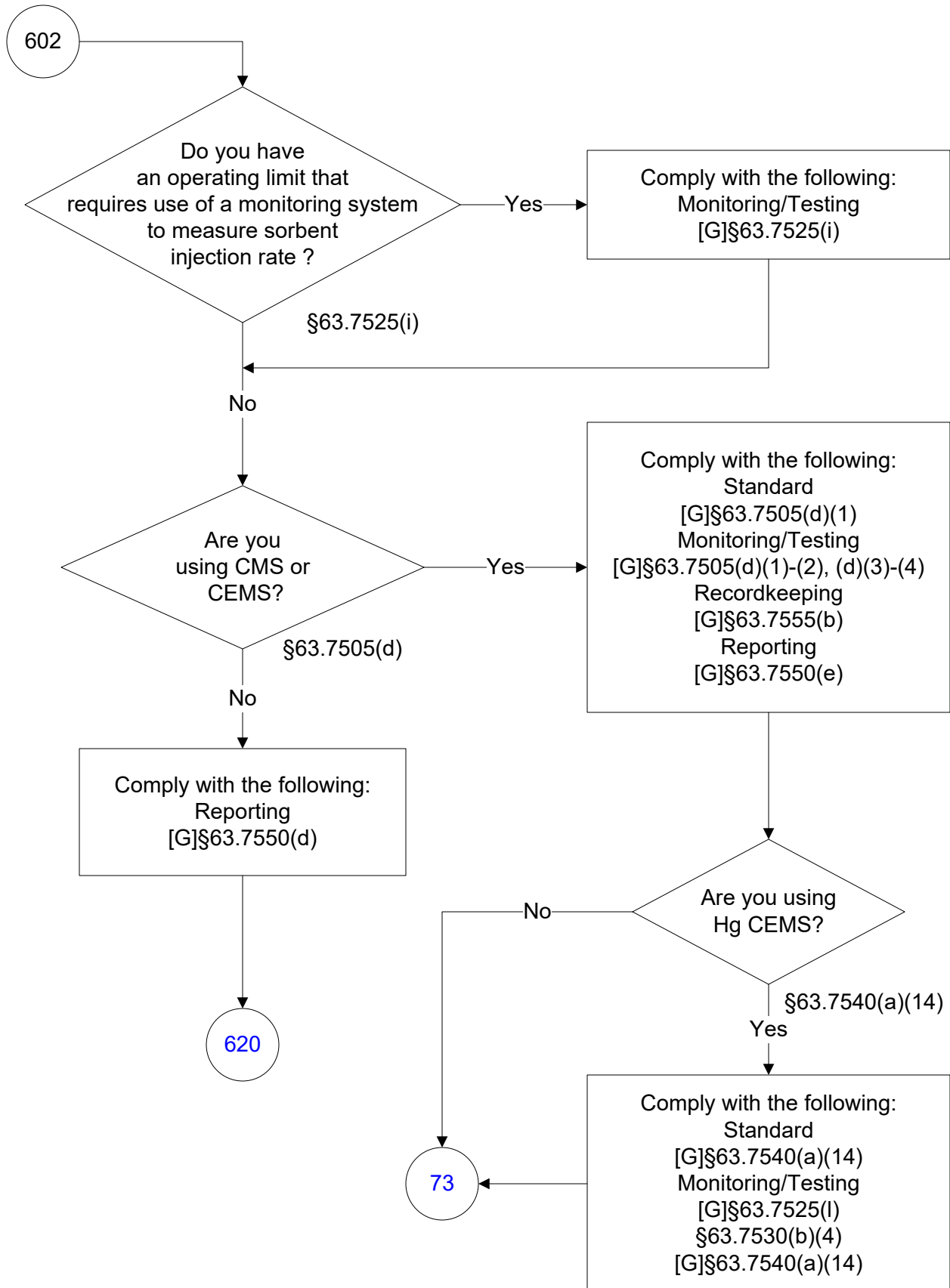

40 CFR Part 63, Subpart DDDDD (233 of 242)

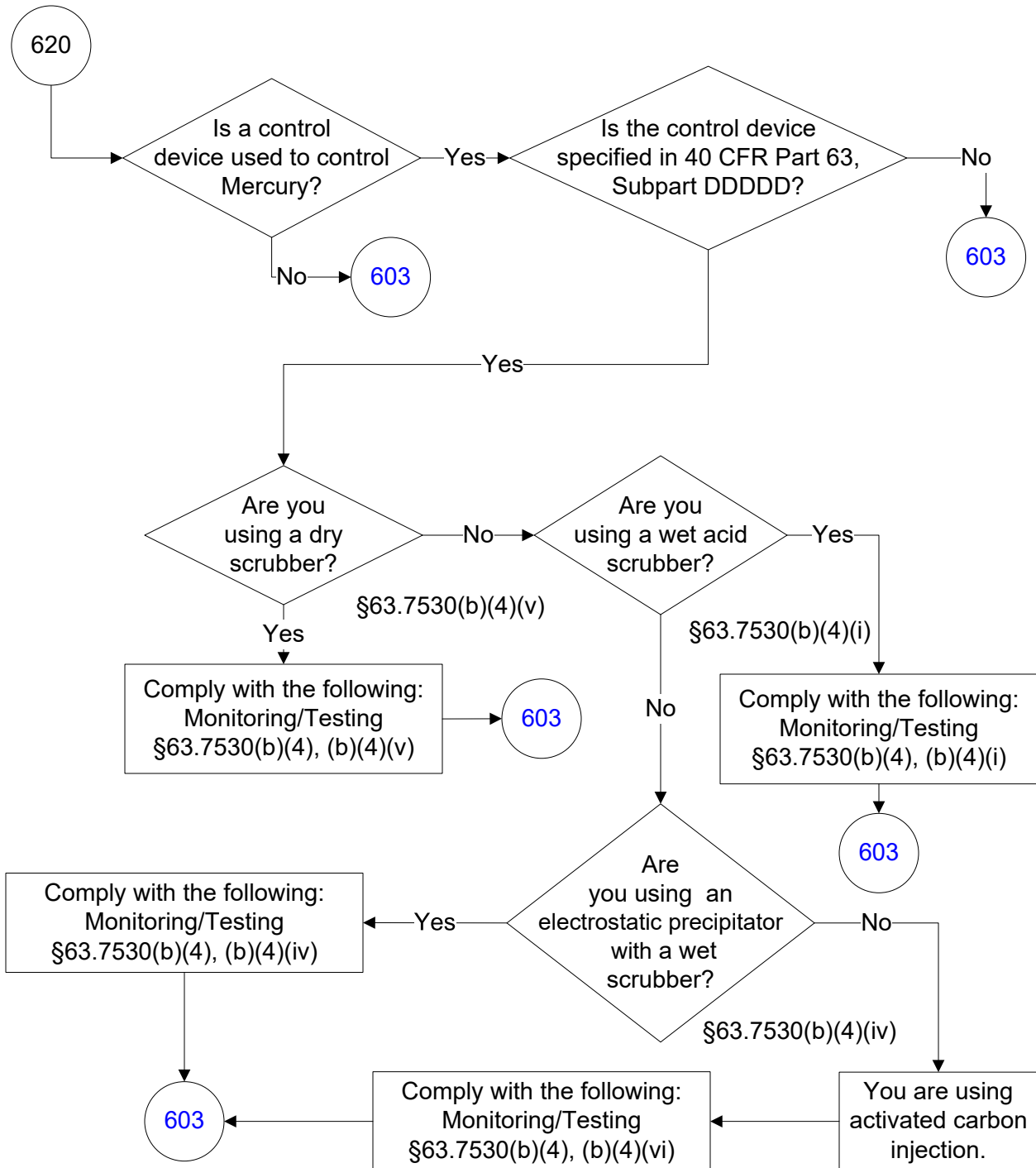

40 CFR Part 63, Subpart DDDDD (234 of 242)

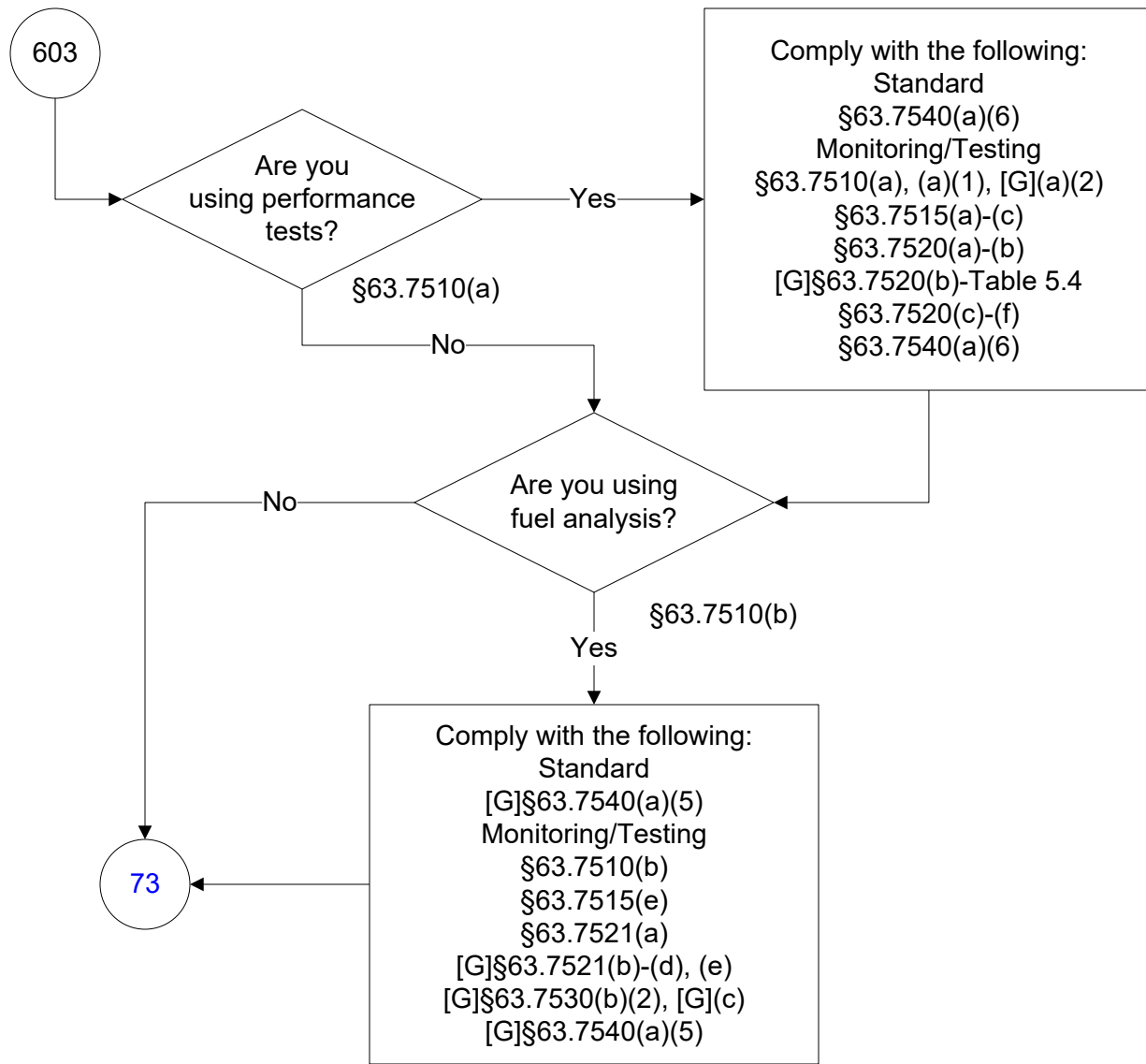

40 CFR Part 63, Subpart DDDDD (235 of 242)

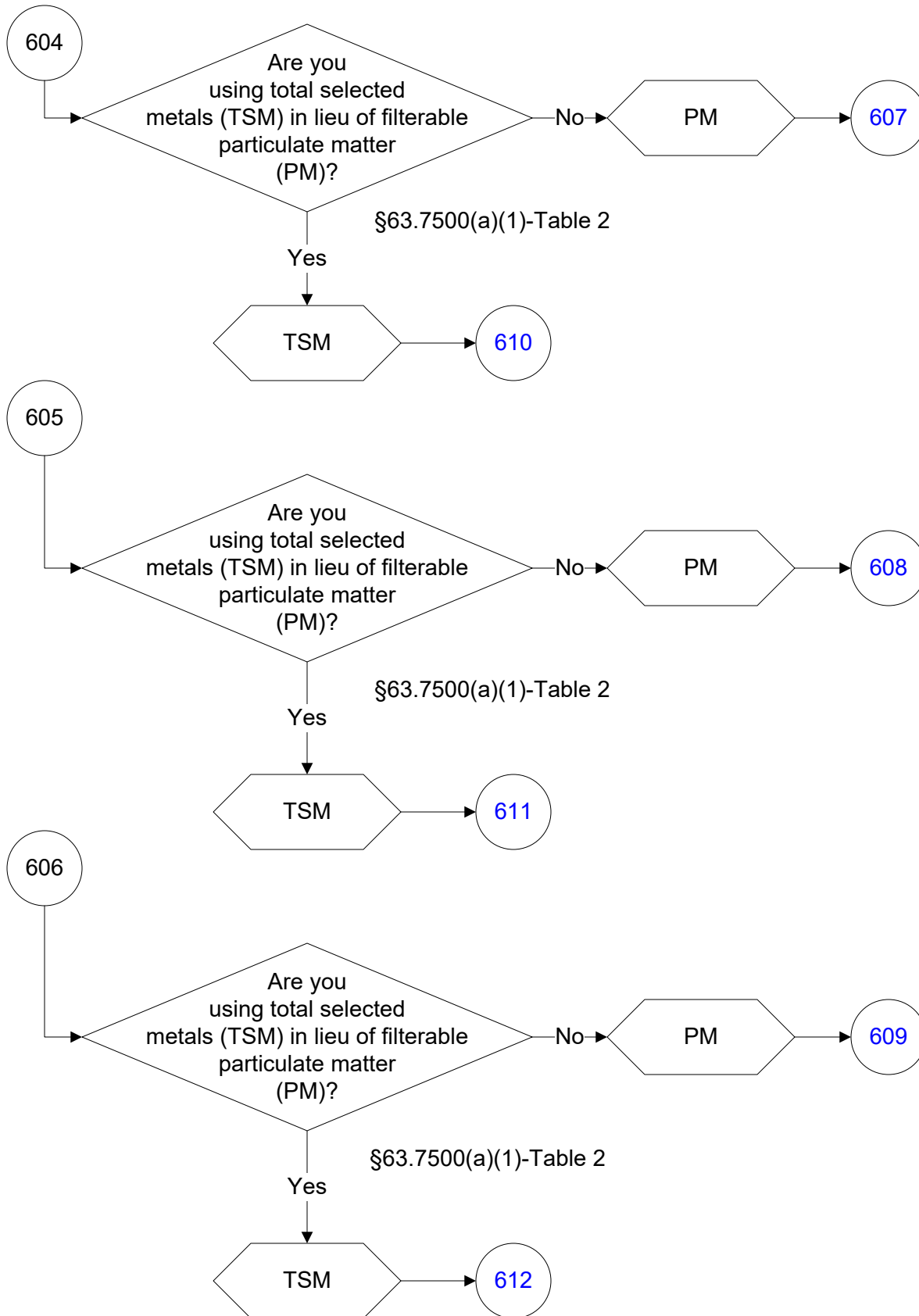

40 CFR Part 63, Subpart DDDDD (236 of 242)

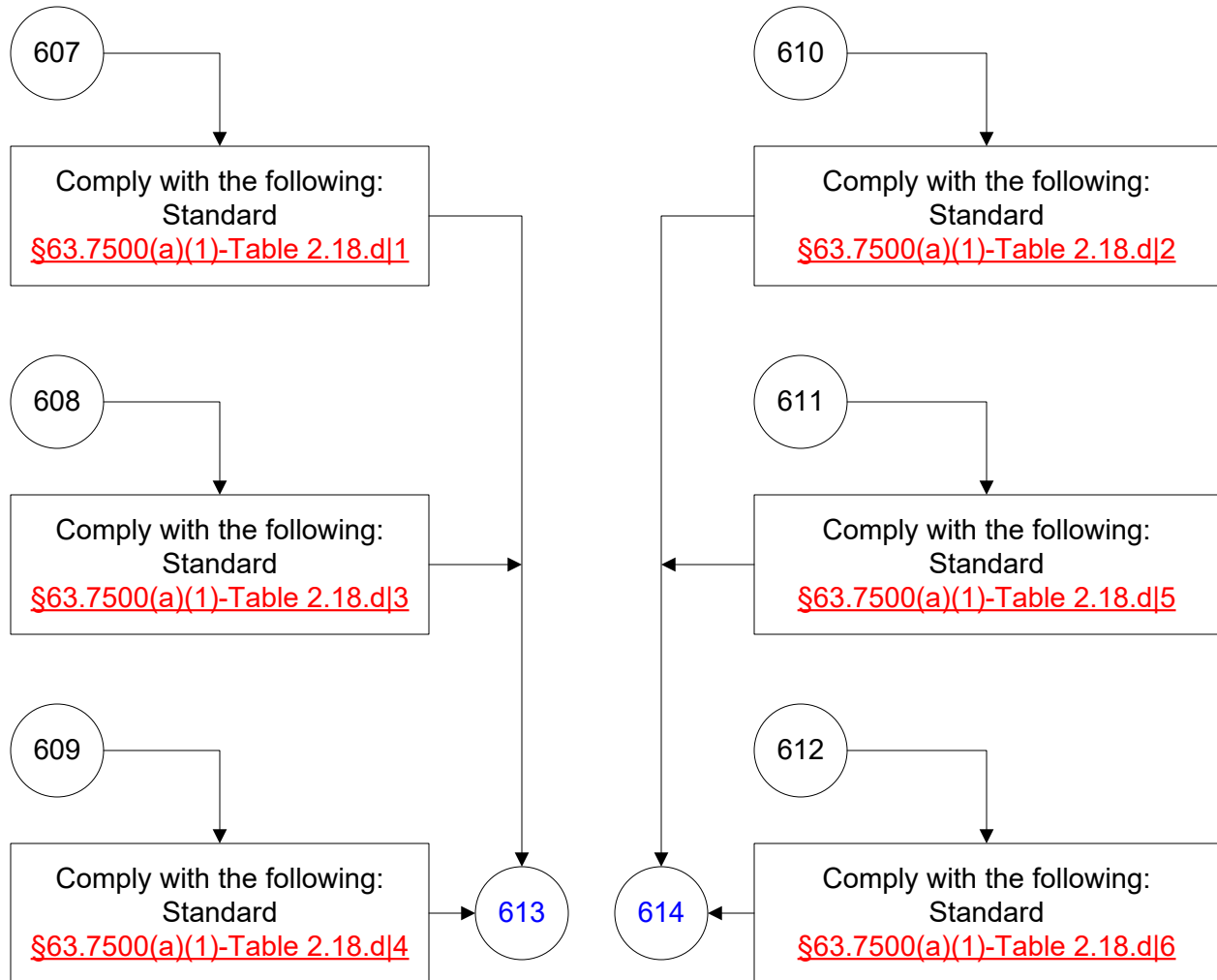

**40 CFR Part 63, Subpart DDDDD
(237 of 242)**

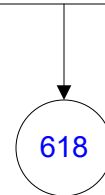
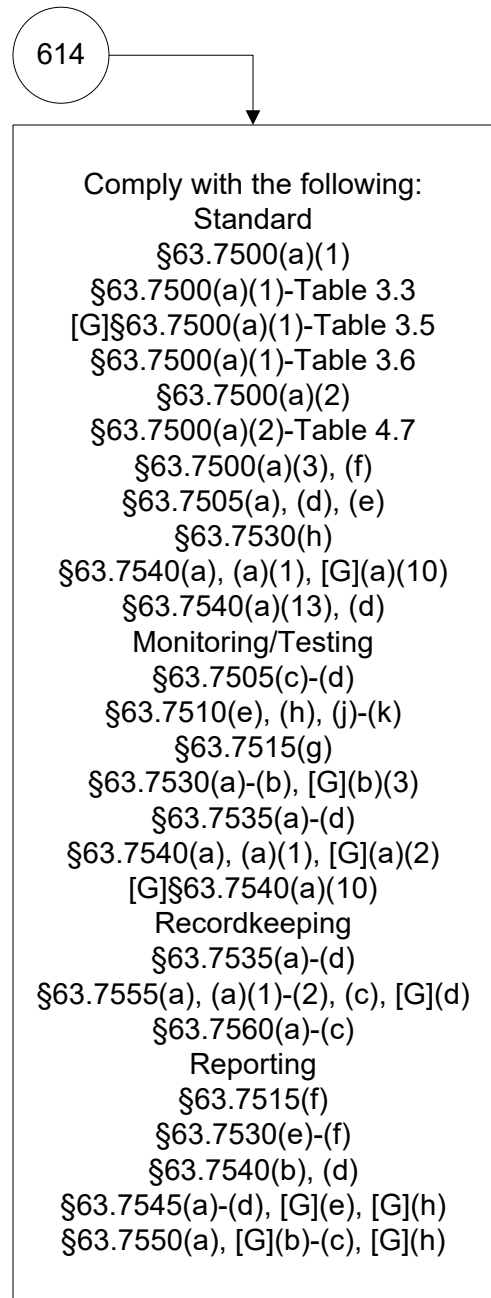
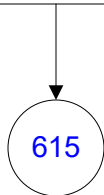
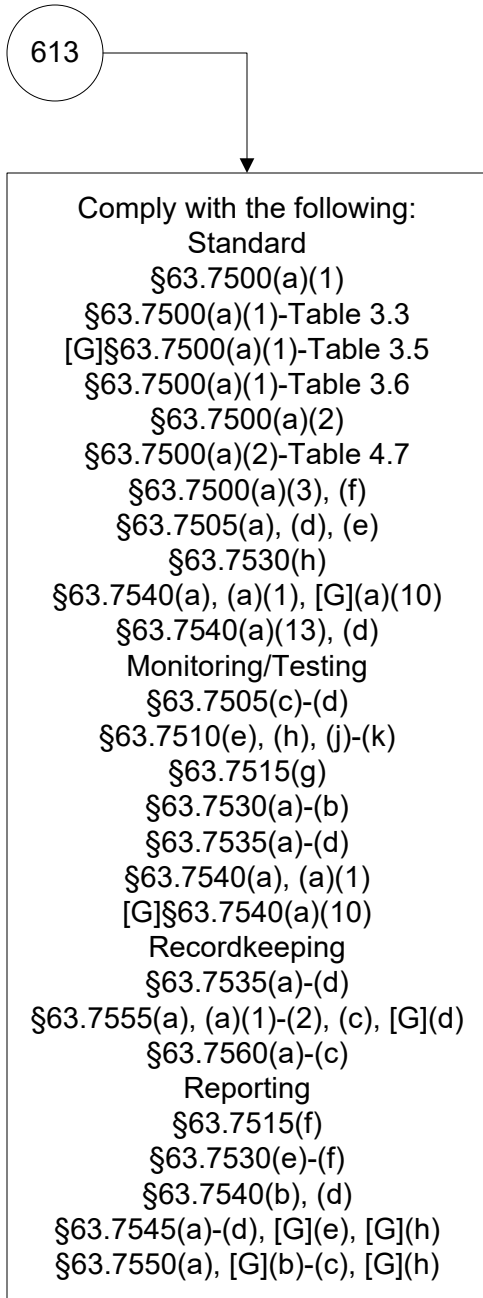

40 CFR Part 63, Subpart DDDDD (238 of 242)

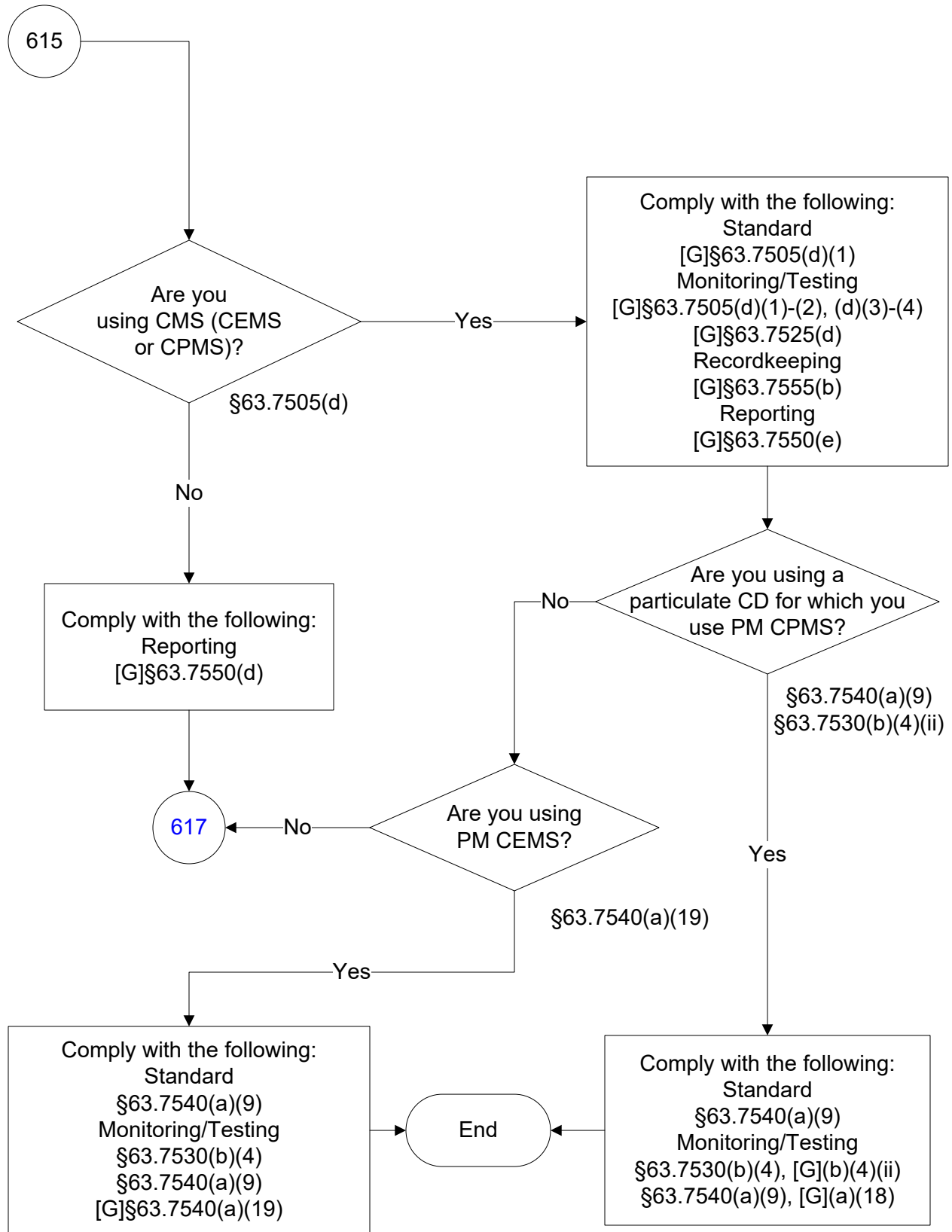

40 CFR Part 63, Subpart DDDDD (239 of 242)

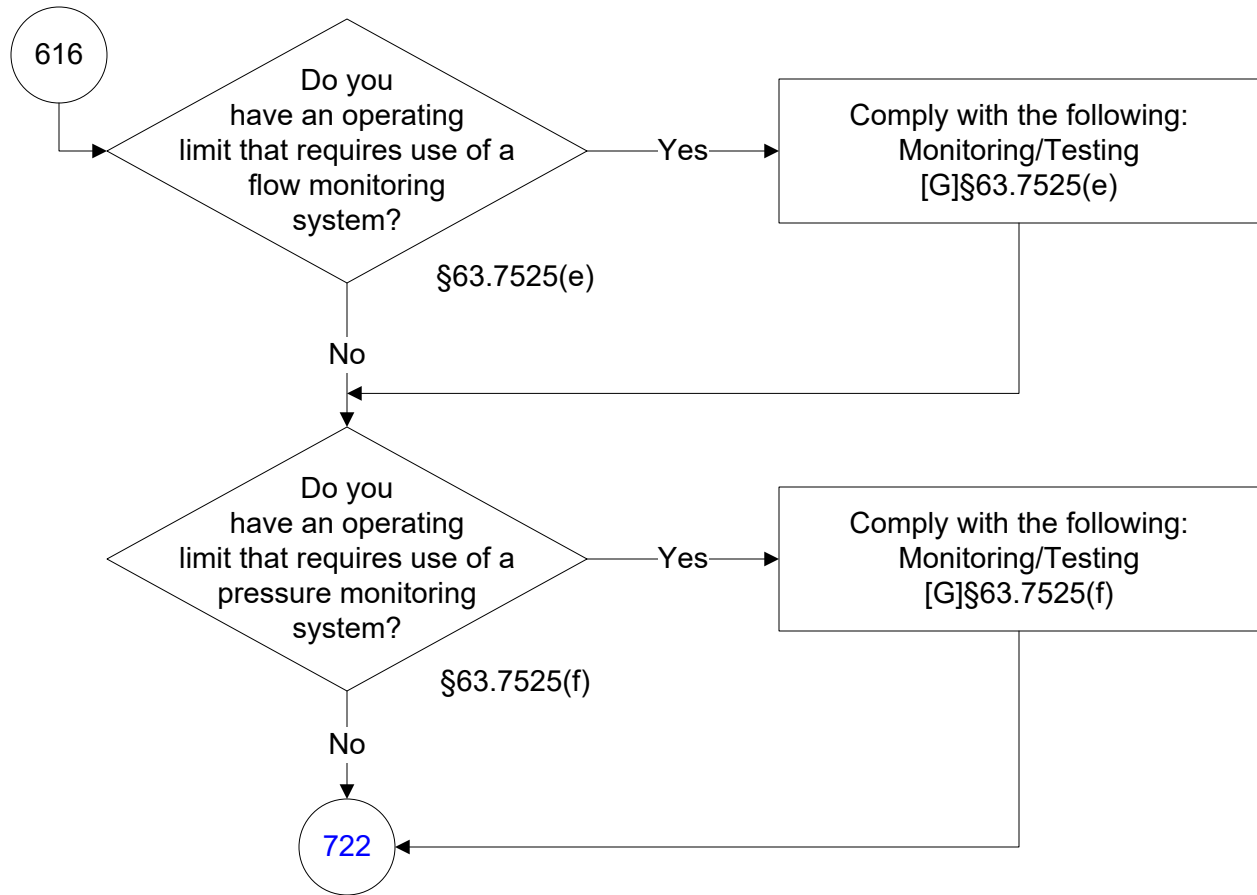

40 CFR Part 63, Subpart DDDDD (240 of 242)

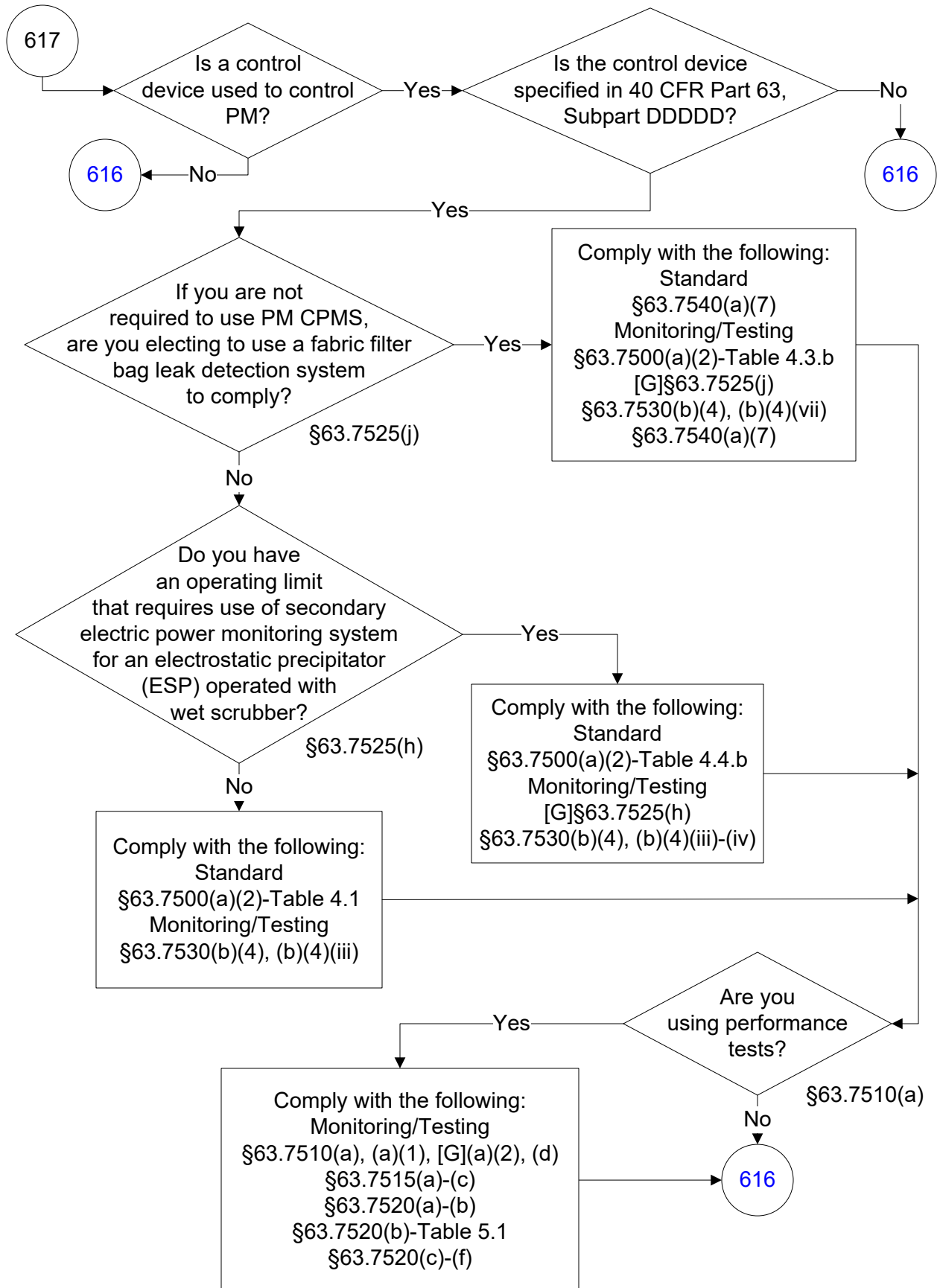

40 CFR Part 63, Subpart DDDDD (241 of 242)

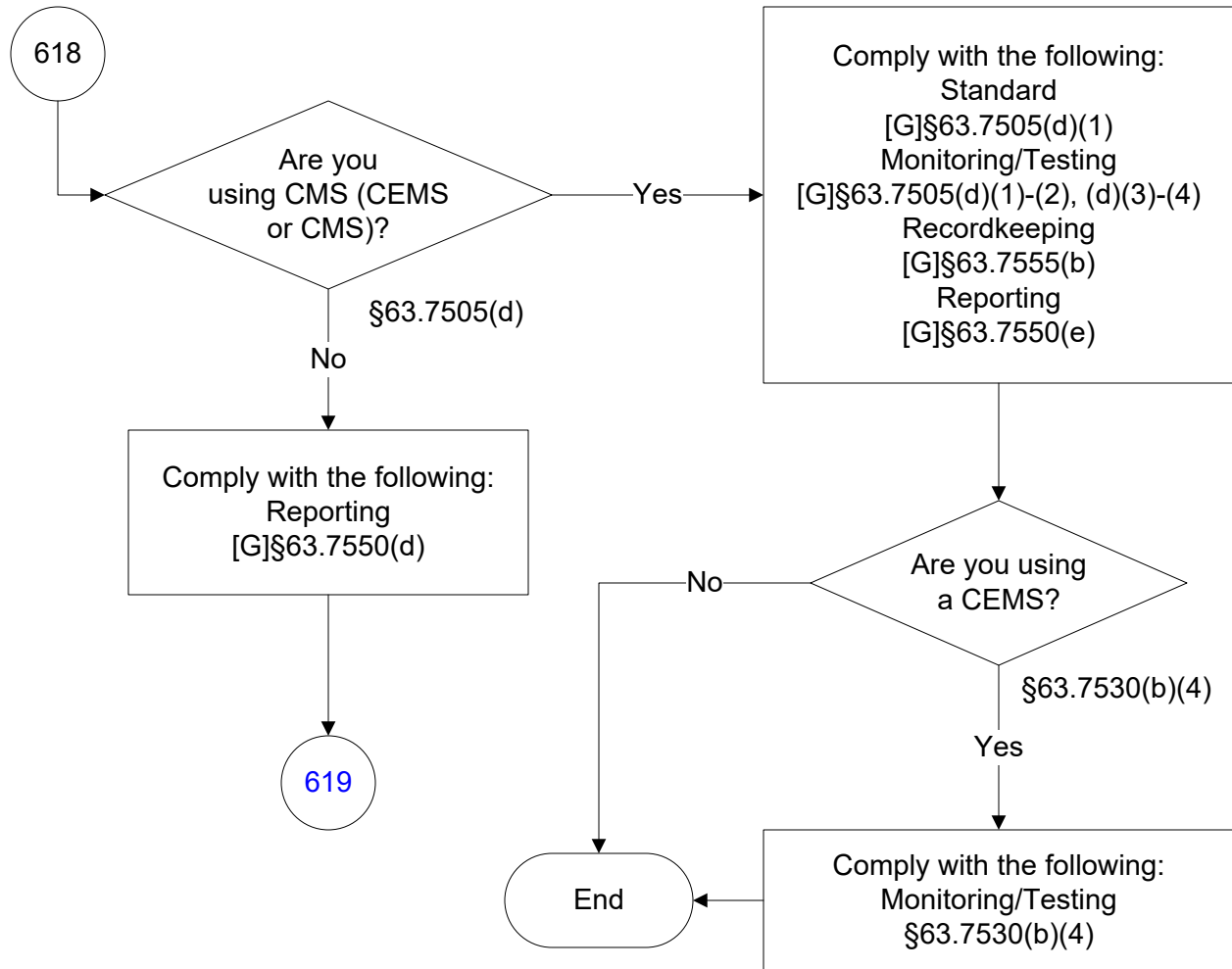

40 CFR Part 63, Subpart DDDDD (242 of 242)

