



Below is a flowchart describing 40 CFR Part 63, Subpart JJJ.

For the text of the statute/rule, please go to

[40 CFR Part 63, Subpart JJJ](#)

(1 of 196)

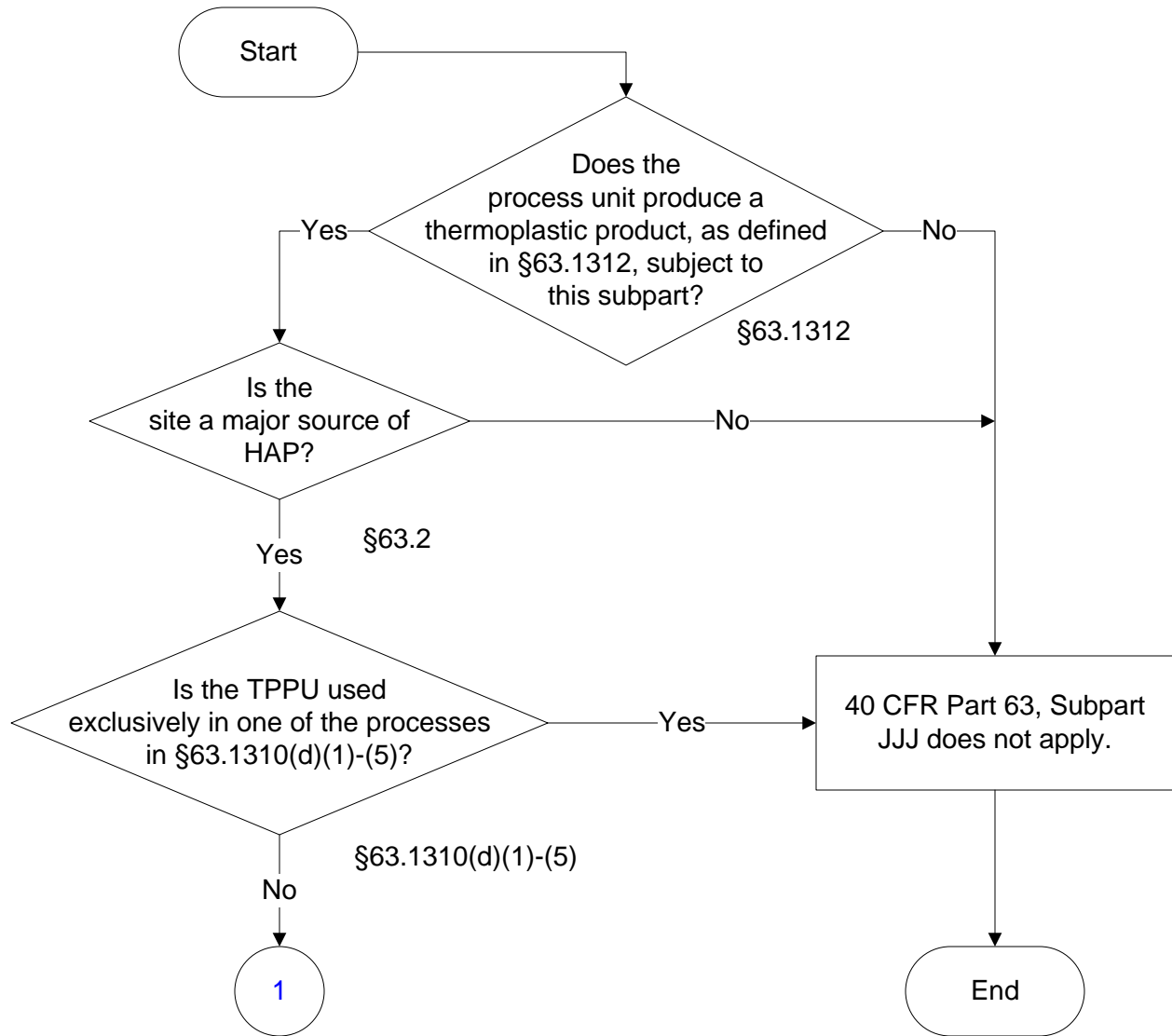

40 CFR Part 63, Subpart JJJ

(2 of 196)

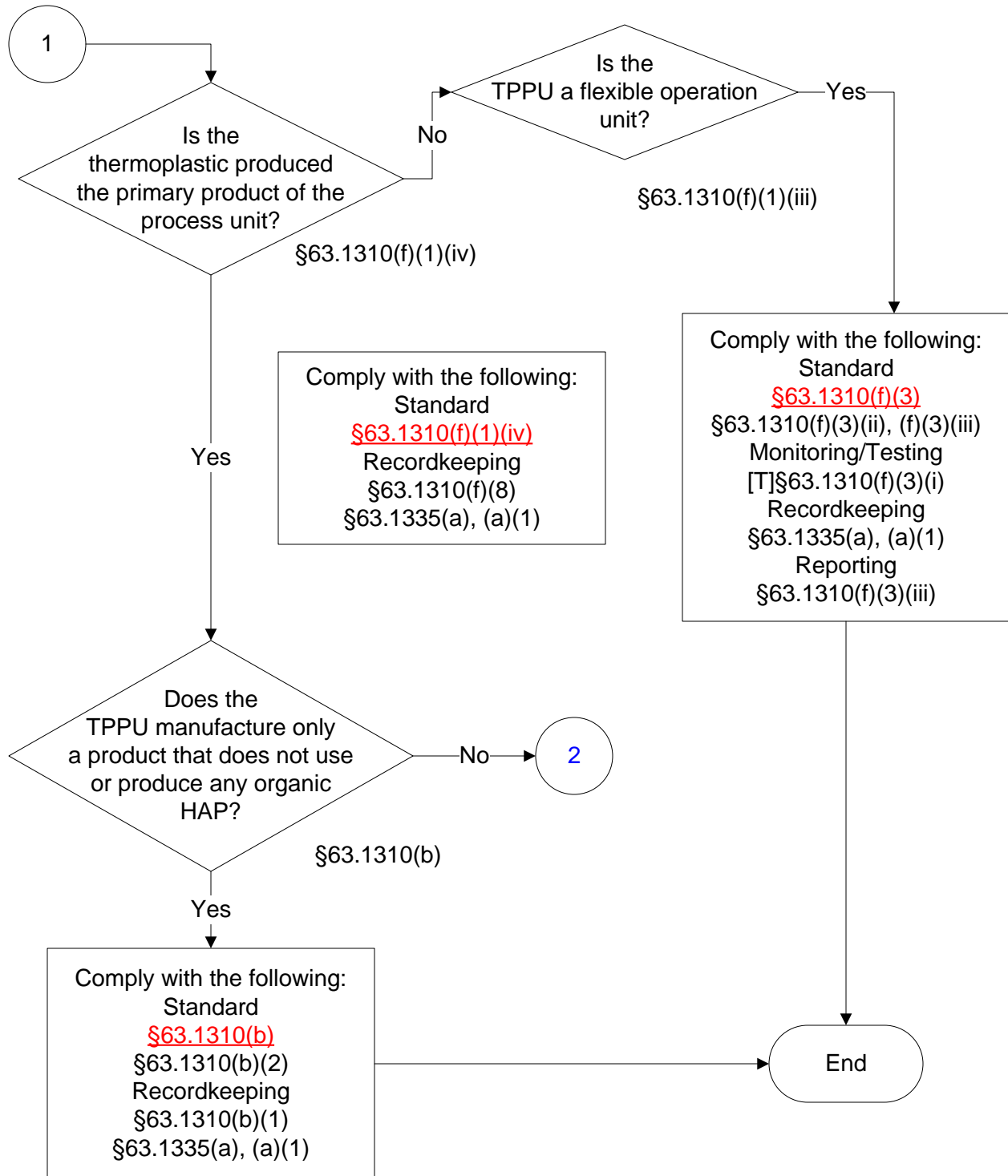

40 CFR Part 63, Subpart JJJ

(3 of 196)

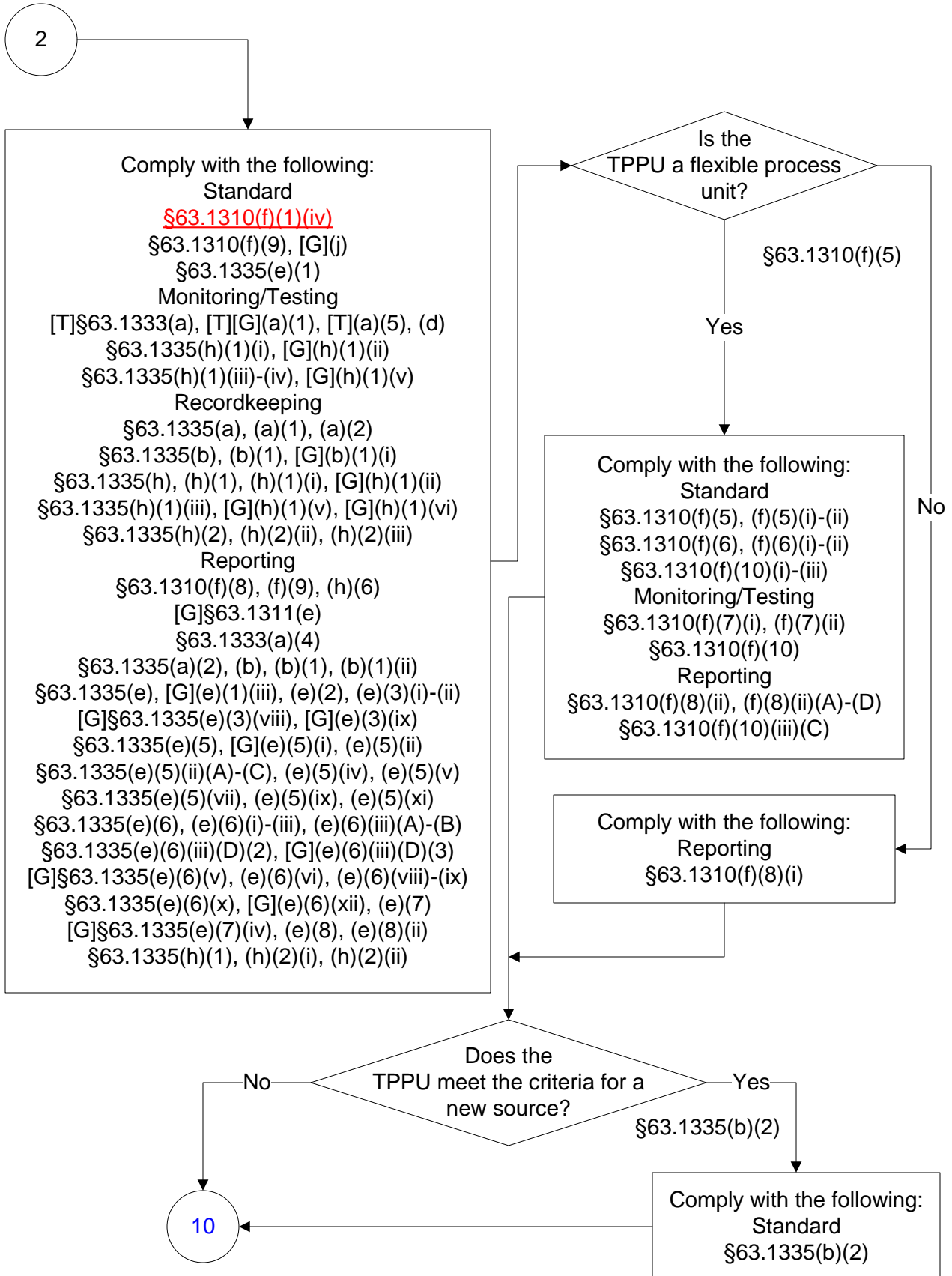

40 CFR Part 63, Subpart JJJ

(4 of 196)

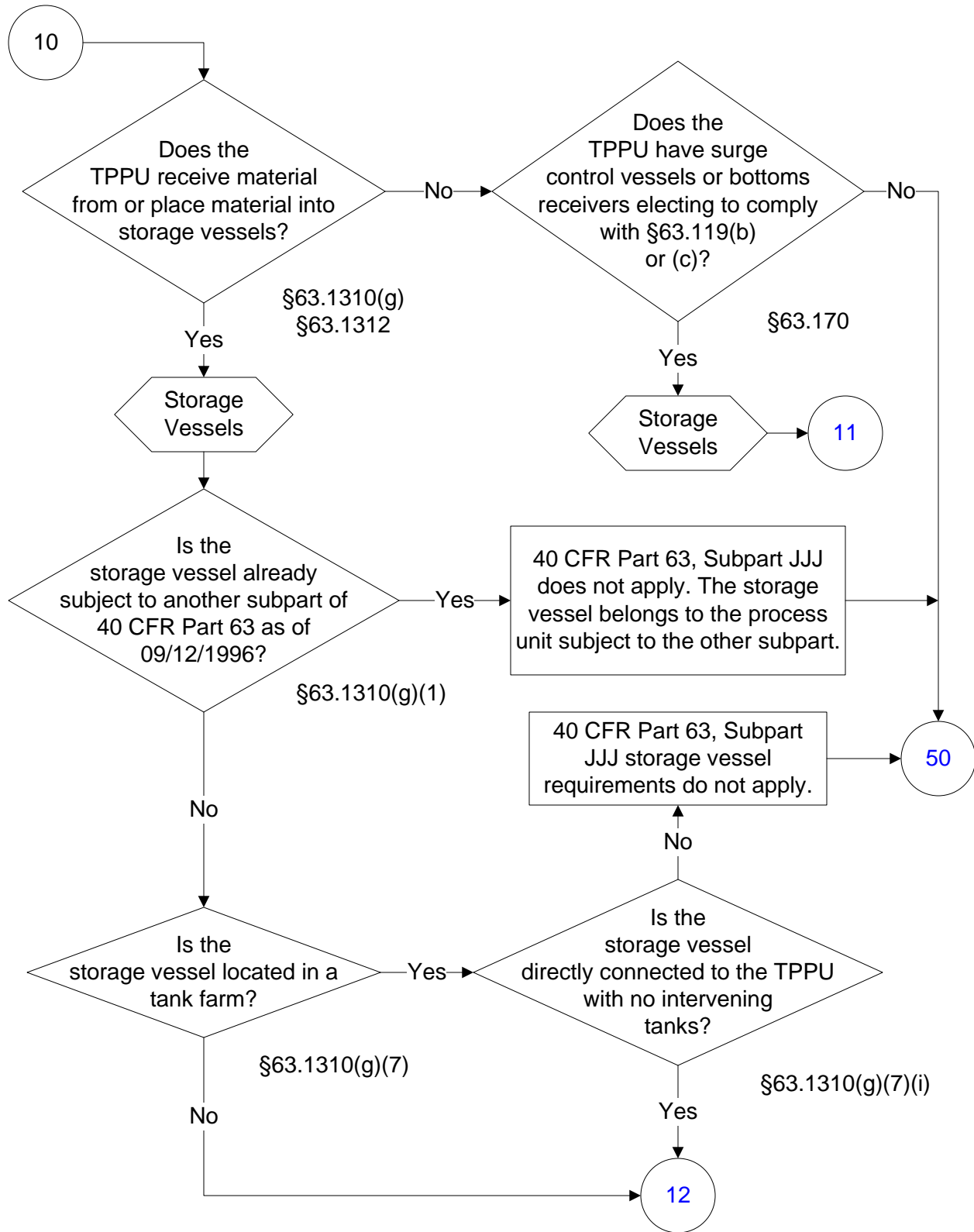

40 CFR Part 63, Subpart JJJ

(5 of 196)

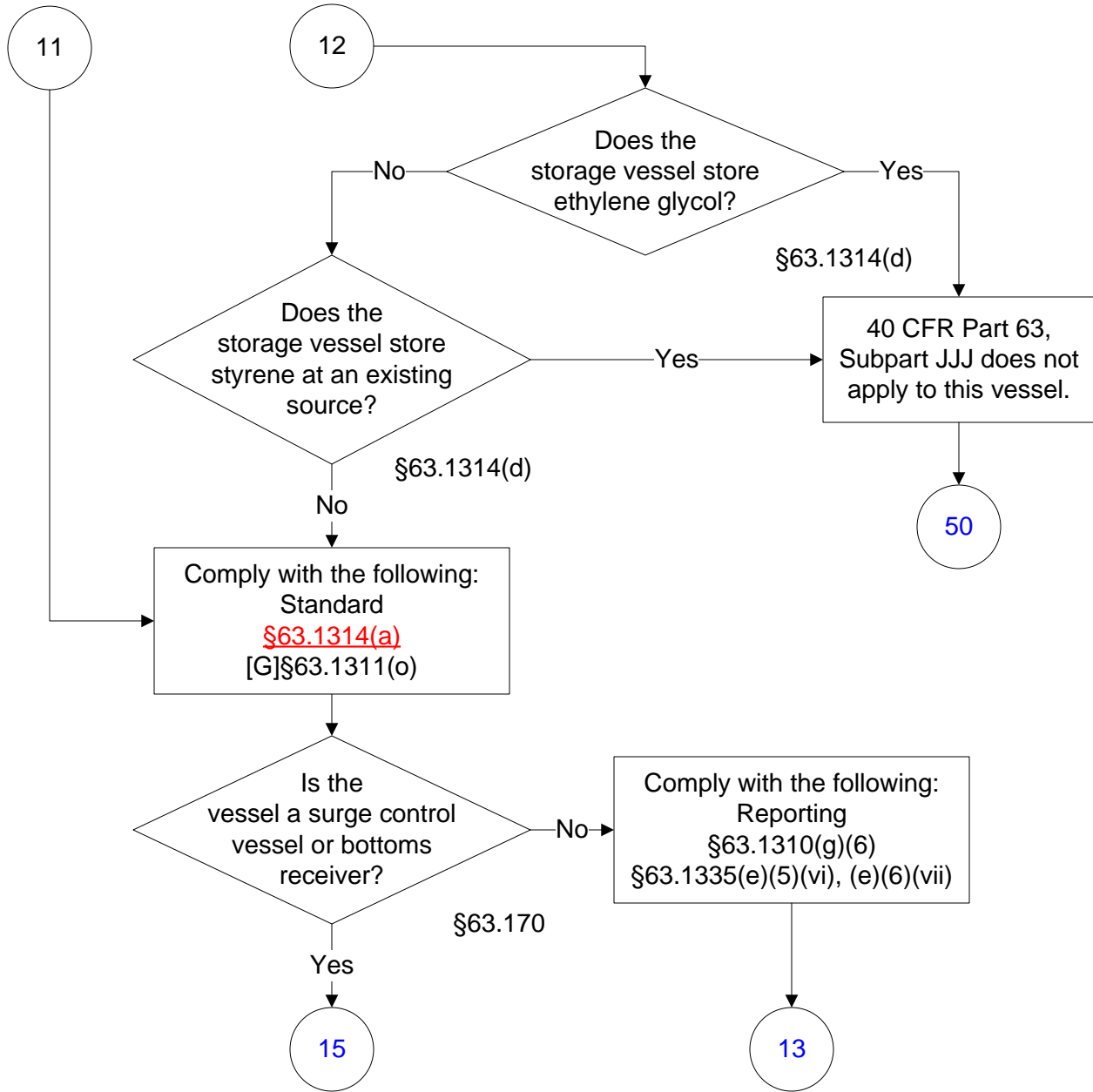

40 CFR Part 63, Subpart JJJ

(6 of 196)

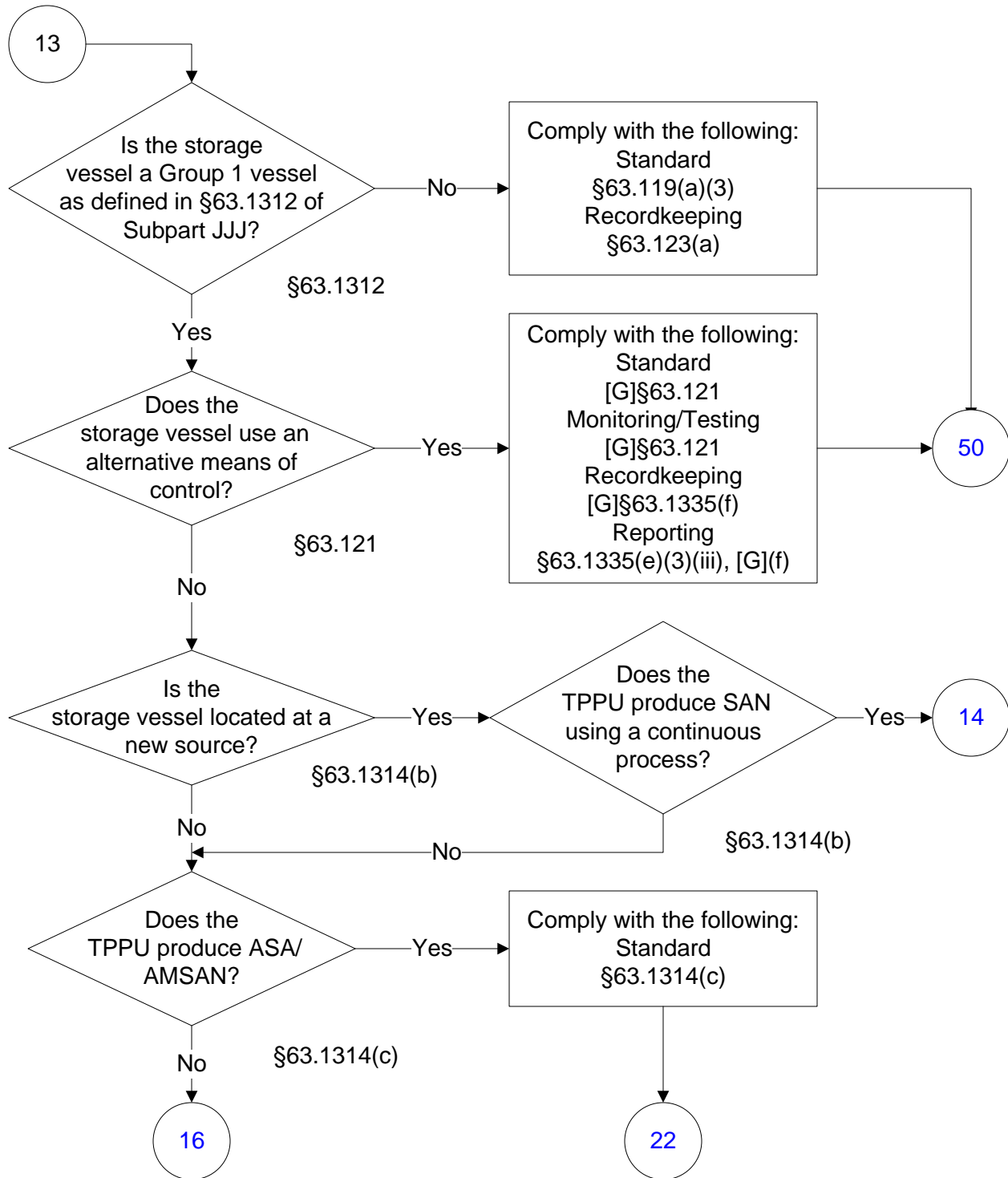

40 CFR Part 63, Subpart JJJ

(7 of 196)

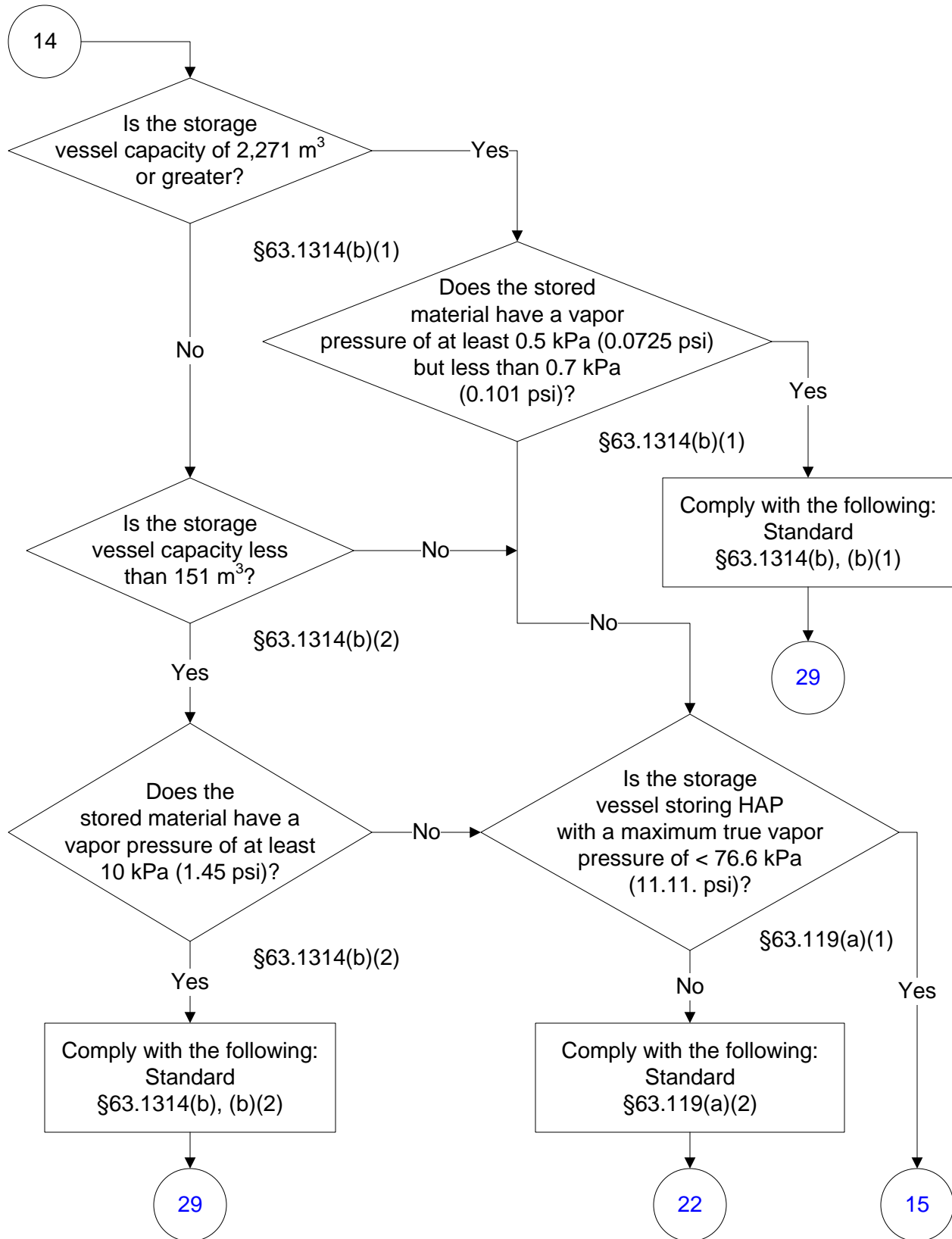

40 CFR Part 63, Subpart JJJ

(8 of 196)

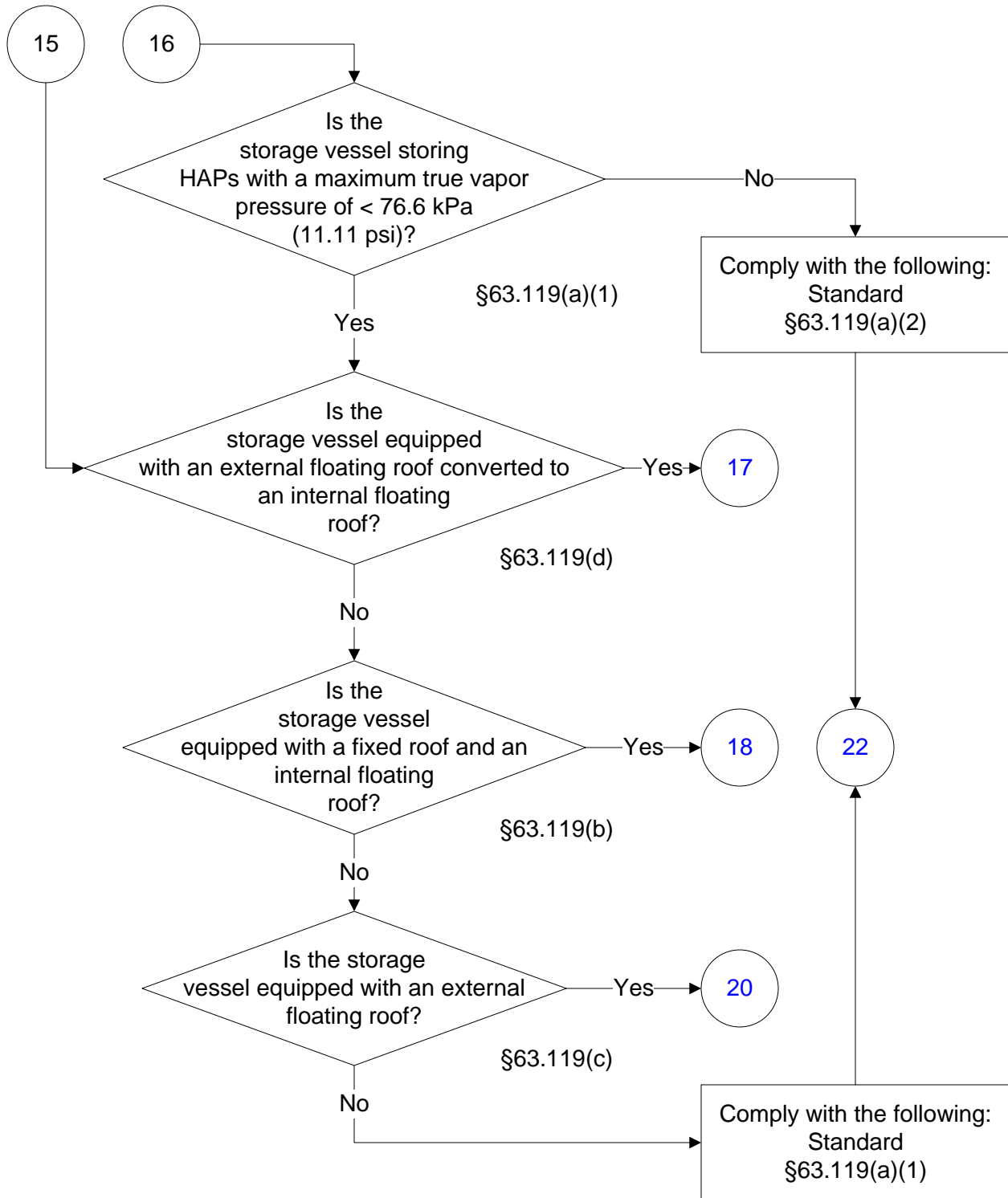

40 CFR Part 63, Subpart JJJ

(9 of 196)

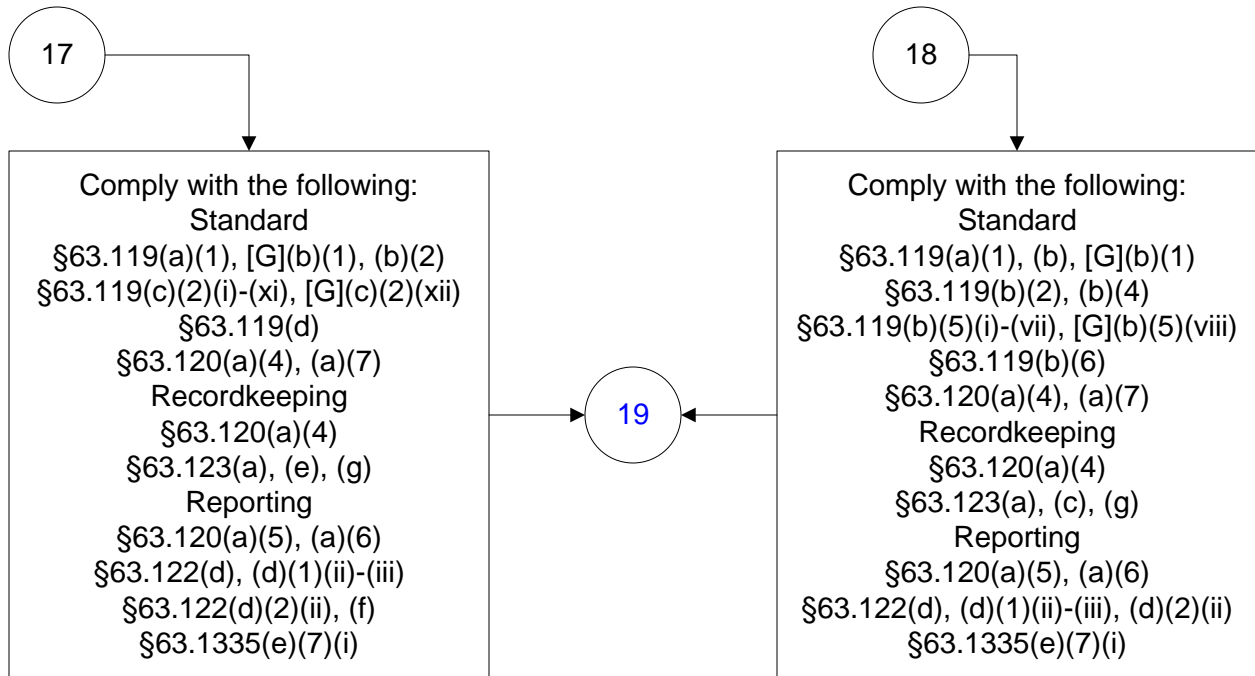

40 CFR Part 63, Subpart JJJ

(10 of 196)

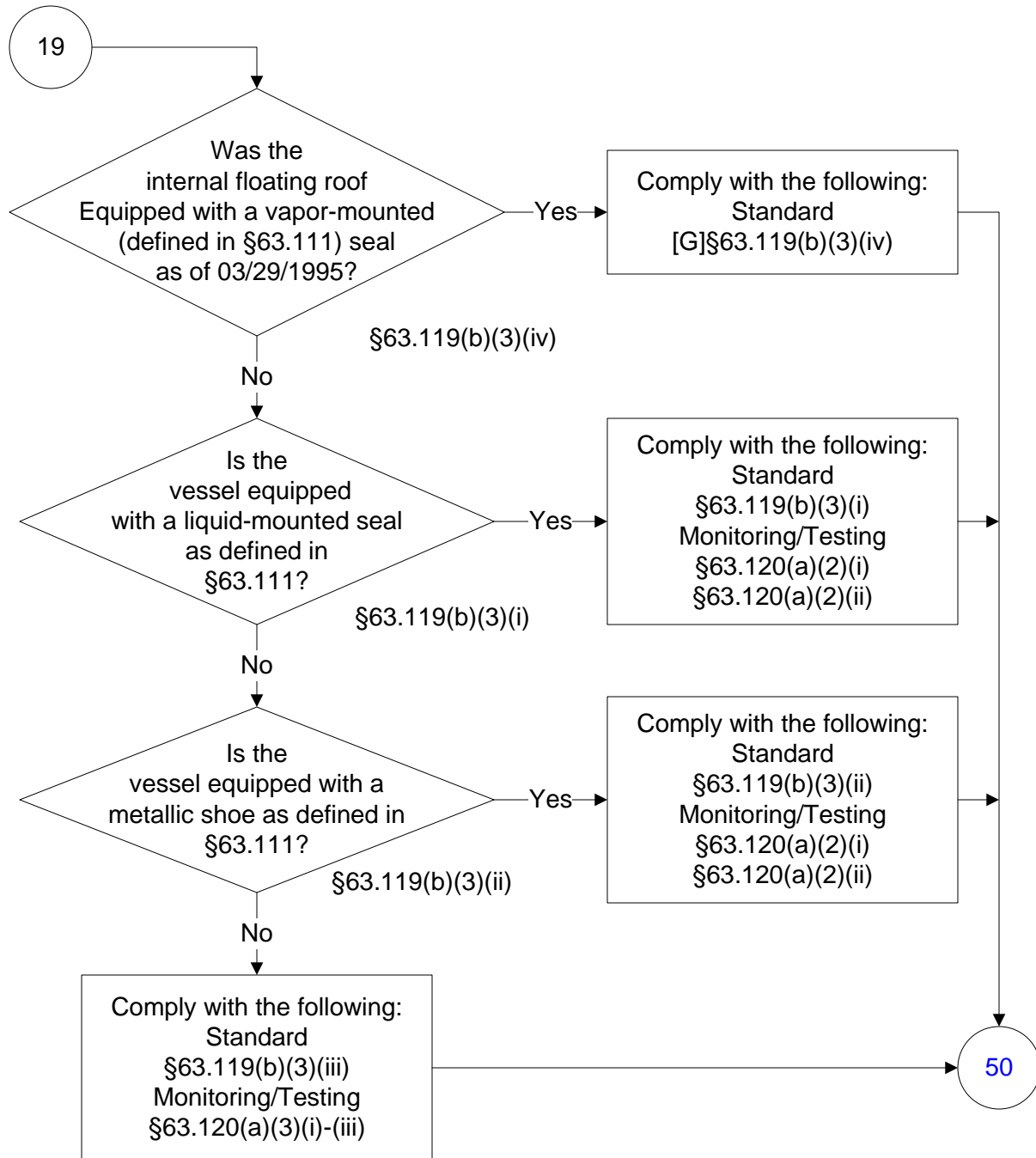

40 CFR Part 63, Subpart JJJ

(11 of 196)

20

Comply with the following:

- Standard
 - §63.119(a)(1), (c), (c)(1), (c)(1)(iii)
 - §63.119(c)(2)(i)-(xi), [G](c)(2)(xii)
 - [G]§63.119(c)(3), (c)(4)
- §63.120(b)(5)(ii), [G](b)(7), (b)(8), (b)(10)(i)
 - Monitoring/Testing
 - §63.120(b)(1)(iv), (b)(2)(i)-(iii)
 - §63.120(b)(3), (b)(10)
 - Recordkeeping
 - [G]§63.120(b)(7), (b)(8)
 - §63.123(a), (d), (g)
 - Reporting
 - §63.120(b)(9), (b)(10)(ii)-(iii)
 - [G]§63.122(e)(1), (e)(2)-(3), (e)(3)(ii)
 - §63.1335(e)(7)(i)

21

40 CFR Part 63, Subpart JJJ

(12 of 196)

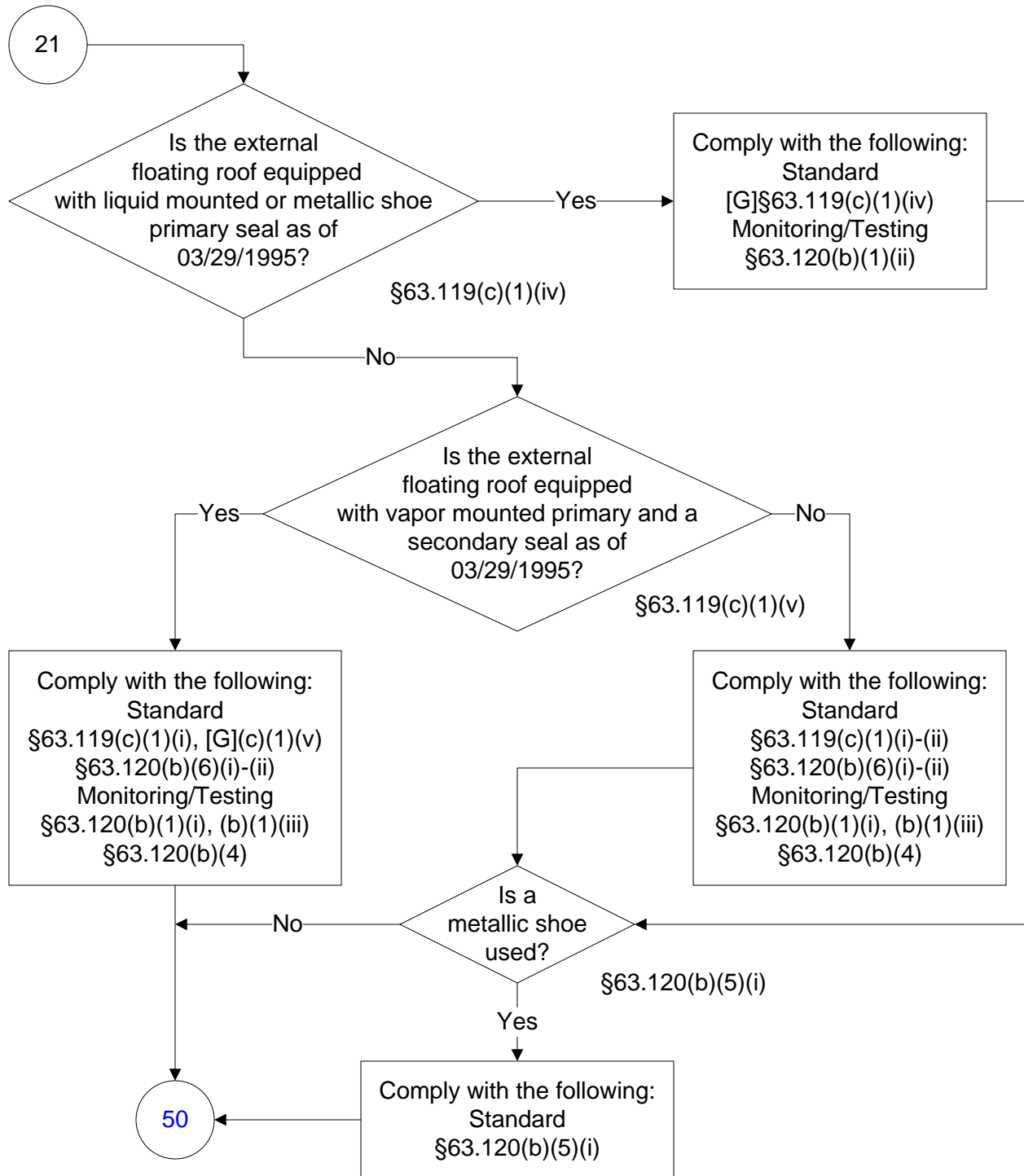

40 CFR Part 63, Subpart JJJ

(13 of 196)

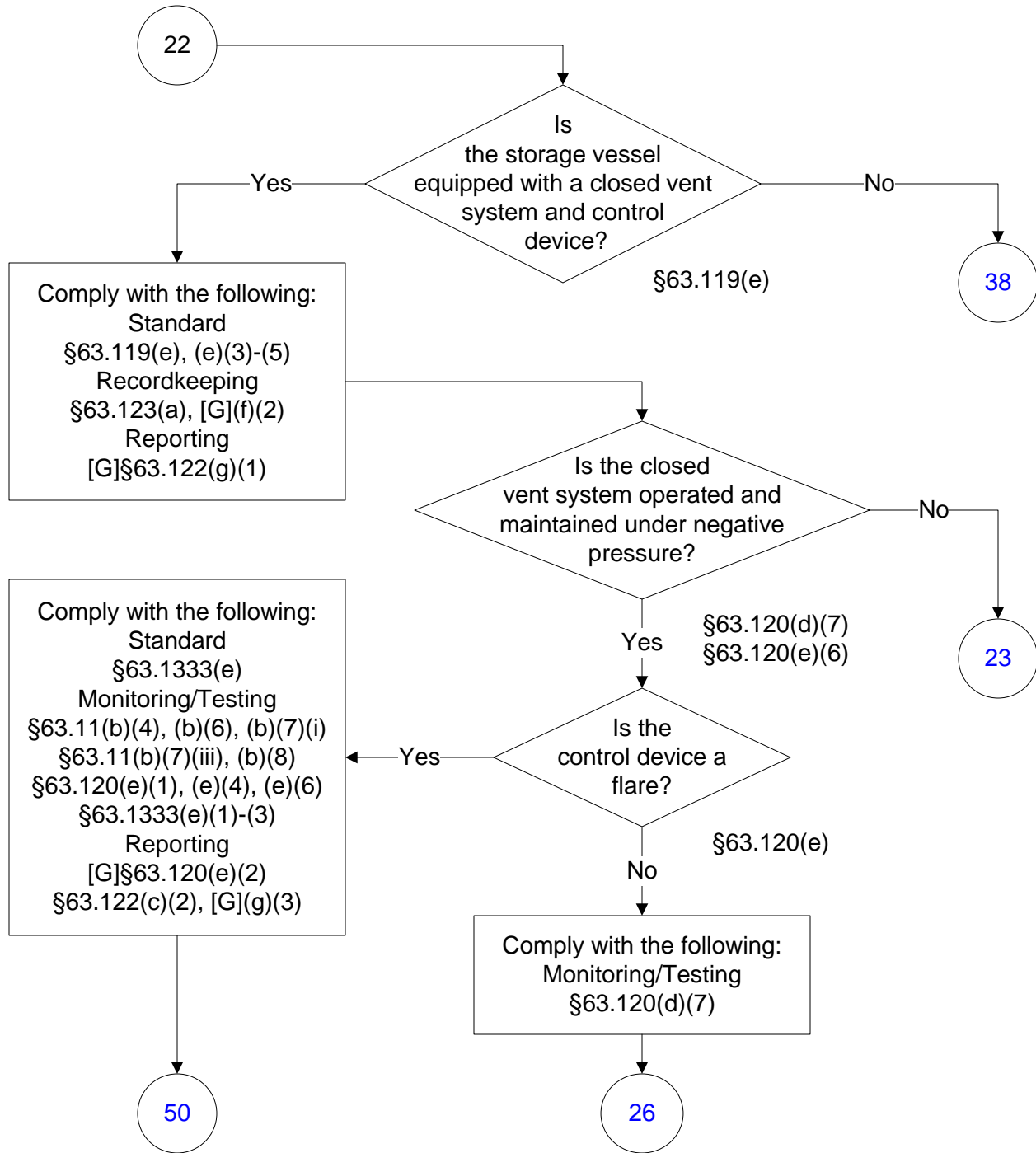

40 CFR Part 63, Subpart JJJ

(14 of 196)

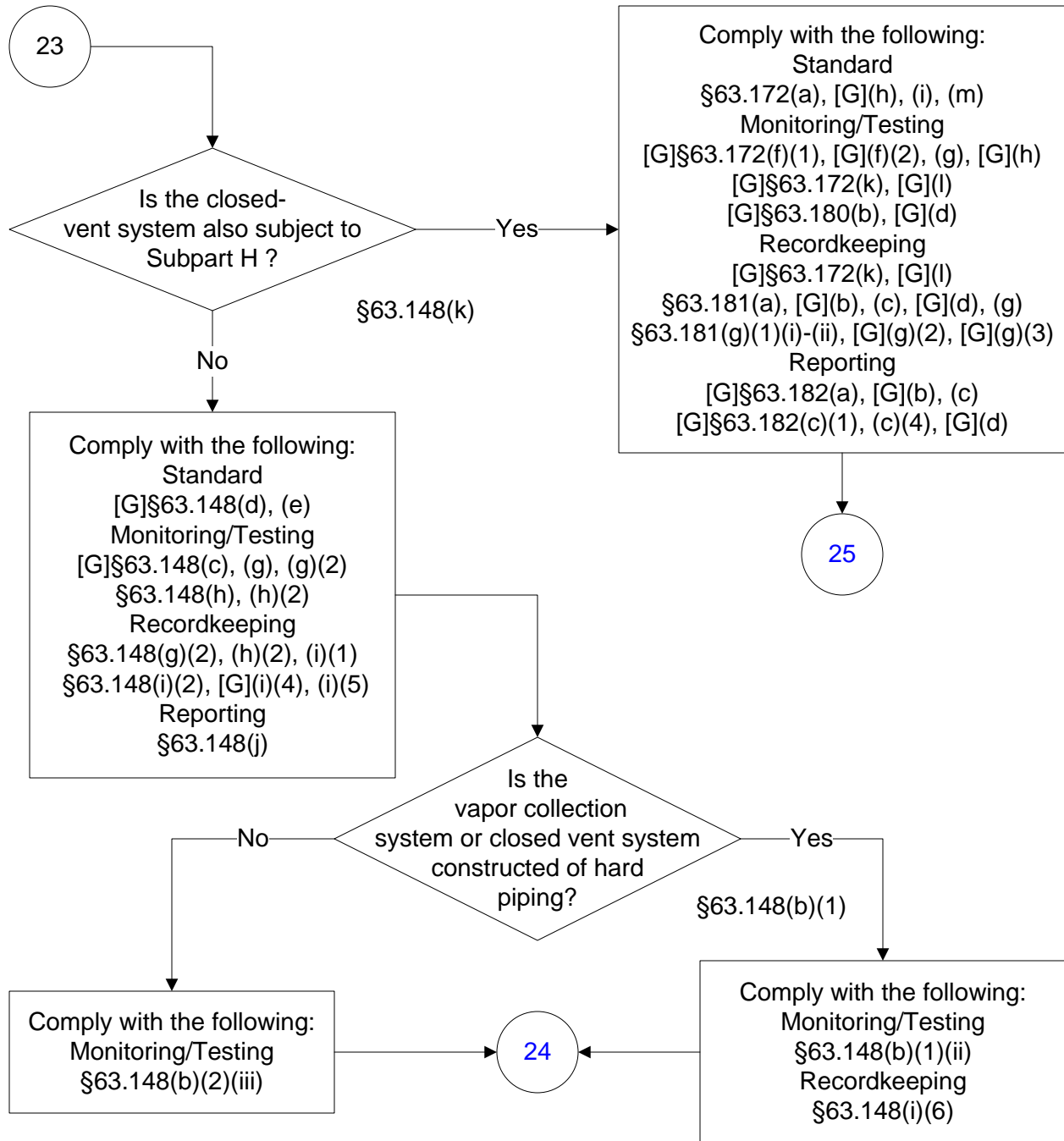

40 CFR Part 63, Subpart JJJ

(15 of 196)

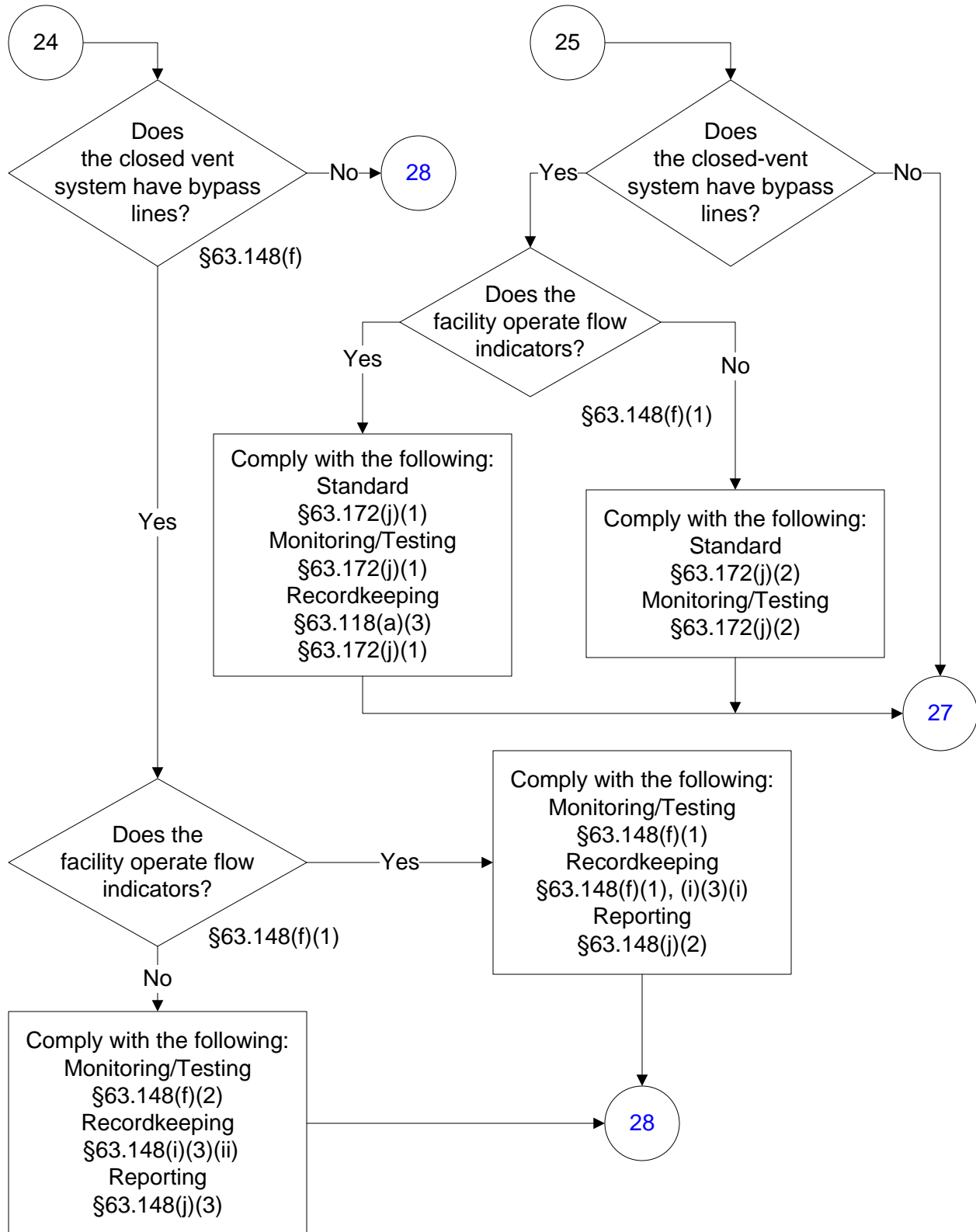

40 CFR Part 63, Subpart JJJ

(16 of 196)

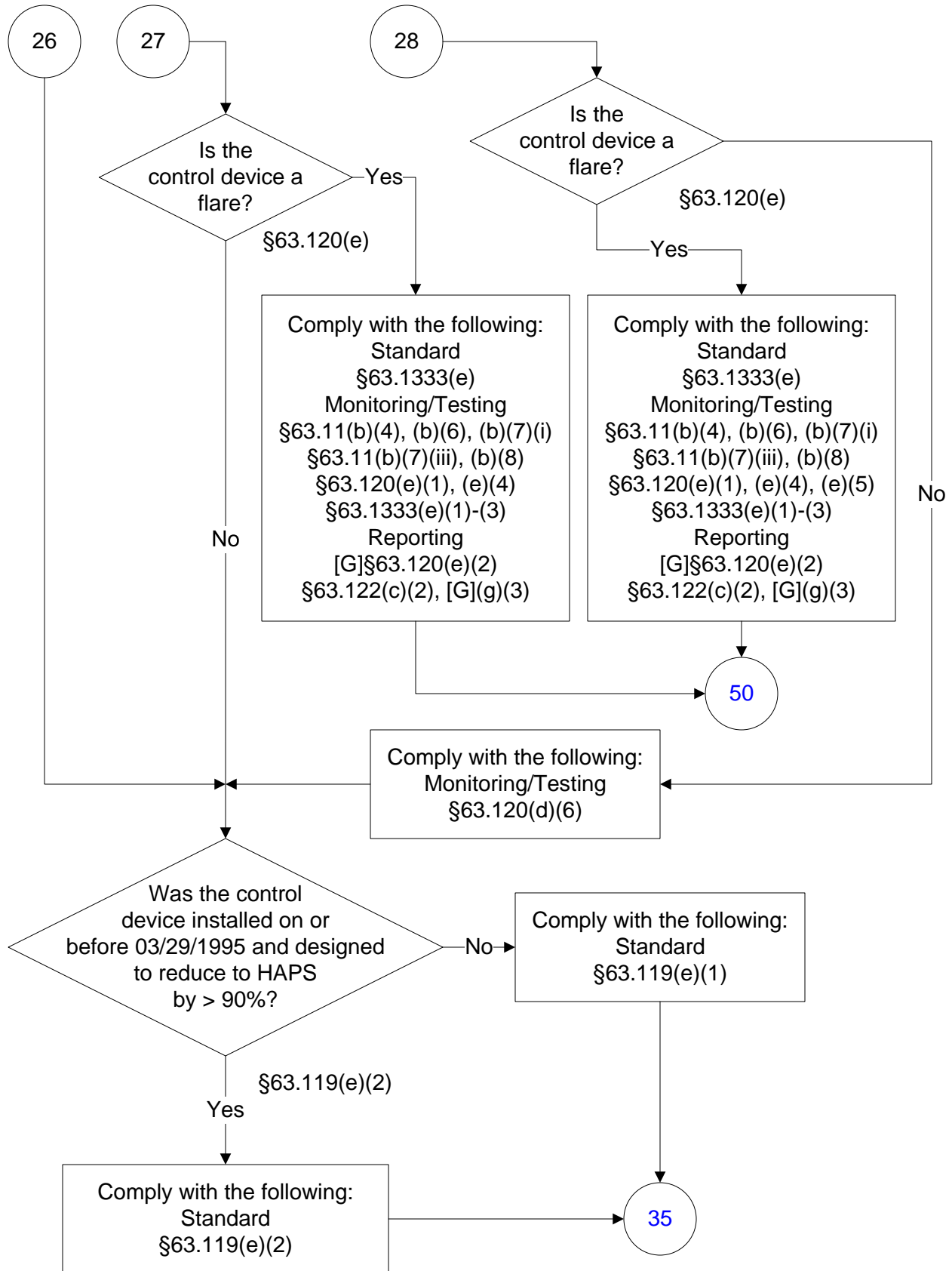

40 CFR Part 63, Subpart JJJ

(17 of 196)

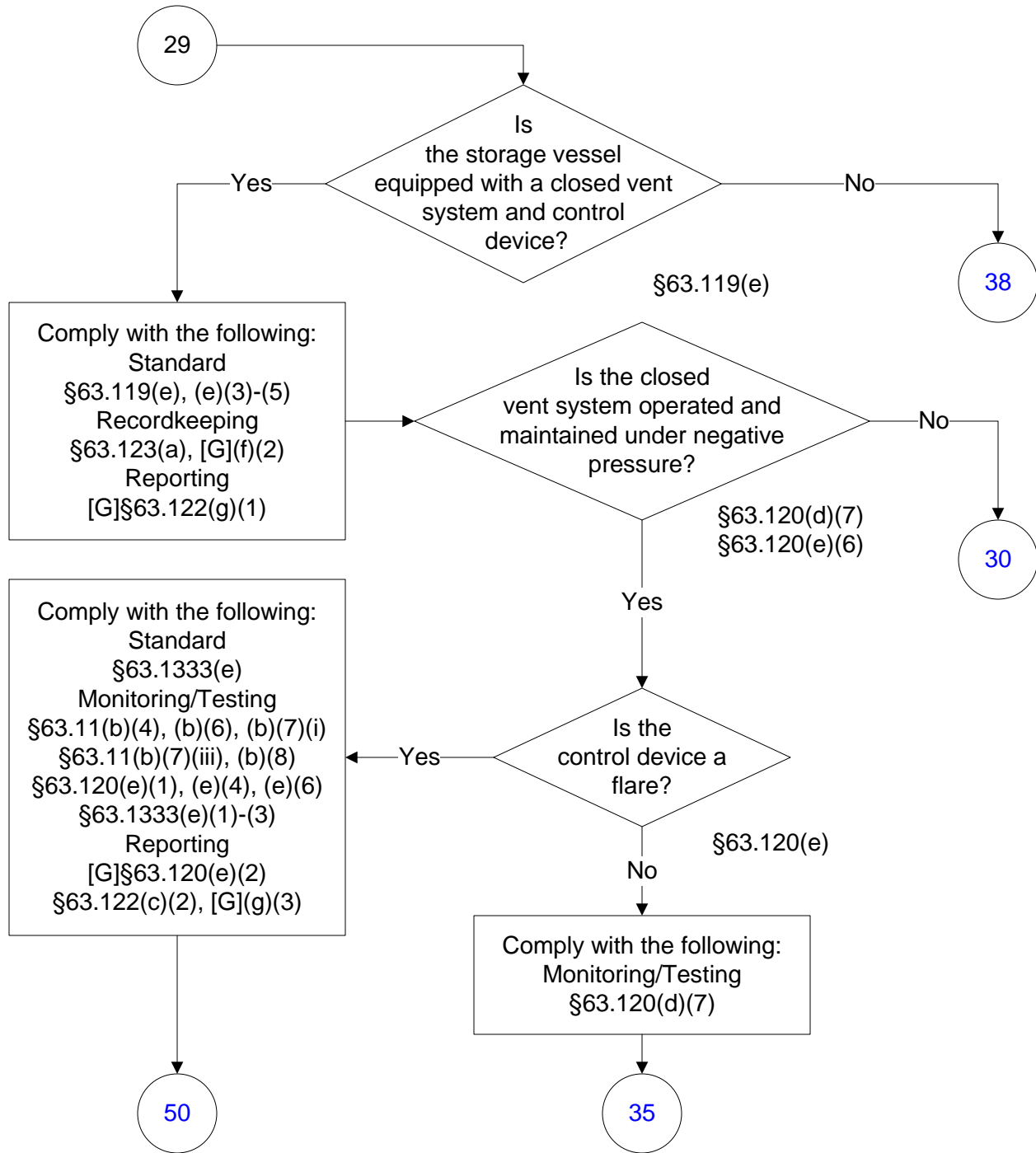

40 CFR Part 63, Subpart JJJ

(18 of 196)

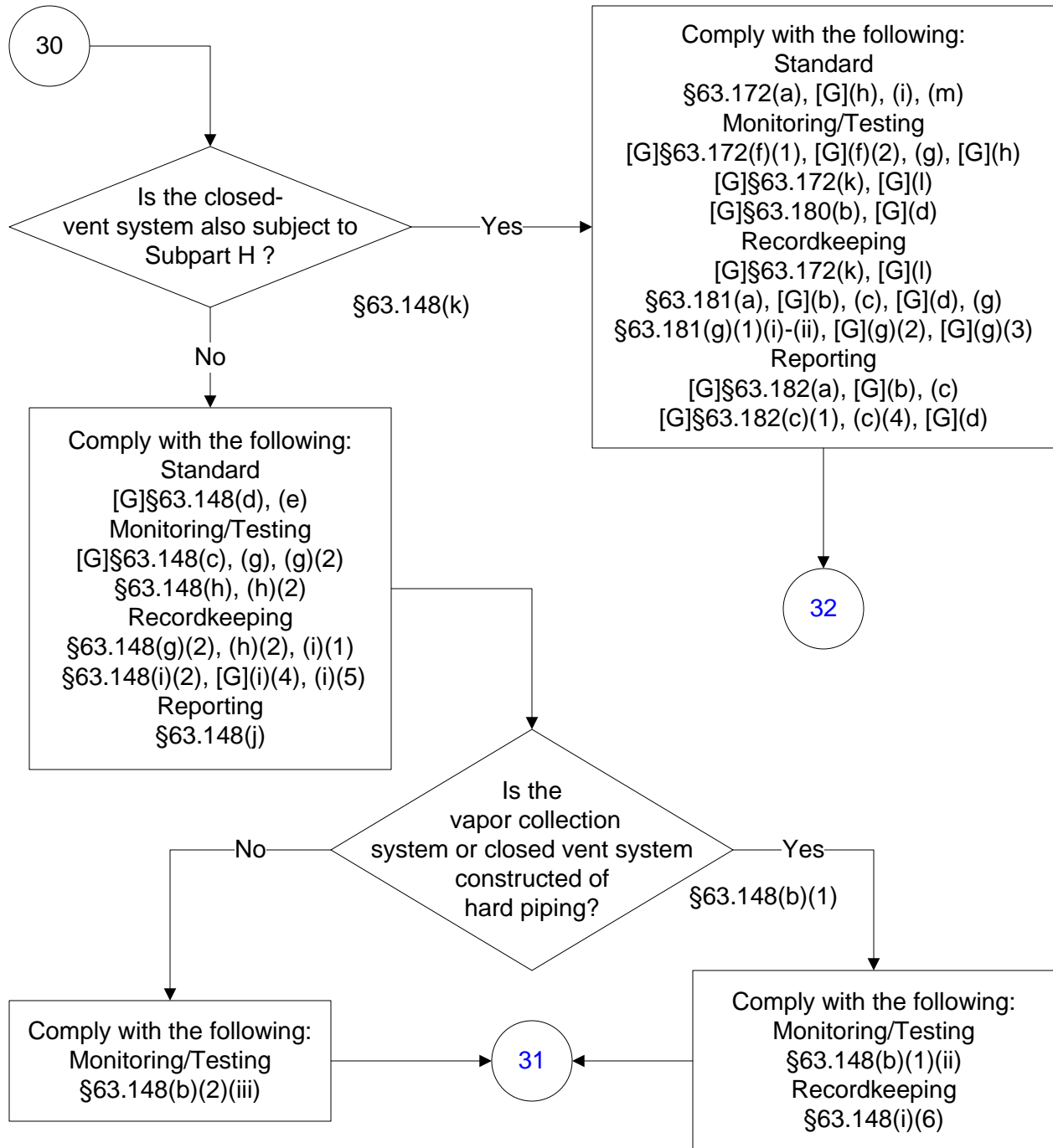

40 CFR Part 63, Subpart JJJ

(19 of 196)

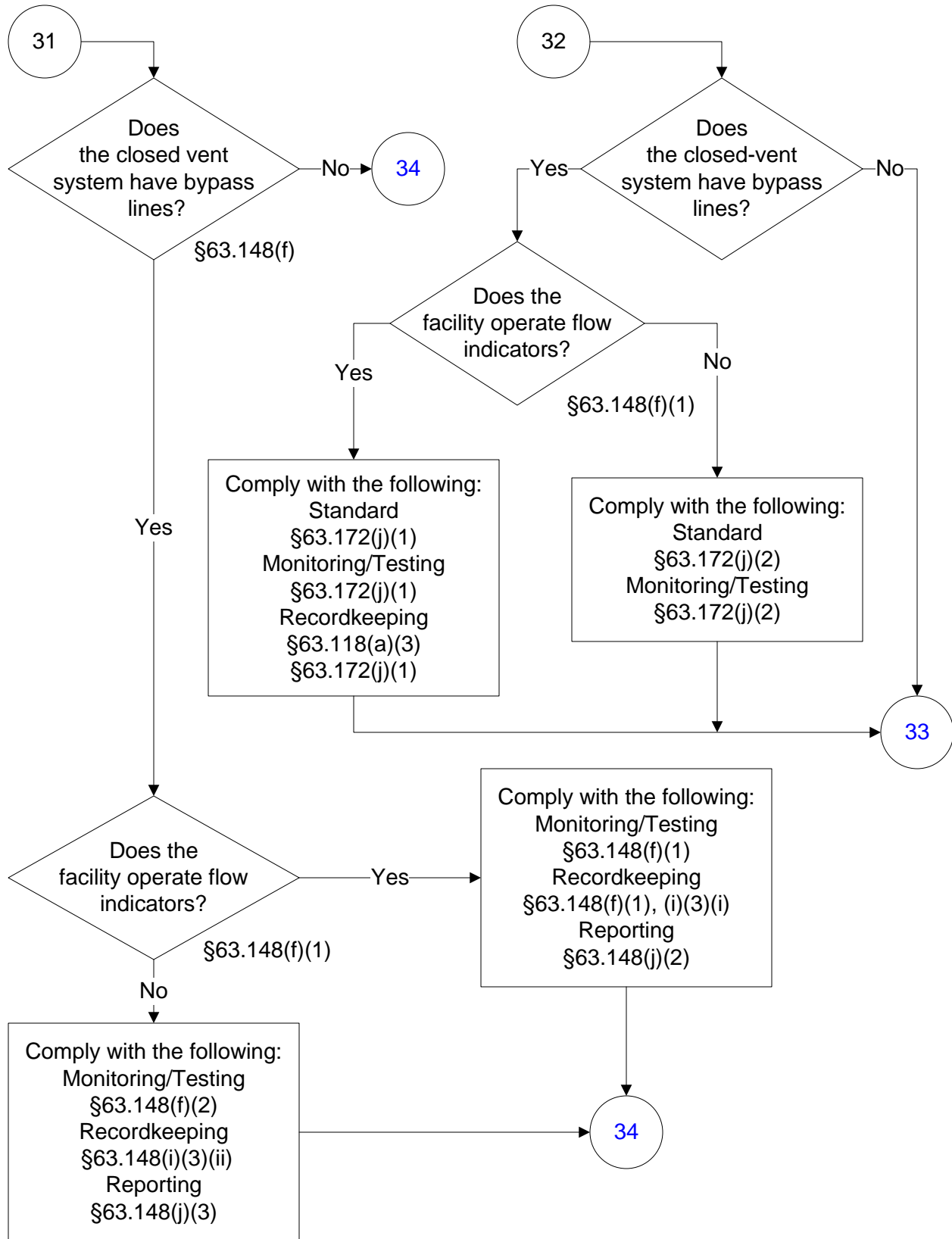

40 CFR Part 63, Subpart JJJ

(20 of 196)

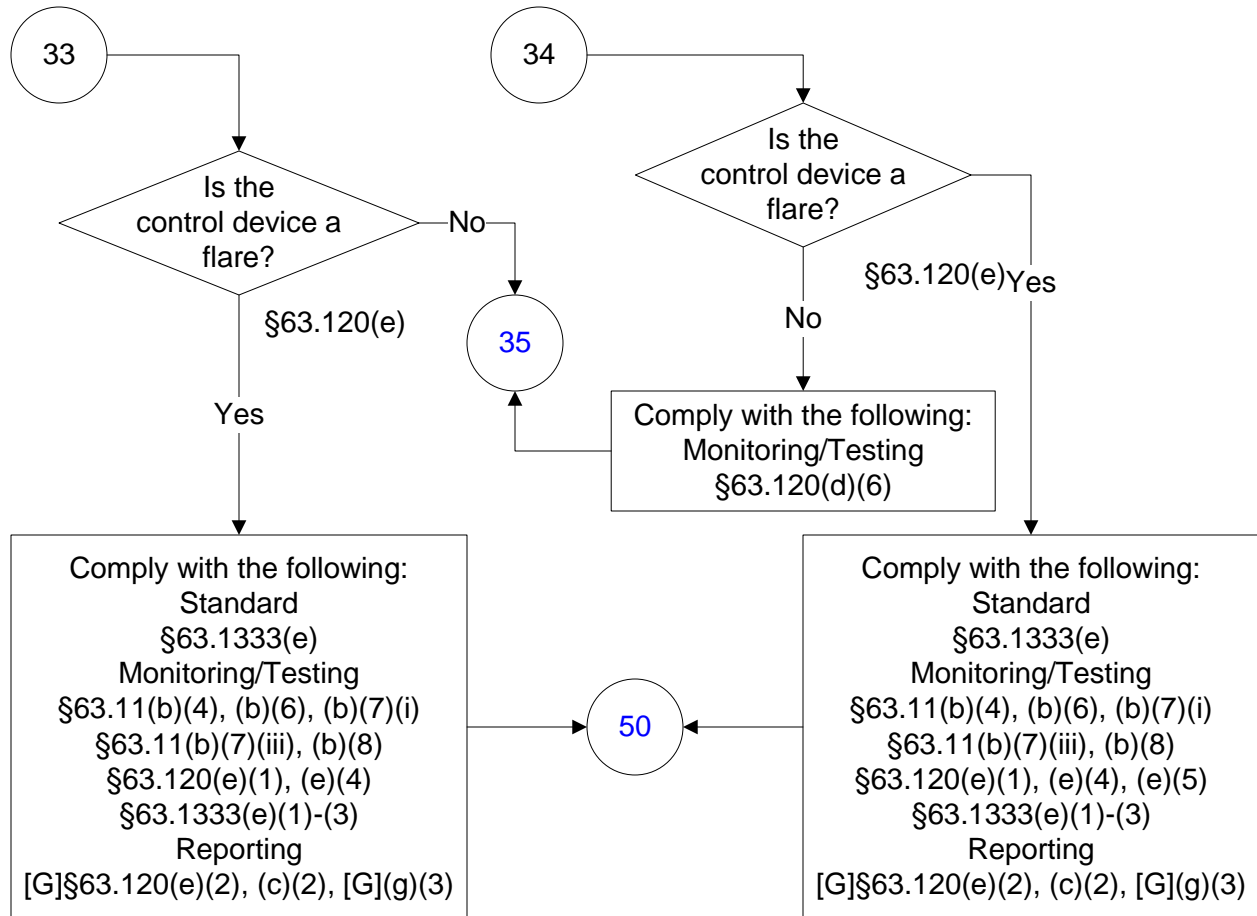

40 CFR Part 63, Subpart JJJ

(21 of 196)

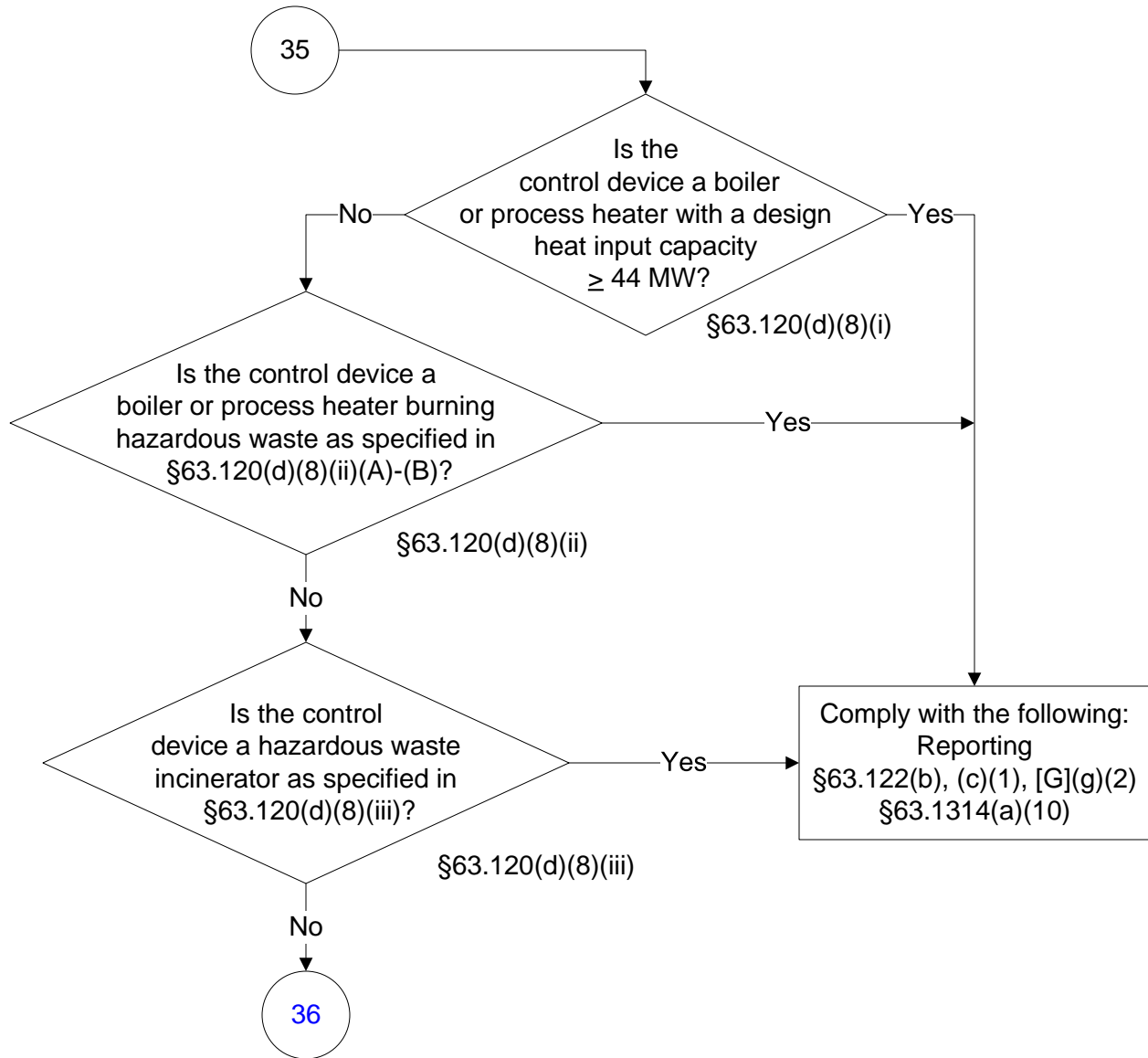

40 CFR Part 63, Subpart JJJ

(22 of 196)

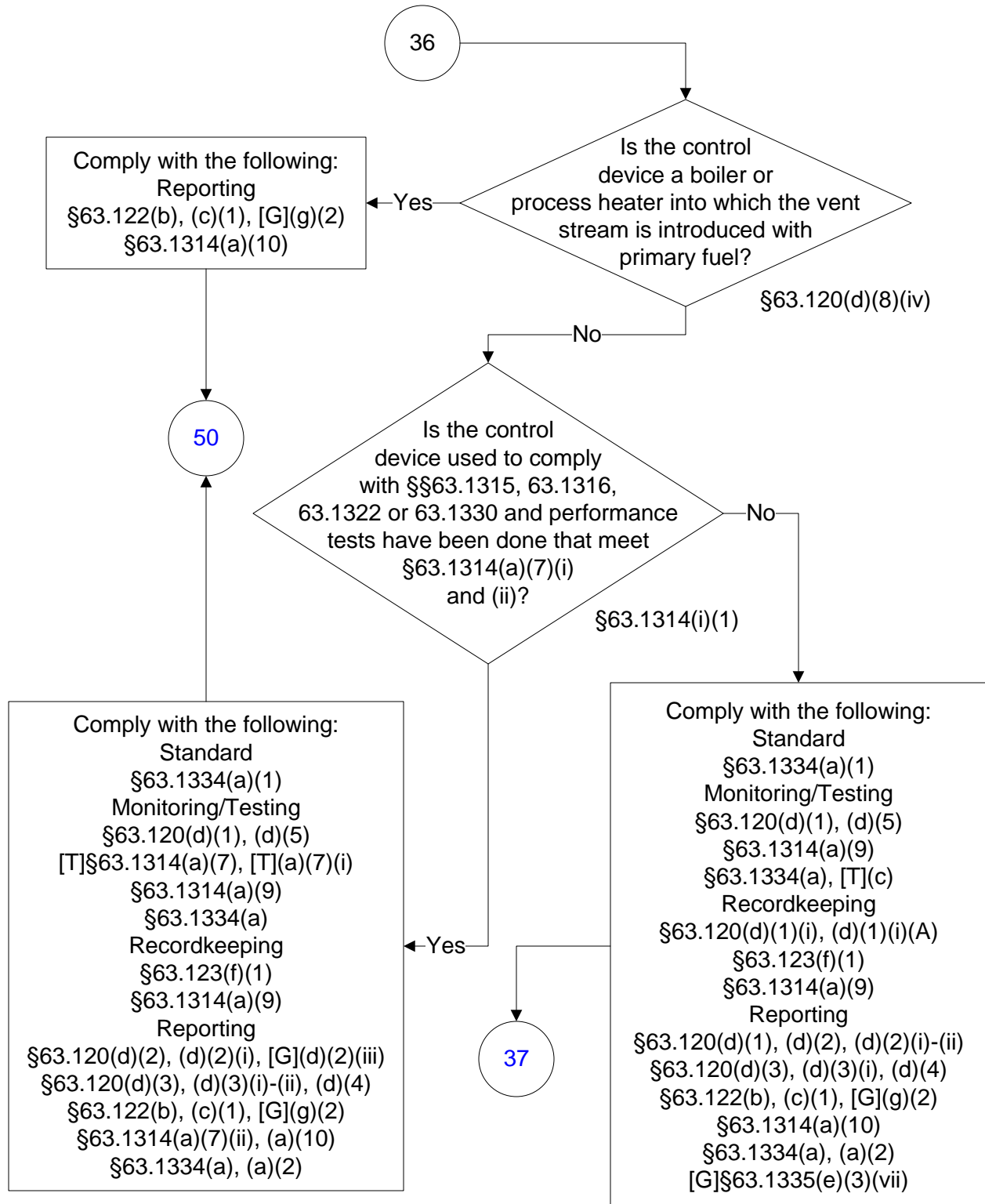

40 CFR Part 63, Subpart JJJ

(23 of 196)

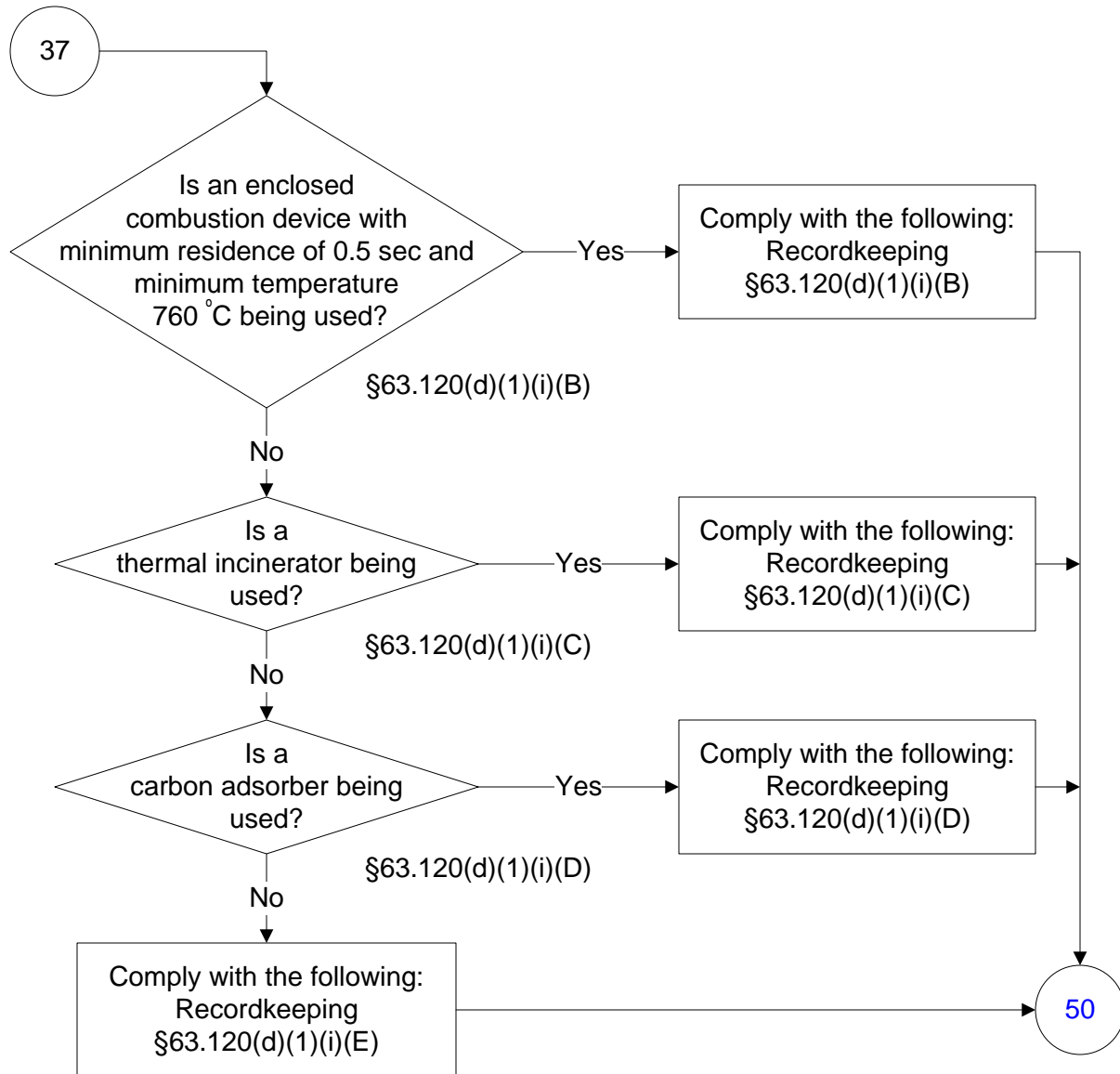

40 CFR Part 63, Subpart JJJ

(24 of 196)

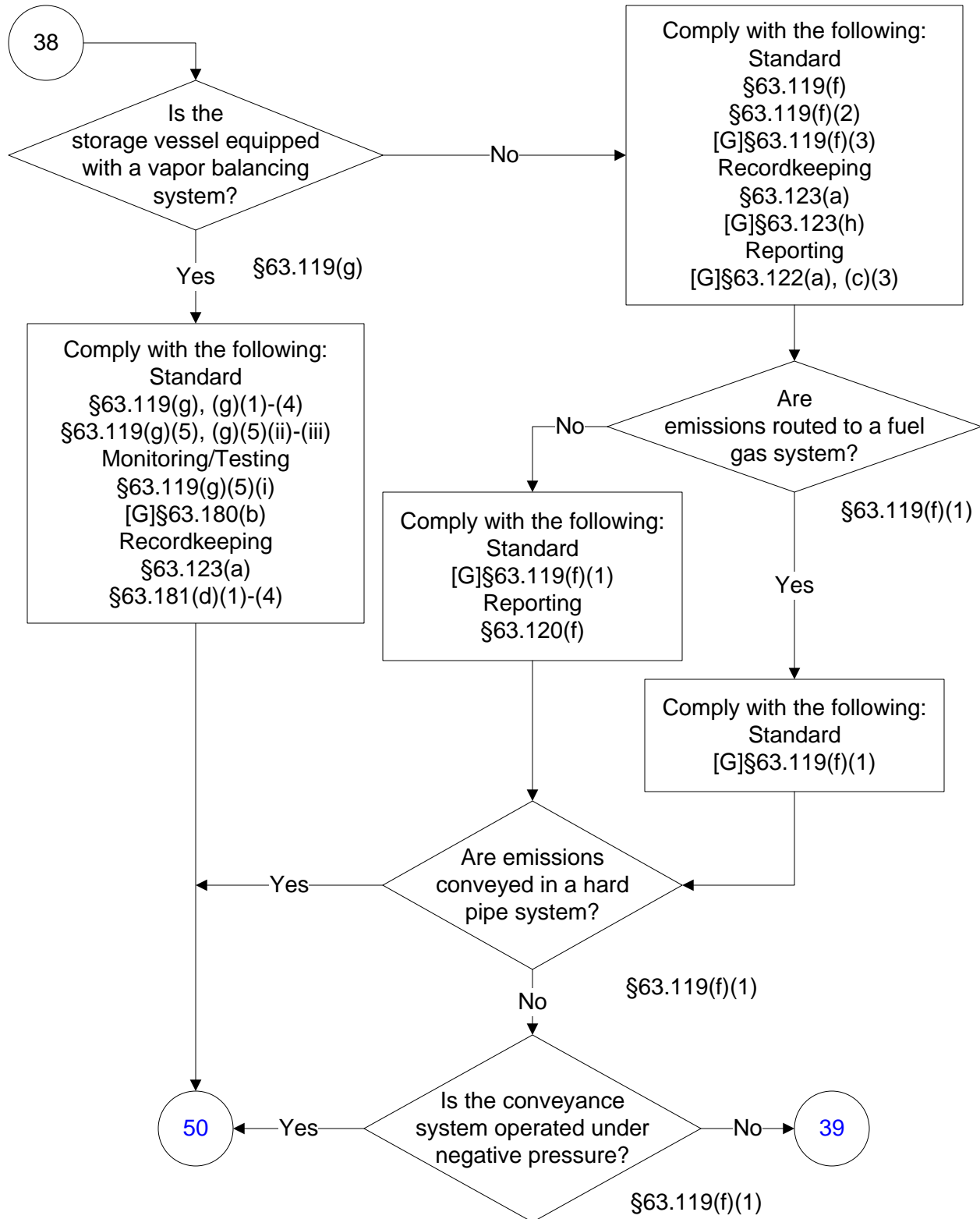

40 CFR Part 63, Subpart JJJ

(25 of 196)

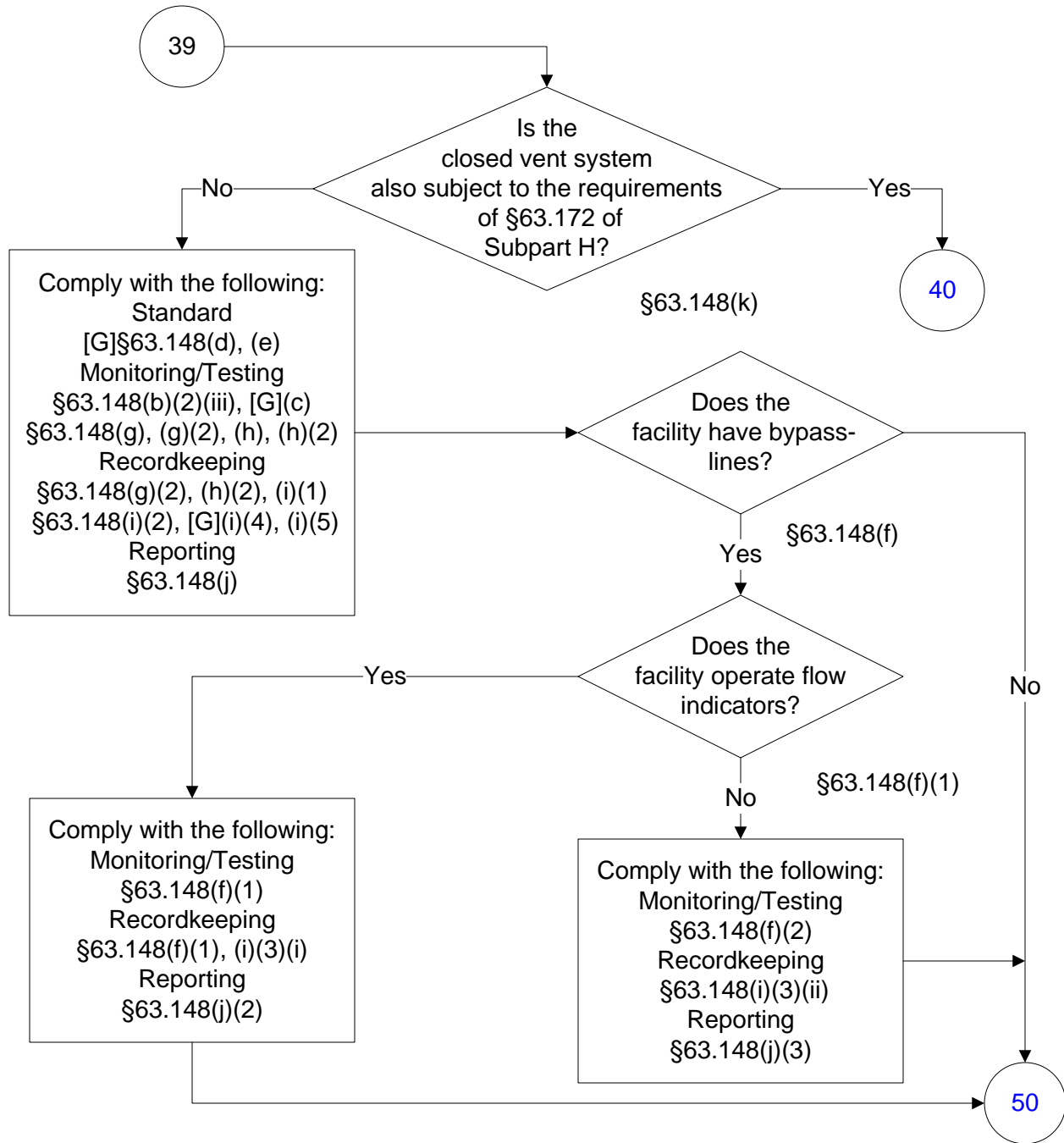

40 CFR Part 63, Subpart JJJ

(26 of 196)

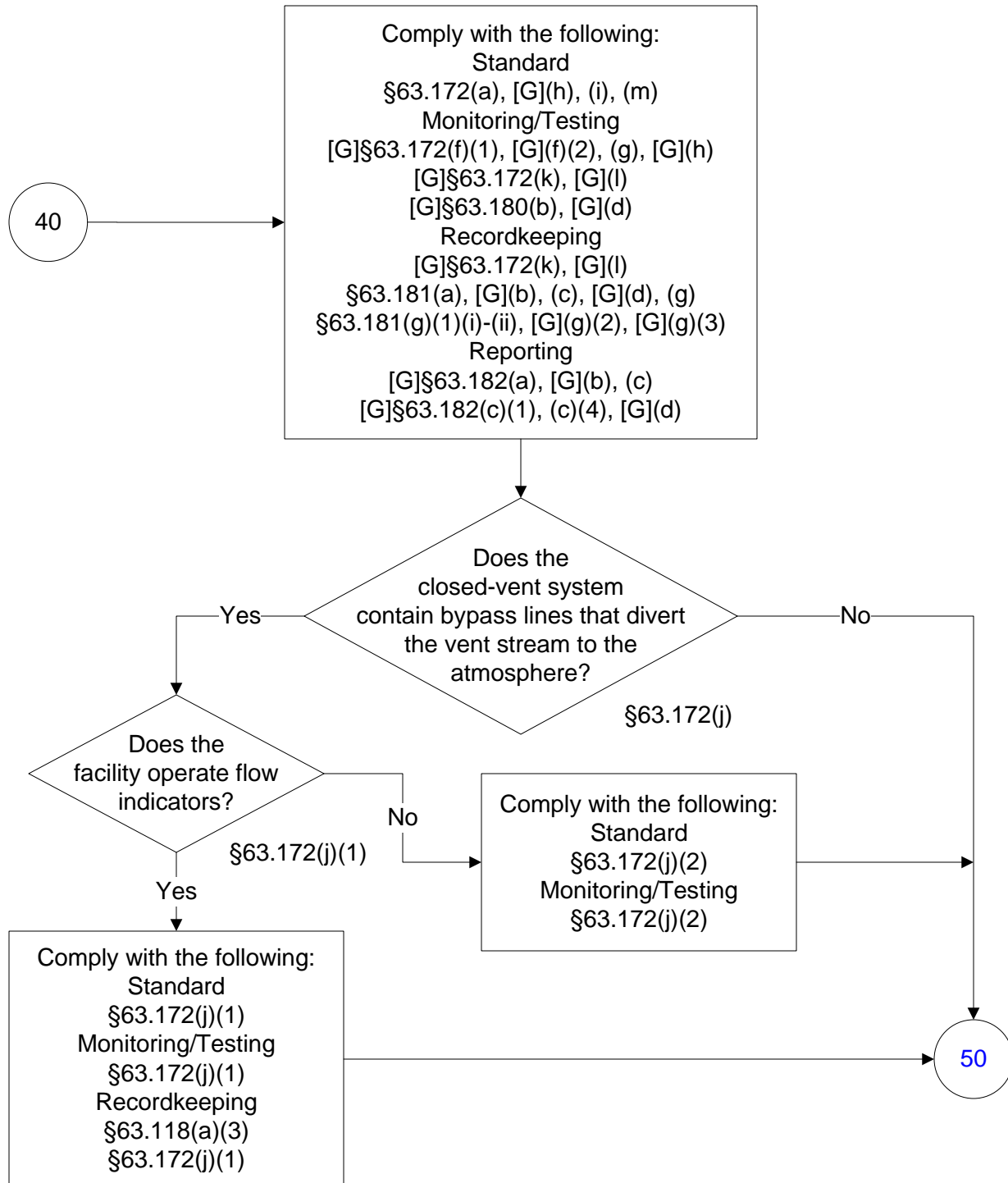

40 CFR Part 63, Subpart JJJ

(27 of 196)

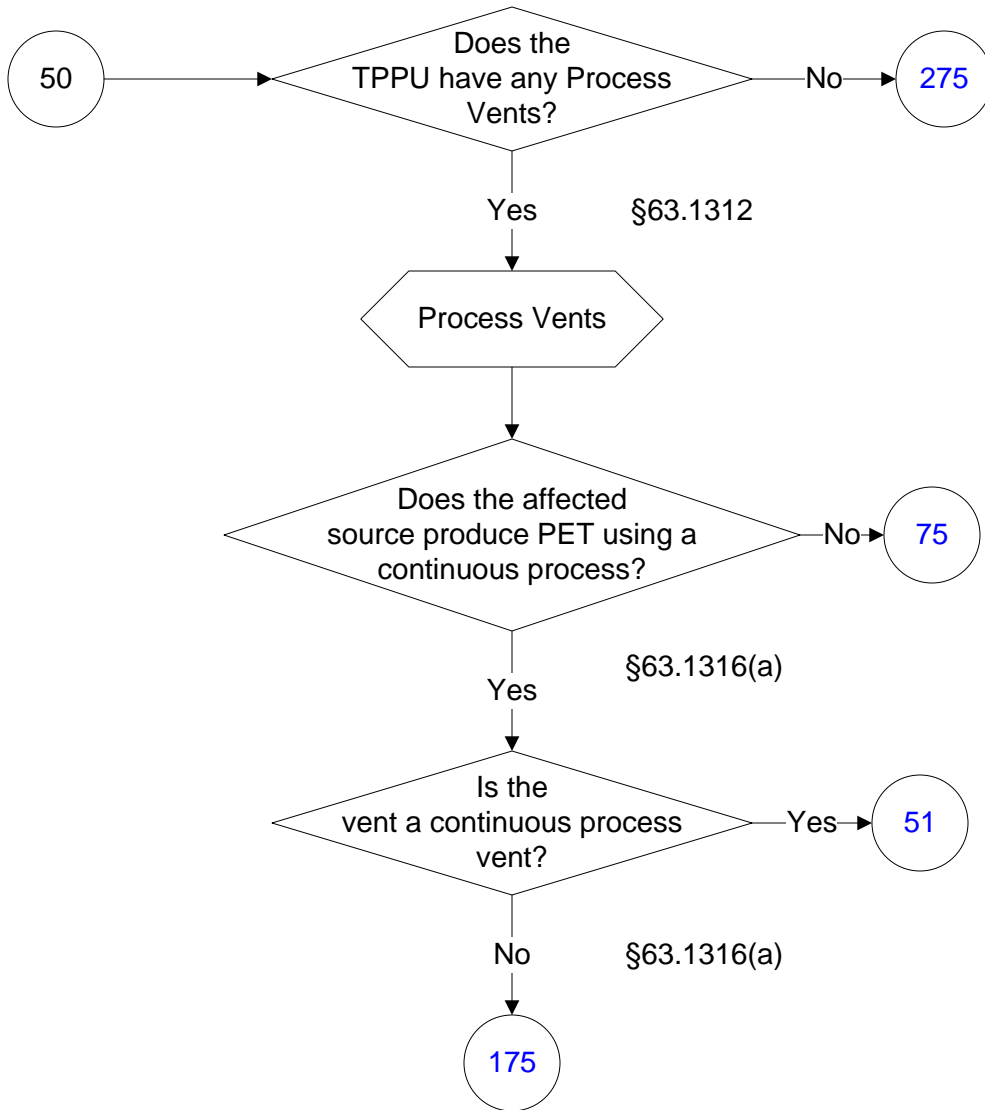

40 CFR Part 63, Subpart JJJ

(28 of 196)

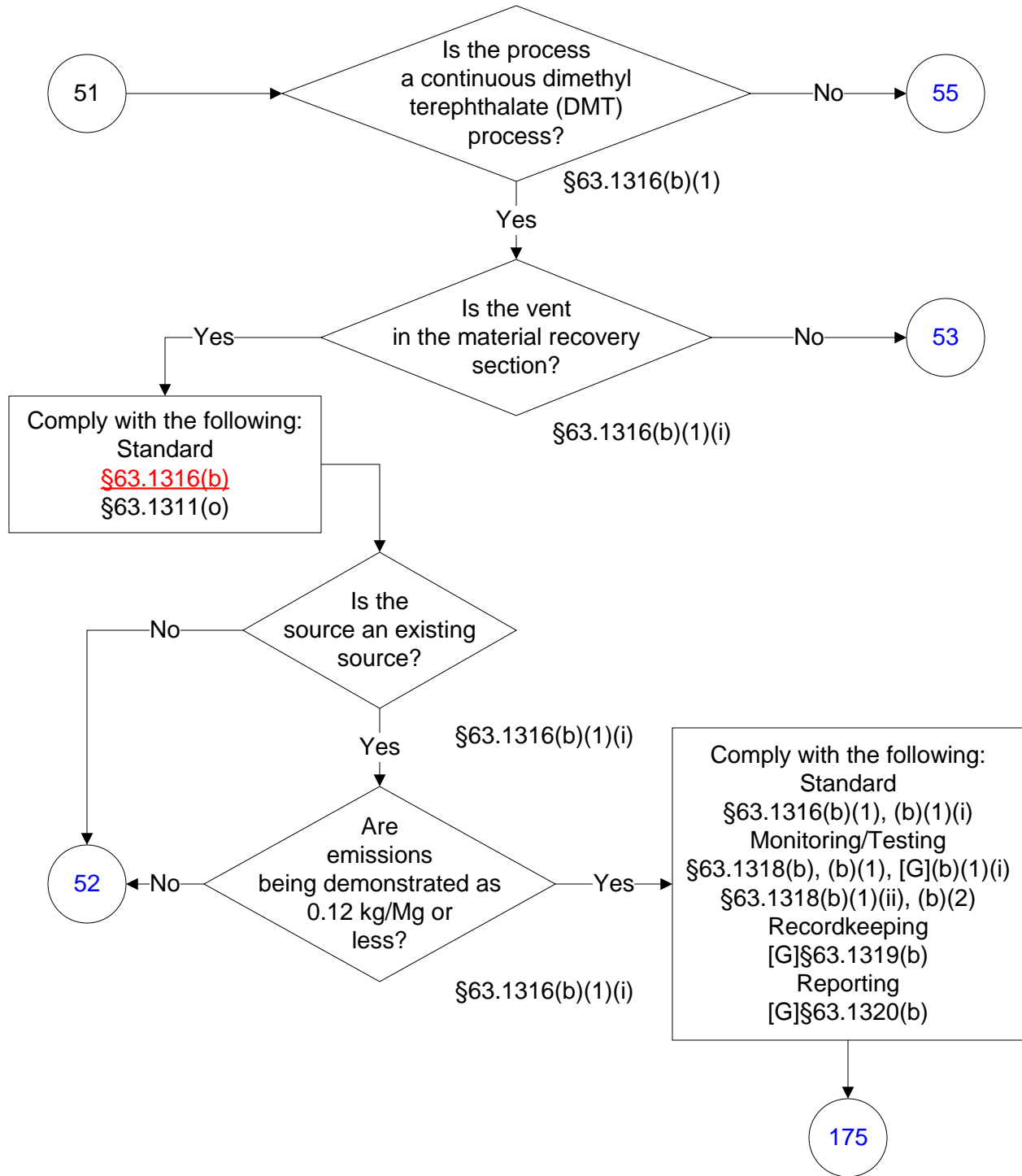

40 CFR Part 63, Subpart JJJ

(29 of 196)

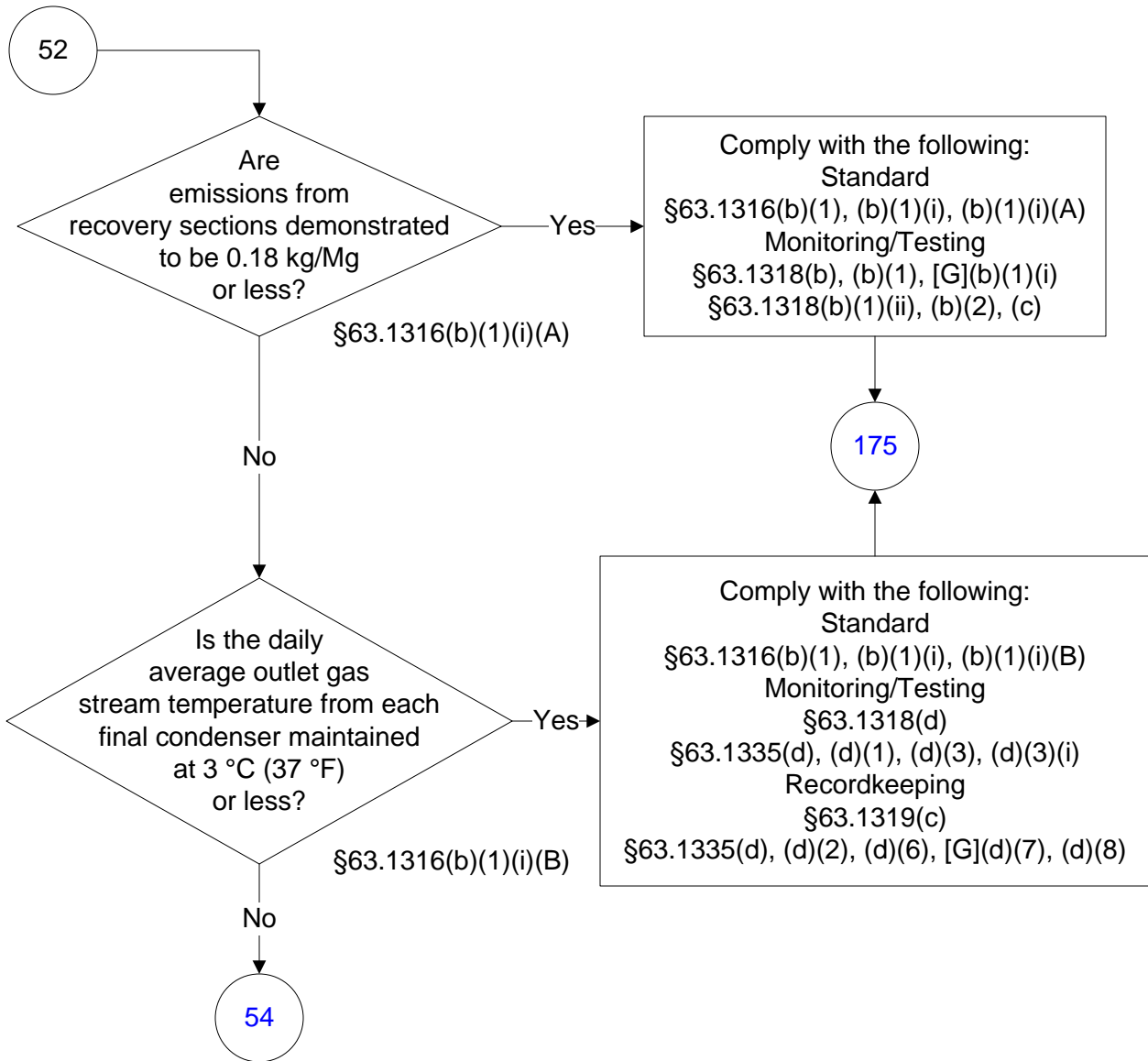

40 CFR Part 63, Subpart JJJ

(30 of 196)

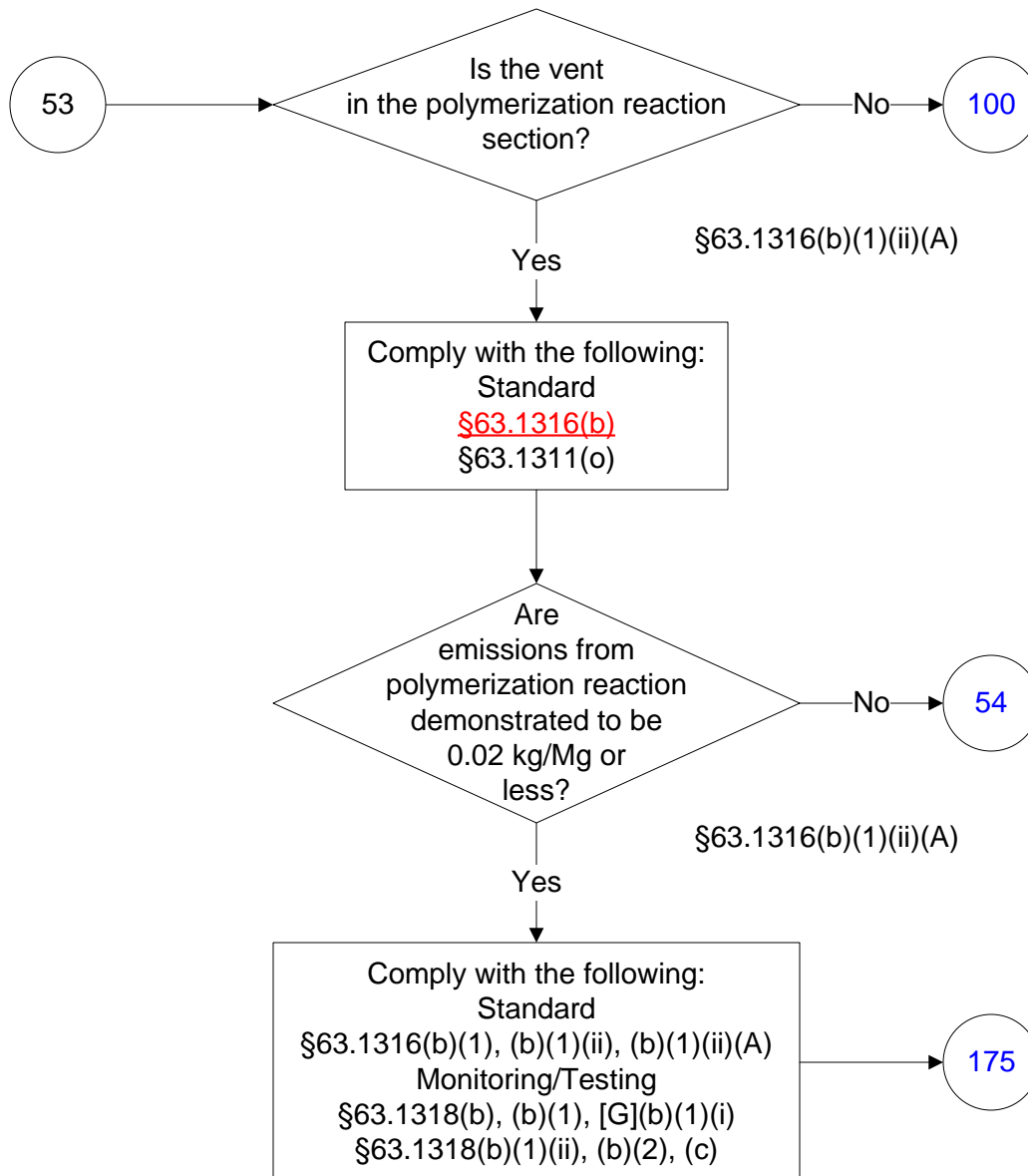

40 CFR Part 63, Subpart JJJ

(31 of 196)

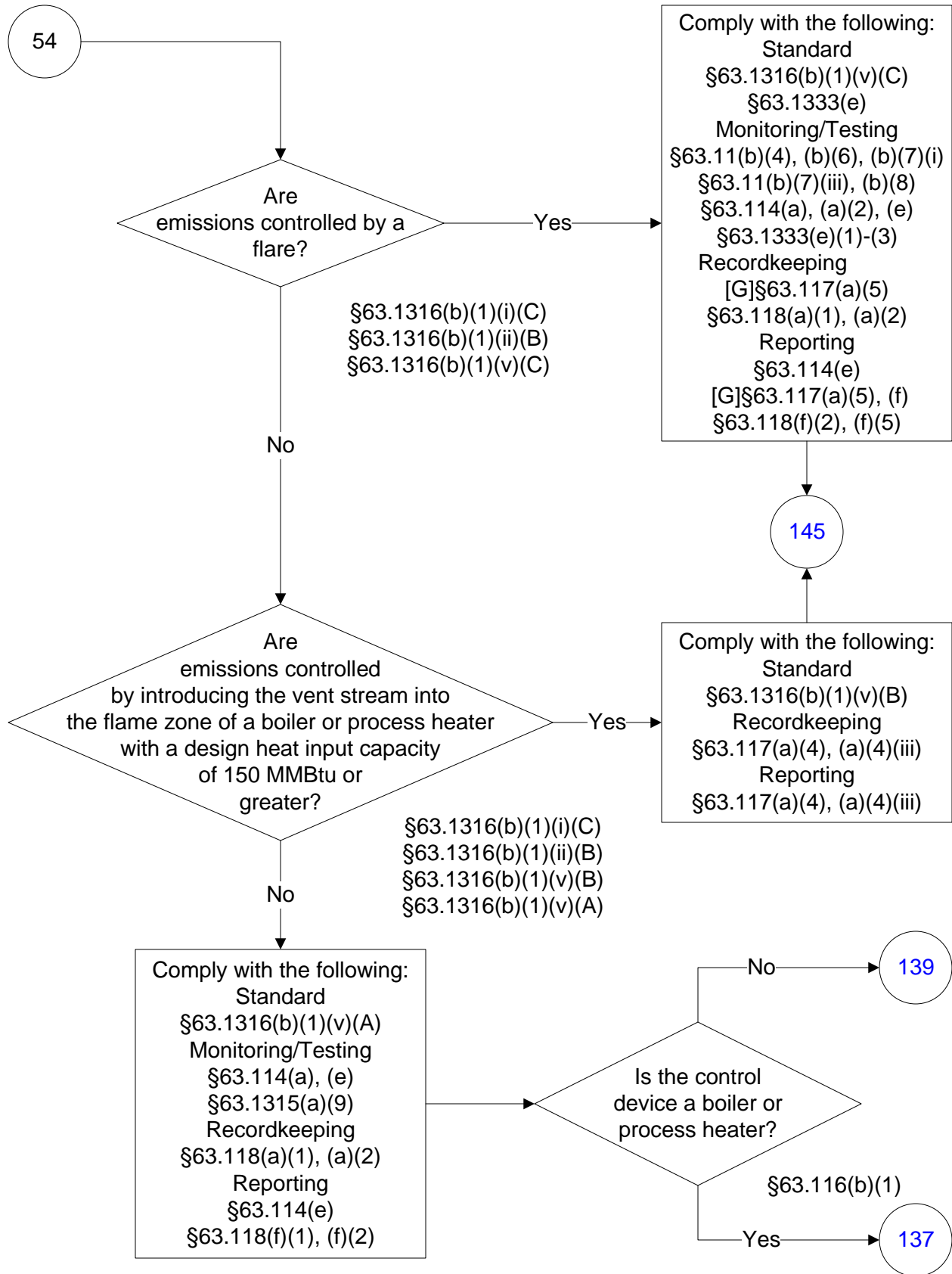

40 CFR Part 63, Subpart JJJ

(32 of 196)

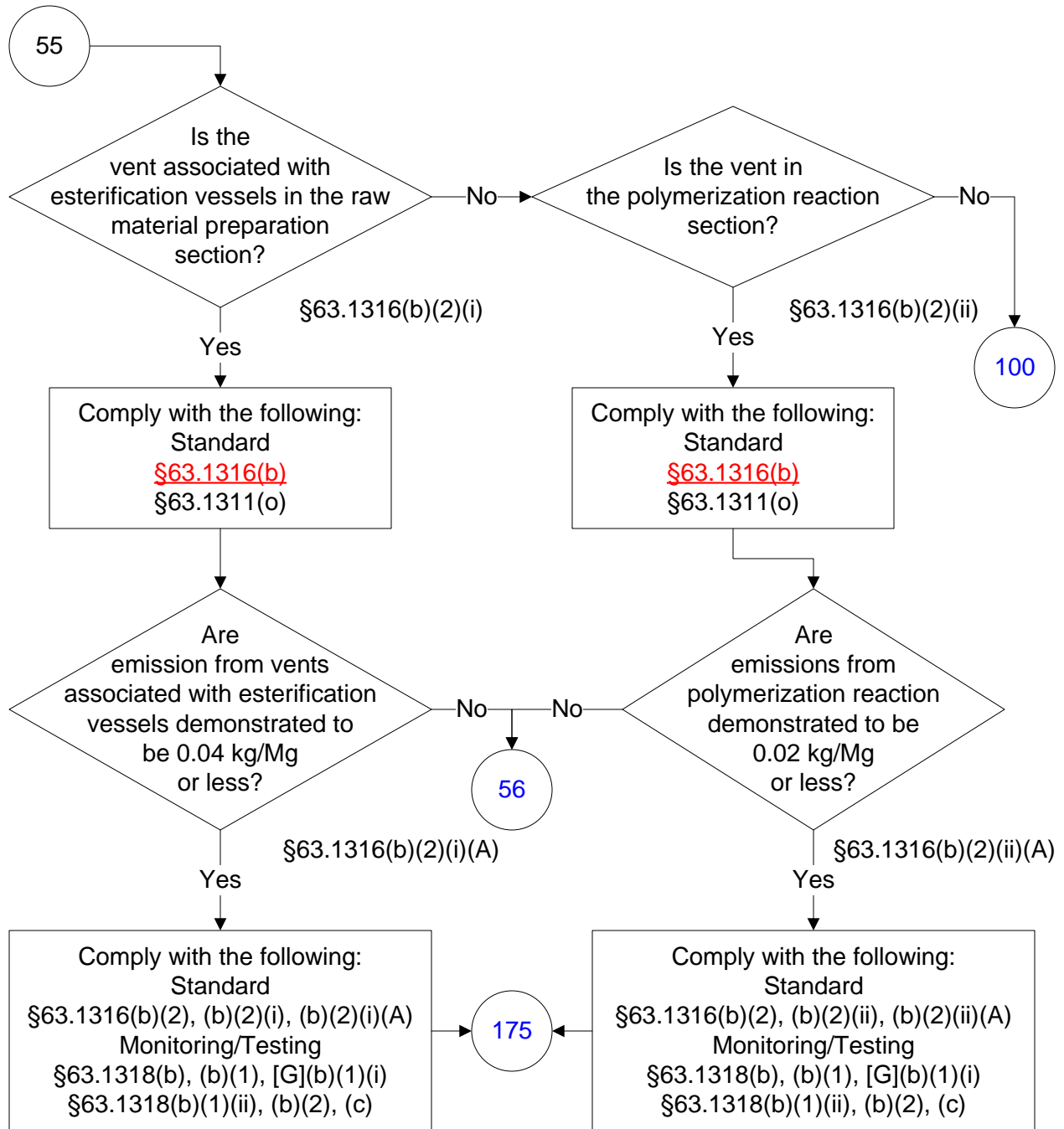

40 CFR Part 63, Subpart JJJ

(33 of 196)

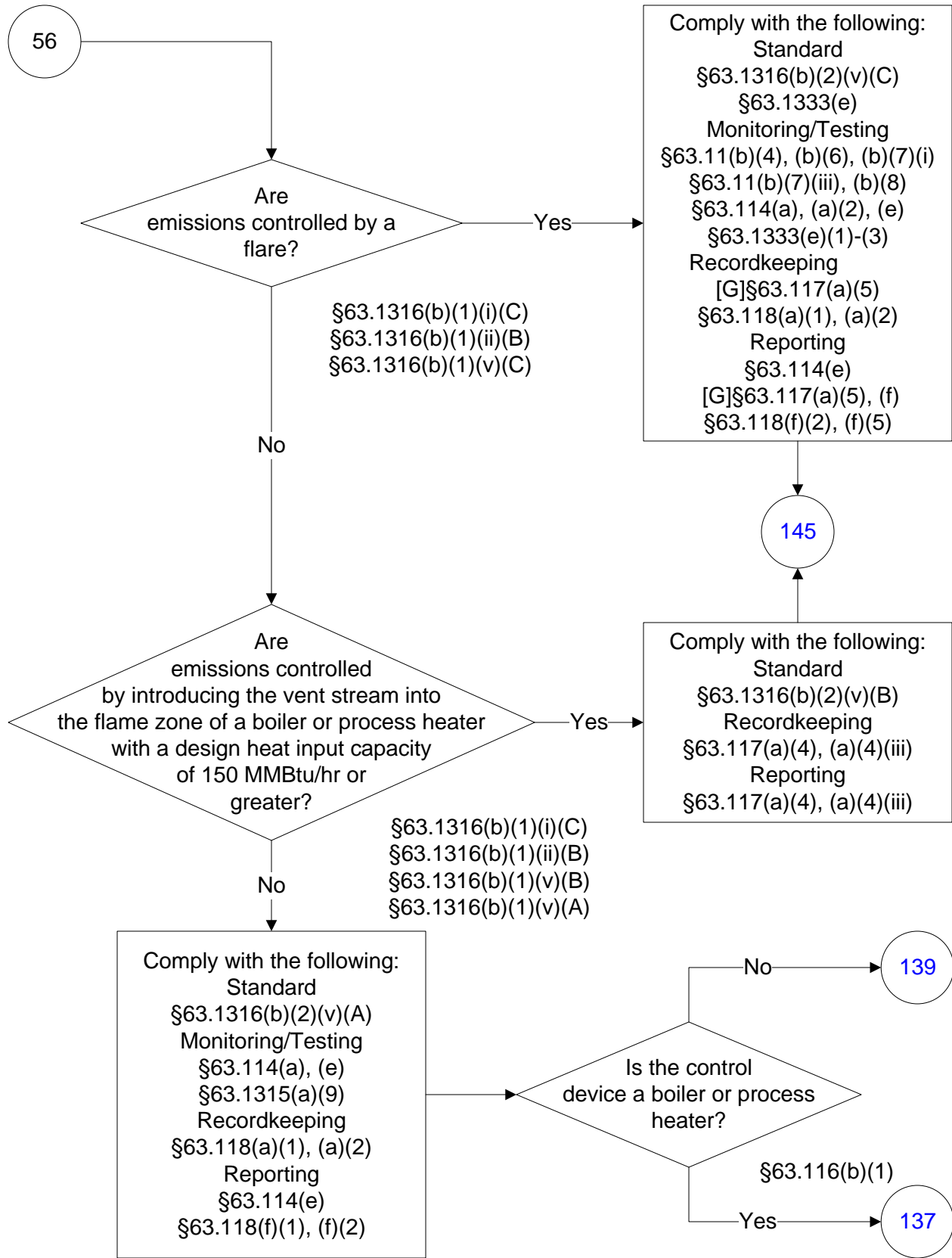

40 CFR Part 63, Subpart JJJ

(34 of 196)

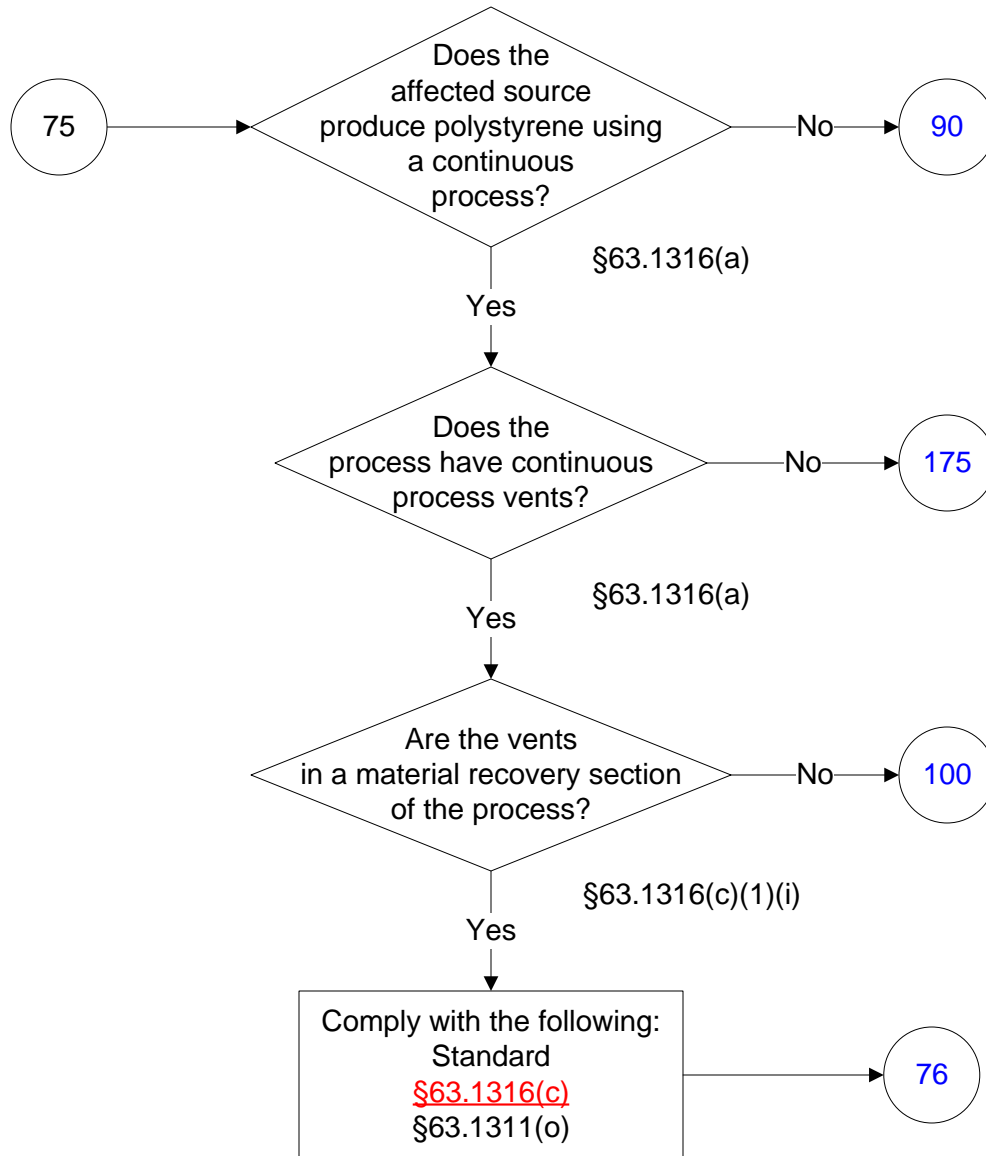

40 CFR Part 63, Subpart JJJ

(35 of 196)

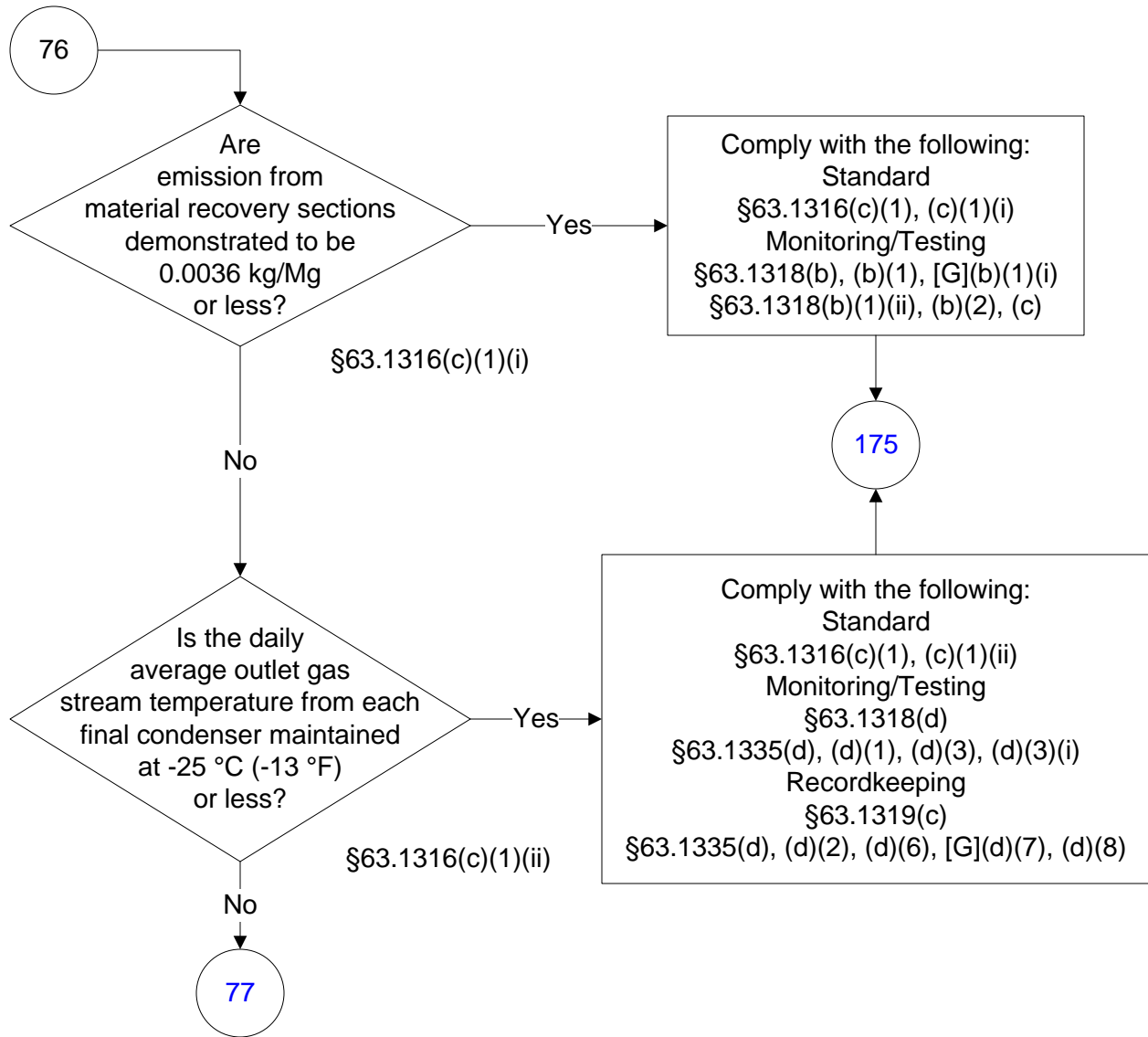

40 CFR Part 63, Subpart JJJ

(36 of 196)

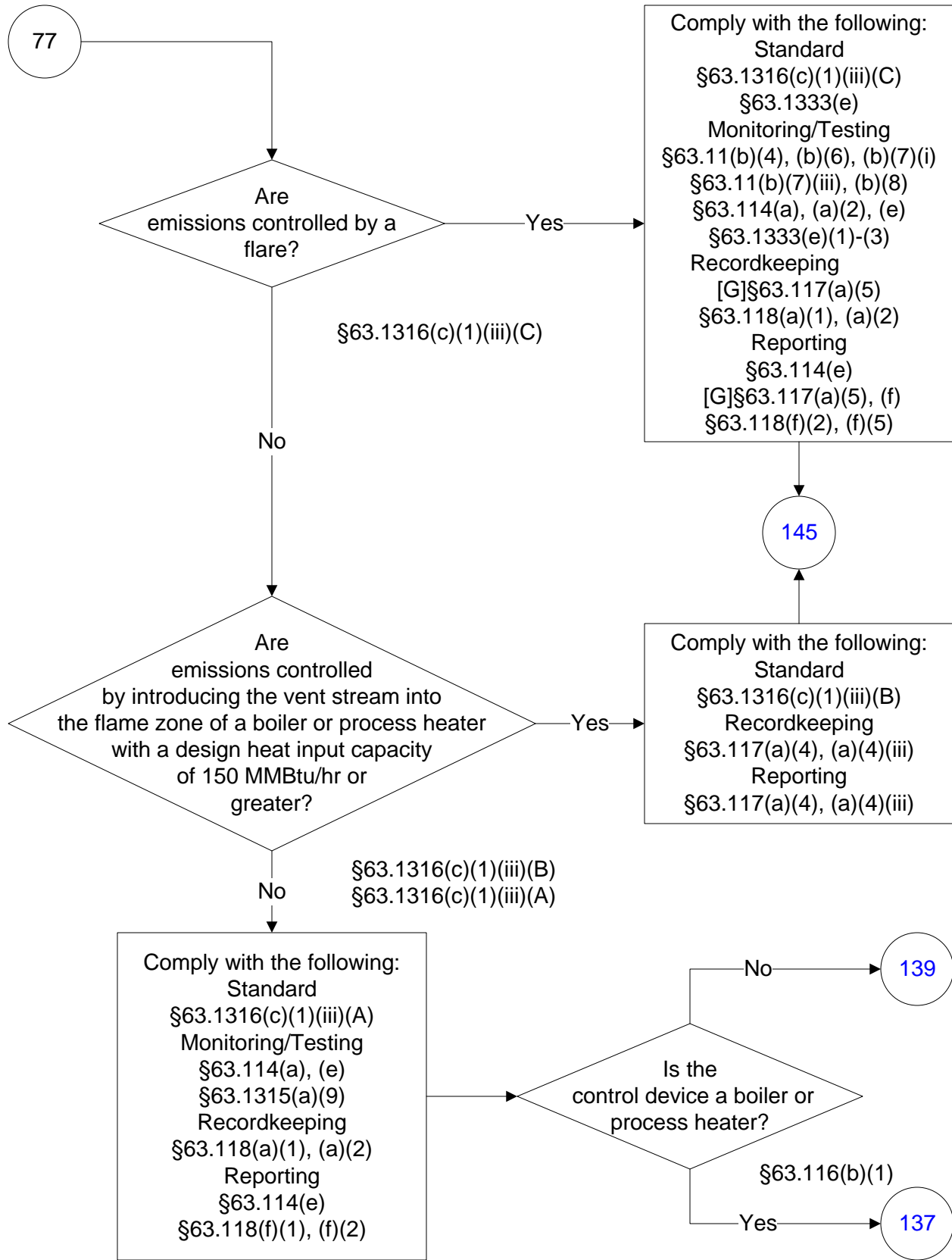

40 CFR Part 63, Subpart JJJ

(37 of 196)

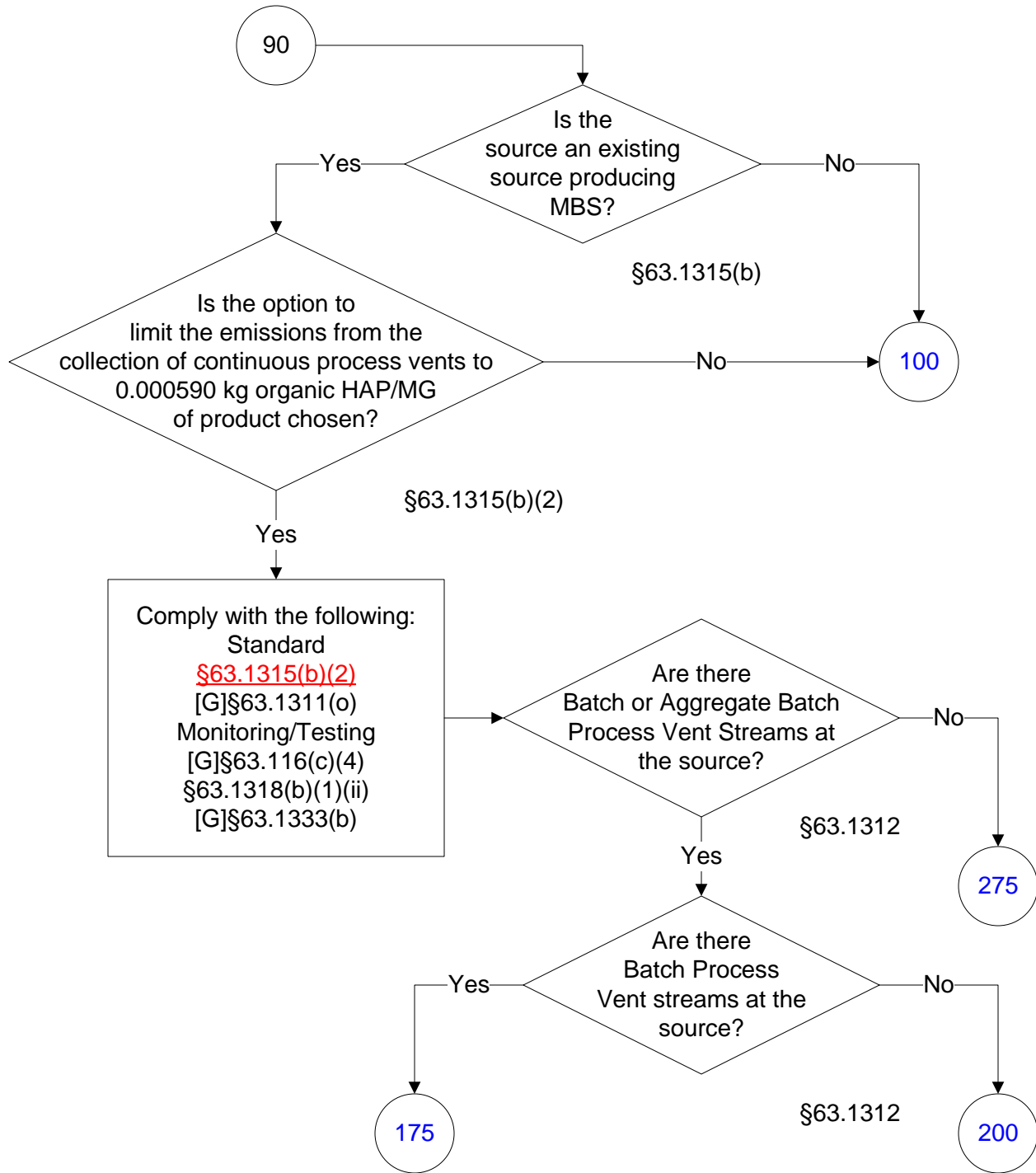

40 CFR Part 63, Subpart JJJ

(38 of 196)

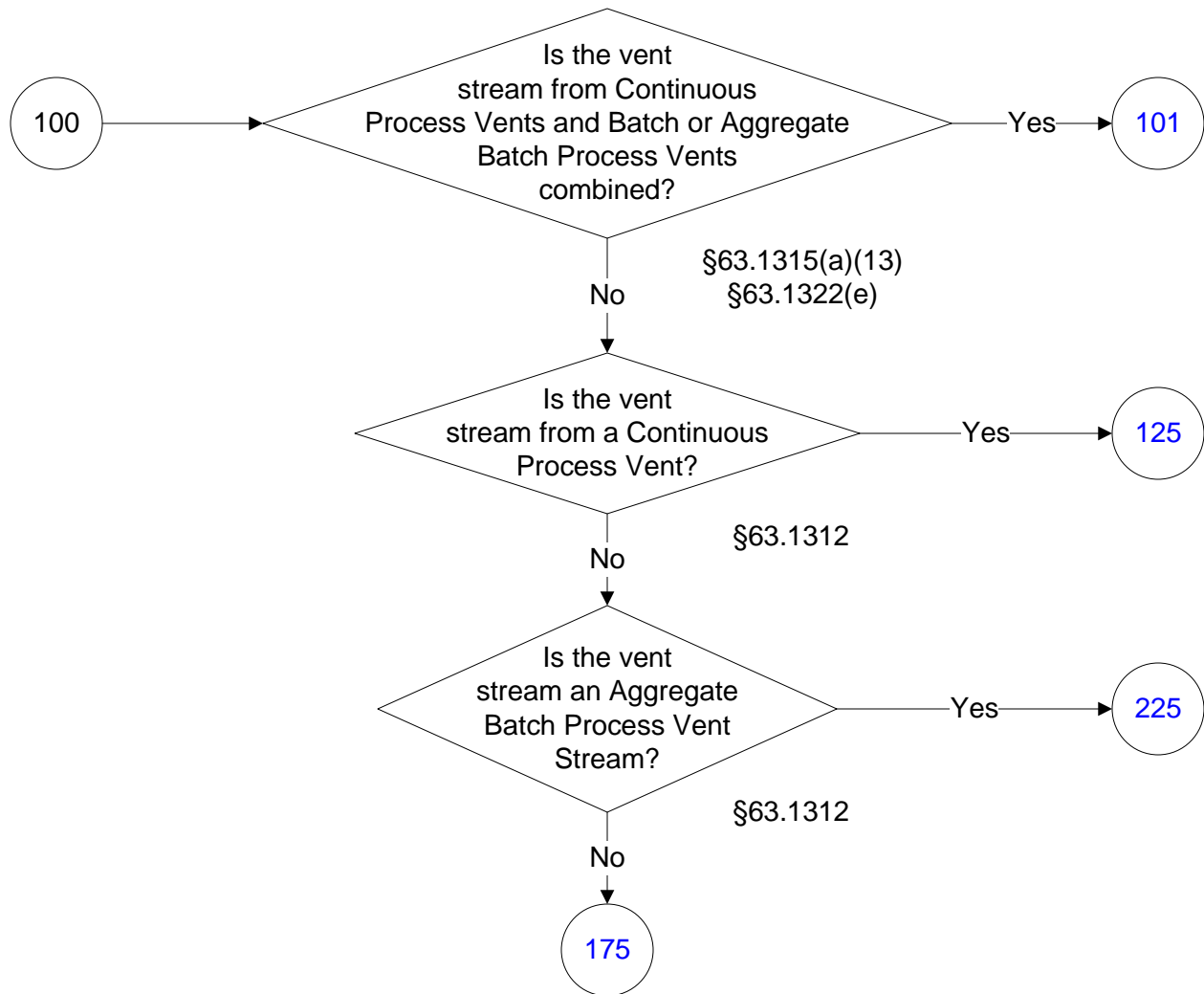

40 CFR Part 63, Subpart JJJ

(39 of 196)

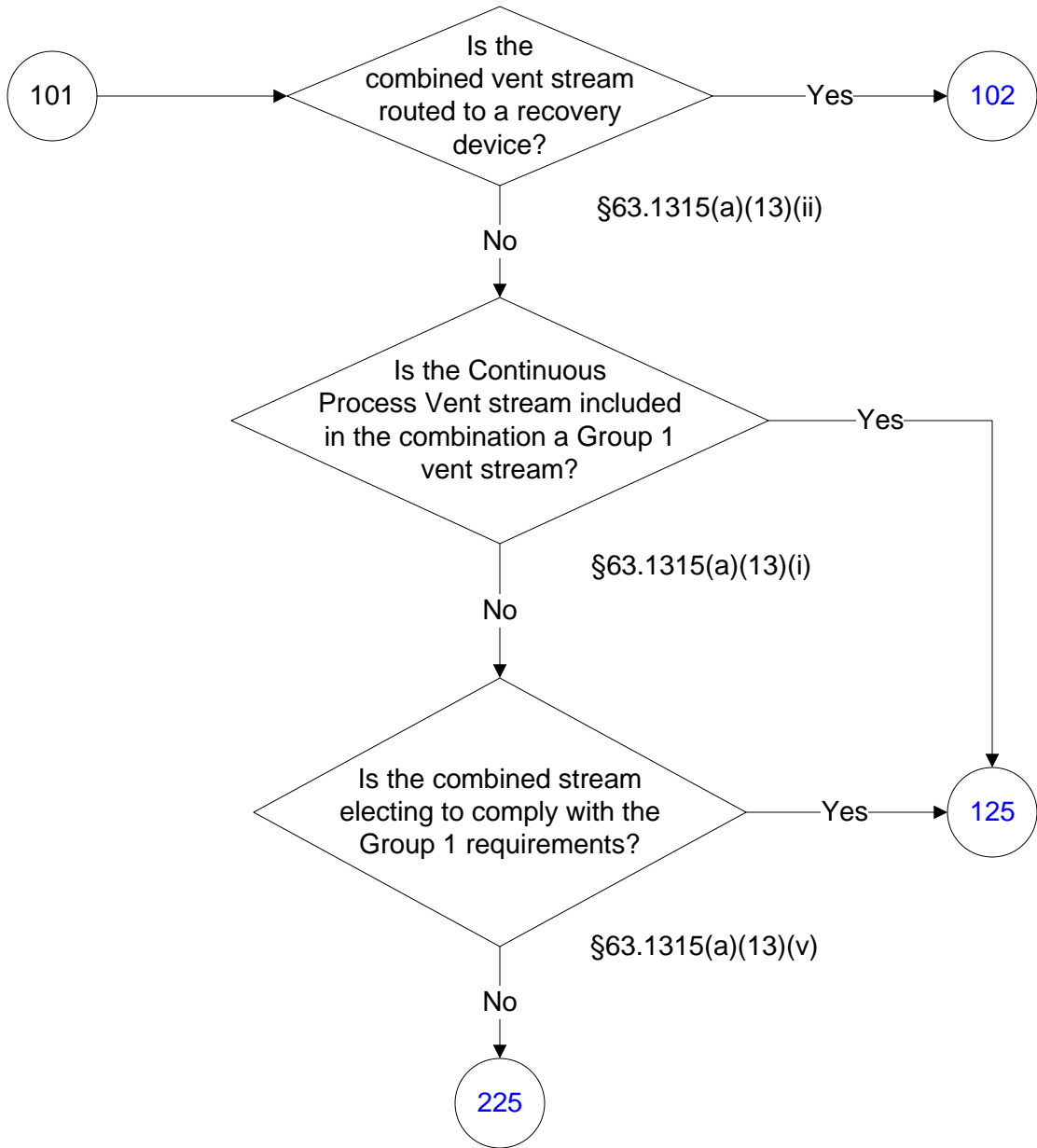

40 CFR Part 63, Subpart JJJ

(40 of 196)

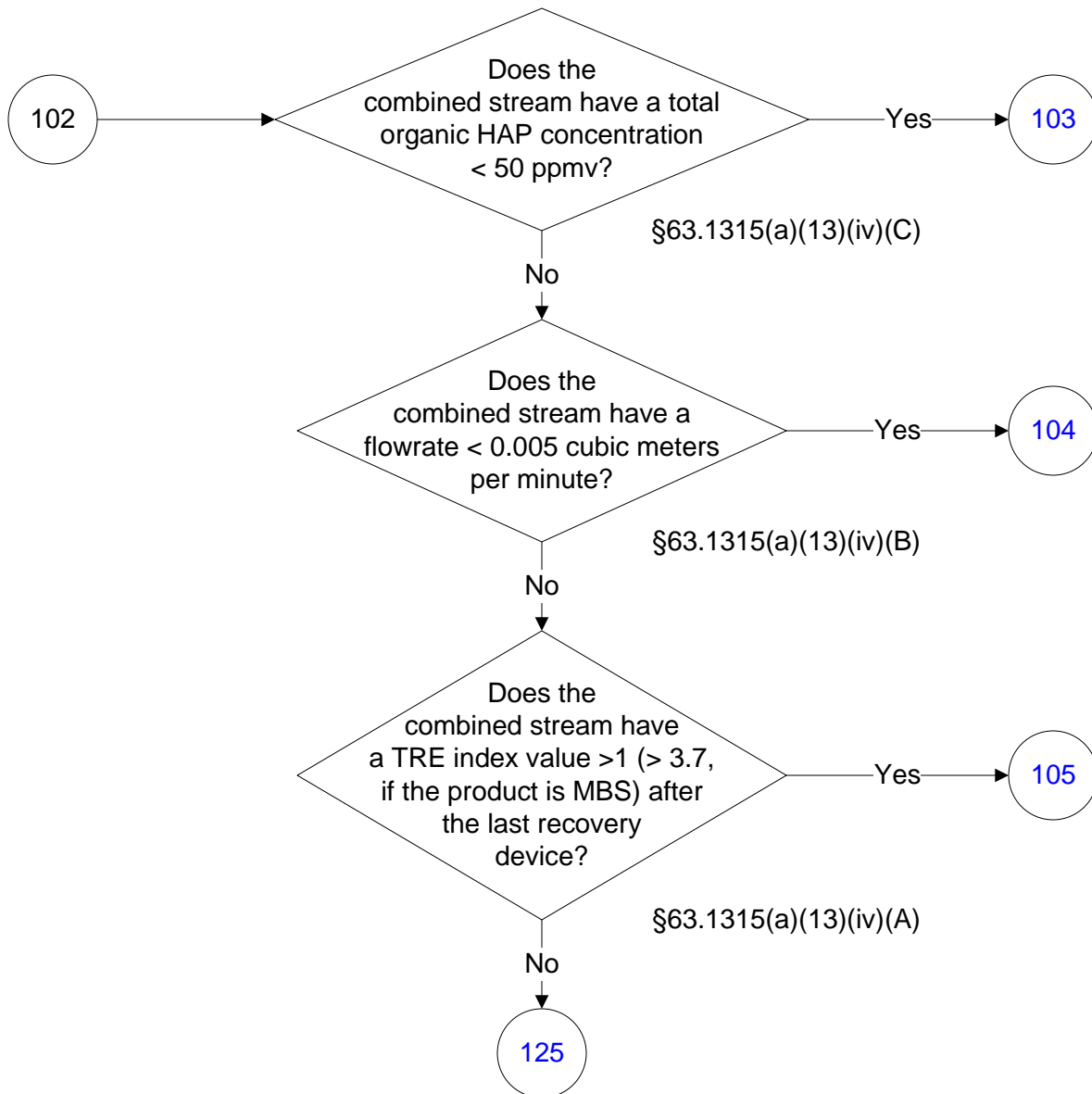

40 CFR Part 63, Subpart JJJ

(41 of 196)

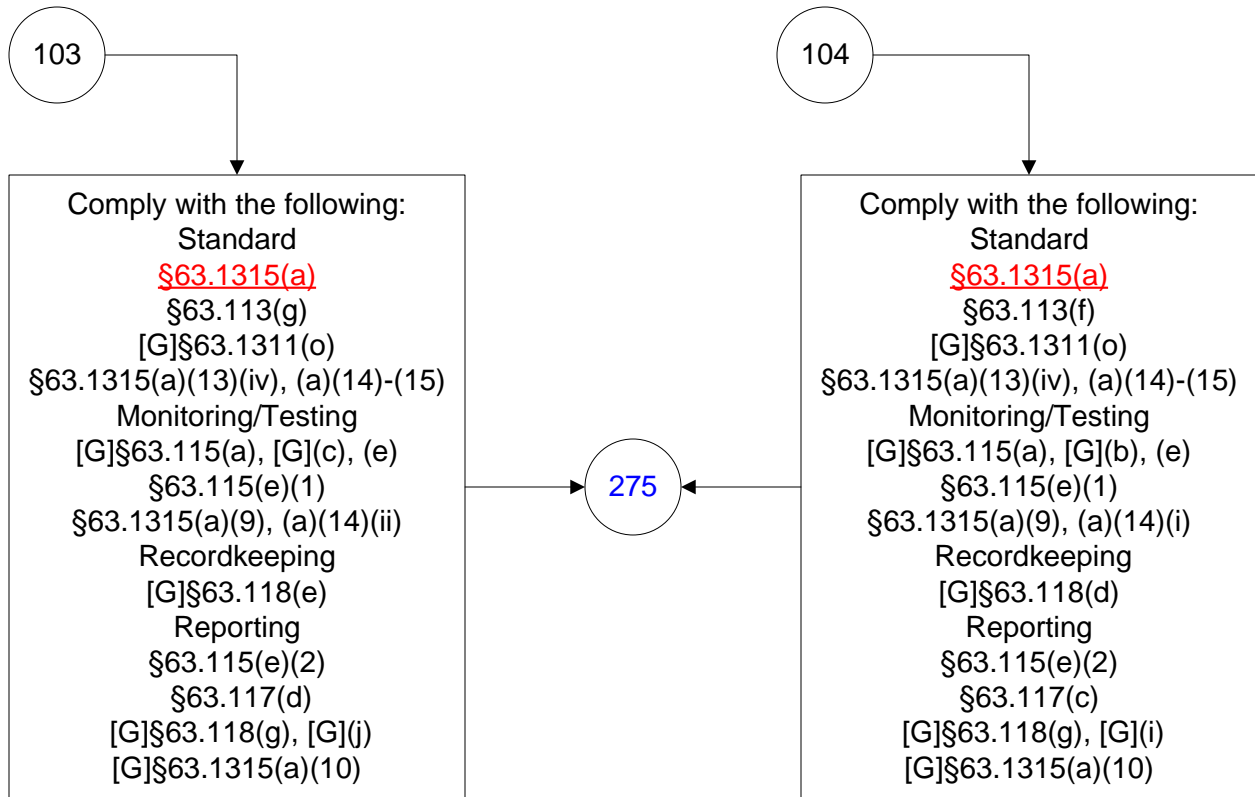

40 CFR Part 63, Subpart JJJ

(42 of 196)

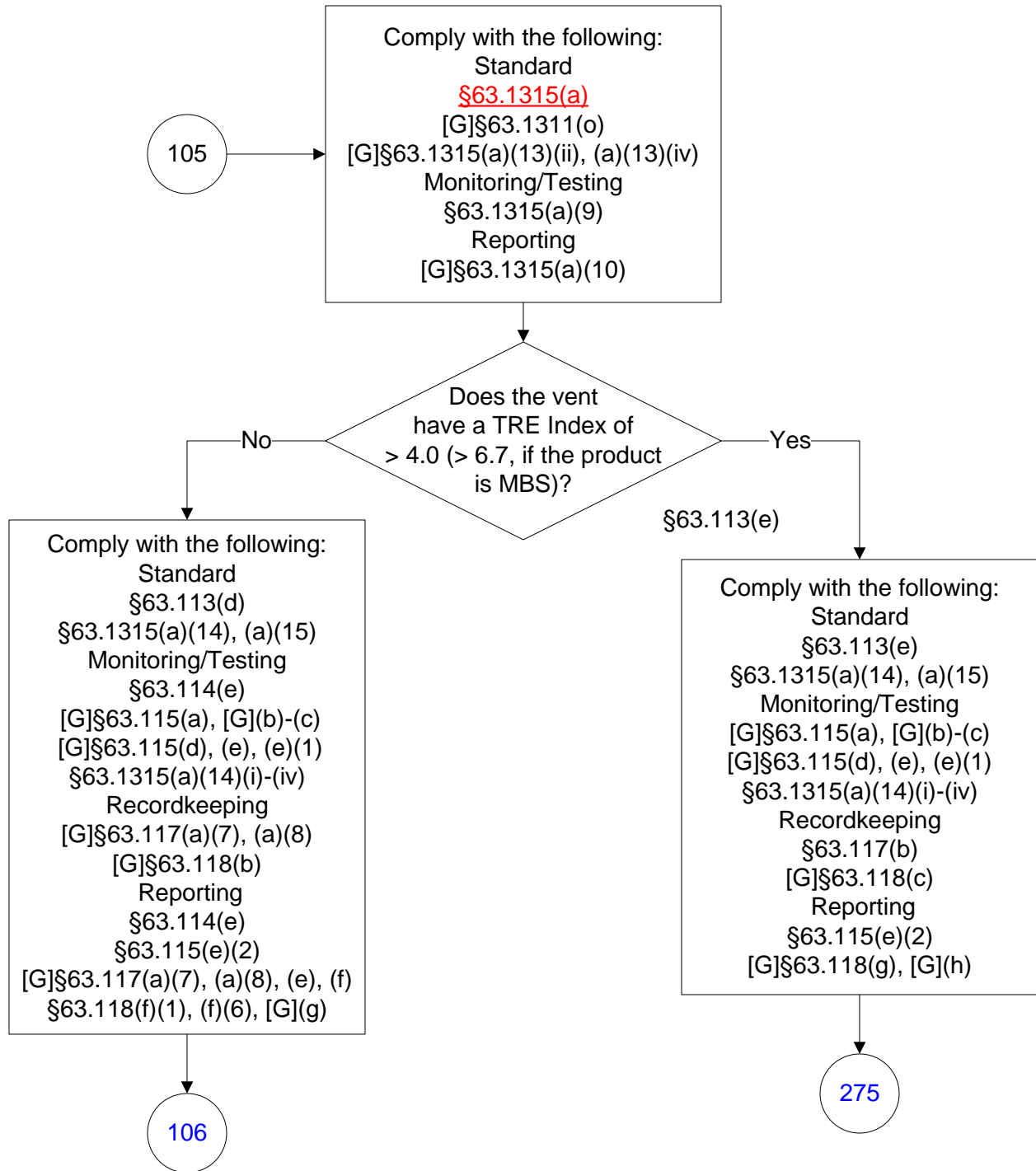

40 CFR Part 63, Subpart JJJ

(43 of 196)

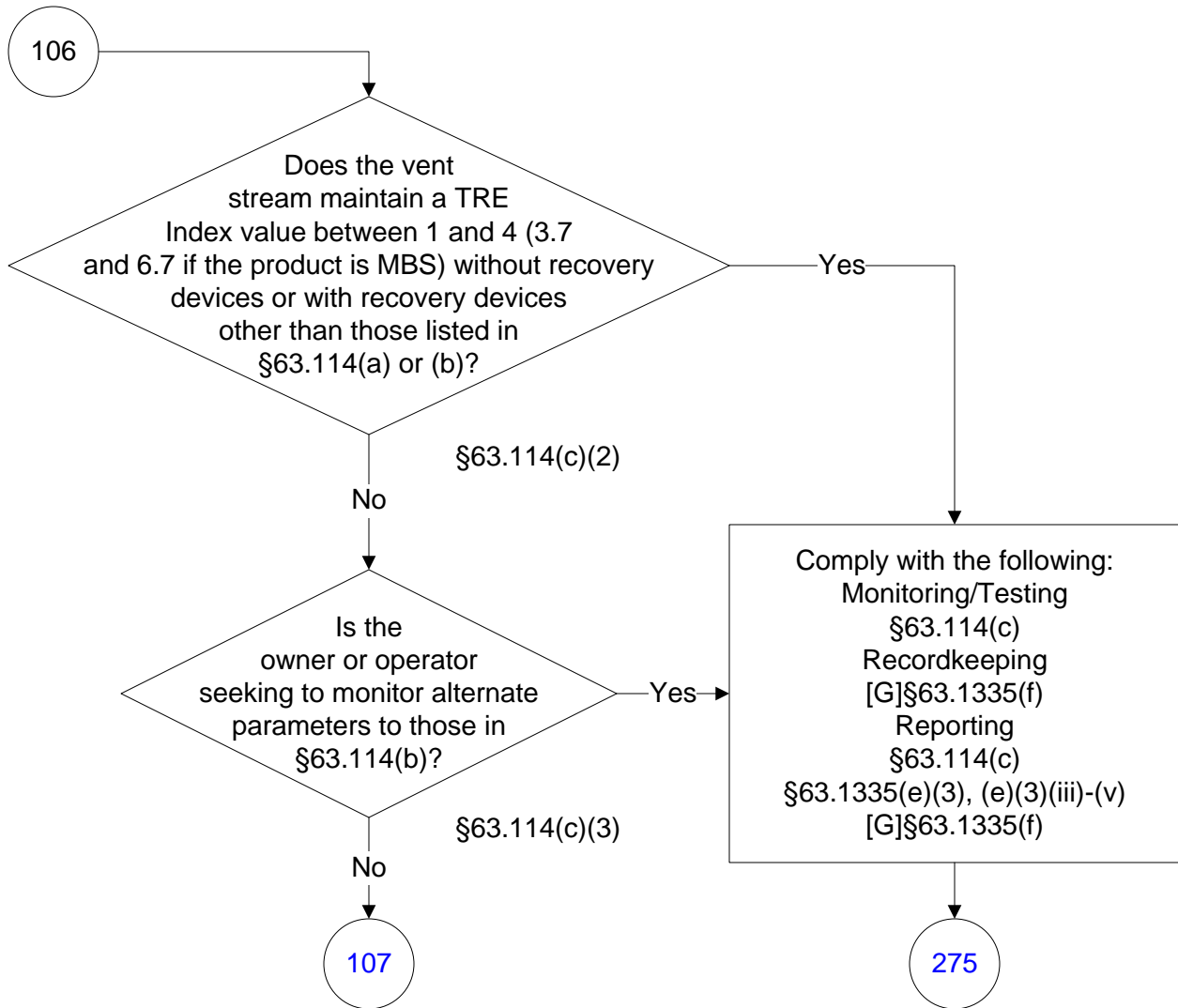

40 CFR Part 63, Subpart JJJ

(44 of 196)

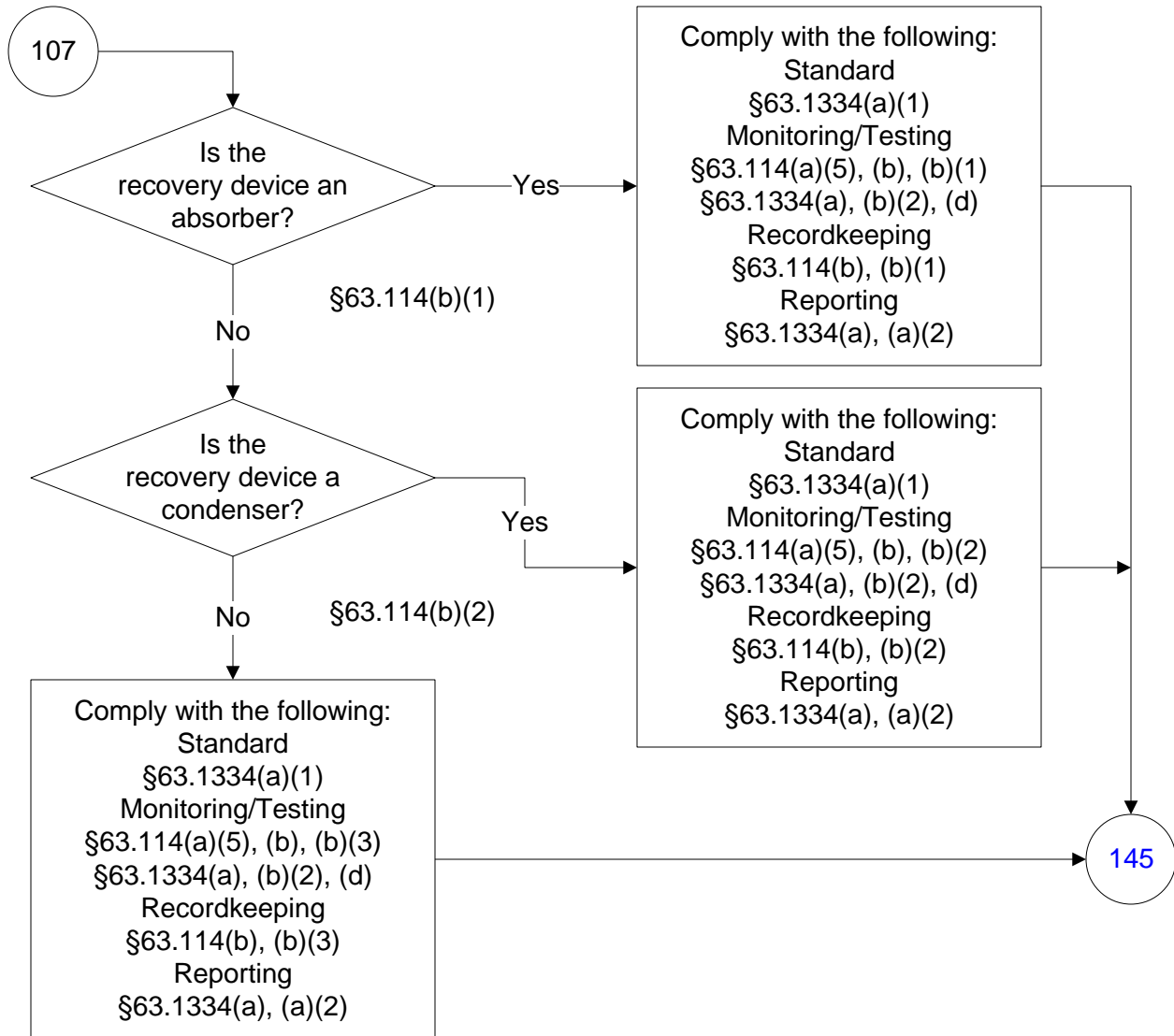

40 CFR Part 63, Subpart JJJ

(45 of 196)

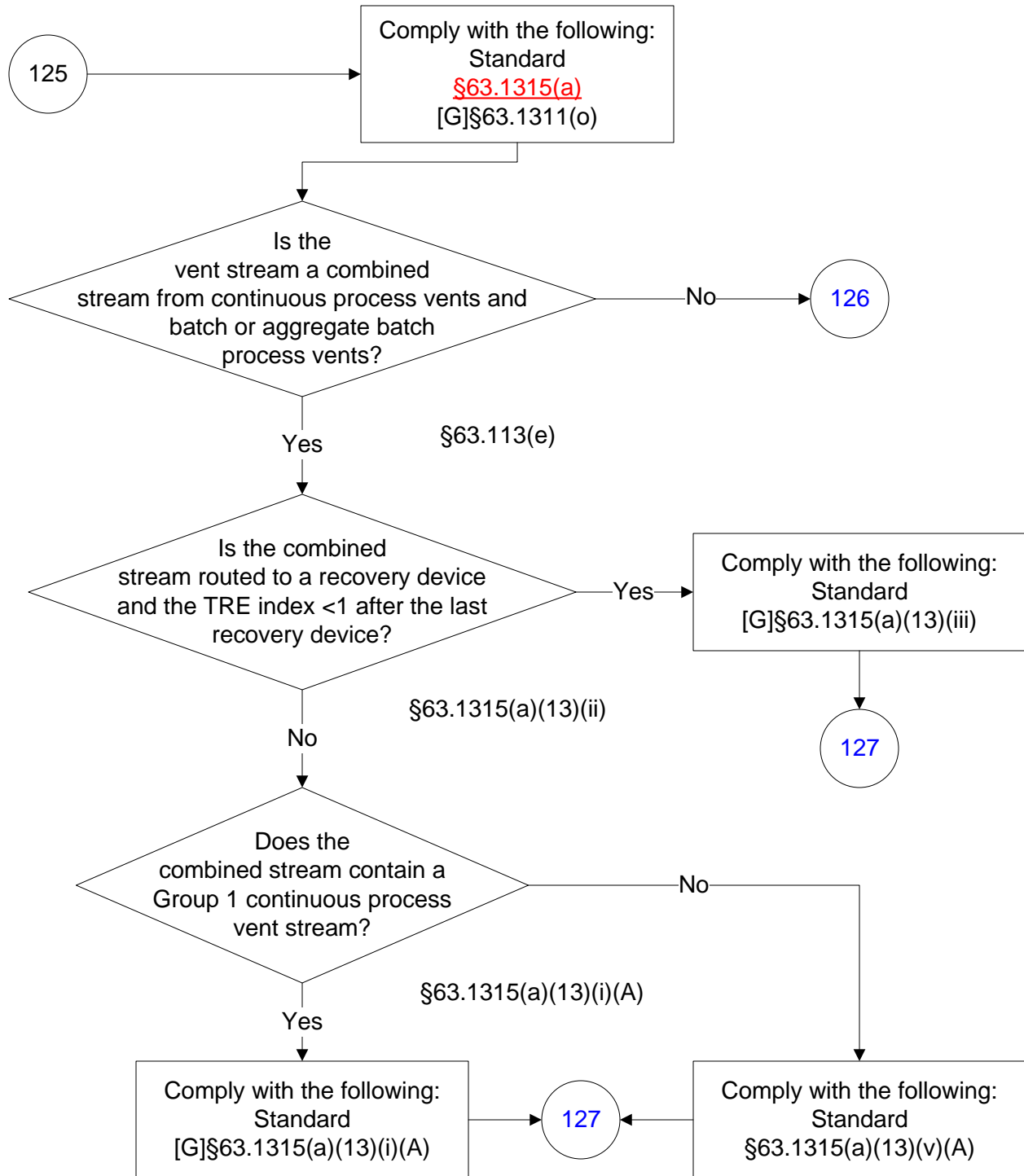

40 CFR Part 63, Subpart JJJ

(46 of 196)

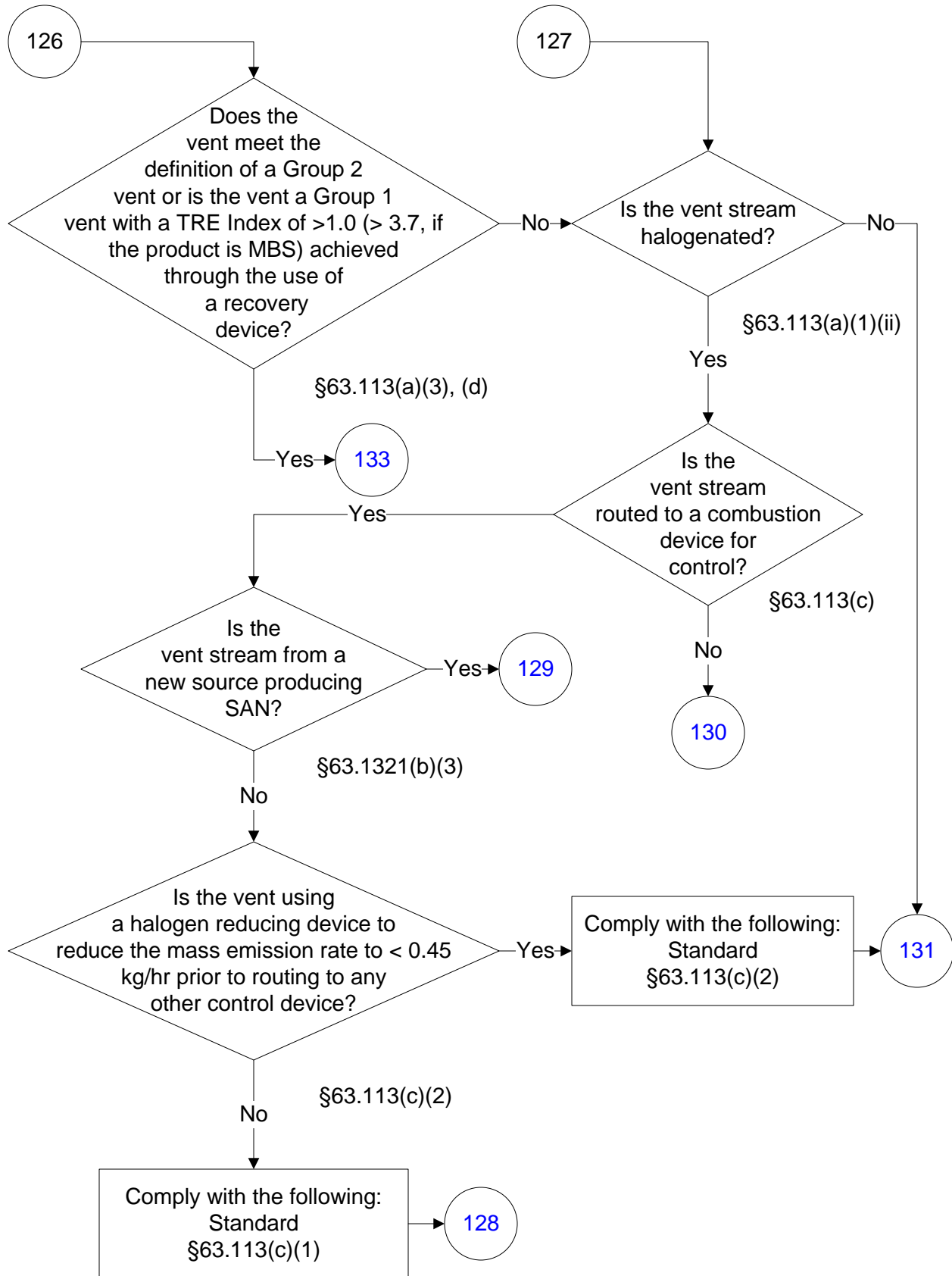

40 CFR Part 63, Subpart JJJ

(47 of 196)

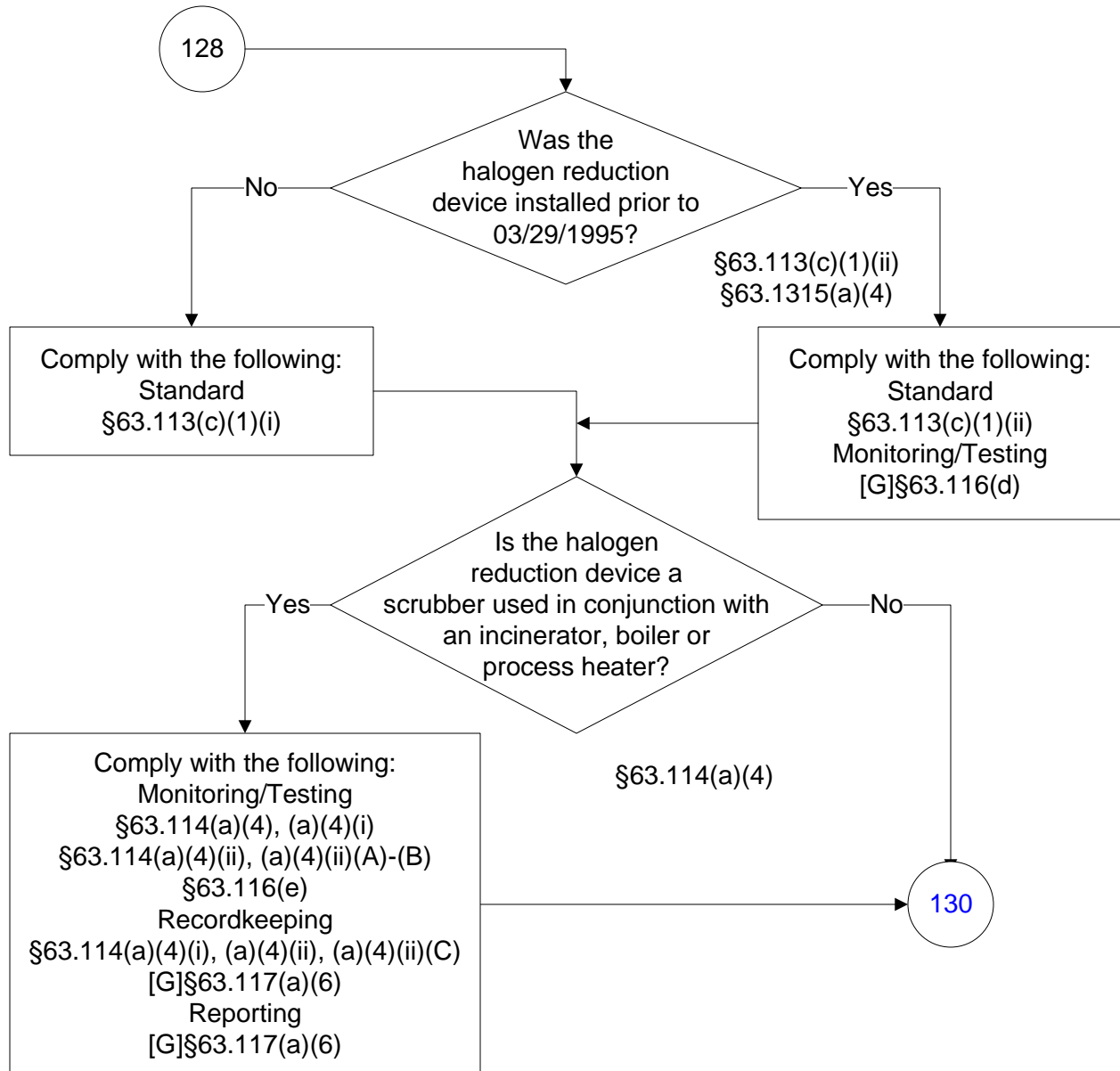

40 CFR Part 63, Subpart JJJ

(48 of 196)

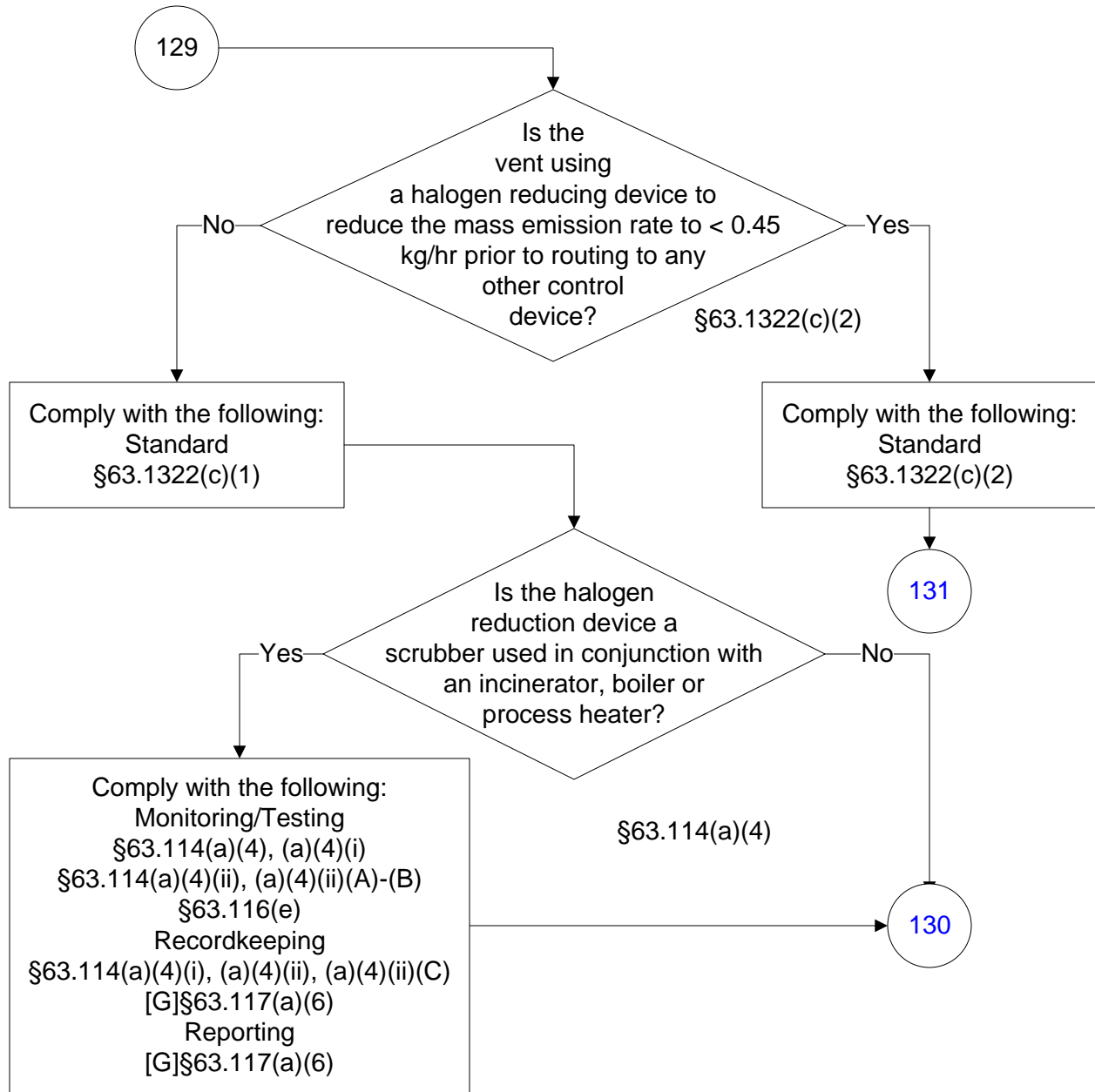

40 CFR Part 63, Subpart JJJ

(49 of 196)

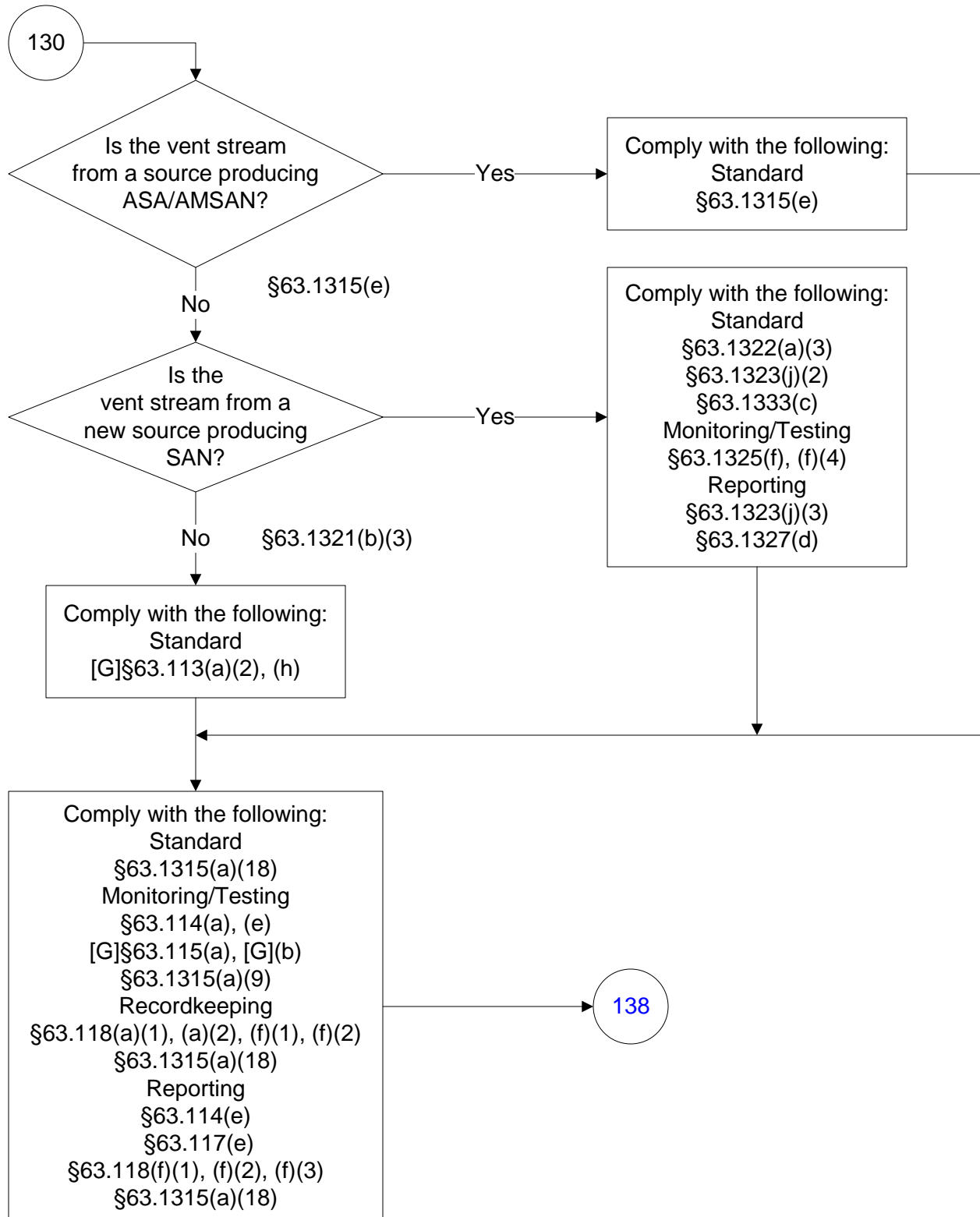

40 CFR Part 63, Subpart JJJ

(50 of 196)

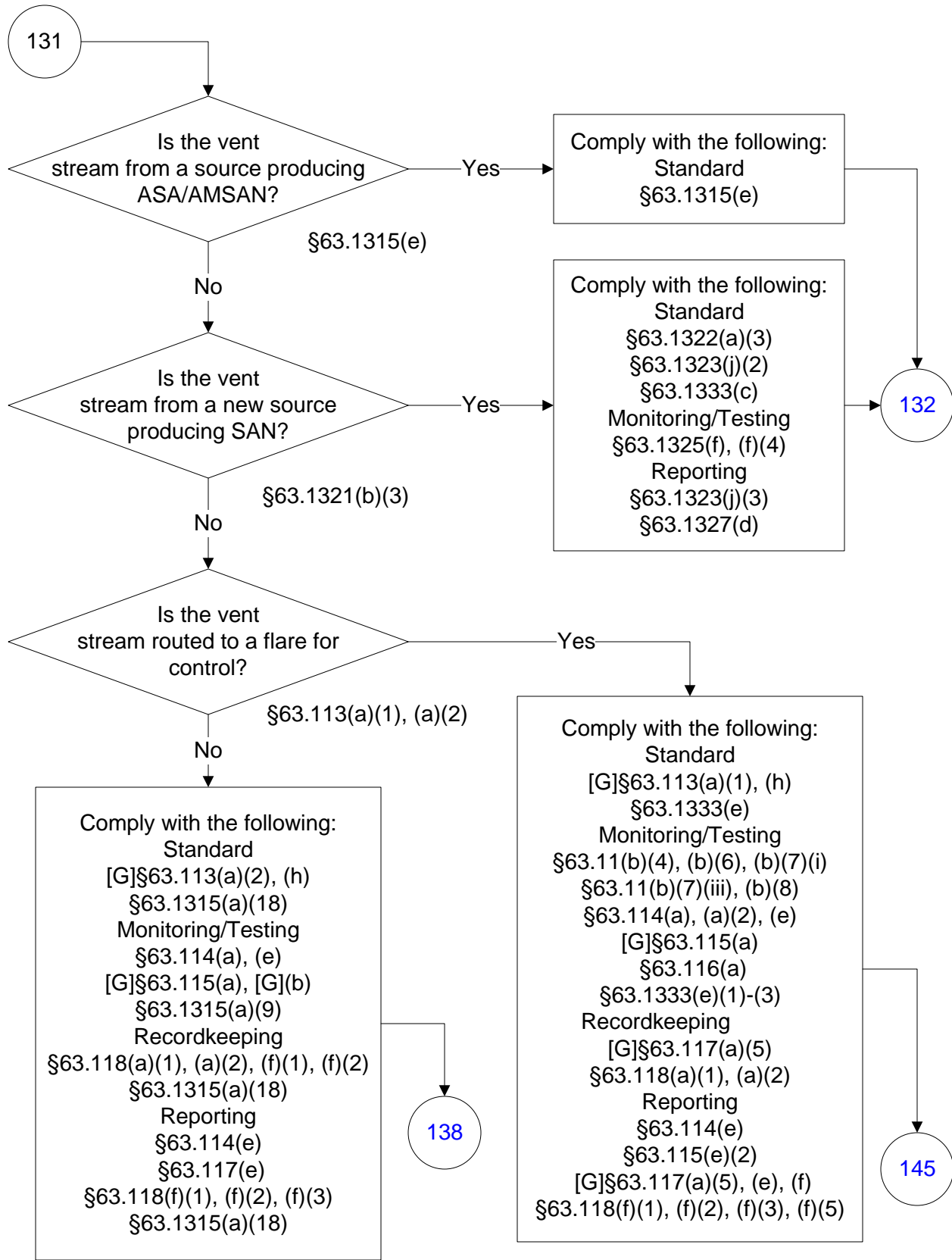

40 CFR Part 63, Subpart JJJ

(51 of 196)

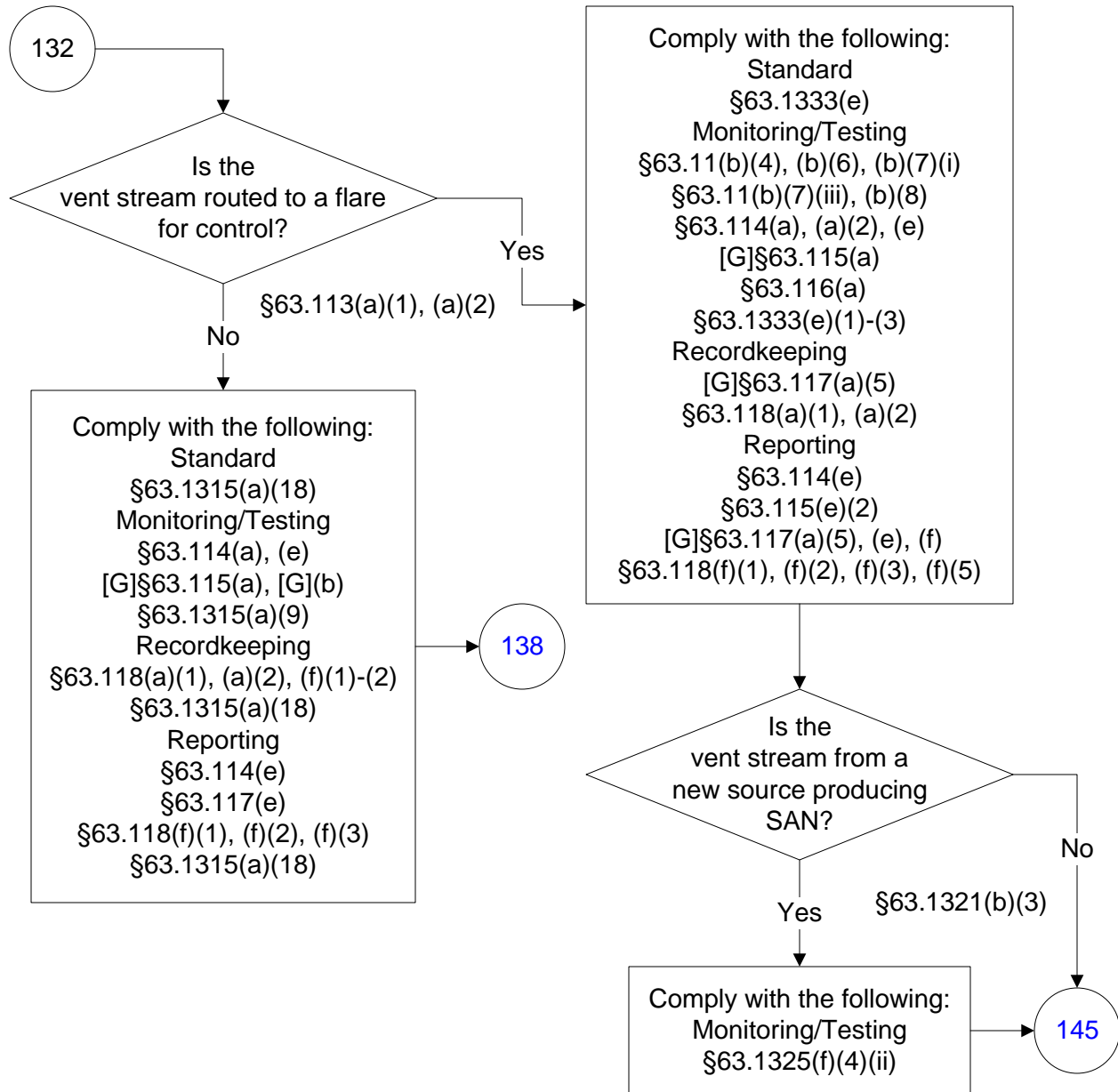

40 CFR Part 63, Subpart JJJ

(52 of 196)

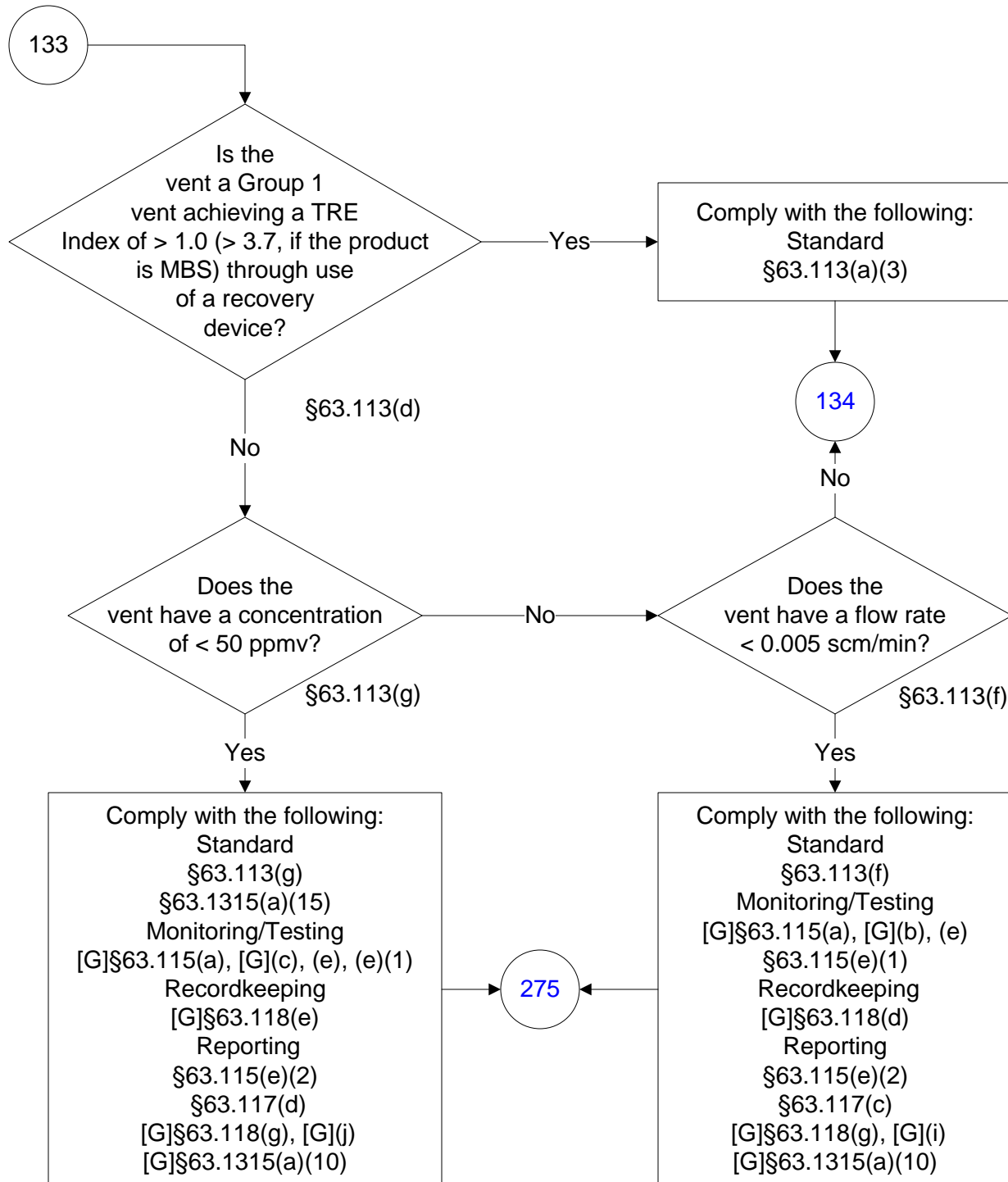

40 CFR Part 63, Subpart JJJ

(53 of 196)

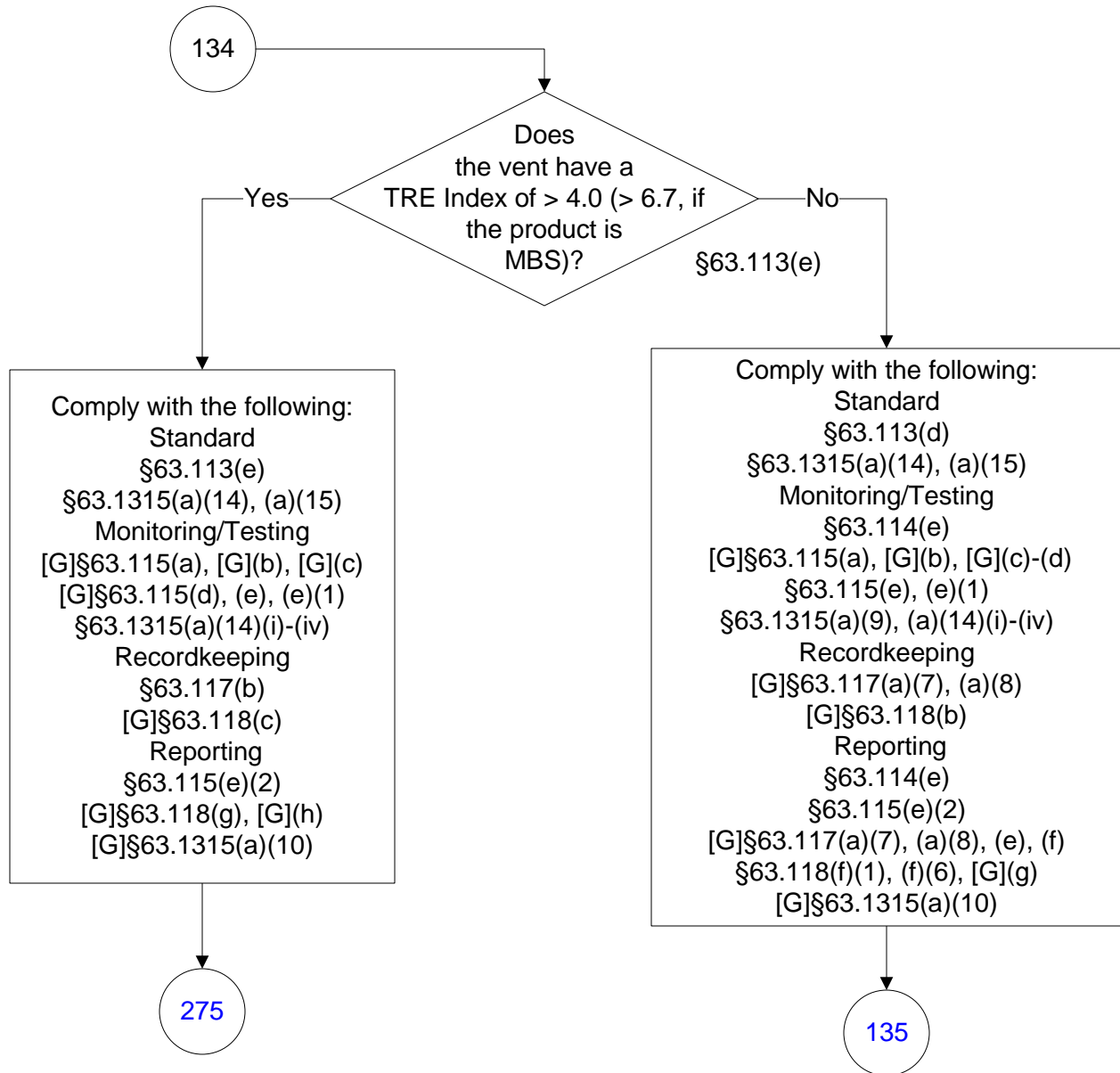

40 CFR Part 63, Subpart JJJ

(54 of 196)

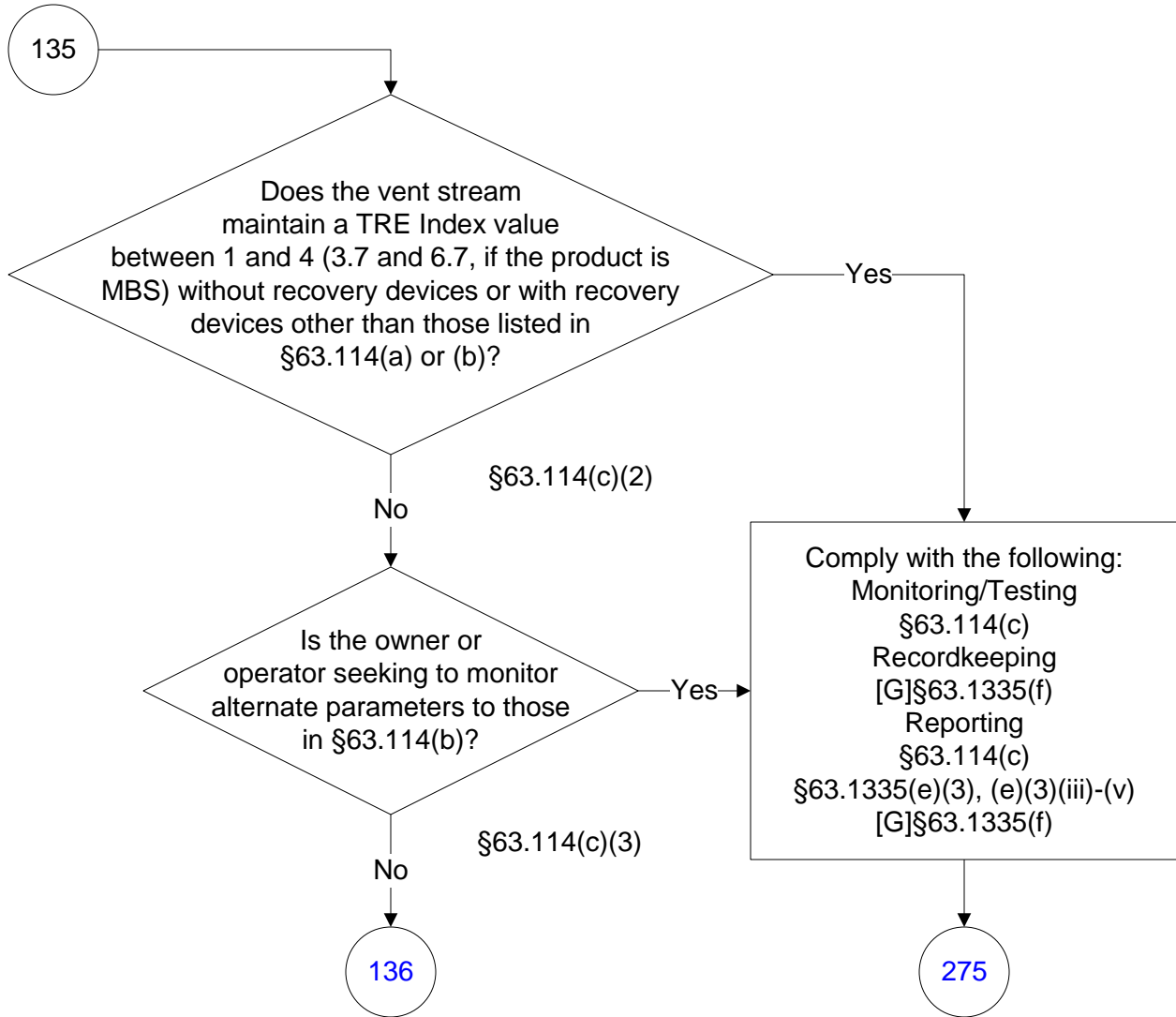

40 CFR Part 63, Subpart JJJ

(55 of 196)

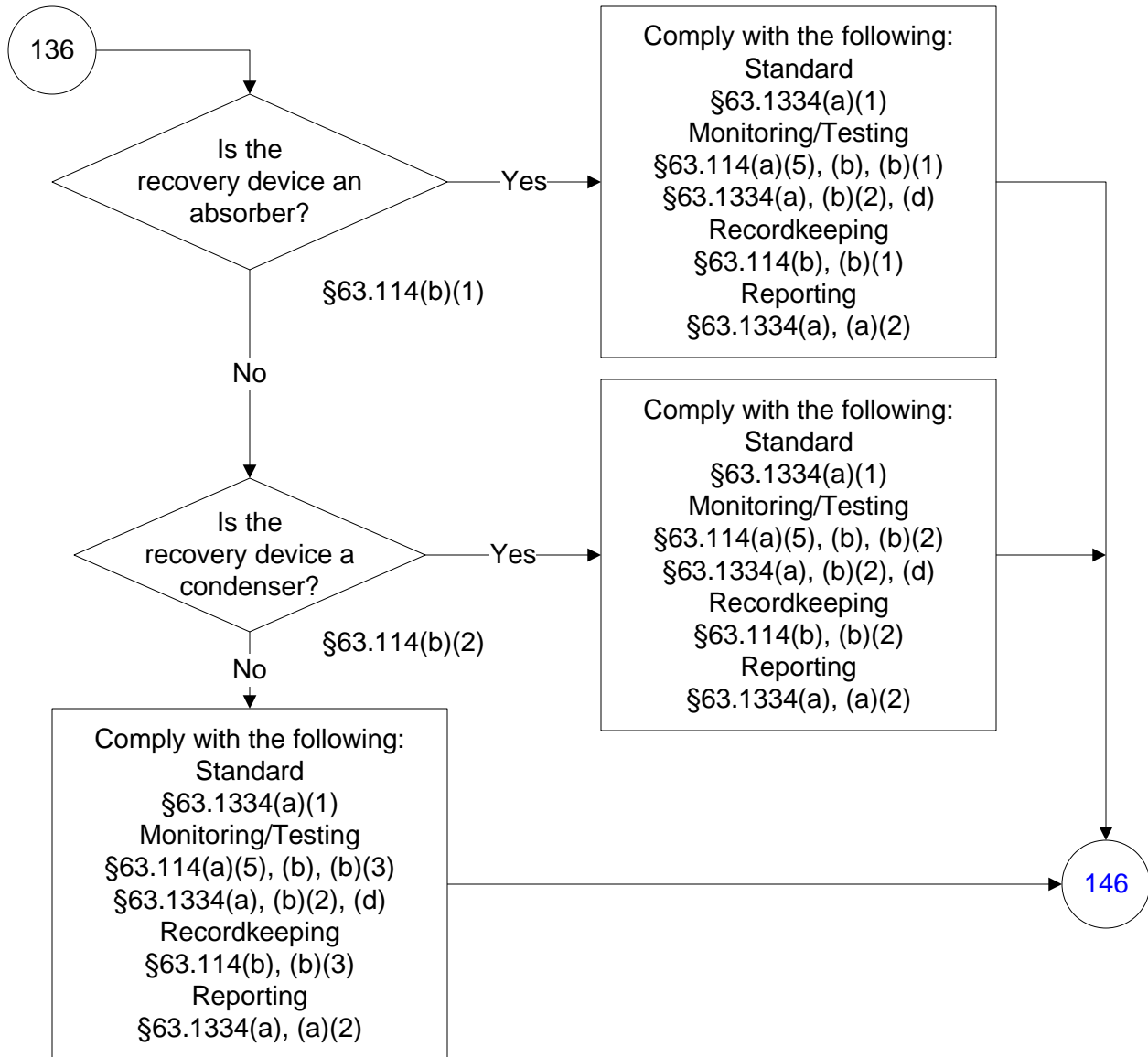

40 CFR Part 63, Subpart JJJ

(56 of 196)

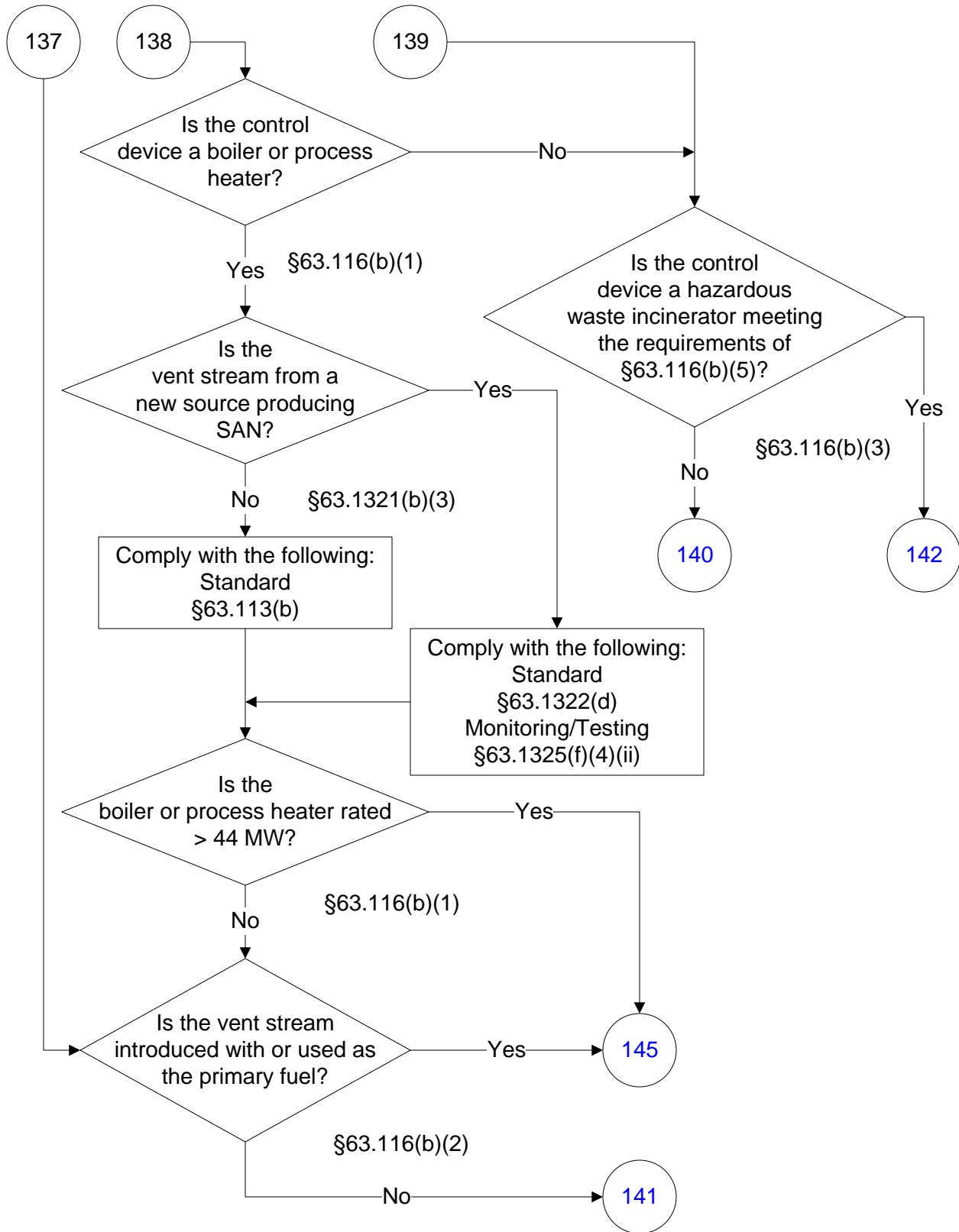

40 CFR Part 63, Subpart JJJ

(57 of 196)

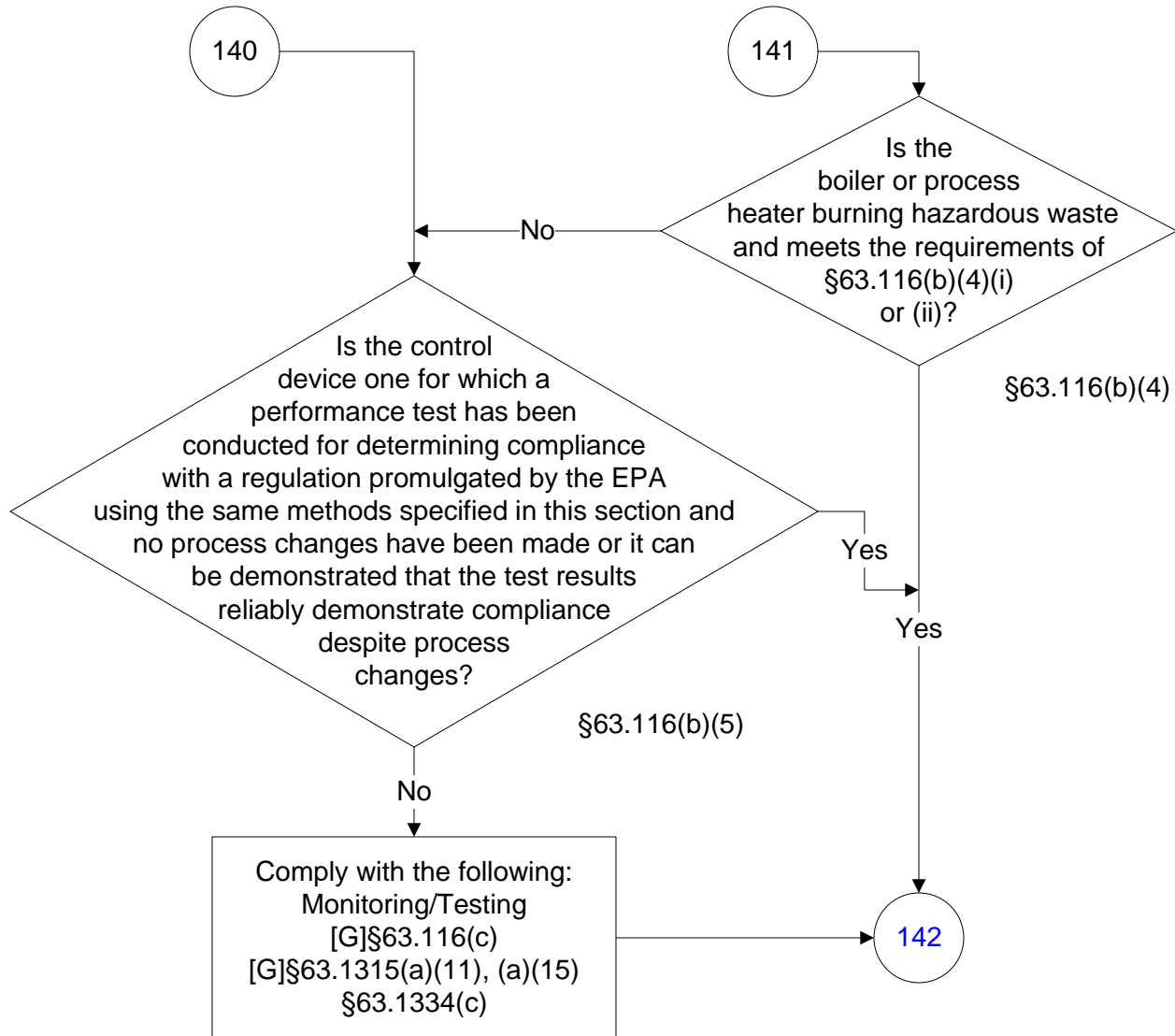

40 CFR Part 63, Subpart JJJ

(58 of 196)

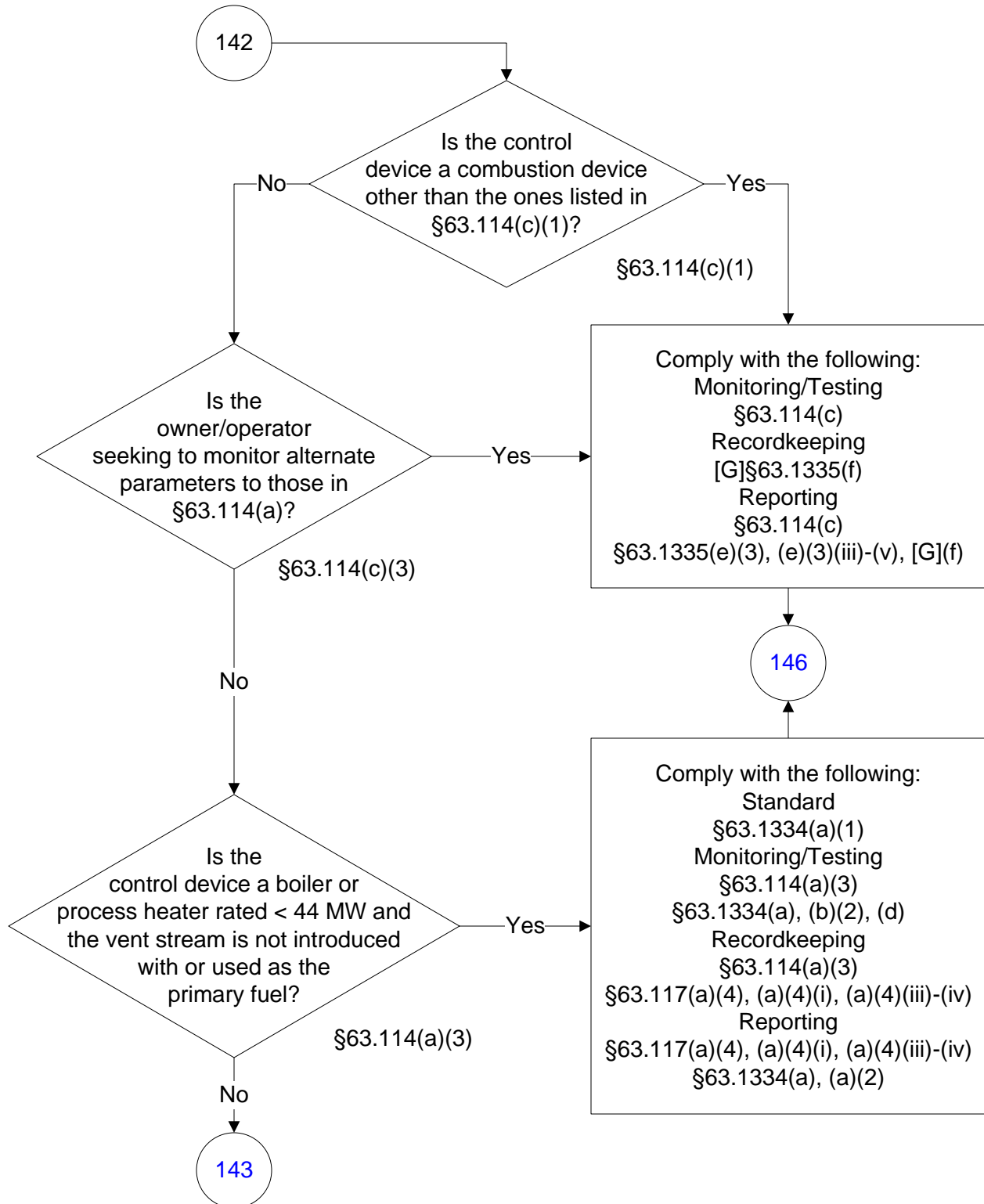

40 CFR Part 63, Subpart JJJ

(59 of 196)

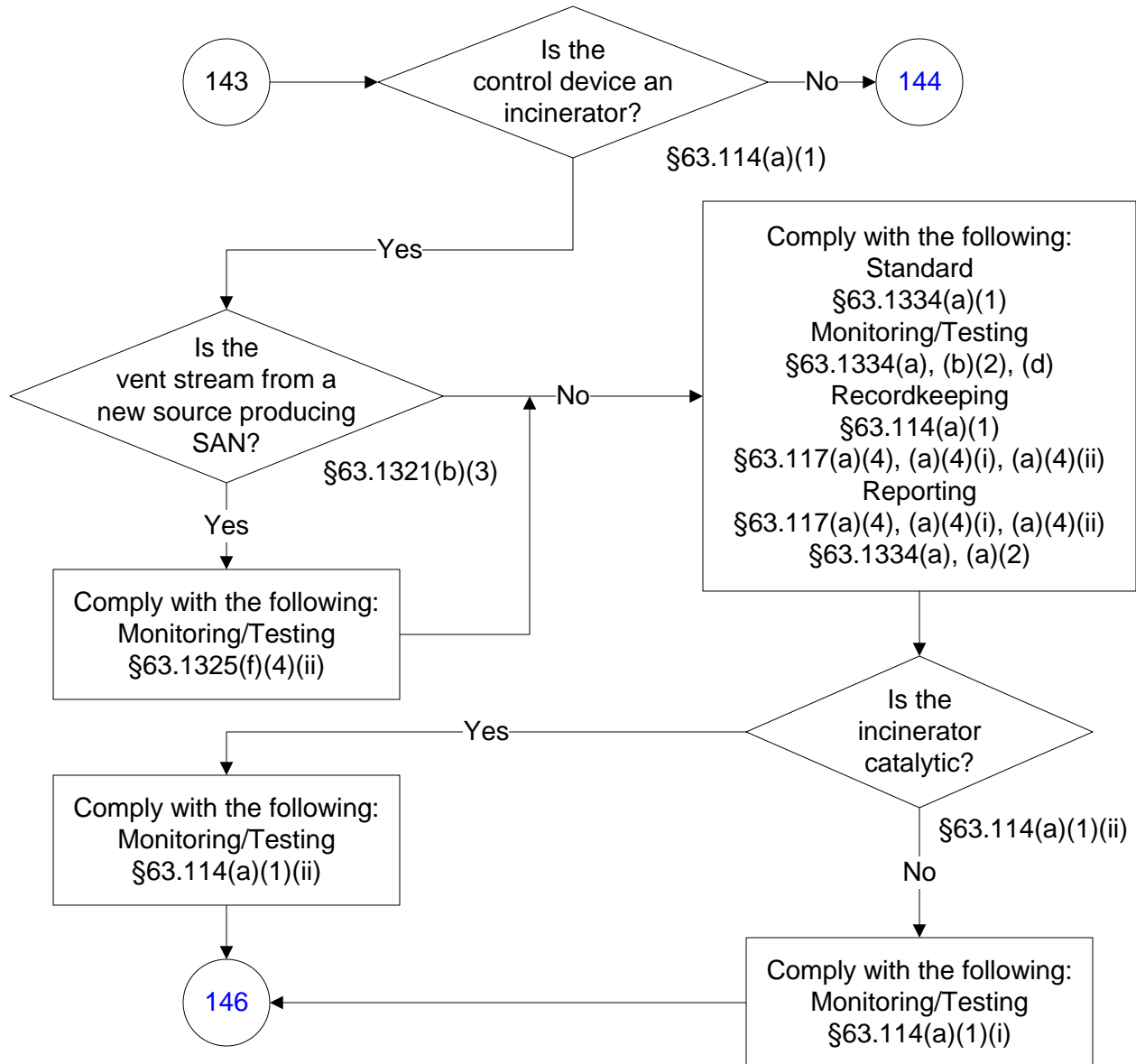

40 CFR Part 63, Subpart JJJ

(60 of 196)

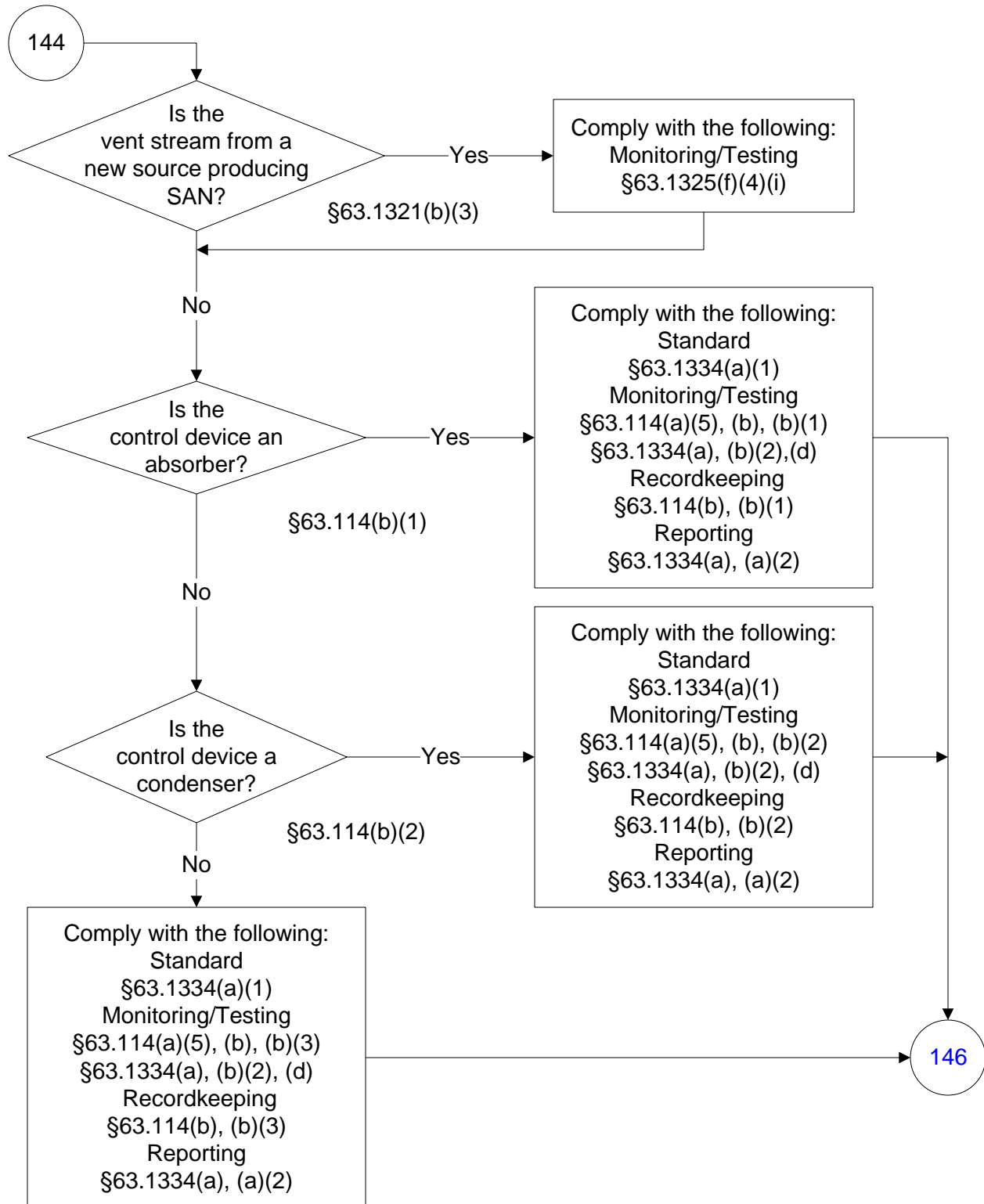

40 CFR Part 63, Subpart JJJ

(61 of 196)

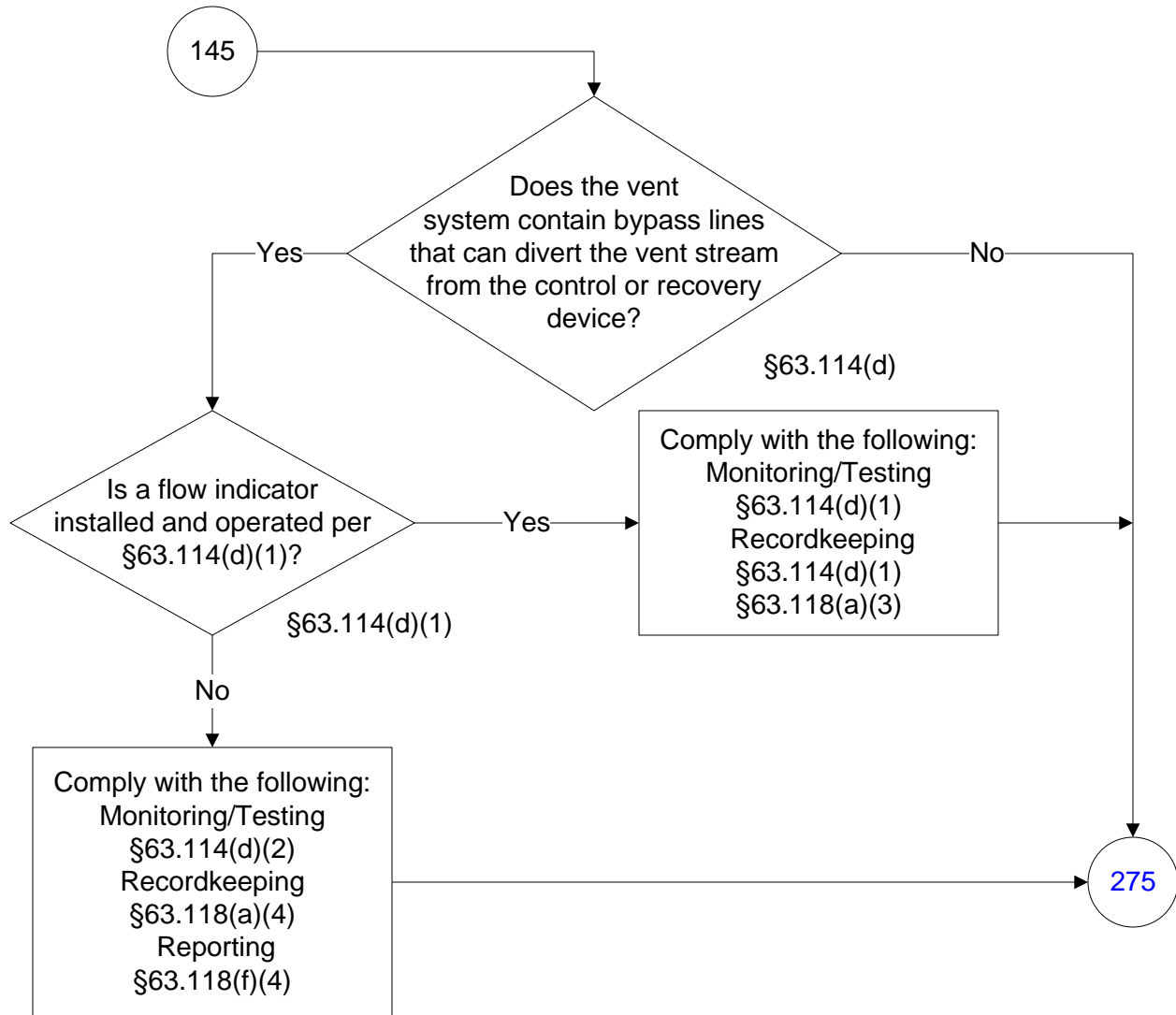

40 CFR Part 63, Subpart JJJ

(62 of 196)

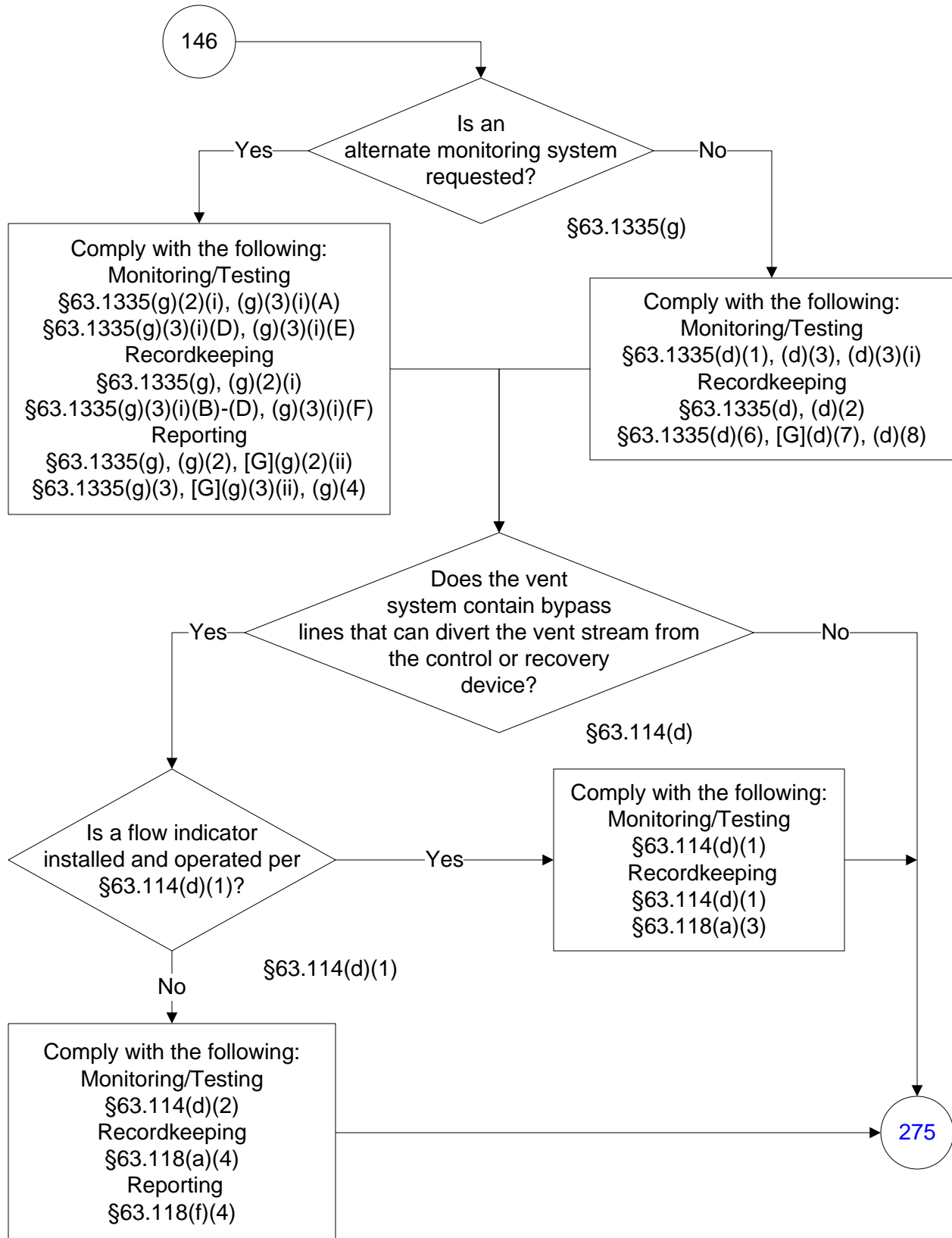

40 CFR Part 63, Subpart JJJ

(63 of 196)

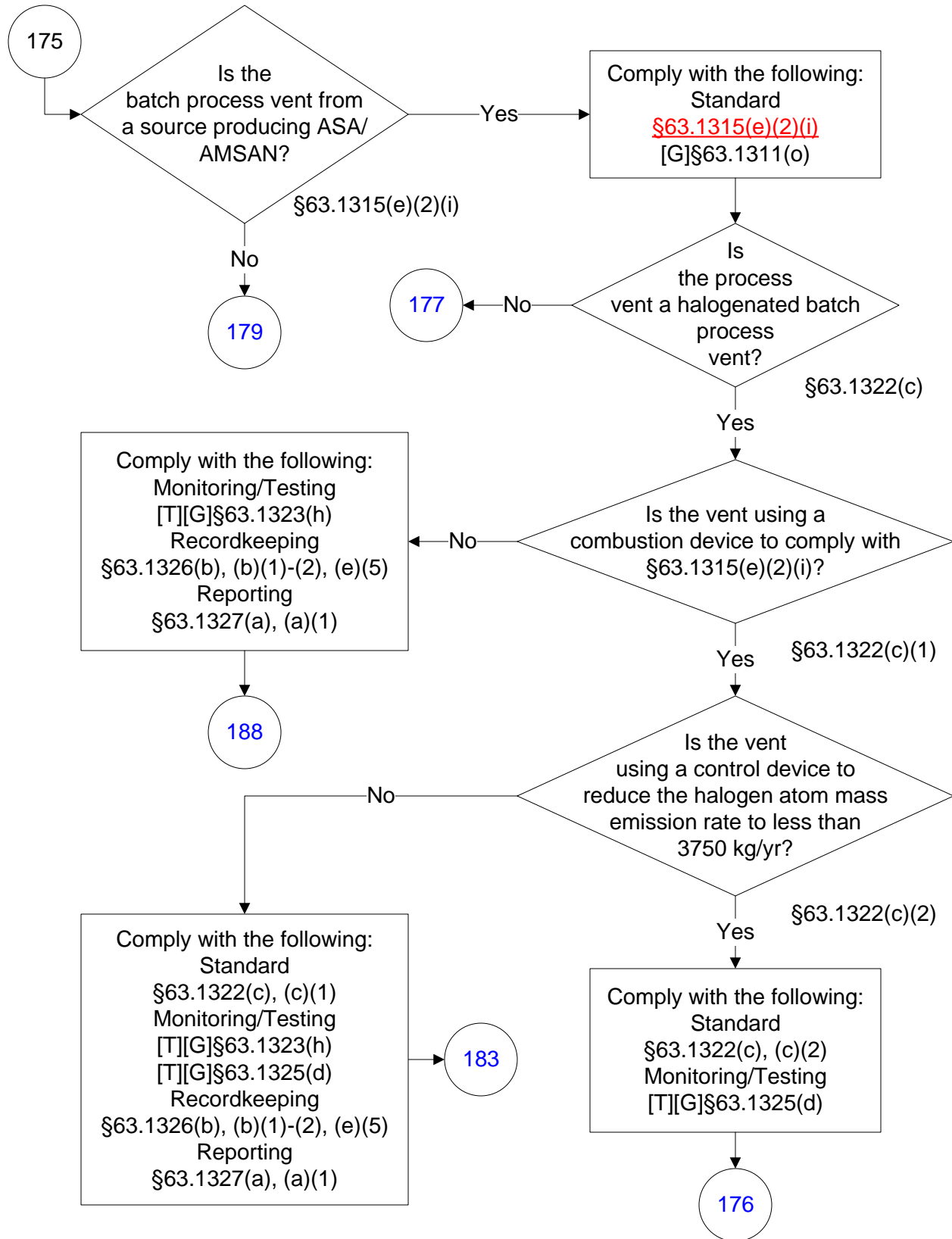

40 CFR Part 63, Subpart JJJ

(64 of 196)

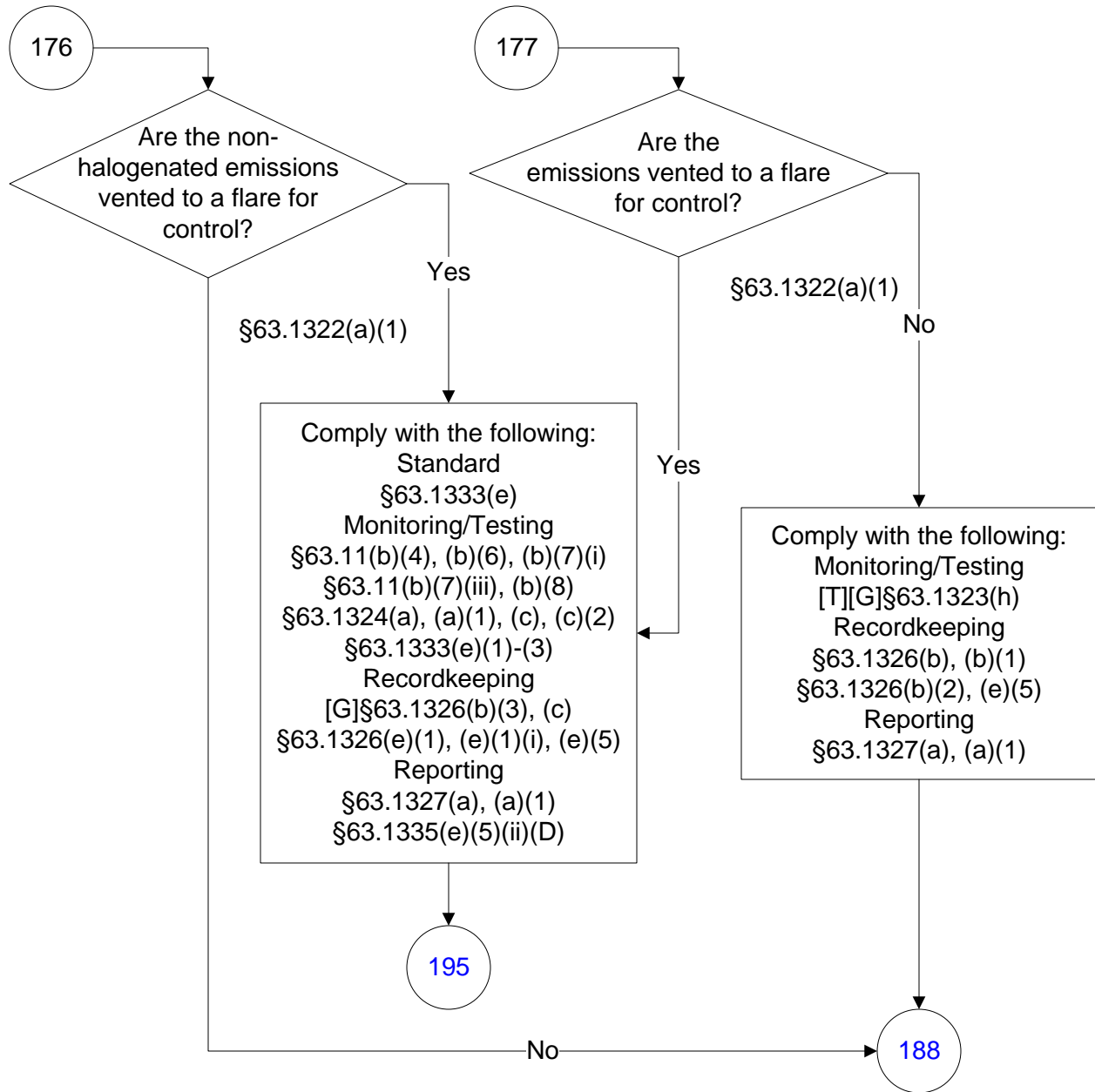

40 CFR Part 63, Subpart JJJ

(65 of 196)

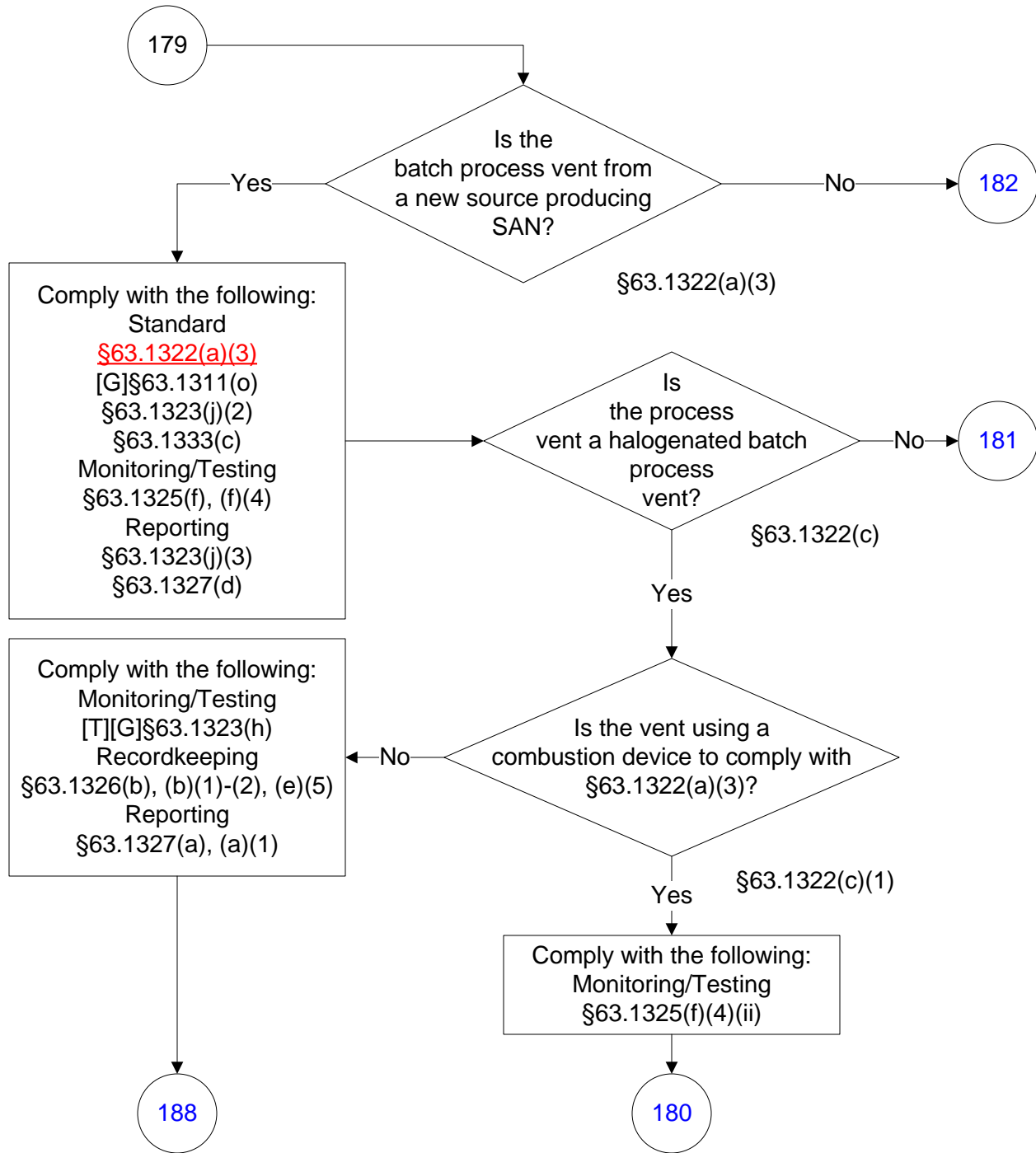

40 CFR Part 63, Subpart JJJ

(66 of 196)

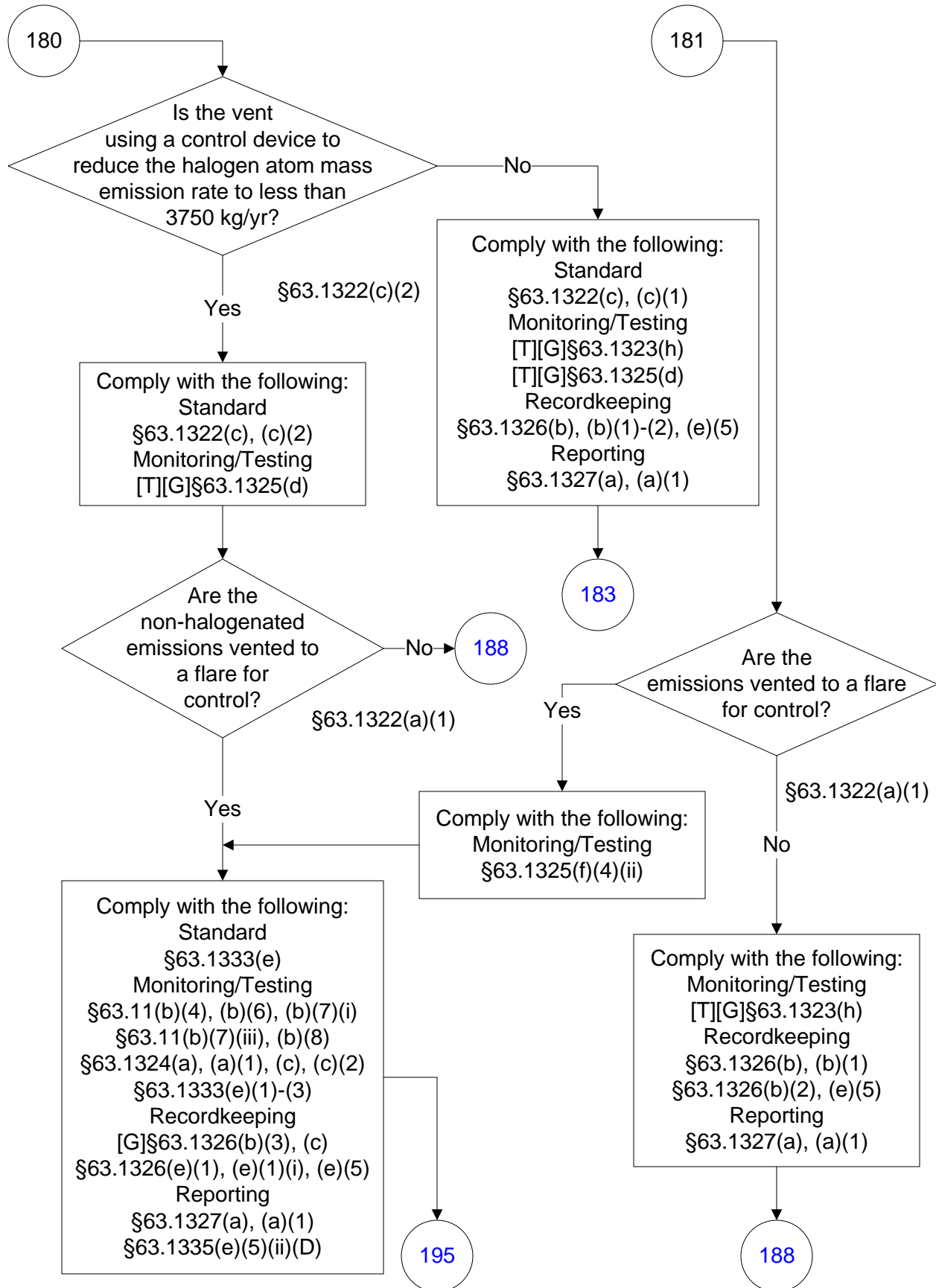

40 CFR Part 63, Subpart JJJ

(67 of 196)

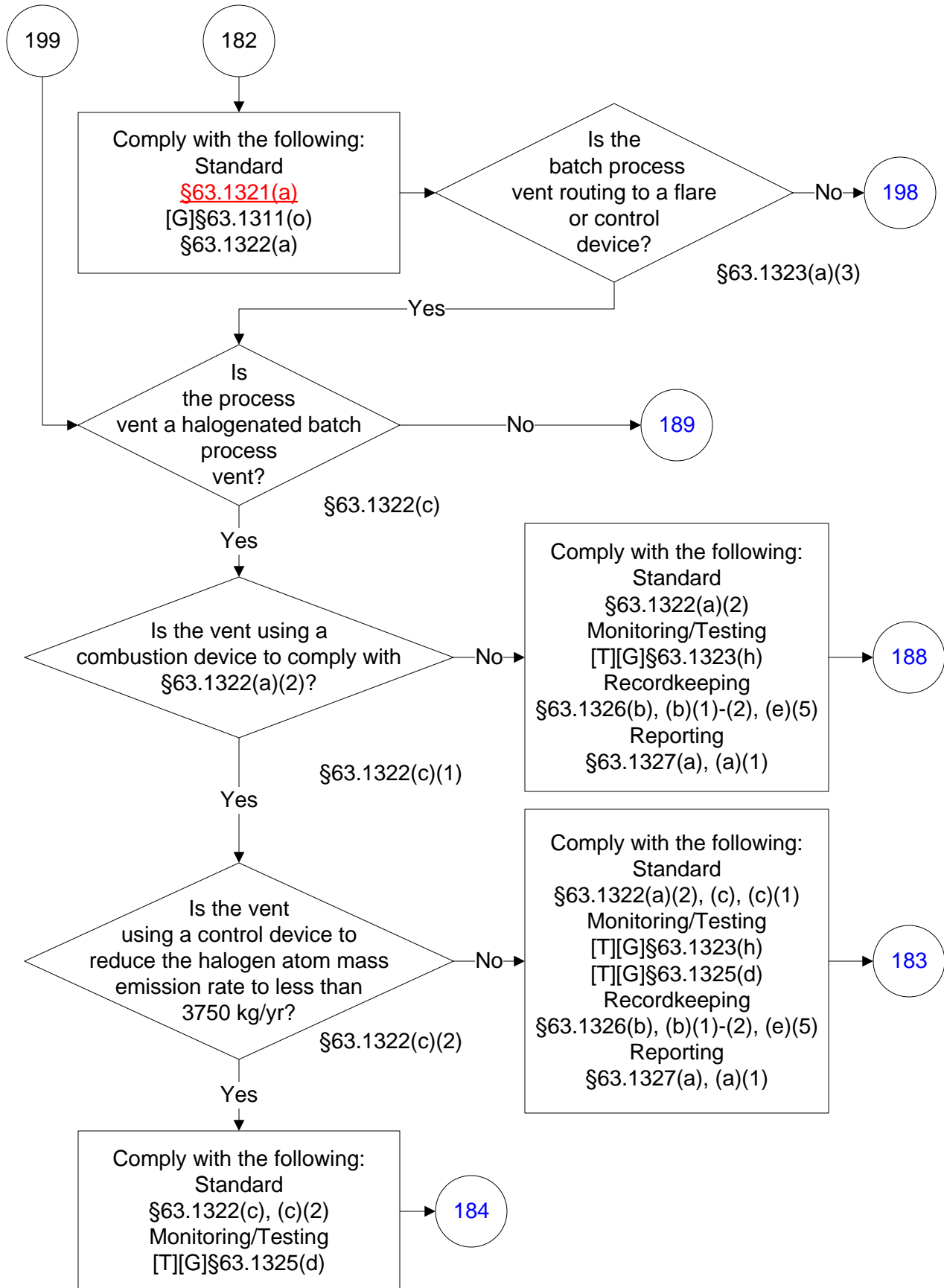

40 CFR Part 63, Subpart JJJ

(68 of 196)

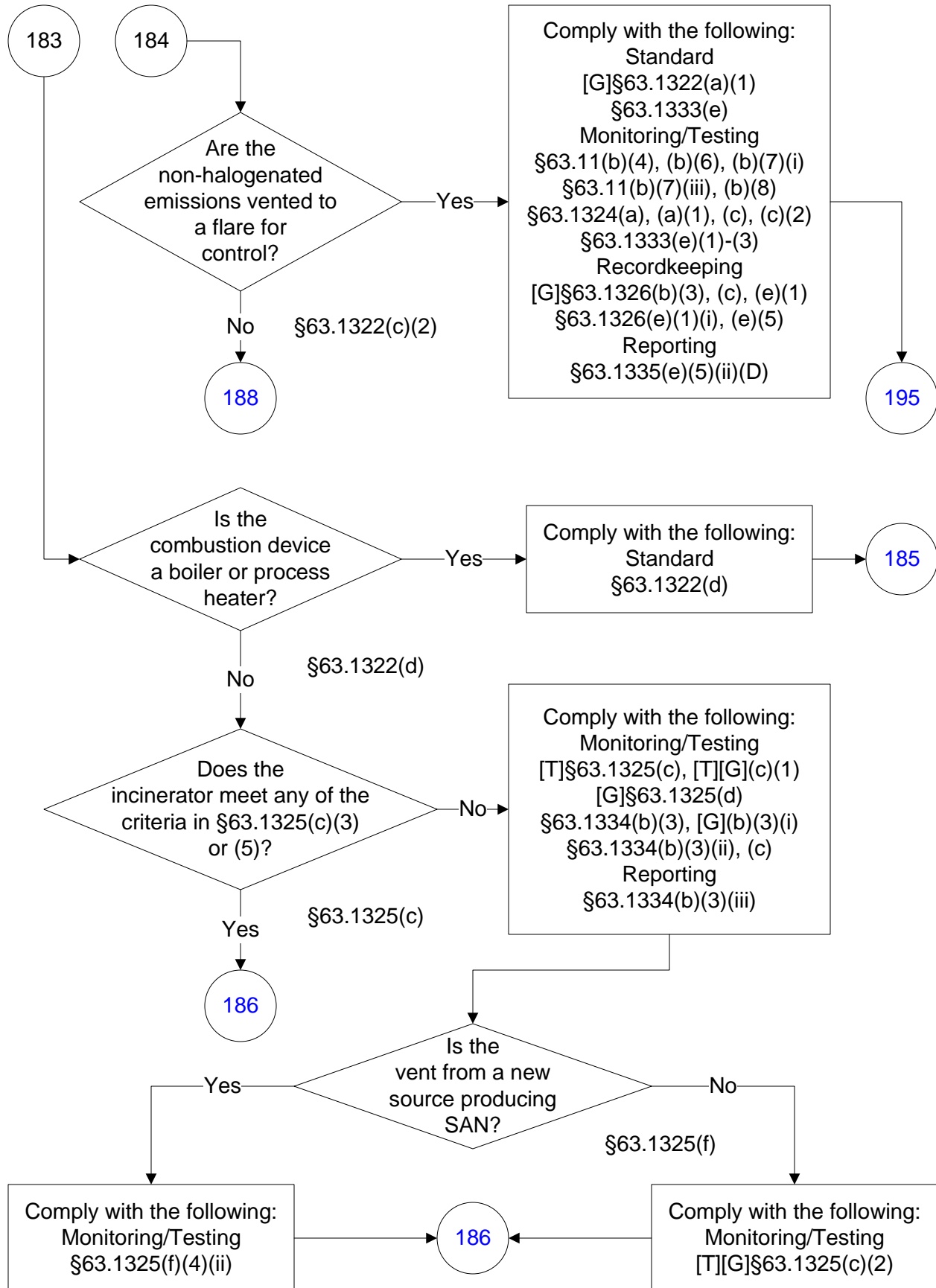

40 CFR Part 63, Subpart JJJ

(69 of 196)

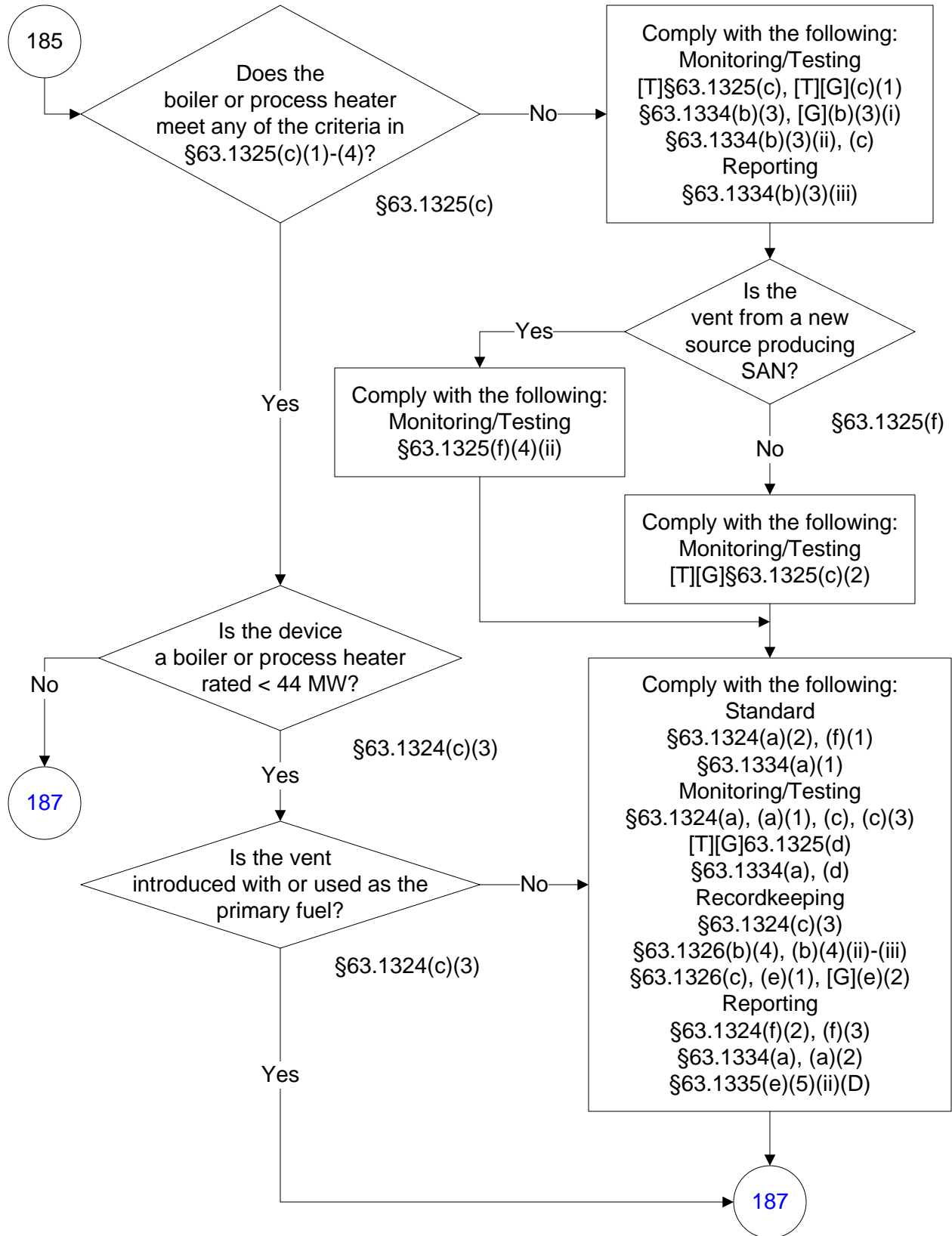

40 CFR Part 63, Subpart JJJ

(70 of 196)

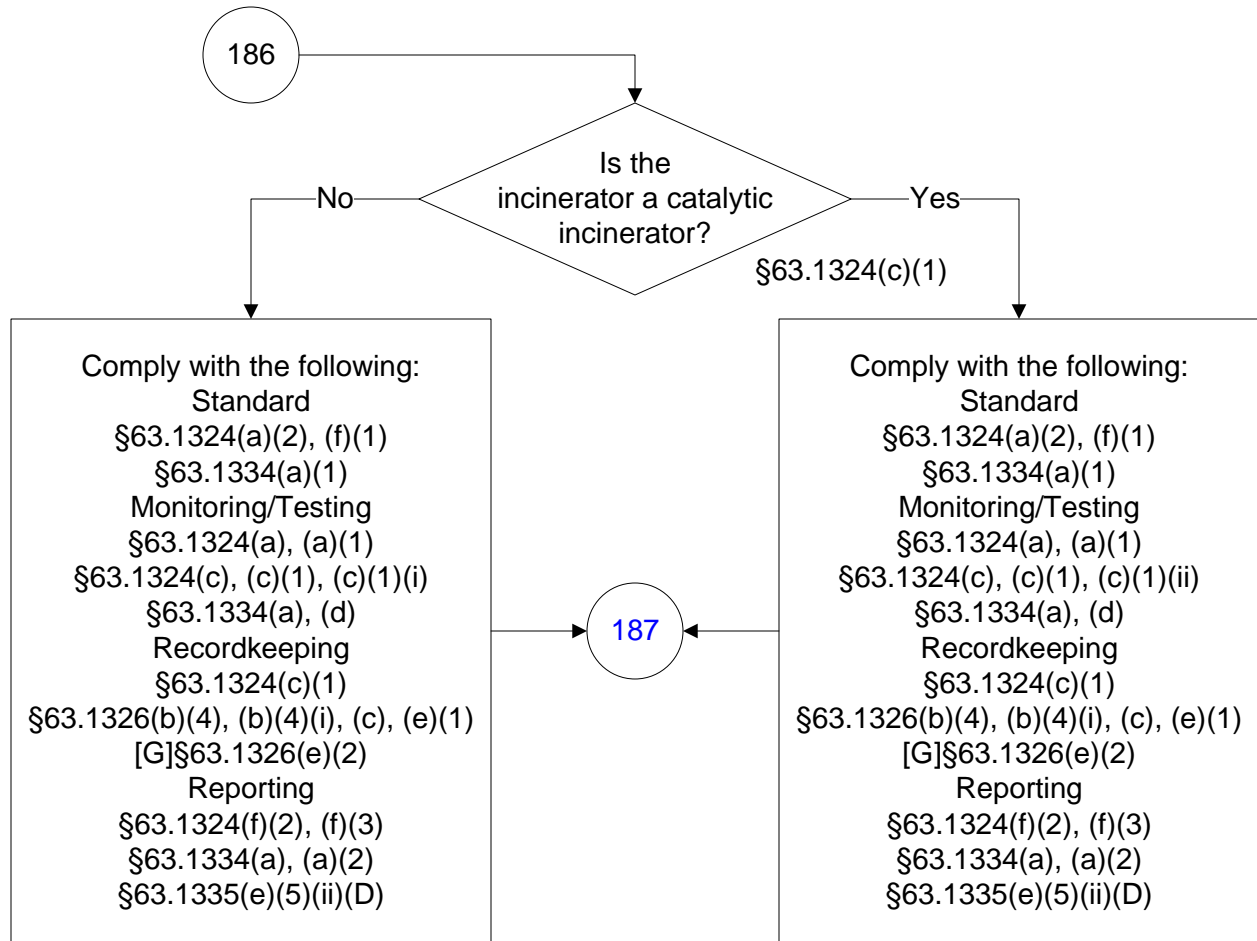

40 CFR Part 63, Subpart JJJ

(71 of 196)

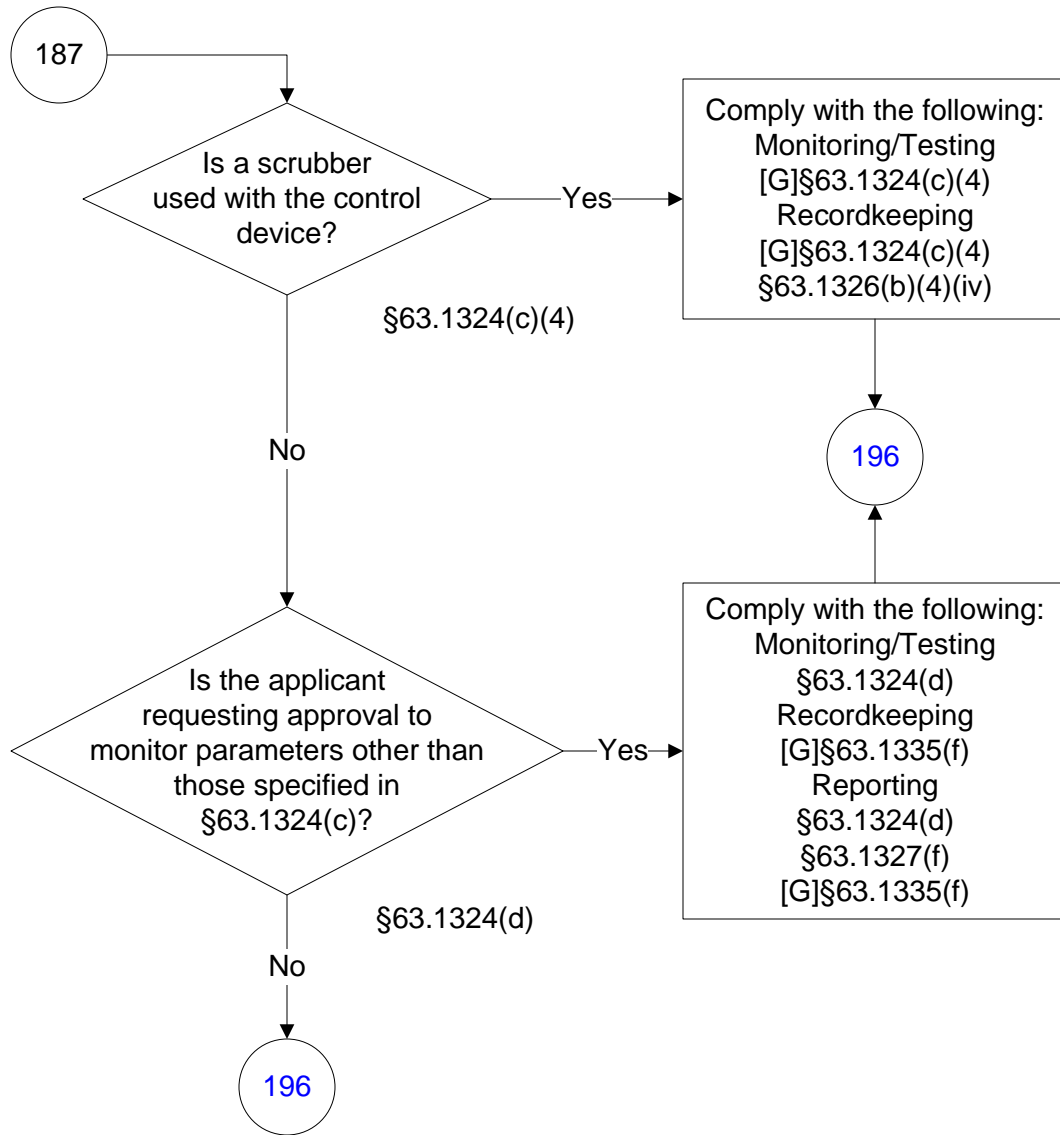

40 CFR Part 63, Subpart JJJ

(72 of 196)

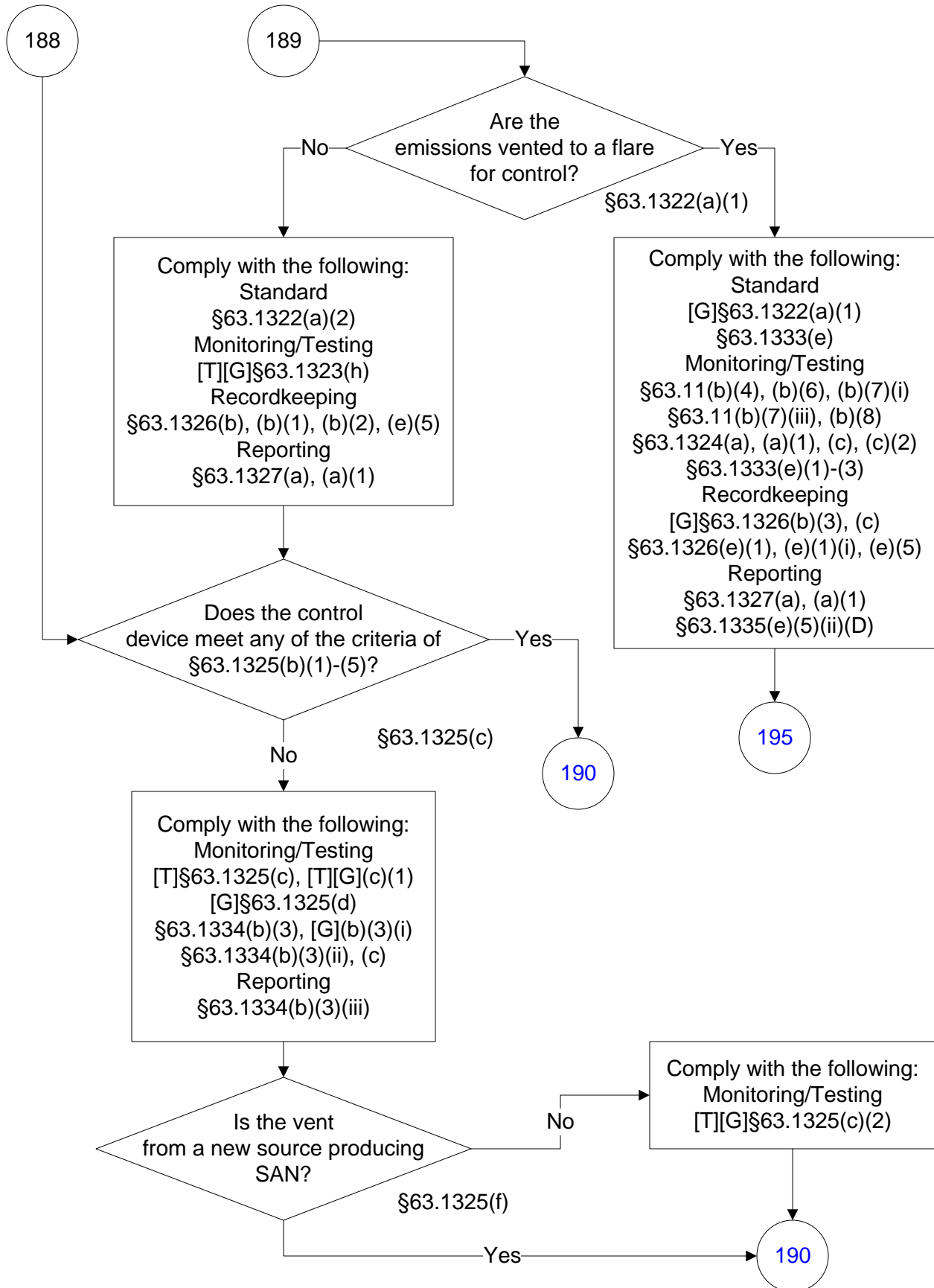

40 CFR Part 63, Subpart JJJ

(73 of 196)

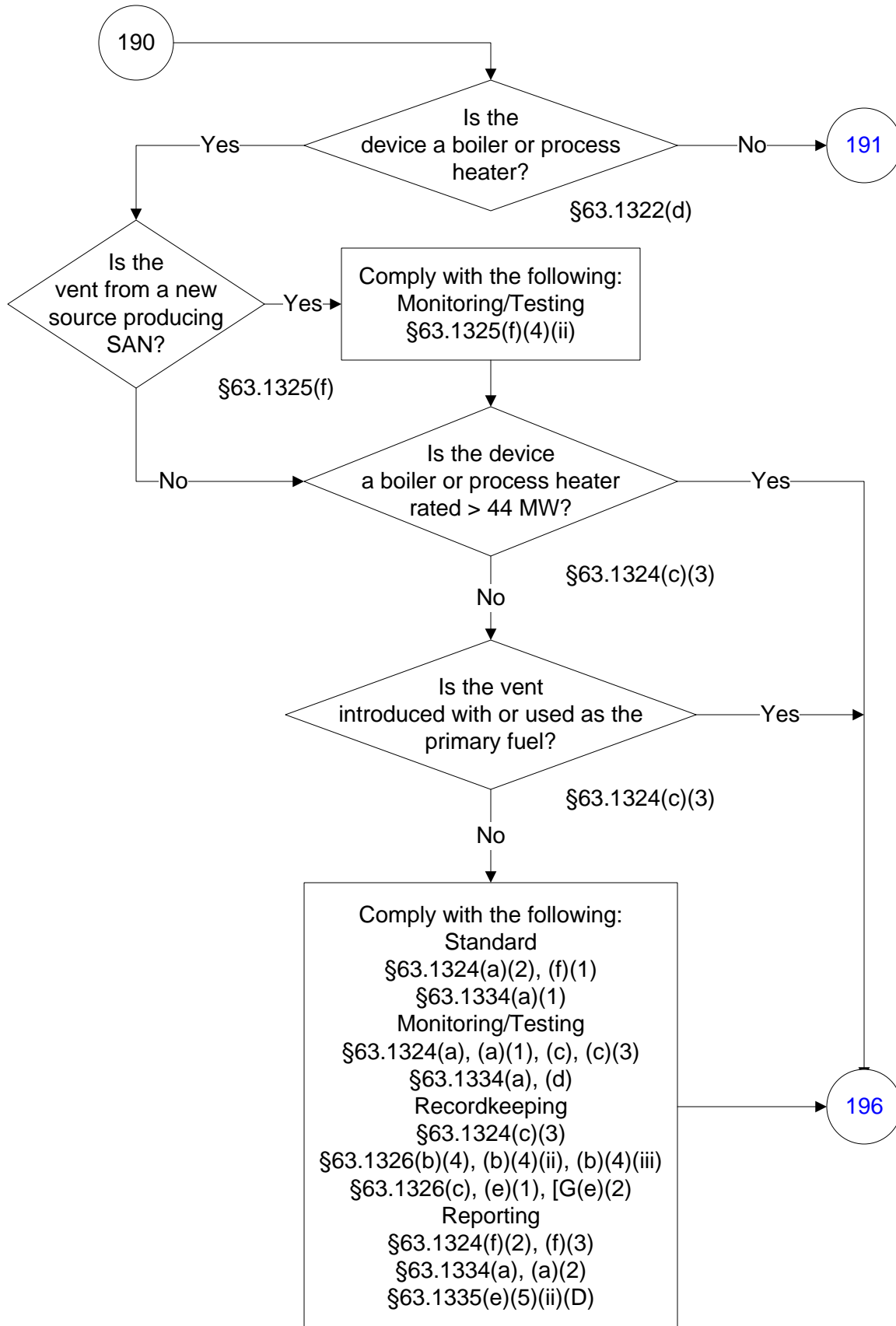

40 CFR Part 63, Subpart JJJ

(74 of 196)

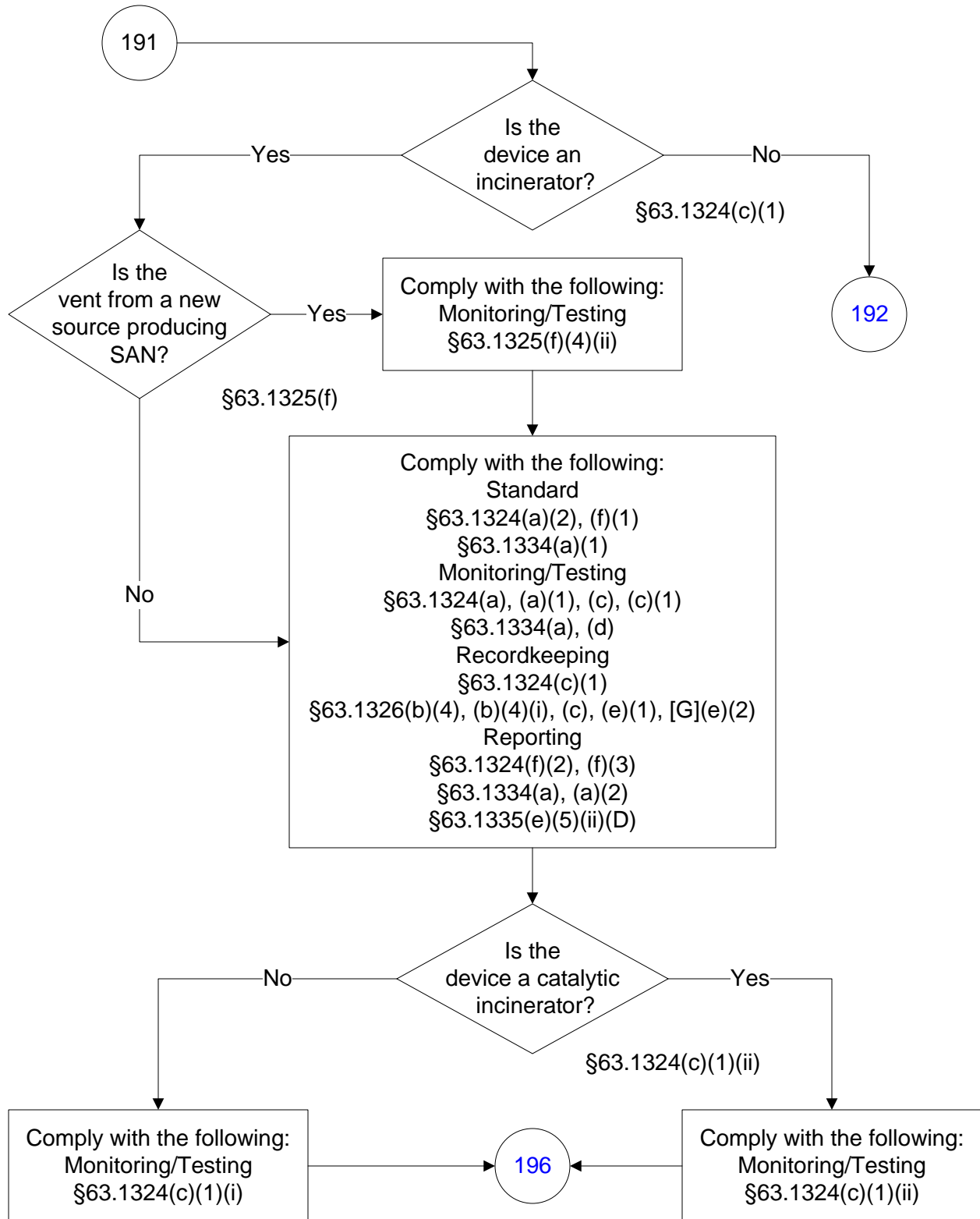

40 CFR Part 63, Subpart JJJ

(75 of 196)

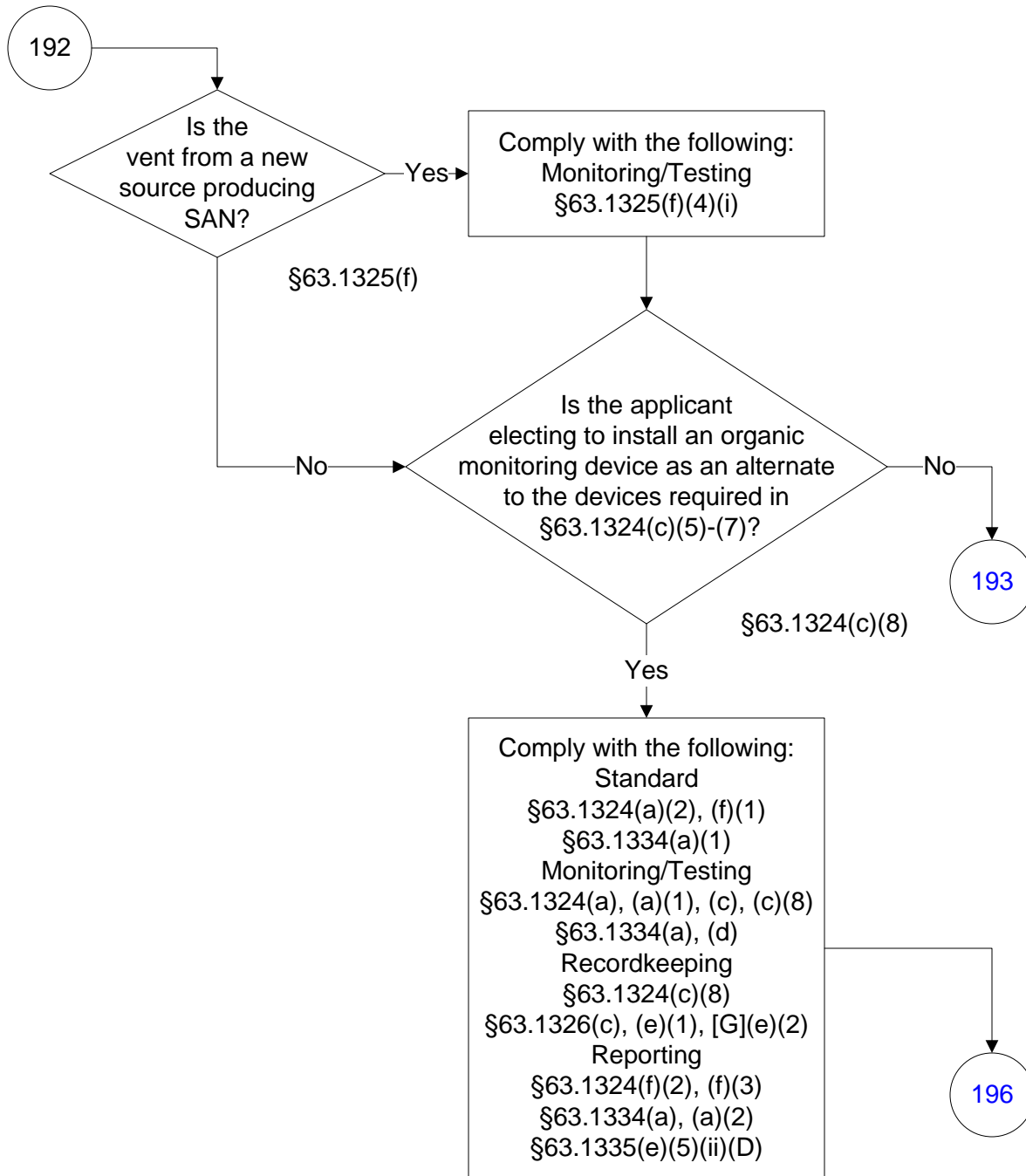

40 CFR Part 63, Subpart JJJ

(76 of 196)

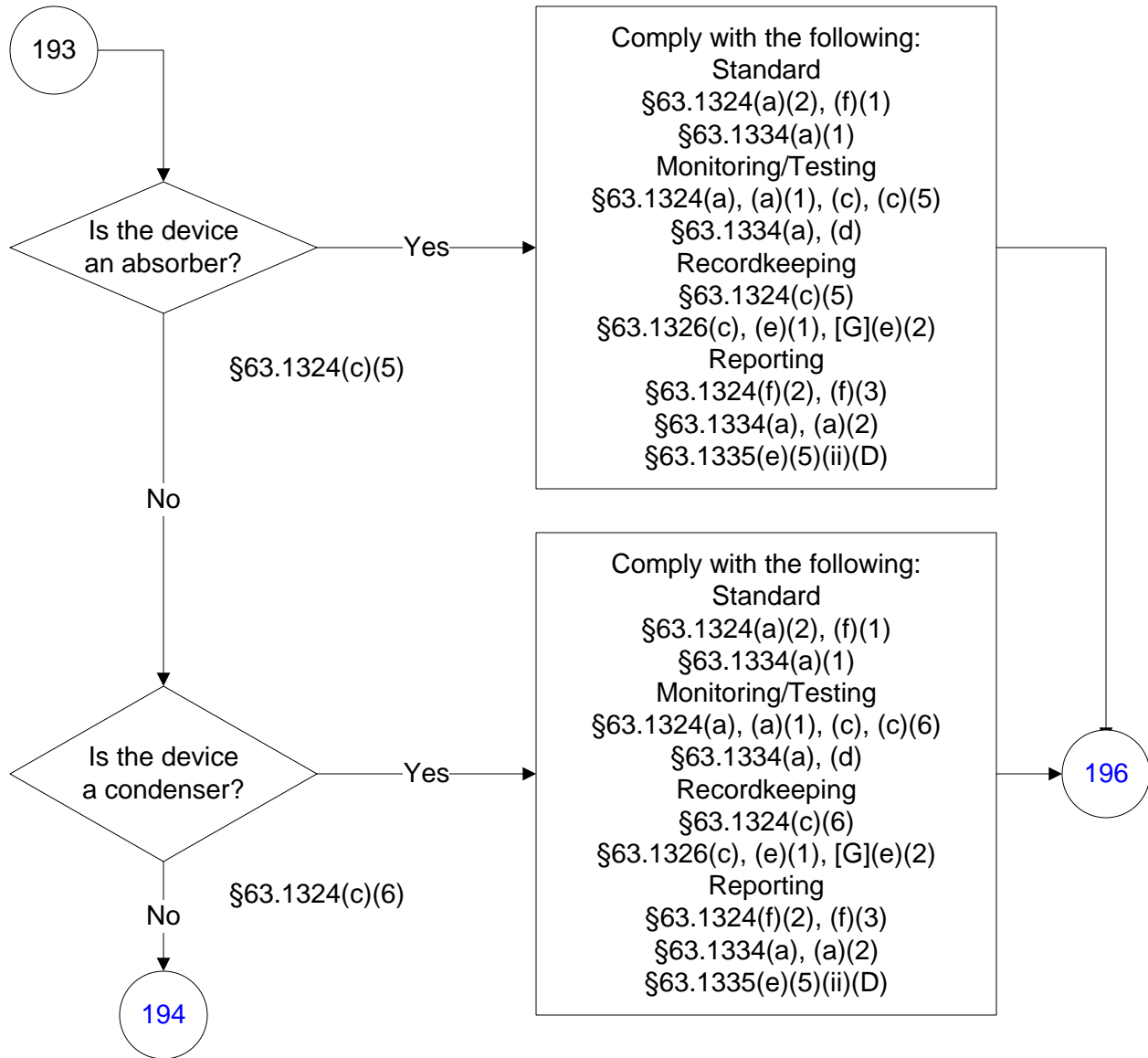

40 CFR Part 63, Subpart JJJ

(77 of 196)

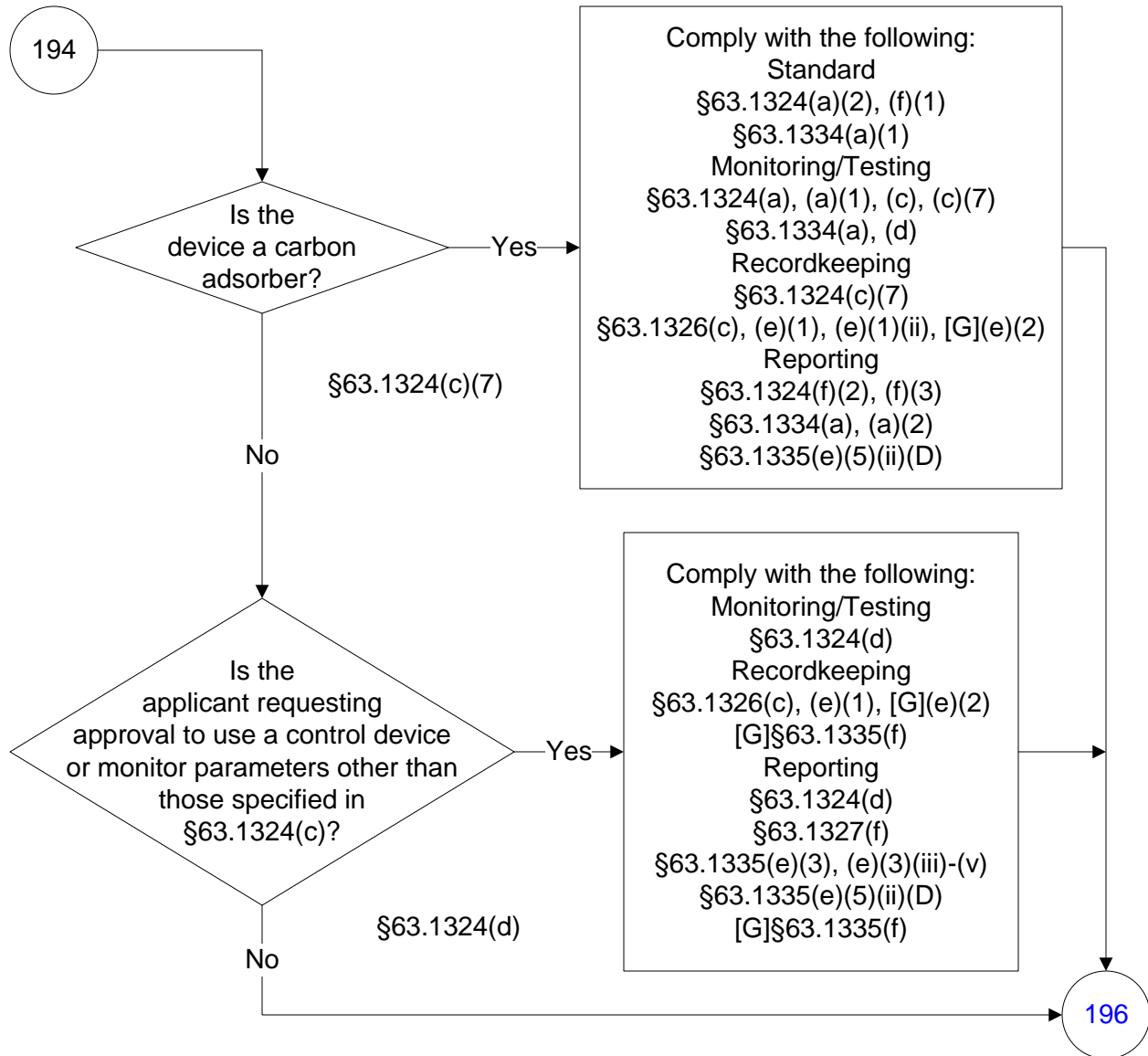

40 CFR Part 63, Subpart JJJ

(78 of 196)

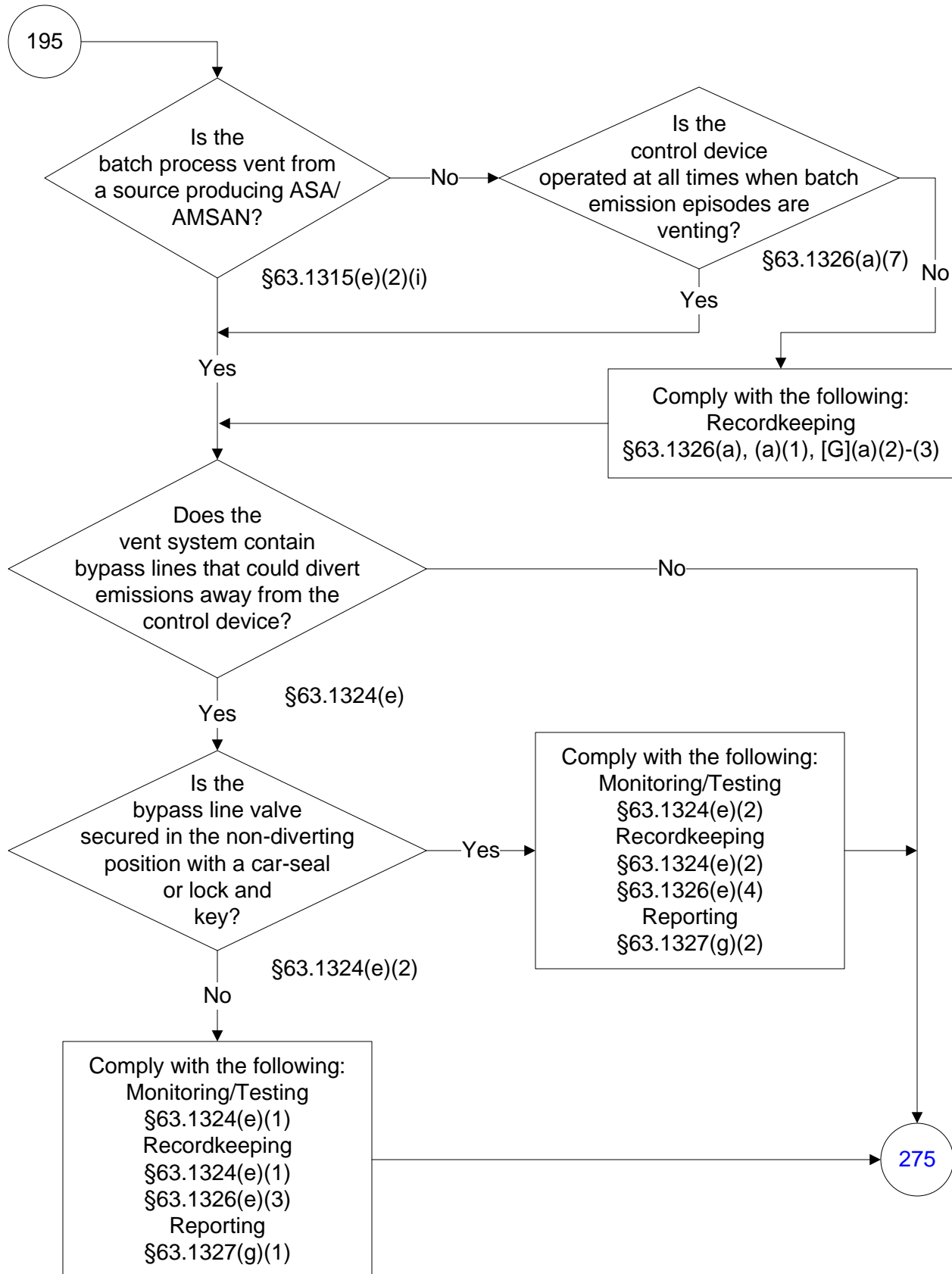

40 CFR Part 63, Subpart JJJ

(79 of 196)

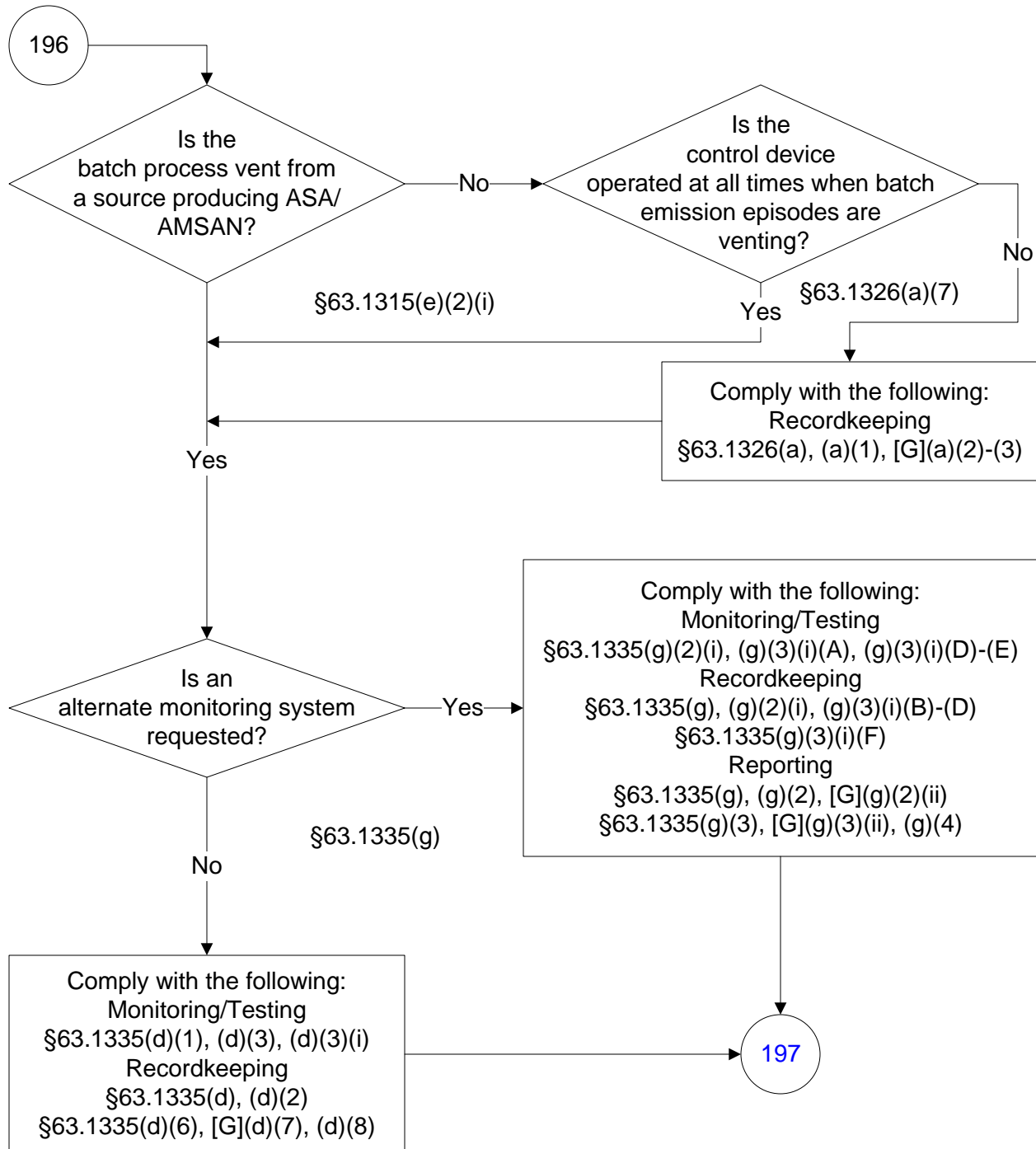

40 CFR Part 63, Subpart JJJ

(80 of 196)

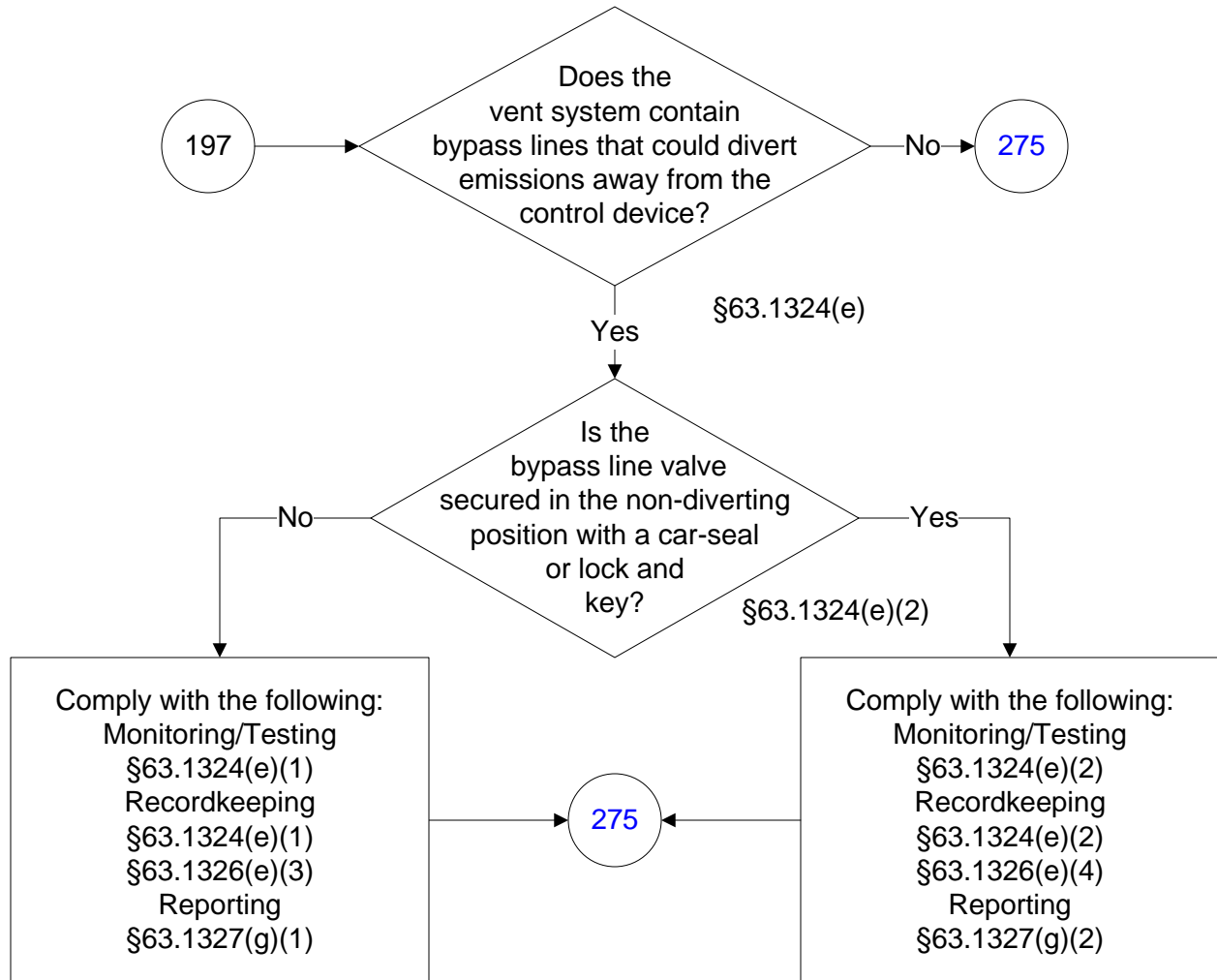

40 CFR Part 63, Subpart JJJ

(81 of 196)

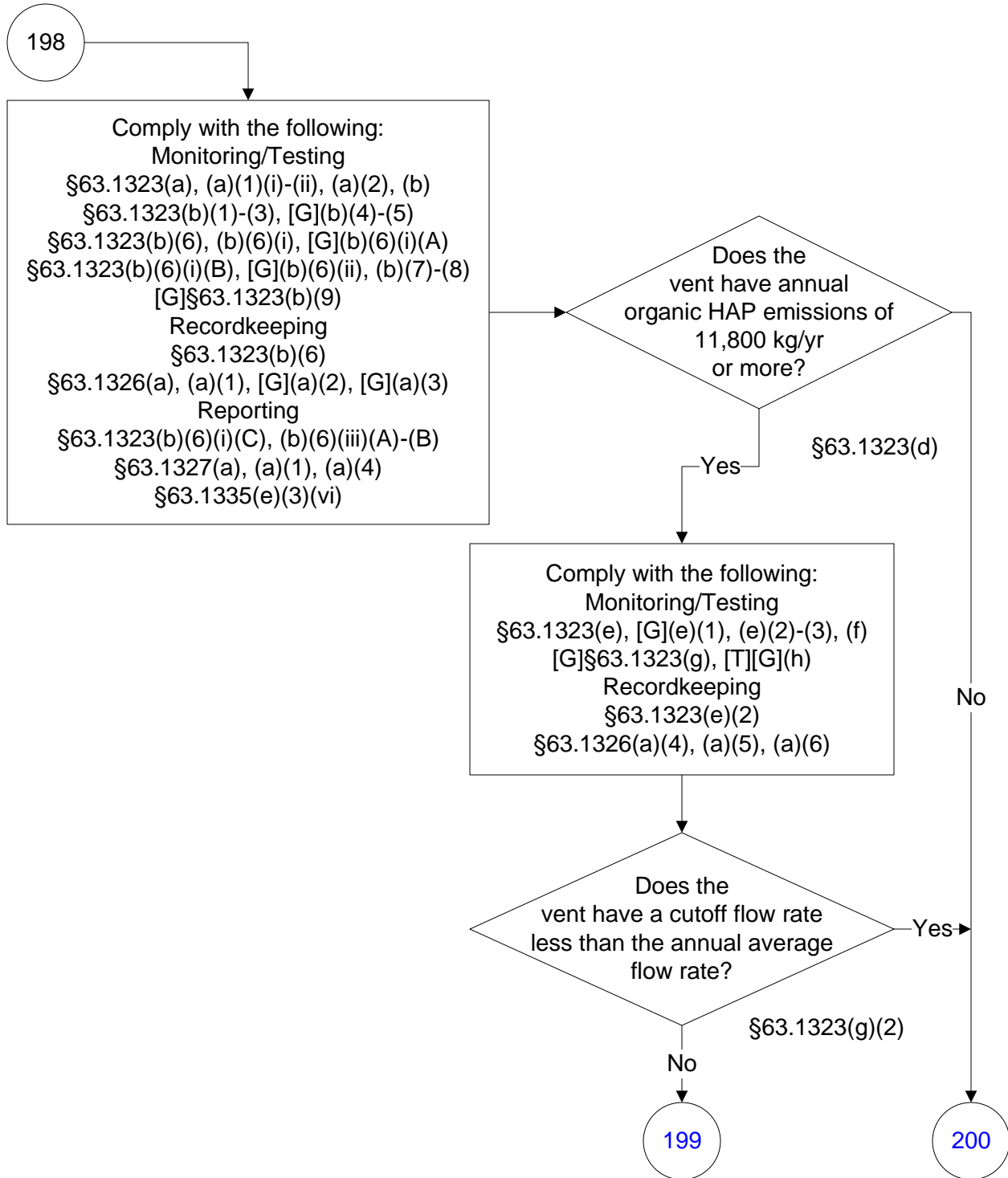

40 CFR Part 63, Subpart JJJ

(82 of 196)

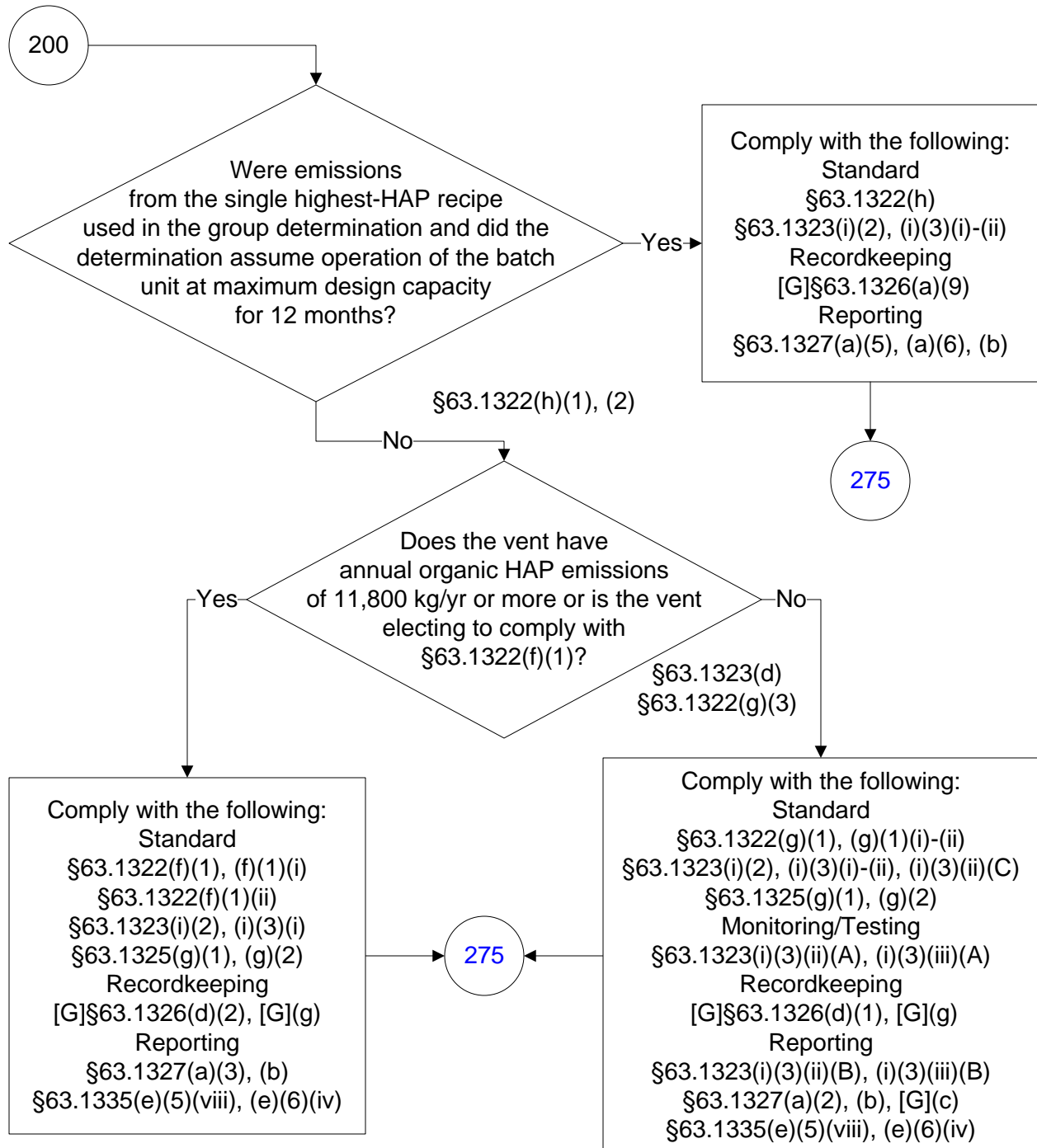

40 CFR Part 63, Subpart JJJ

(83 of 196)

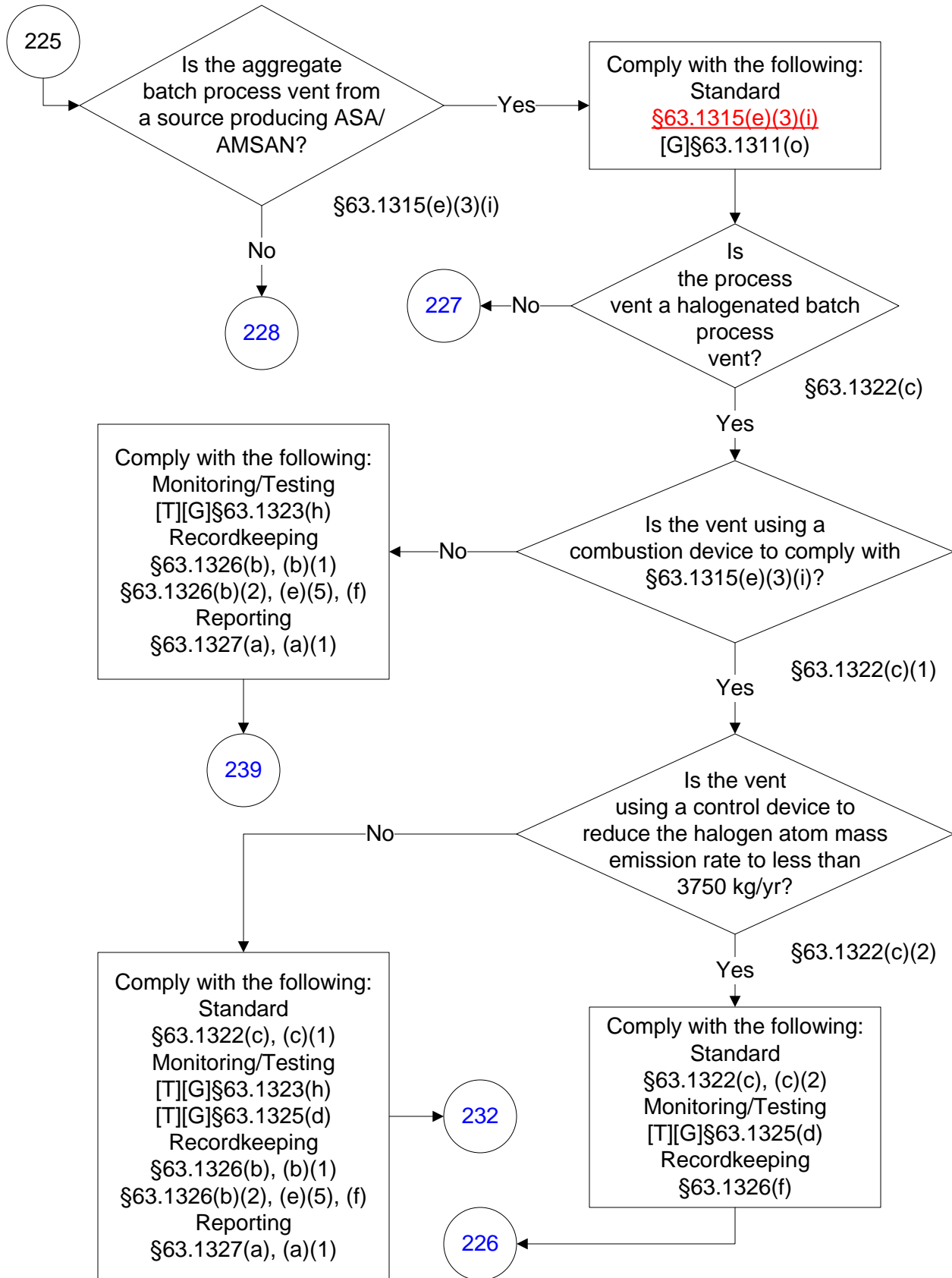

40 CFR Part 63, Subpart JJJ

(84 of 196)

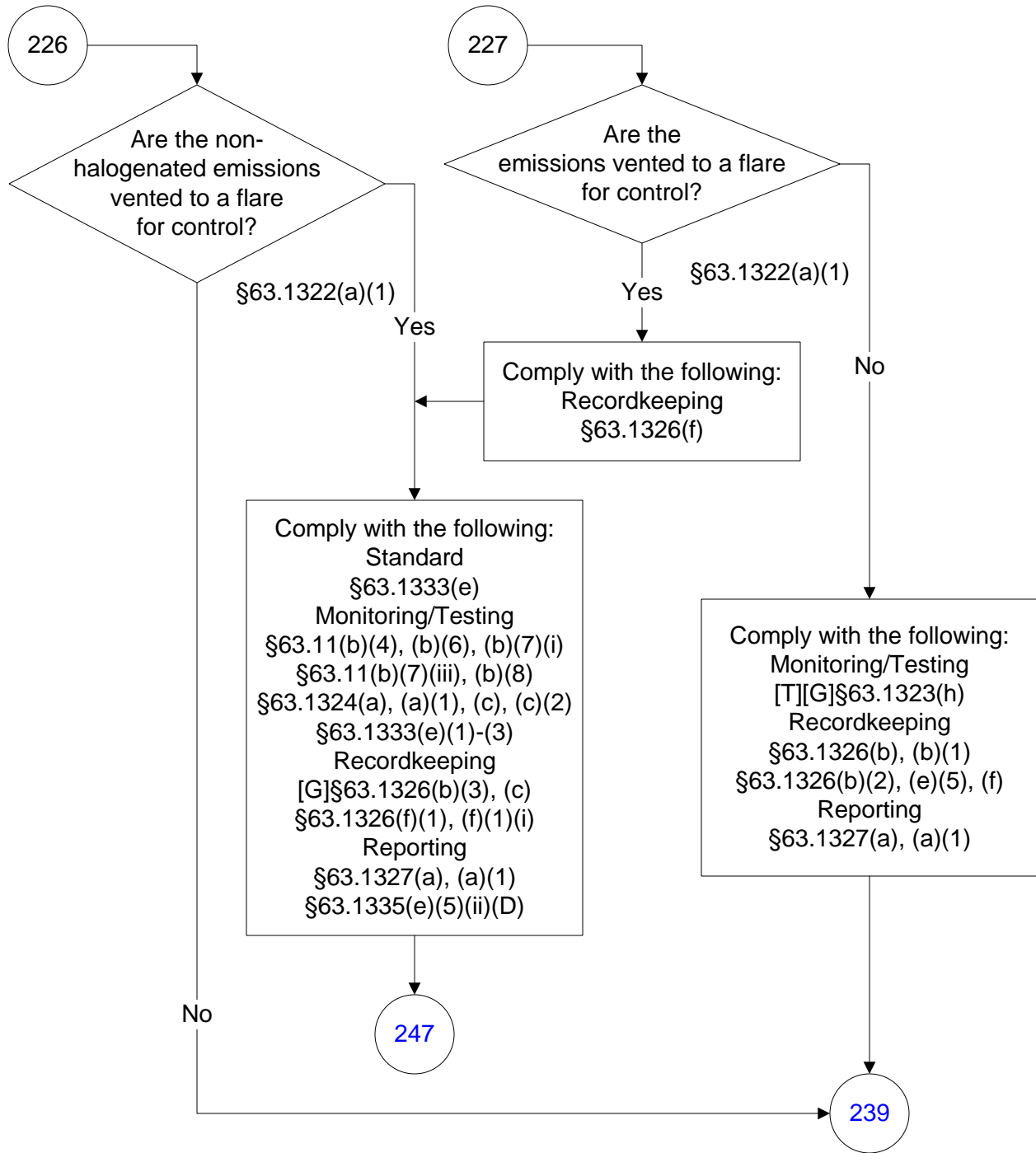

40 CFR Part 63, Subpart JJJ

(85 of 196)

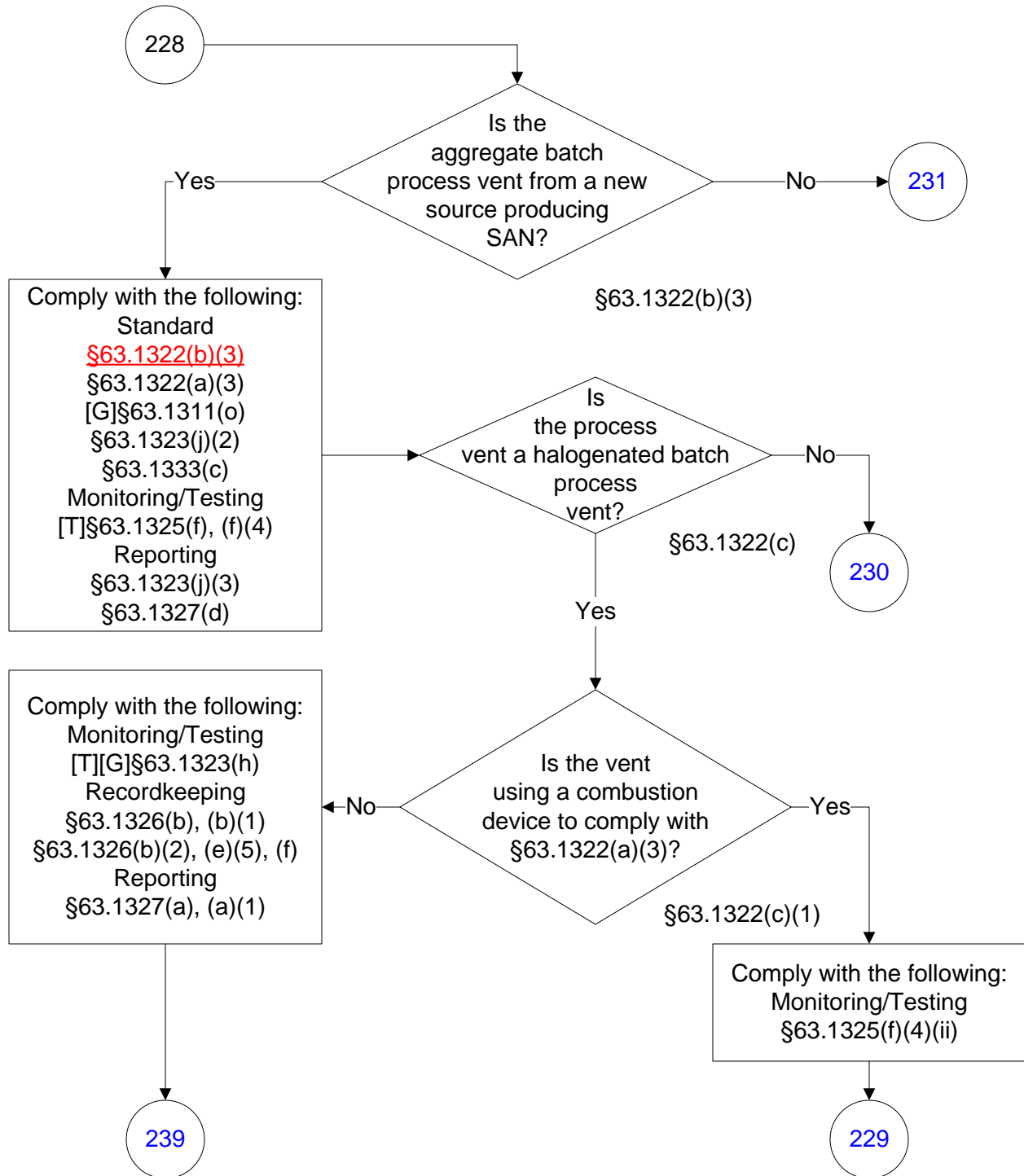

40 CFR Part 63, Subpart JJJ

(86 of 196)

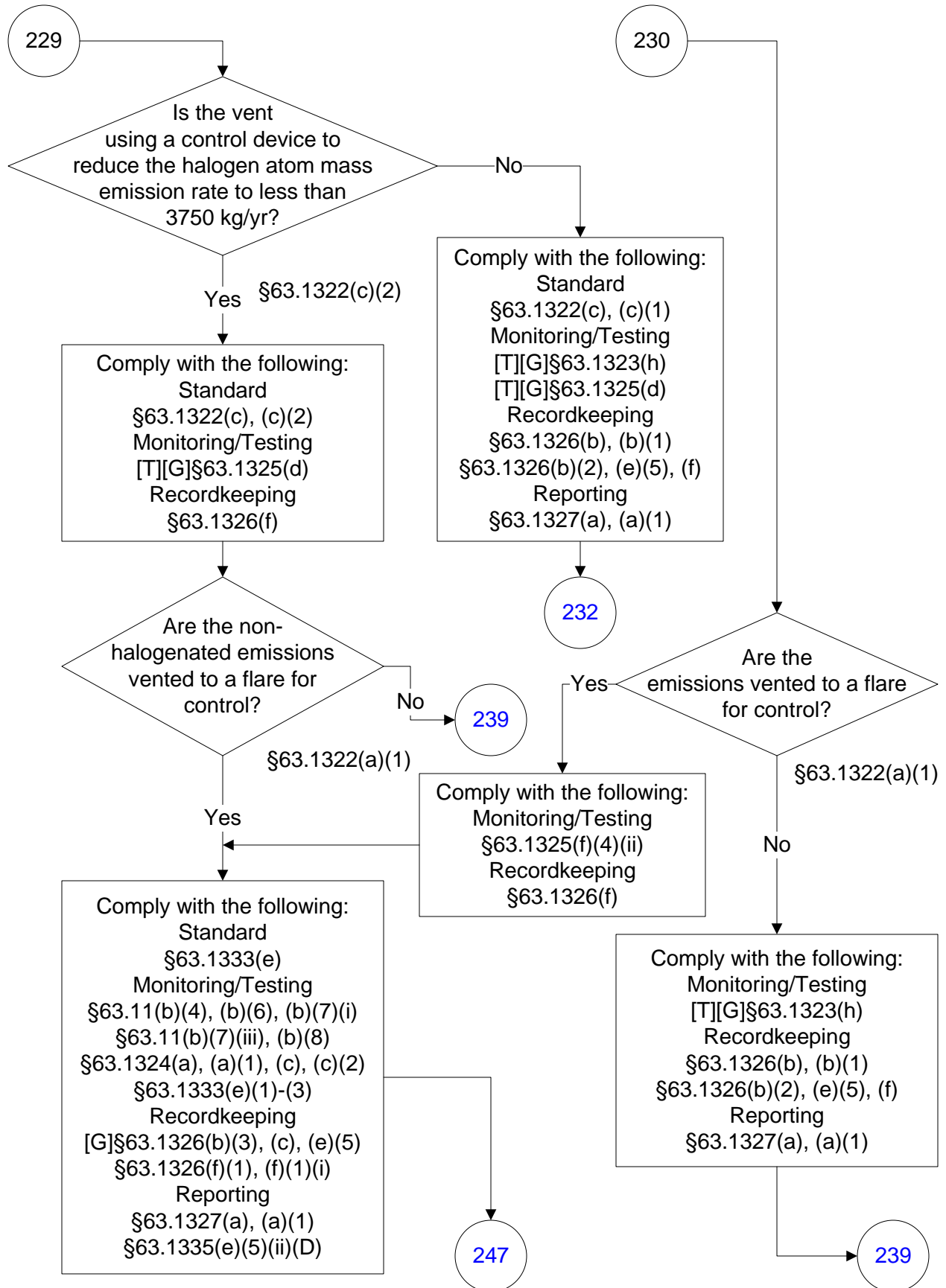

40 CFR Part 63, Subpart JJJ

(87 of 196)

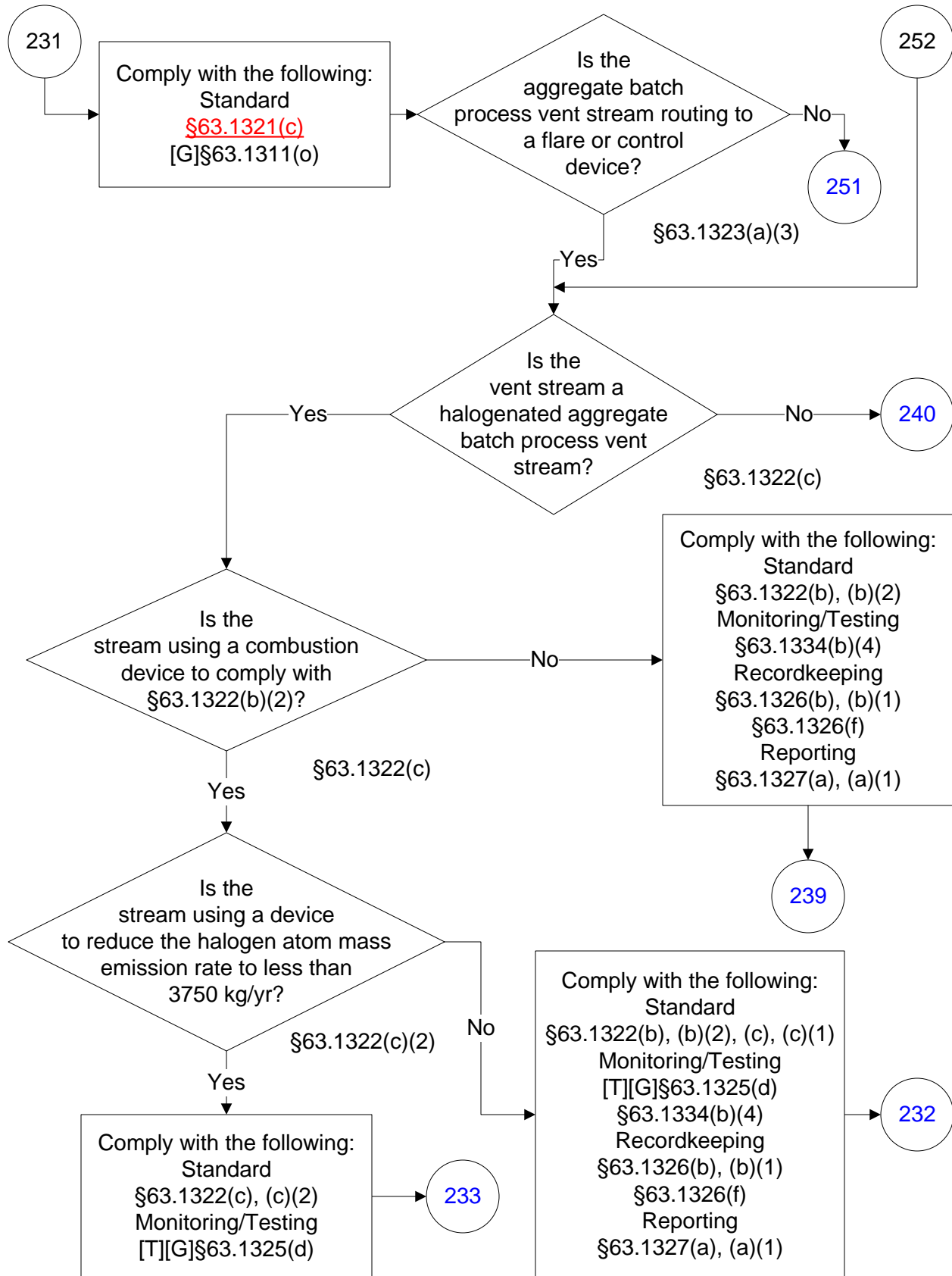

40 CFR Part 63, Subpart JJJ

(88 of 196)

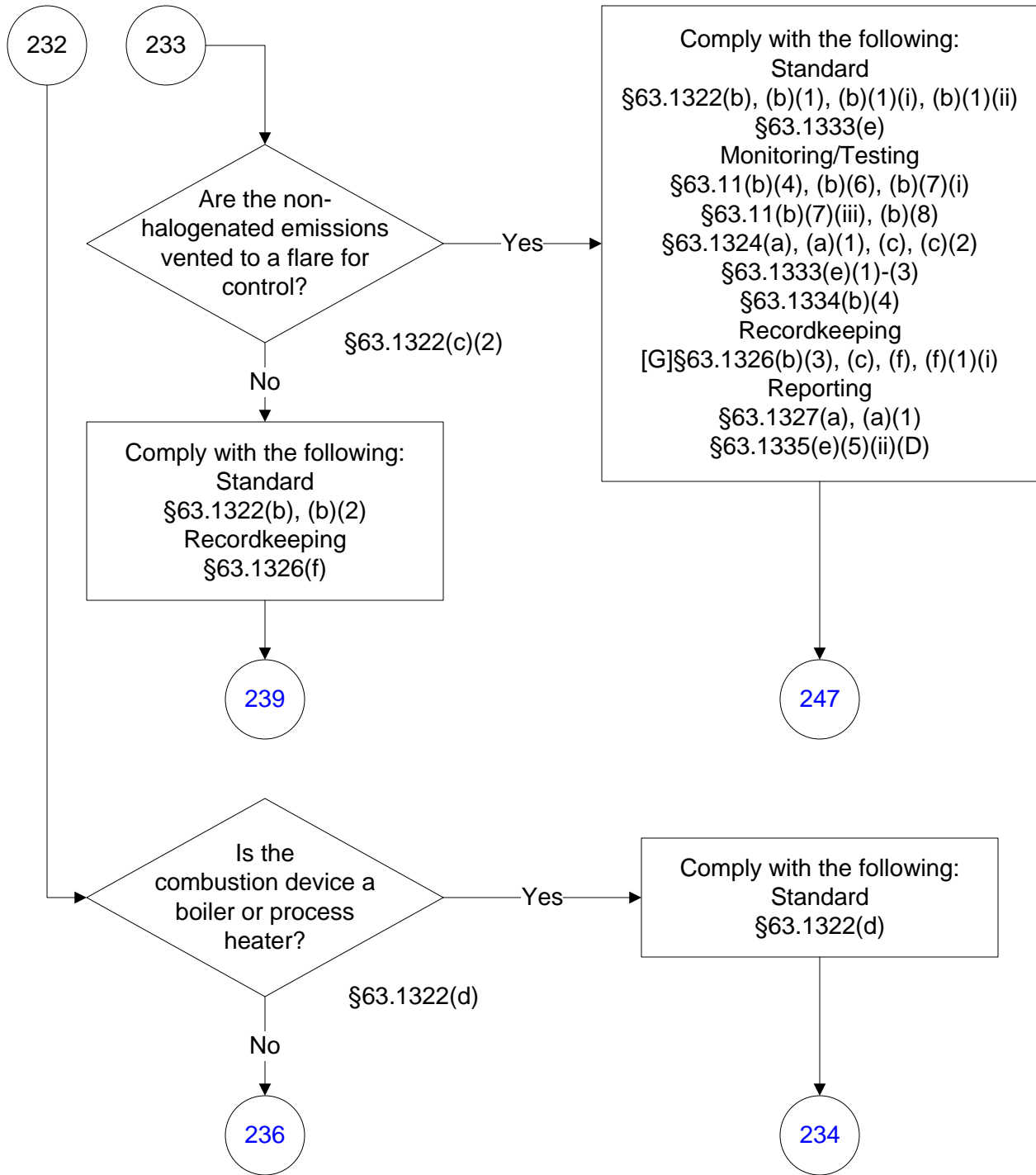

40 CFR Part 63, Subpart JJJ

(89 of 196)

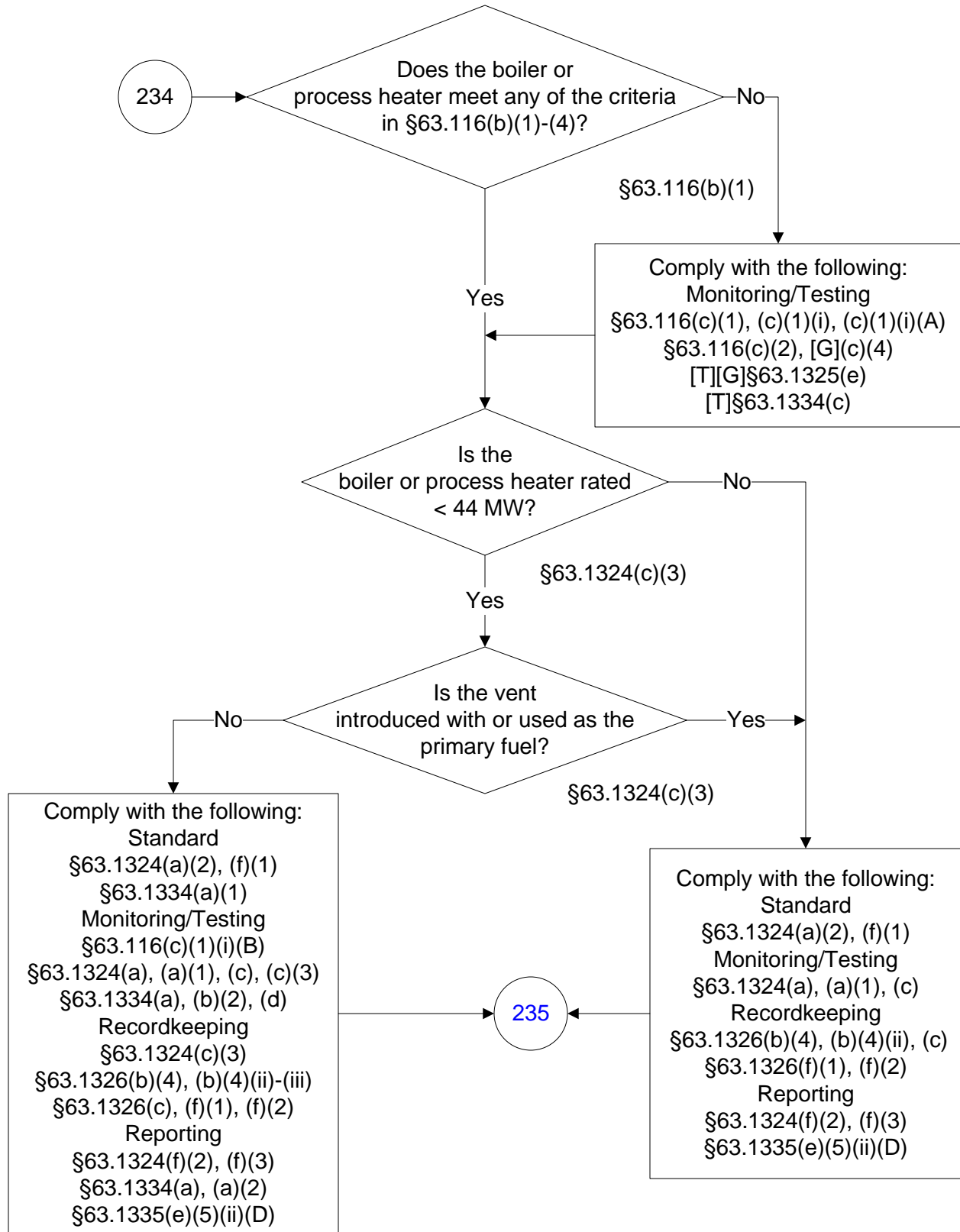

40 CFR Part 63, Subpart JJJ

(90 of 196)

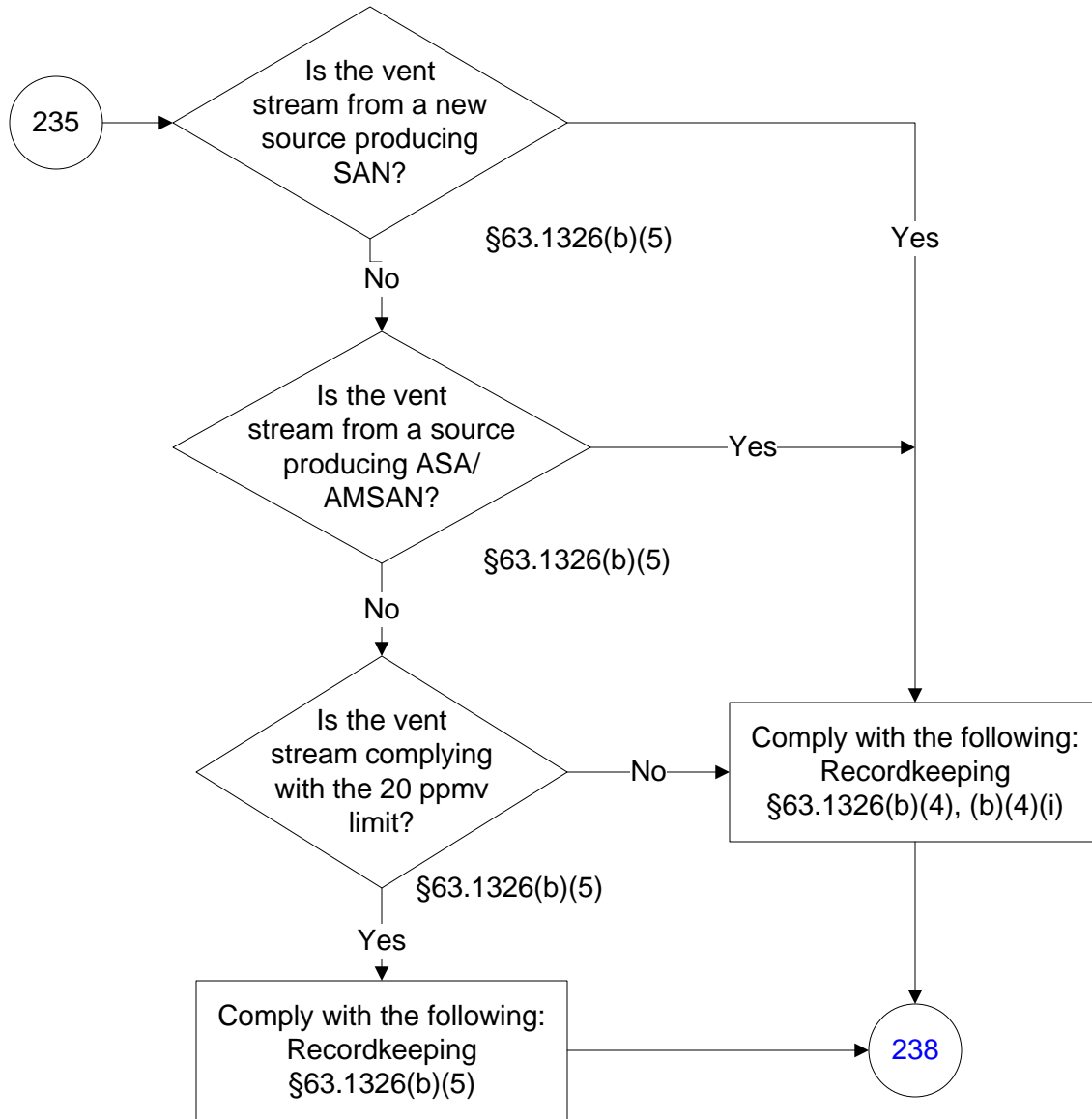

40 CFR Part 63, Subpart JJJ

(91 of 196)

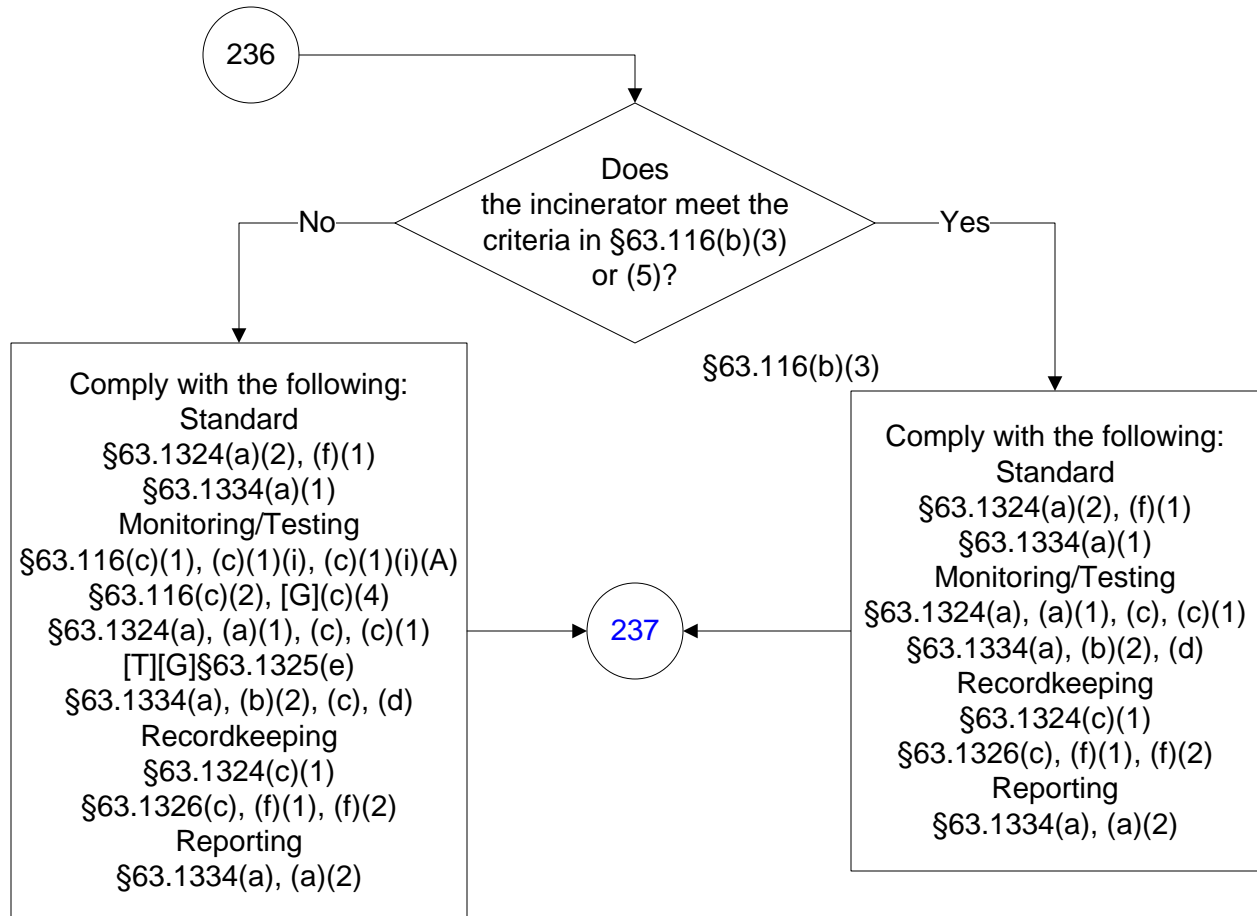

40 CFR Part 63, Subpart JJJ

(92 of 196)

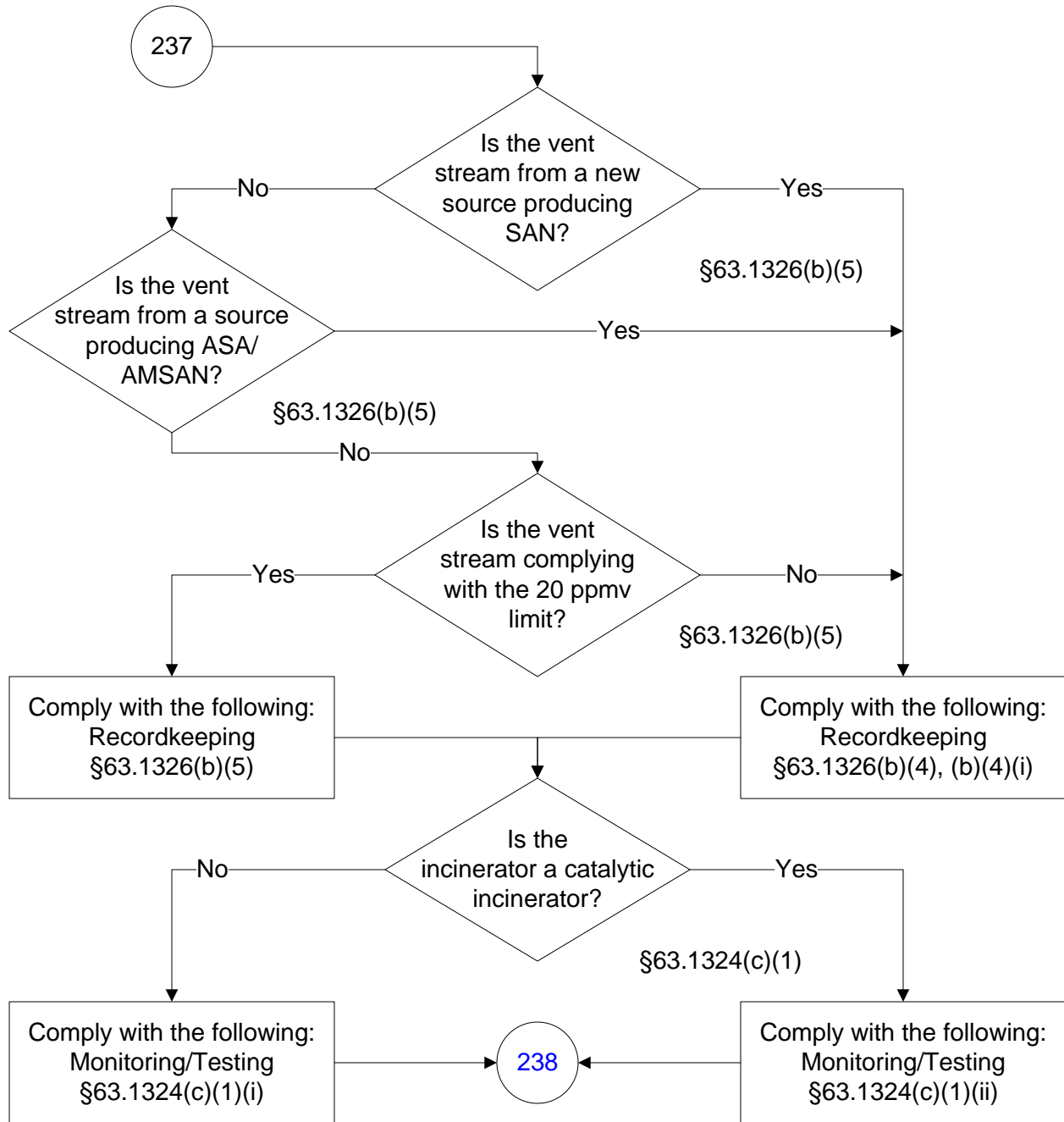

40 CFR Part 63, Subpart JJJ

(93 of 196)

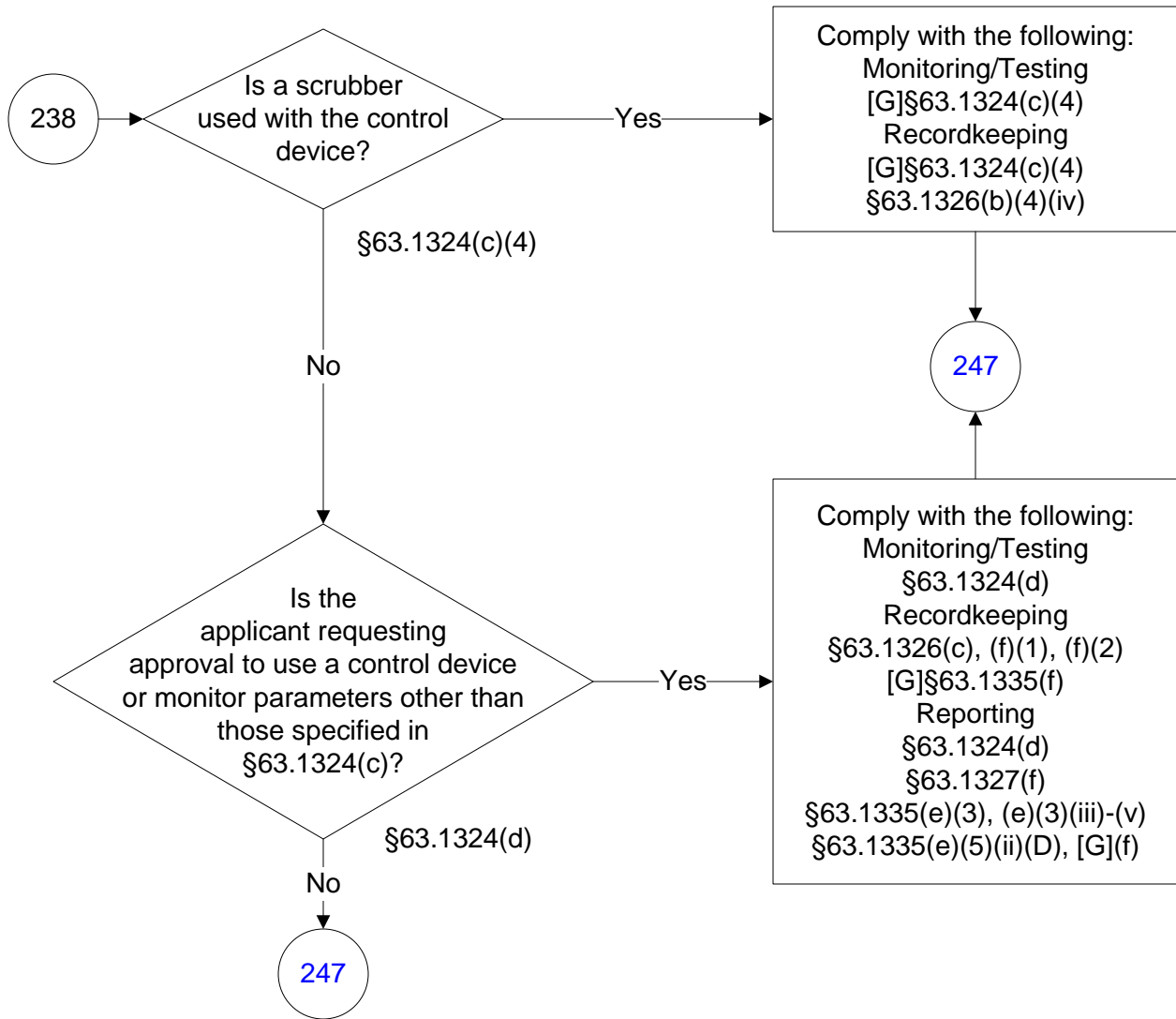

40 CFR Part 63, Subpart JJJ

(94 of 196)

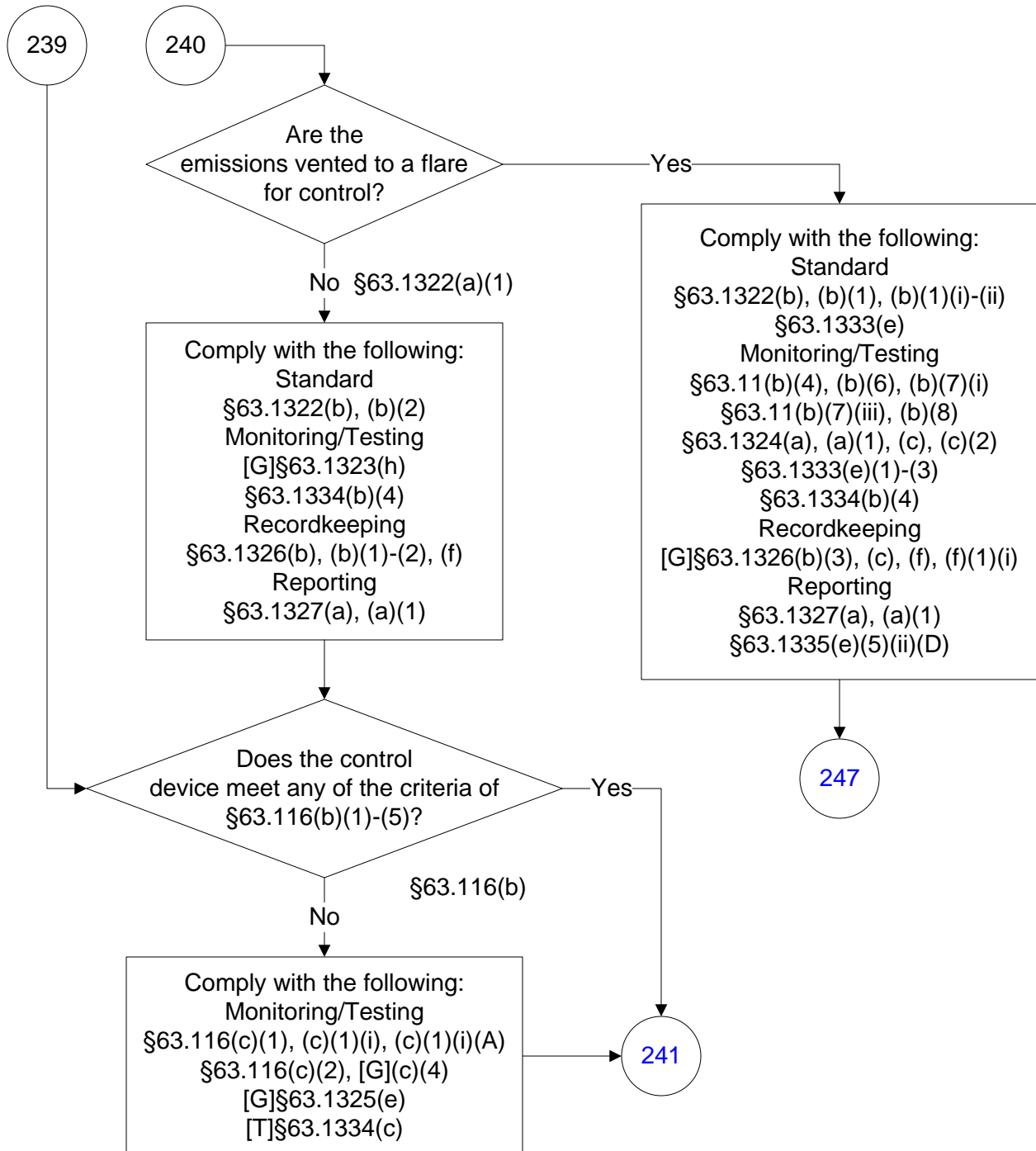

40 CFR Part 63, Subpart JJJ

(95 of 196)

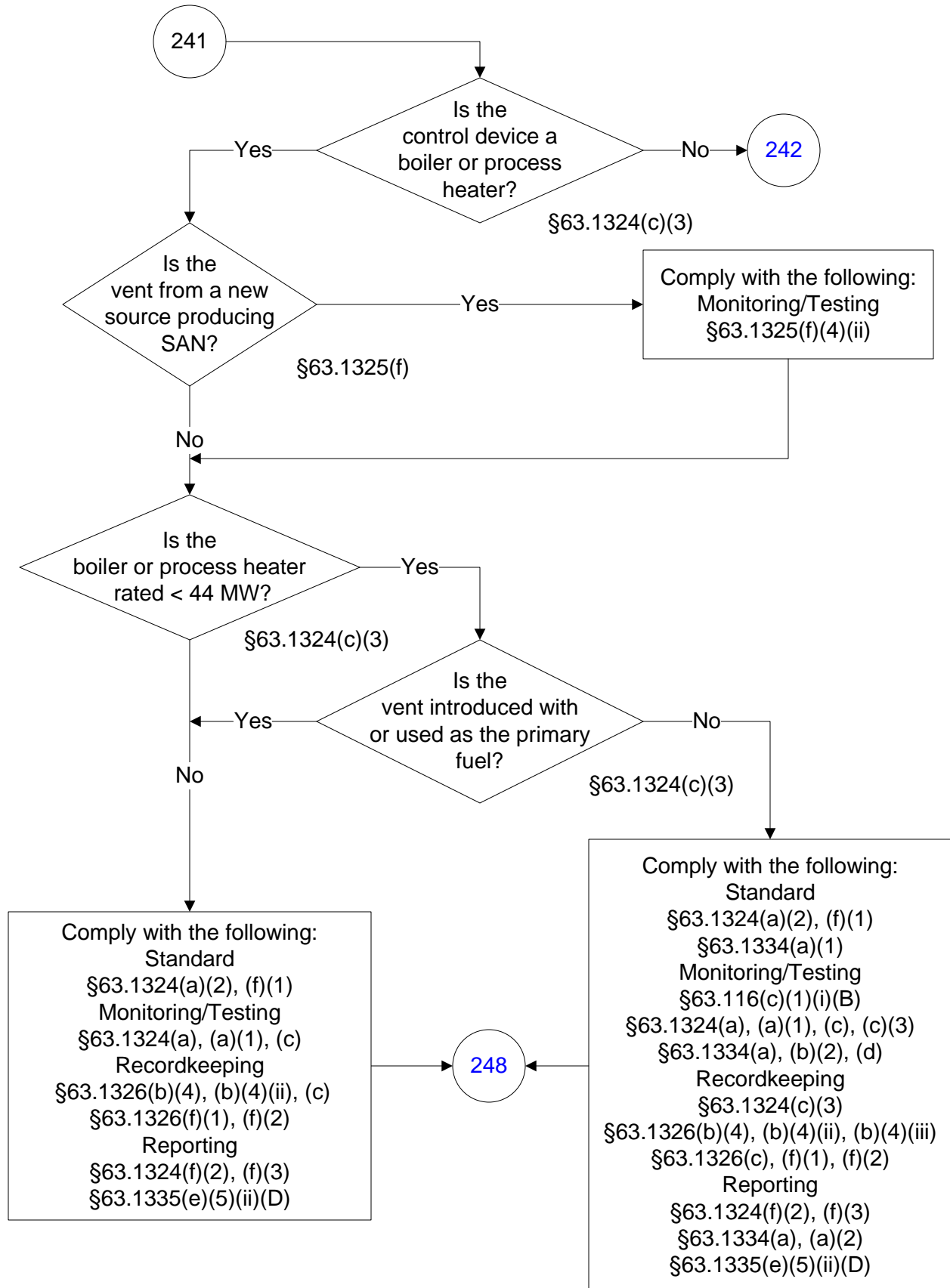

40 CFR Part 63, Subpart JJJ

(96 of 196)

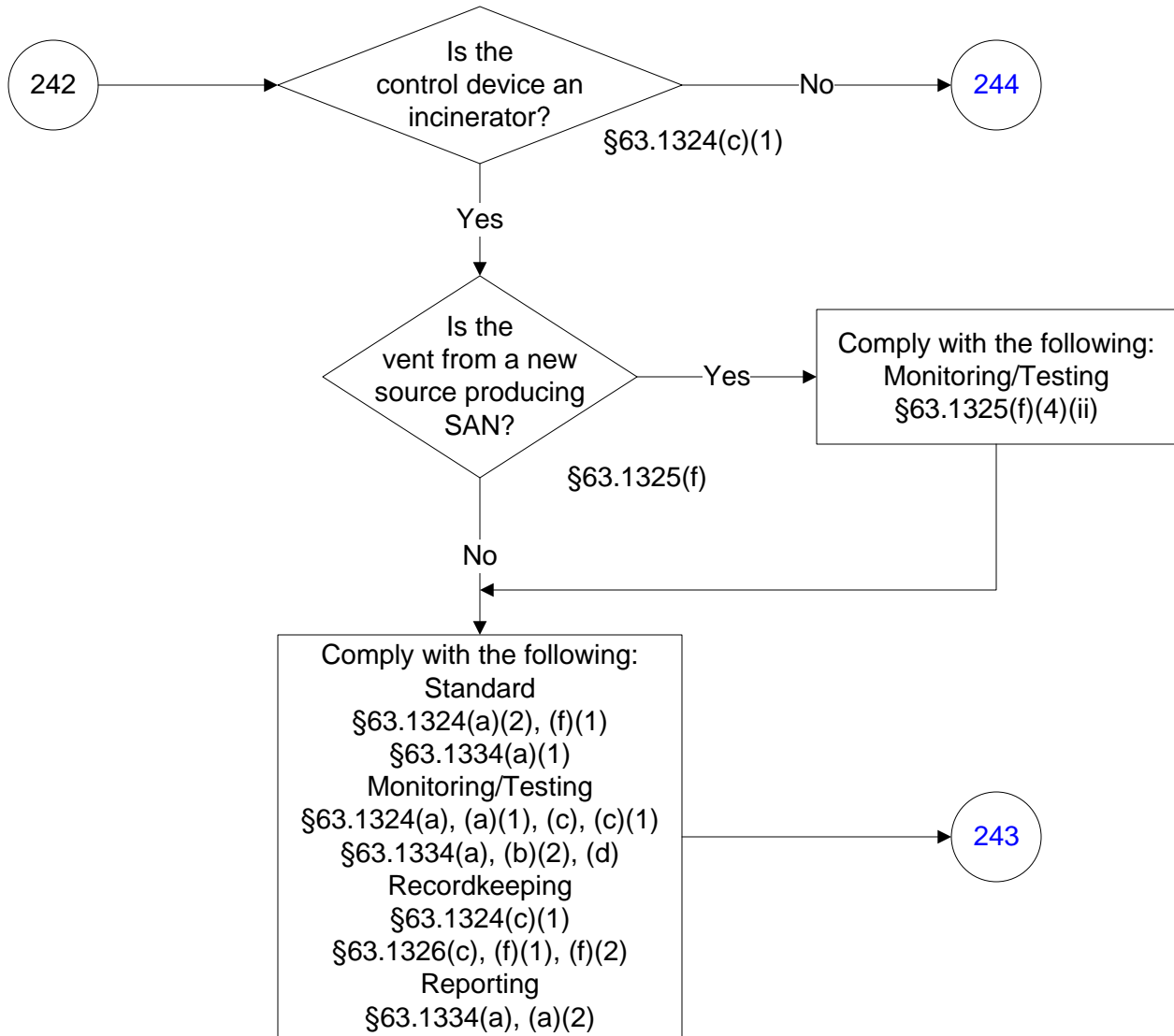

40 CFR Part 63, Subpart JJJ

(97 of 196)

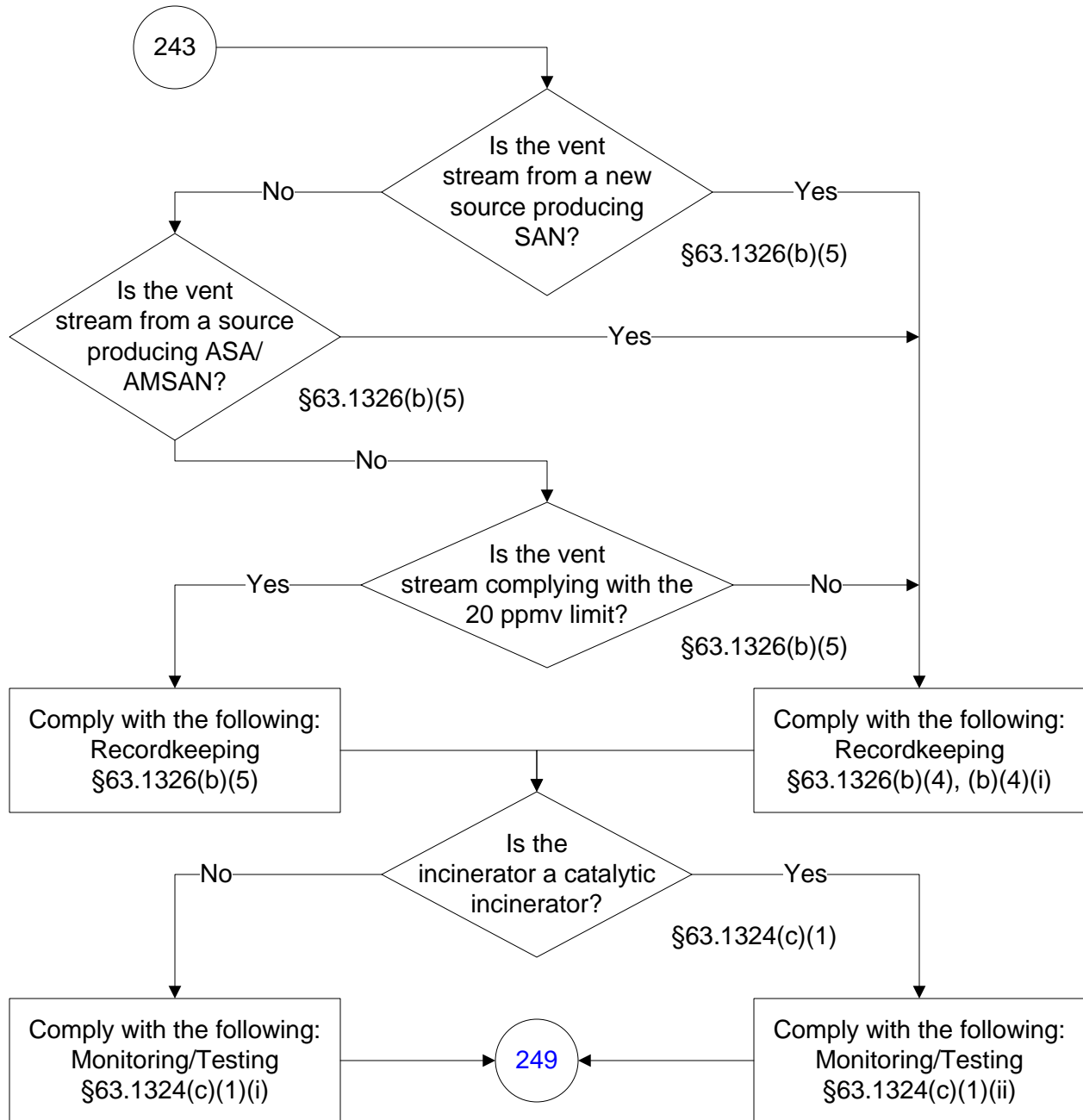

40 CFR Part 63, Subpart JJJ

(98 of 196)

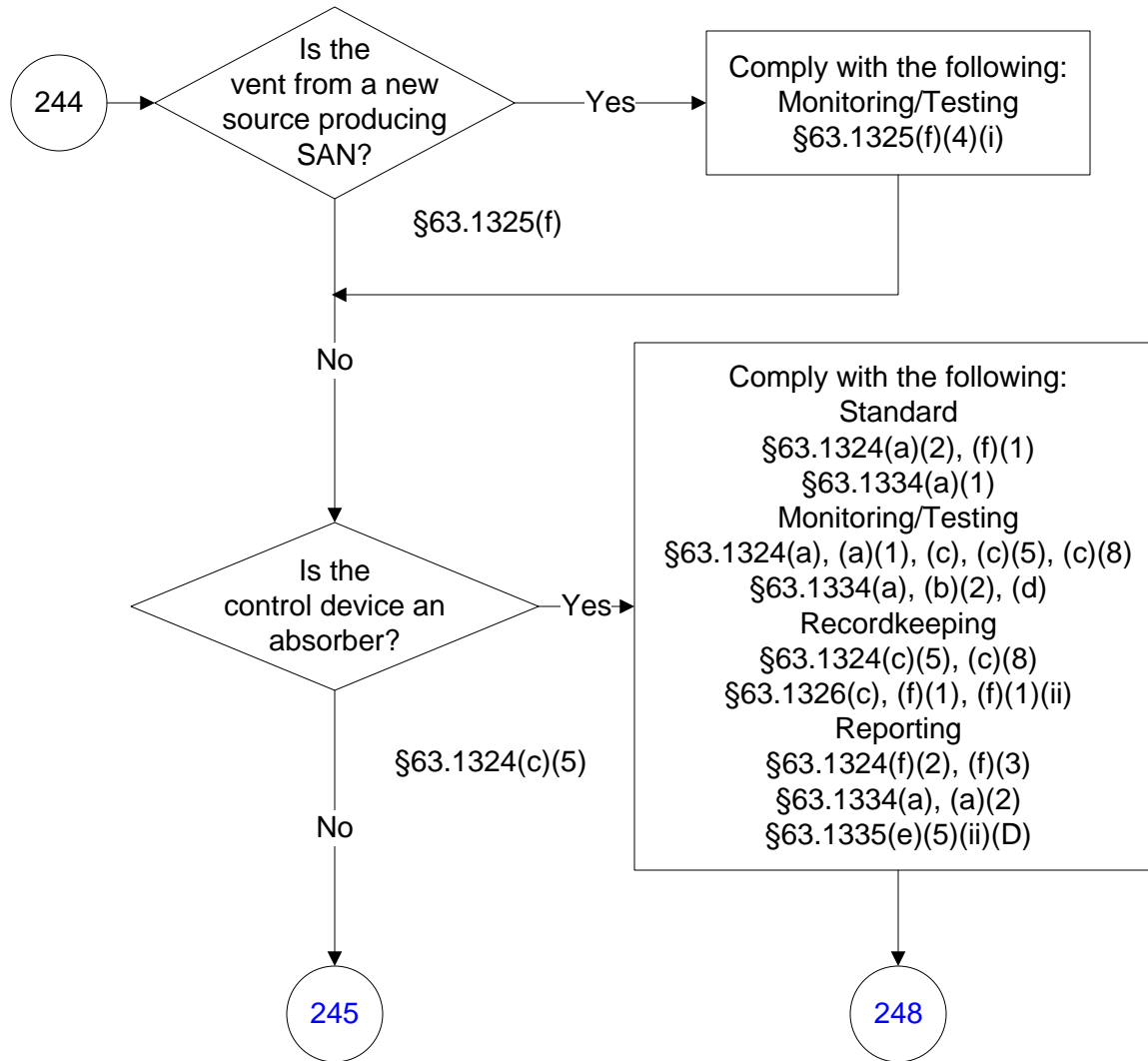

40 CFR Part 63, Subpart JJJ

(99 of 196)

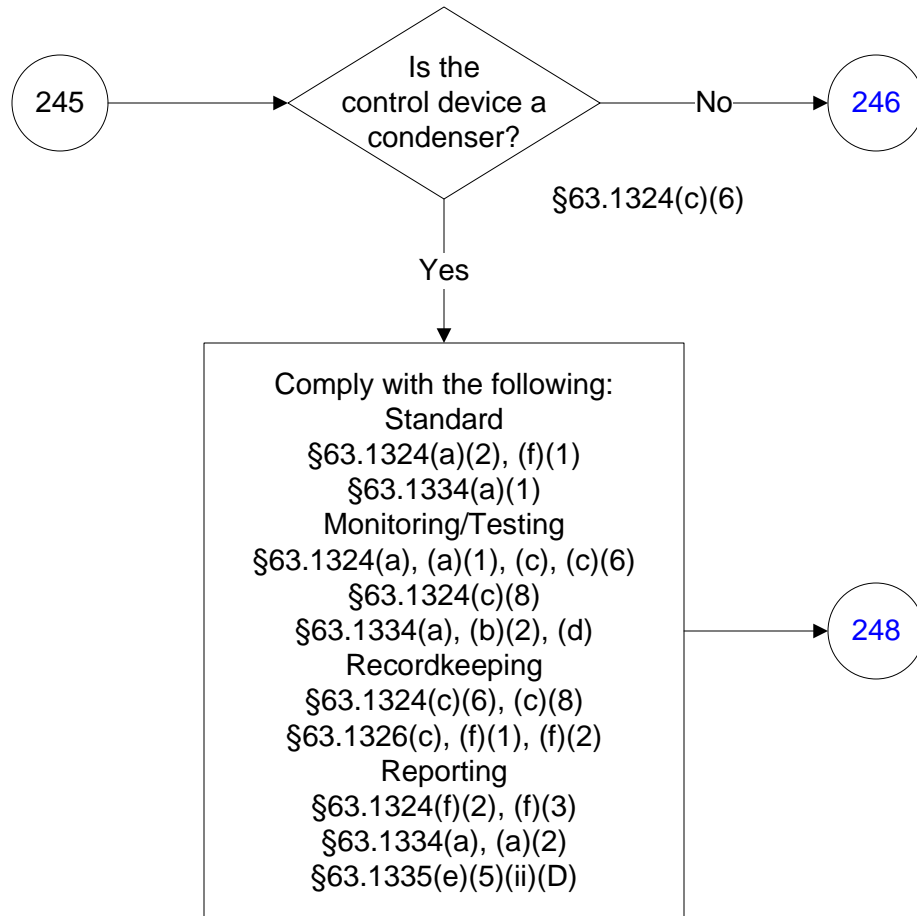

40 CFR Part 63, Subpart JJJ

(100 of 196)

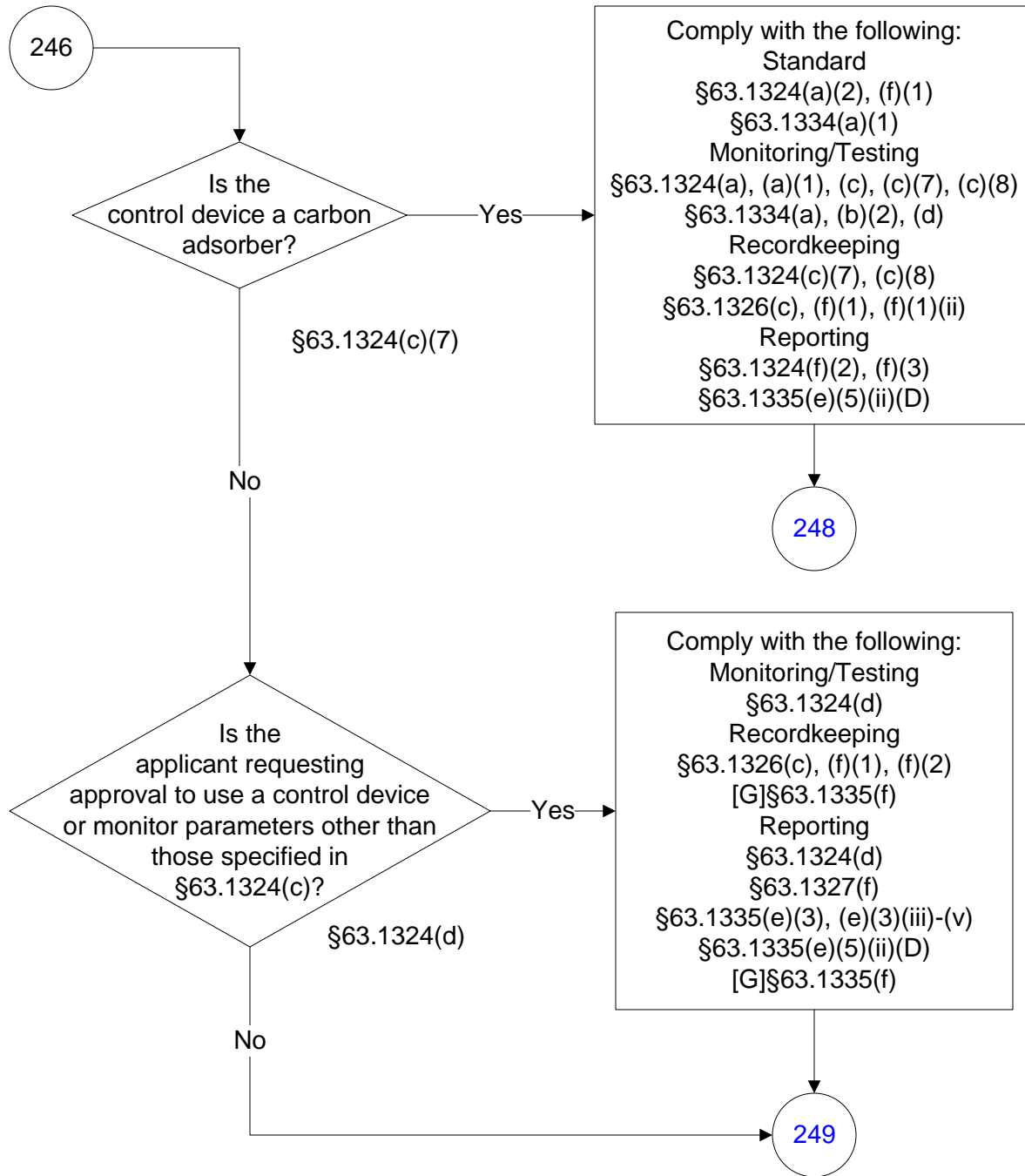

40 CFR Part 63, Subpart JJJ

(101 of 196)

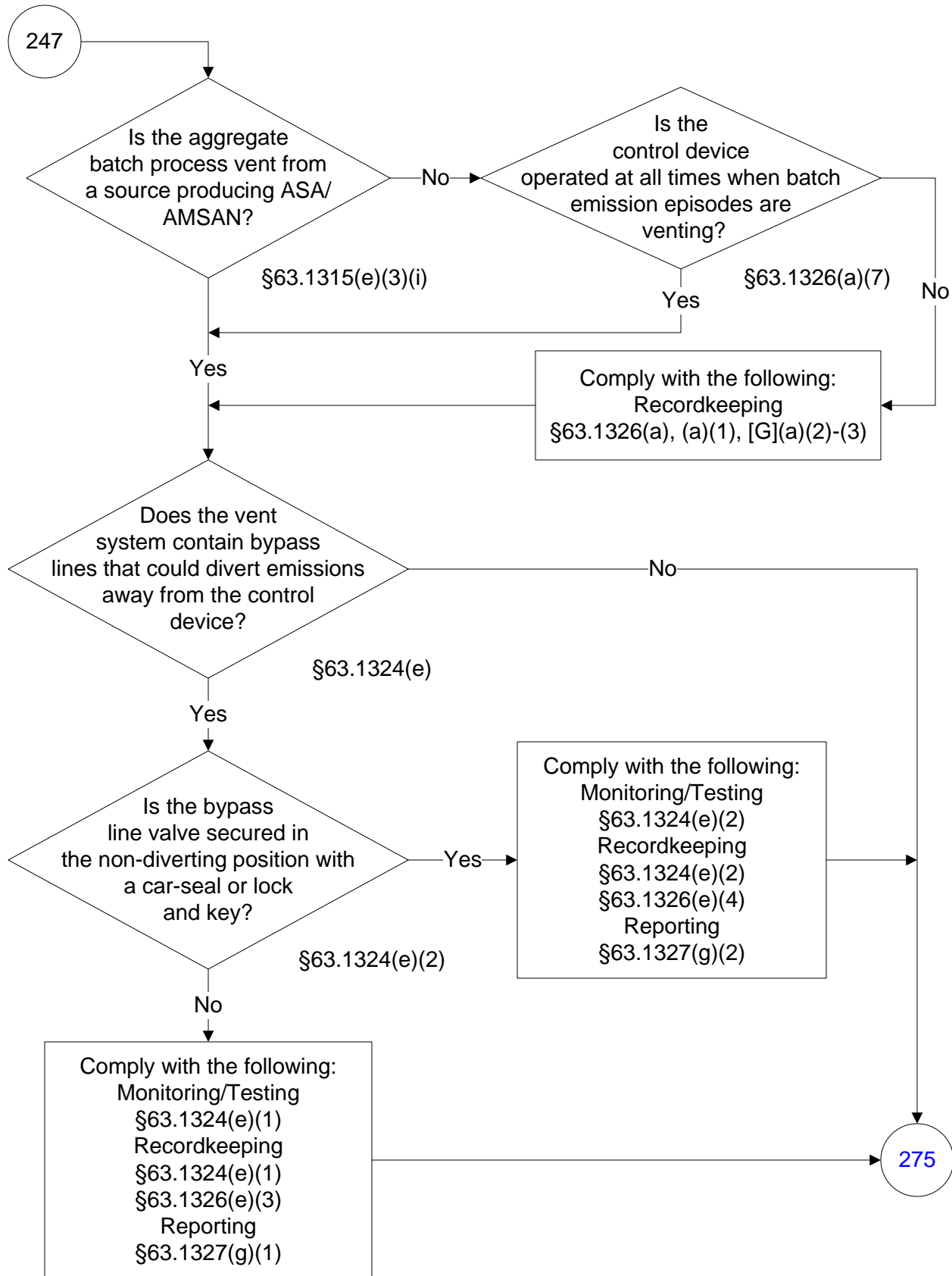

40 CFR Part 63, Subpart JJJ

(102 of 196)

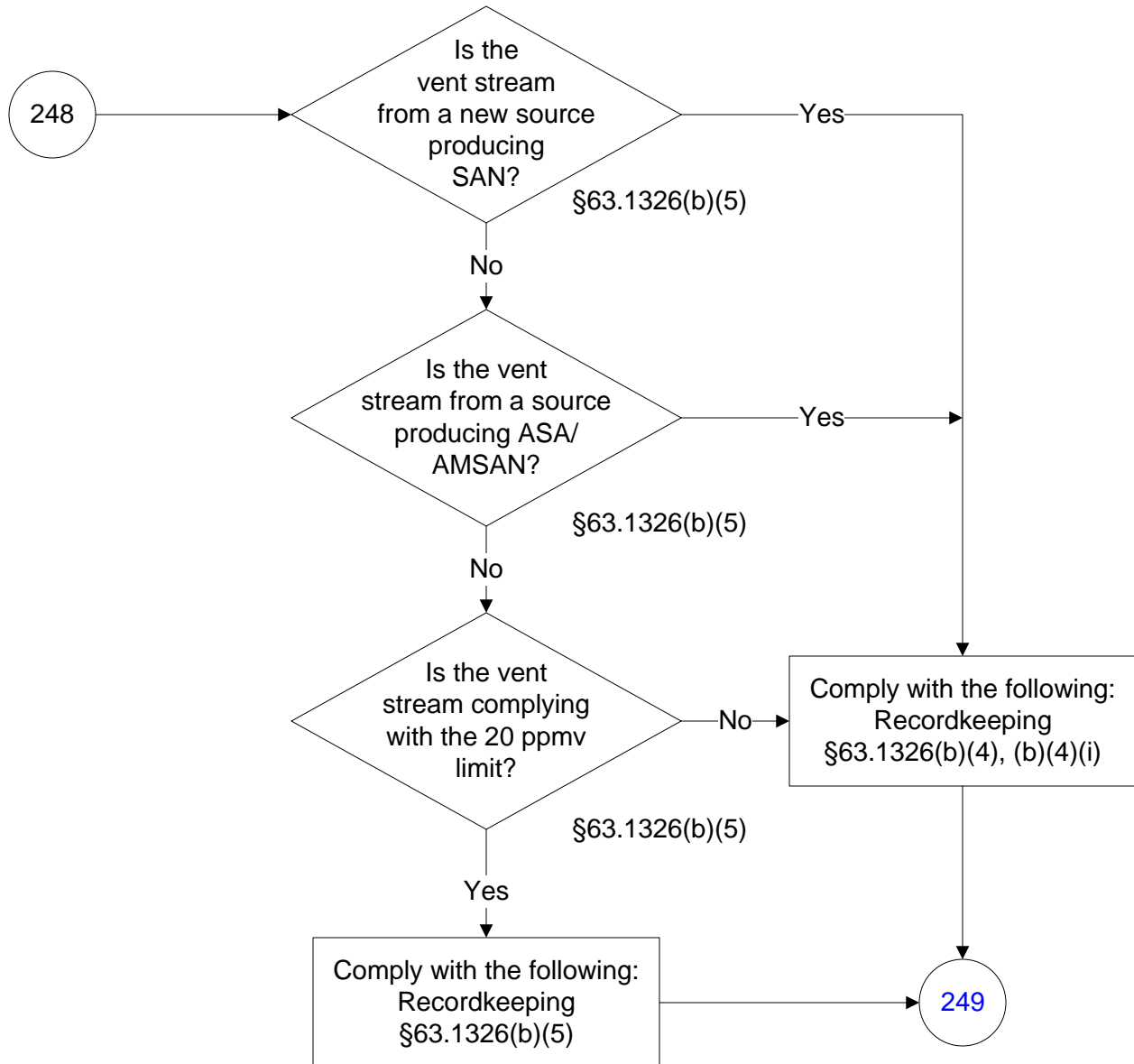

40 CFR Part 63, Subpart JJJ

(103 of 196)

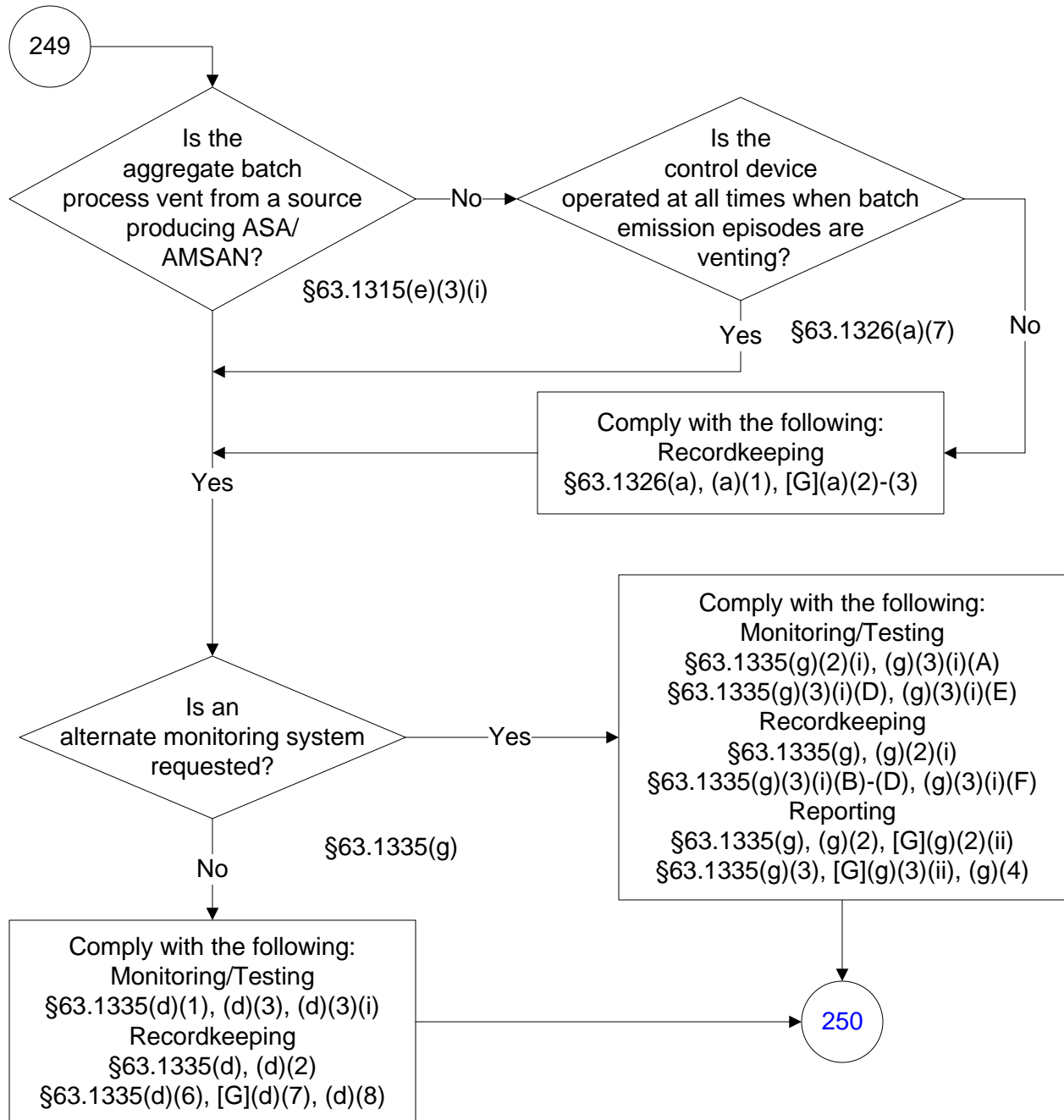

40 CFR Part 63, Subpart JJJ

(104 of 196)

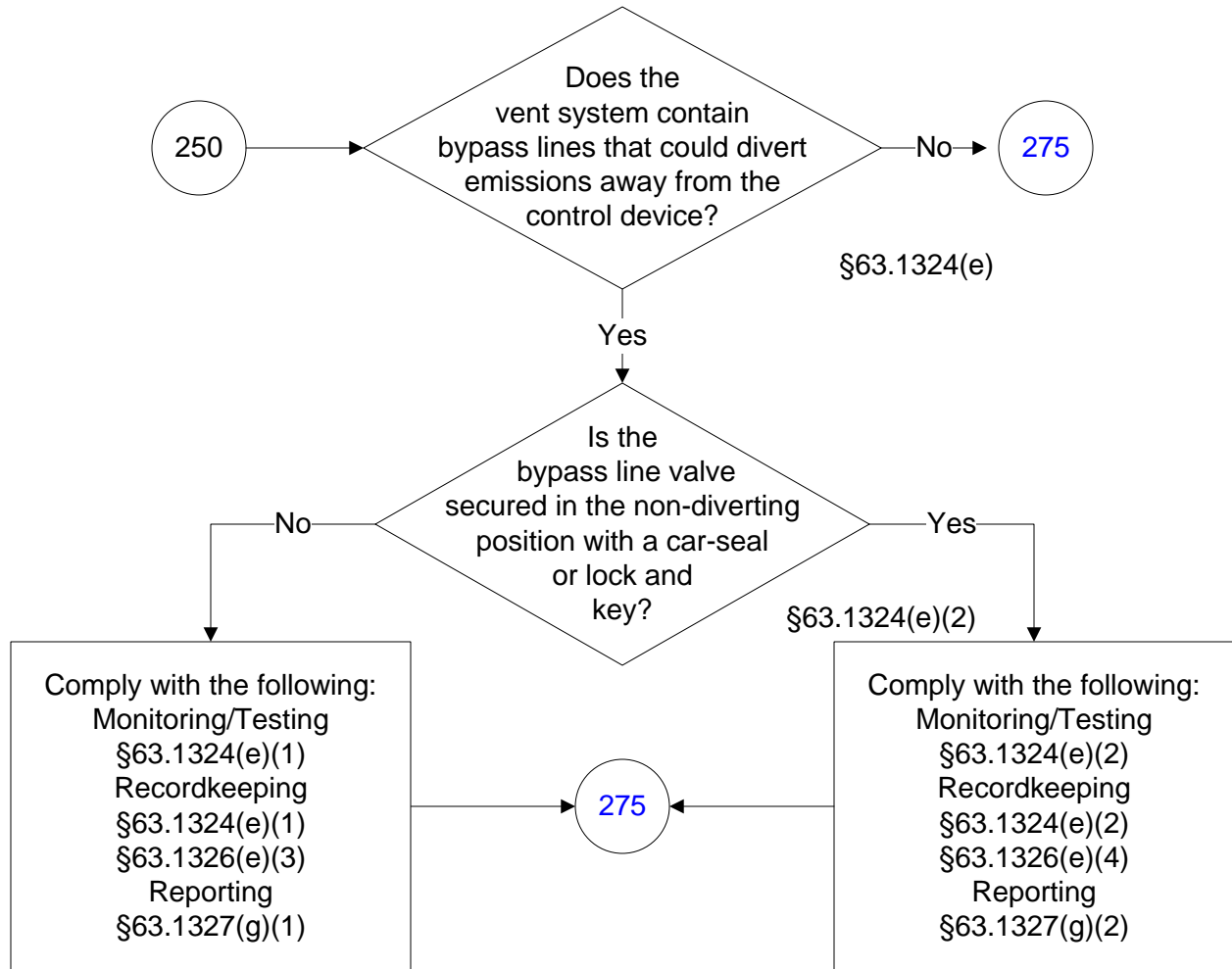

40 CFR Part 63, Subpart JJJ

(105 of 196)

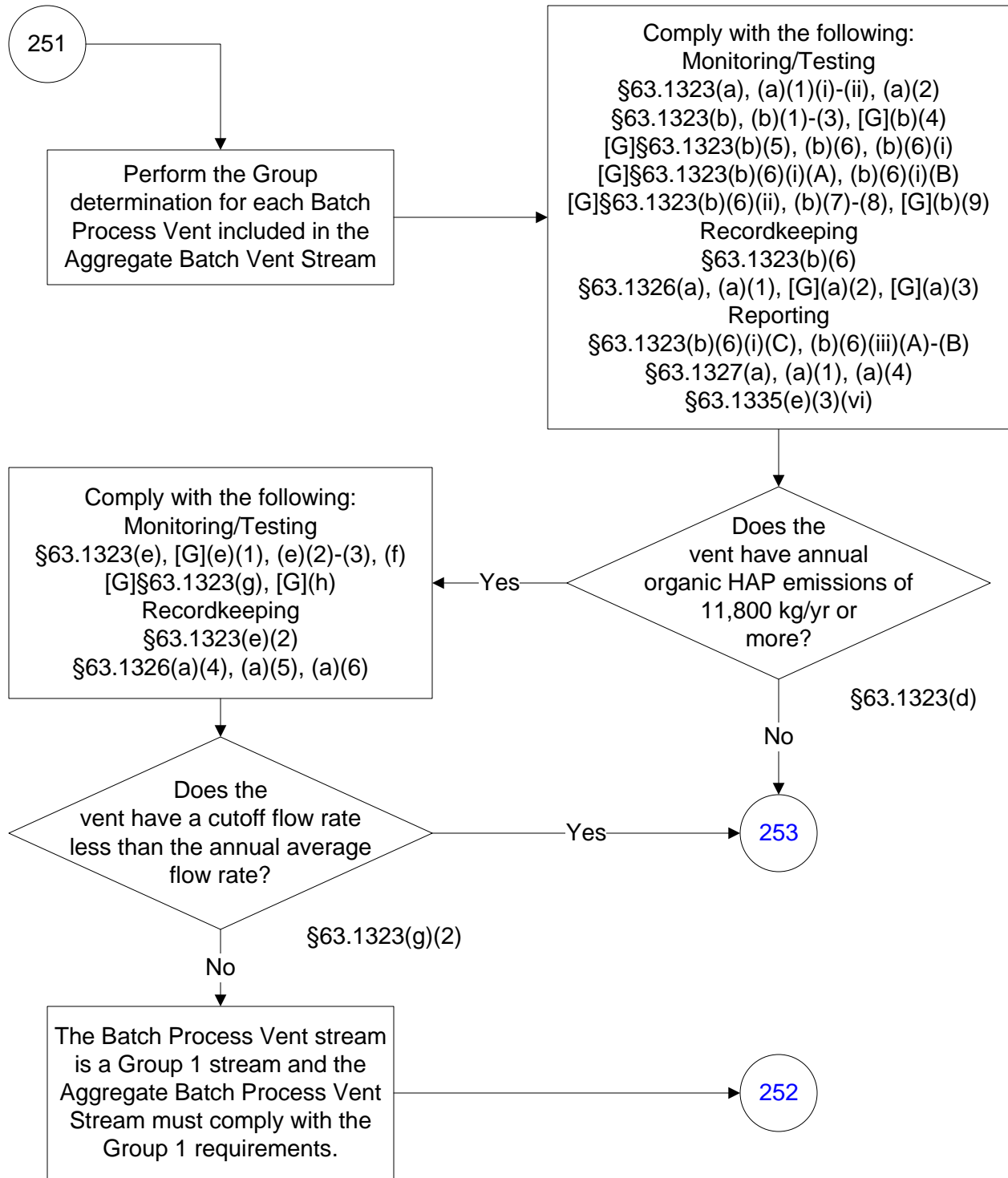

40 CFR Part 63, Subpart JJJ

(106 of 196)

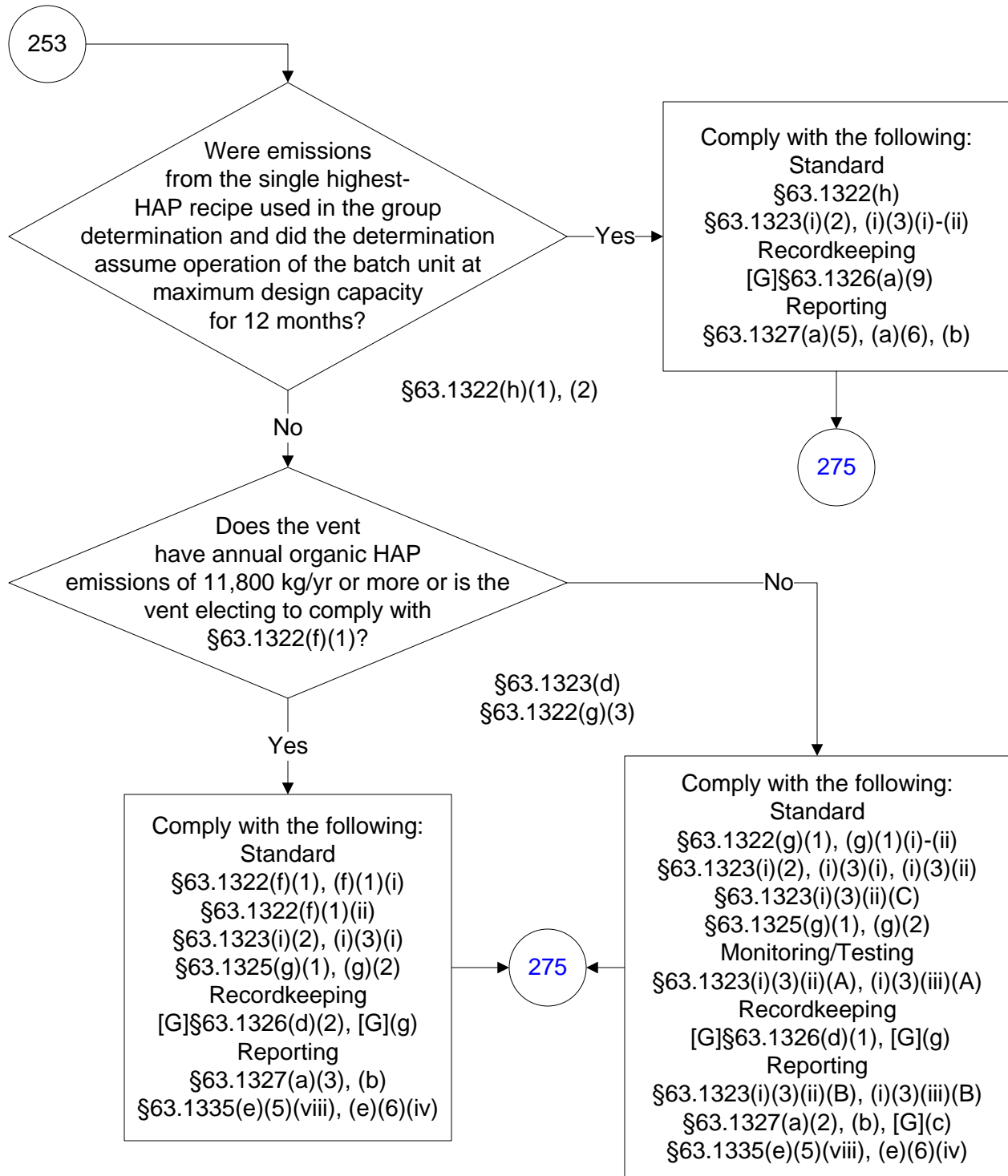

40 CFR Part 63, Subpart JJJ

(107 of 196)

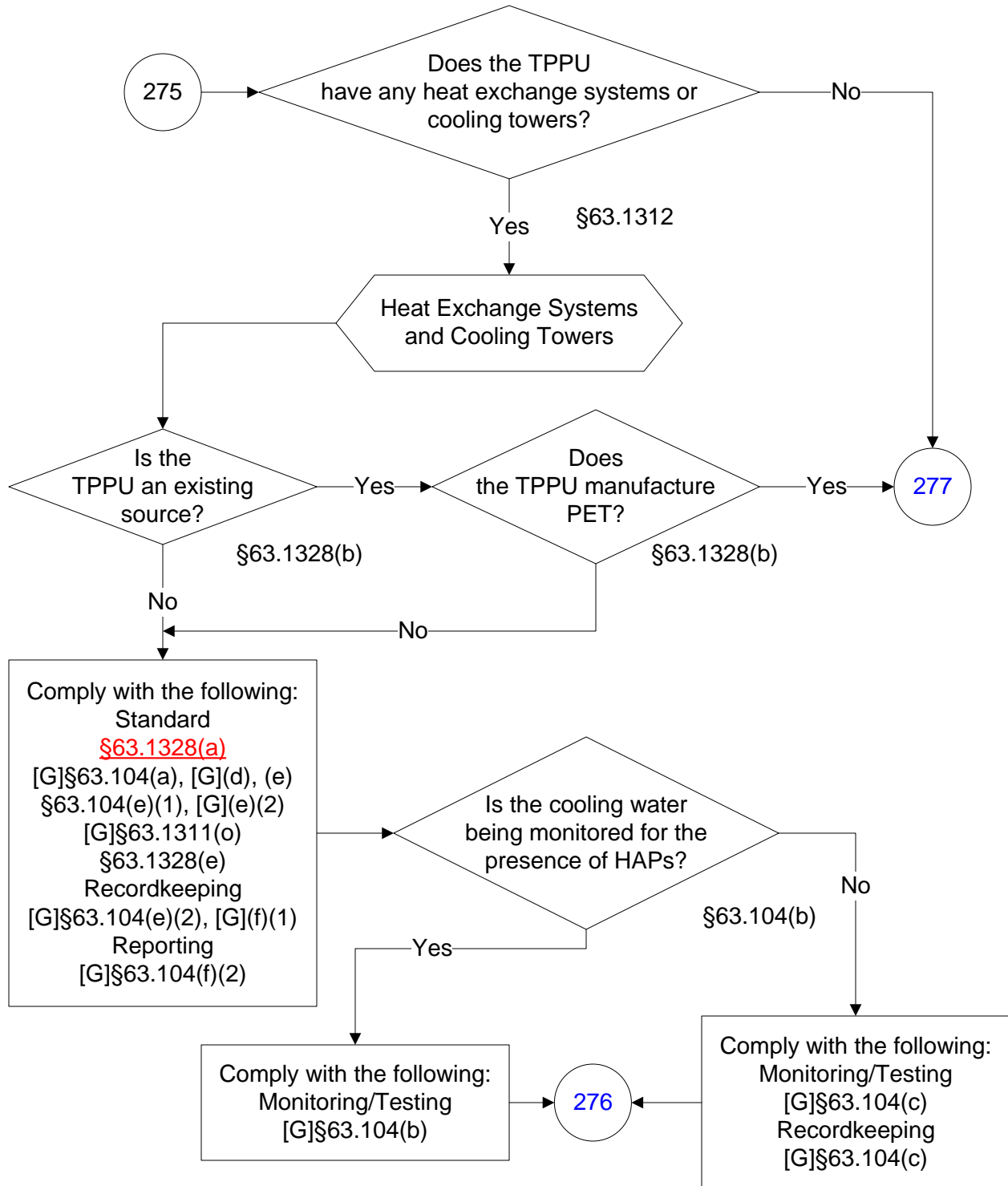

40 CFR Part 63, Subpart JJJ

(108 of 196)

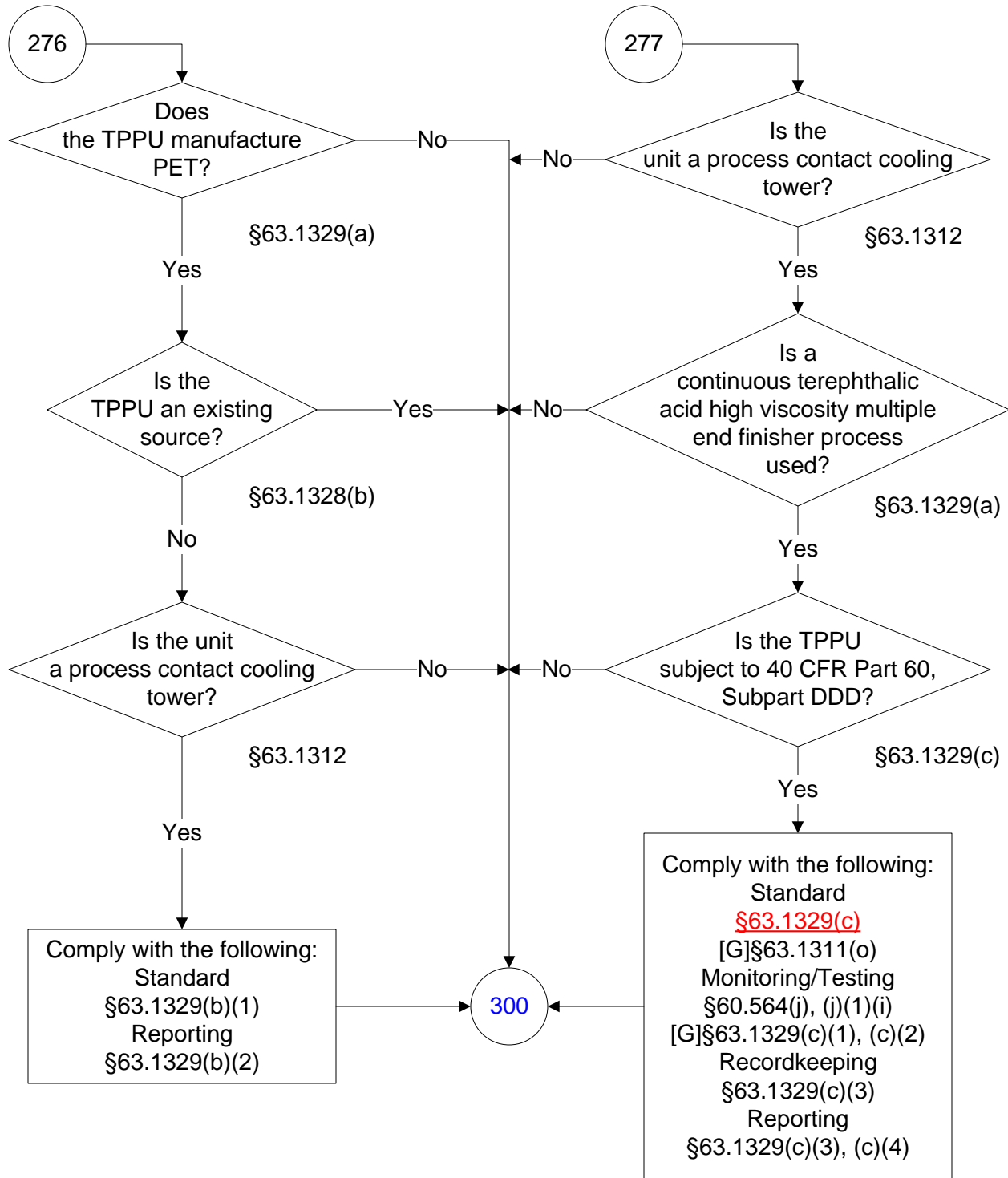

40 CFR Part 63, Subpart JJJ

(109 of 196)

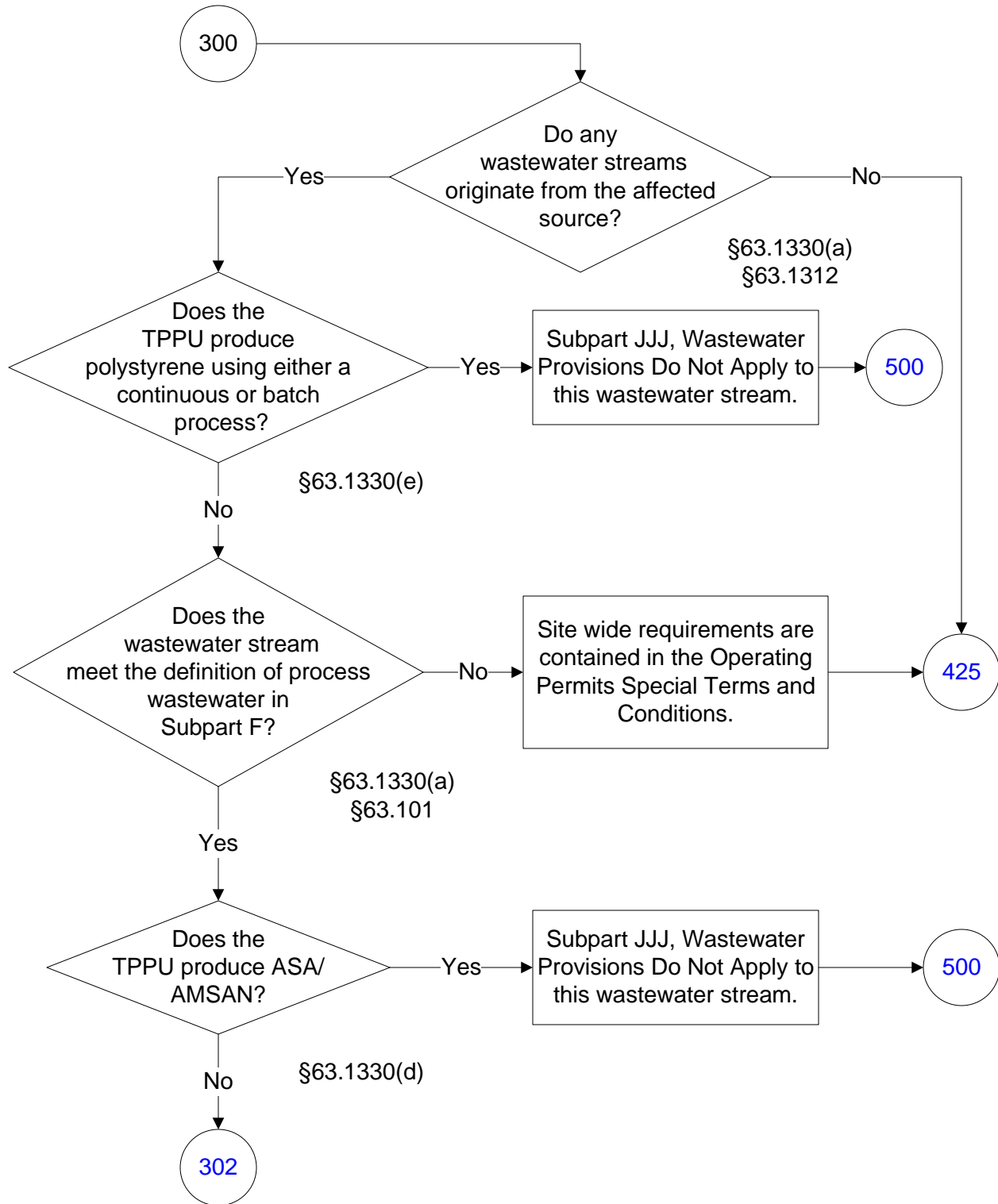

40 CFR Part 63, Subpart JJJ

(110 of 196)

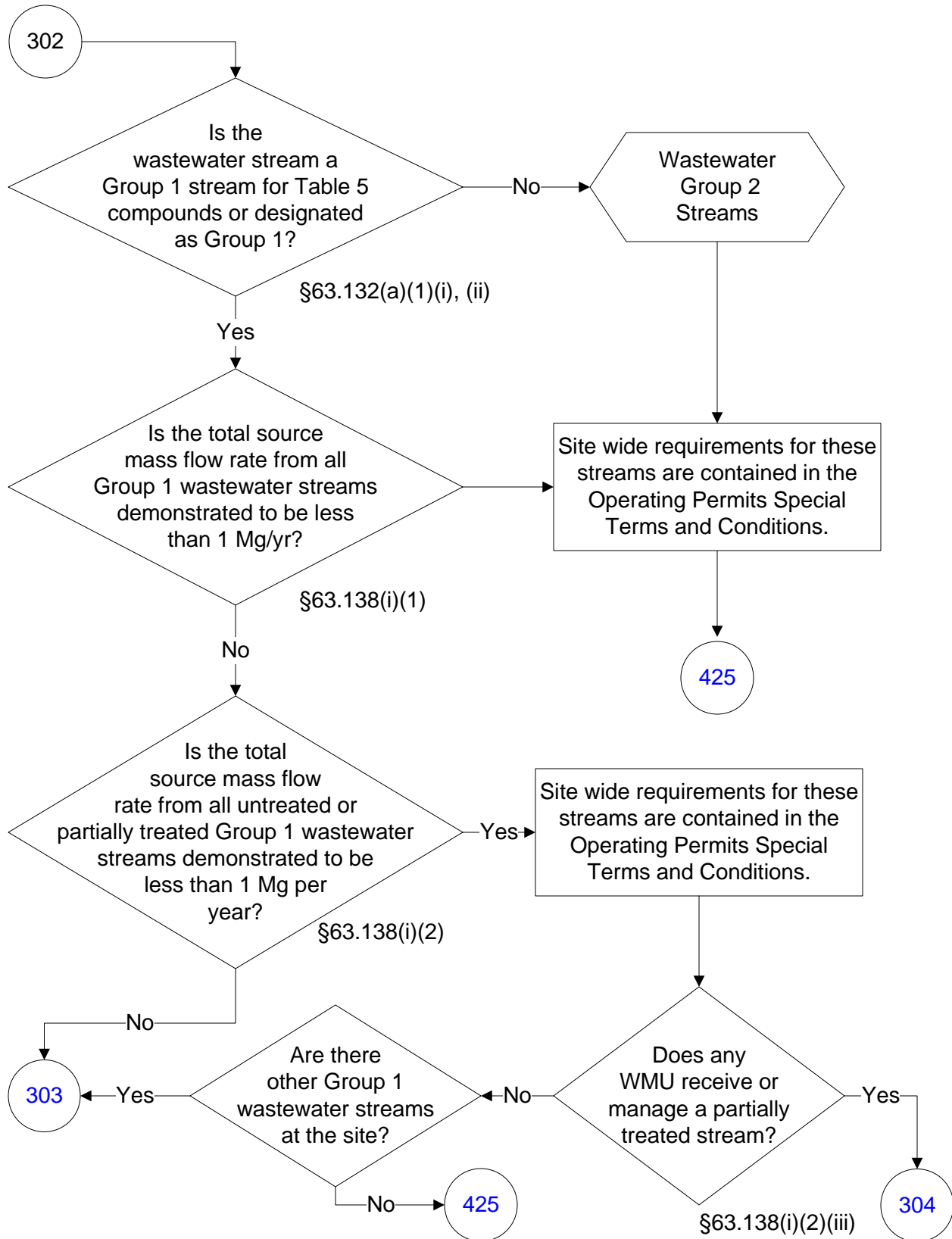

40 CFR Part 63, Subpart JJJ

(111 of 196)

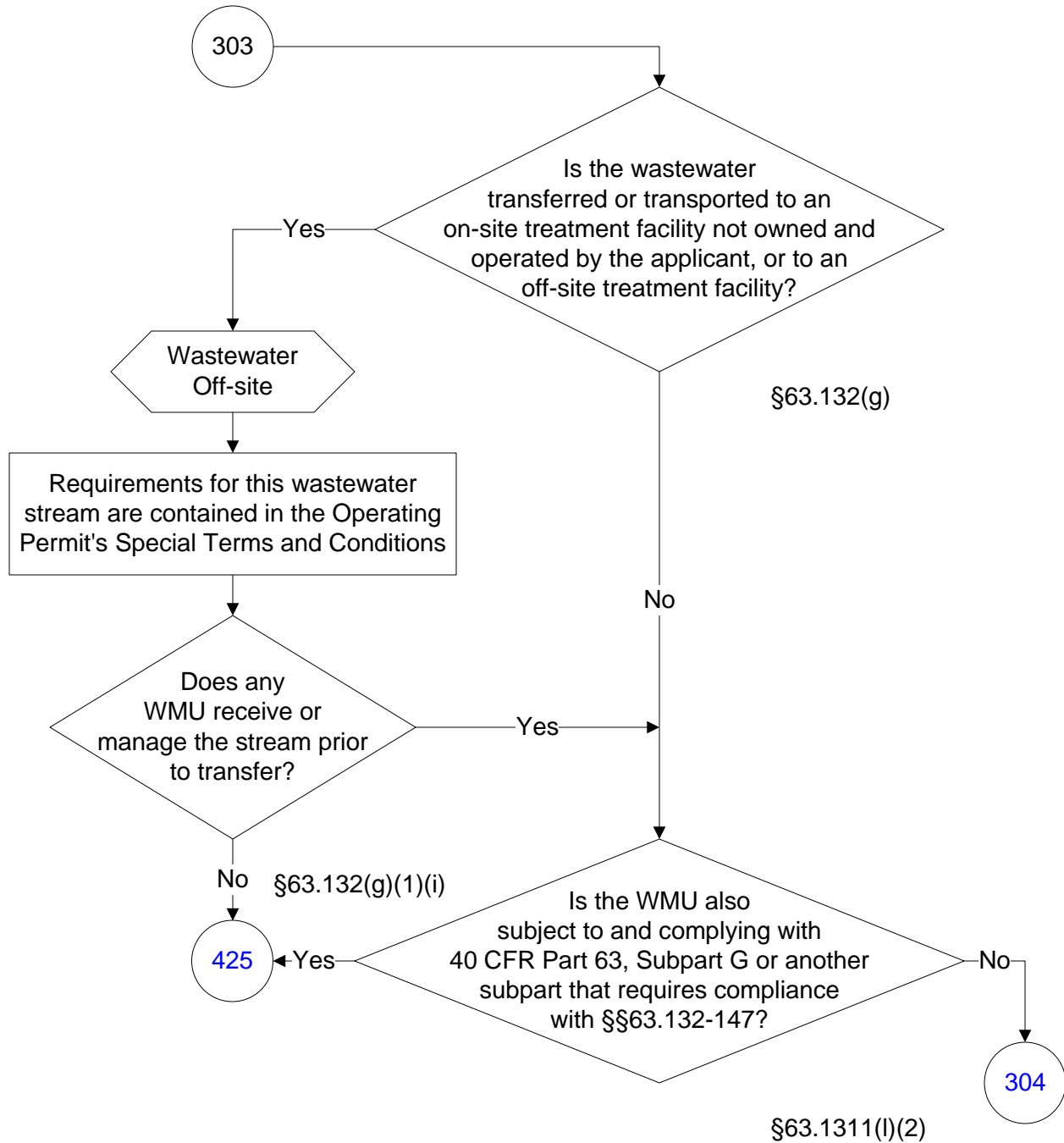

40 CFR Part 63, Subpart JJJ

(112 of 196)

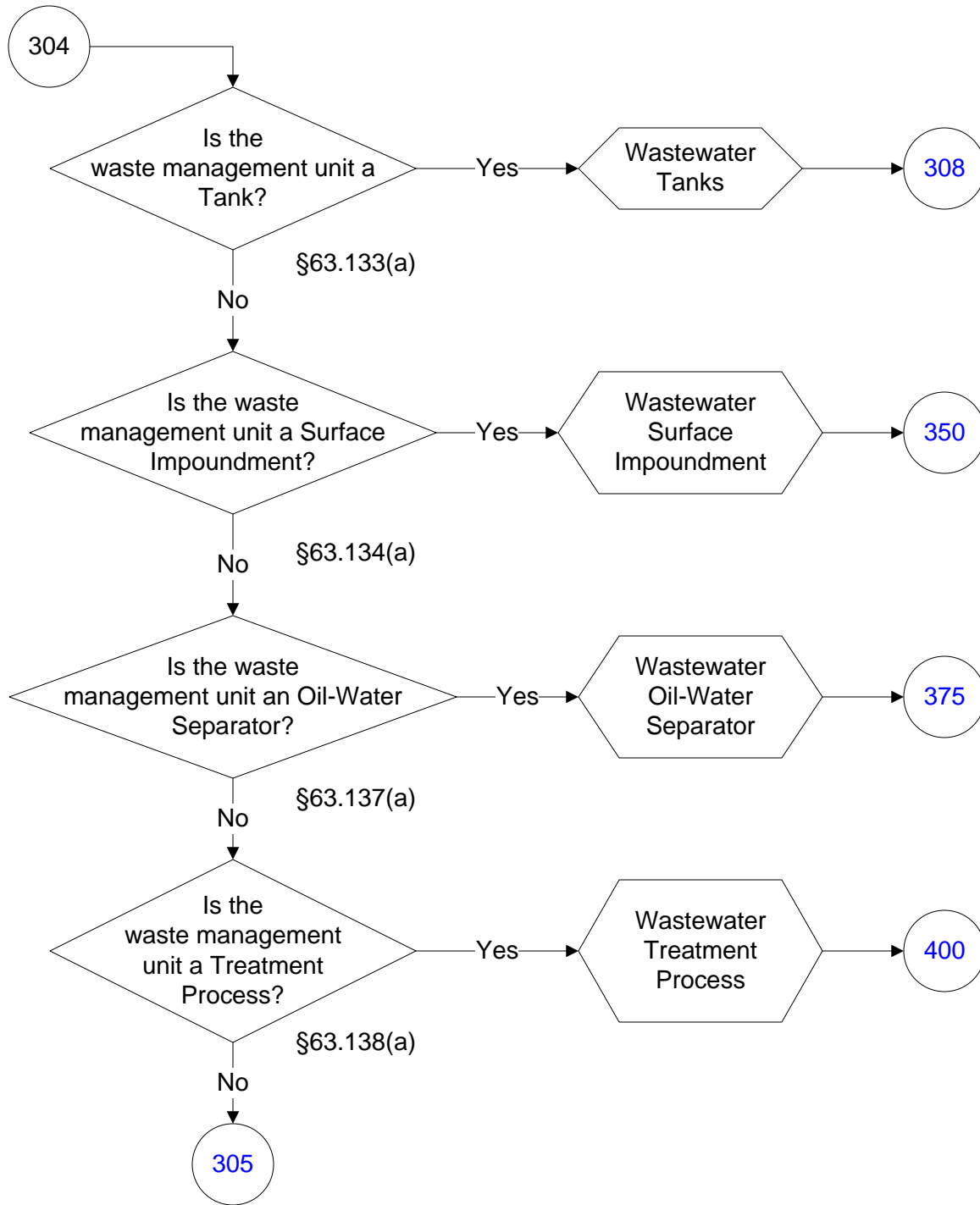

40 CFR Part 63, Subpart JJJ

(113 of 196)

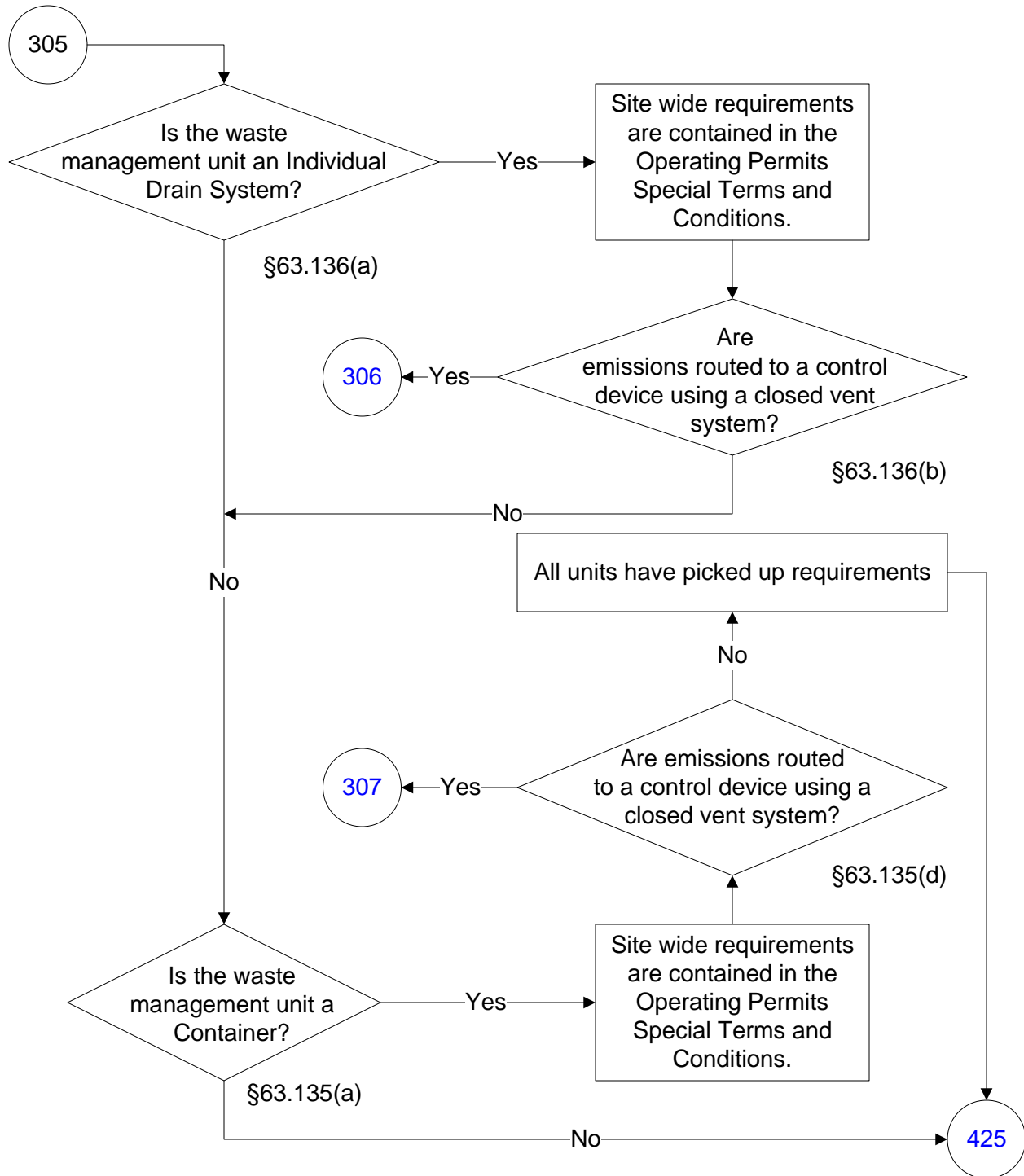

40 CFR Part 63, Subpart JJJ

(114 of 196)

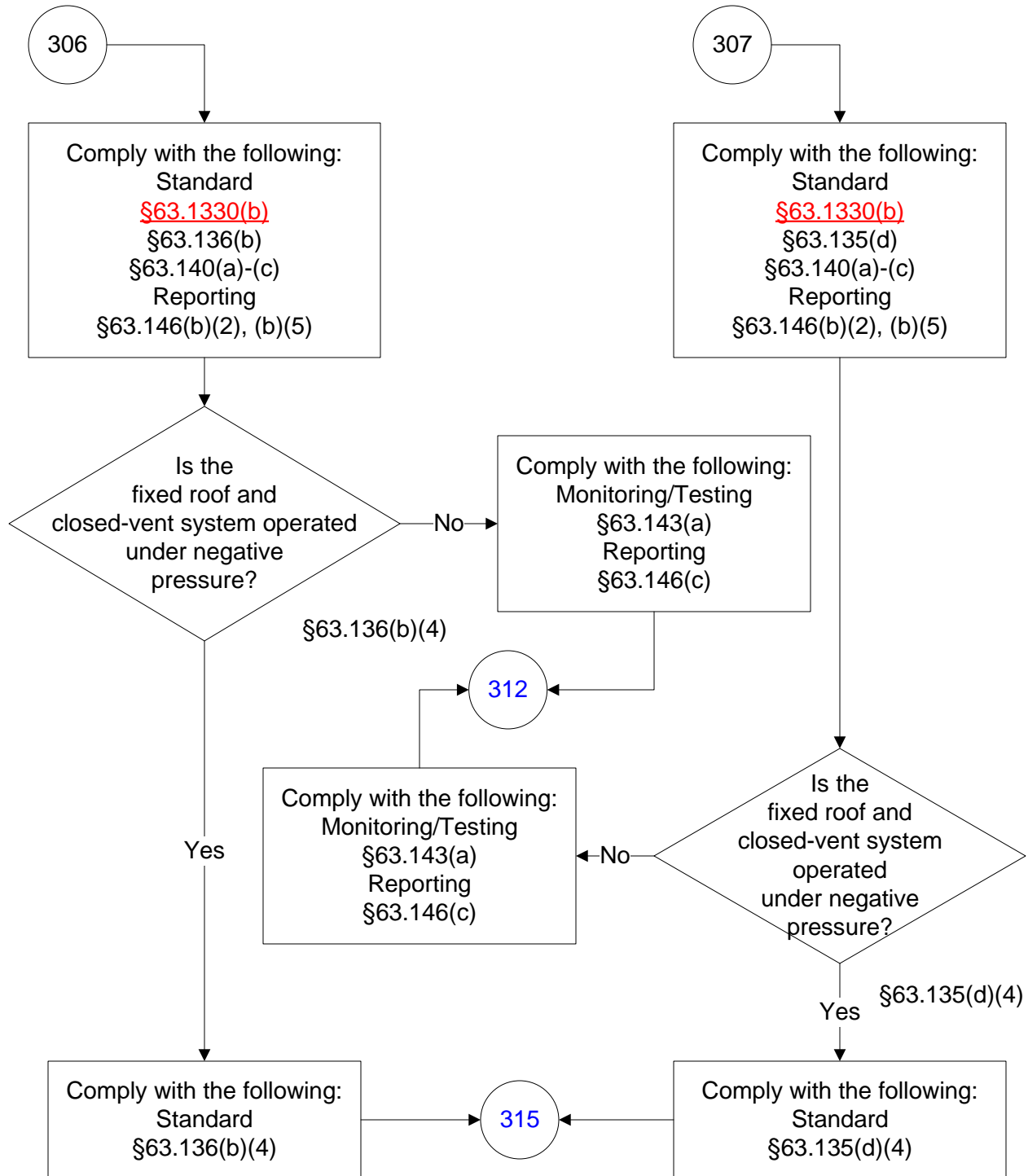

40 CFR Part 63, Subpart JJJ

(115 of 196)

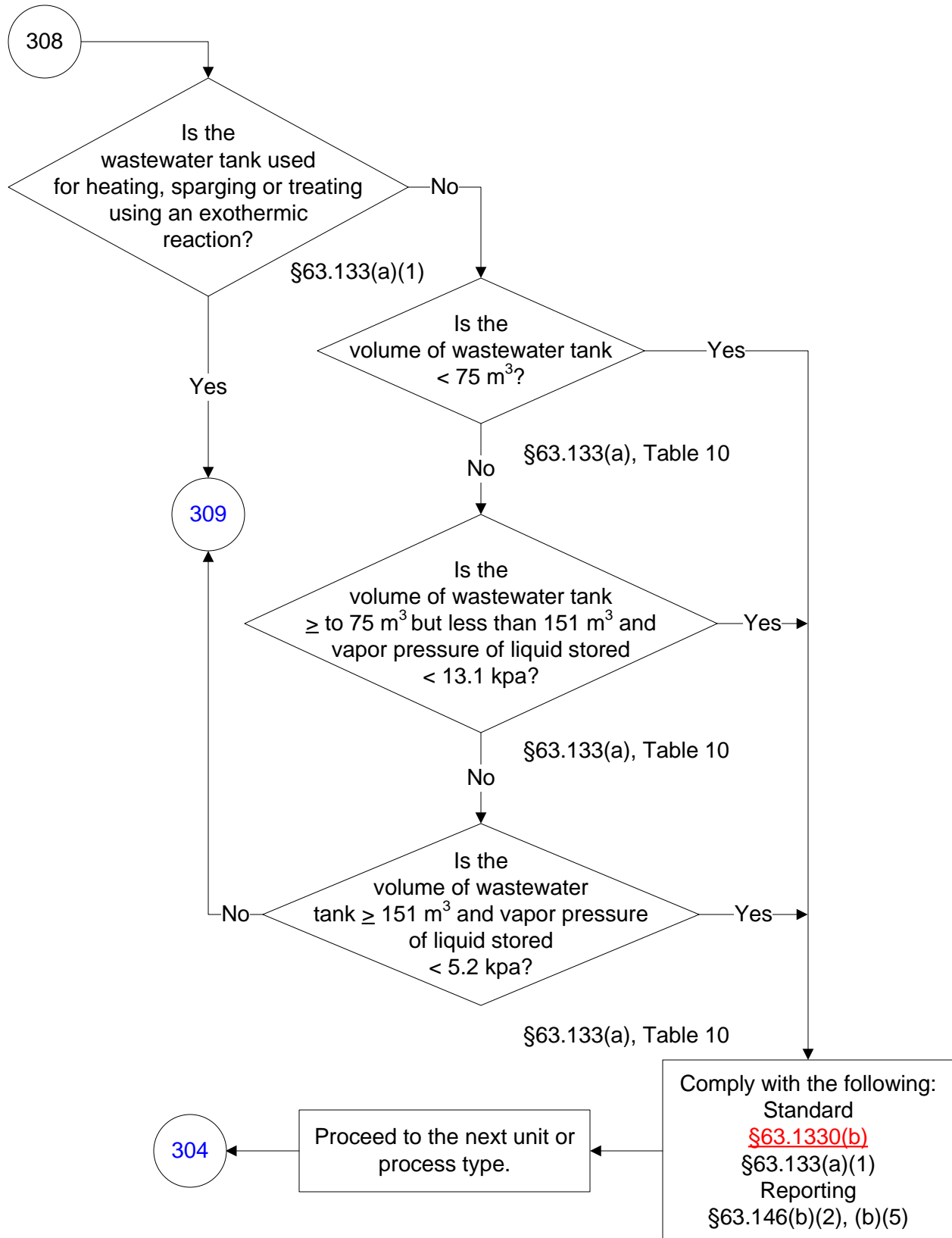

40 CFR Part 63, Subpart JJJ

(116 of 196)

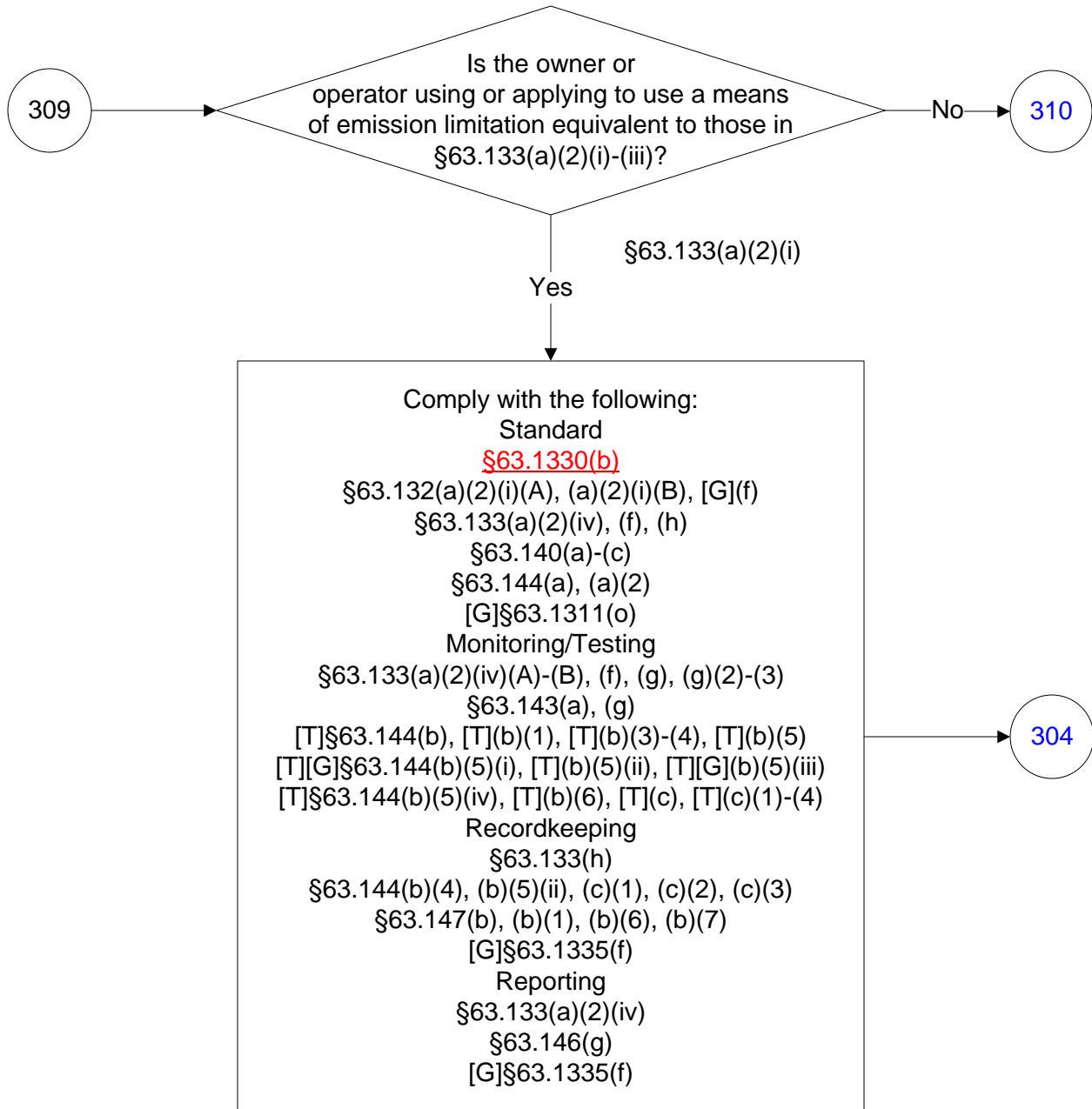

40 CFR Part 63, Subpart JJJ

(117 of 196)

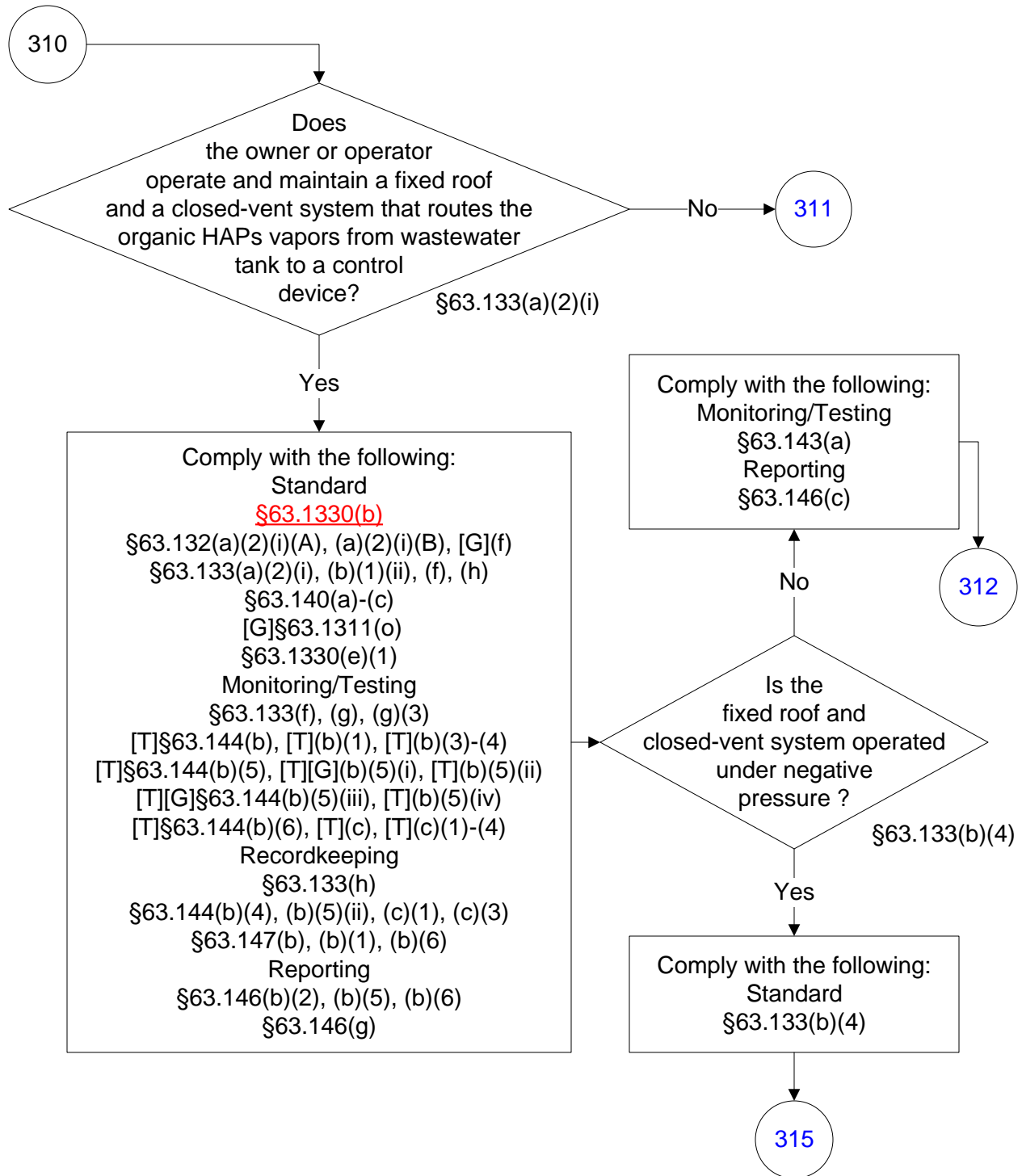

40 CFR Part 63, Subpart JJJ

(118 of 196)

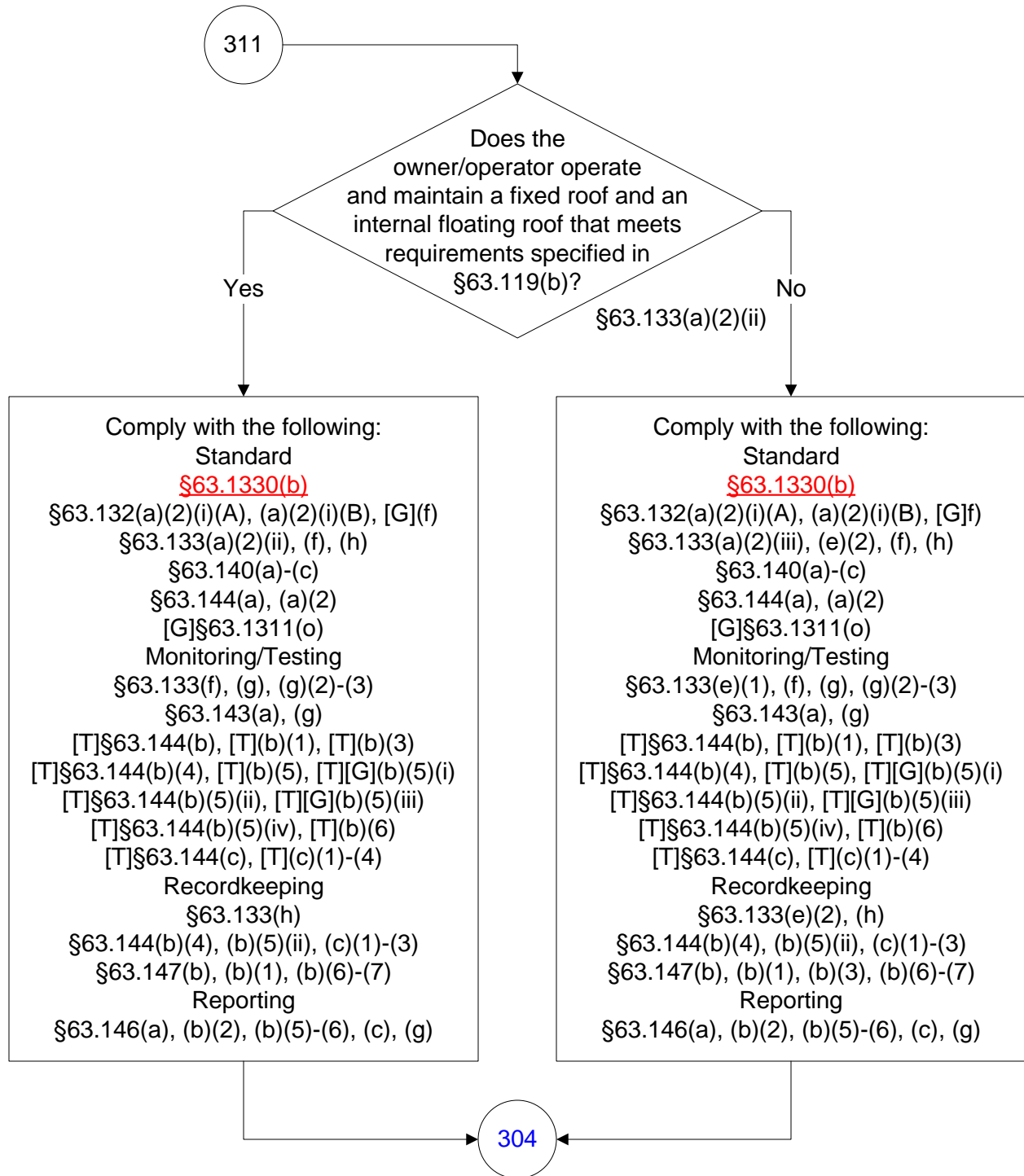

40 CFR Part 63, Subpart JJJ

(119 of 196)

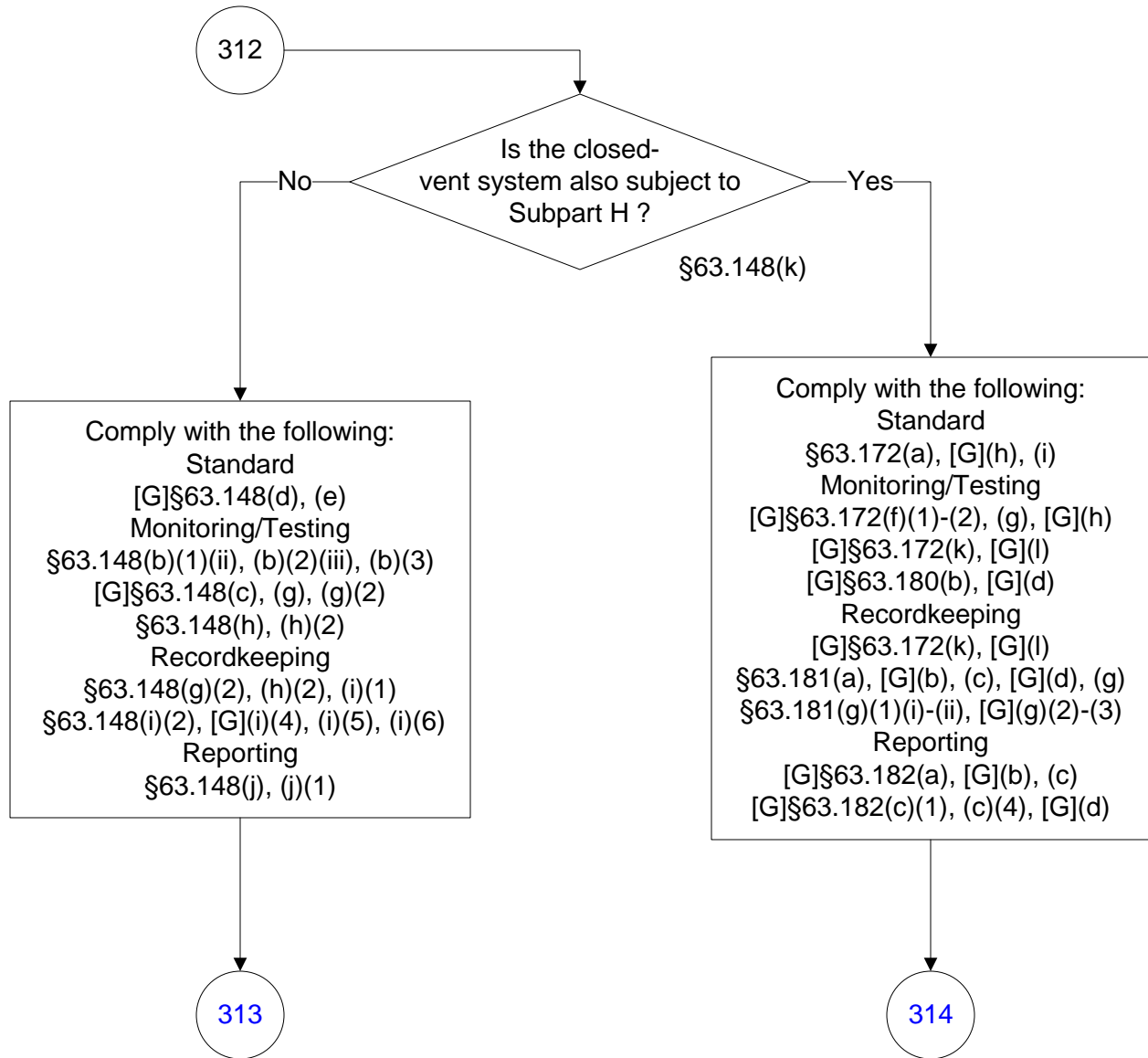

40 CFR Part 63, Subpart JJJ

(120 of 196)

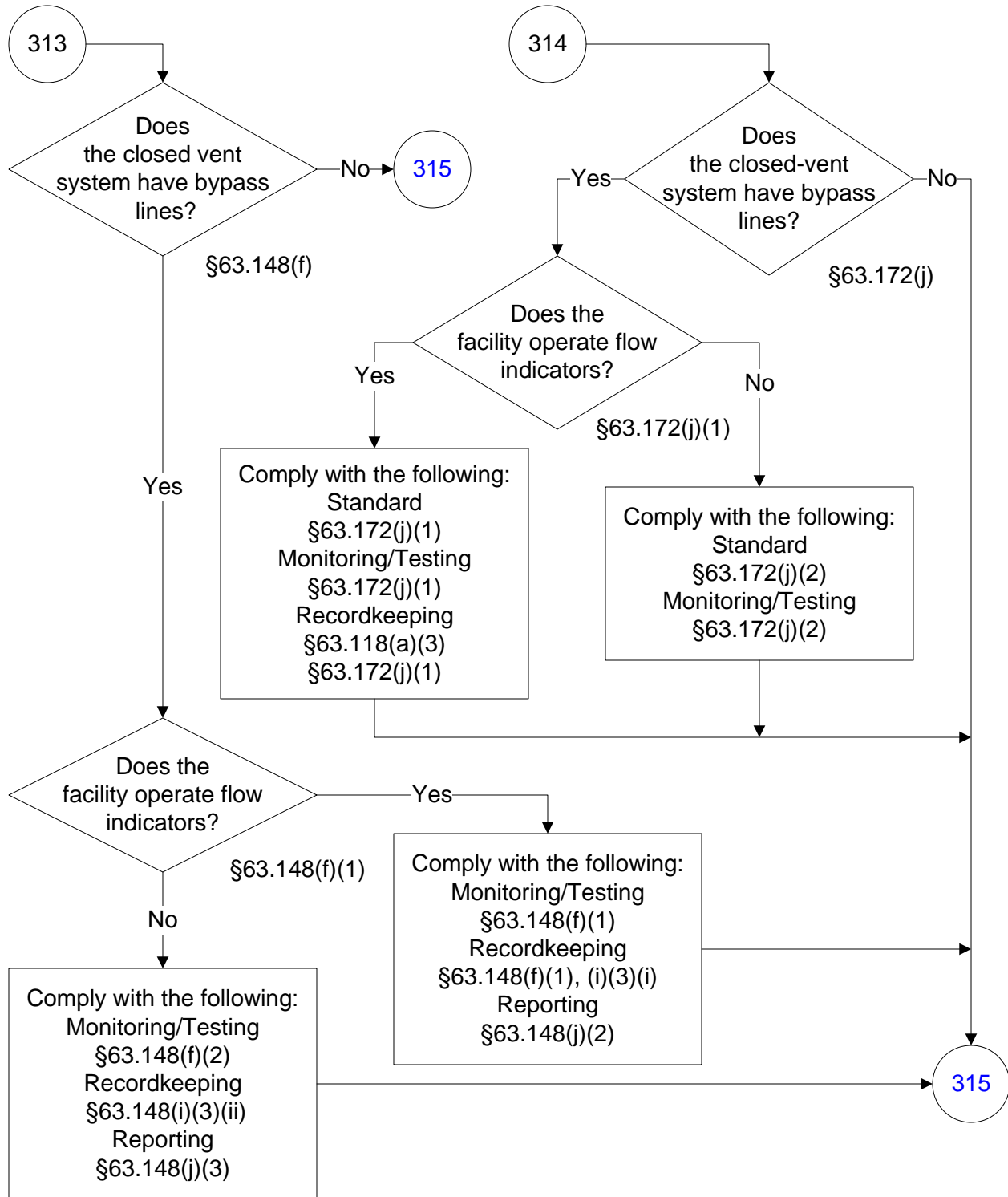

40 CFR Part 63, Subpart JJJ

(121 of 196)

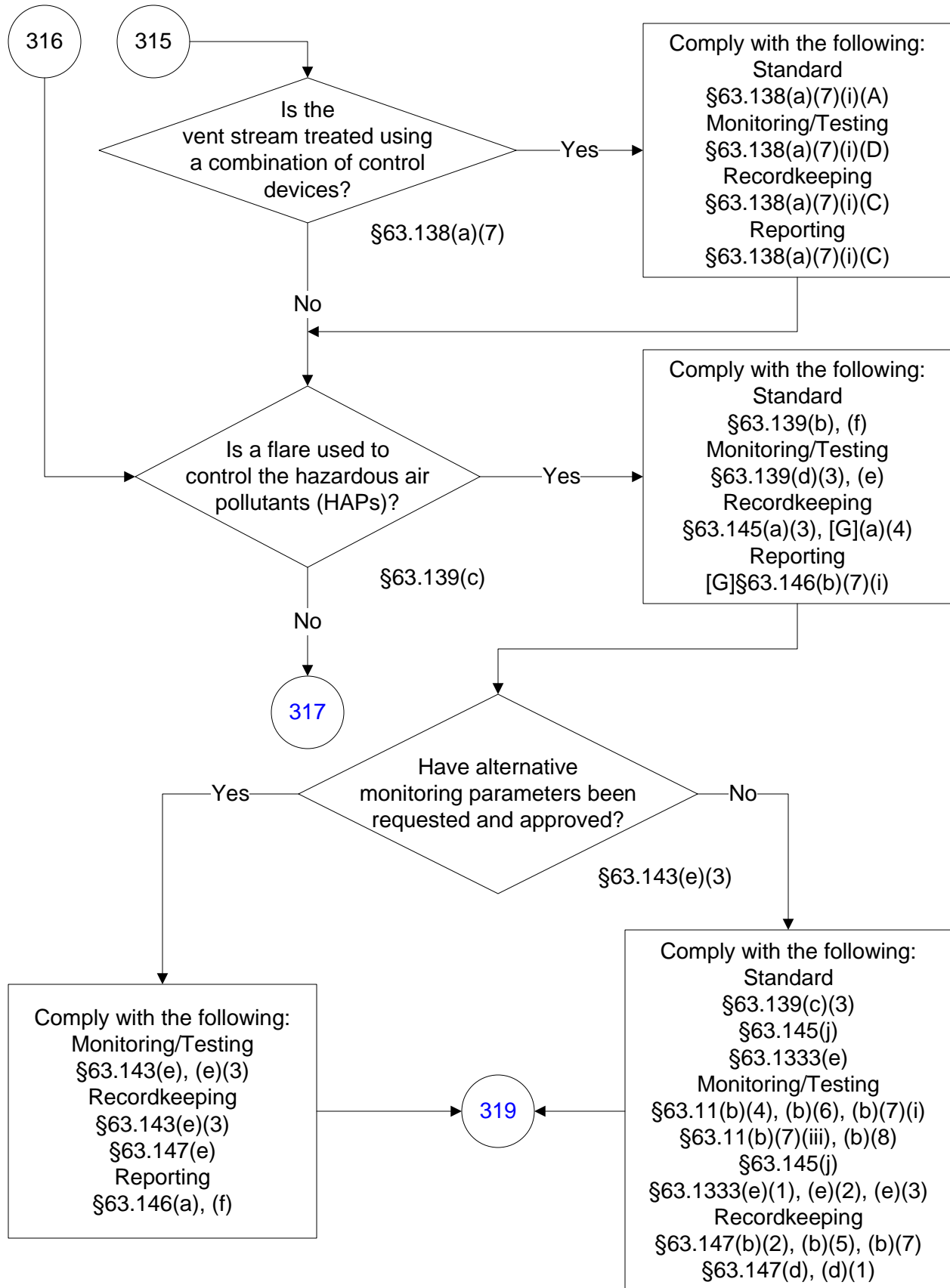

40 CFR Part 63, Subpart JJJ

(122 of 196)

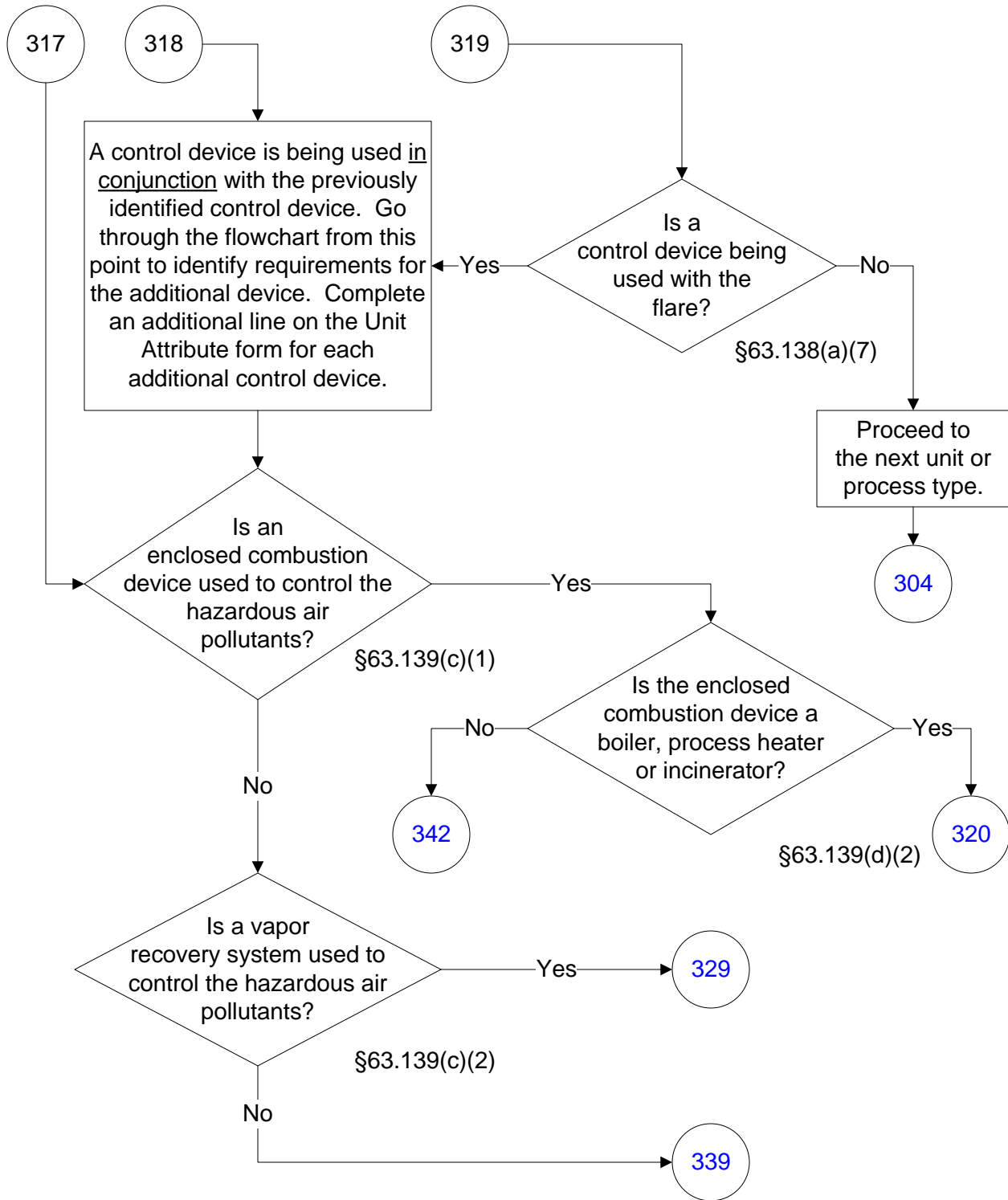

40 CFR Part 63, Subpart JJJ

(123 of 196)

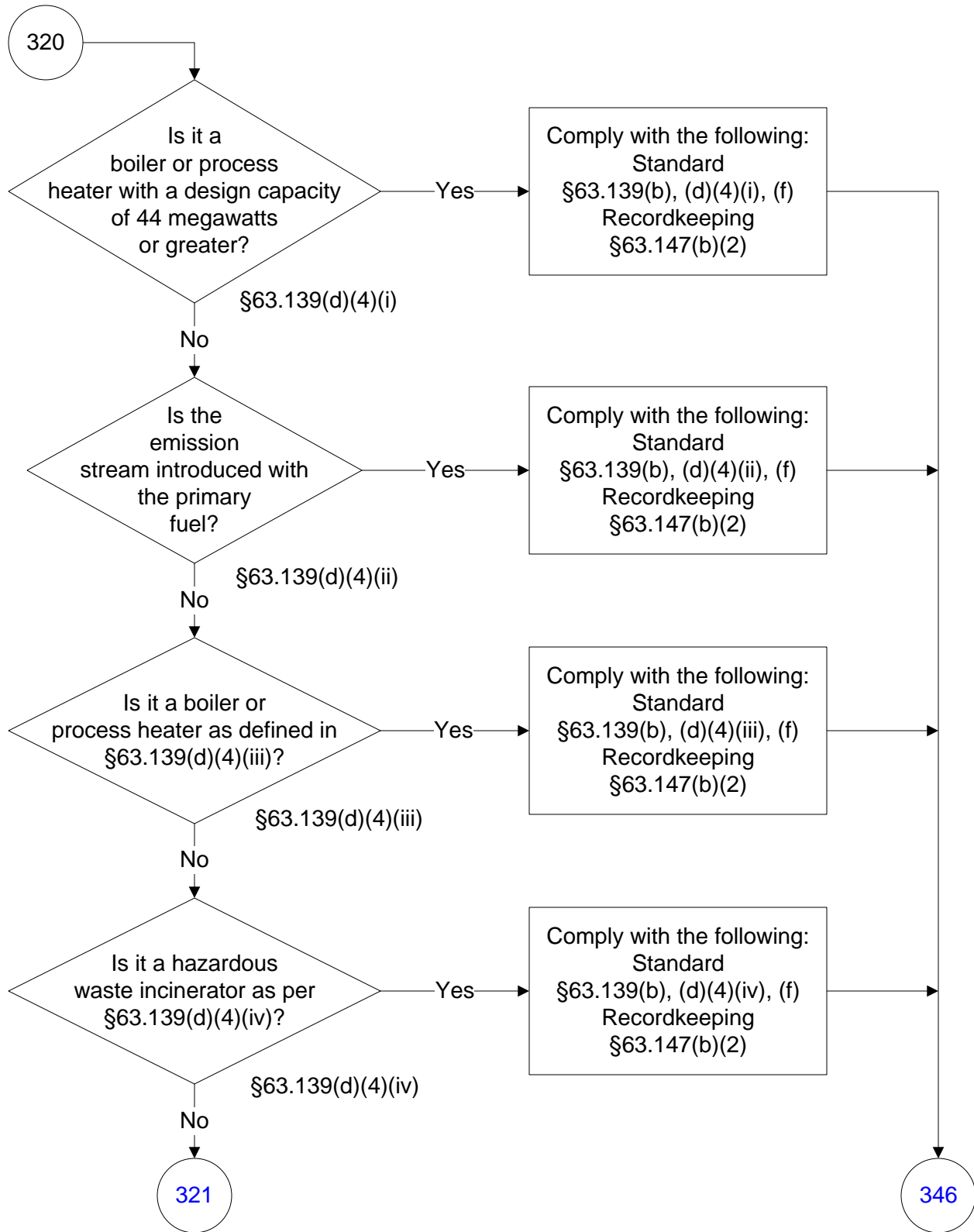

40 CFR Part 63, Subpart JJJ

(124 of 196)

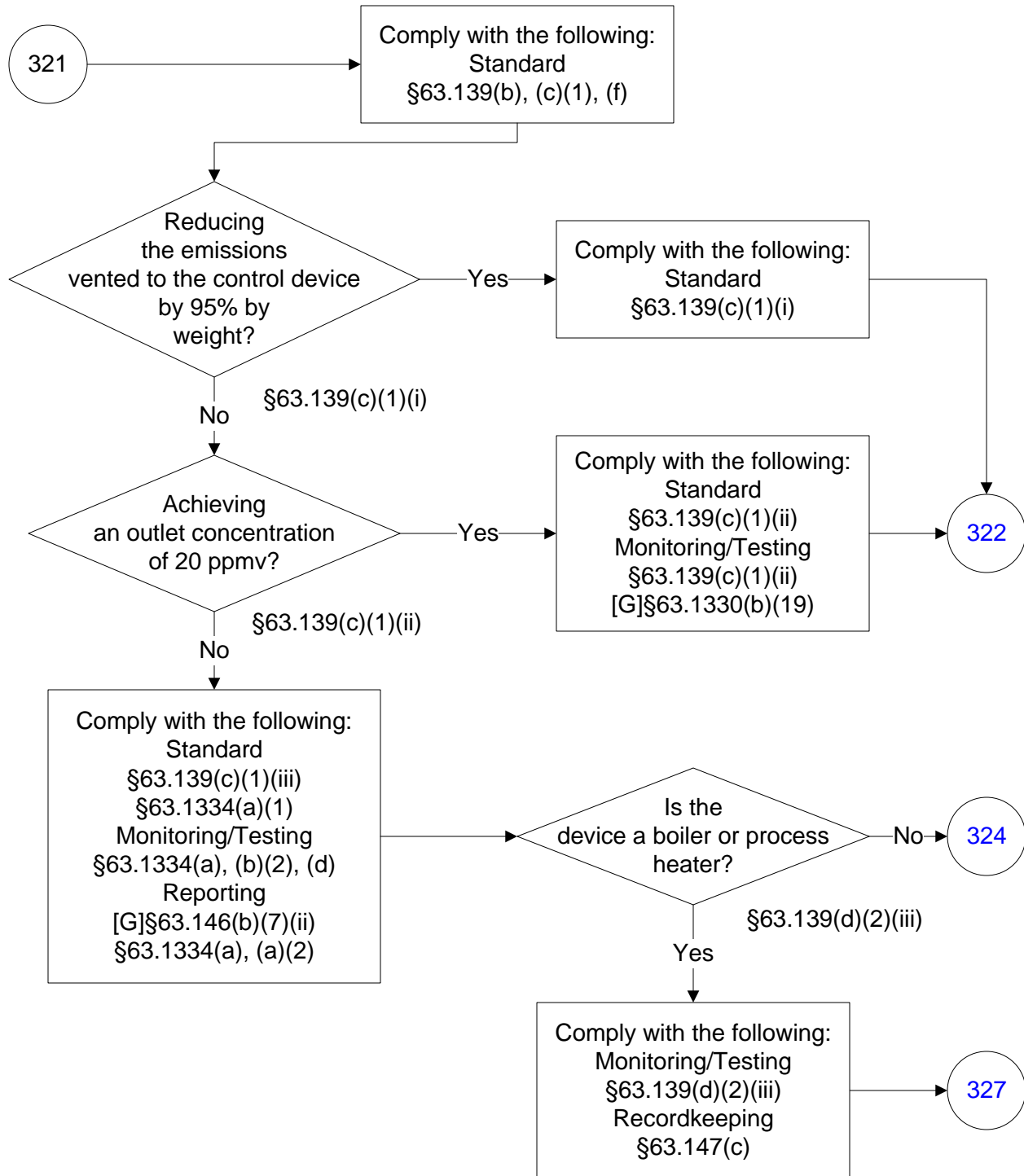

40 CFR Part 63, Subpart JJJ

(125 of 196)

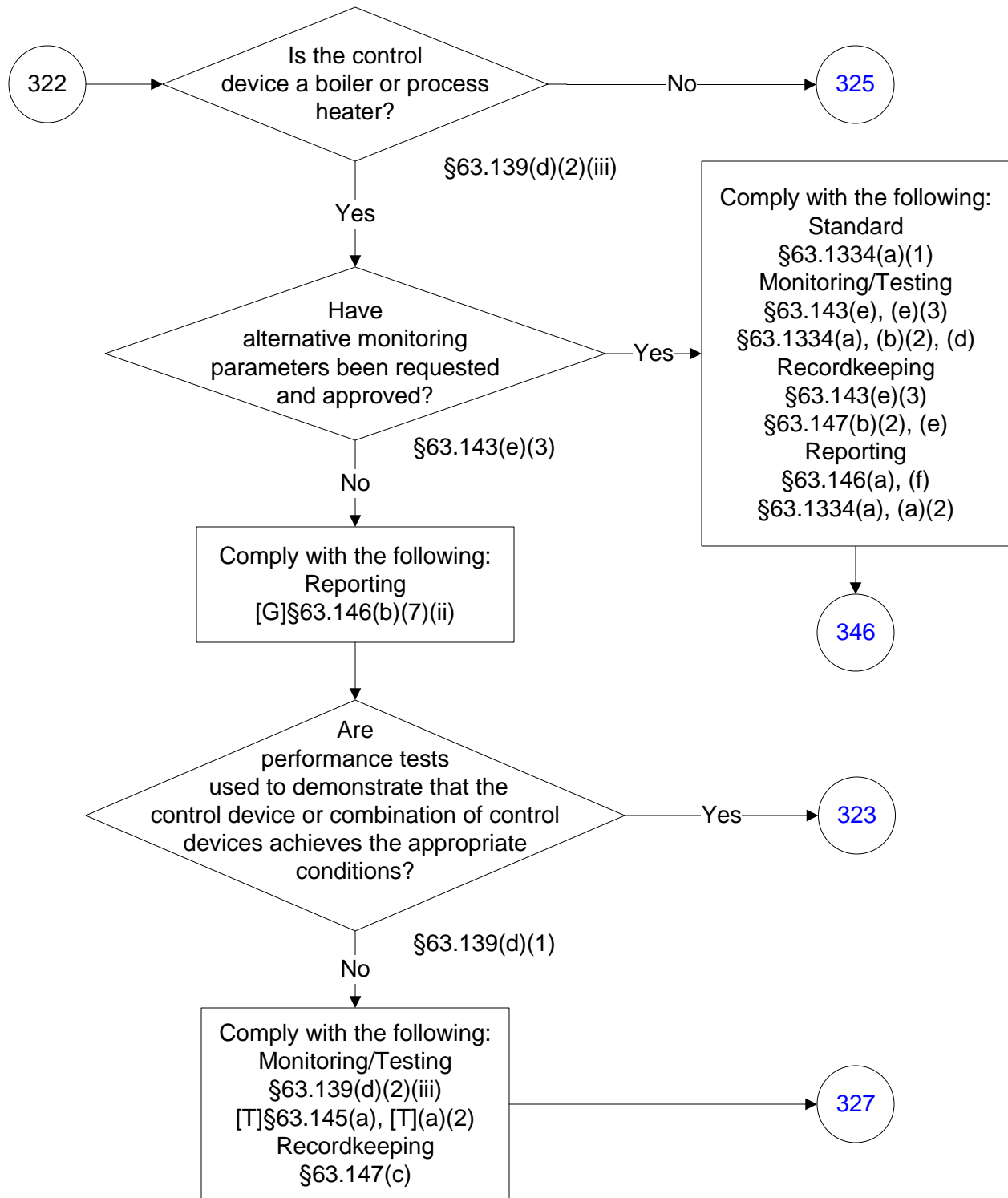

40 CFR Part 63, Subpart JJJ

(126 of 196)

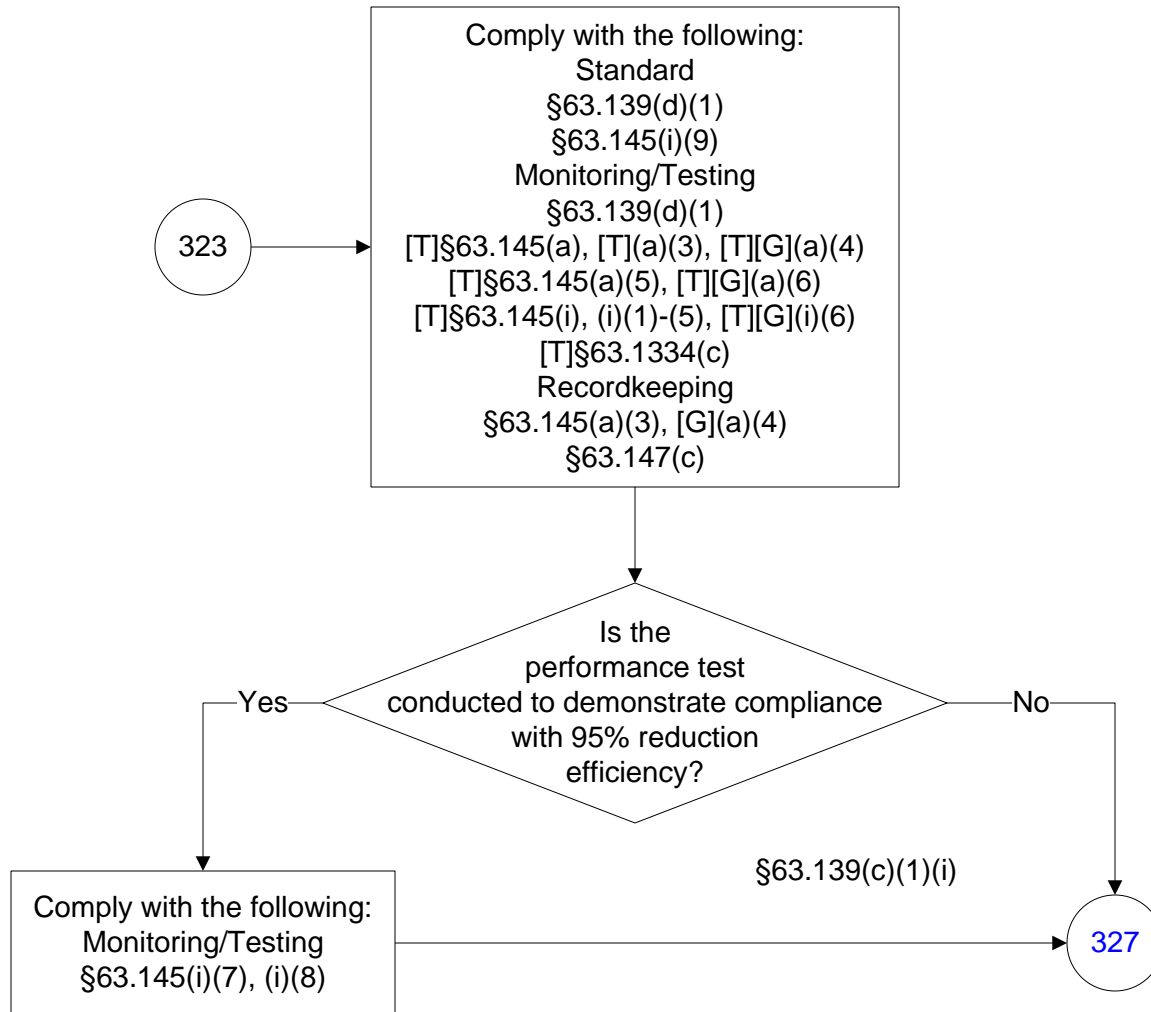

40 CFR Part 63, Subpart JJJ

(127 of 196)

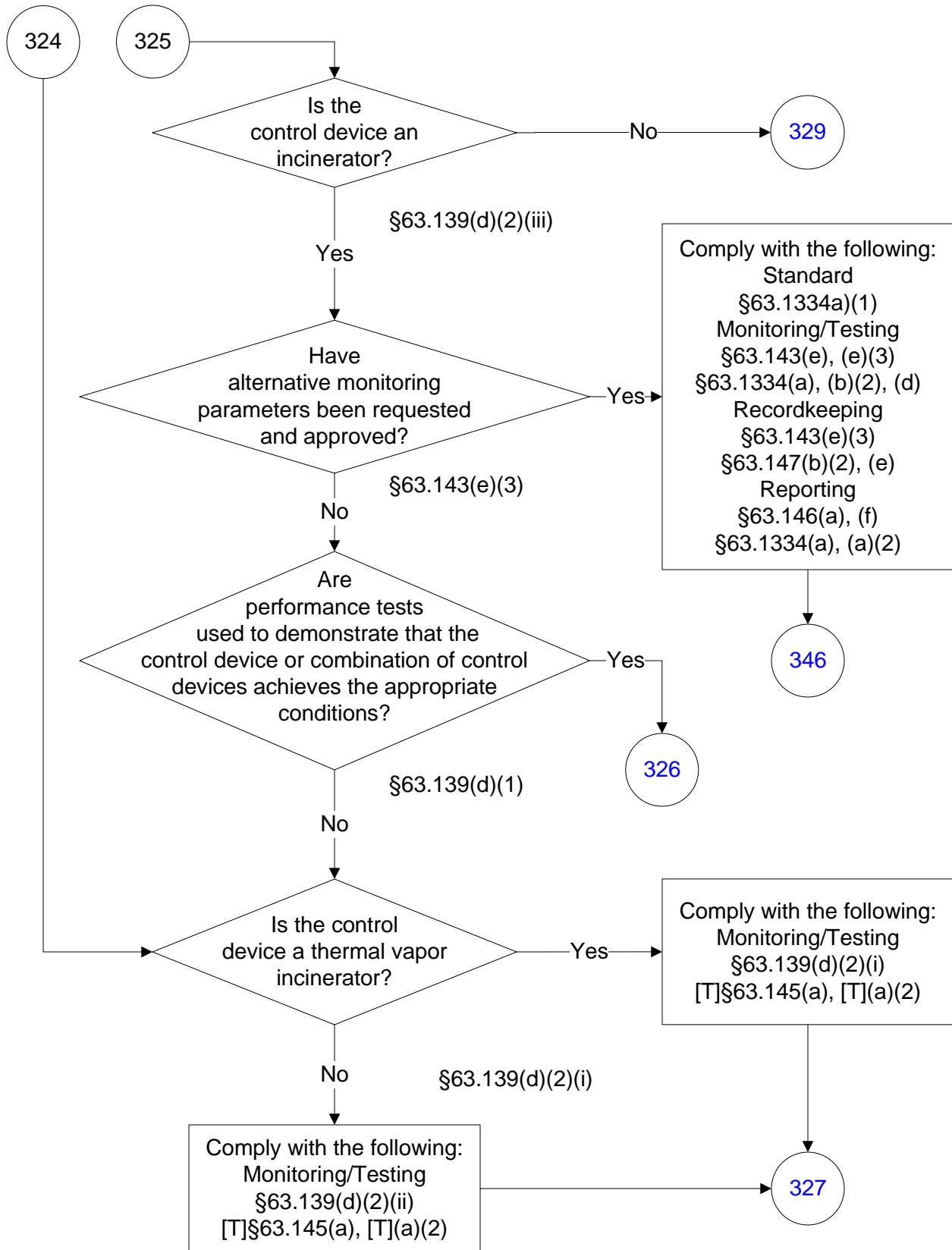

40 CFR Part 63, Subpart JJJ

(128 of 196)

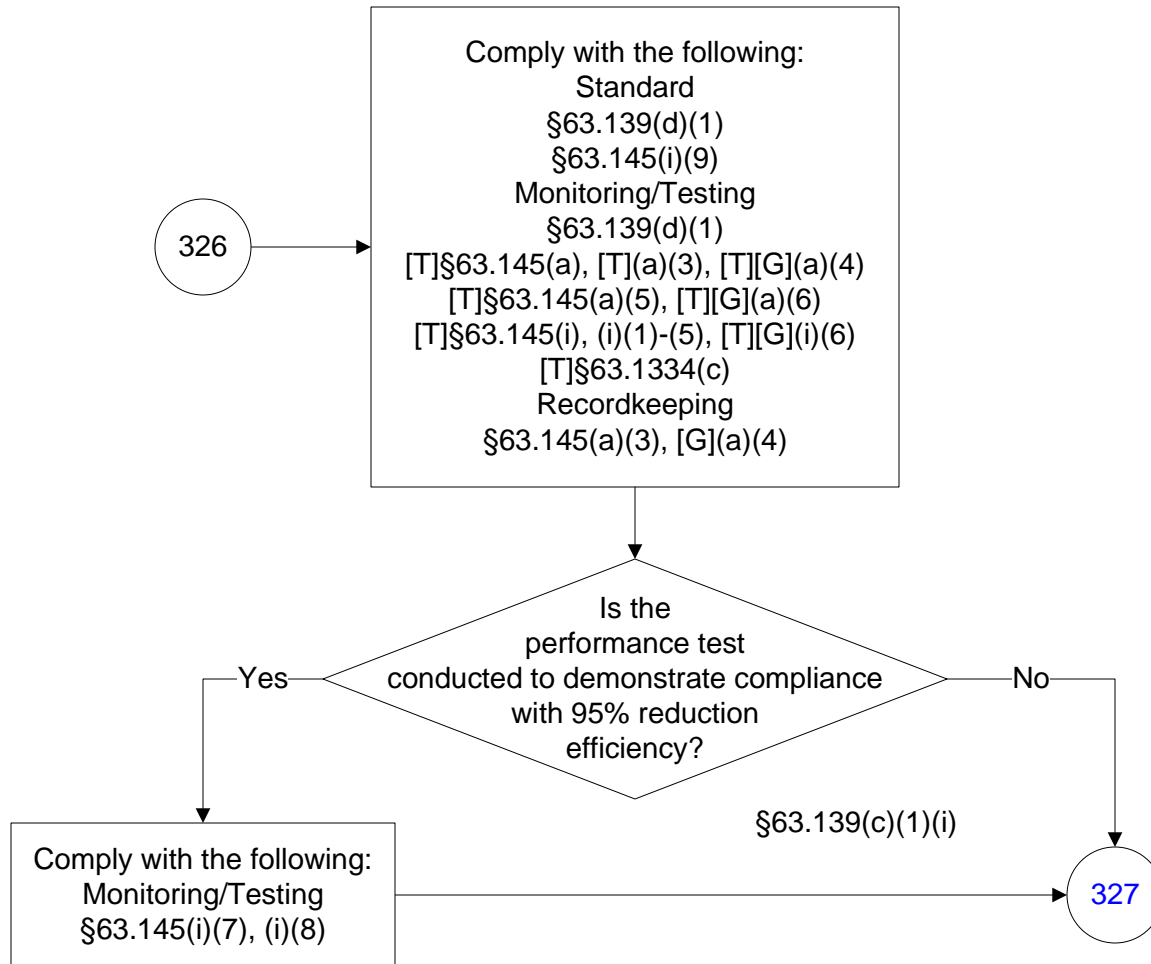

40 CFR Part 63, Subpart JJJ

(129 of 196)

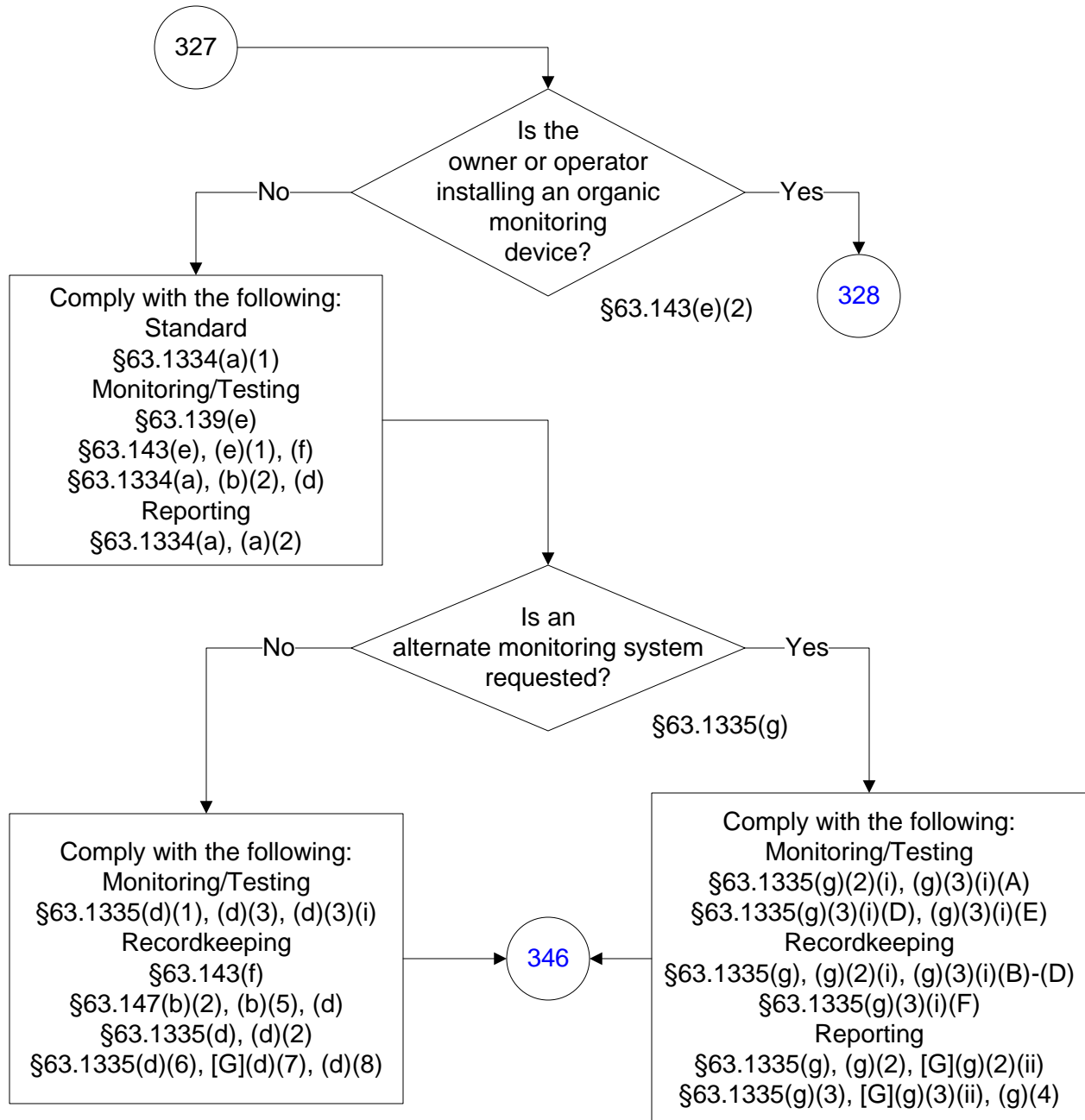

40 CFR Part 63, Subpart JJJ

(130 of 196)

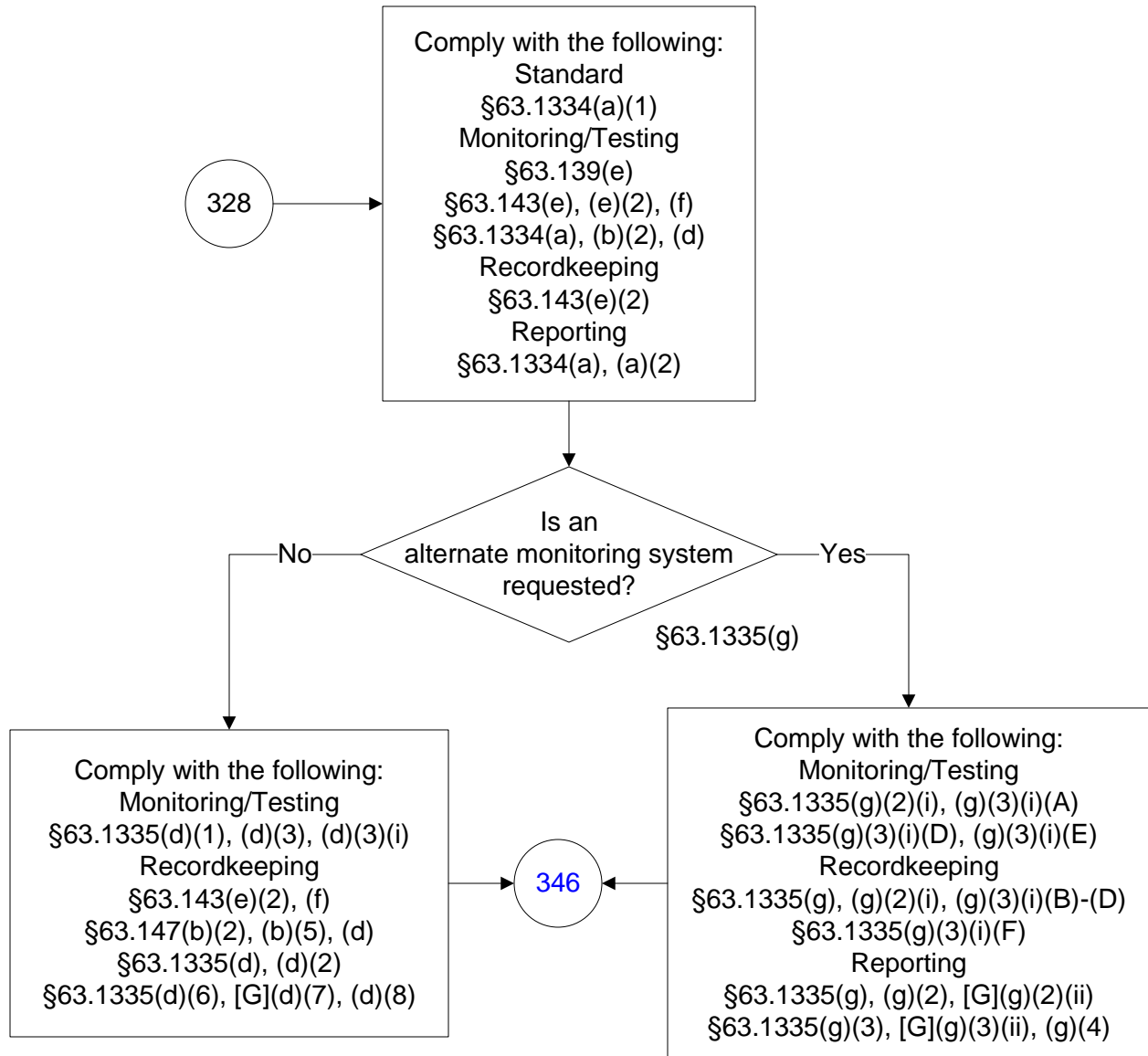

40 CFR Part 63, Subpart JJJ

(131 of 196)

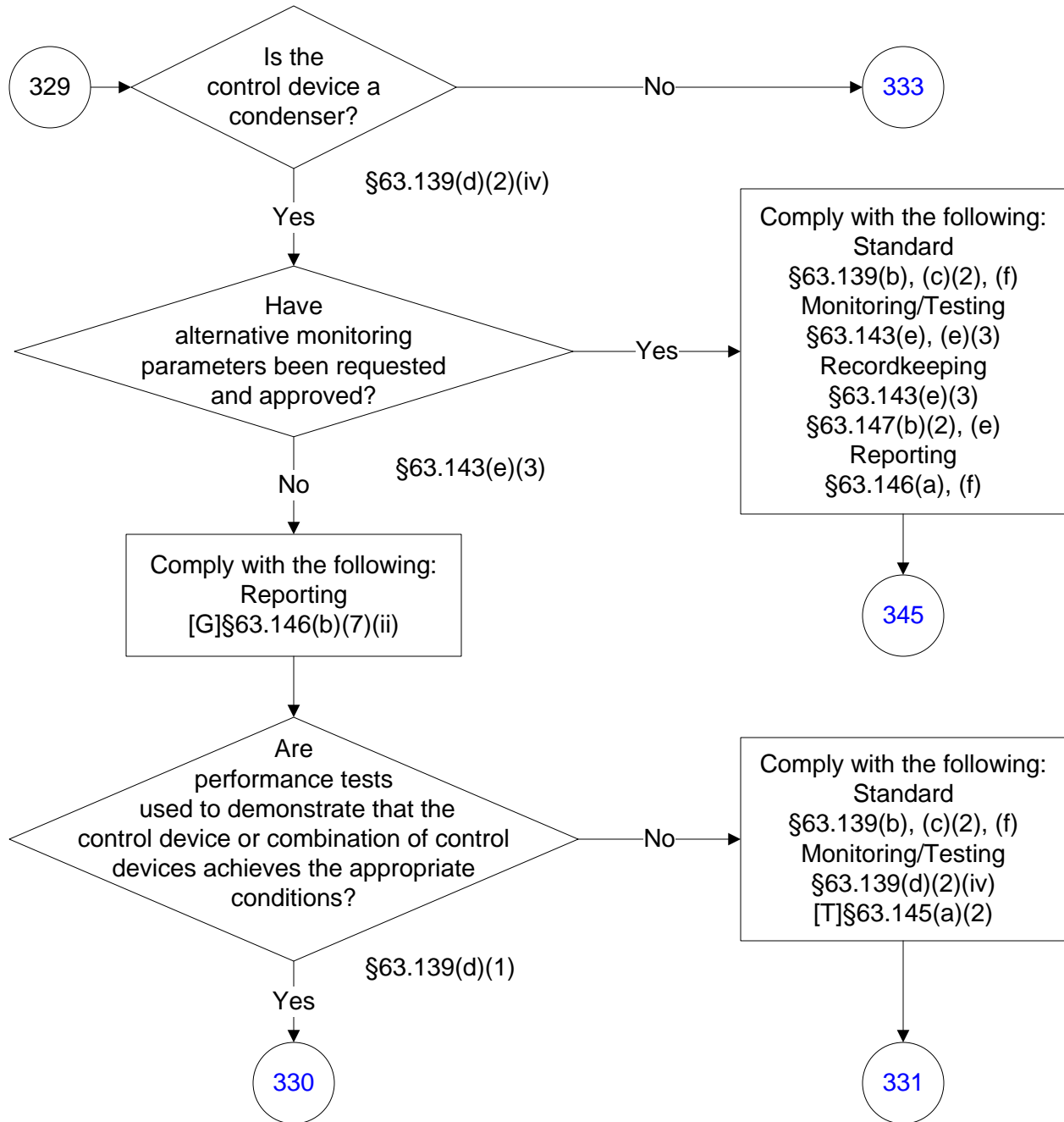

40 CFR Part 63, Subpart JJJ

(132 of 196)

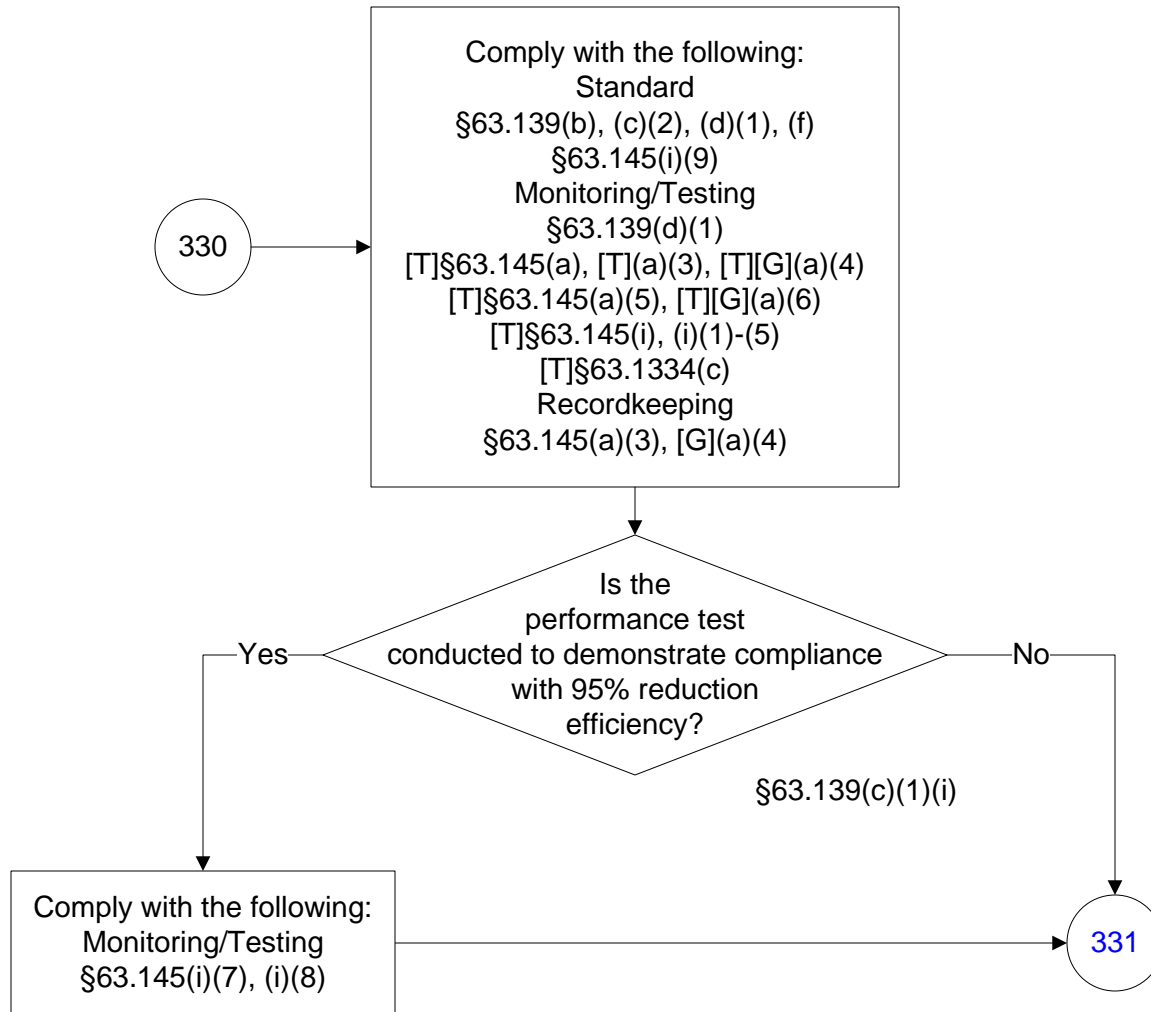

40 CFR Part 63, Subpart JJJ

(133 of 196)

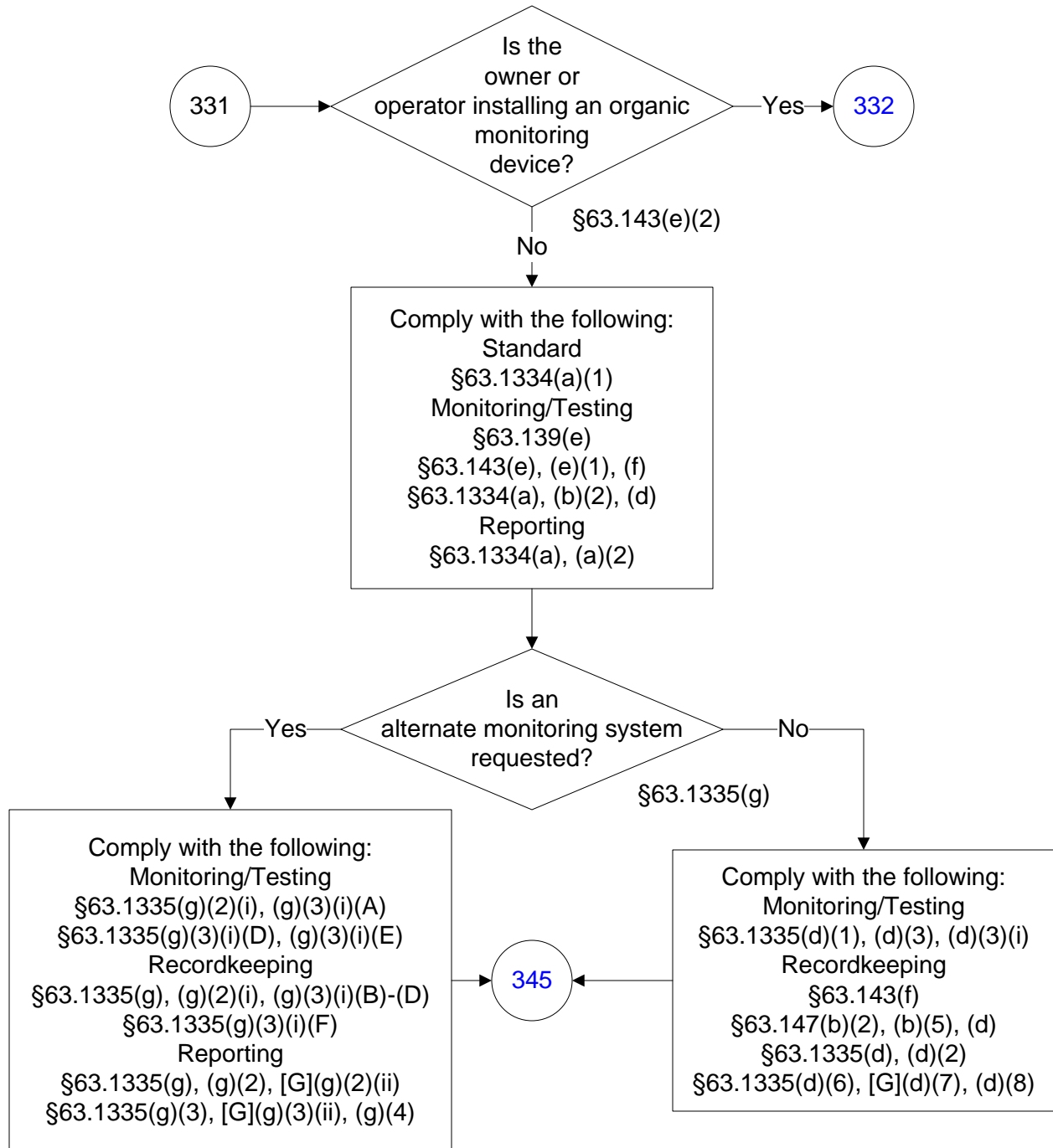

40 CFR Part 63, Subpart JJJ

(134 of 196)

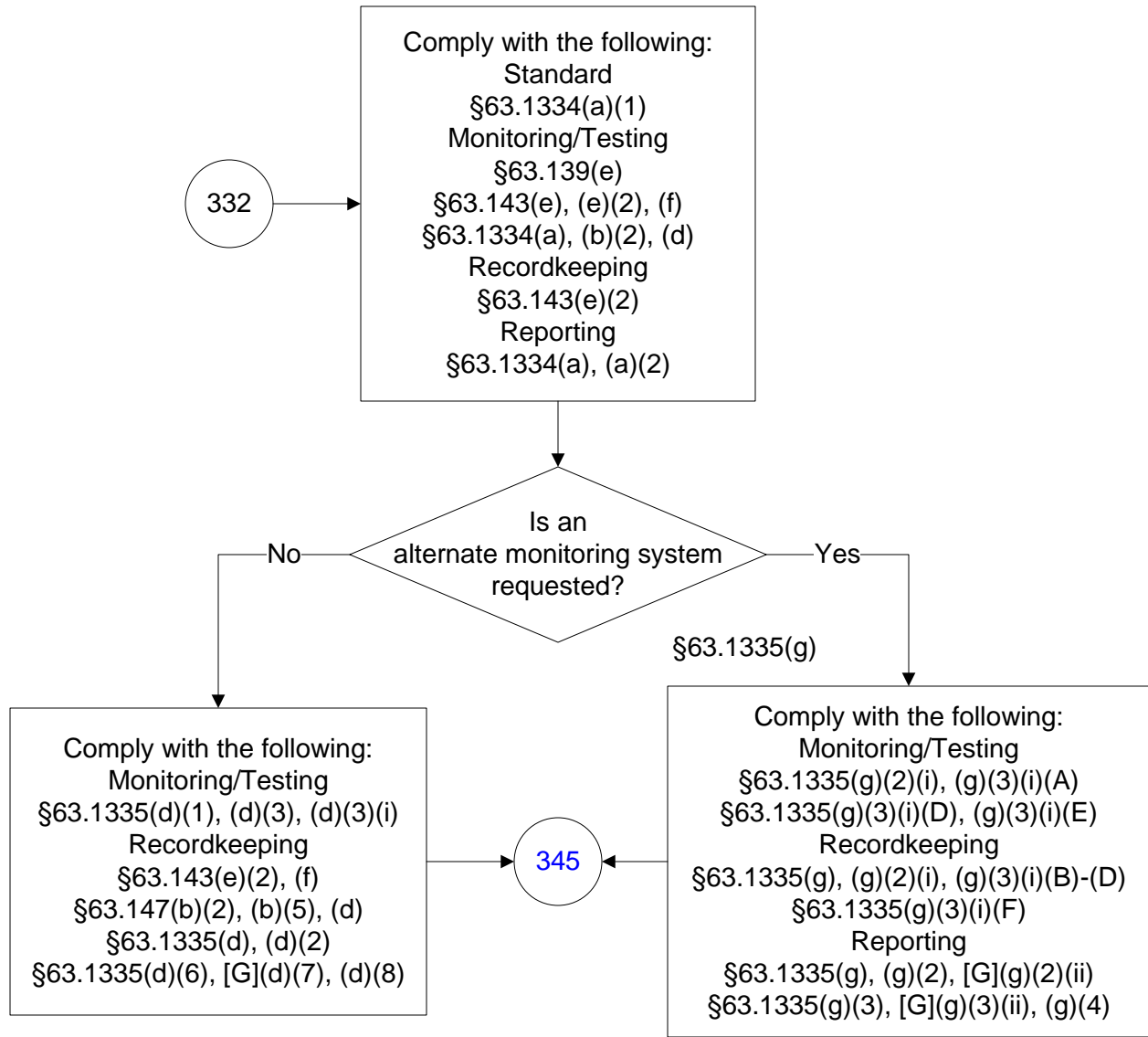

40 CFR Part 63, Subpart JJJ

(135 of 196)

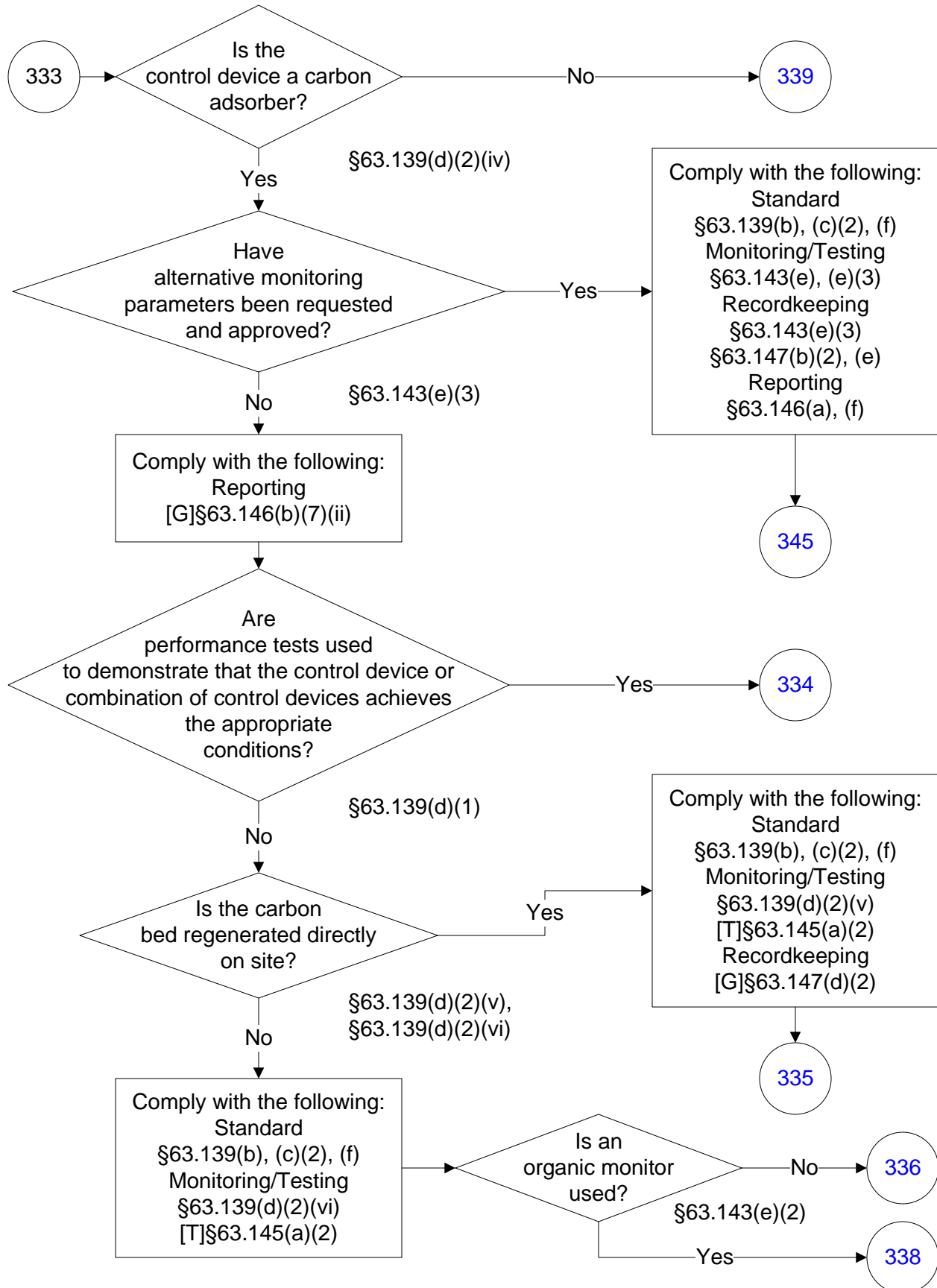

40 CFR Part 63, Subpart JJJ

(136 of 196)

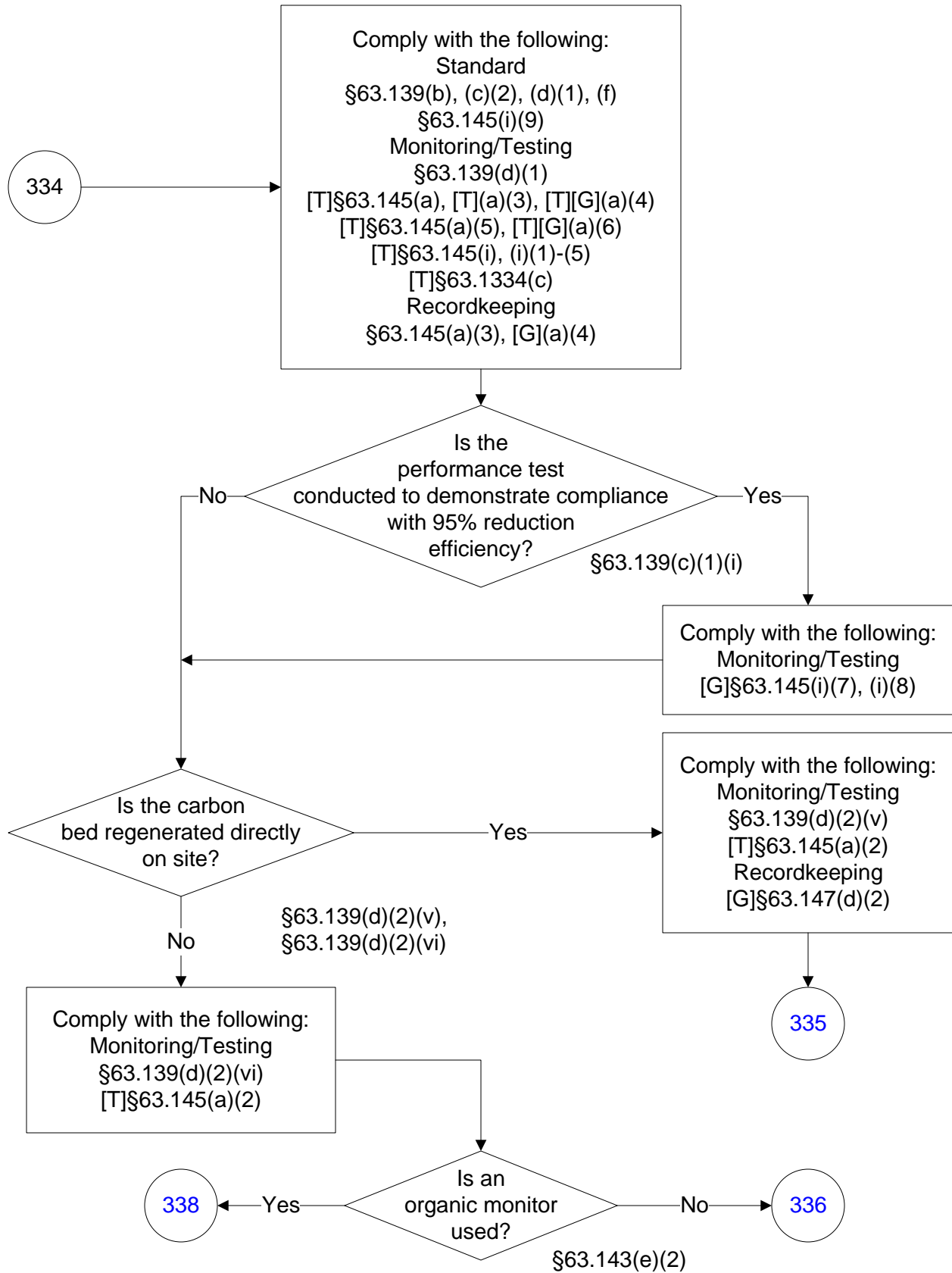

40 CFR Part 63, Subpart JJJ

(137 of 196)

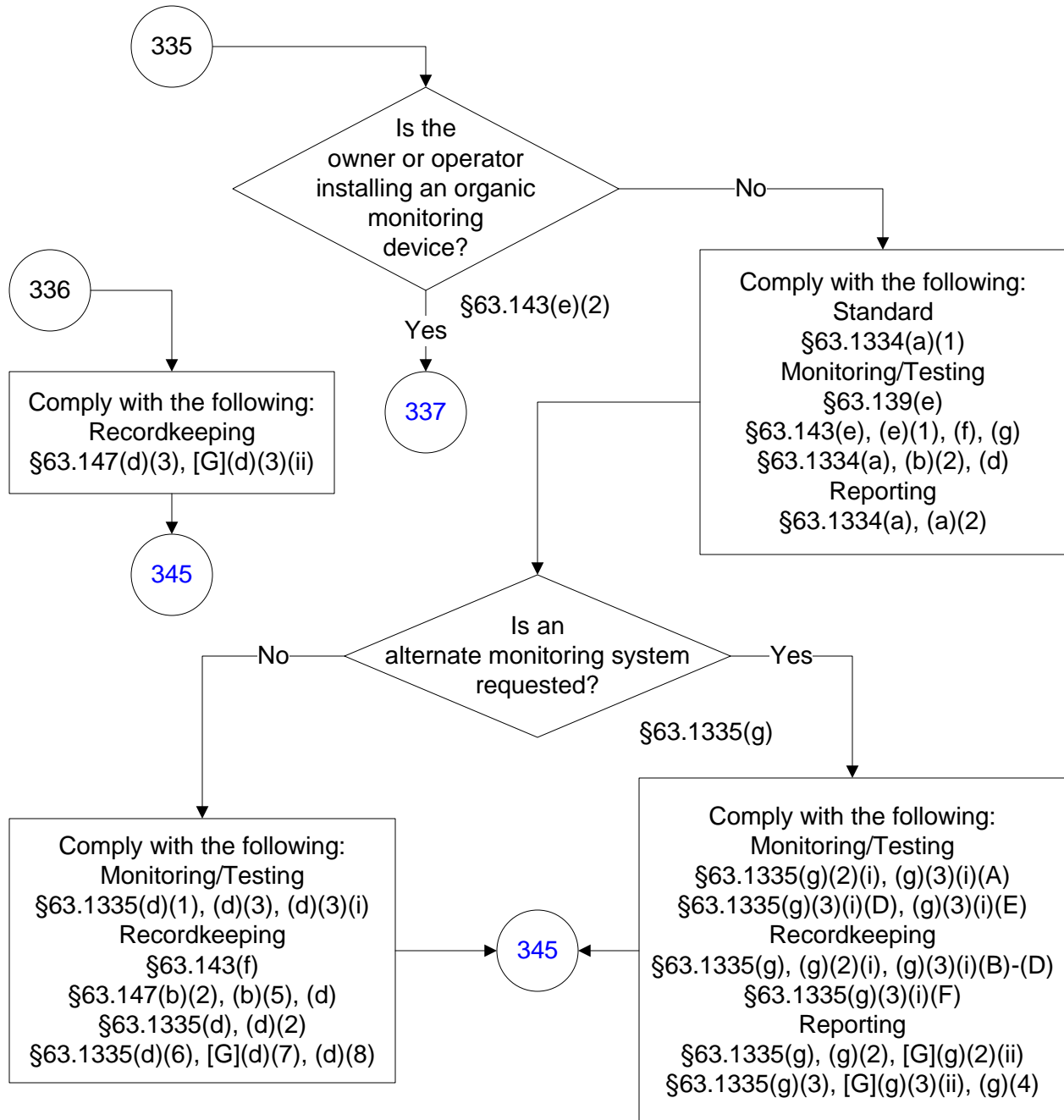

40 CFR Part 63, Subpart JJJ

(138 of 196)

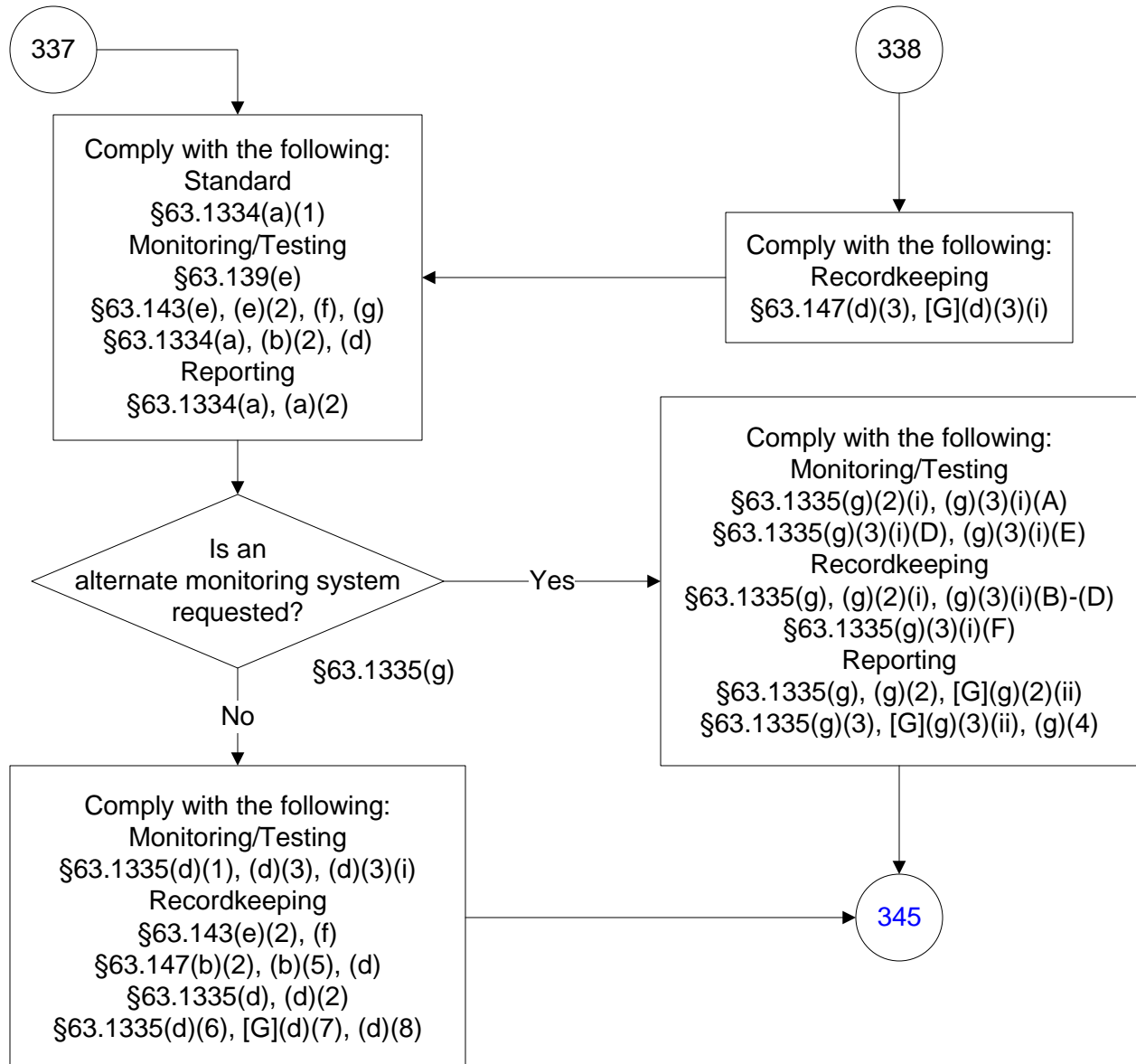

40 CFR Part 63, Subpart JJJ

(139 of 196)

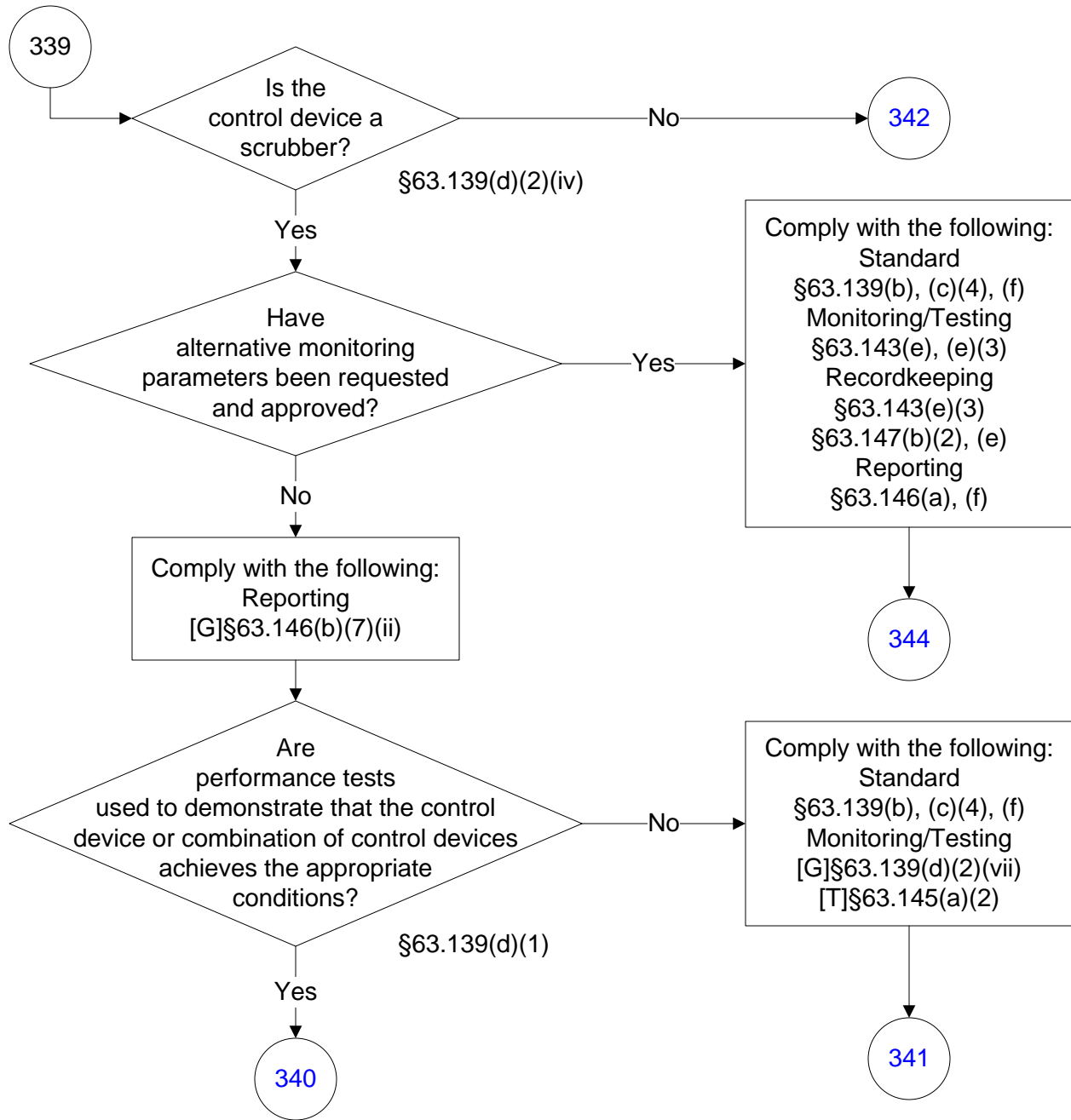

40 CFR Part 63, Subpart JJJ

(140 of 196)

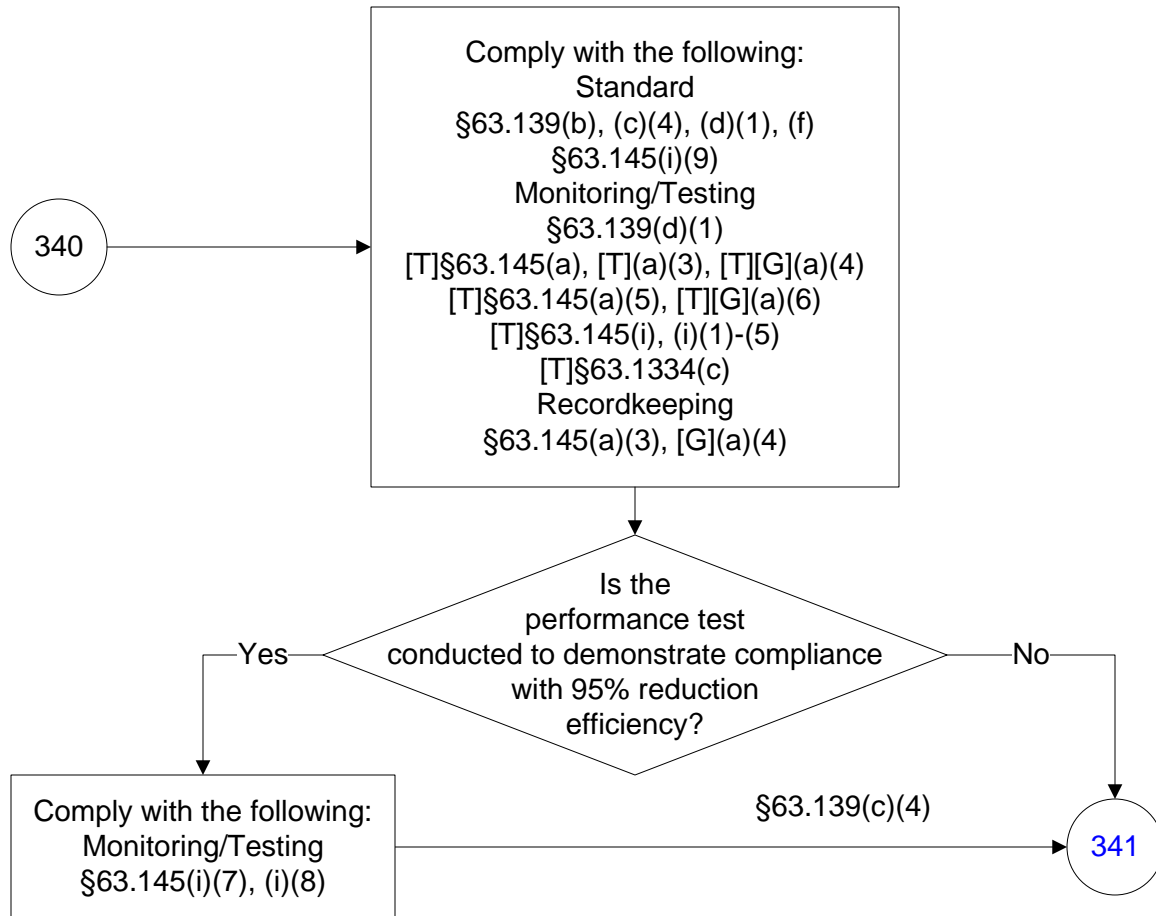

40 CFR Part 63, Subpart JJJ

(141 of 196)

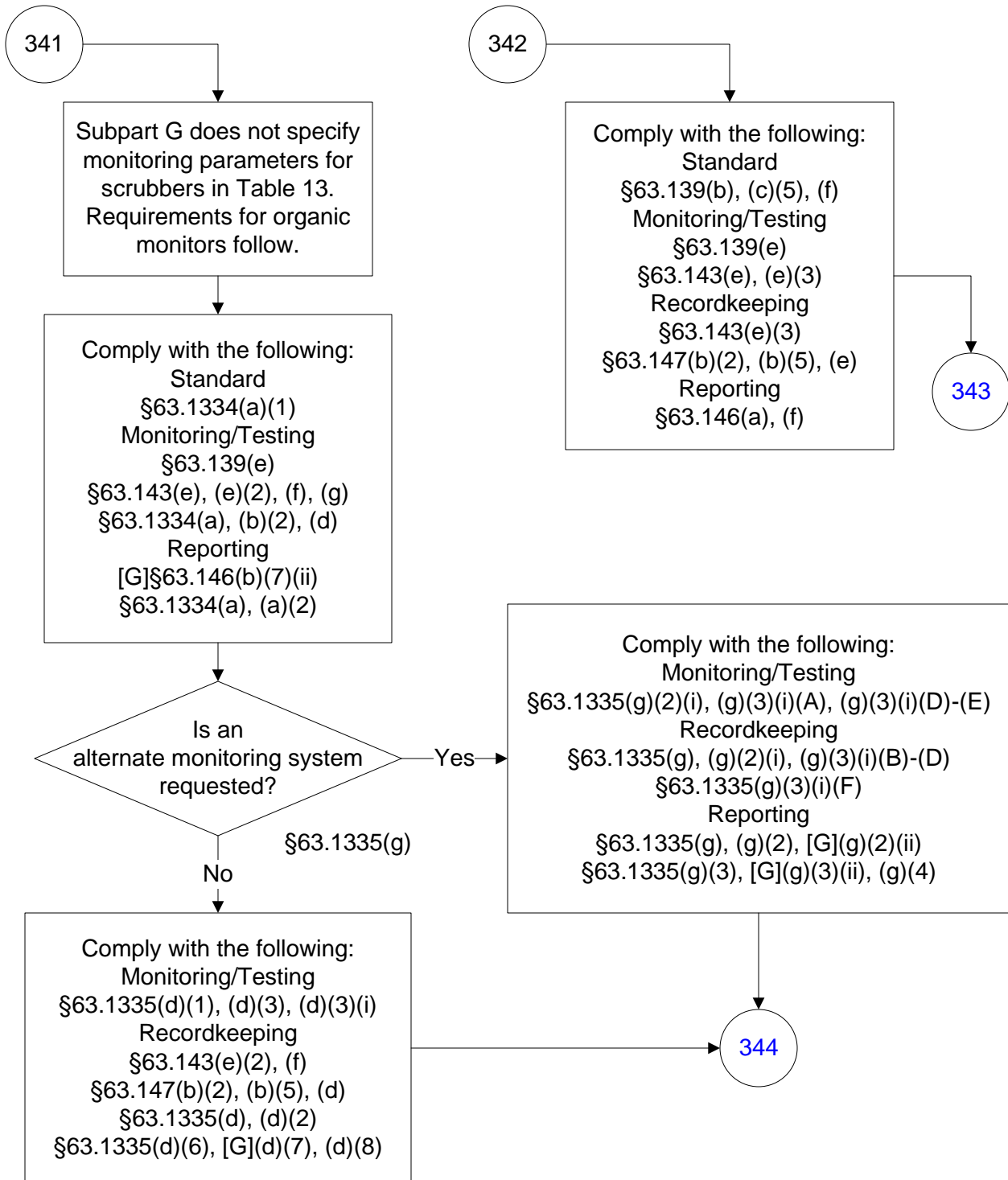

40 CFR Part 63, Subpart JJJ

(142 of 196)

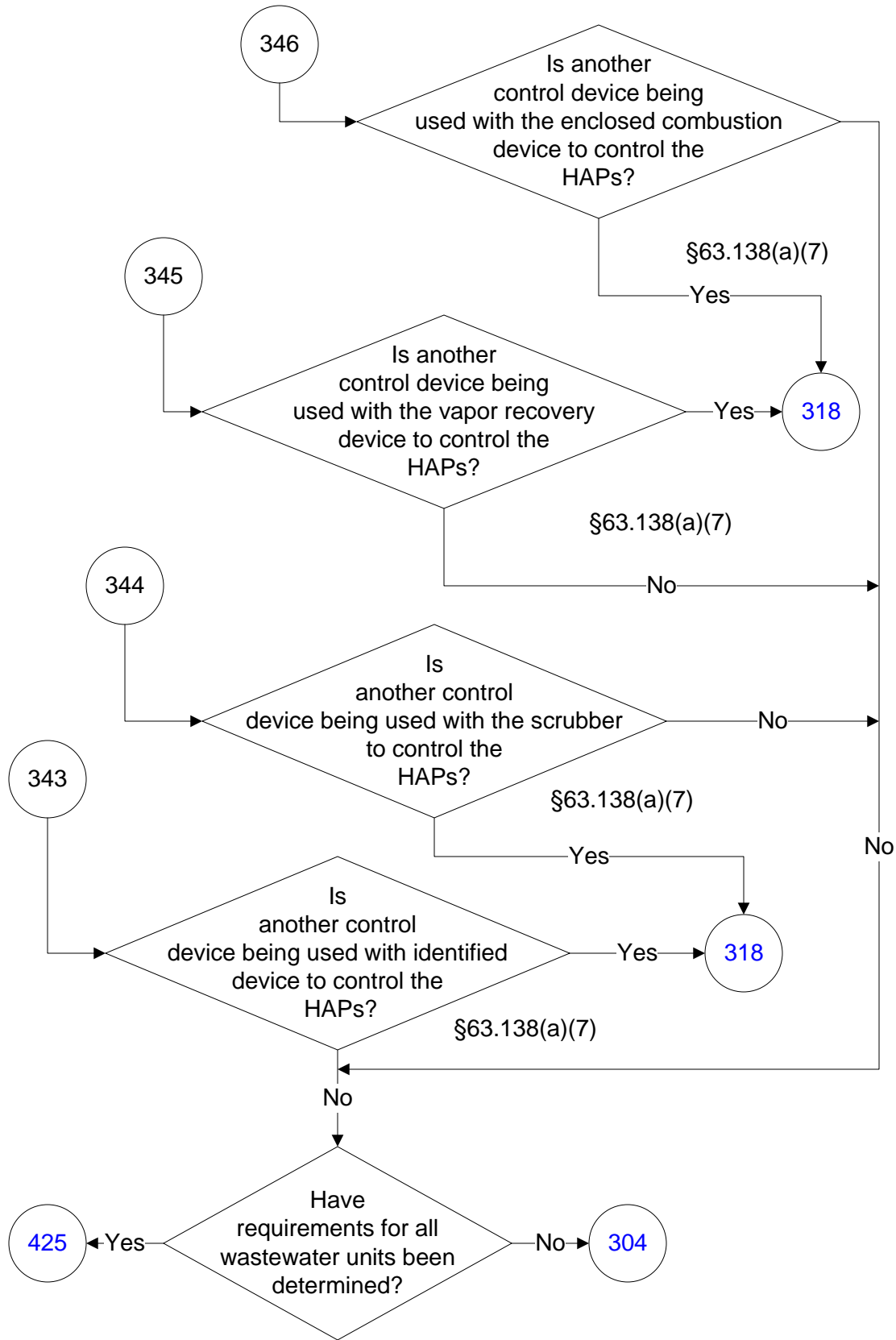

40 CFR Part 63, Subpart JJJ

(143 of 196)

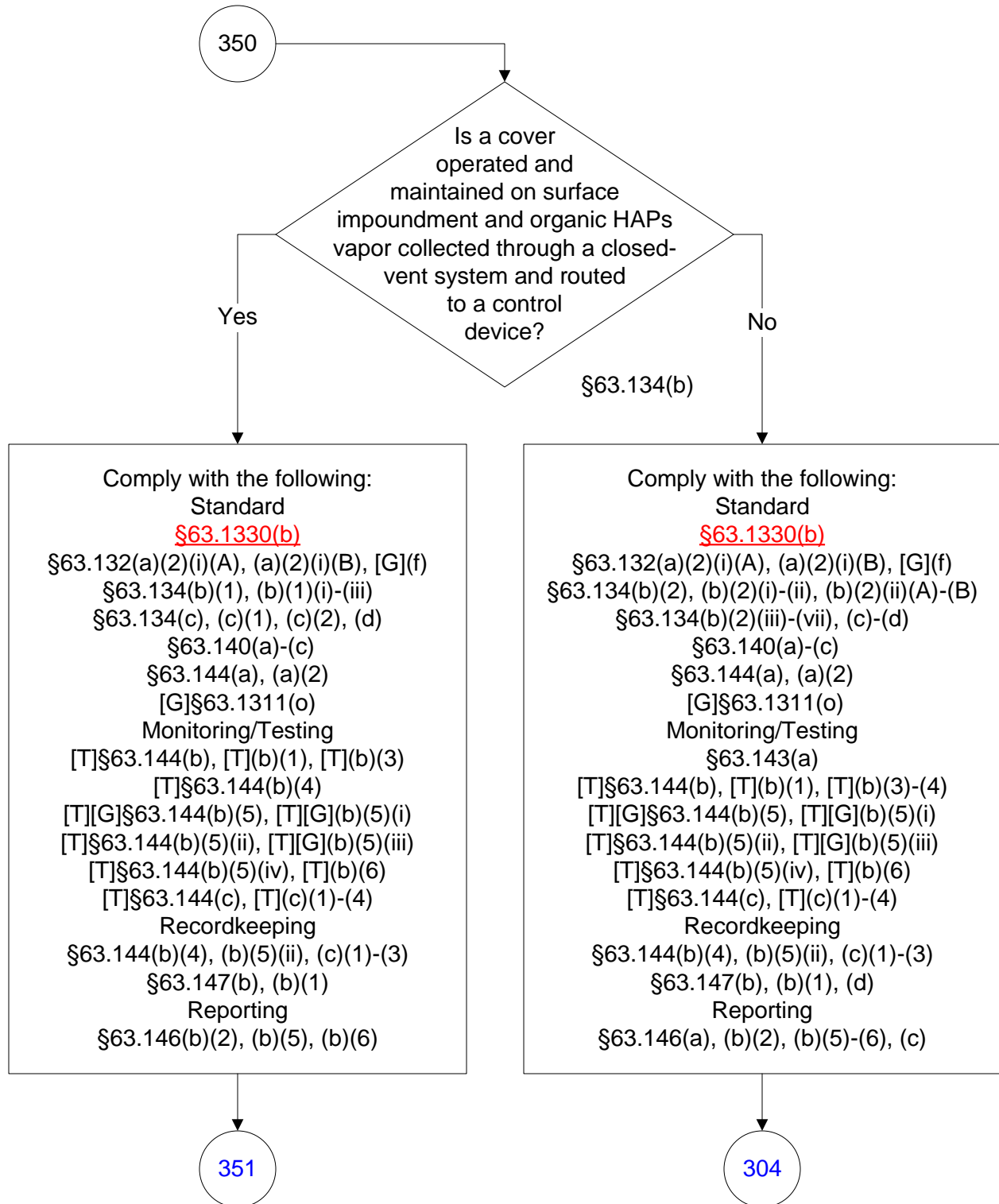

40 CFR Part 63, Subpart JJJ

(144 of 196)

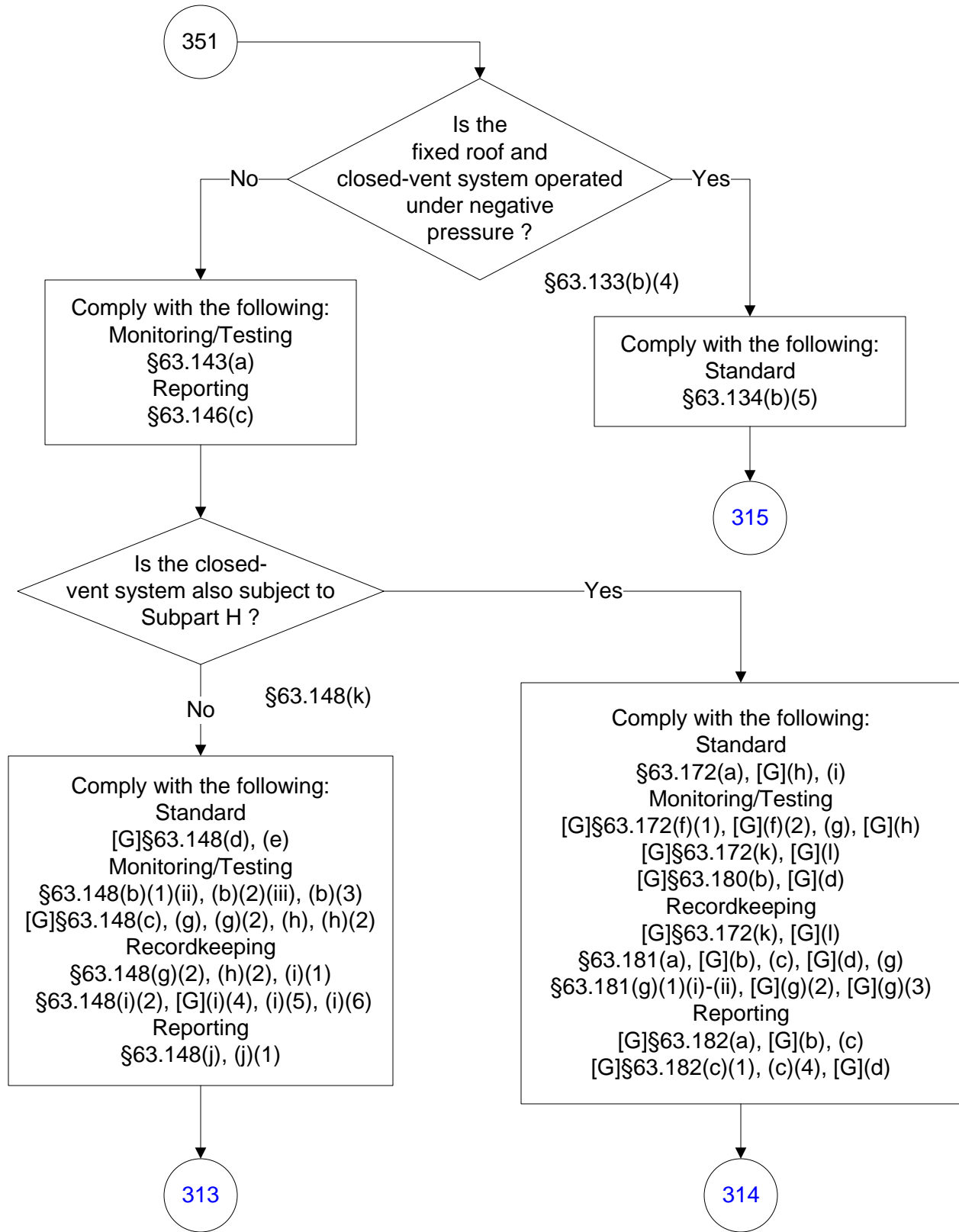

40 CFR Part 63, Subpart JJJ

(145 of 196)

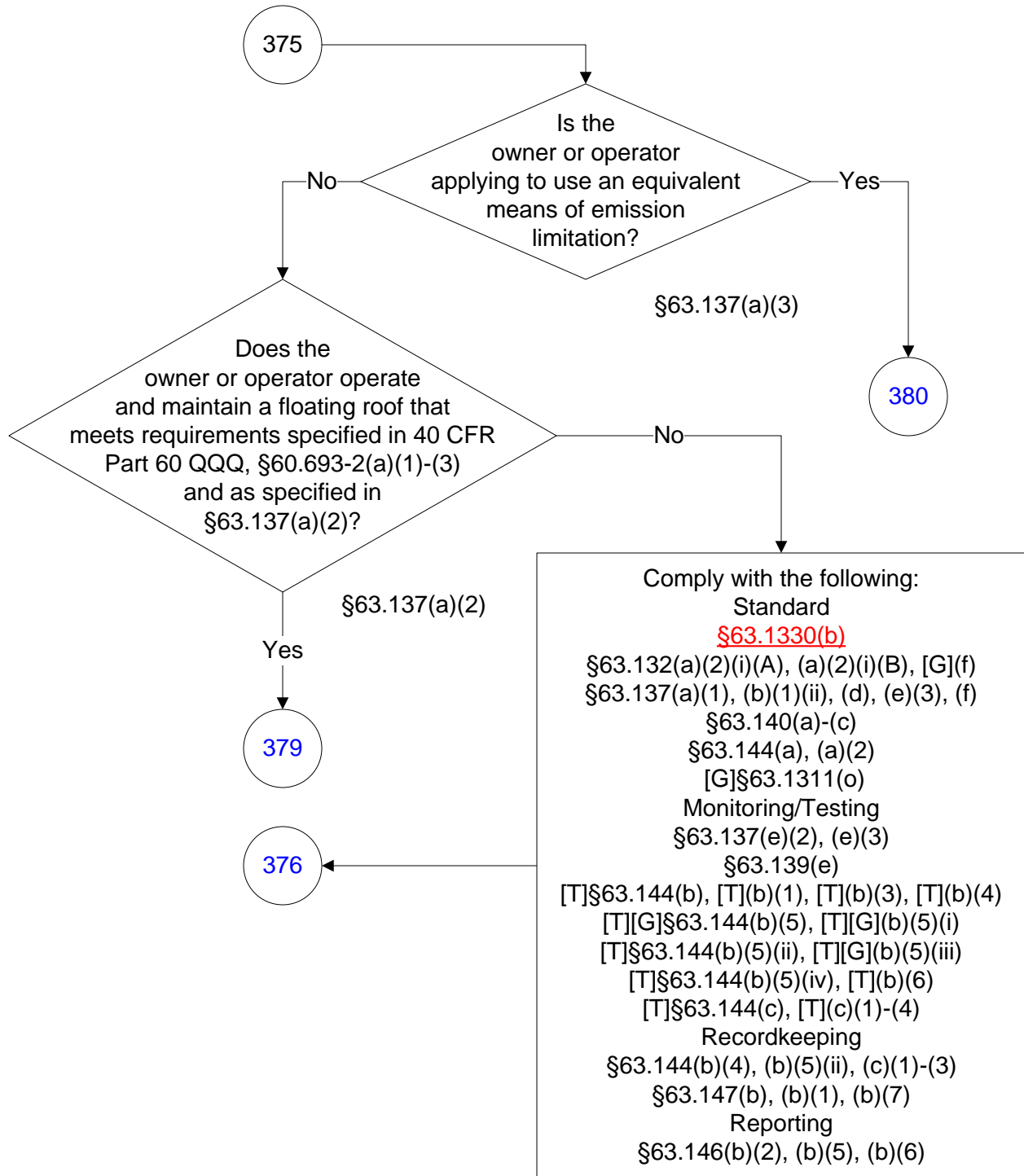

40 CFR Part 63, Subpart JJJ

(146 of 196)

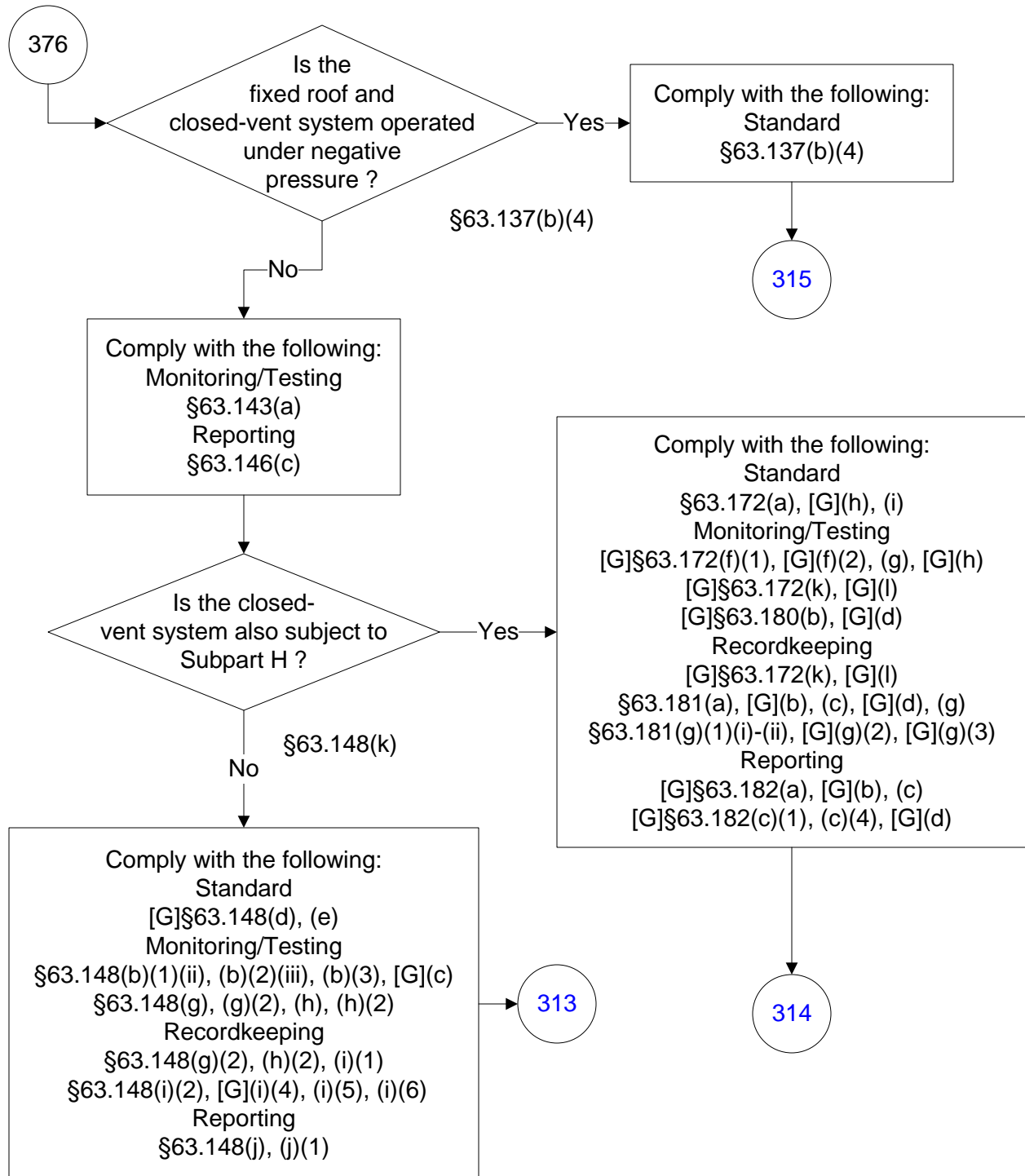

40 CFR Part 63, Subpart JJJ

(147 of 196)

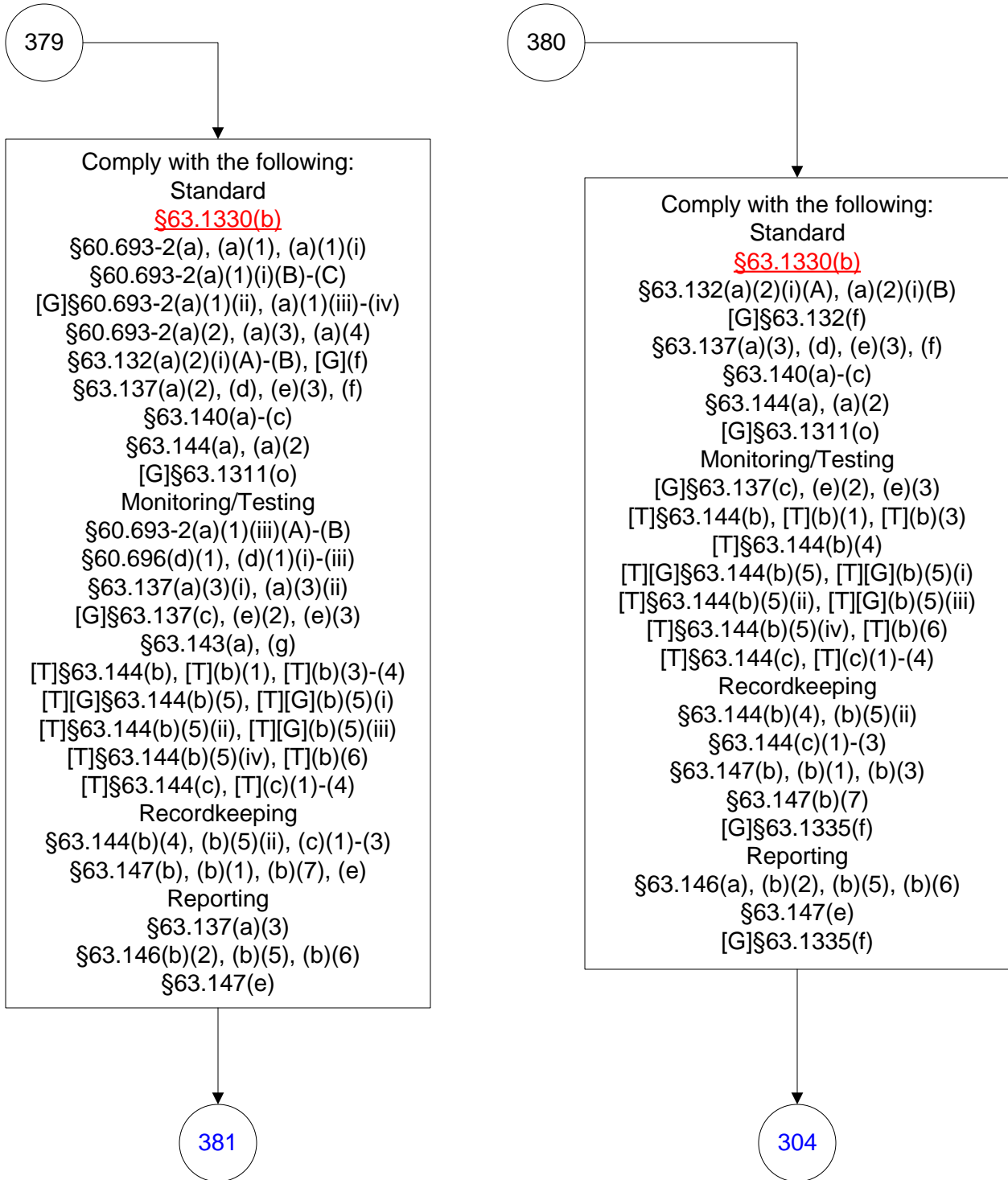

40 CFR Part 63, Subpart JJJ

(148 of 196)

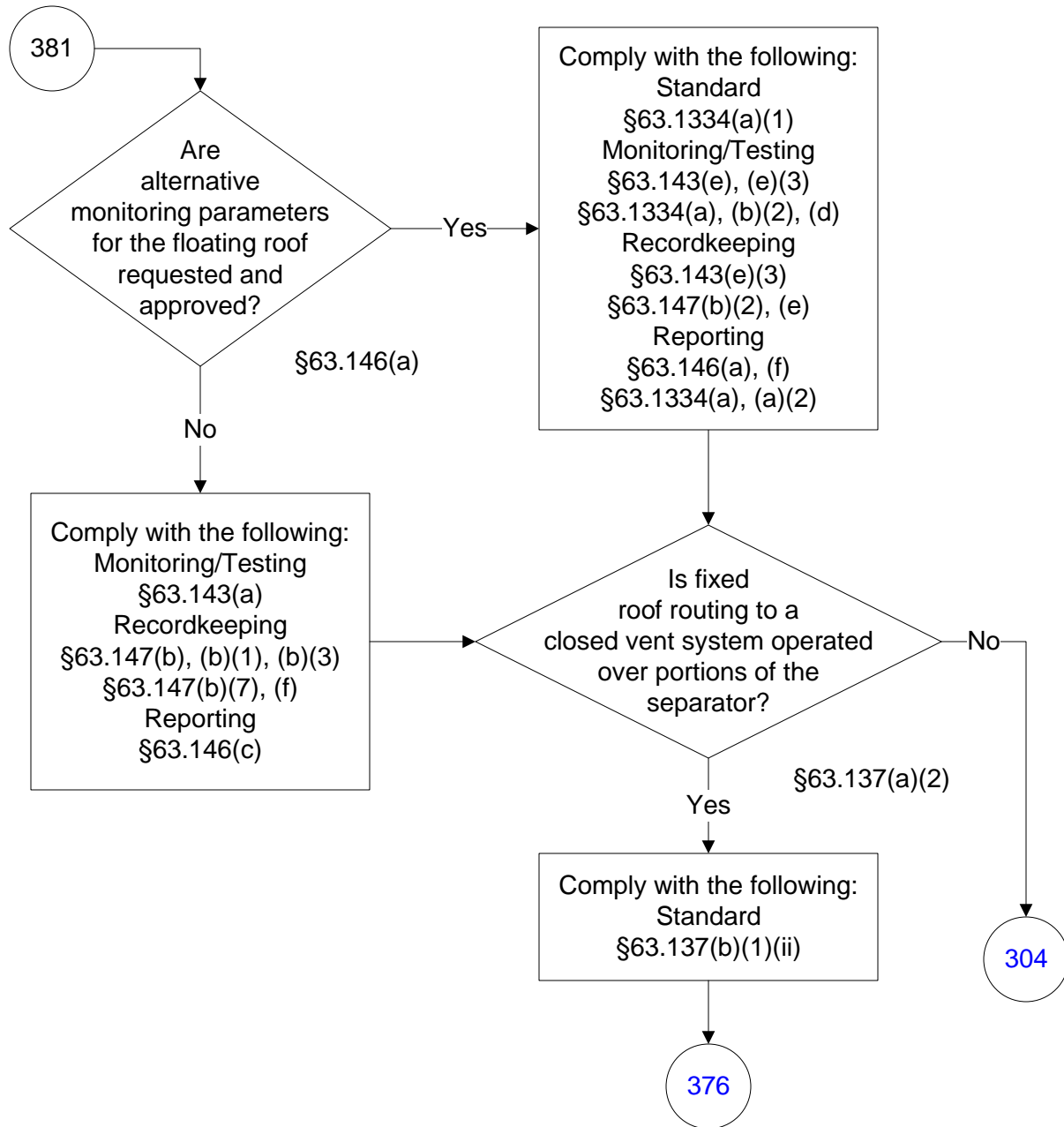

40 CFR Part 63, Subpart JJJ

(149 of 196)

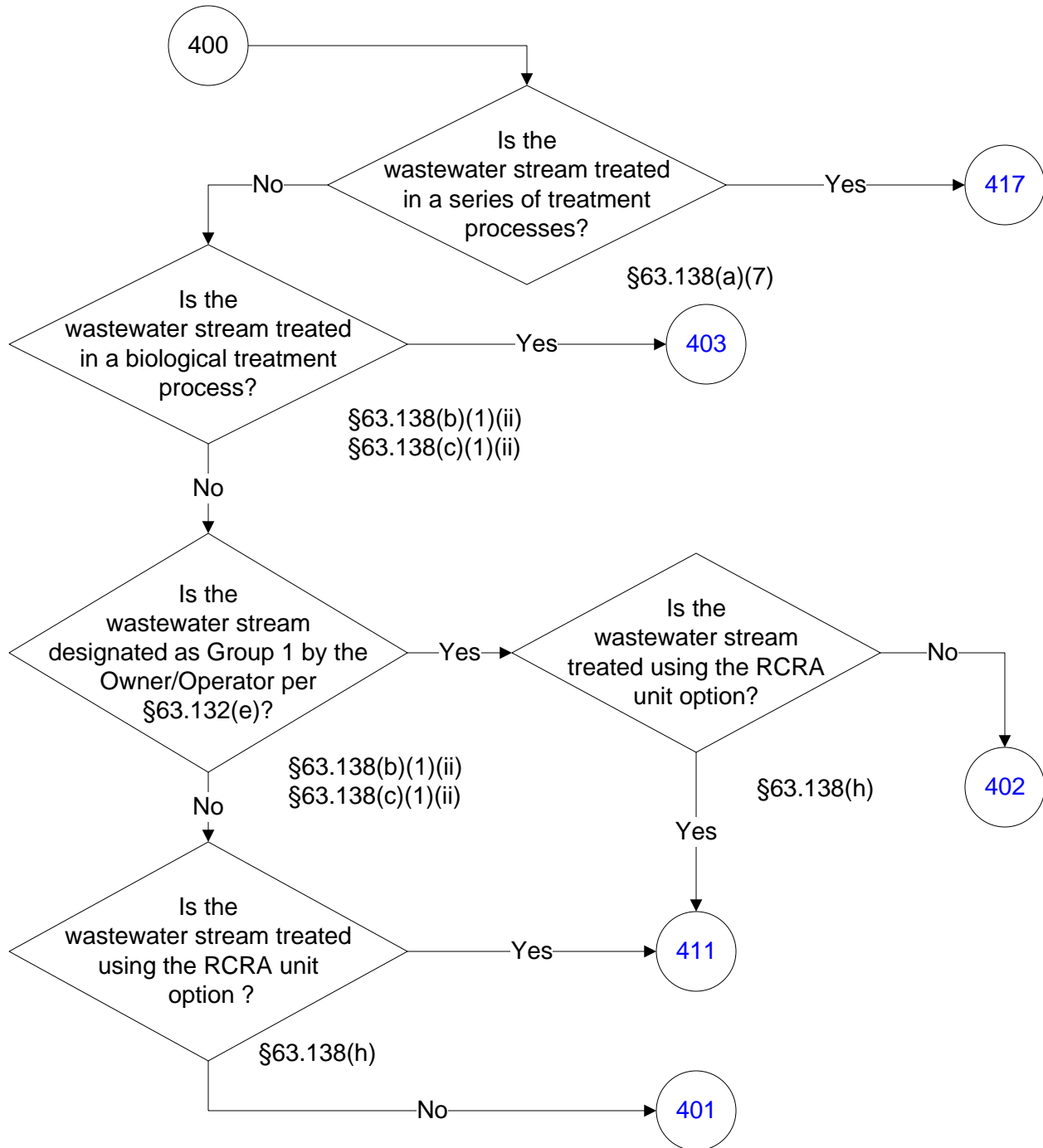

40 CFR Part 63, Subpart JJJ

(150 of 196)

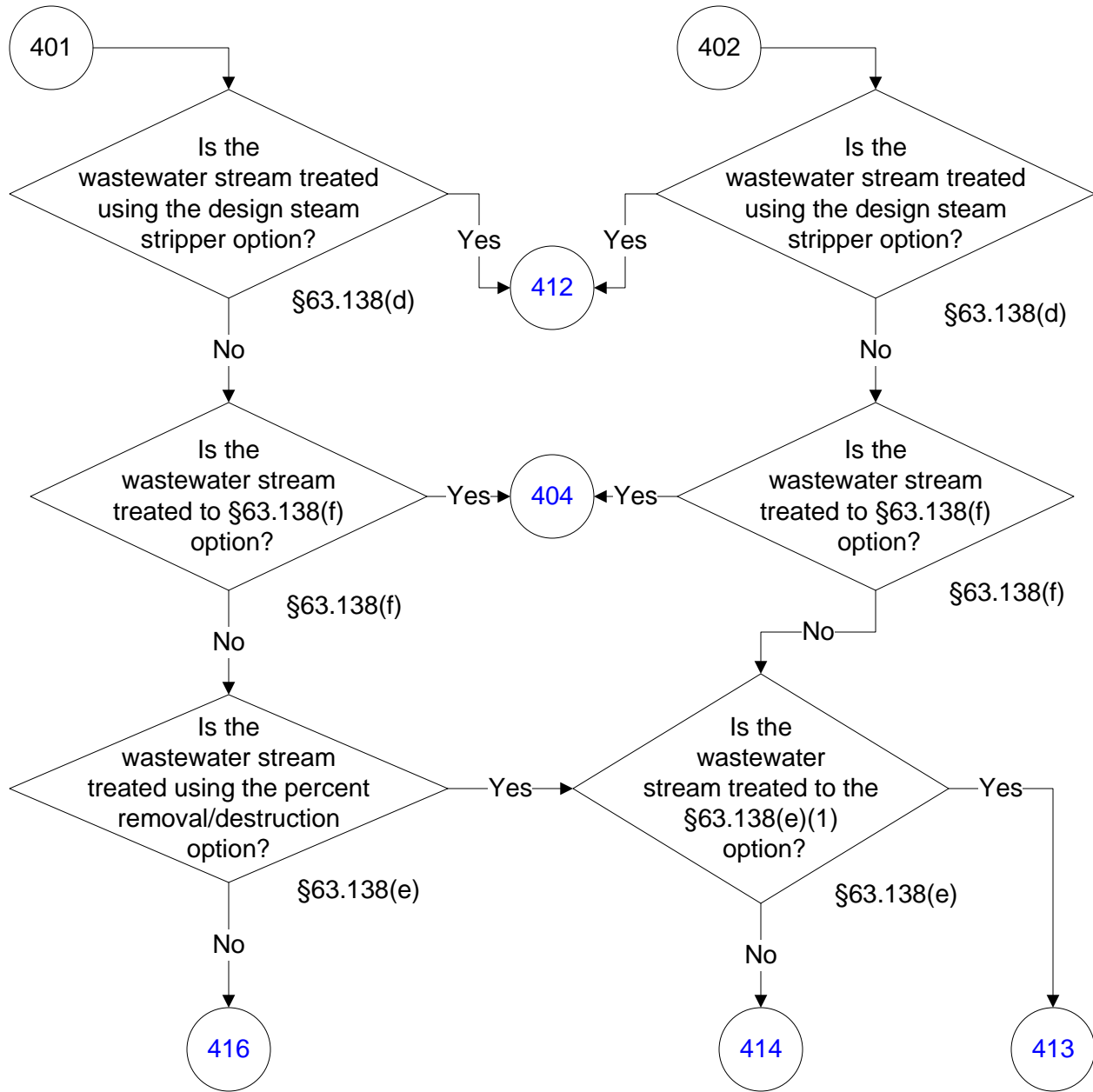

40 CFR Part 63, Subpart JJJ

(151 of 196)

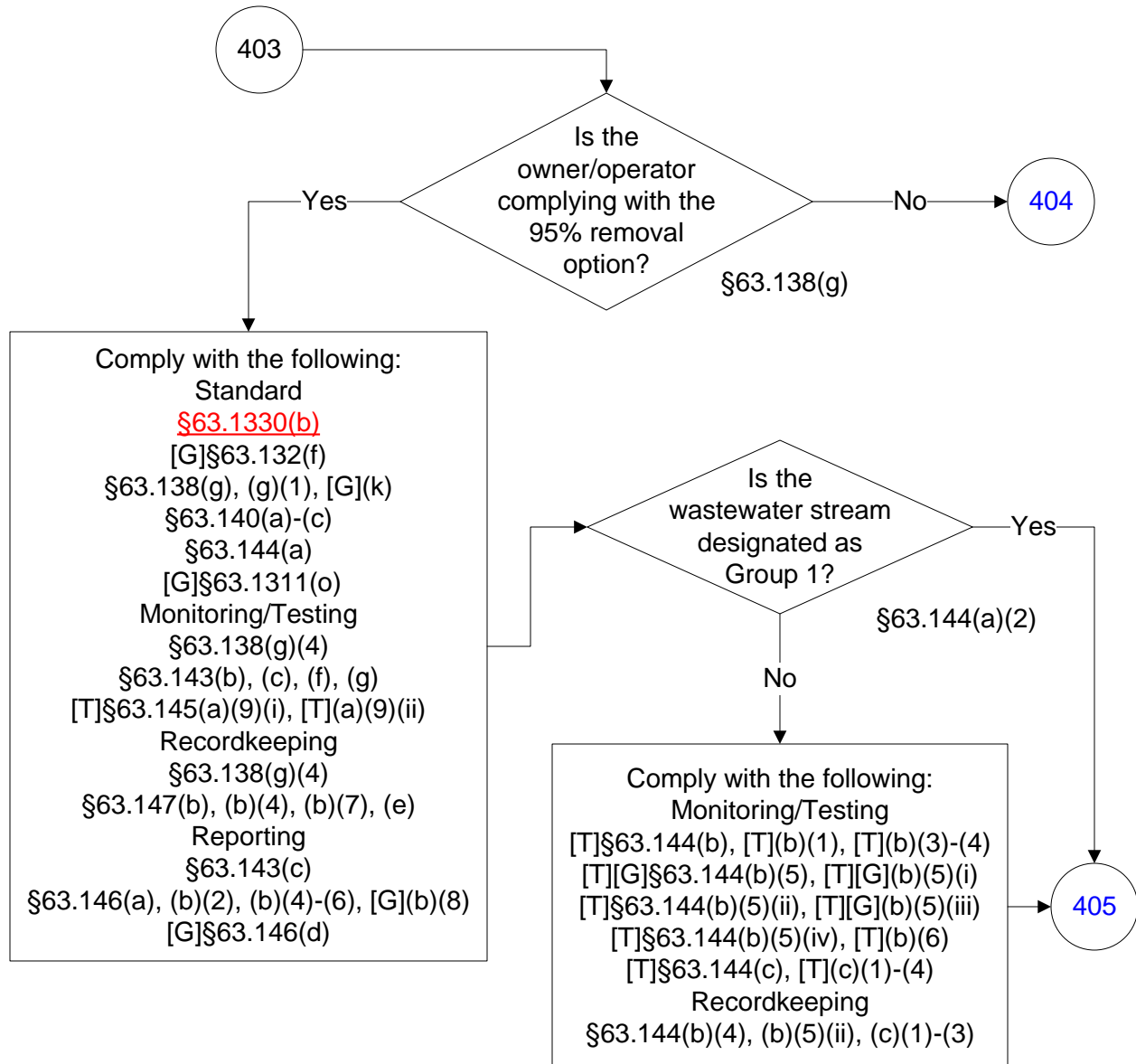

40 CFR Part 63, Subpart JJJ

(152 of 196)

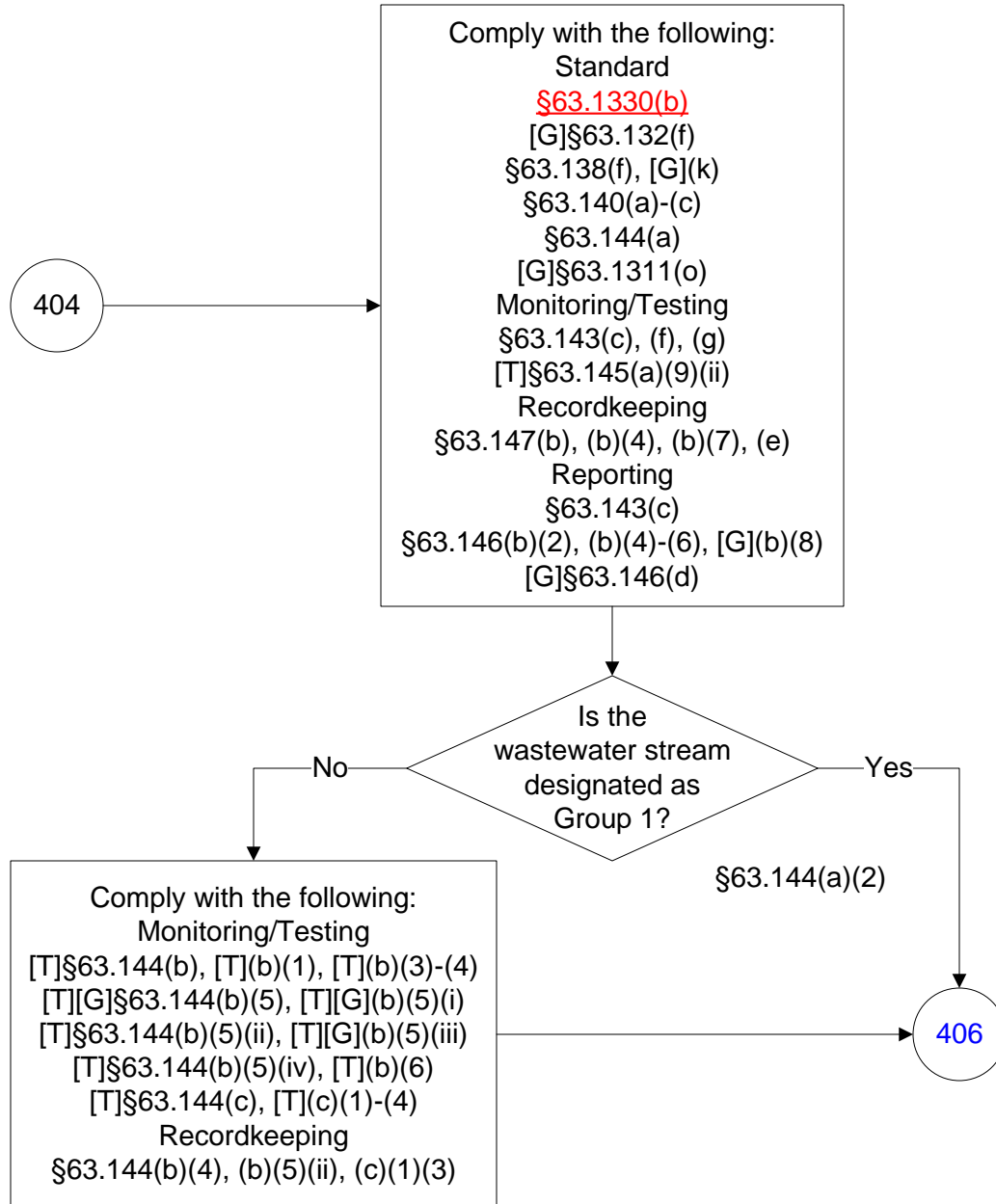

40 CFR Part 63, Subpart JJJ

(153 of 196)

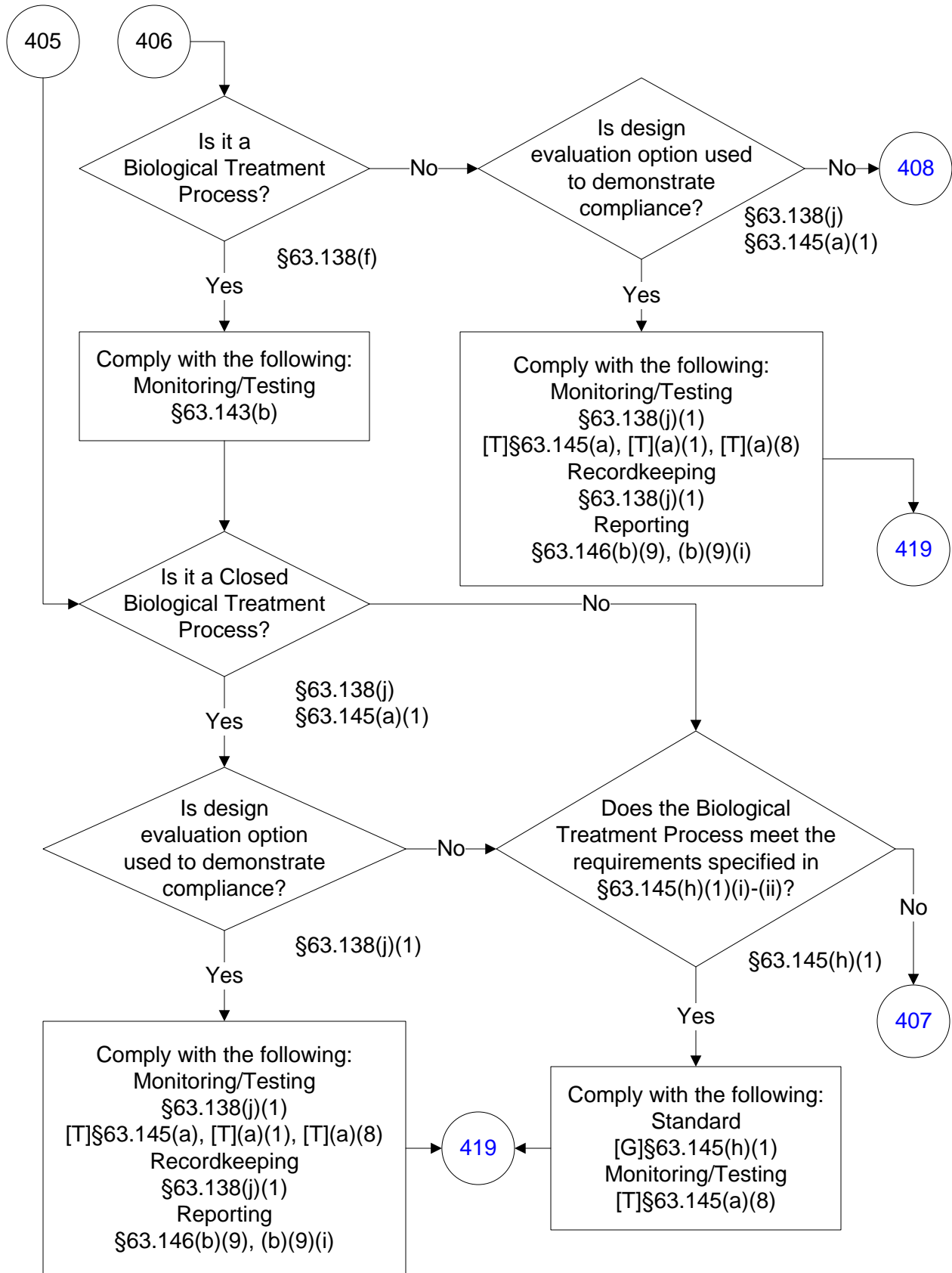

40 CFR Part 63, Subpart JJJ

(154 of 196)

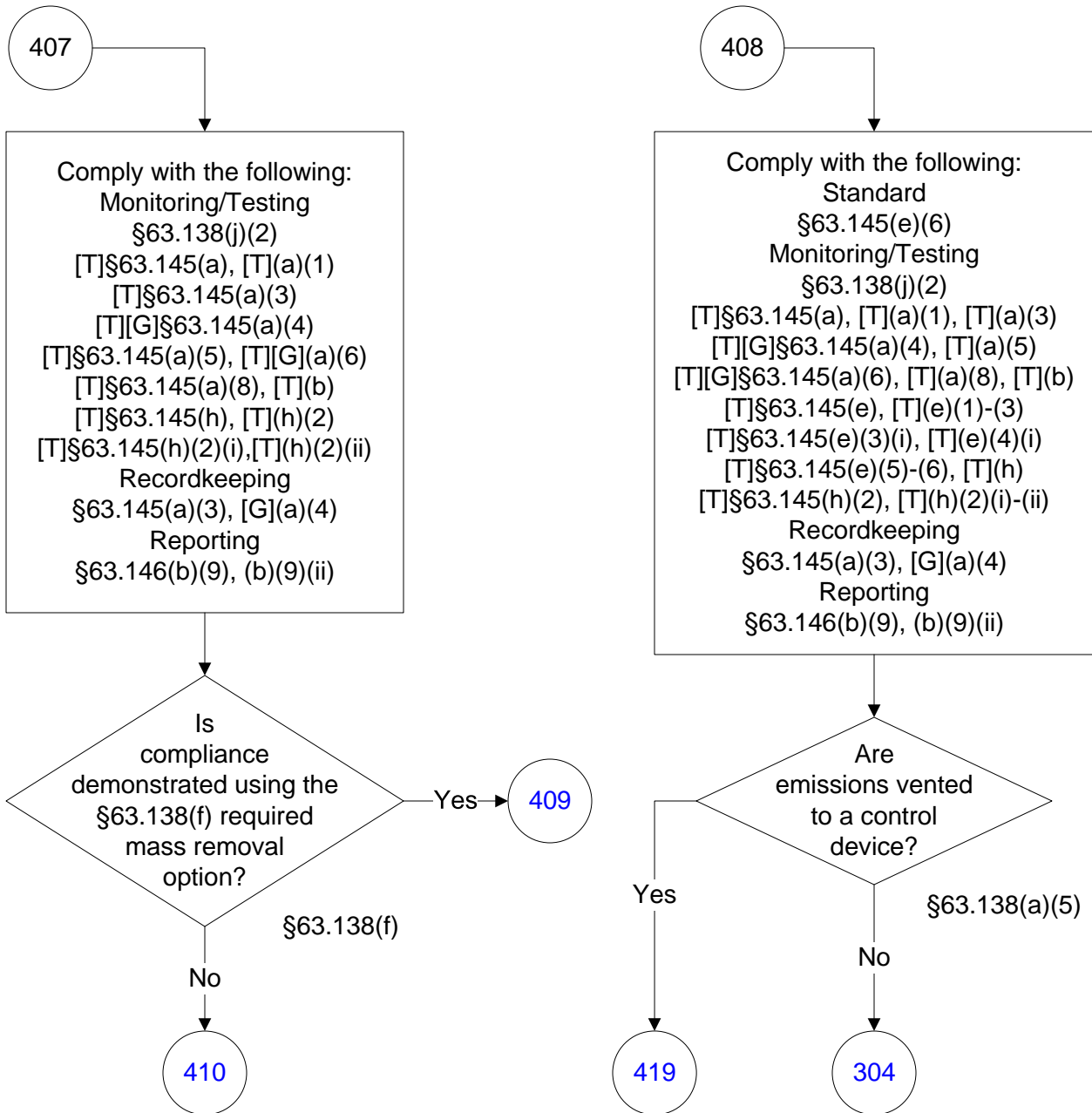

40 CFR Part 63, Subpart JJJ

(155 of 196)

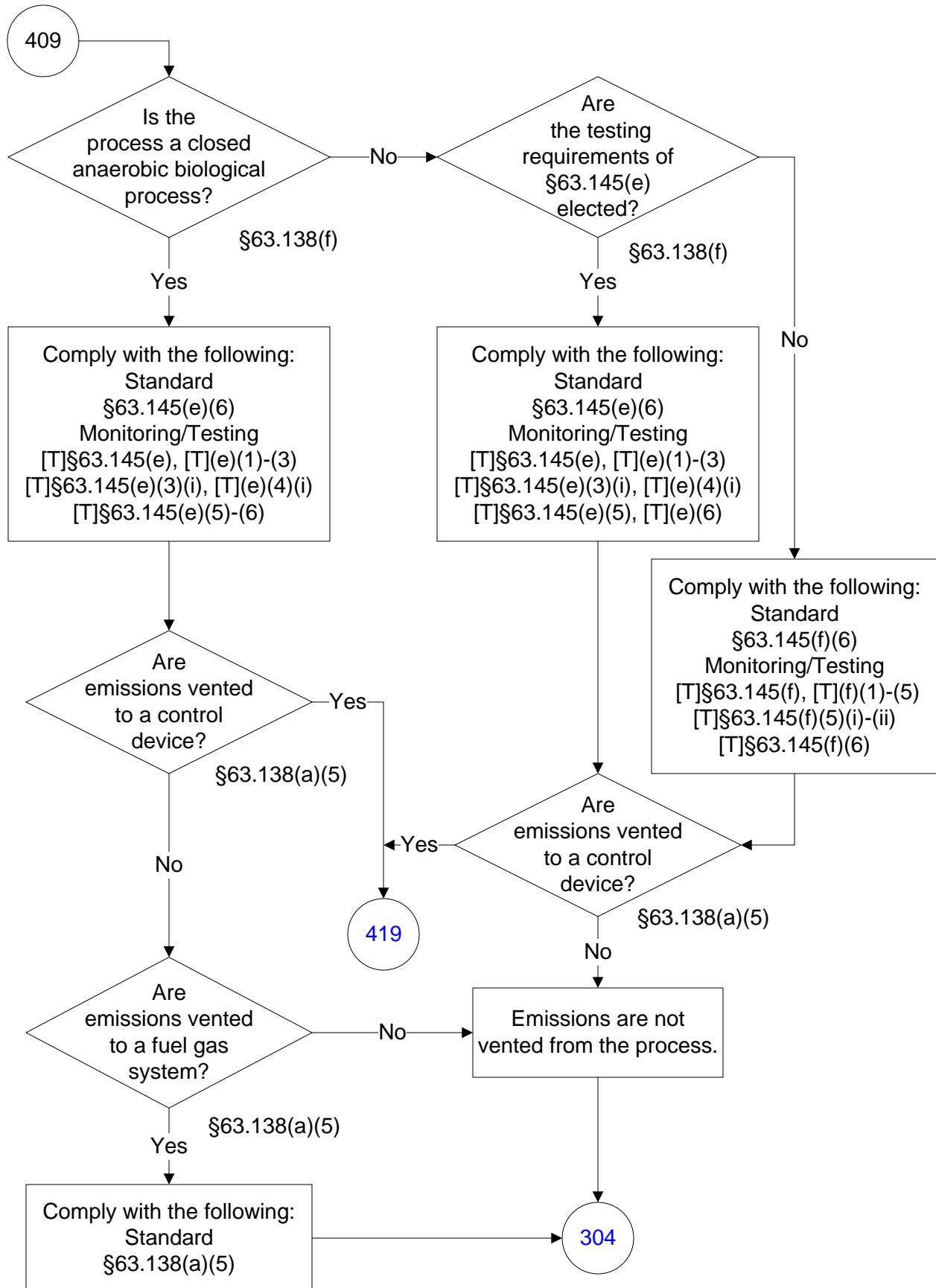

40 CFR Part 63, Subpart JJJ

(156 of 196)

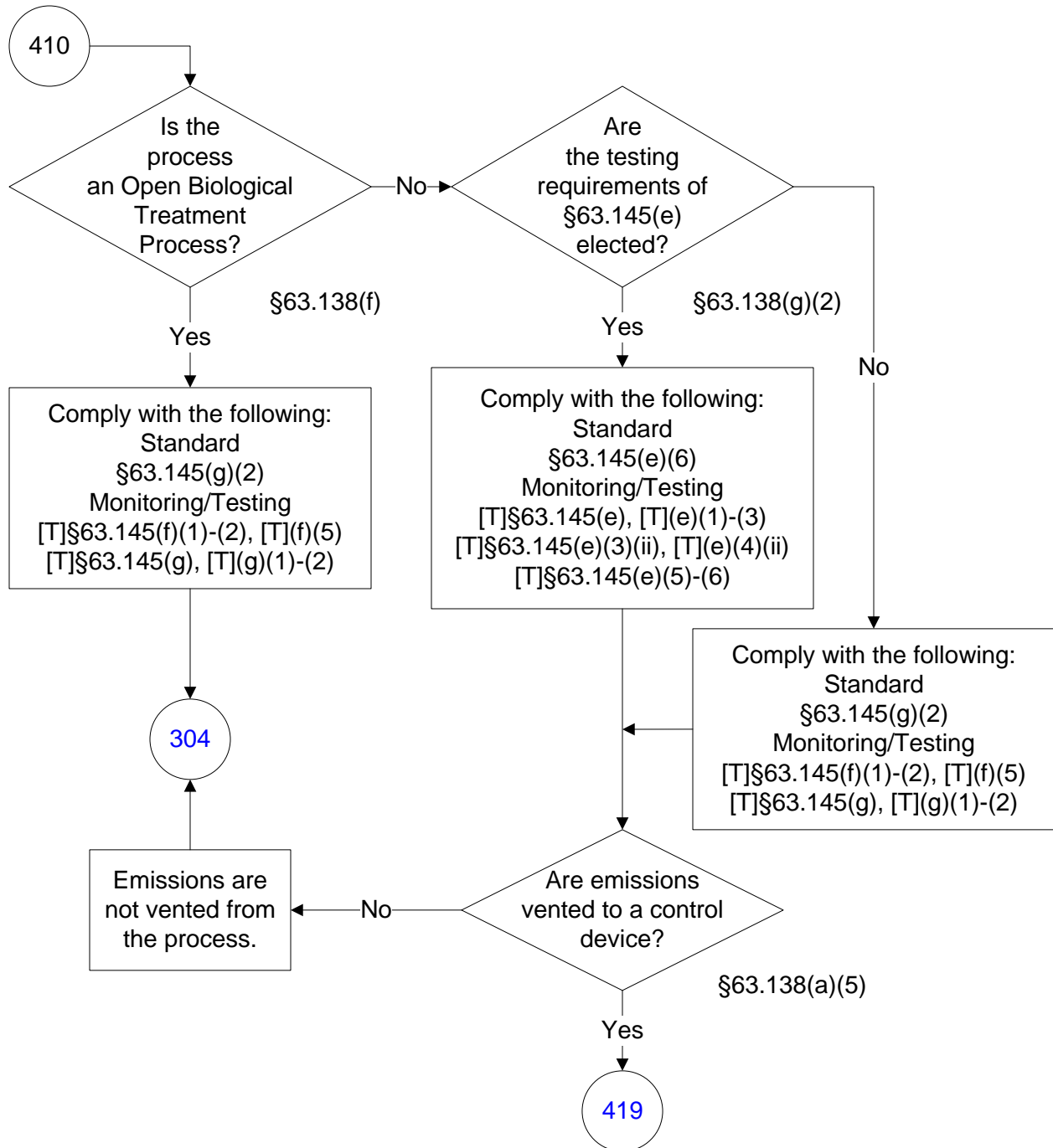

40 CFR Part 63, Subpart JJJ

(157 of 196)

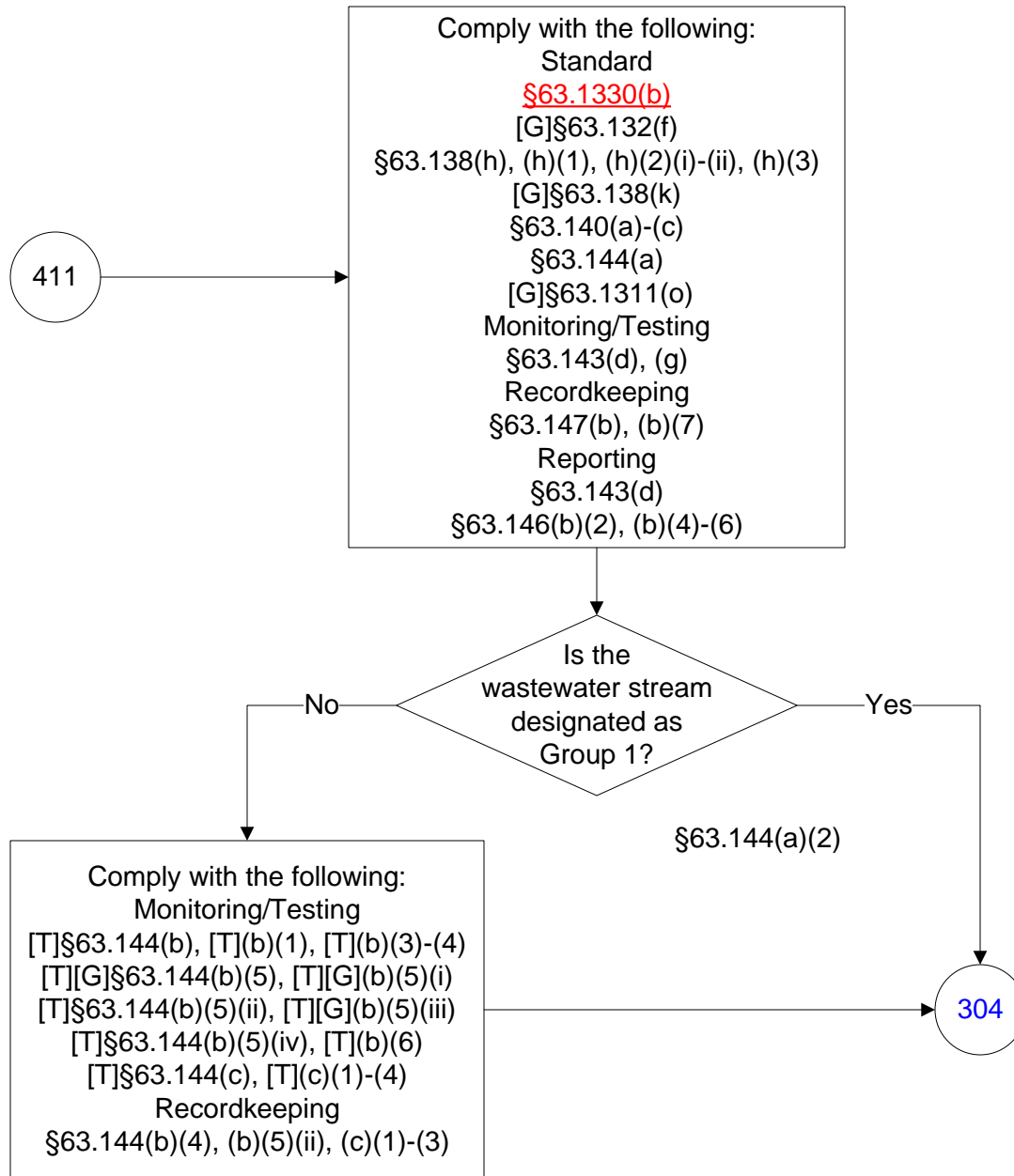

40 CFR Part 63, Subpart JJJ
(158 of 196)

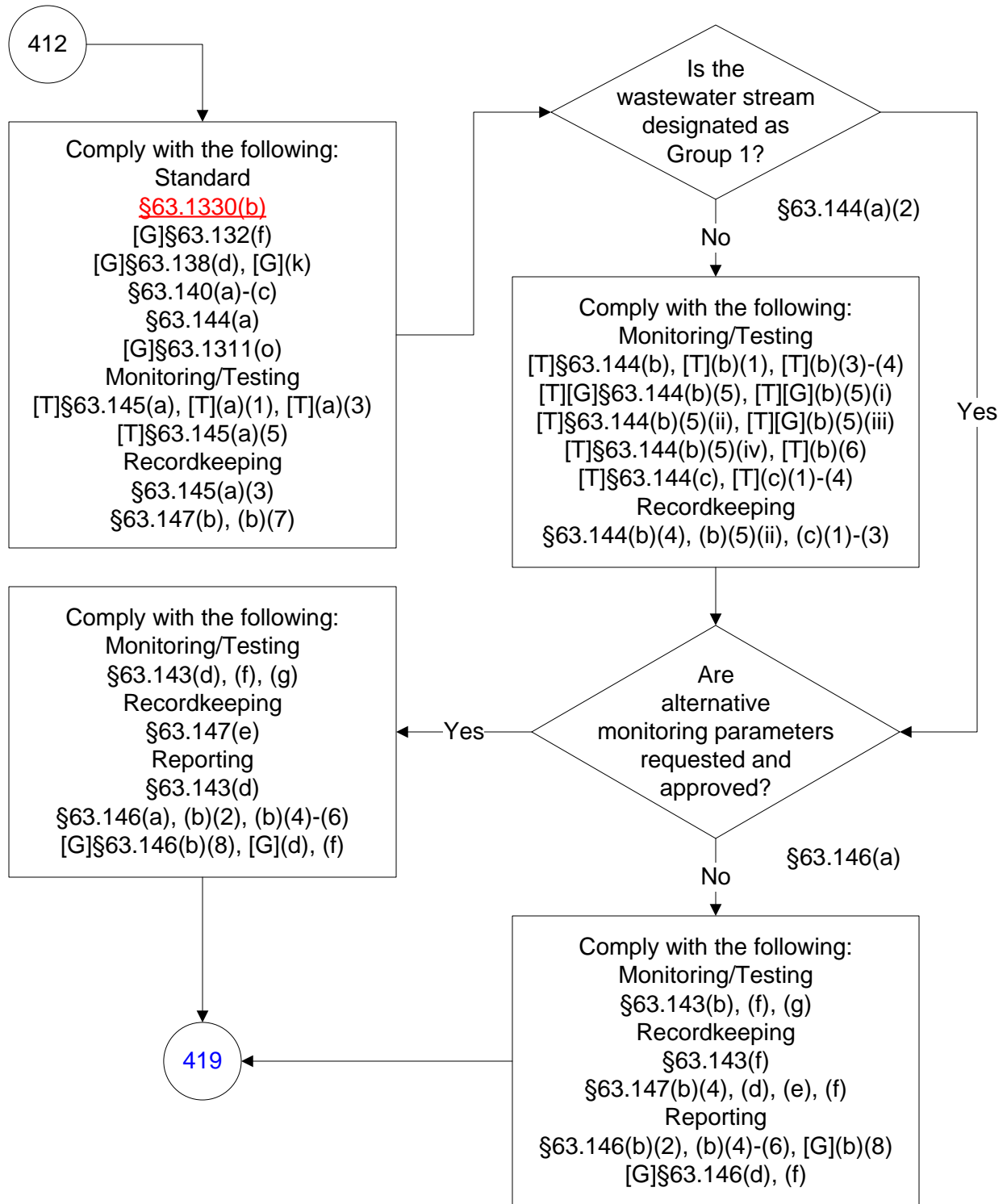

40 CFR Part 63, Subpart JJJ

(159 of 196)

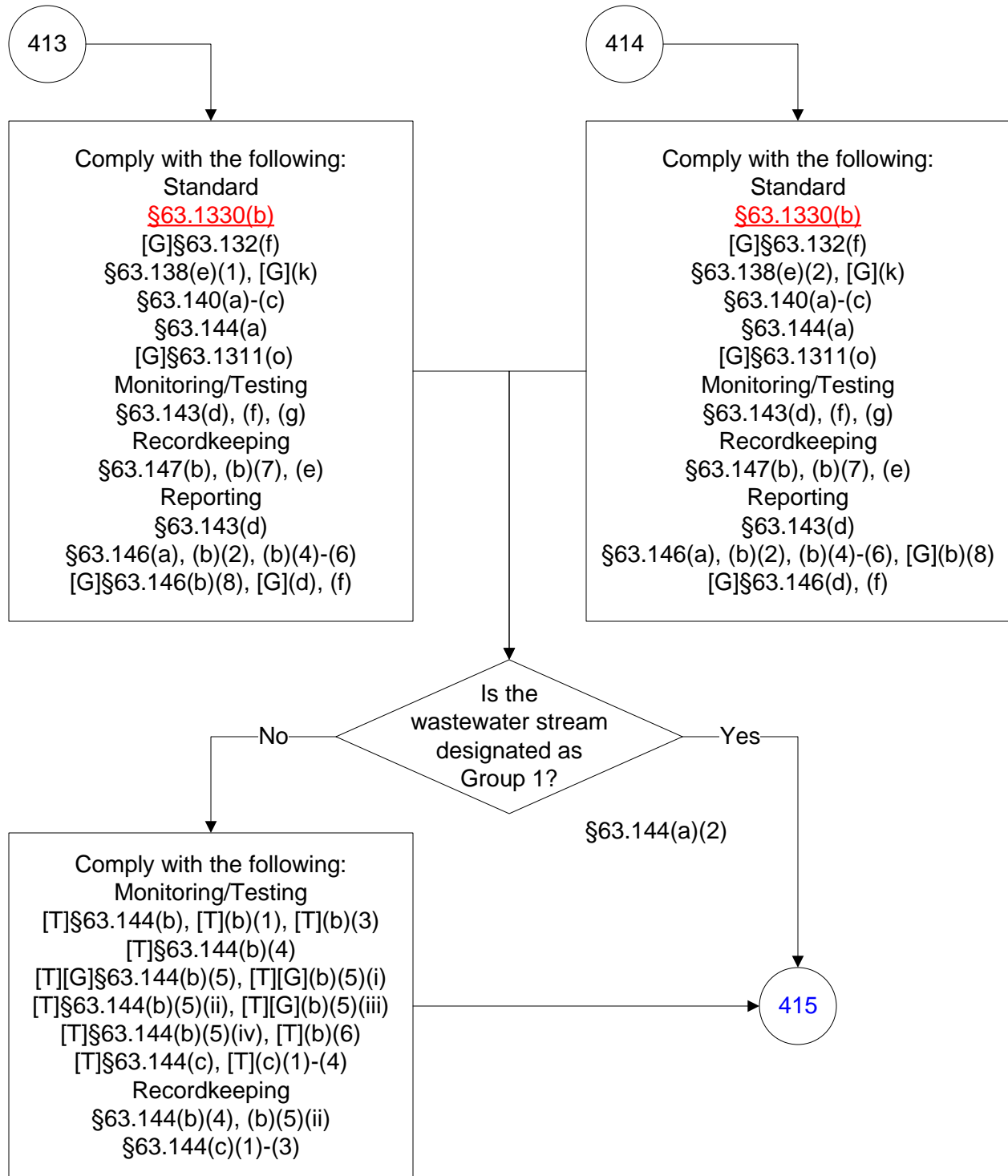

40 CFR Part 63, Subpart JJJ

(160 of 196)

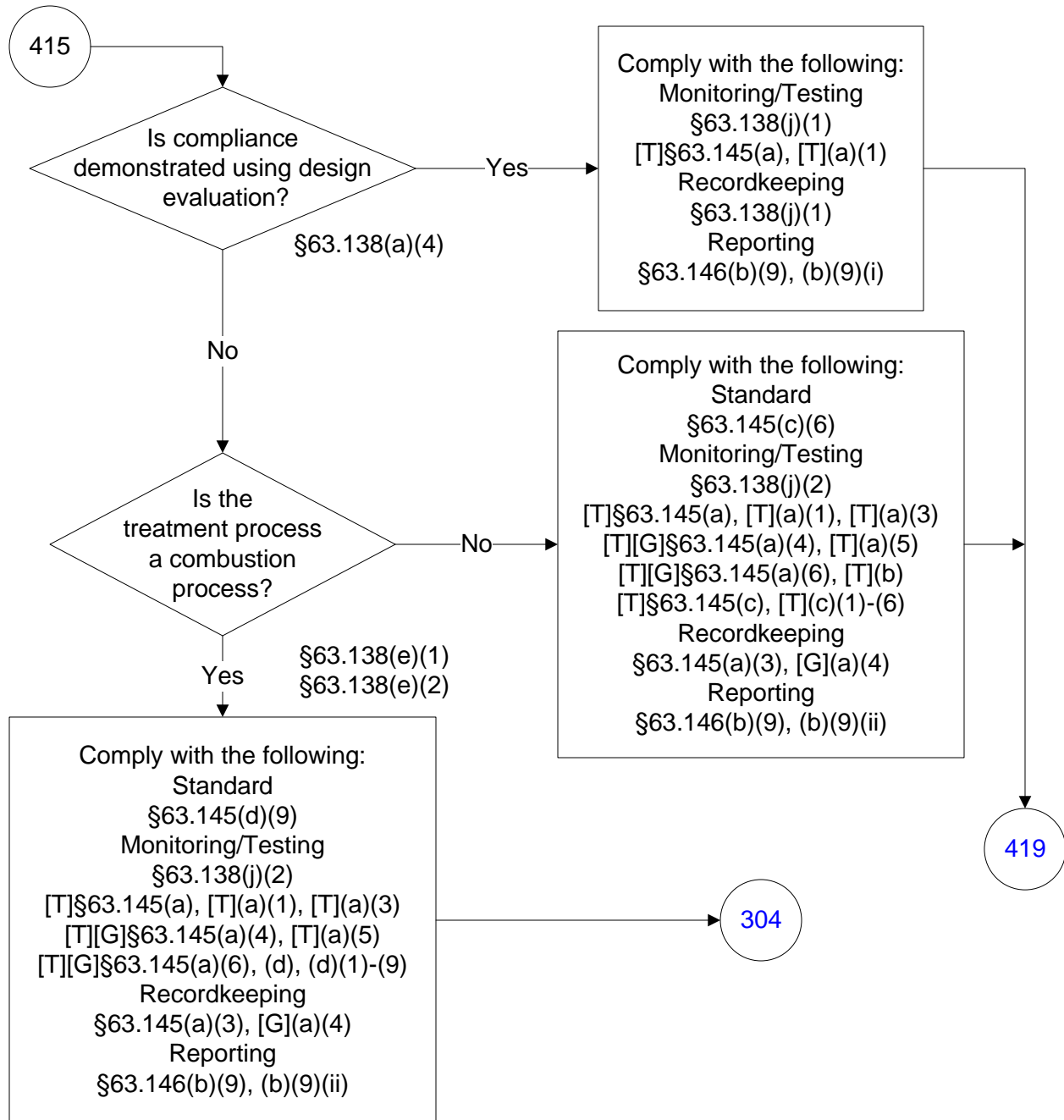

40 CFR Part 63, Subpart JJJ

(161 of 196)

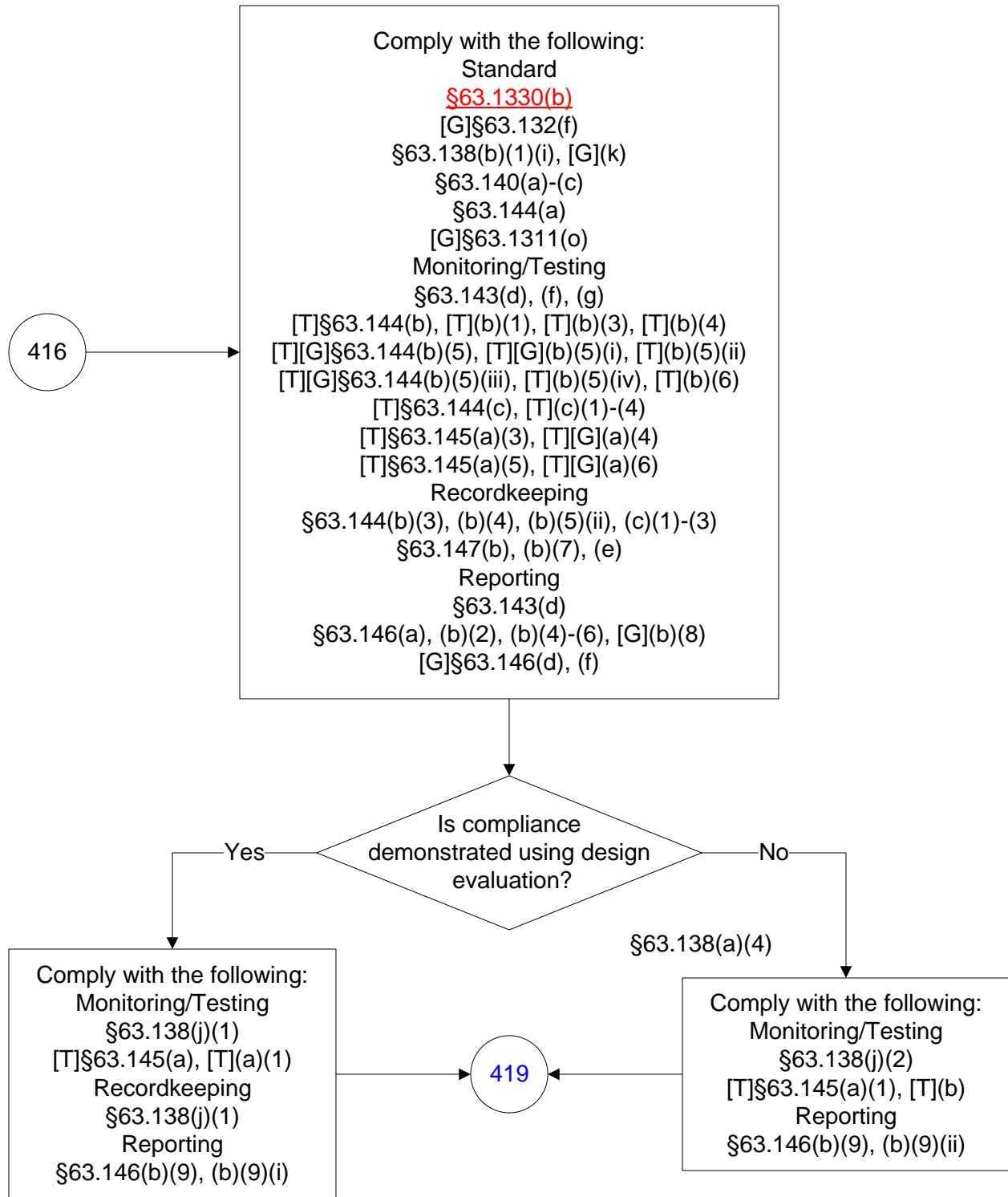

40 CFR Part 63, Subpart JJJ

(162 of 196)

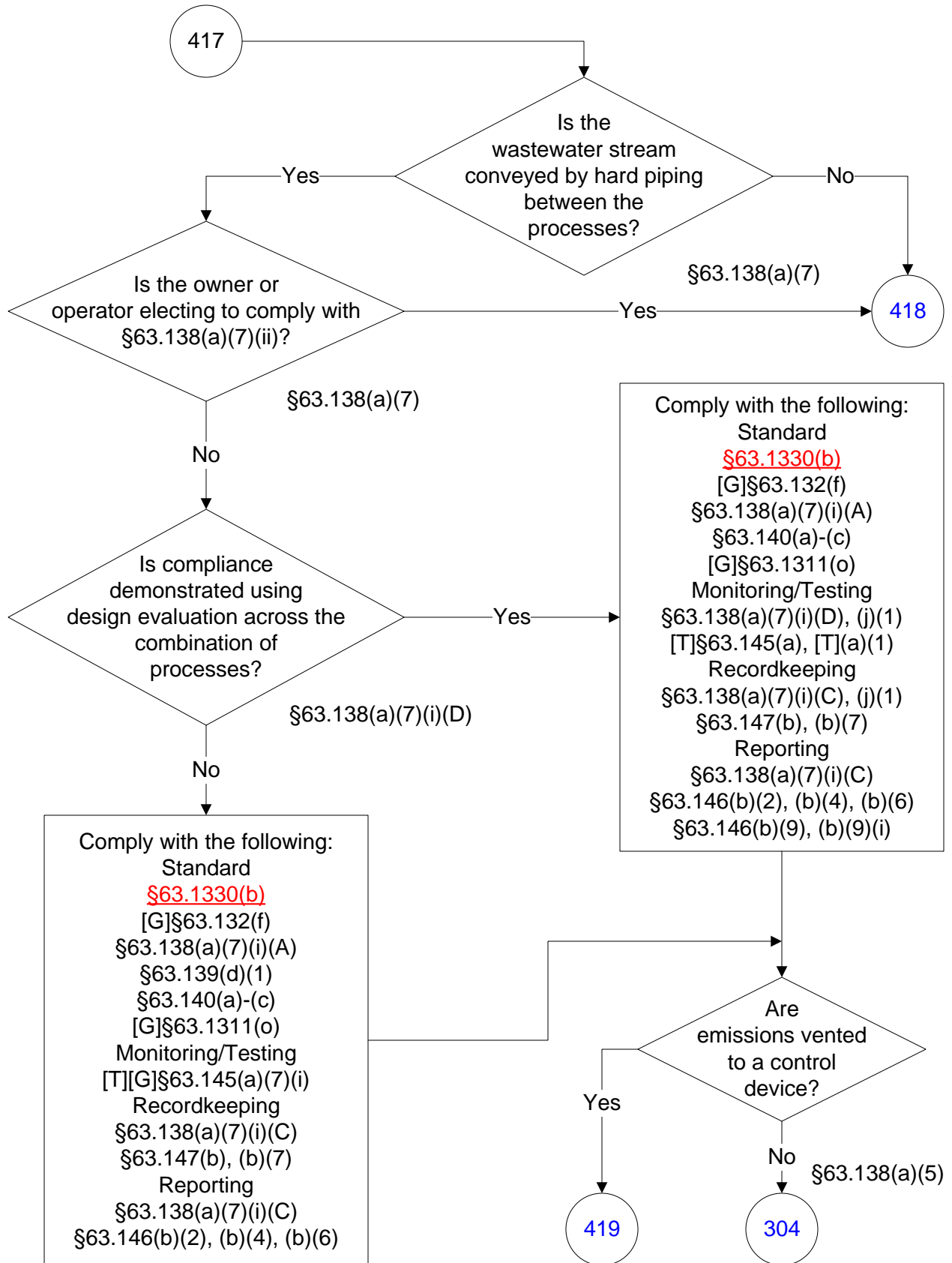

40 CFR Part 63, Subpart JJJ

(163 of 196)

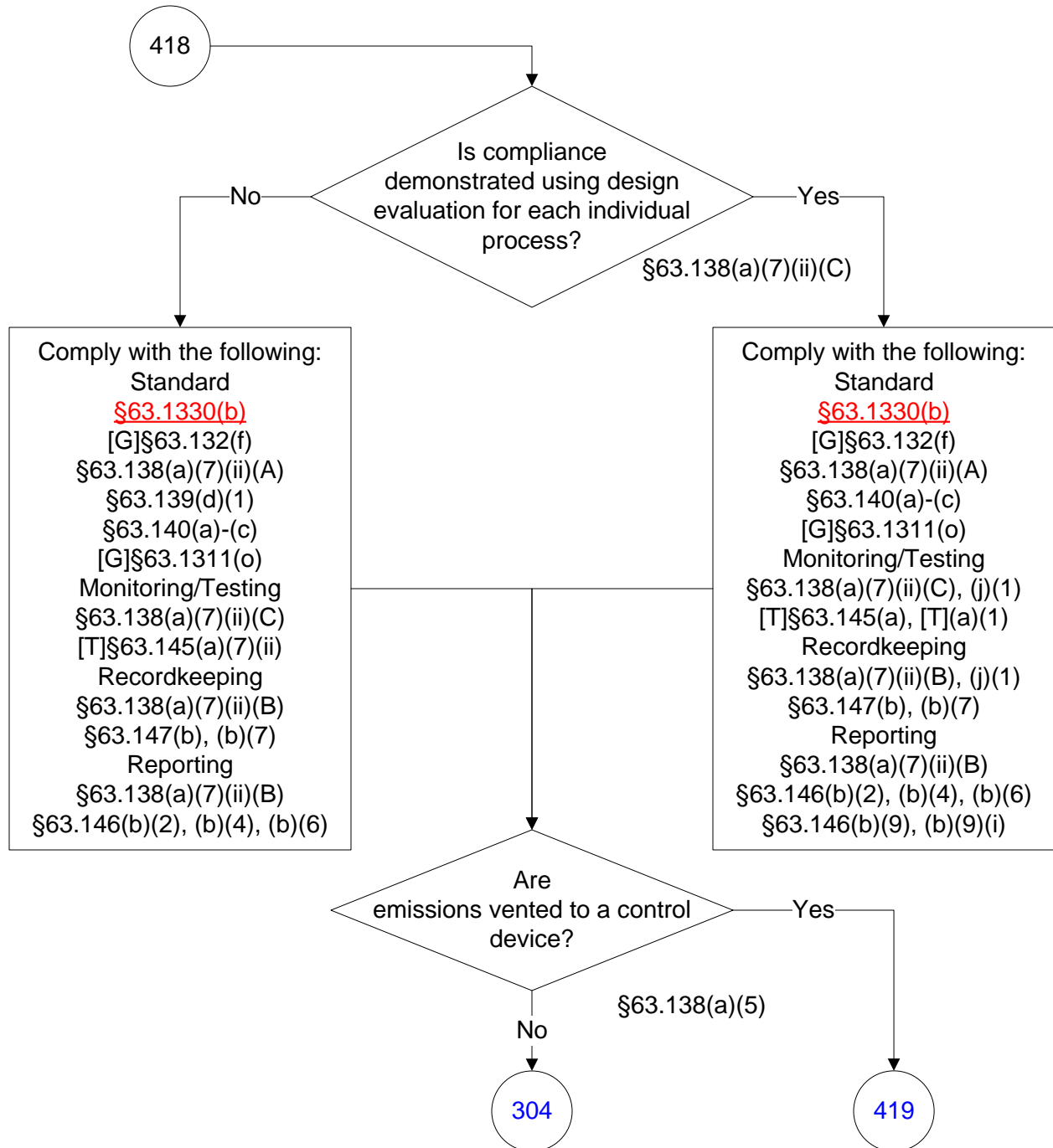

40 CFR Part 63, Subpart JJJ

(164 of 196)

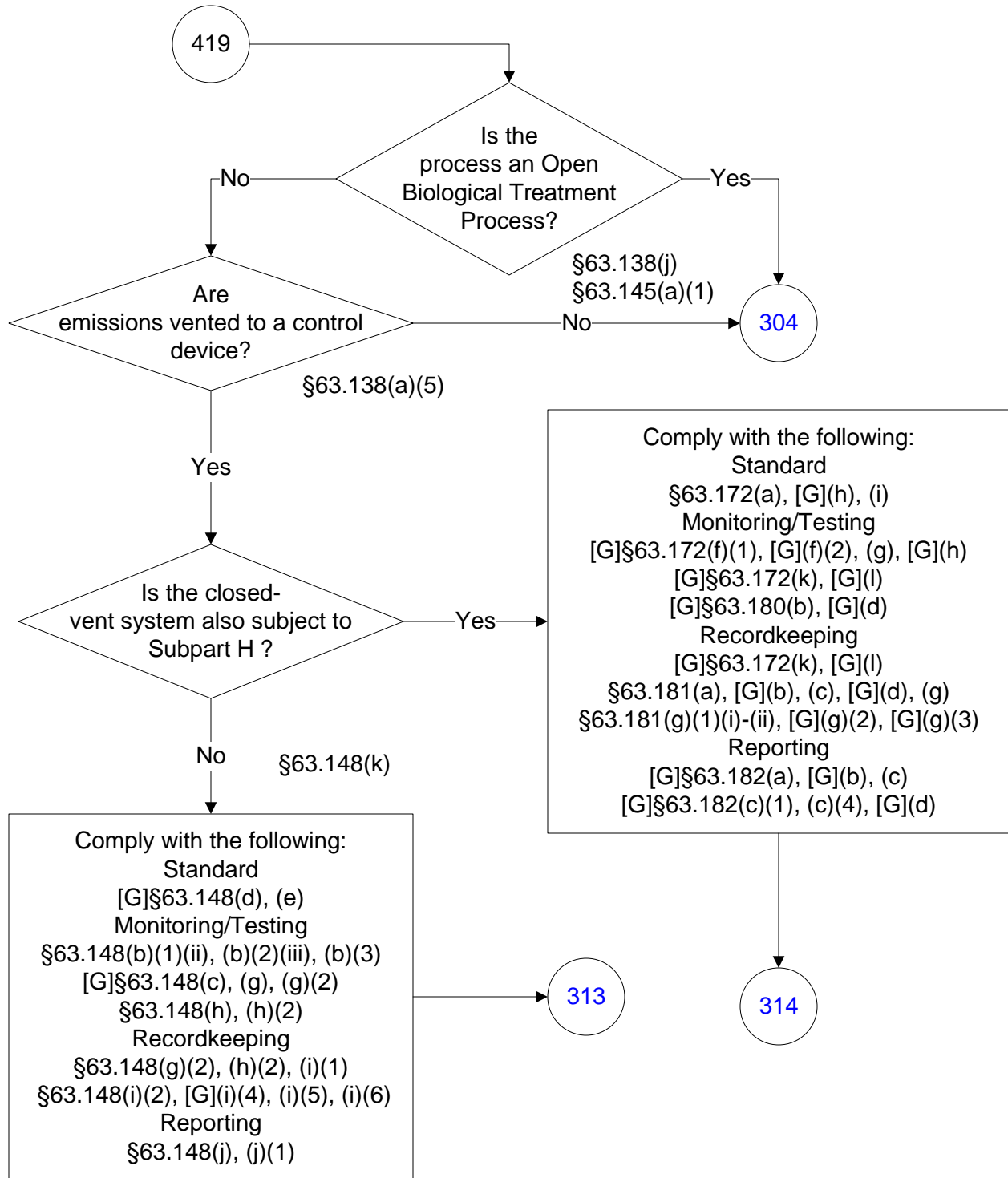

40 CFR Part 63, Subpart JJJ

(165 of 196)

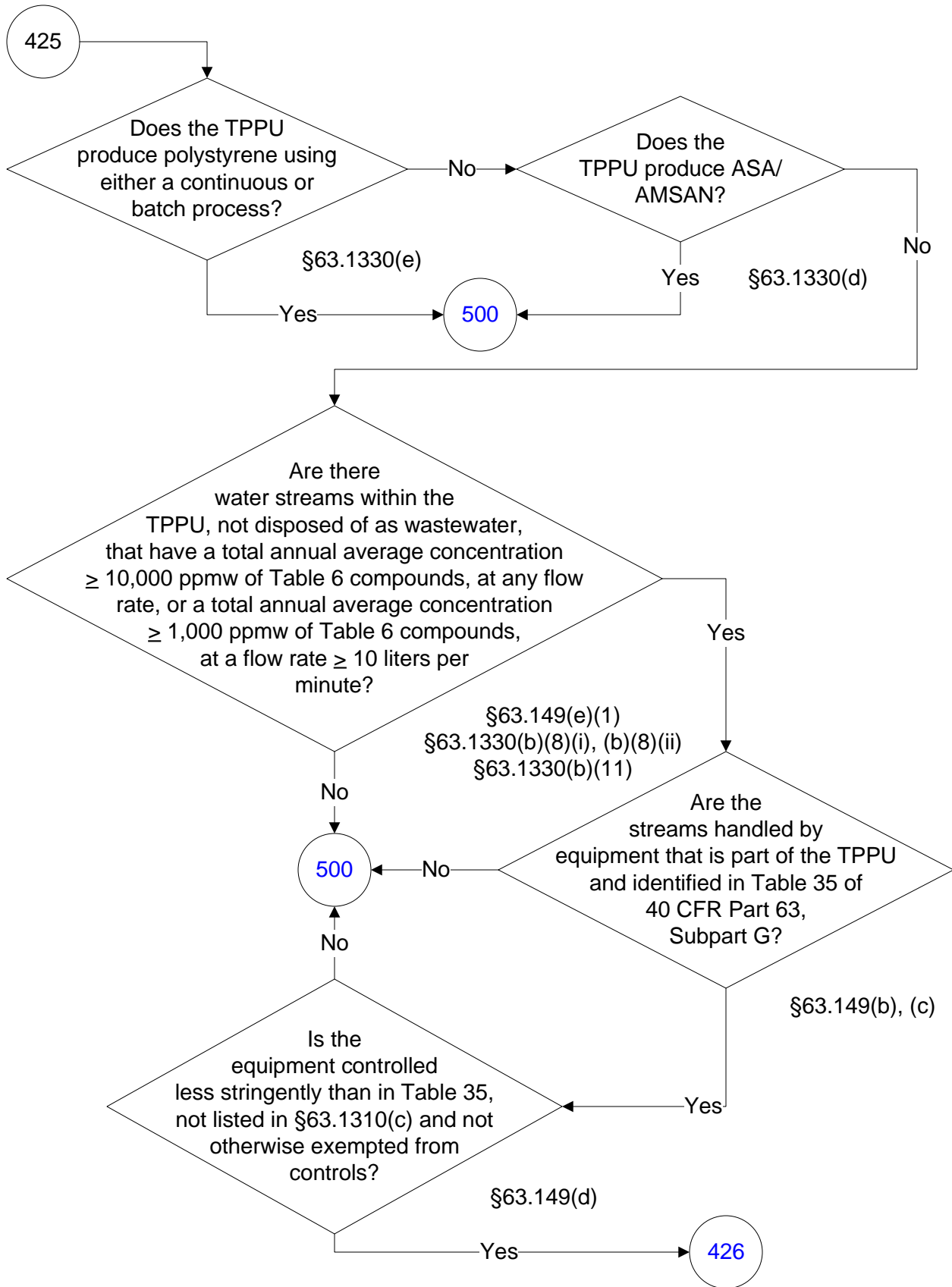

40 CFR Part 63, Subpart JJJ

(166 of 196)

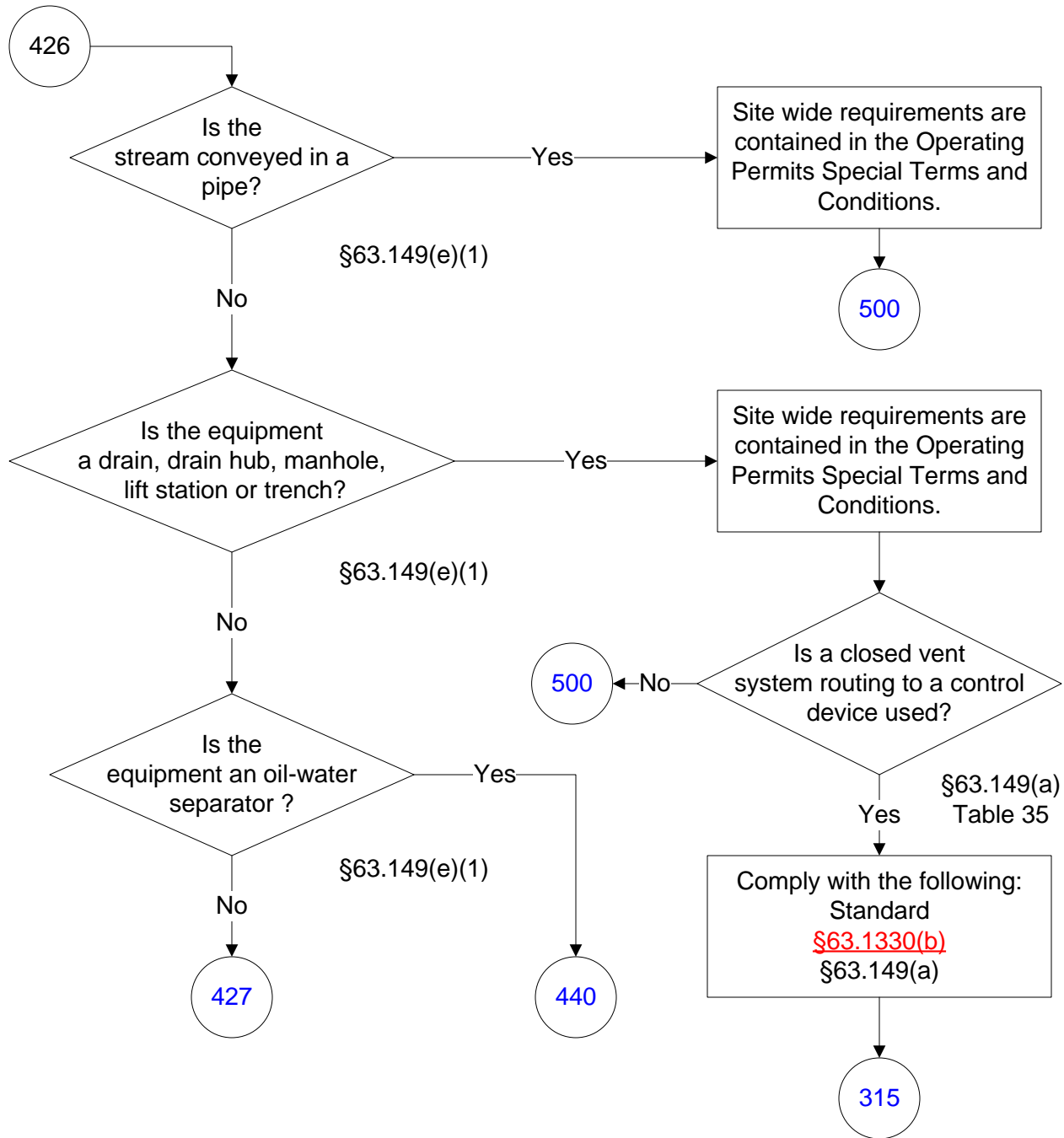

40 CFR Part 63, Subpart JJJ

(167 of 196)

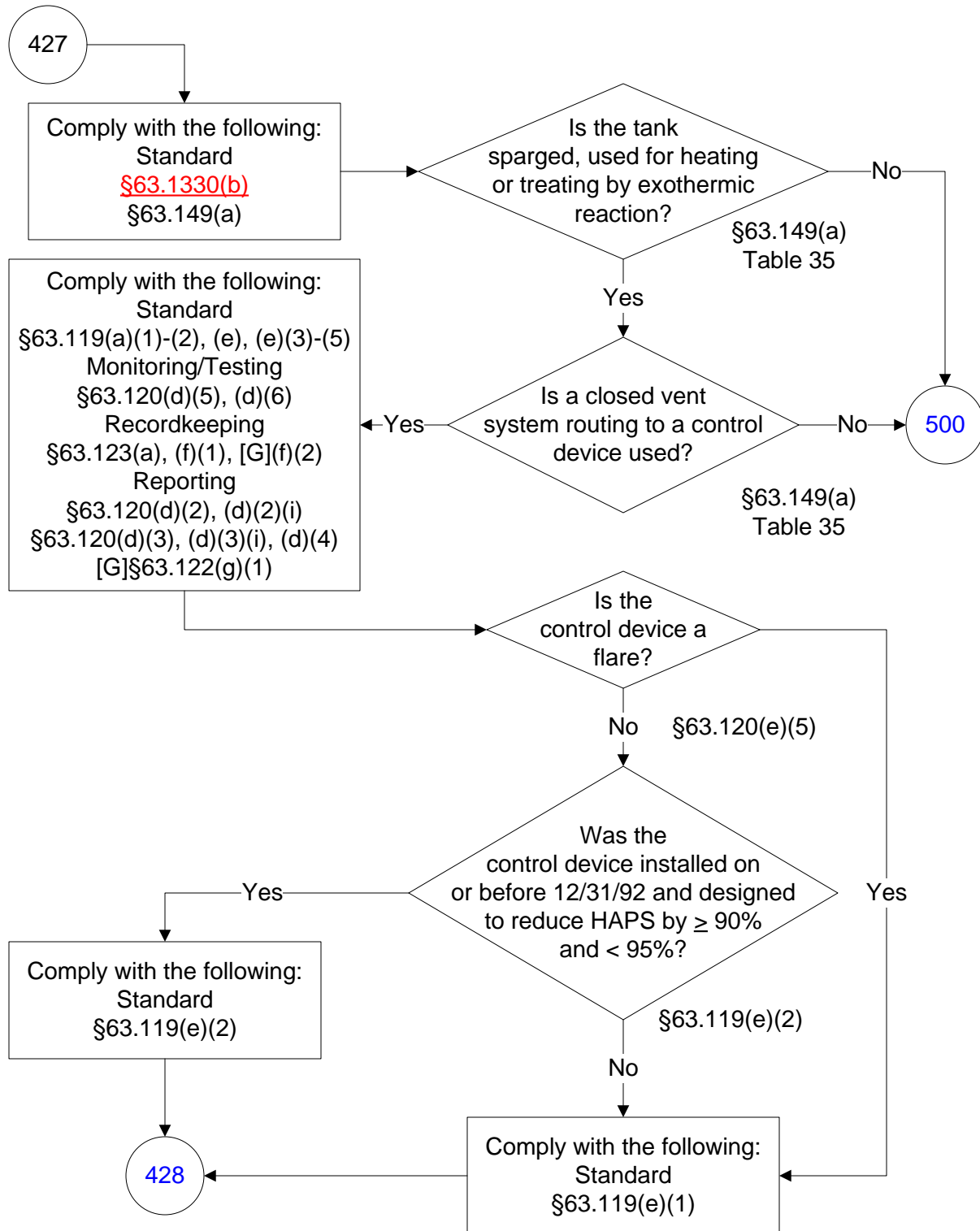

40 CFR Part 63, Subpart JJJ

(168 of 196)

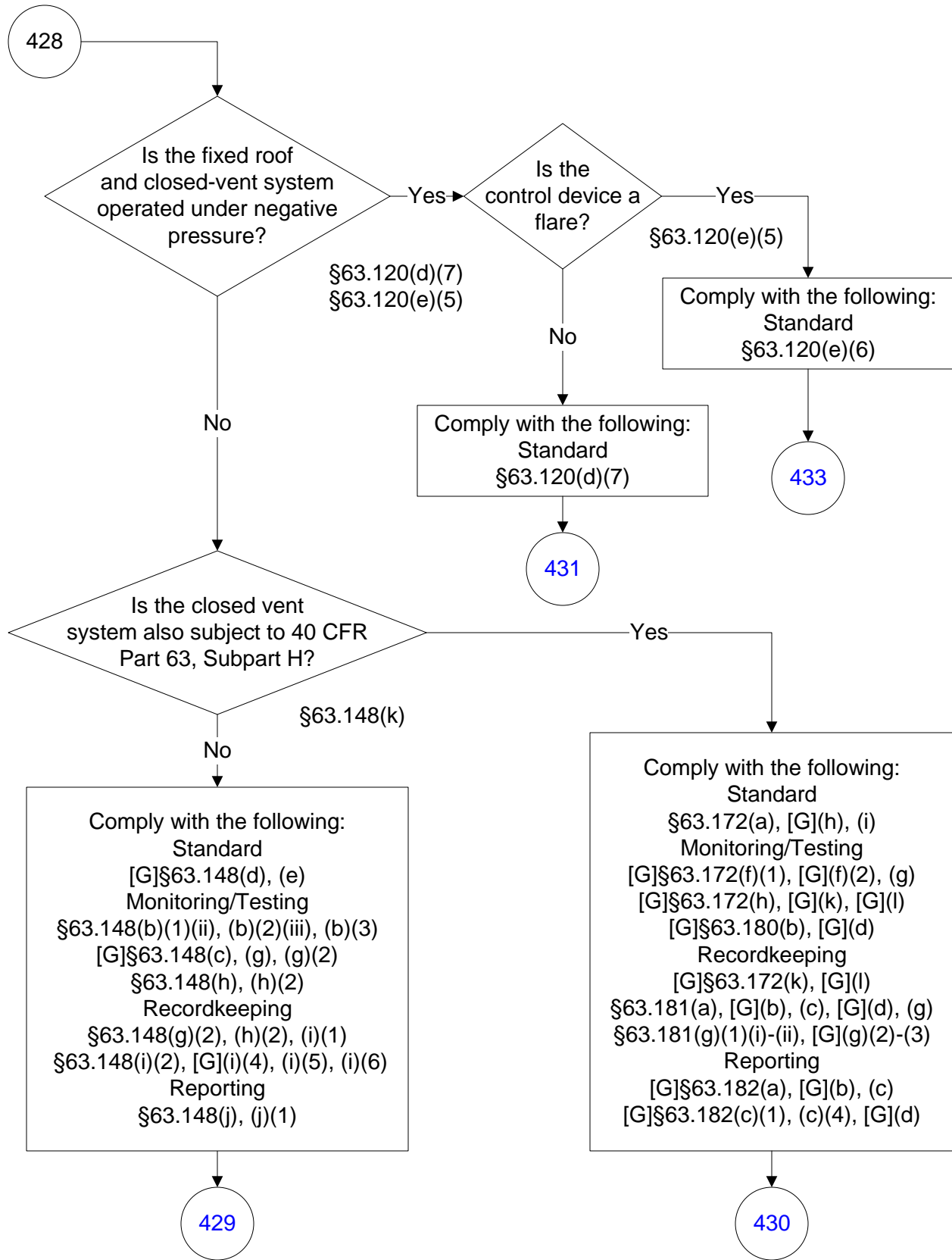

40 CFR Part 63, Subpart JJJ

(169 of 196)

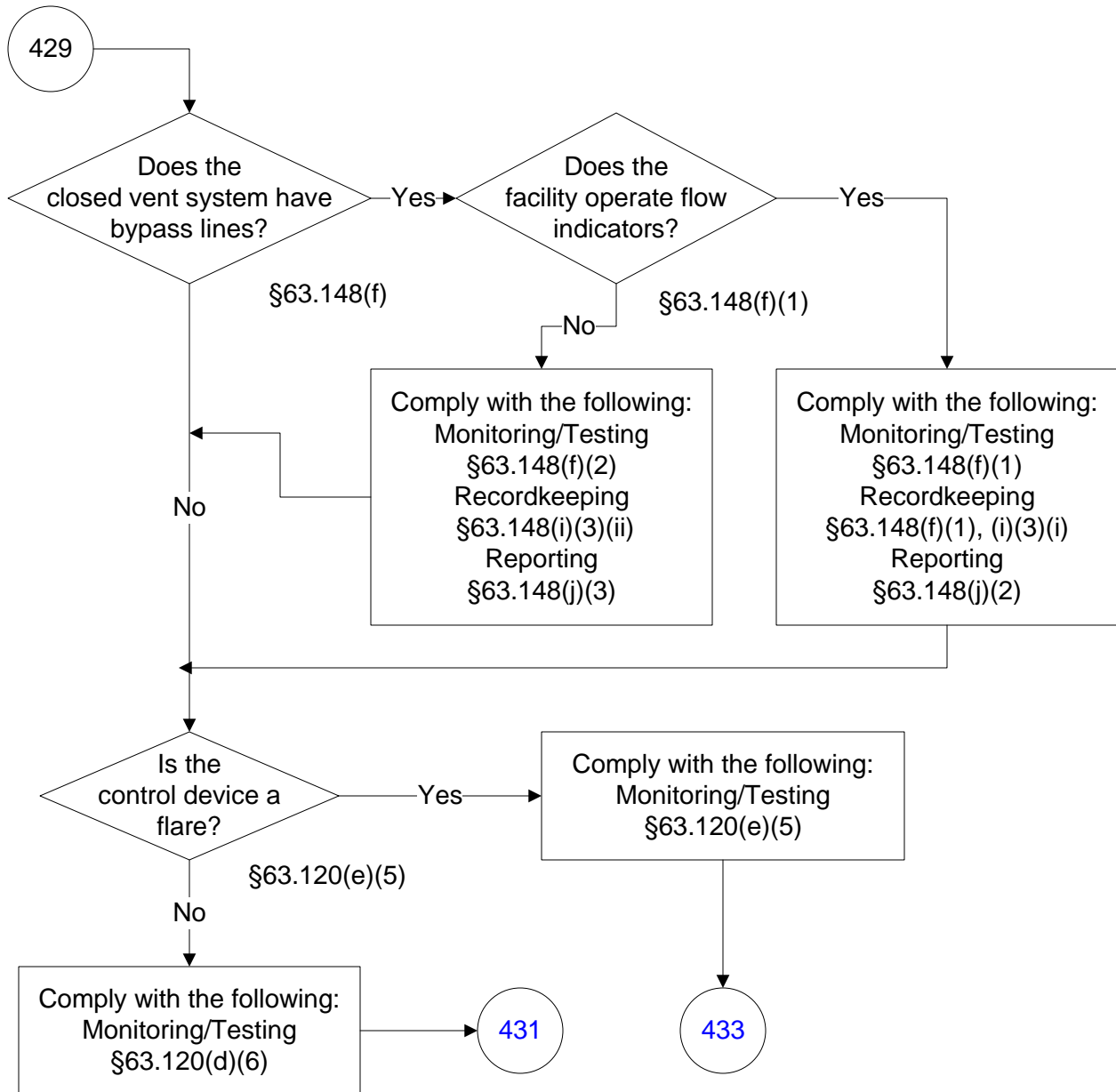

40 CFR Part 63, Subpart JJJ

(170 of 196)

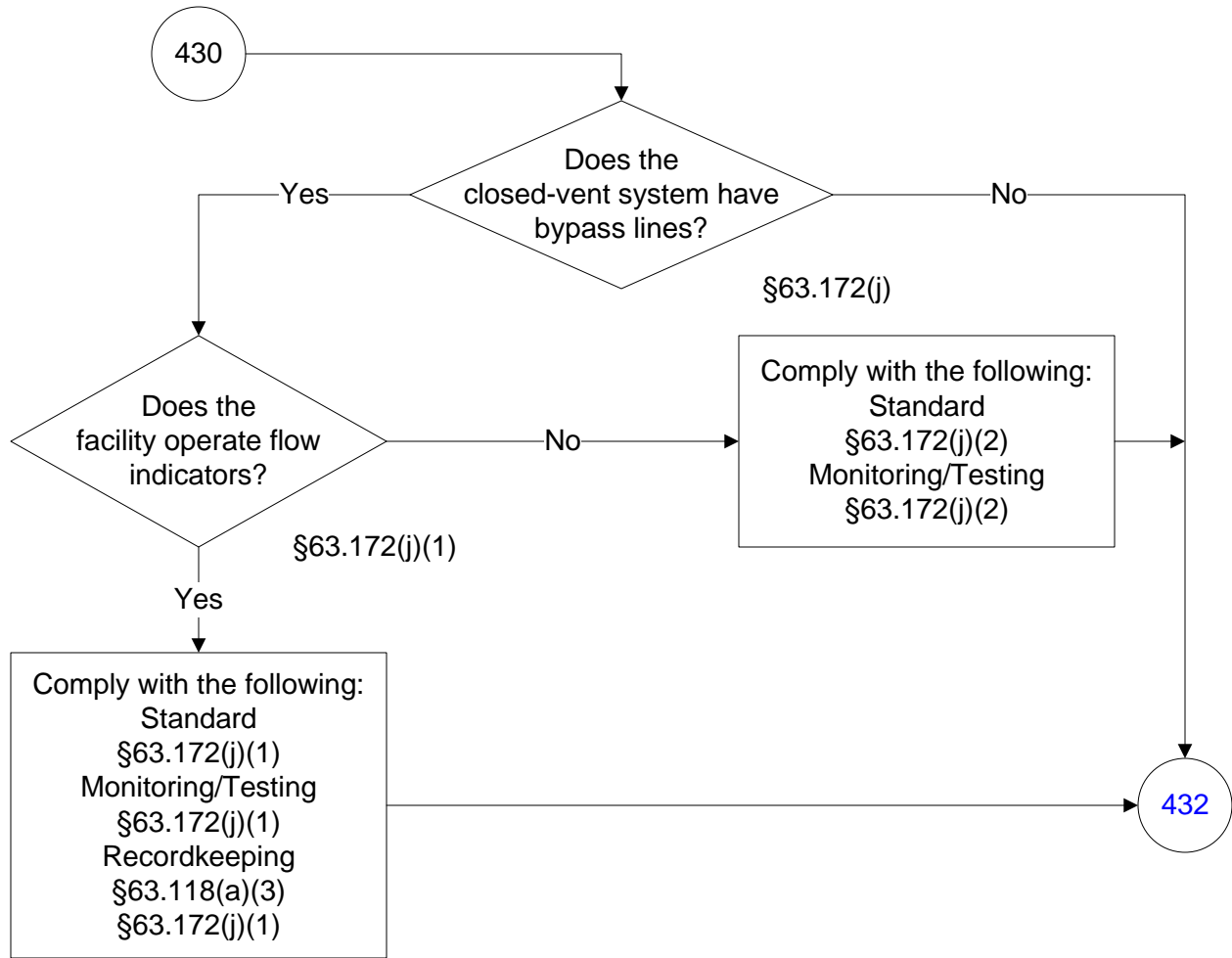

40 CFR Part 63, Subpart JJJ

(171 of 196)

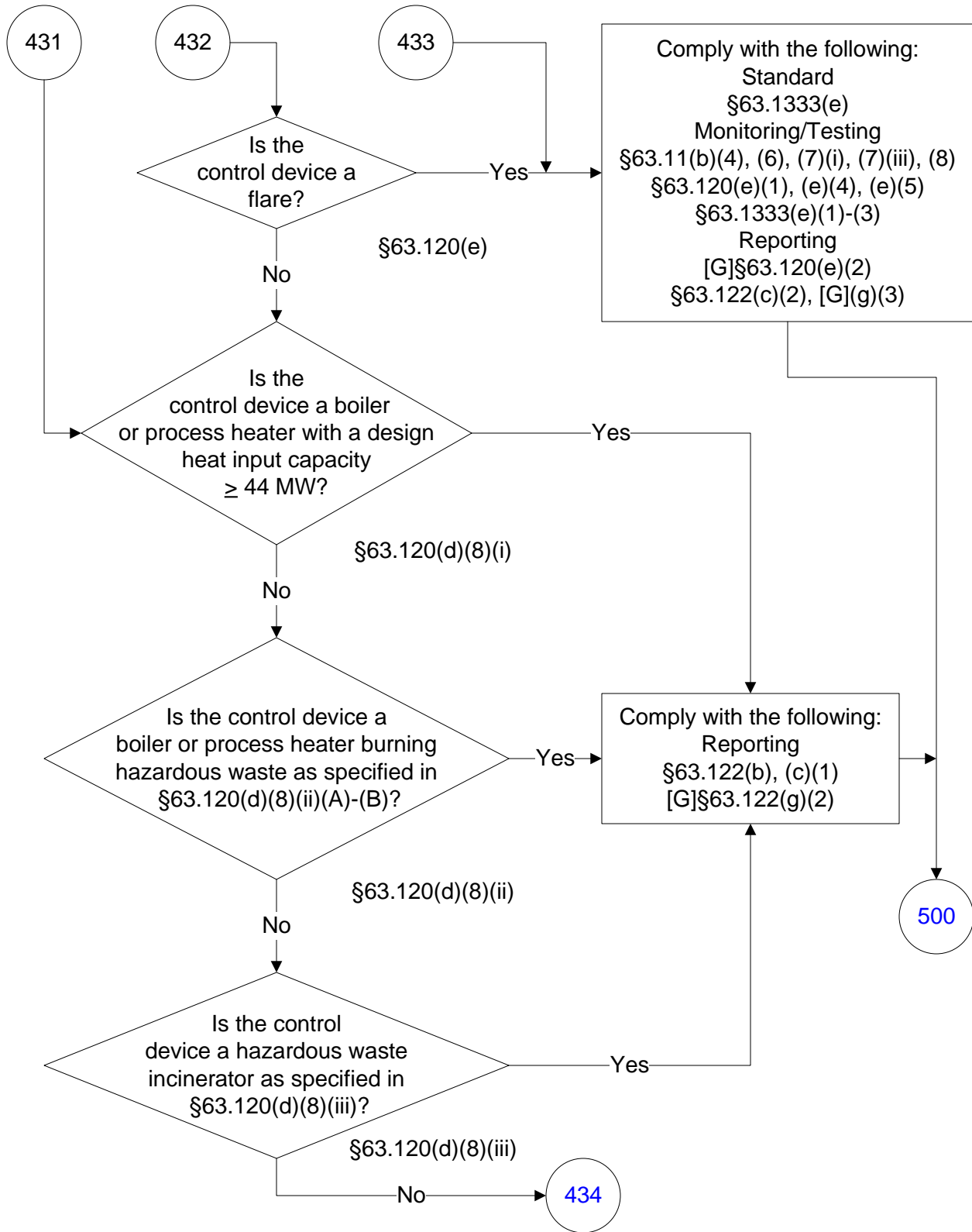

40 CFR Part 63, Subpart JJJ

(172 of 196)

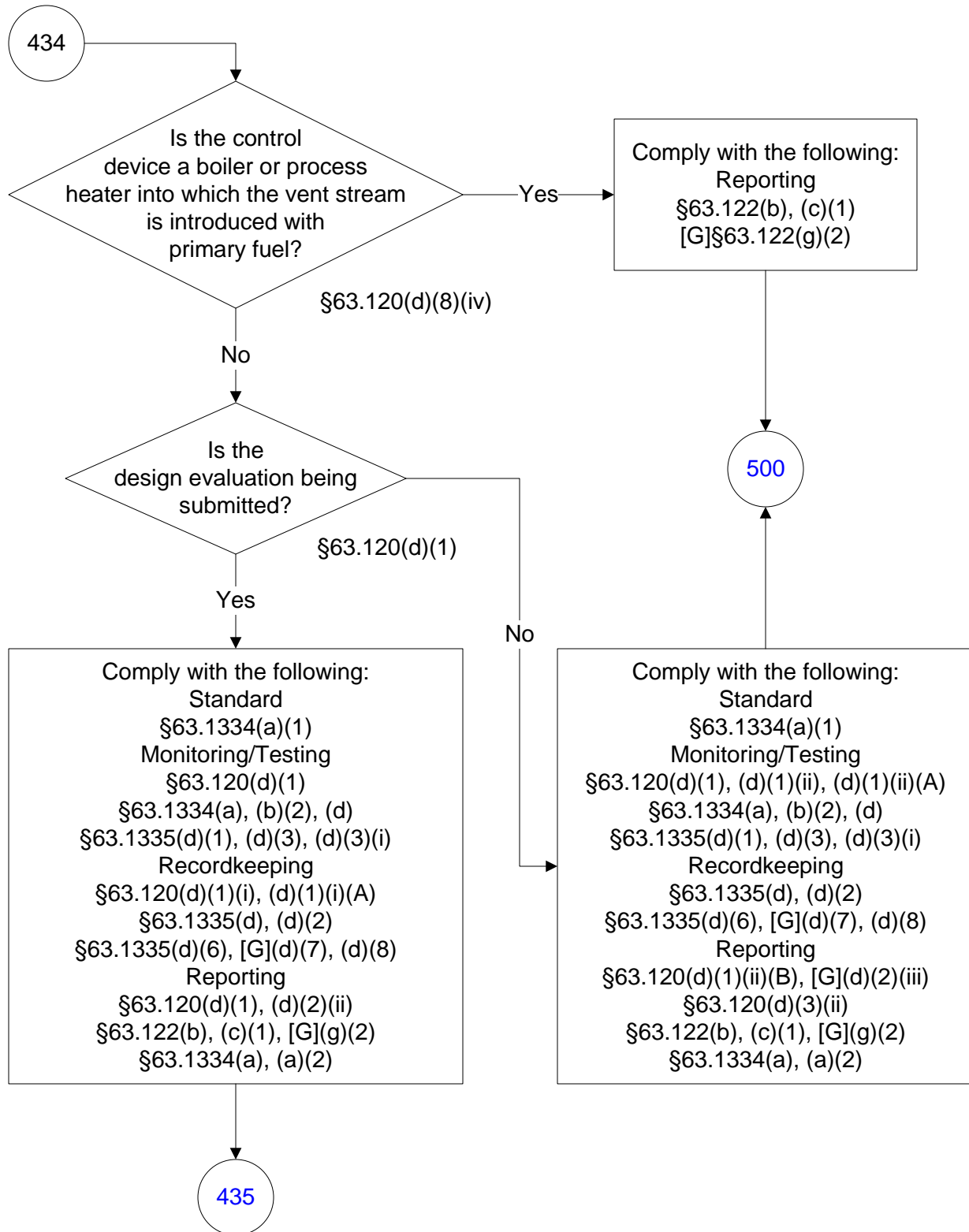

40 CFR Part 63, Subpart JJJ

(173 of 196)

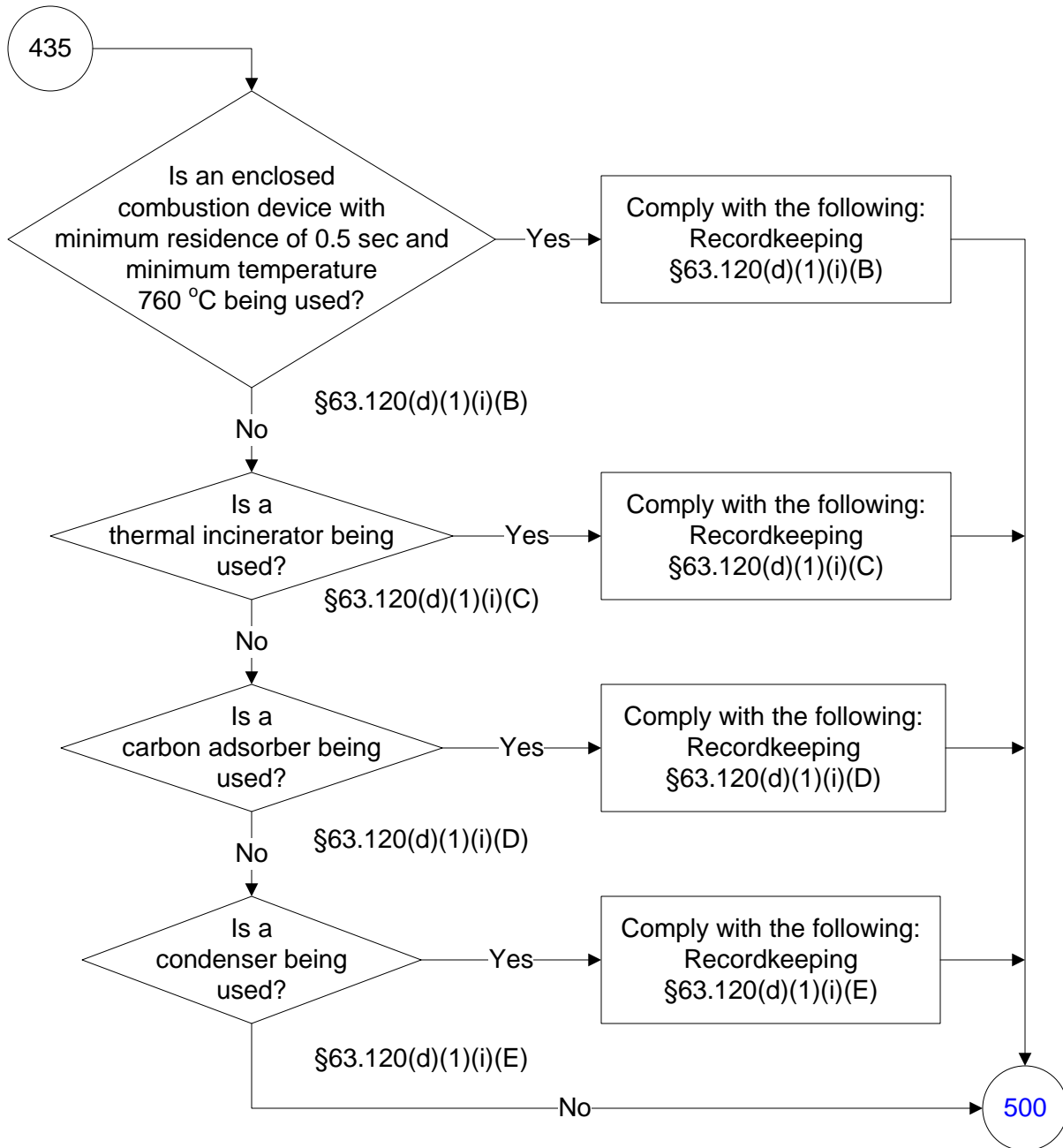

40 CFR Part 63, Subpart JJJ

(174 of 196)

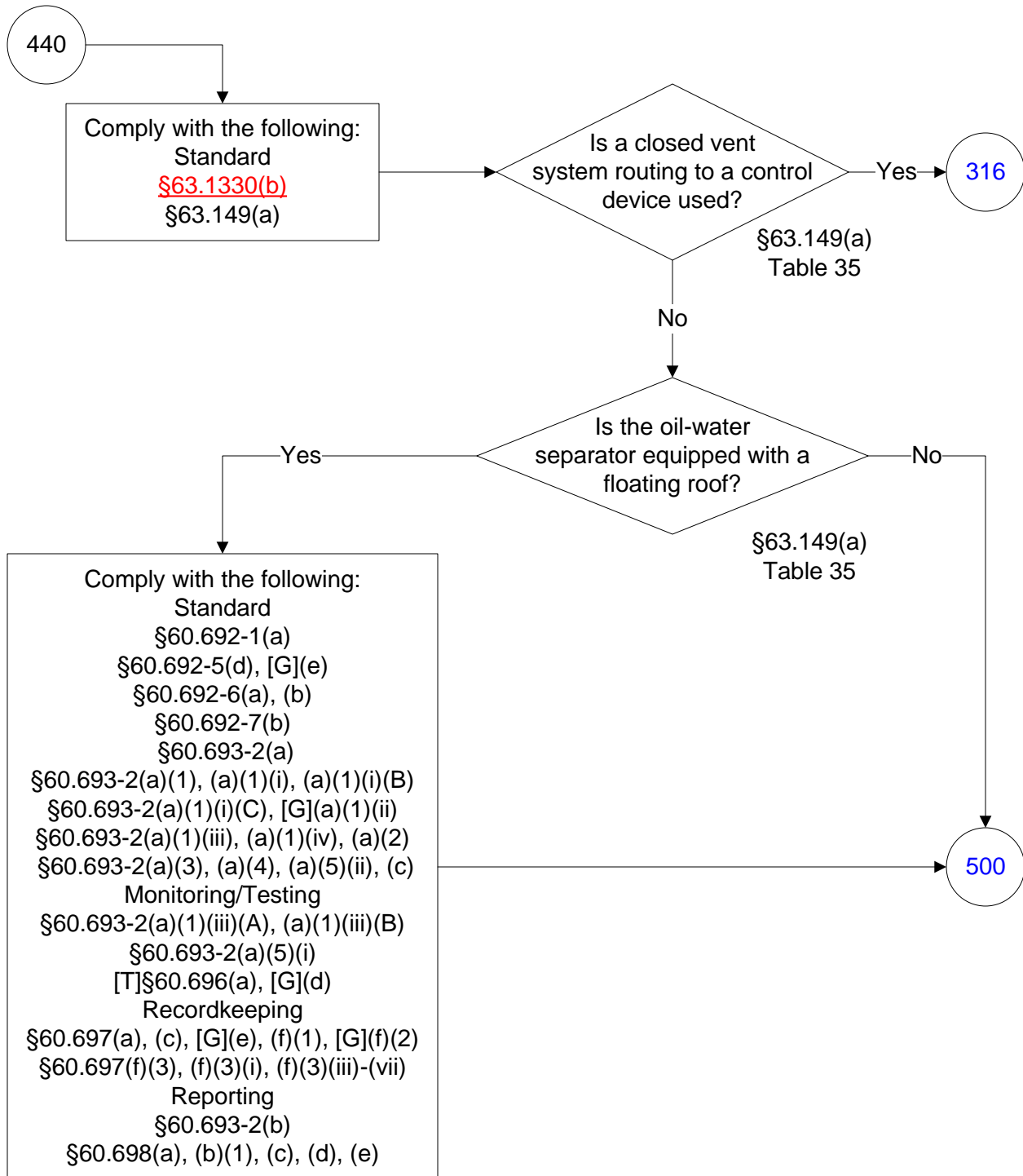

40 CFR Part 63, Subpart JJJ

(175 of 196)

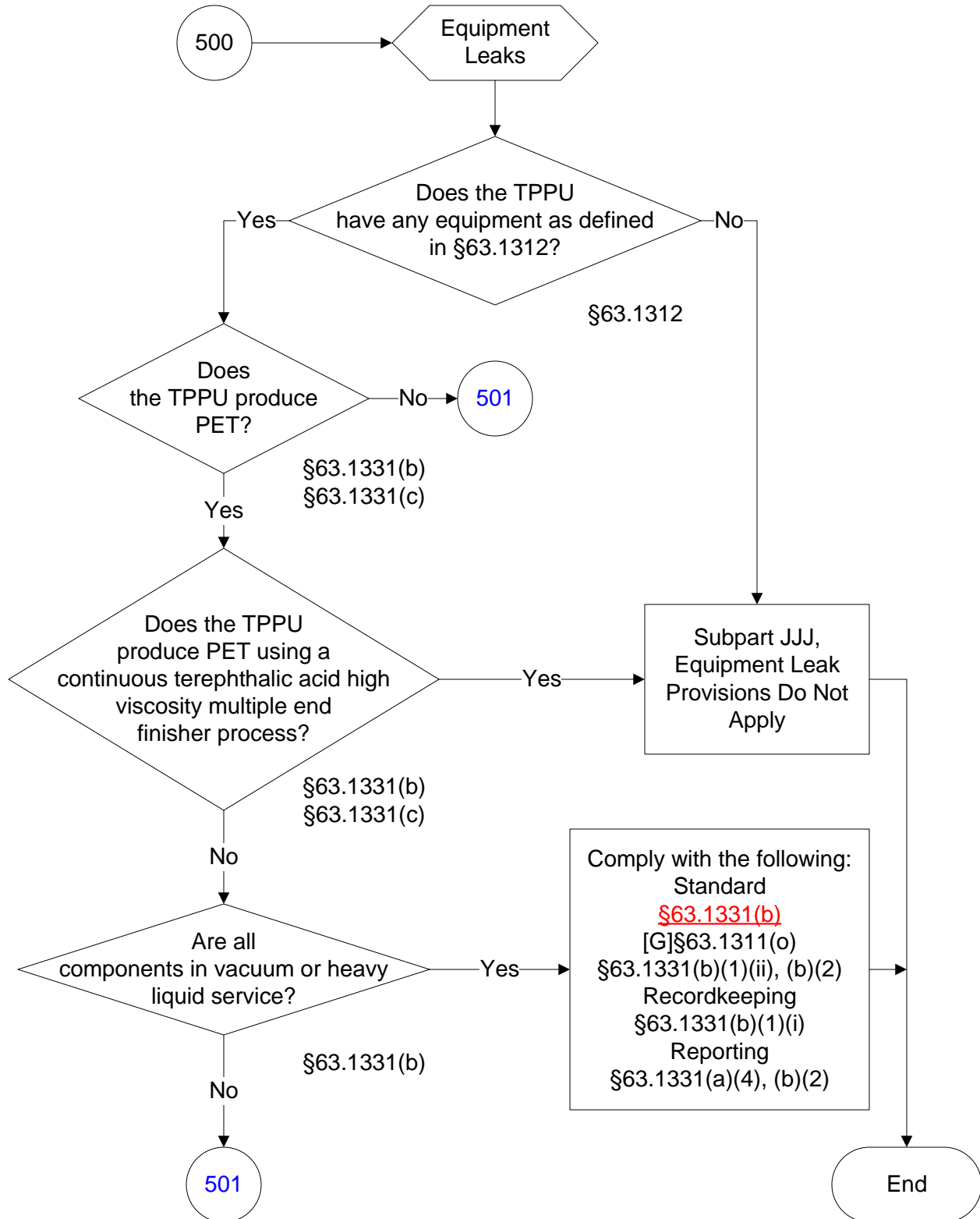

40 CFR Part 63, Subpart JJJ

(176 of 196)

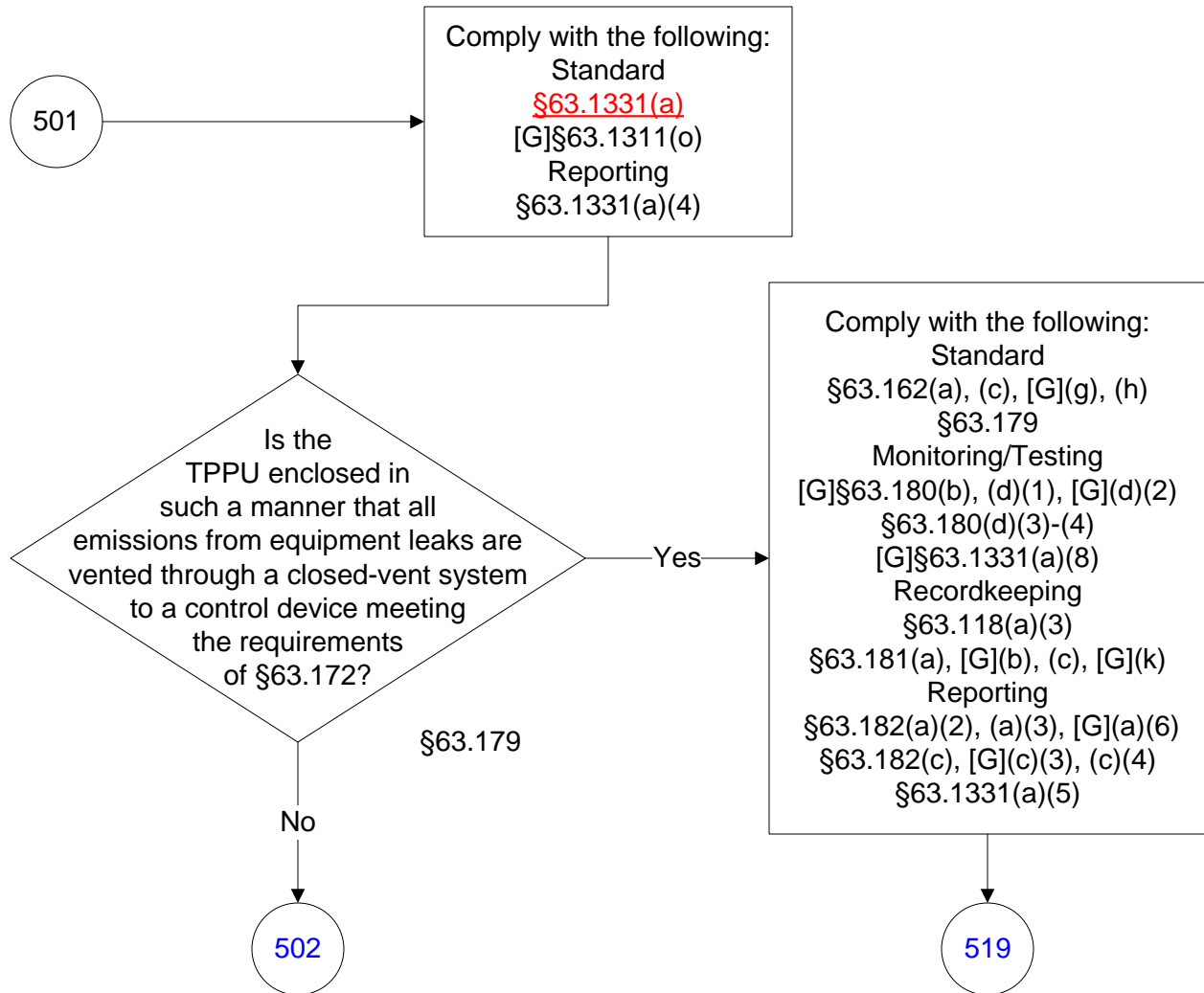

40 CFR Part 63, Subpart JJJ

(177 of 196)

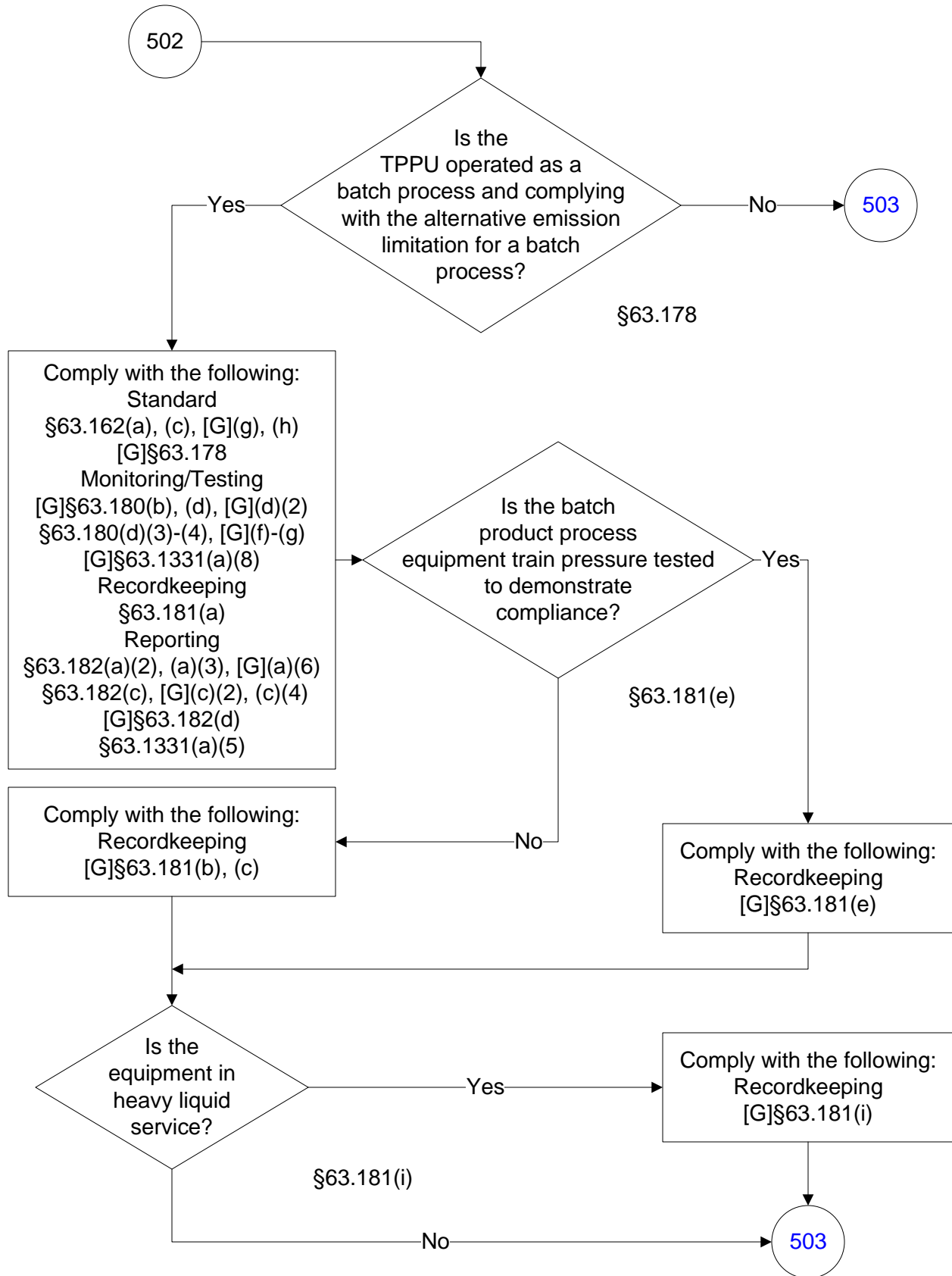

40 CFR Part 63, Subpart JJJ

(178 of 196)

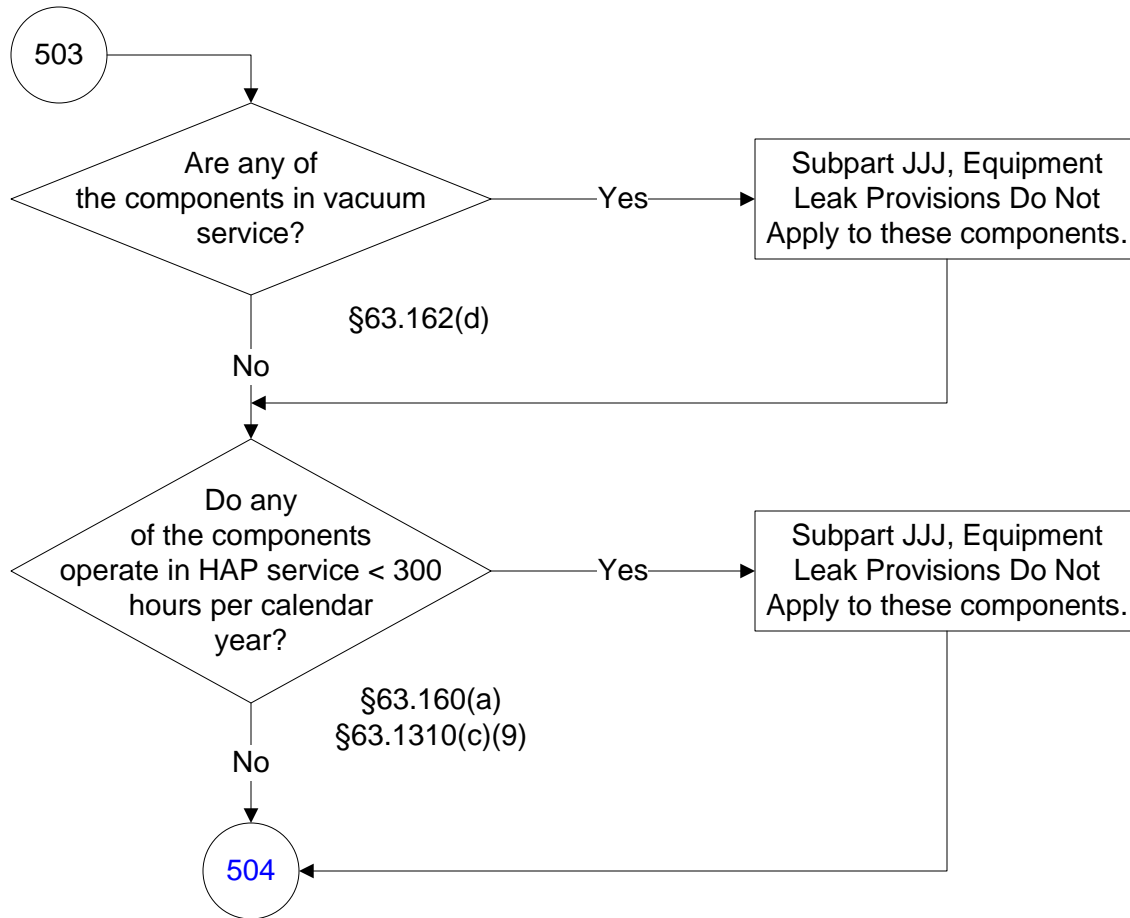

40 CFR Part 63, Subpart JJJ

(179 of 196)

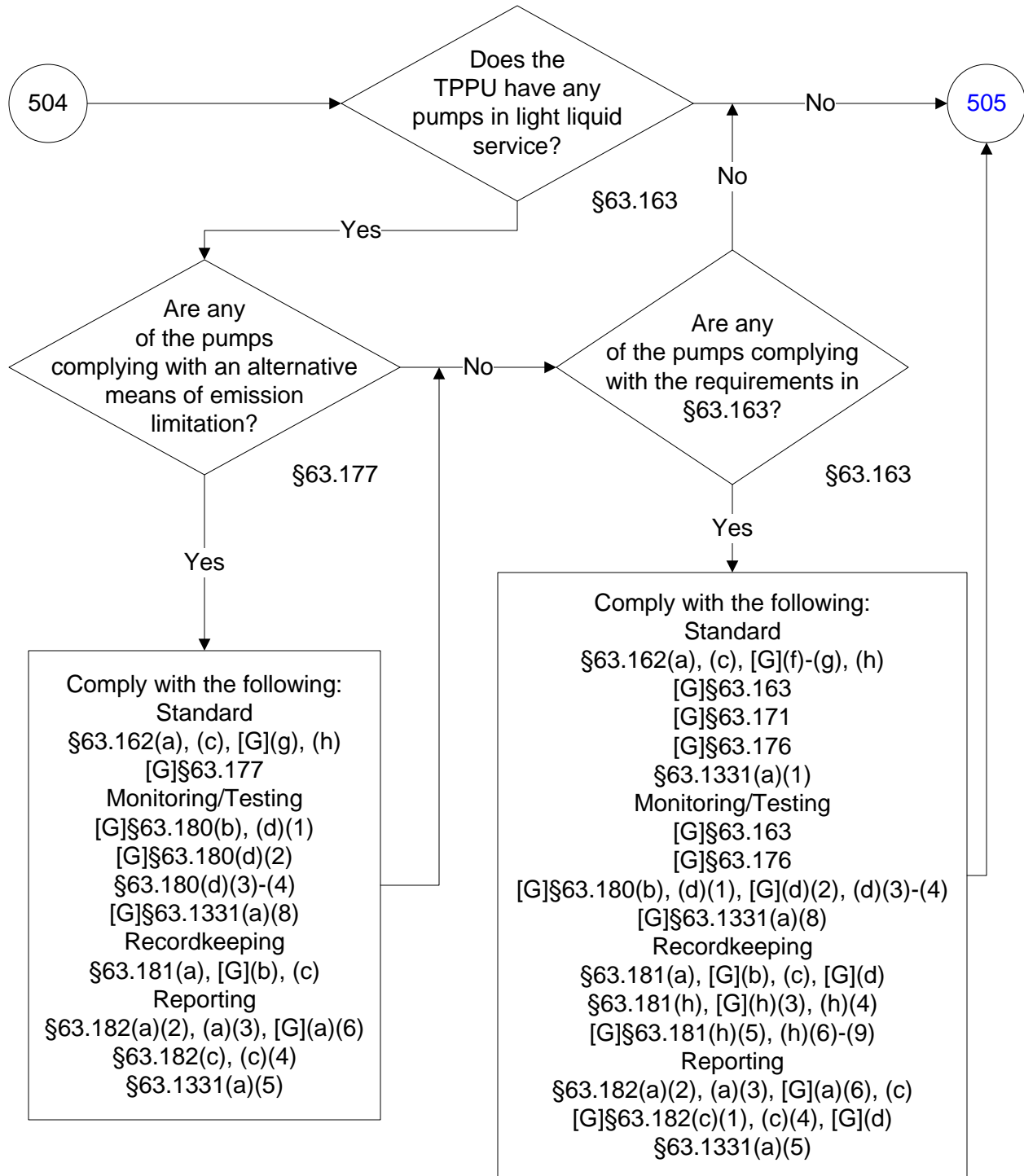

40 CFR Part 63, Subpart JJJ

(180 of 196)

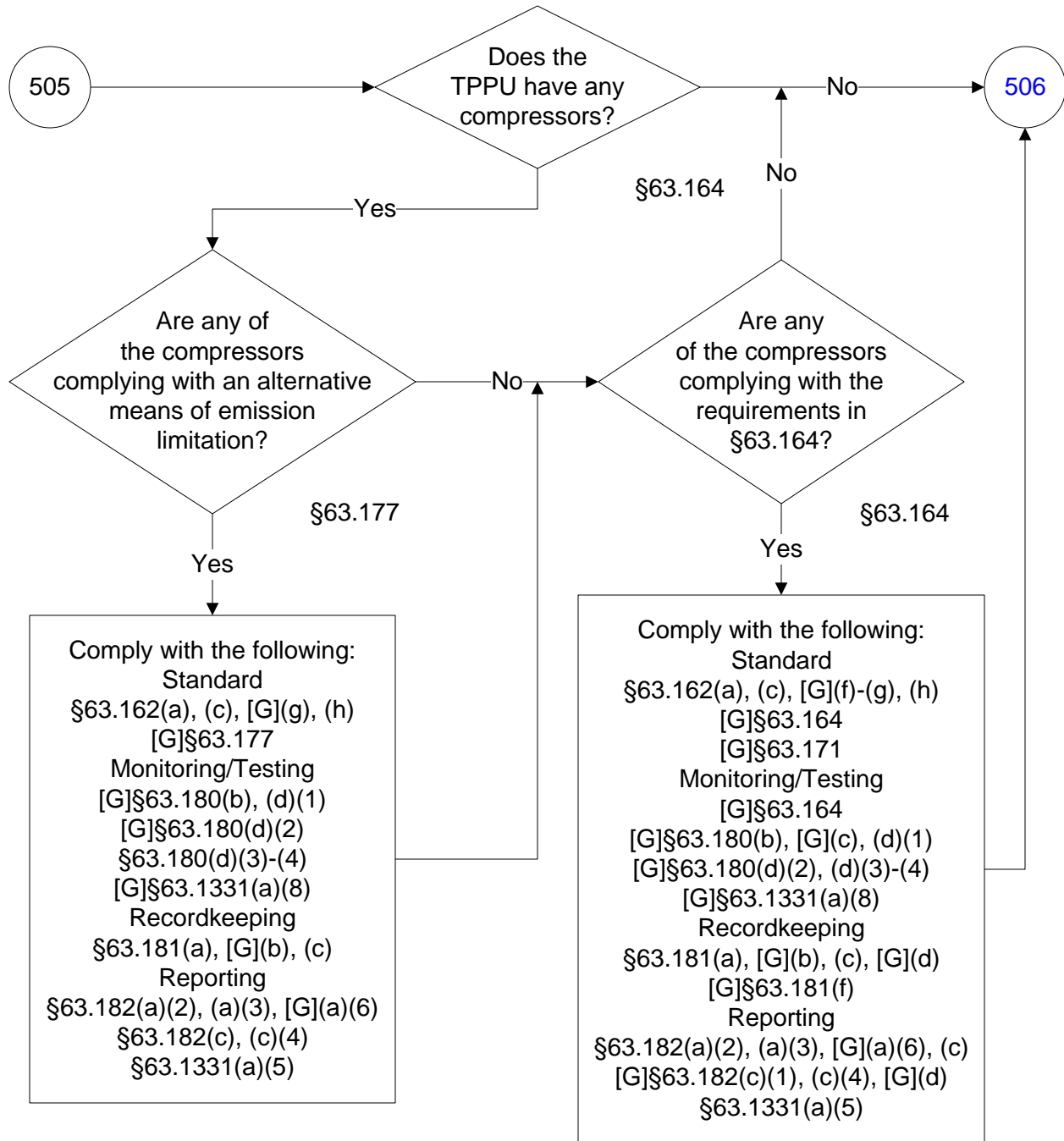

40 CFR Part 63, Subpart JJJ

(181 of 196)

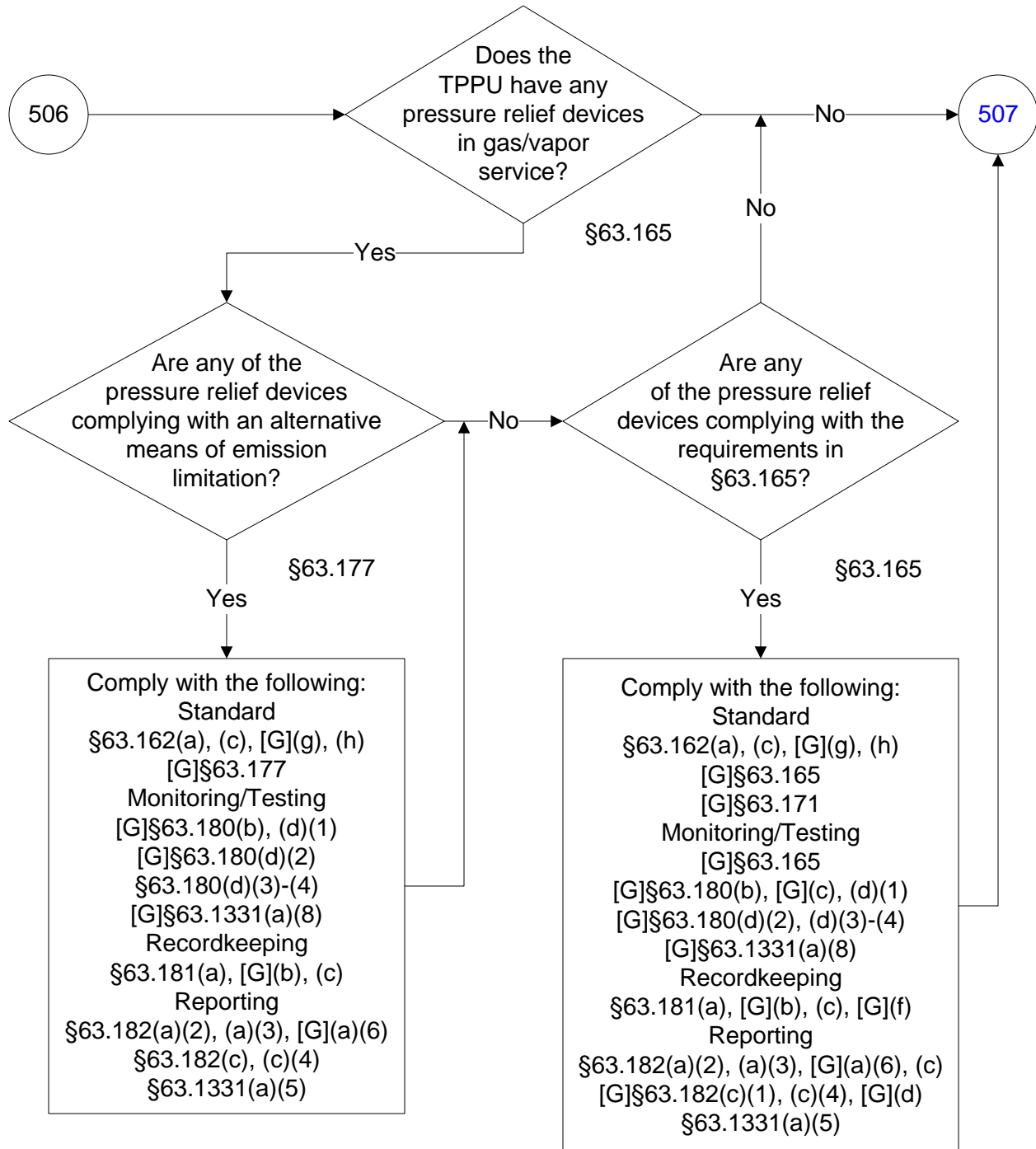

40 CFR Part 63, Subpart JJJ

(182 of 196)

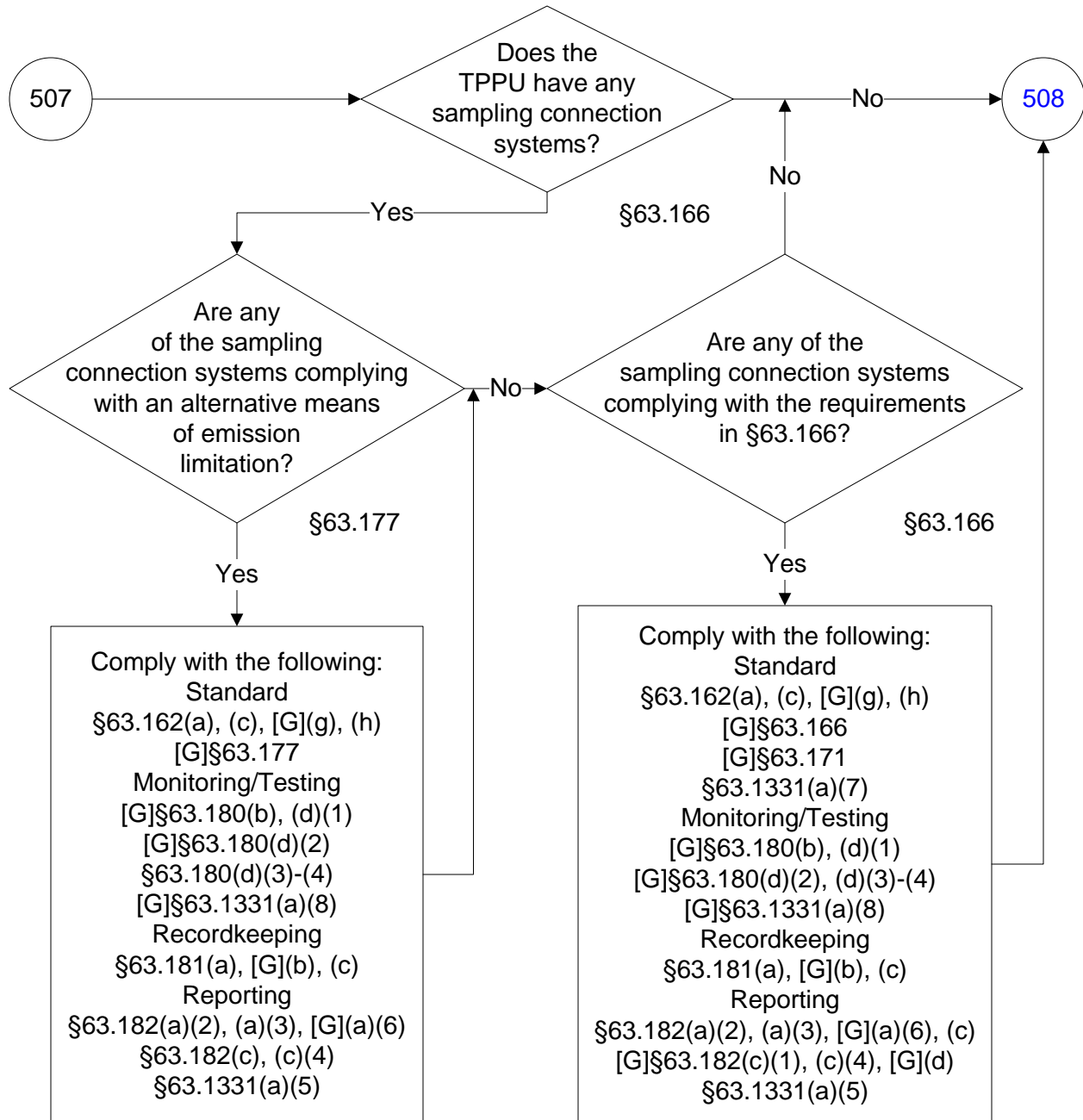

40 CFR Part 63, Subpart JJJ

(183 of 196)

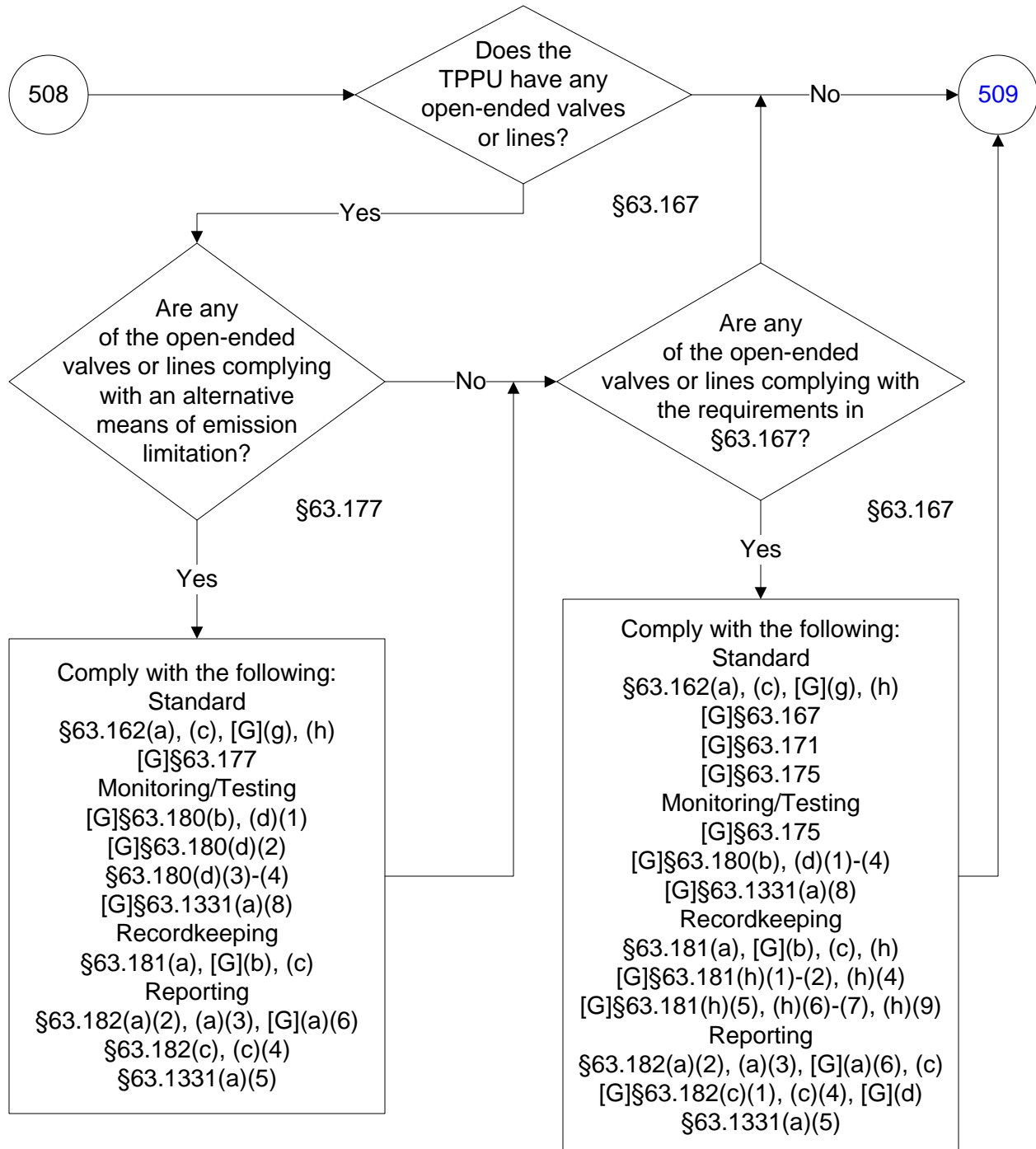

40 CFR Part 63, Subpart JJJ

(184 of 196)

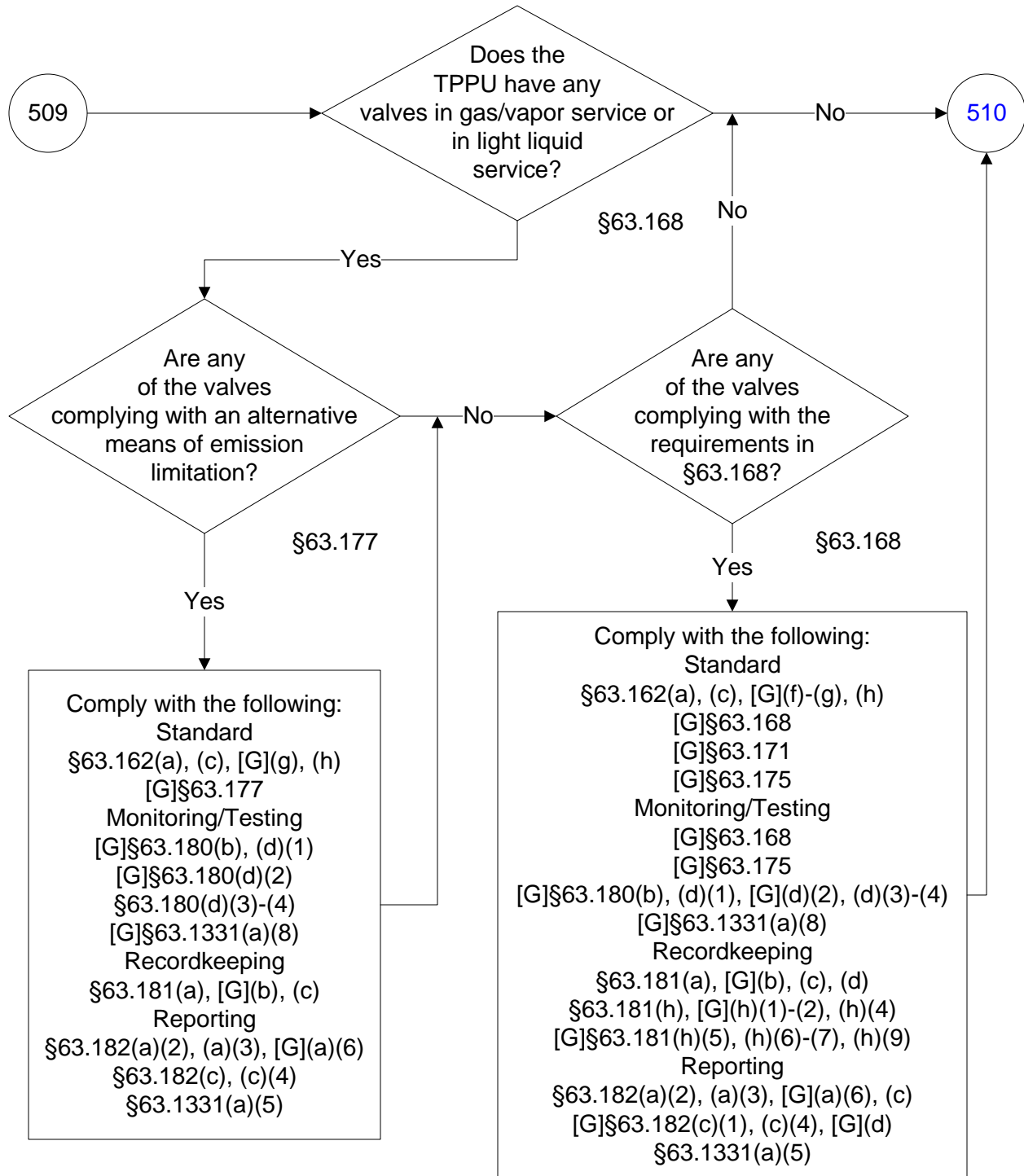

40 CFR Part 63, Subpart JJJ

(185 of 196)

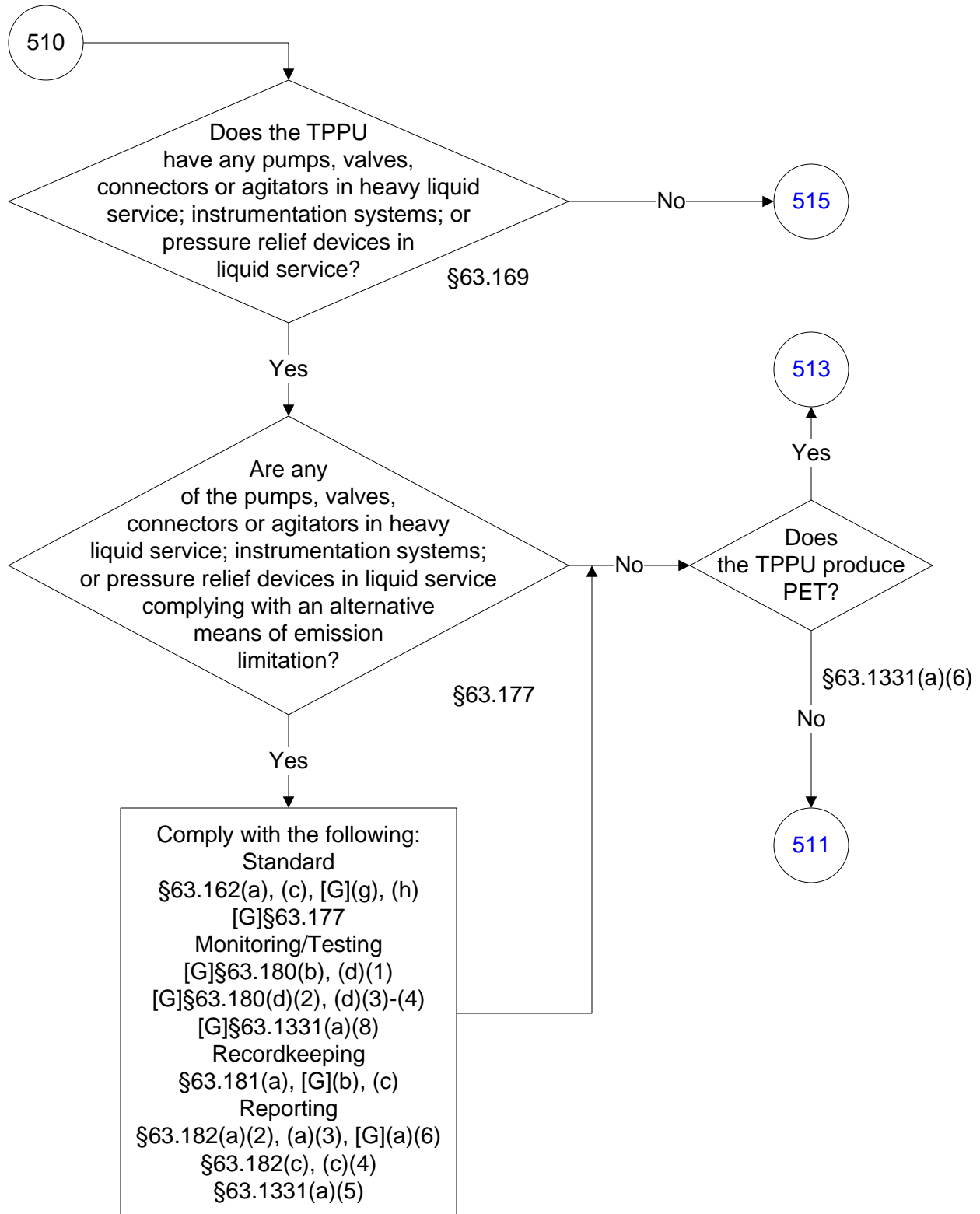

40 CFR Part 63, Subpart JJJ

(186 of 196)

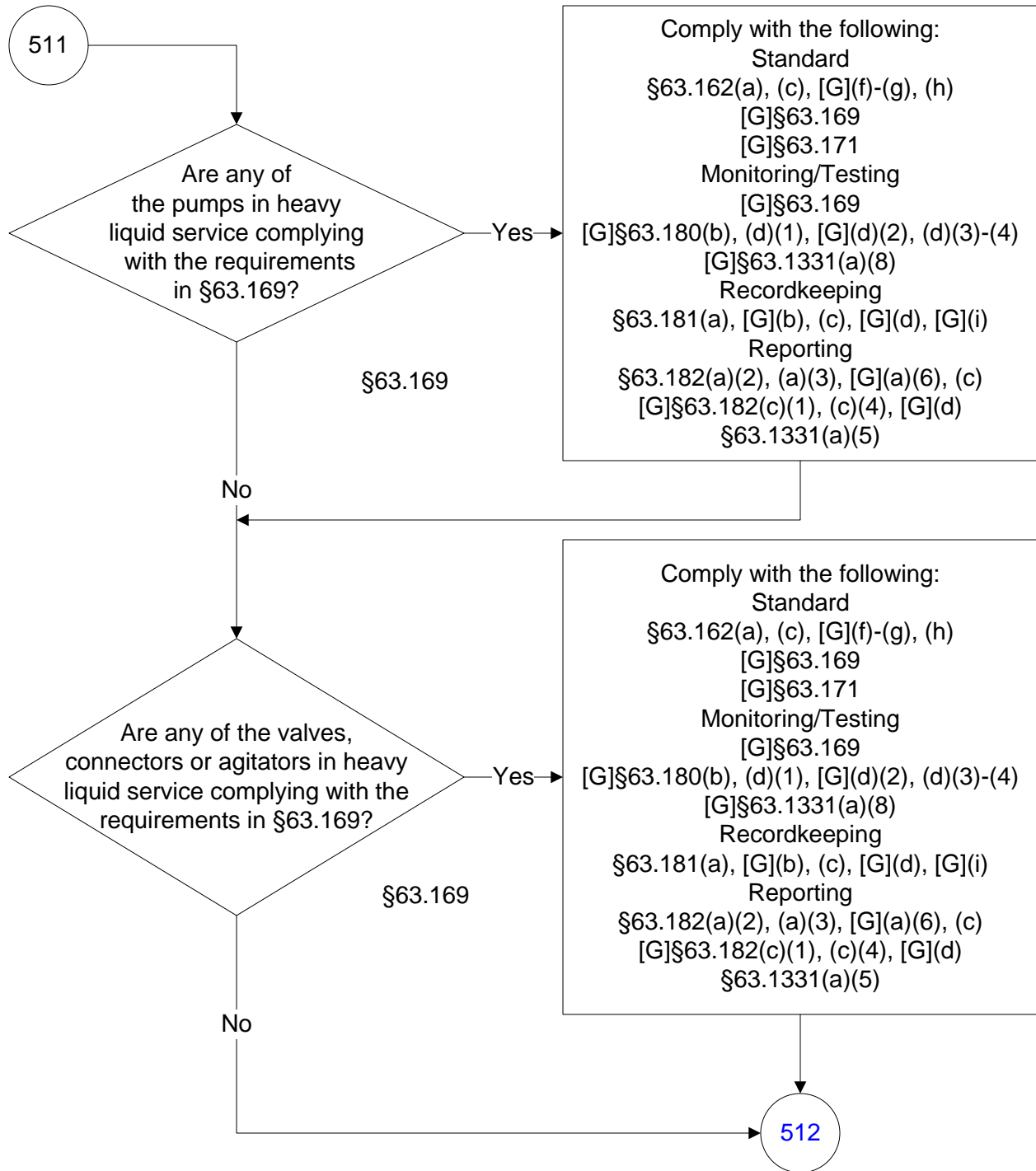

40 CFR Part 63, Subpart JJJ

(187 of 196)

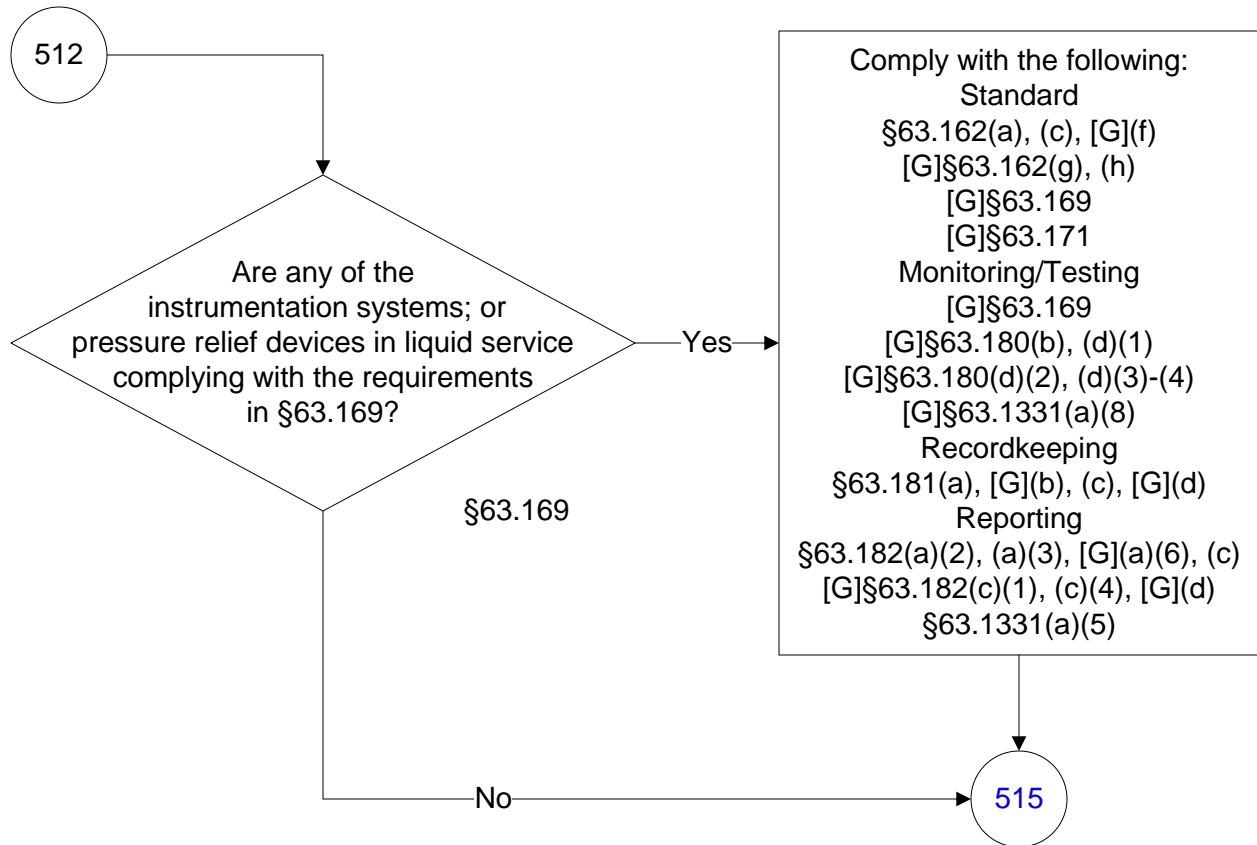

40 CFR Part 63, Subpart JJJ

(188 of 196)

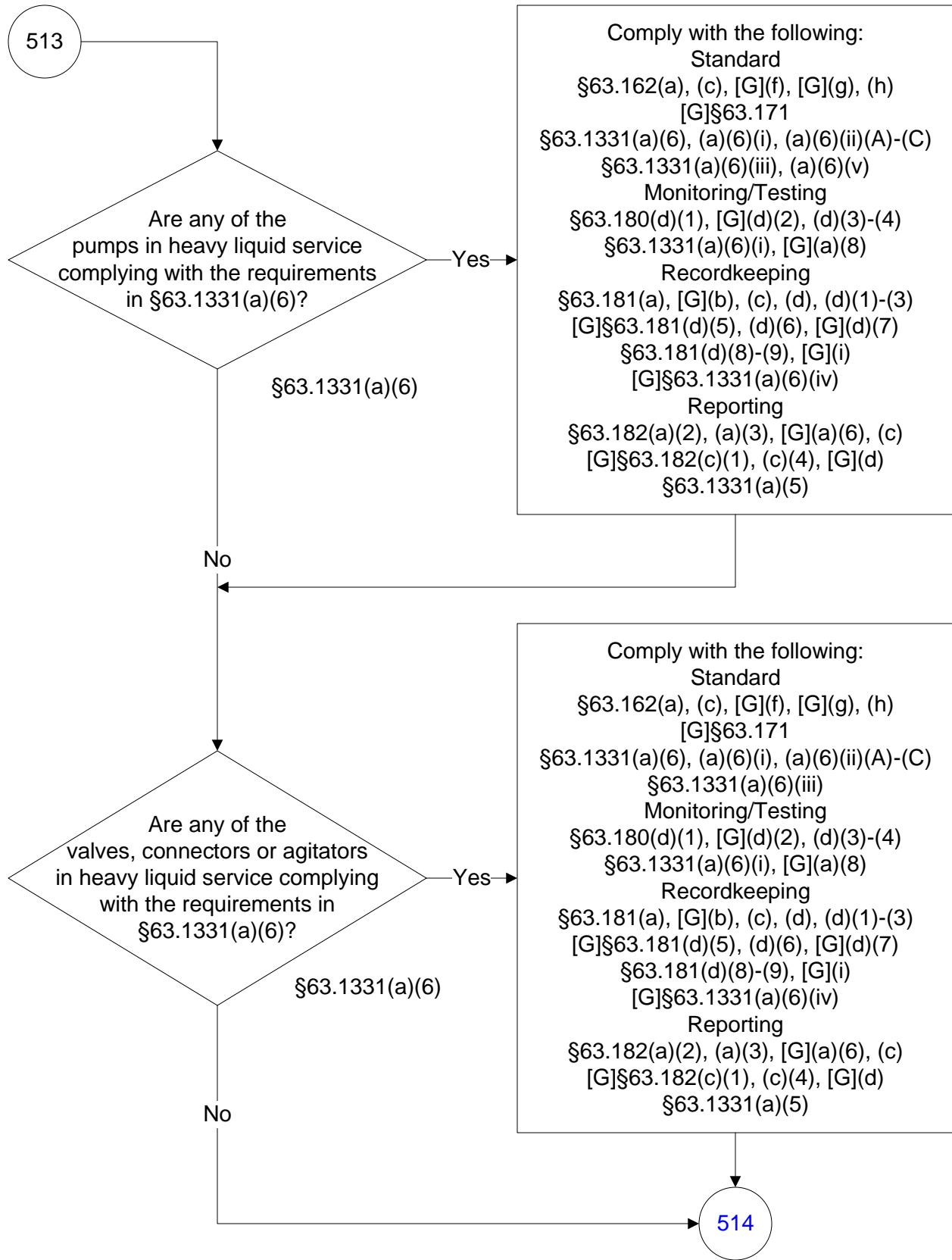

40 CFR Part 63, Subpart JJJ

(189 of 196)

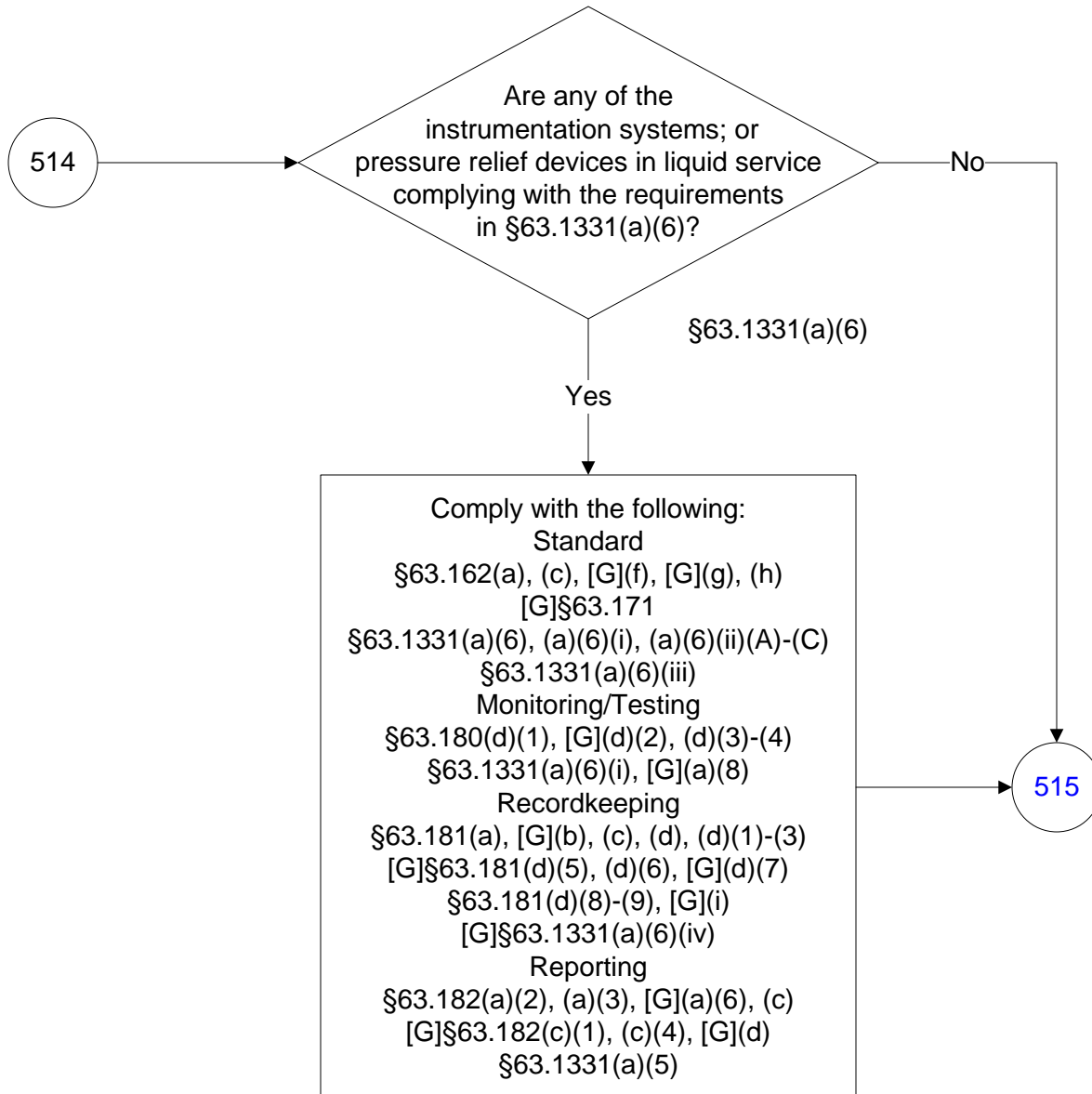

40 CFR Part 63, Subpart JJJ

(190 of 196)

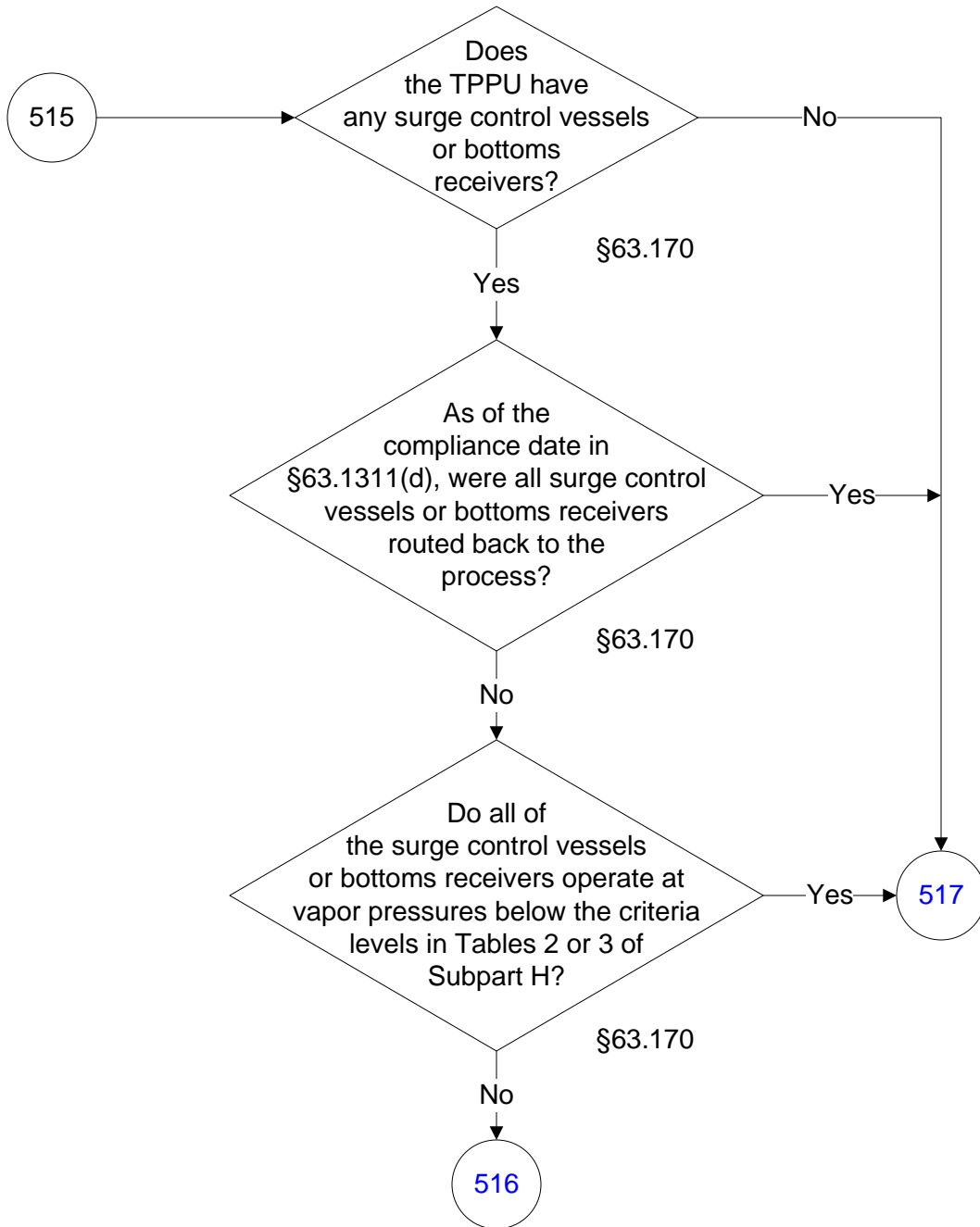

40 CFR Part 63, Subpart JJJ

(191 of 196)

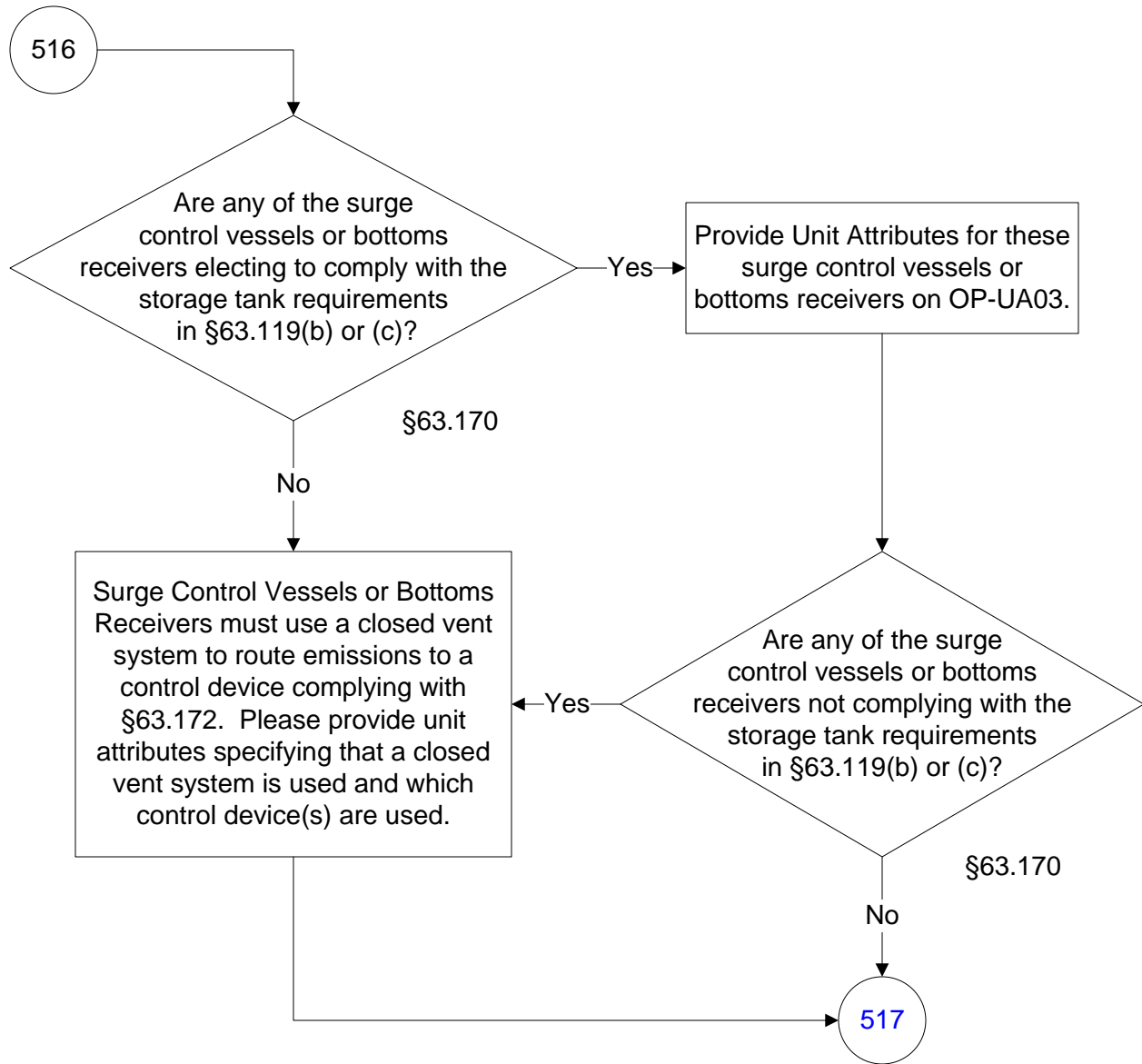

40 CFR Part 63, Subpart JJJ

(192 of 196)

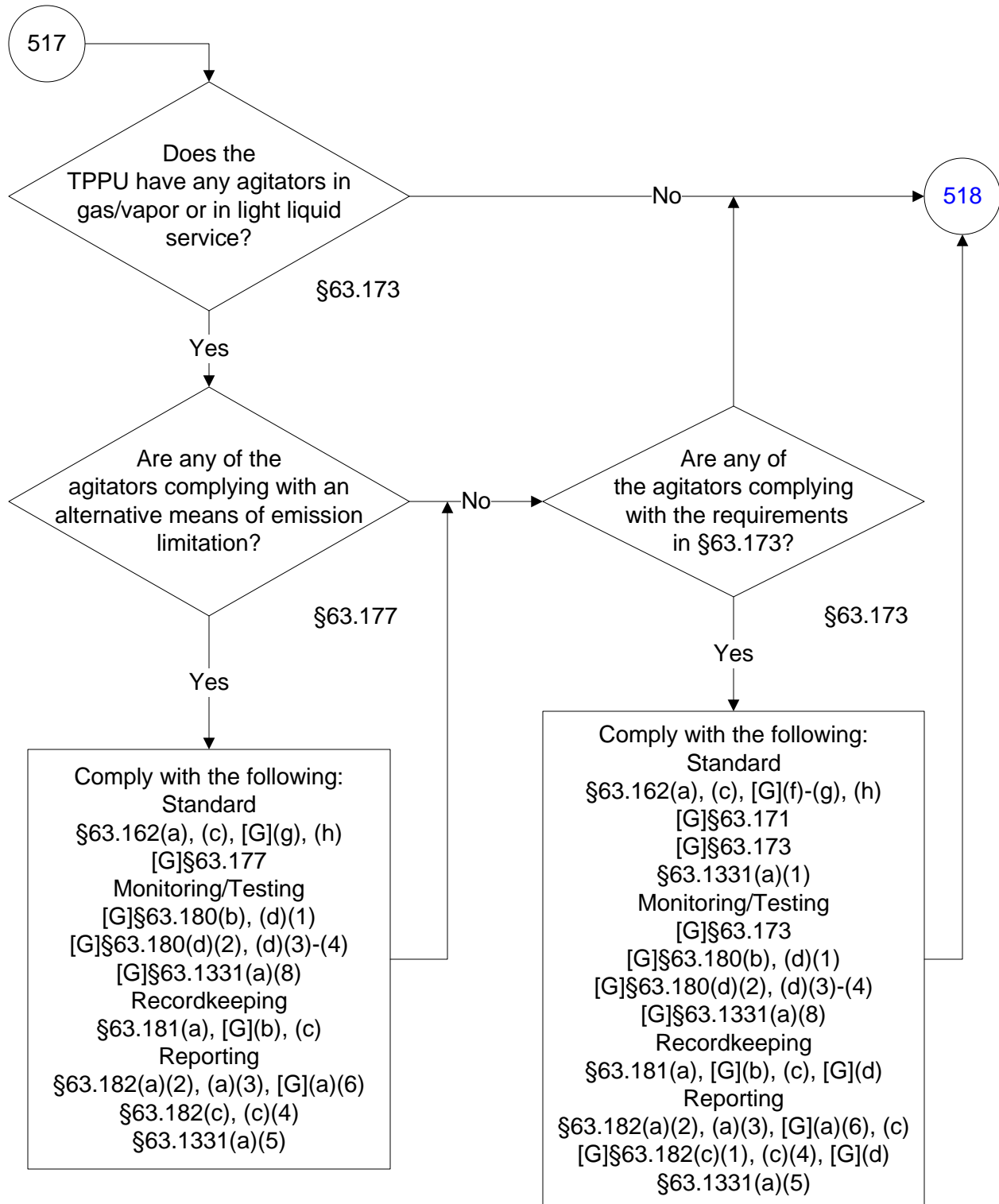

40 CFR Part 63, Subpart JJJ

(193 of 196)

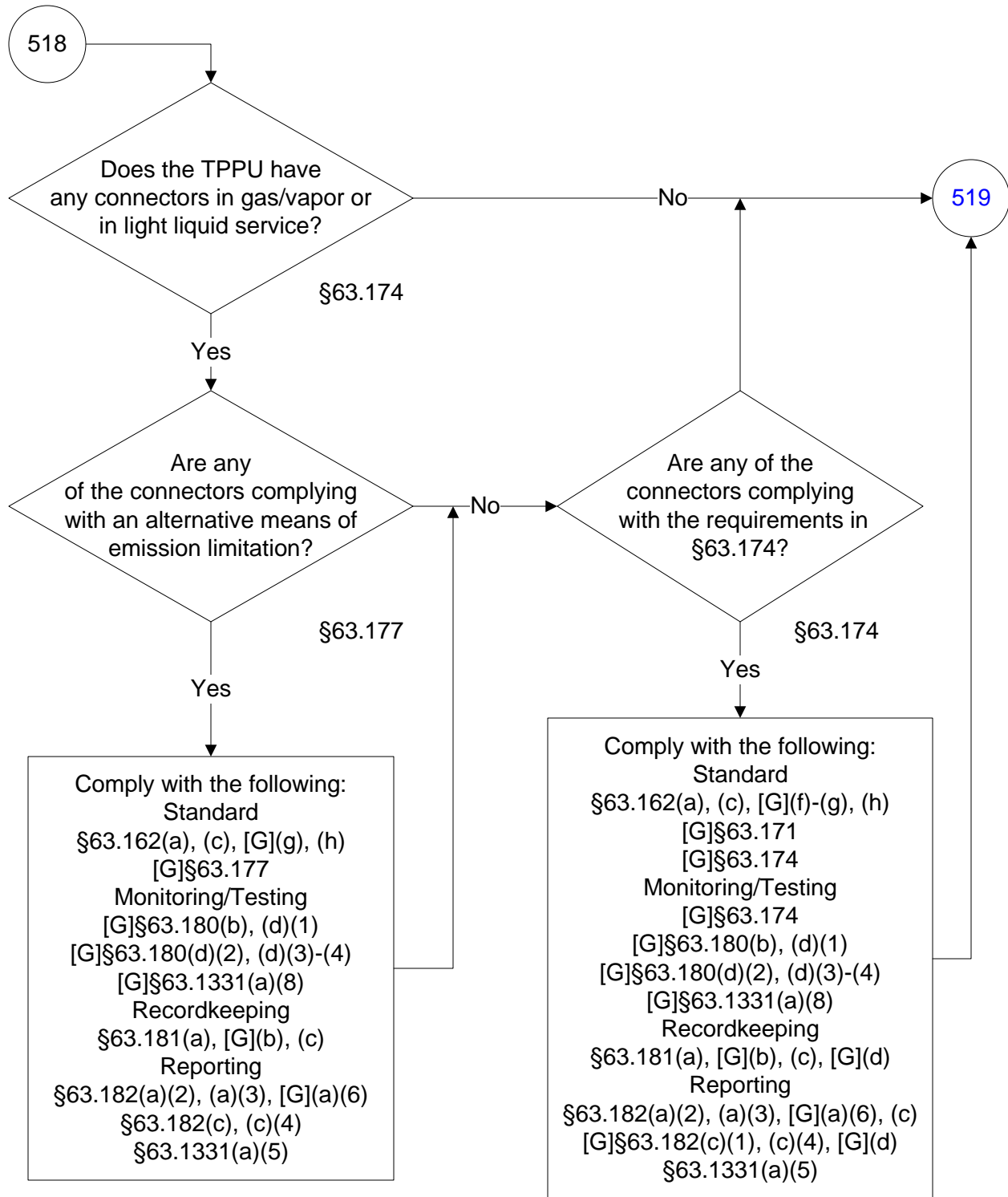

40 CFR Part 63, Subpart JJJ

(194 of 196)

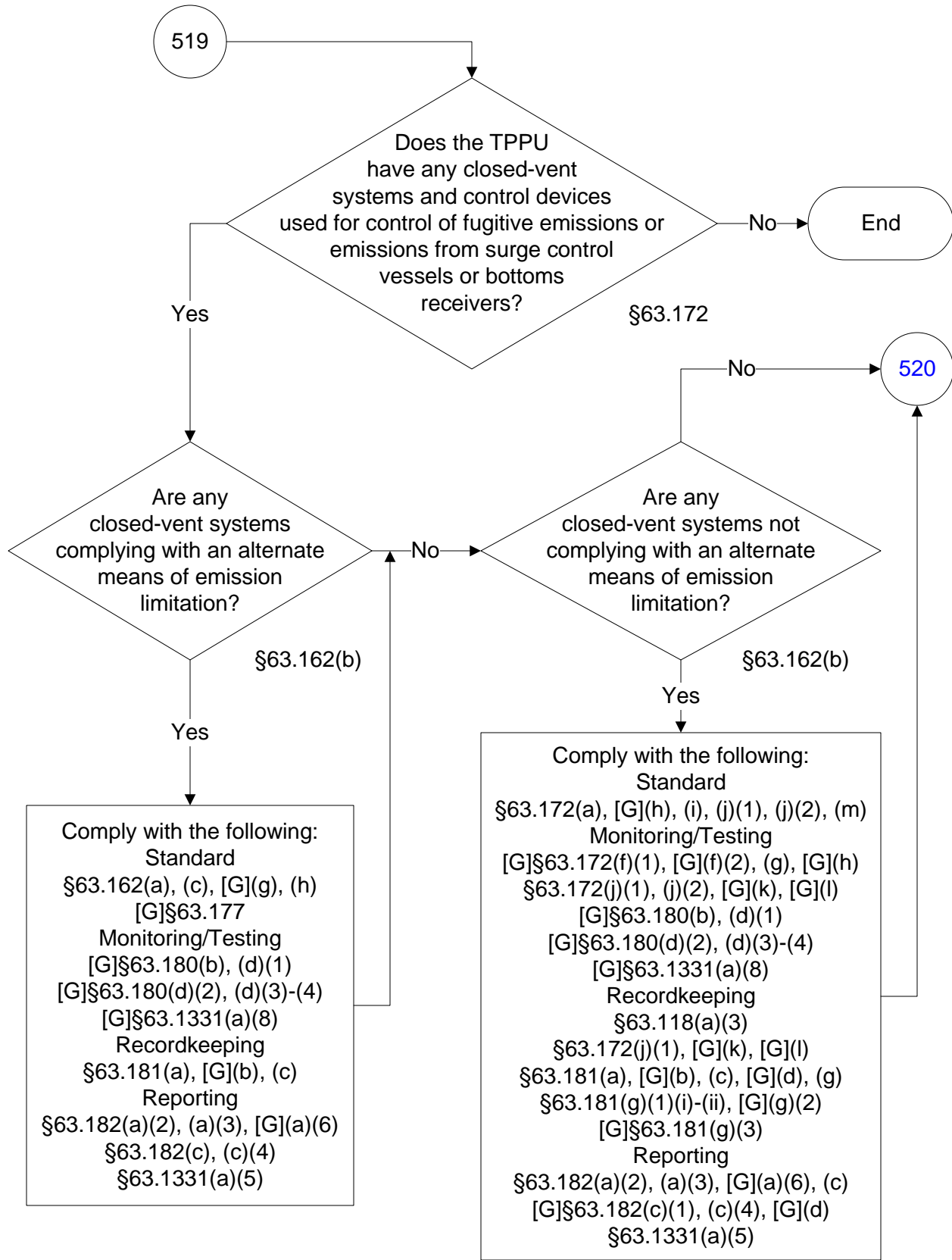

40 CFR Part 63, Subpart JJJ

(195 of 196)

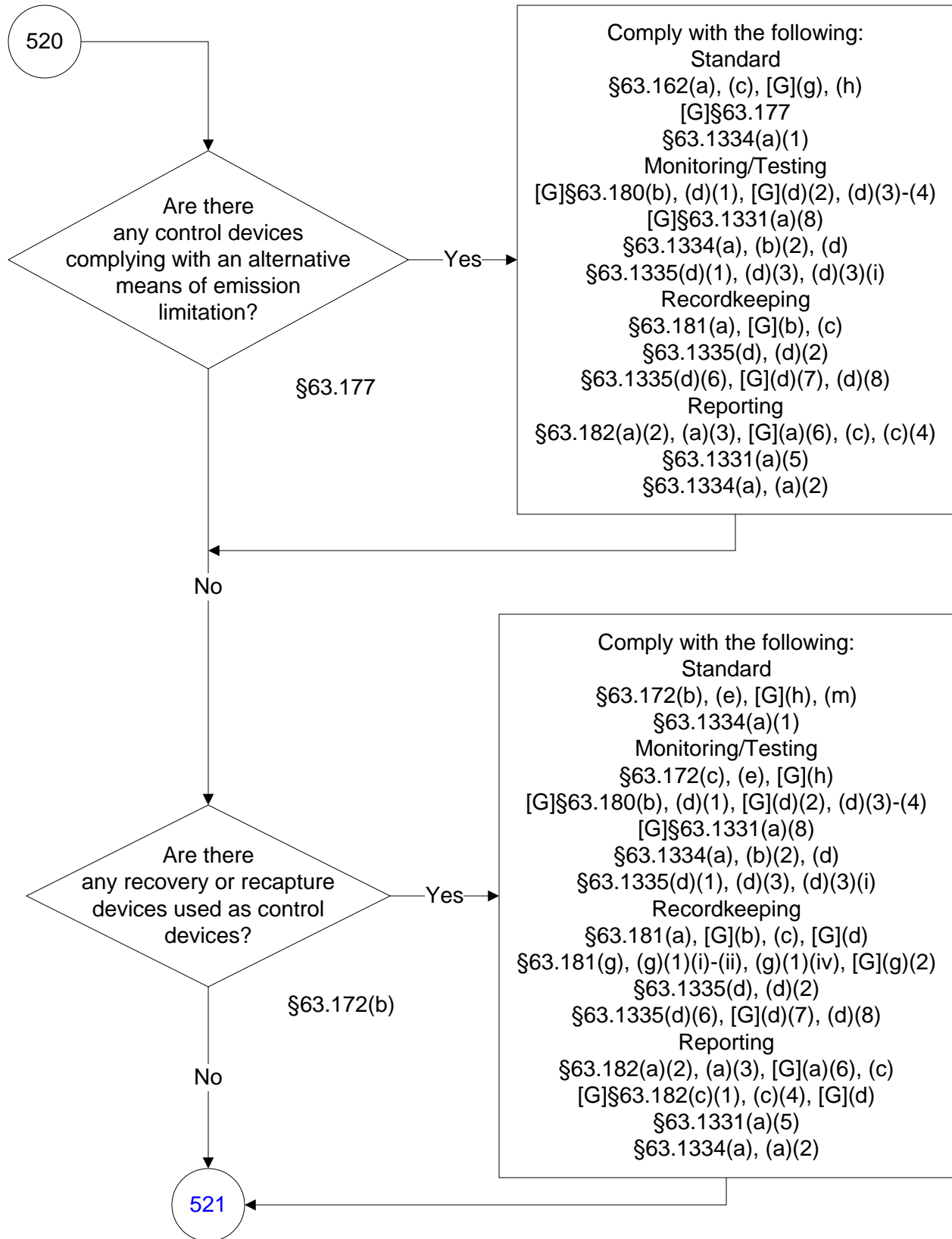

40 CFR Part 63, Subpart JJJ

(196 of 196)

