



Below is a flowchart describing 40 CFR Part 63, Subpart U.

For the text of the statute/rule, please go to

[40 CFR Part 63, Subpart U](#)

(1 of 176)

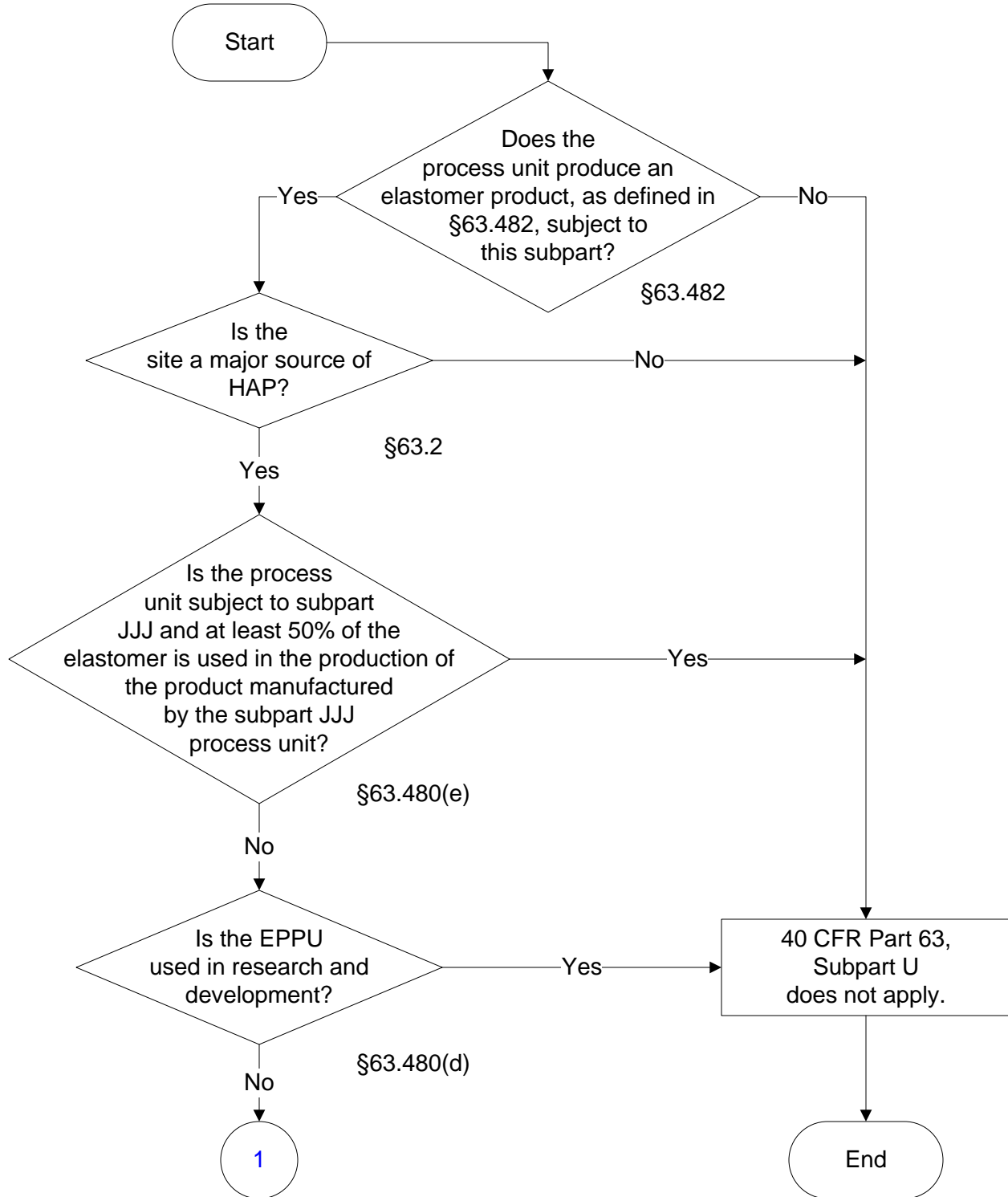

40 CFR Part 63, Subpart U

(2 of 176)

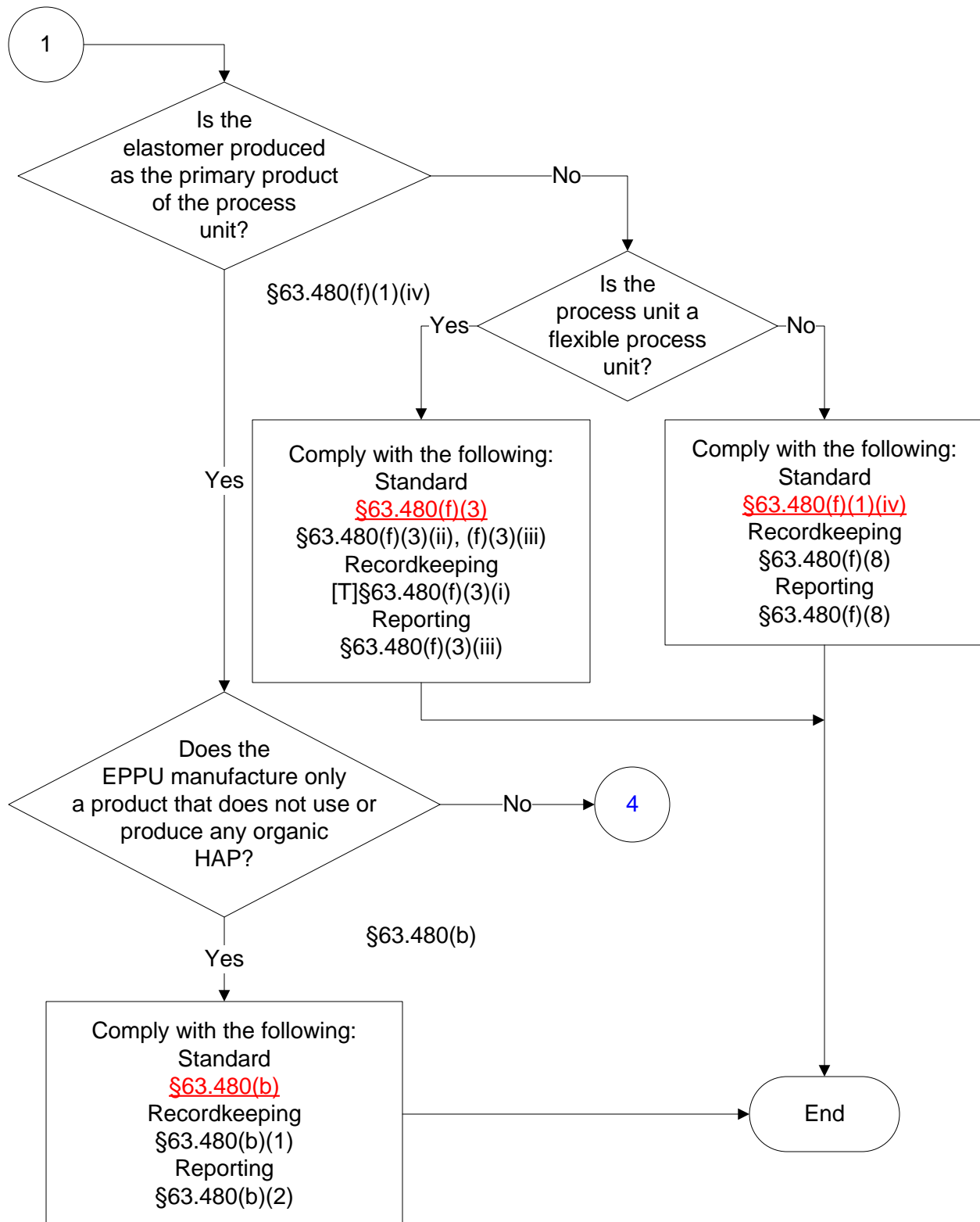

40 CFR Part 63, Subpart U

(3 of 176)

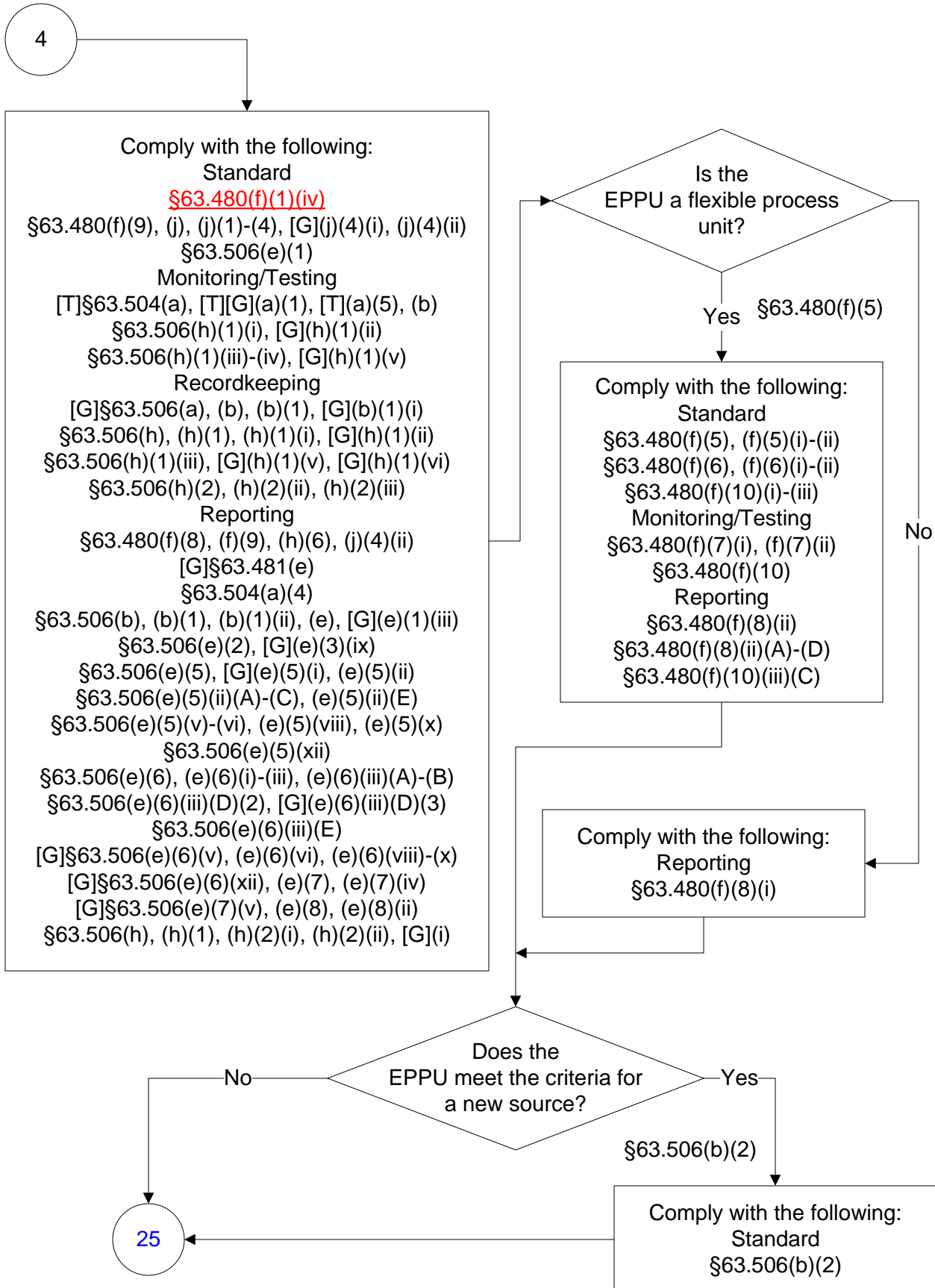

40 CFR Part 63, Subpart U

(4 of 176)

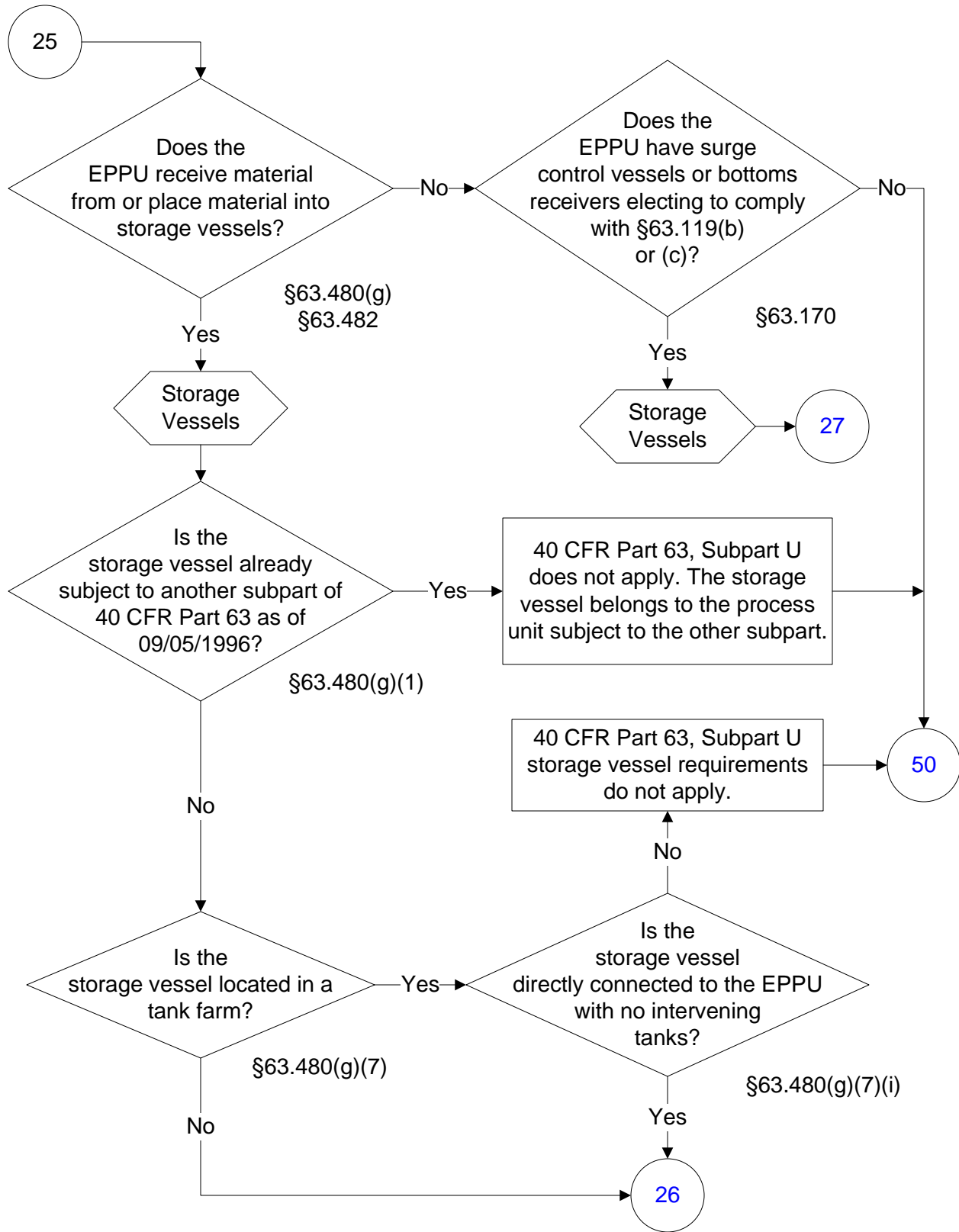

40 CFR Part 63, Subpart U

(5 of 176)

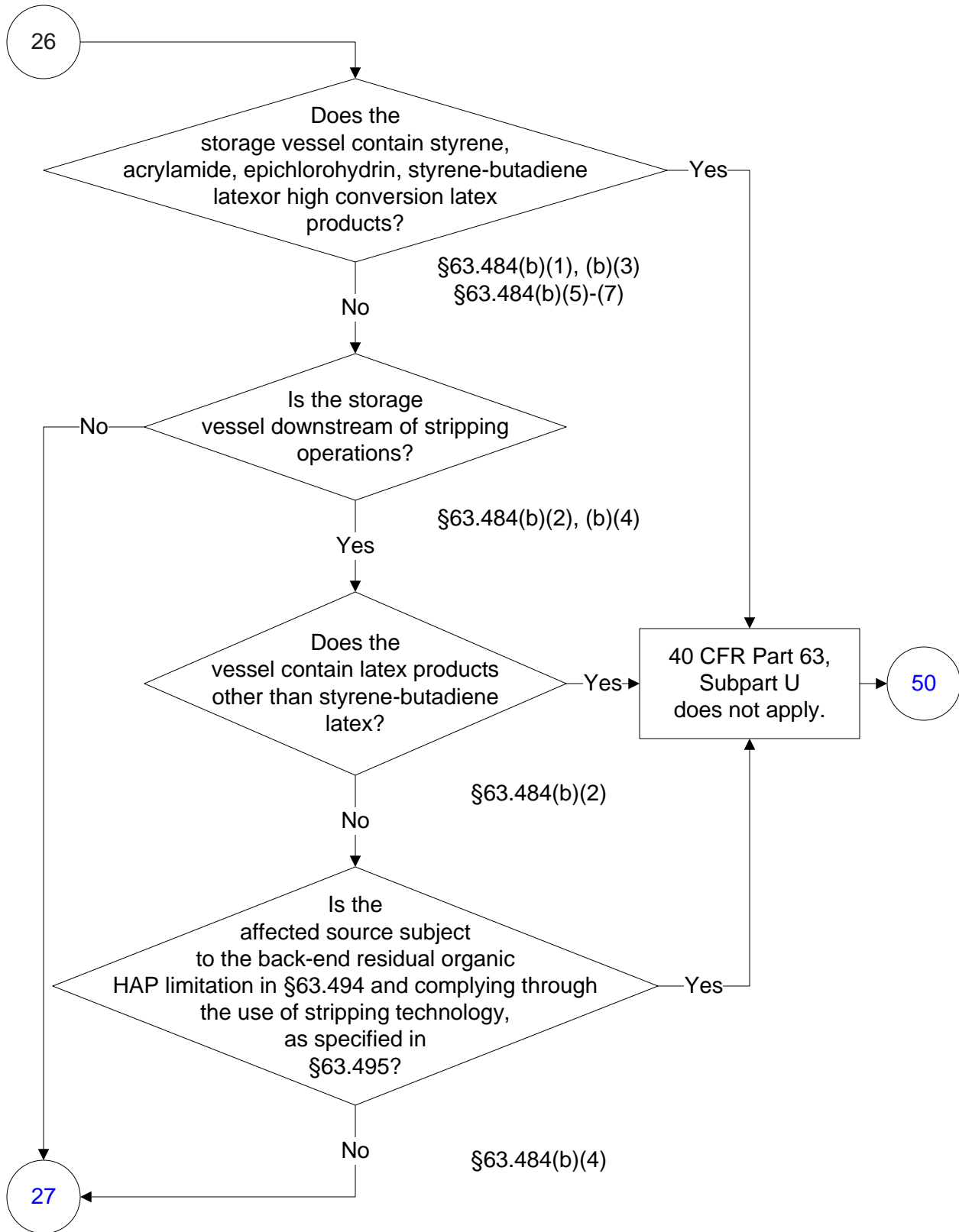

40 CFR Part 63, Subpart U

(6 of 176)

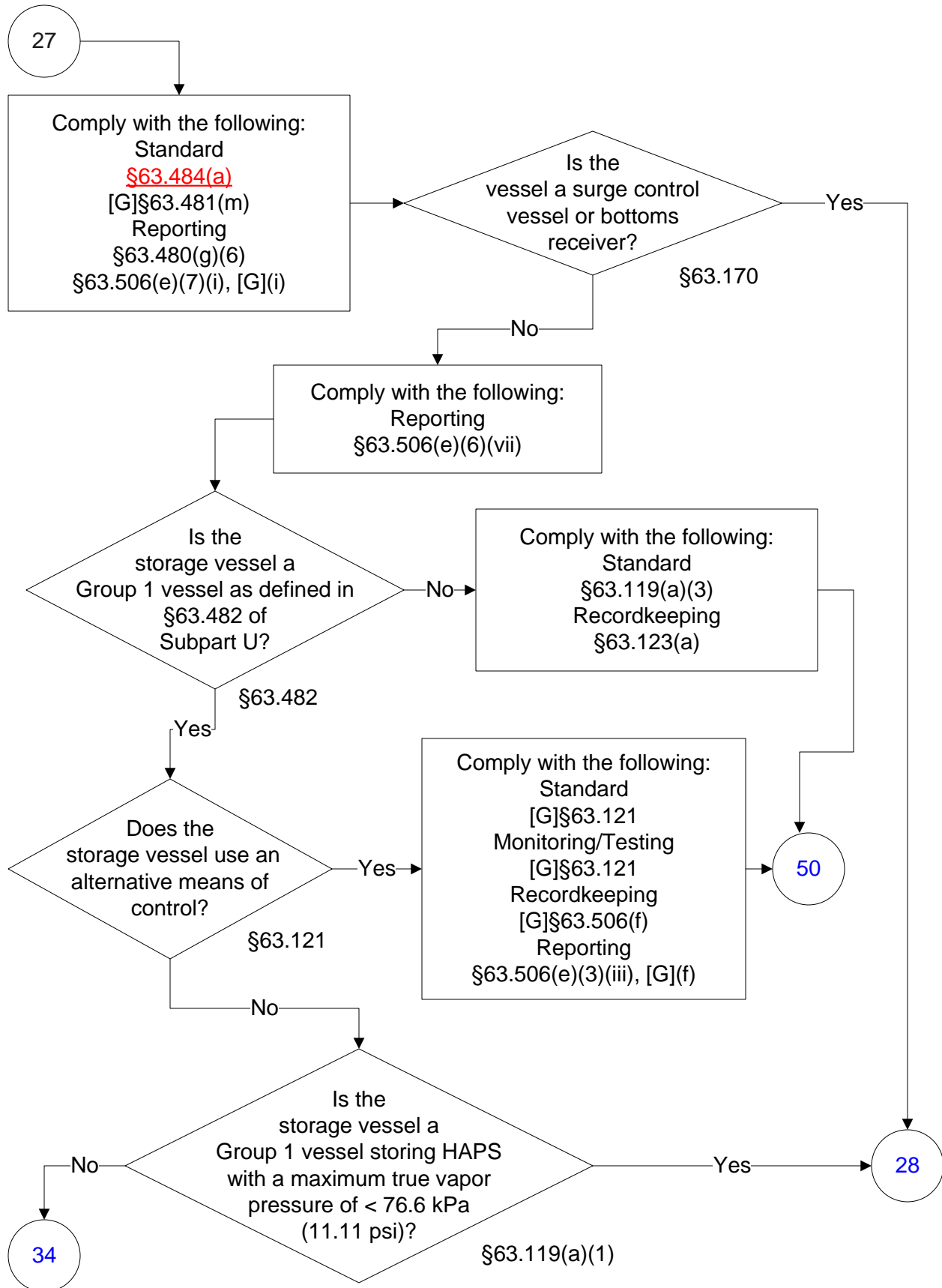

40 CFR Part 63, Subpart U

(7 of 176)

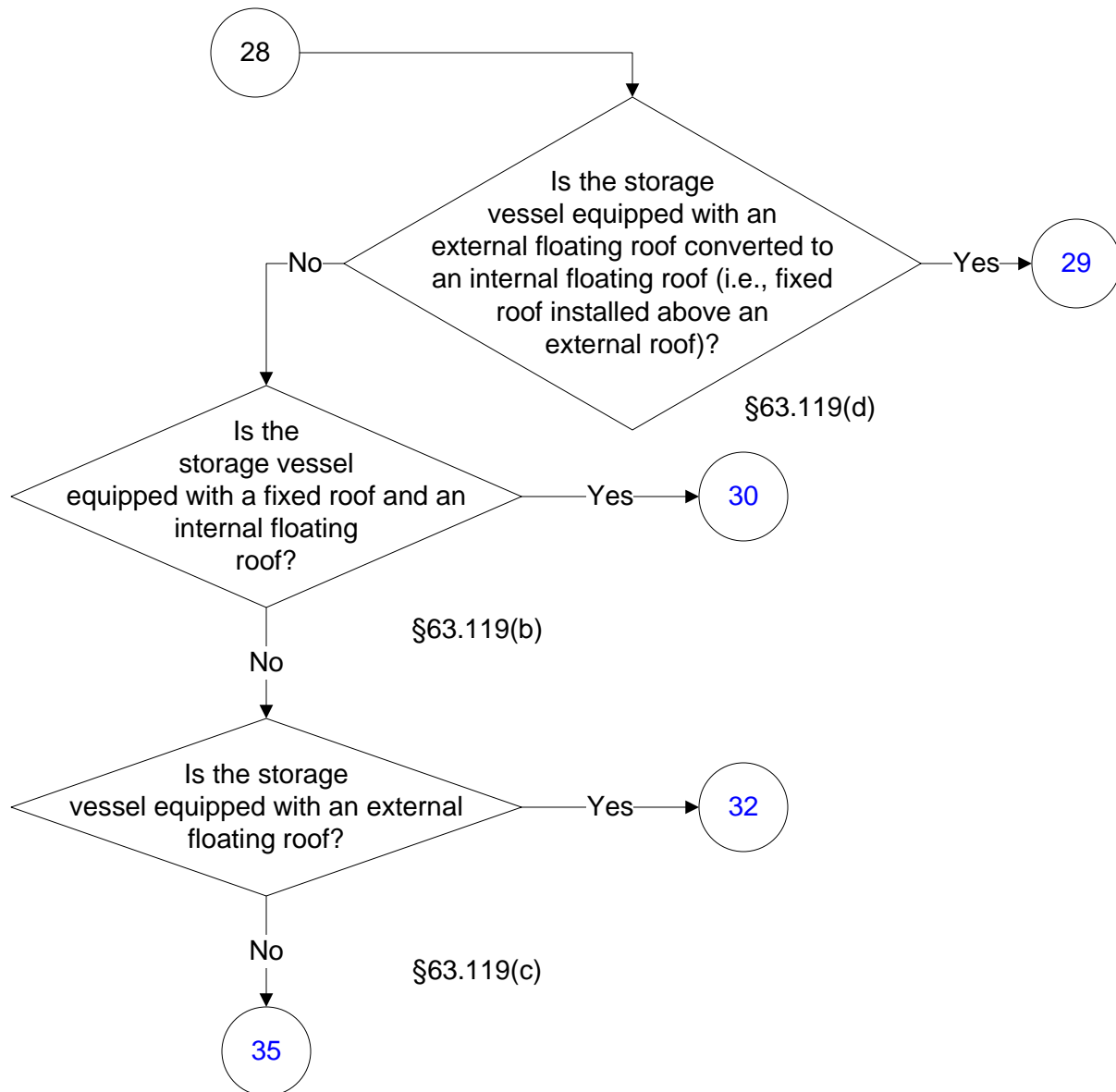

40 CFR Part 63, Subpart U

(8 of 176)

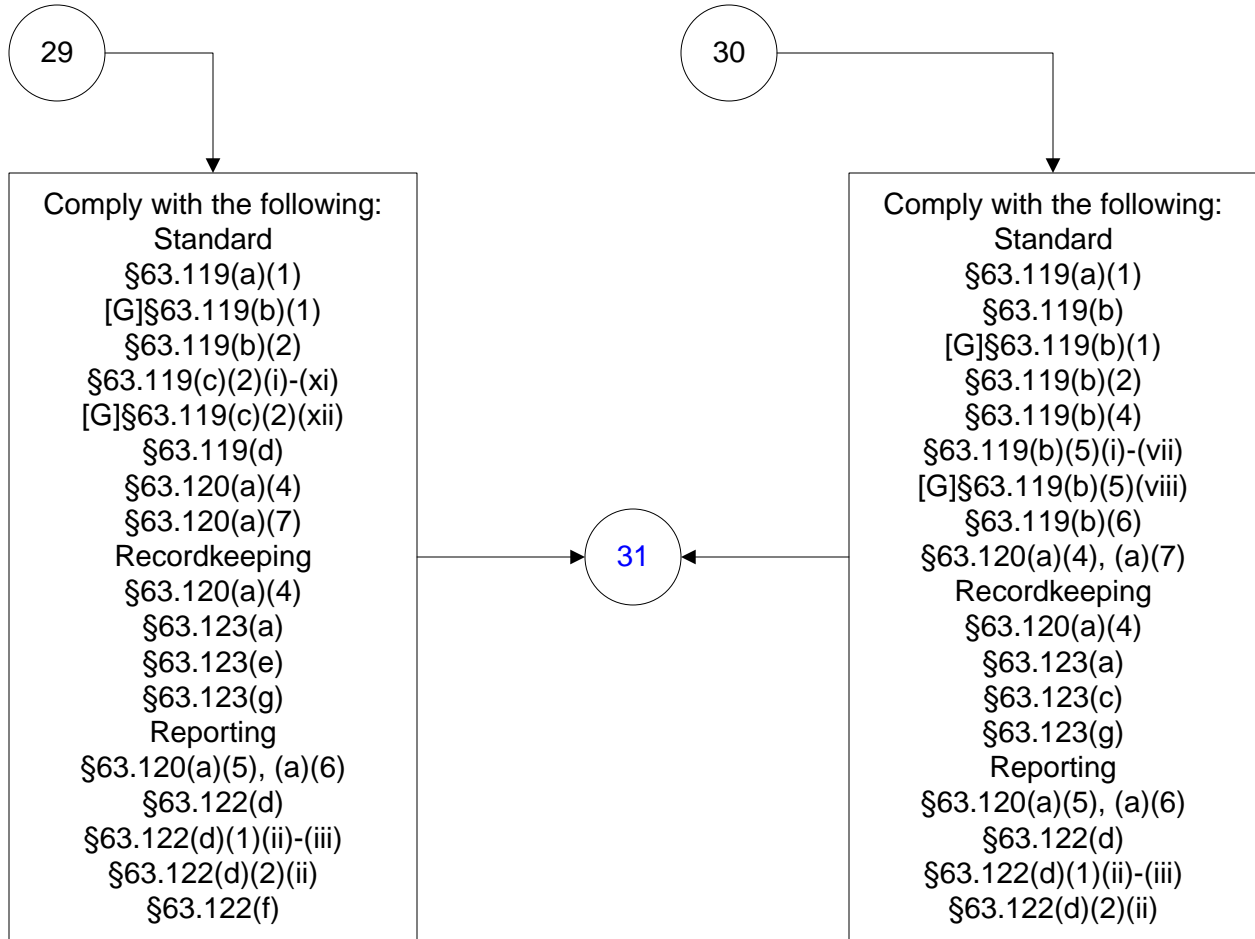

40 CFR Part 63, Subpart U

(9 of 176)

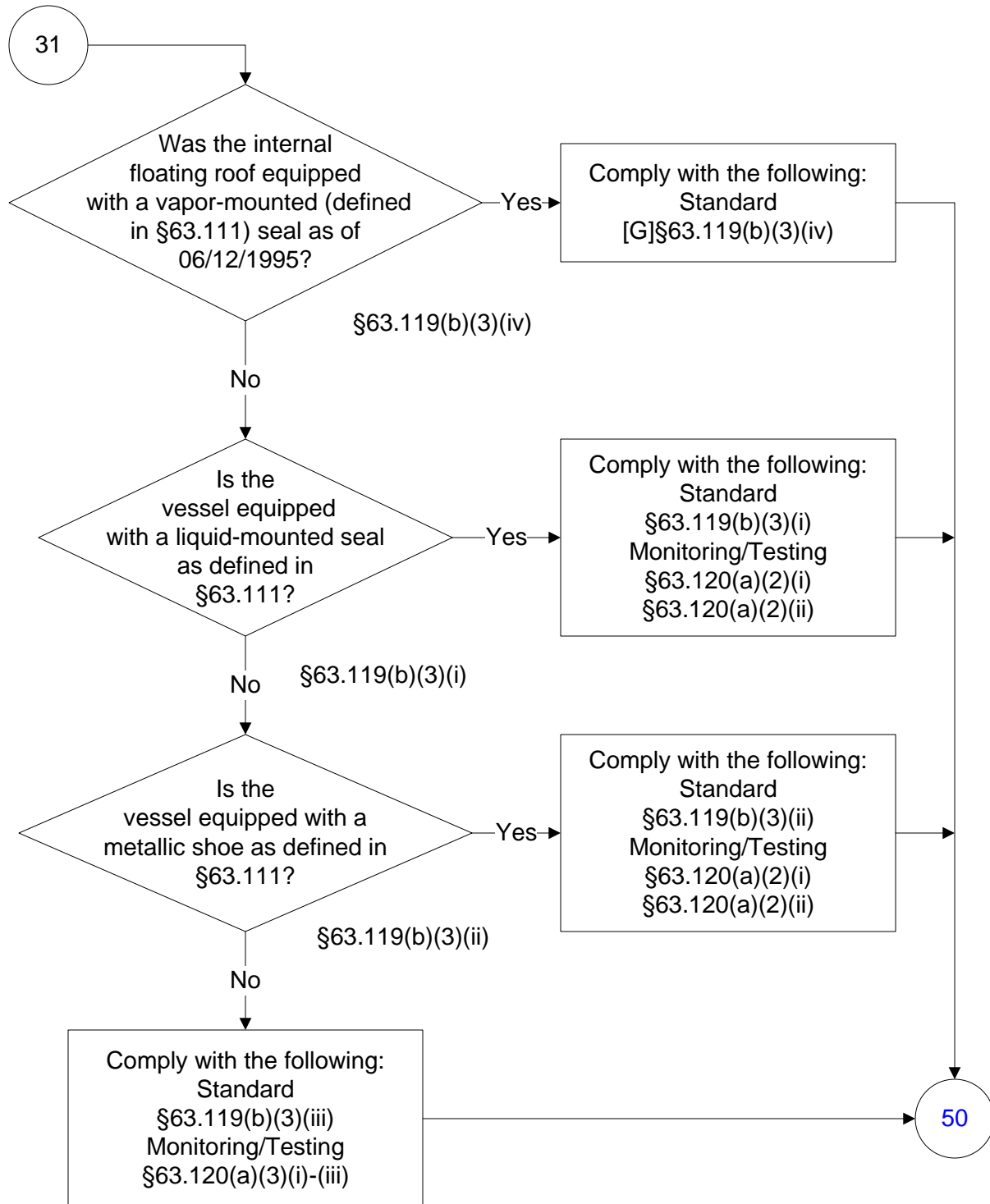

40 CFR Part 63, Subpart U

(10 of 176)

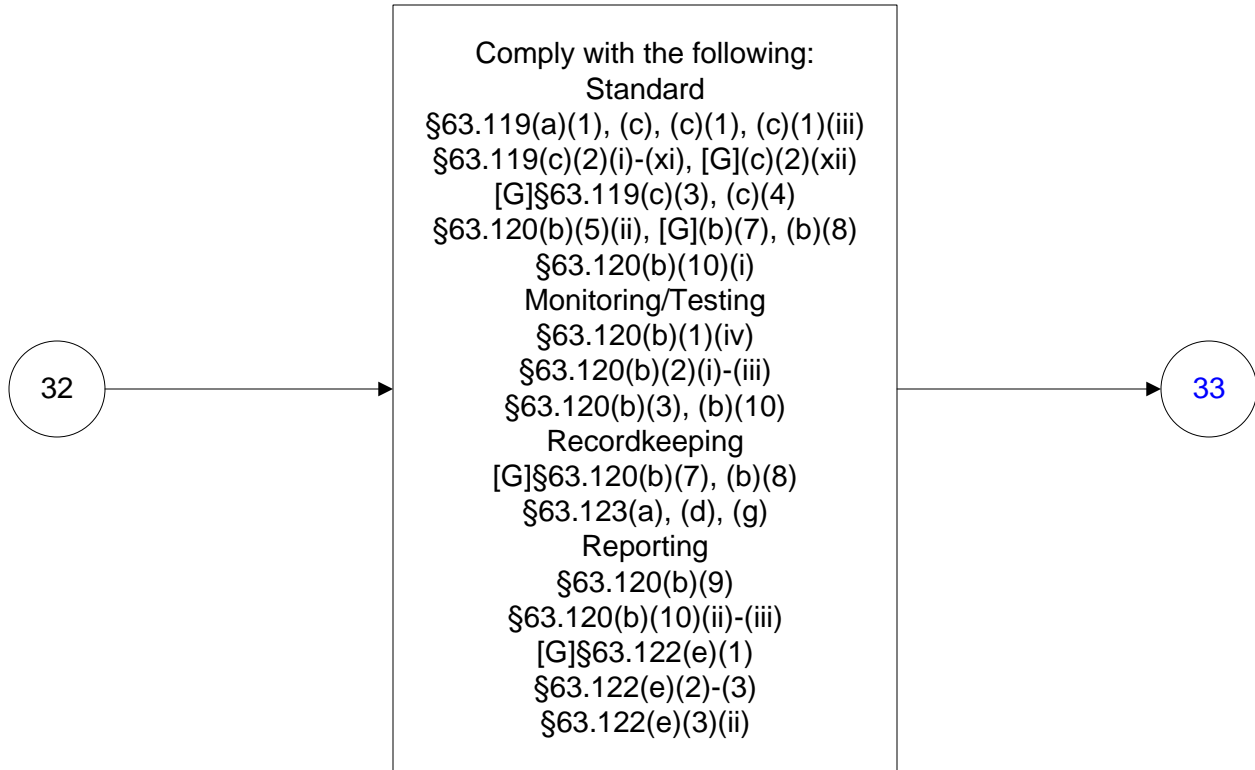

40 CFR Part 63, Subpart U

(11 of 176)

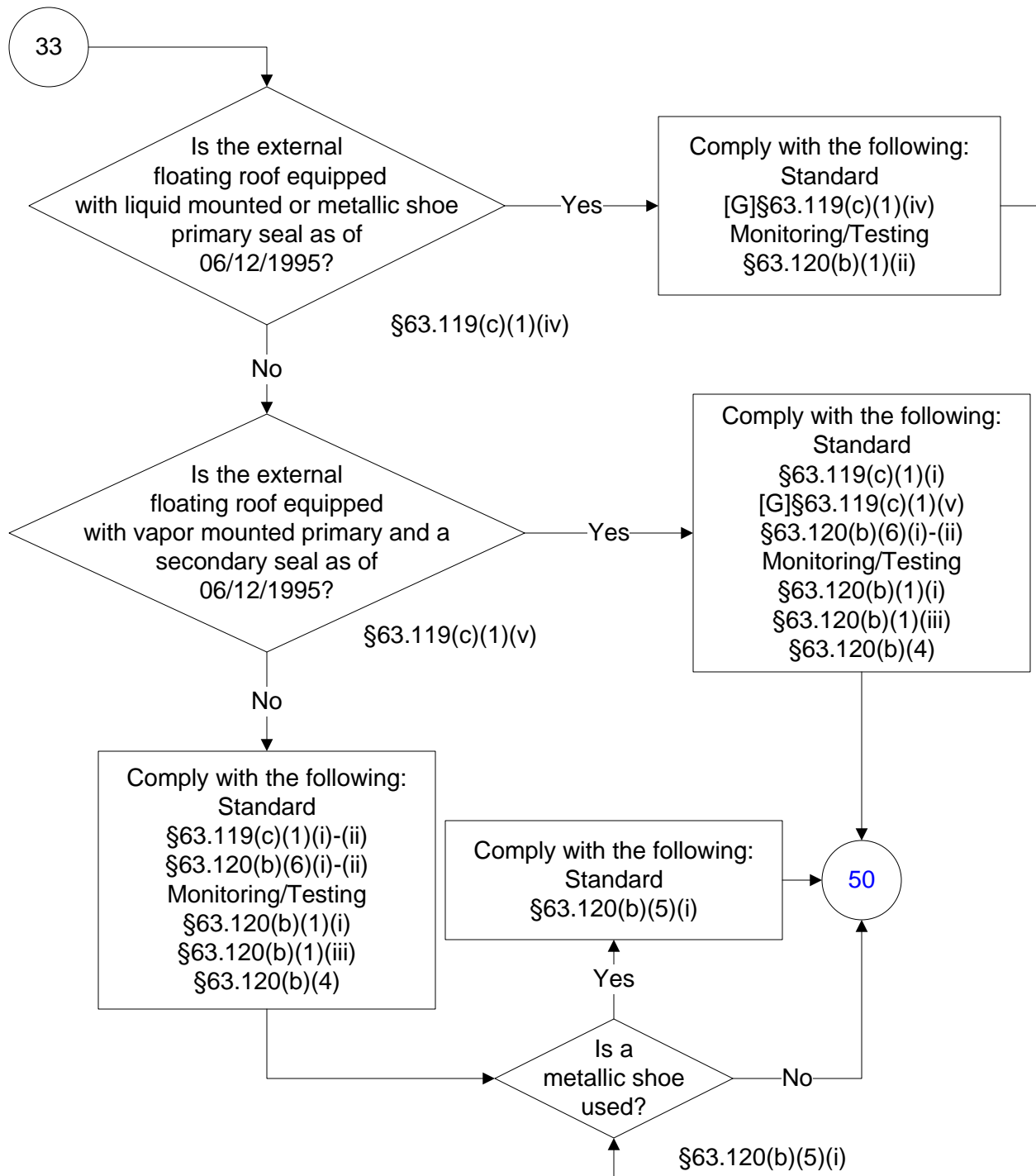

40 CFR Part 63, Subpart U

(12 of 176)

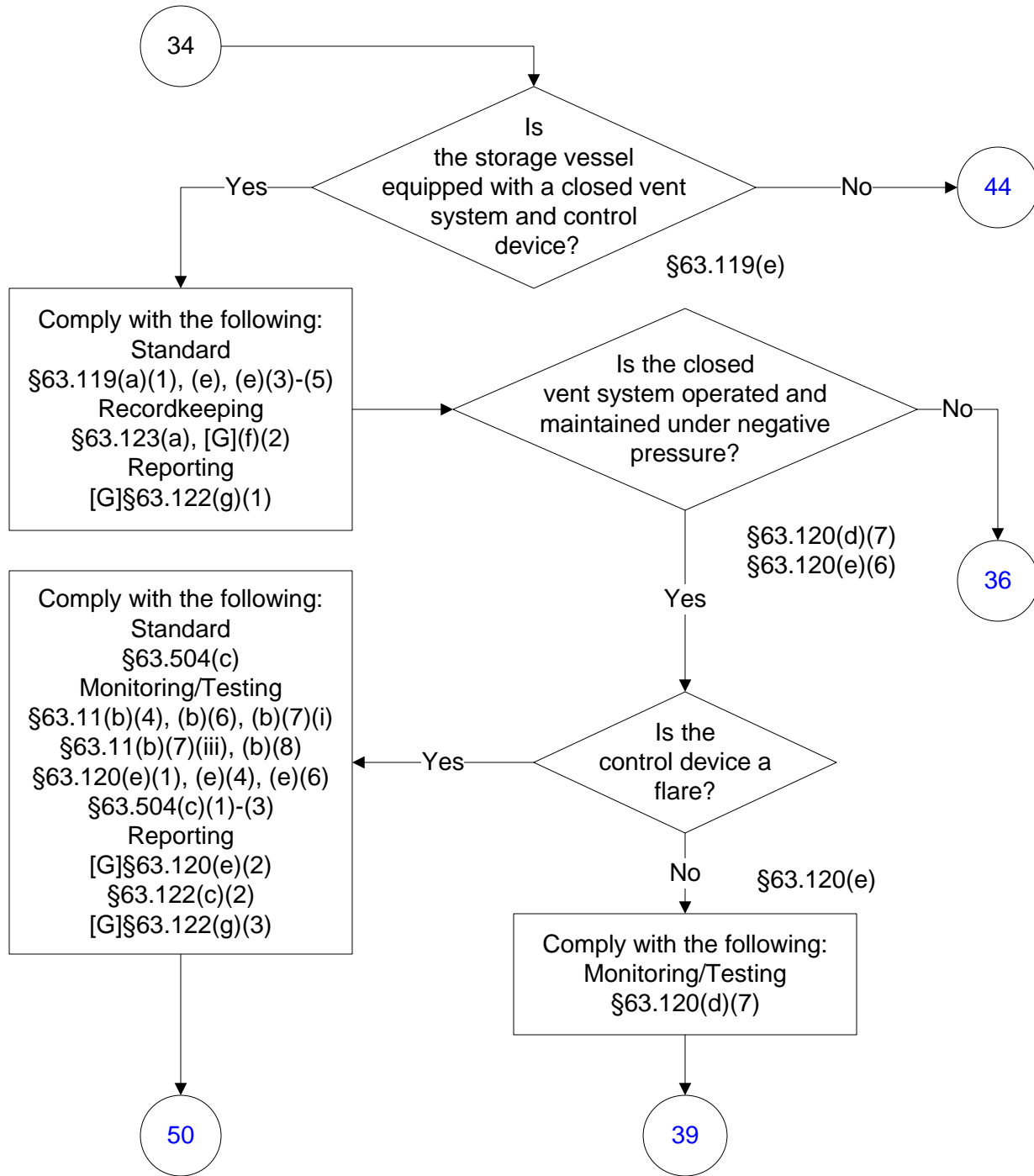

40 CFR Part 63, Subpart U

(13 of 176)

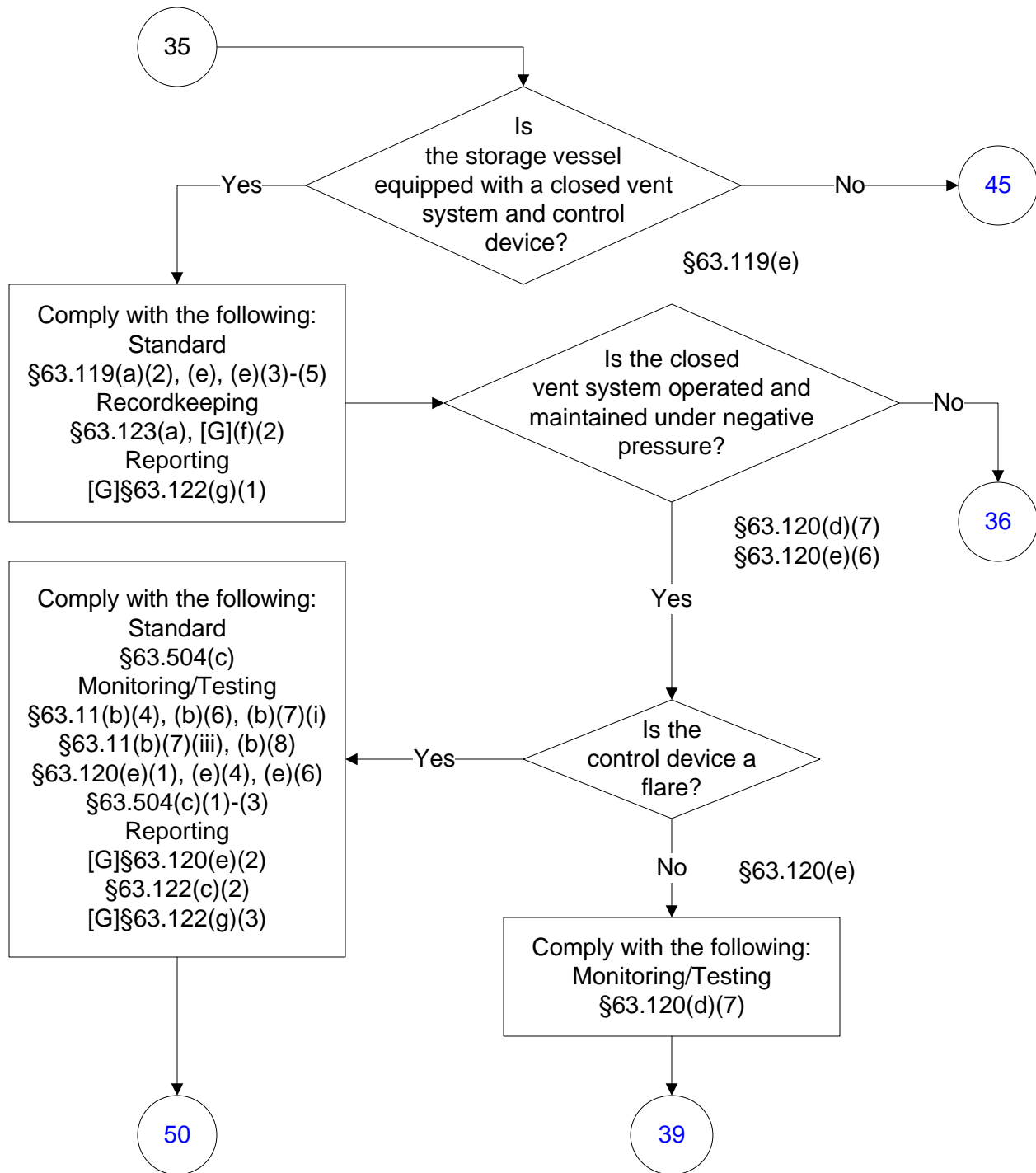

40 CFR Part 63, Subpart U

(14 of 176)

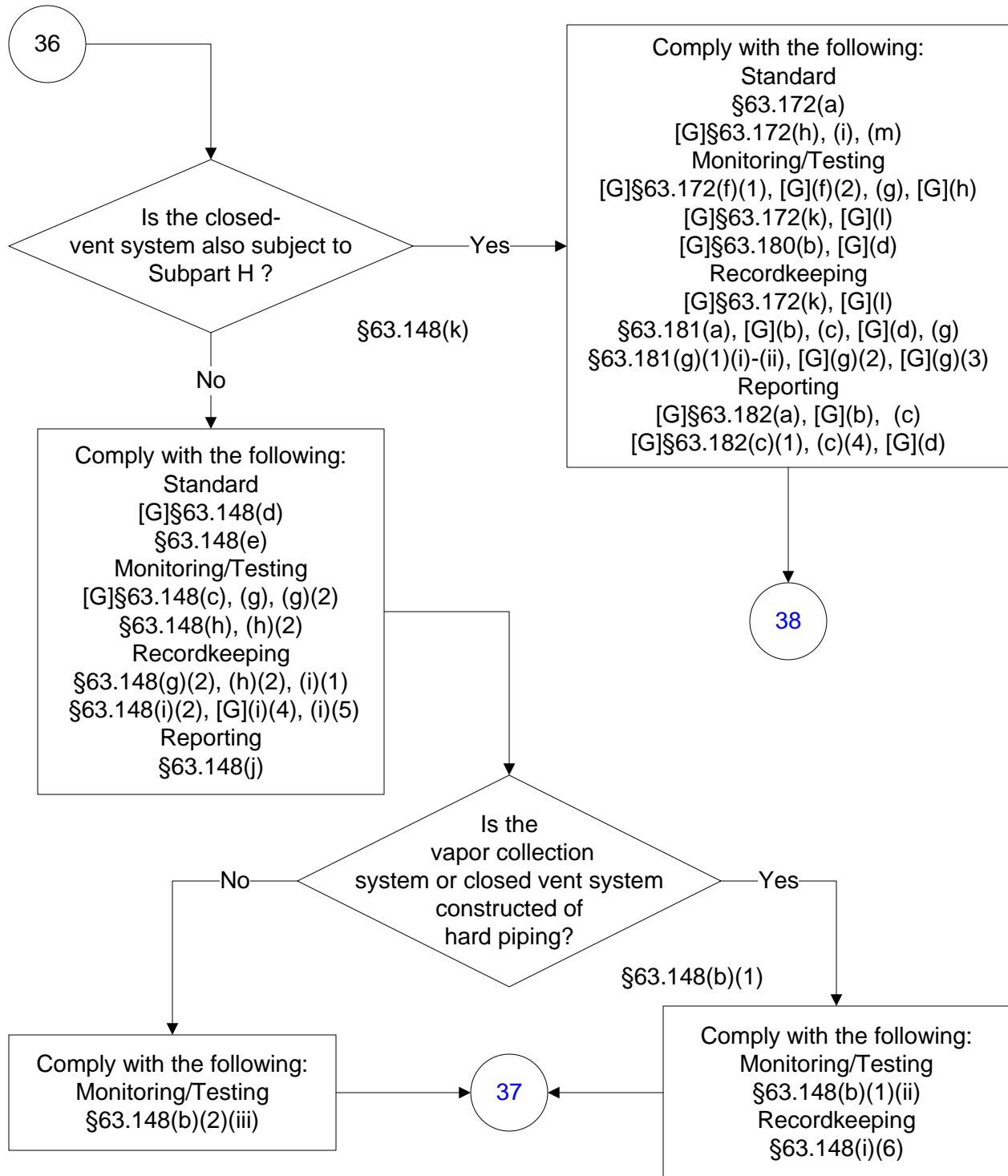

40 CFR Part 63, Subpart U

(15 of 176)

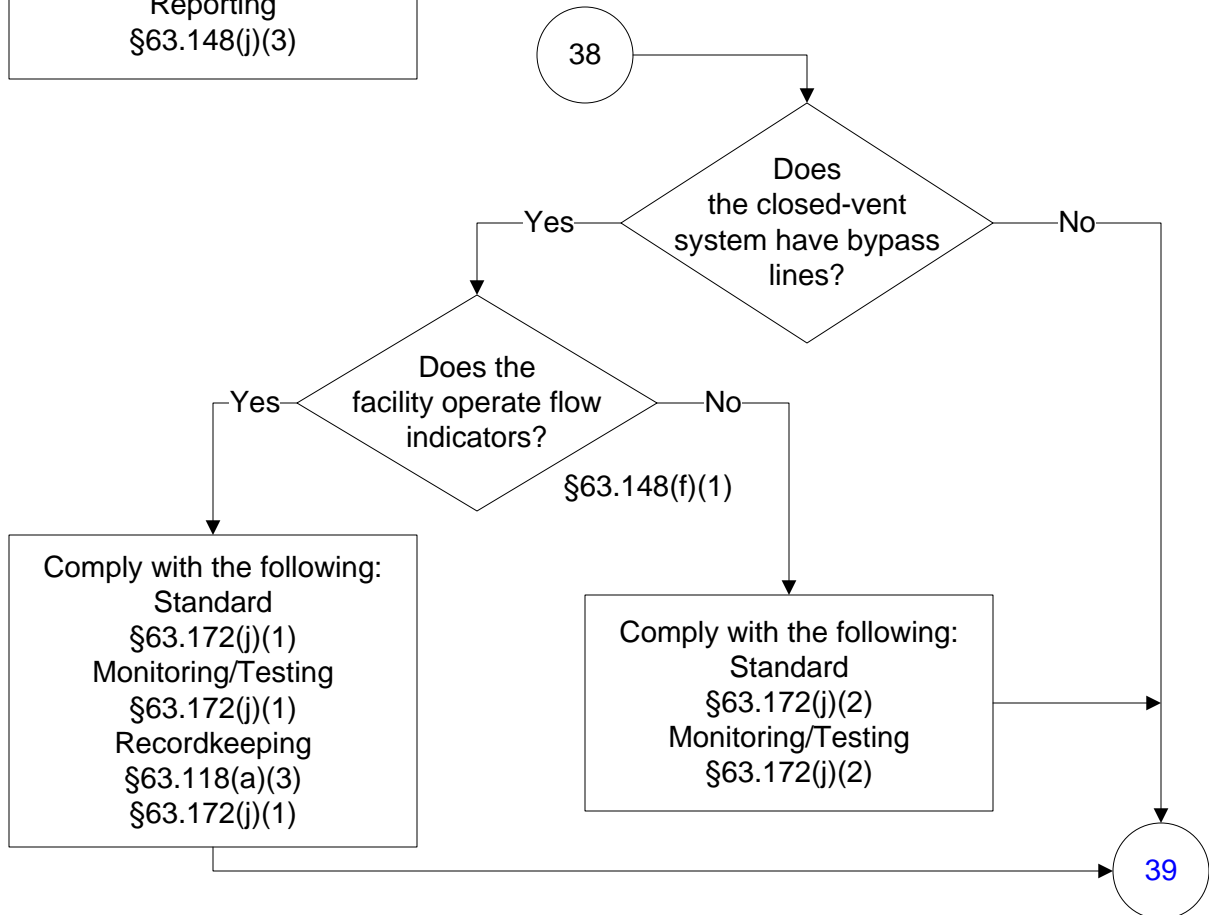
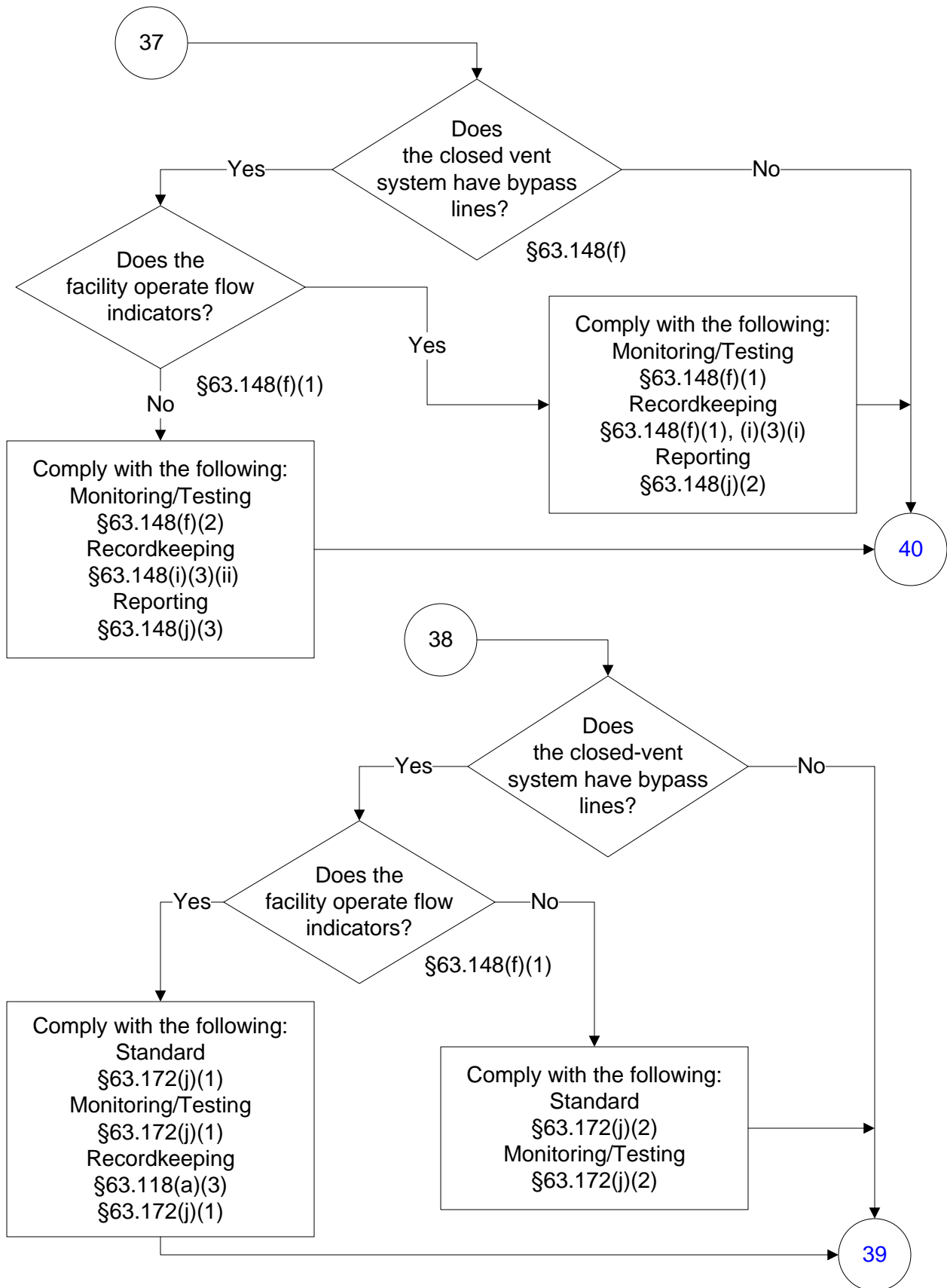

40 CFR Part 63, Subpart U

(16 of 176)

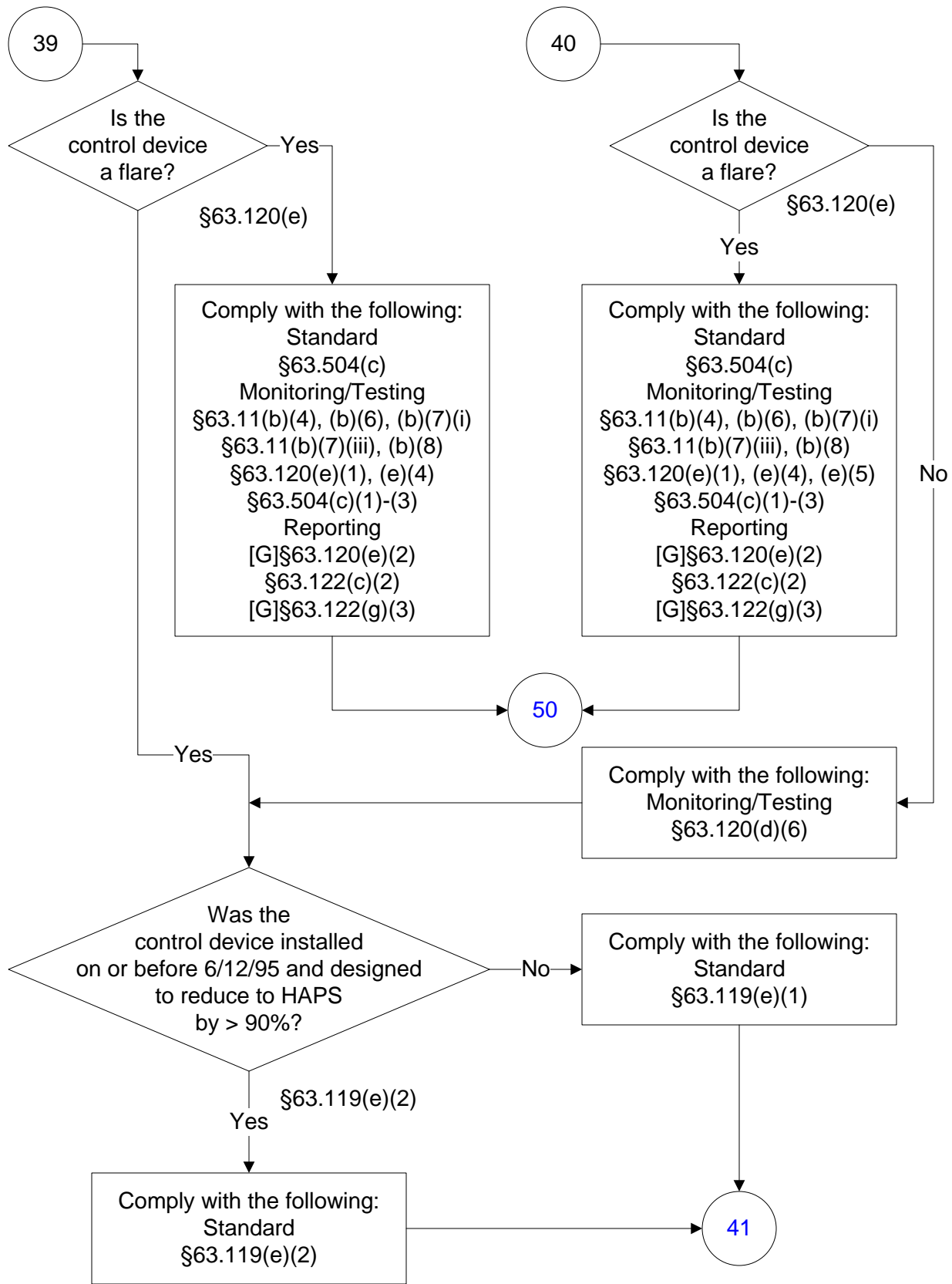

40 CFR Part 63, Subpart U

(17 of 176)

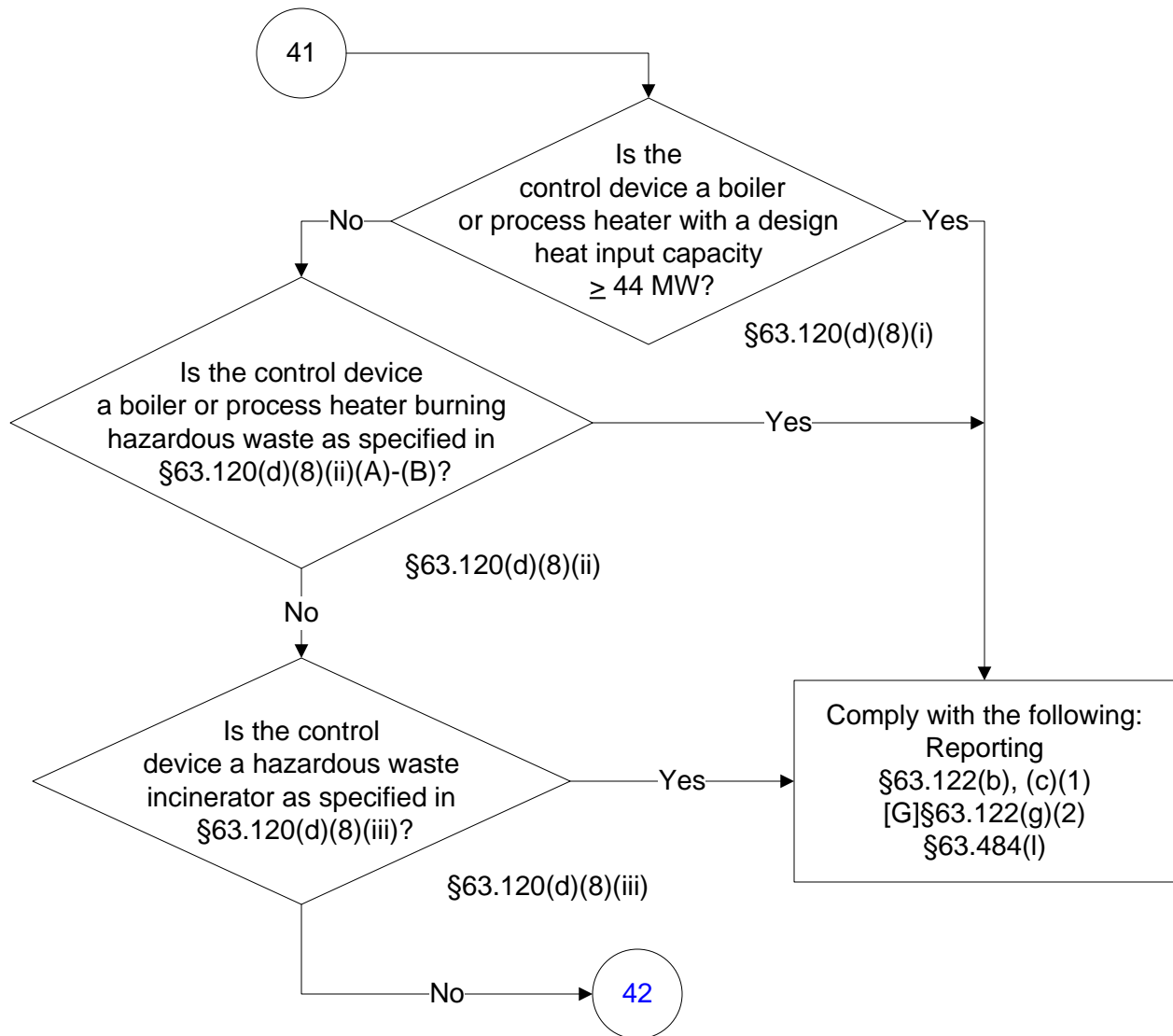

40 CFR Part 63, Subpart U

(18 of 176)

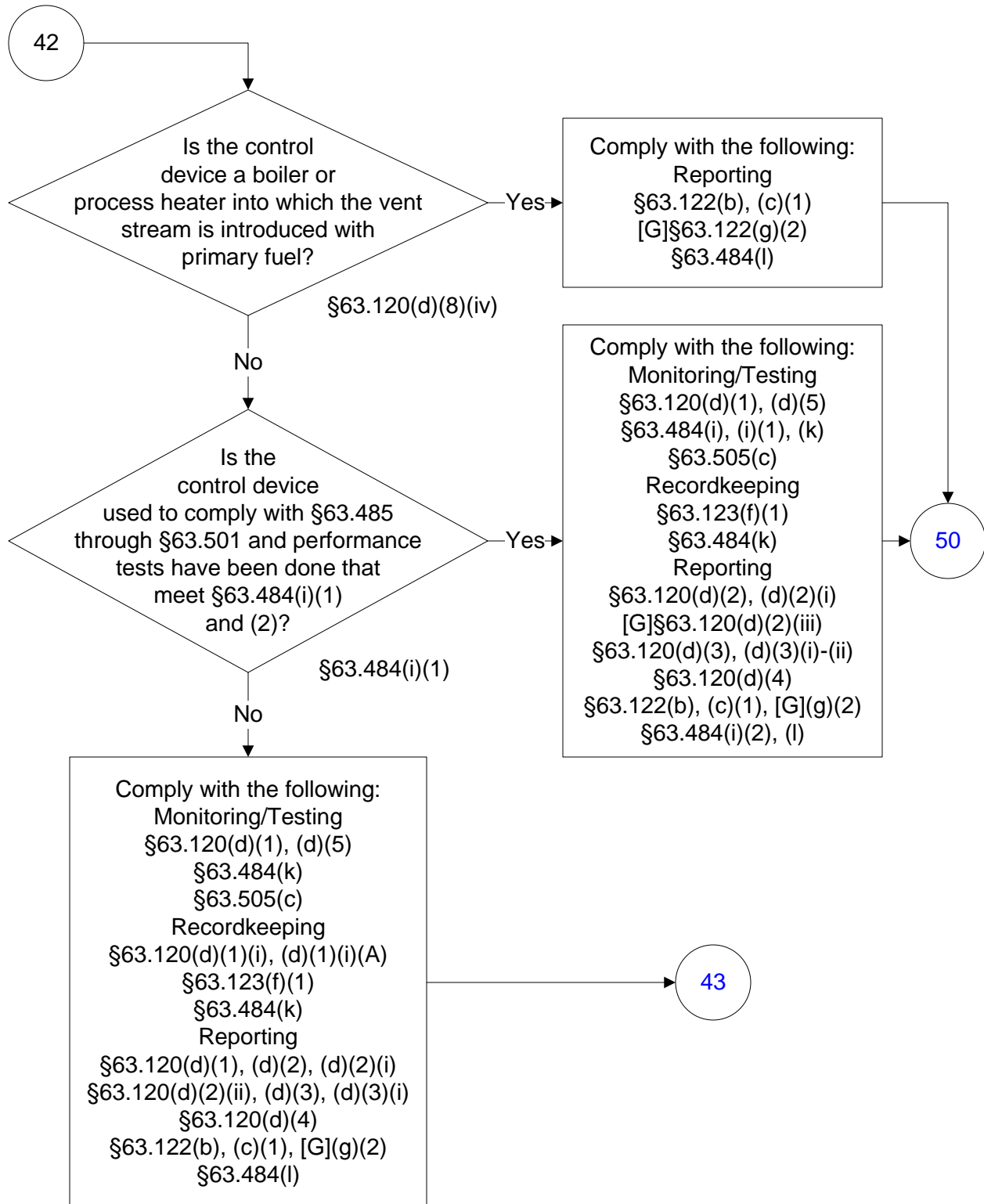

40 CFR Part 63, Subpart U

(19 of 176)

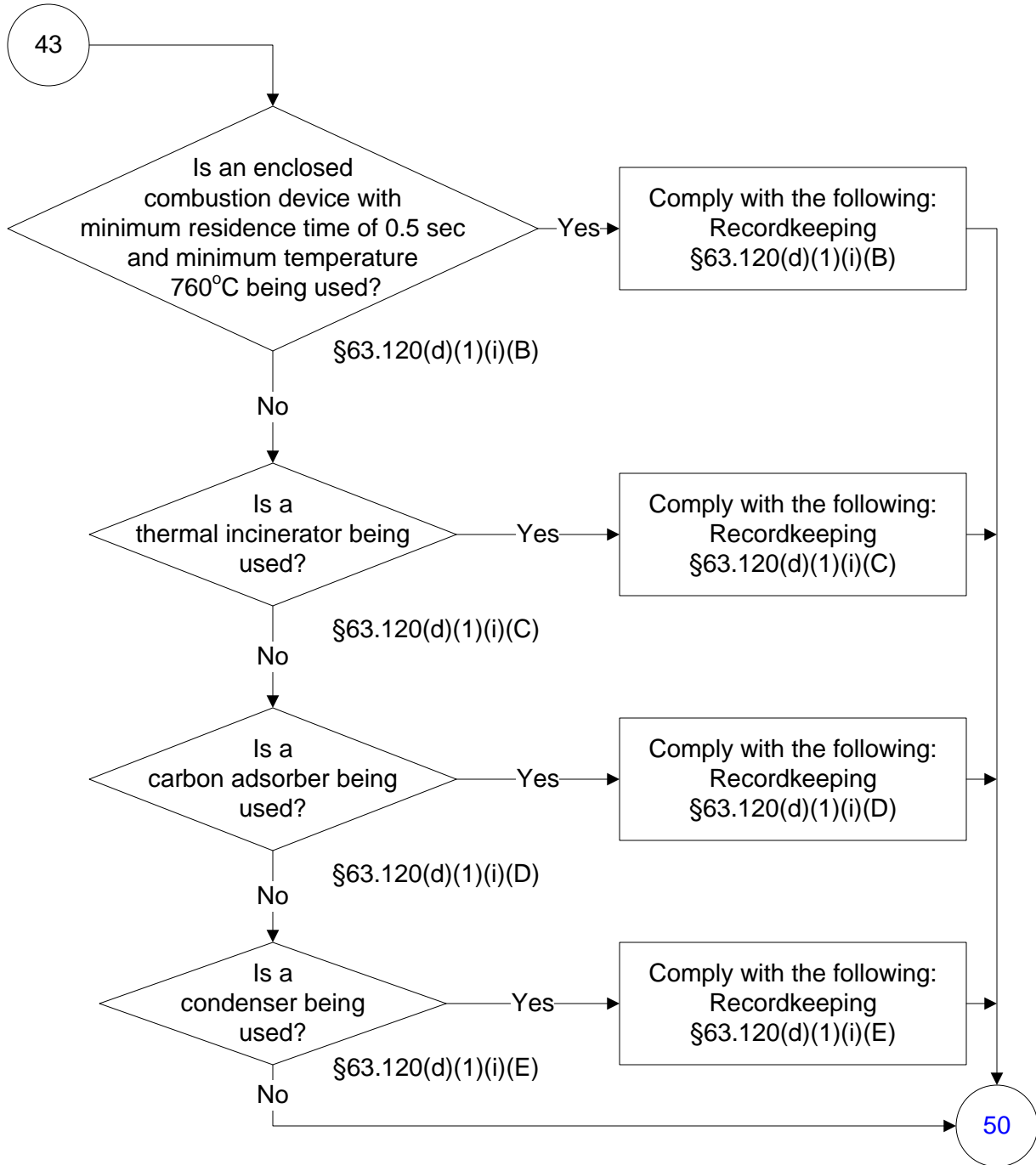

40 CFR Part 63, Subpart U

(20 of 176)

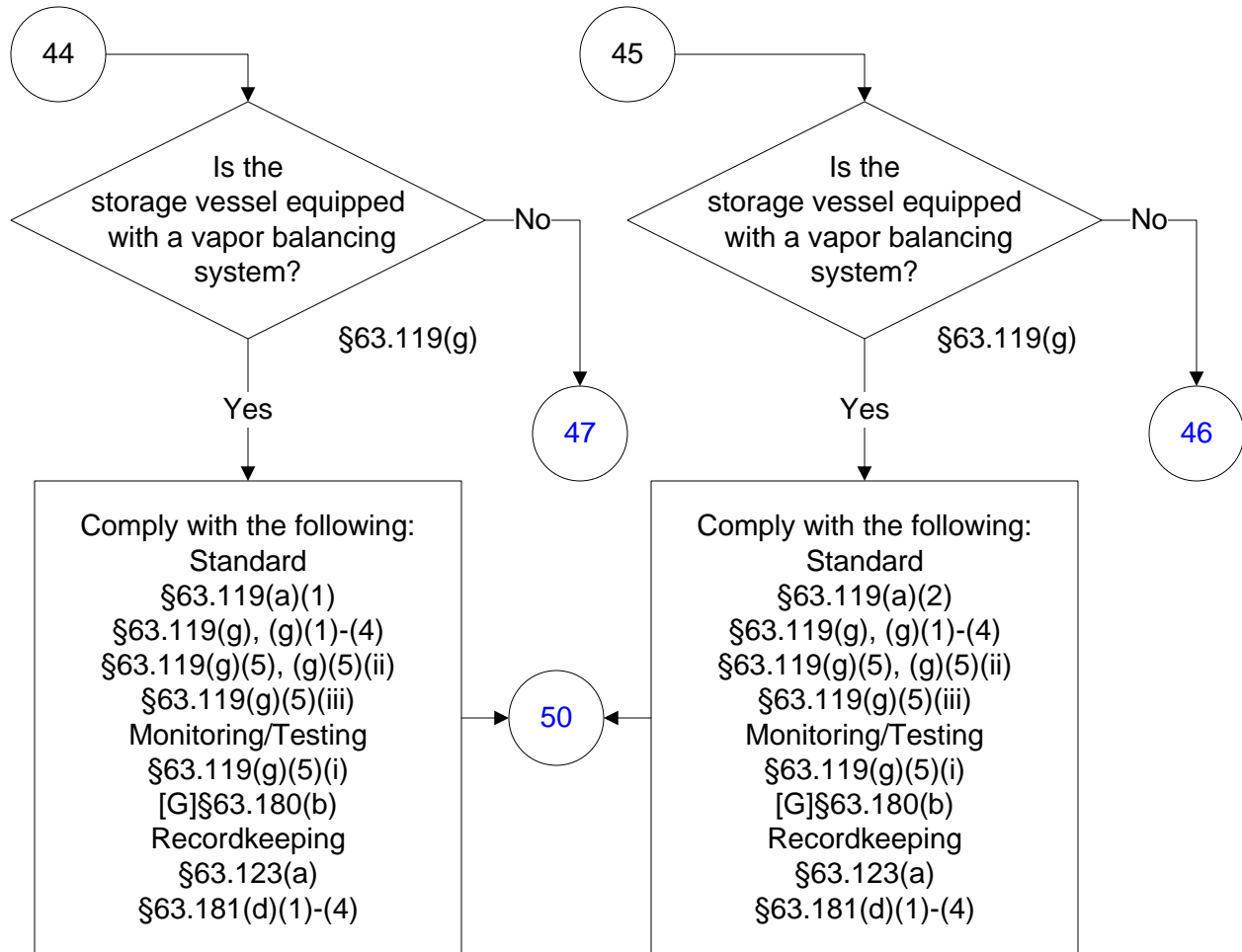

40 CFR Part 63, Subpart U

(21 of 176)

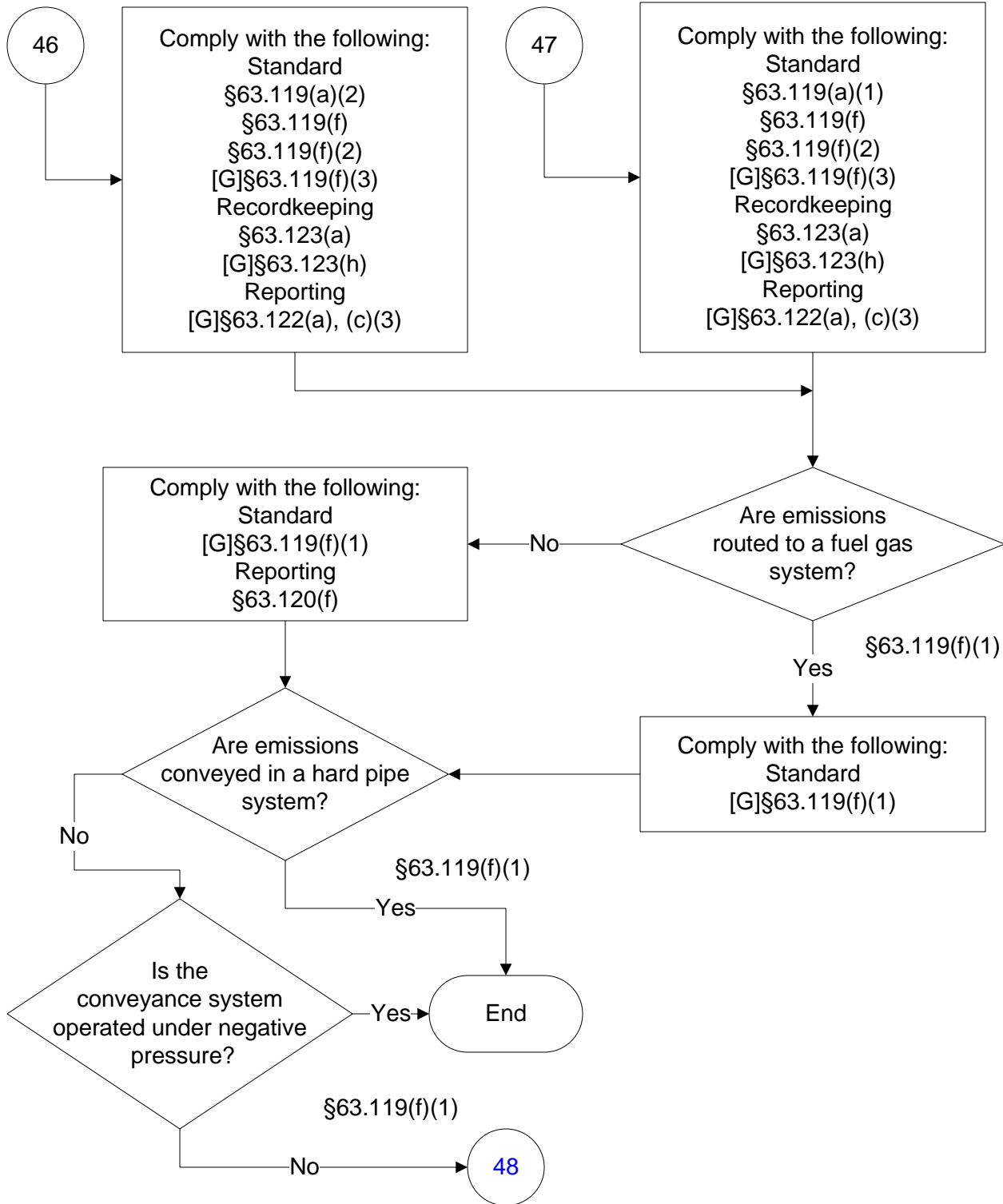

40 CFR Part 63, Subpart U

(22 of 176)

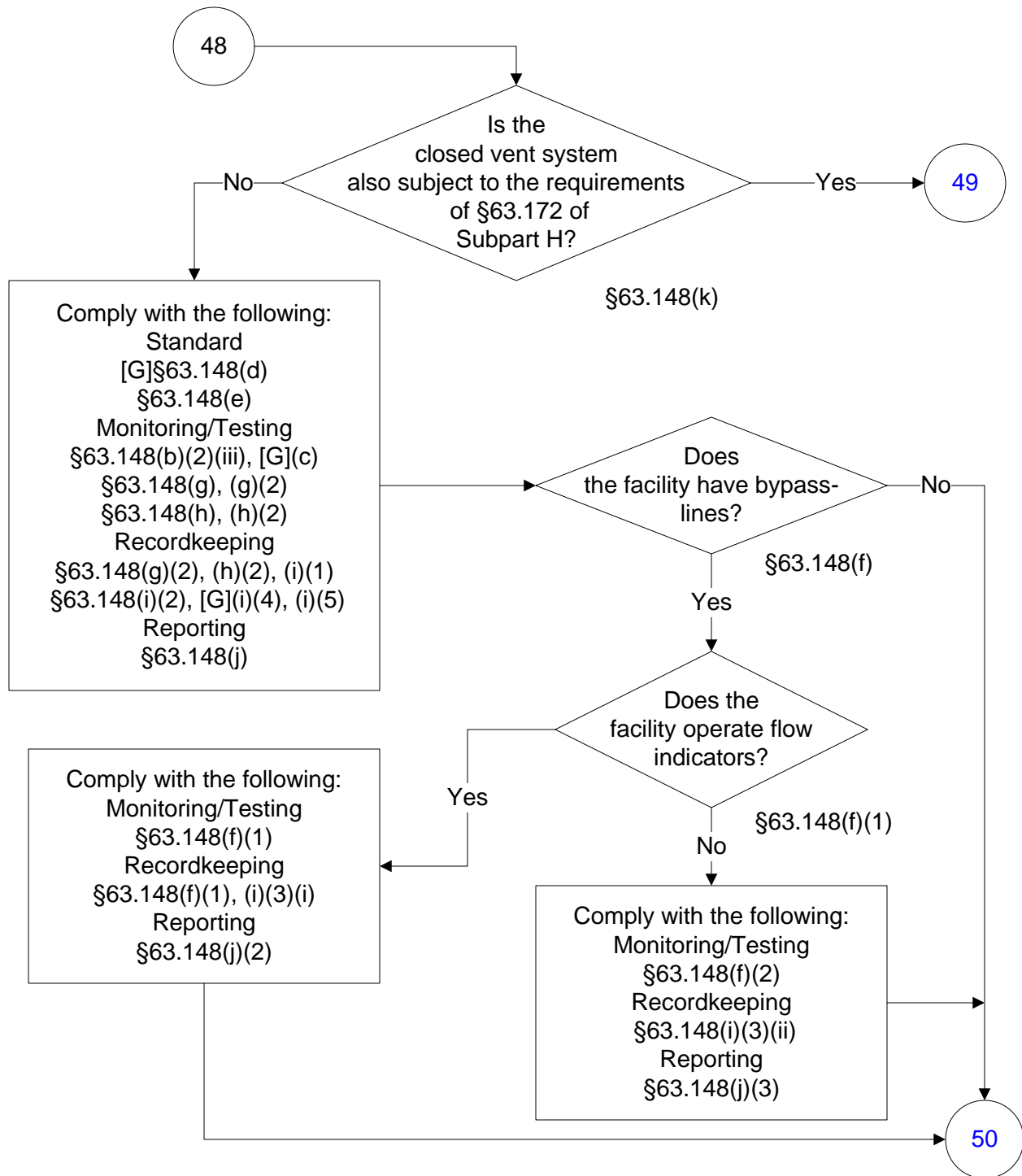

40 CFR Part 63, Subpart U

(23 of 176)

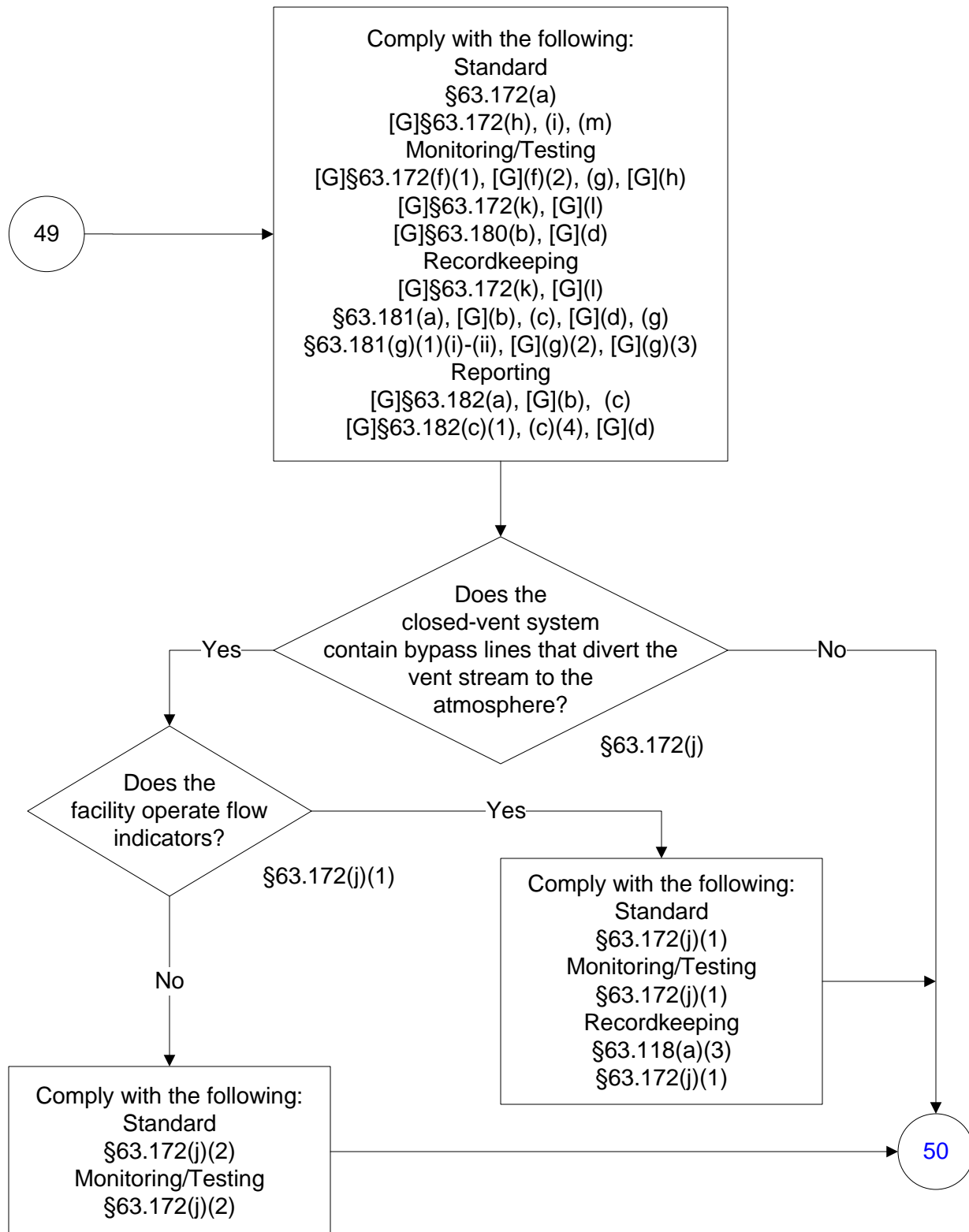

40 CFR Part 63, Subpart U

(24 of 176)

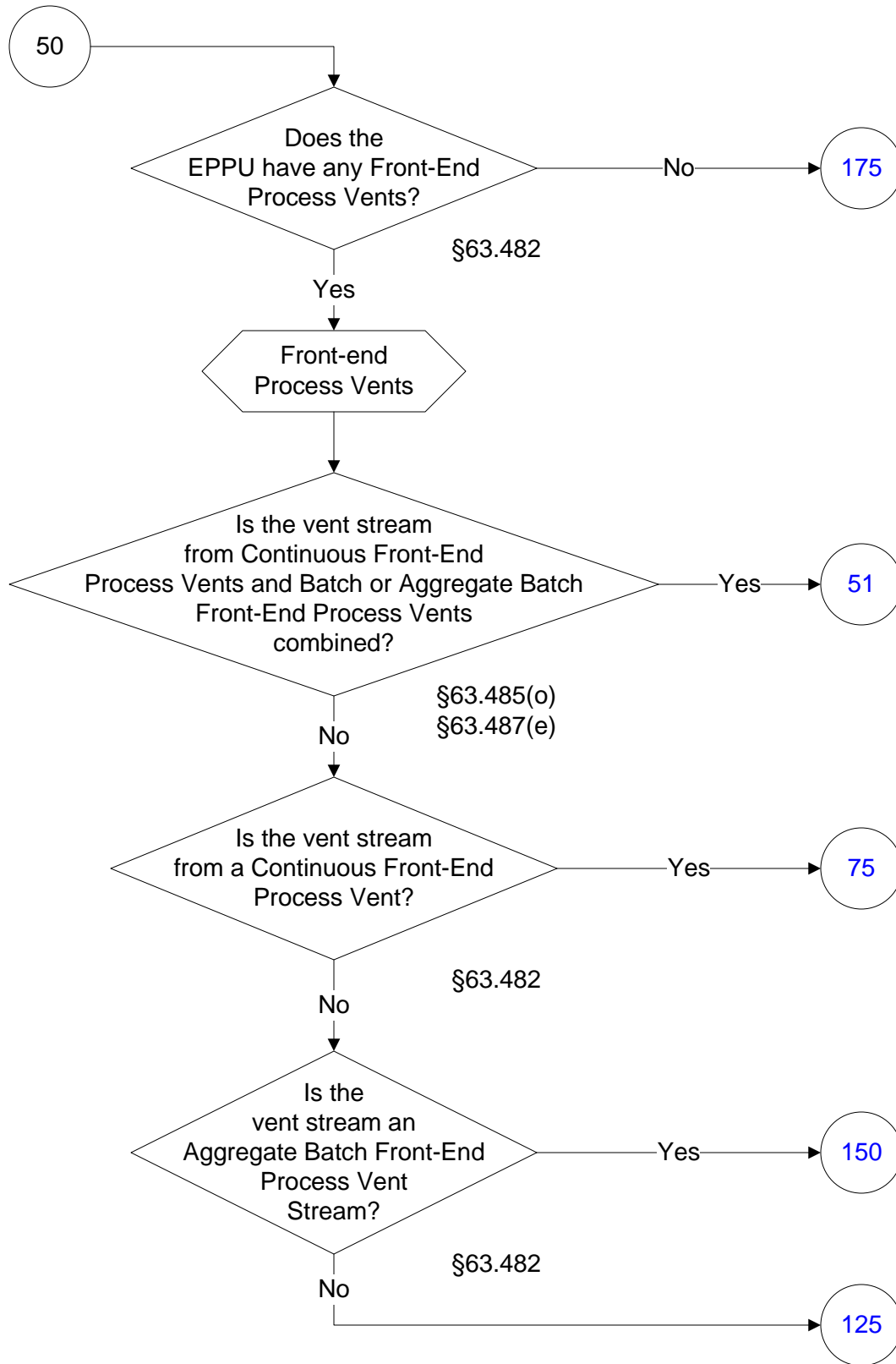

40 CFR Part 63, Subpart U

(25 of 176)

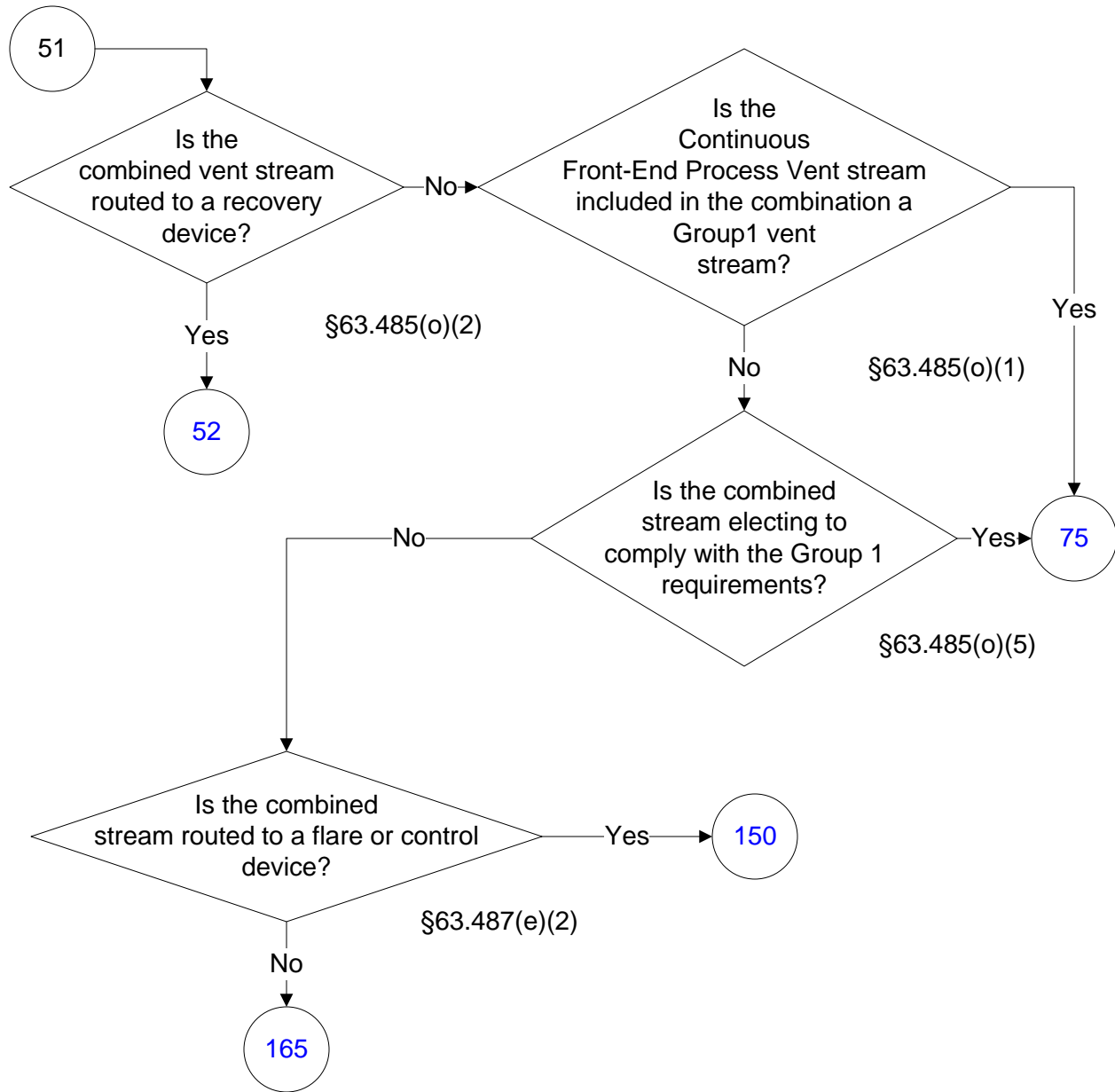

40 CFR Part 63, Subpart U

(26 of 176)

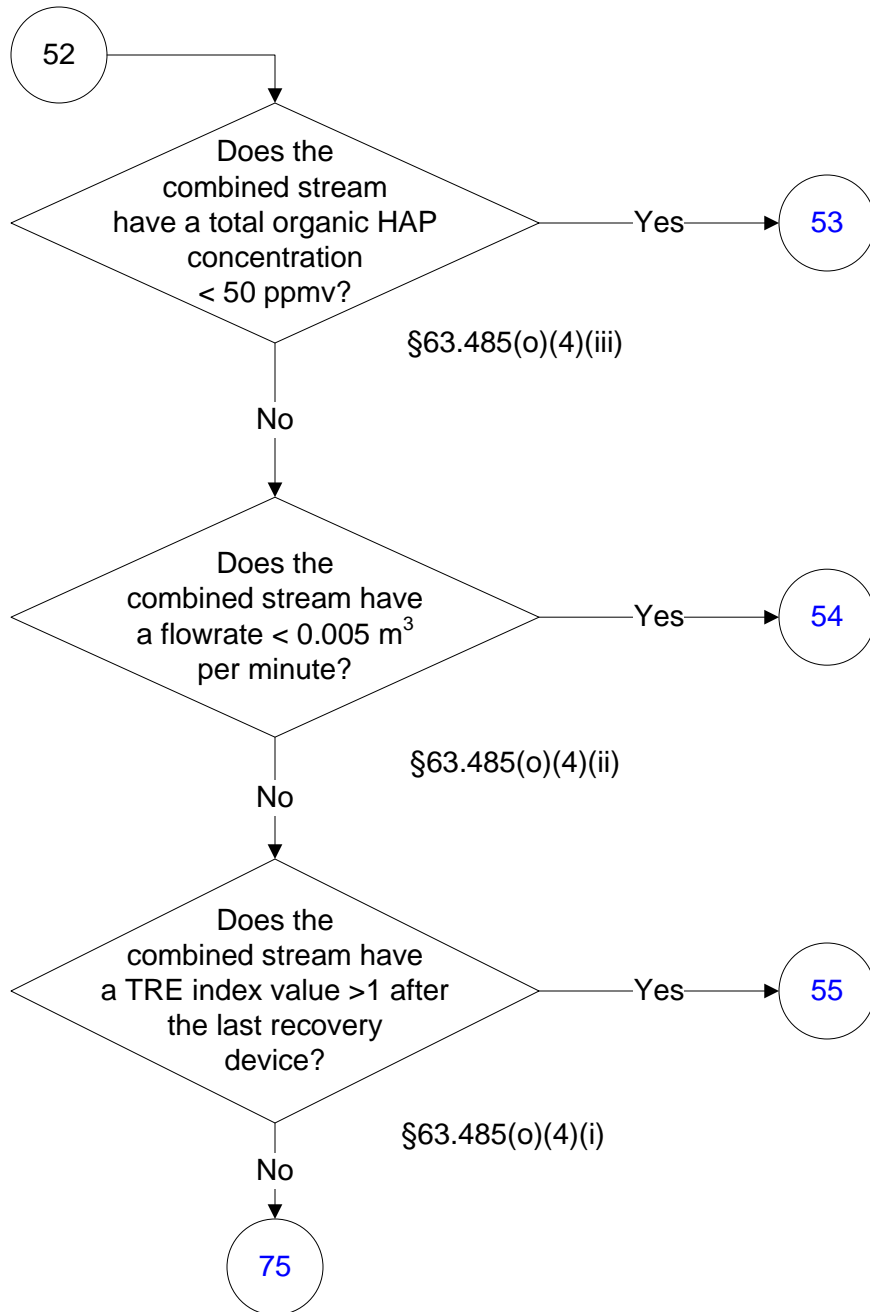

40 CFR Part 63, Subpart U

(27 of 176)

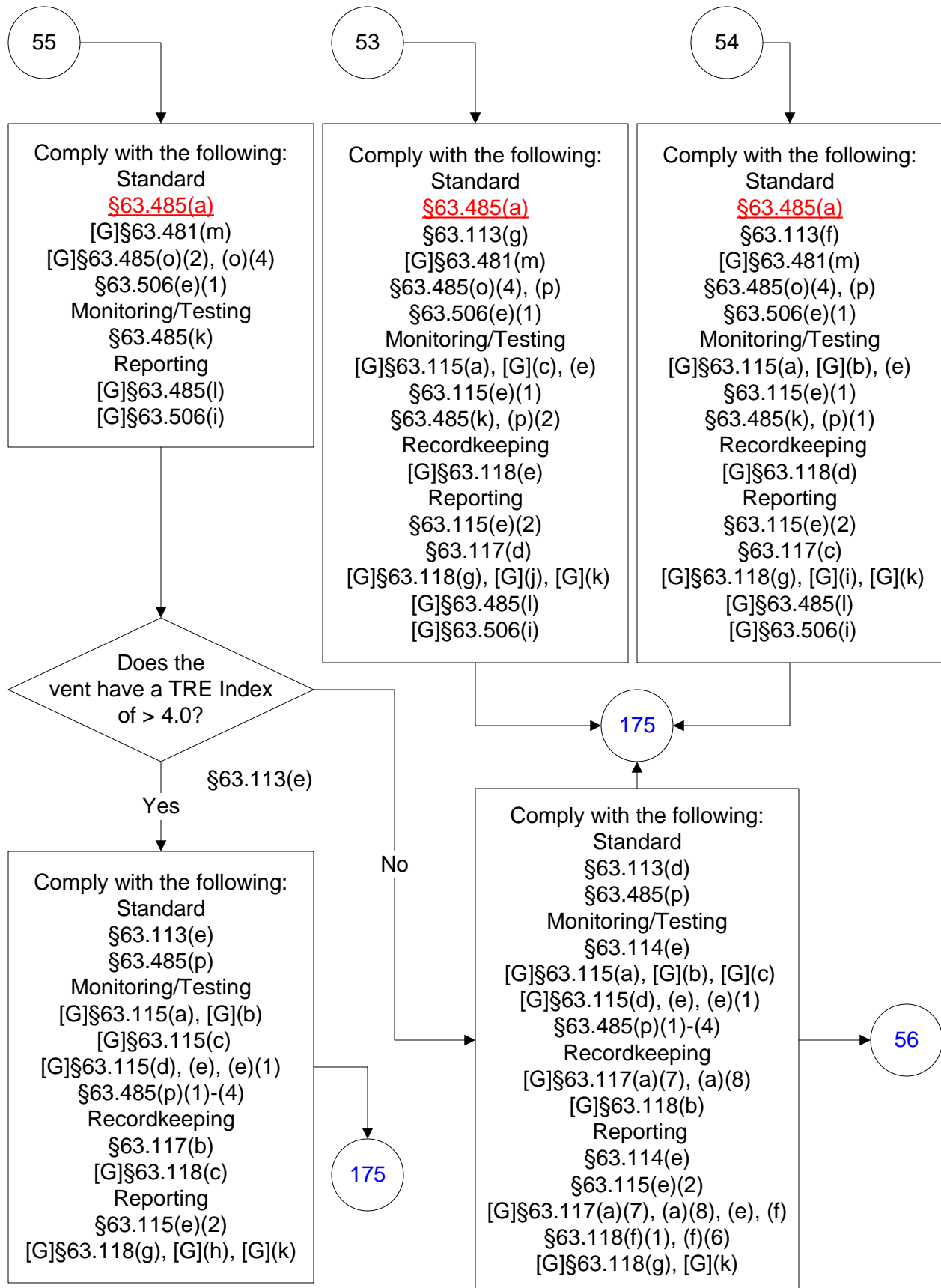

40 CFR Part 63, Subpart U

(28 of 176)

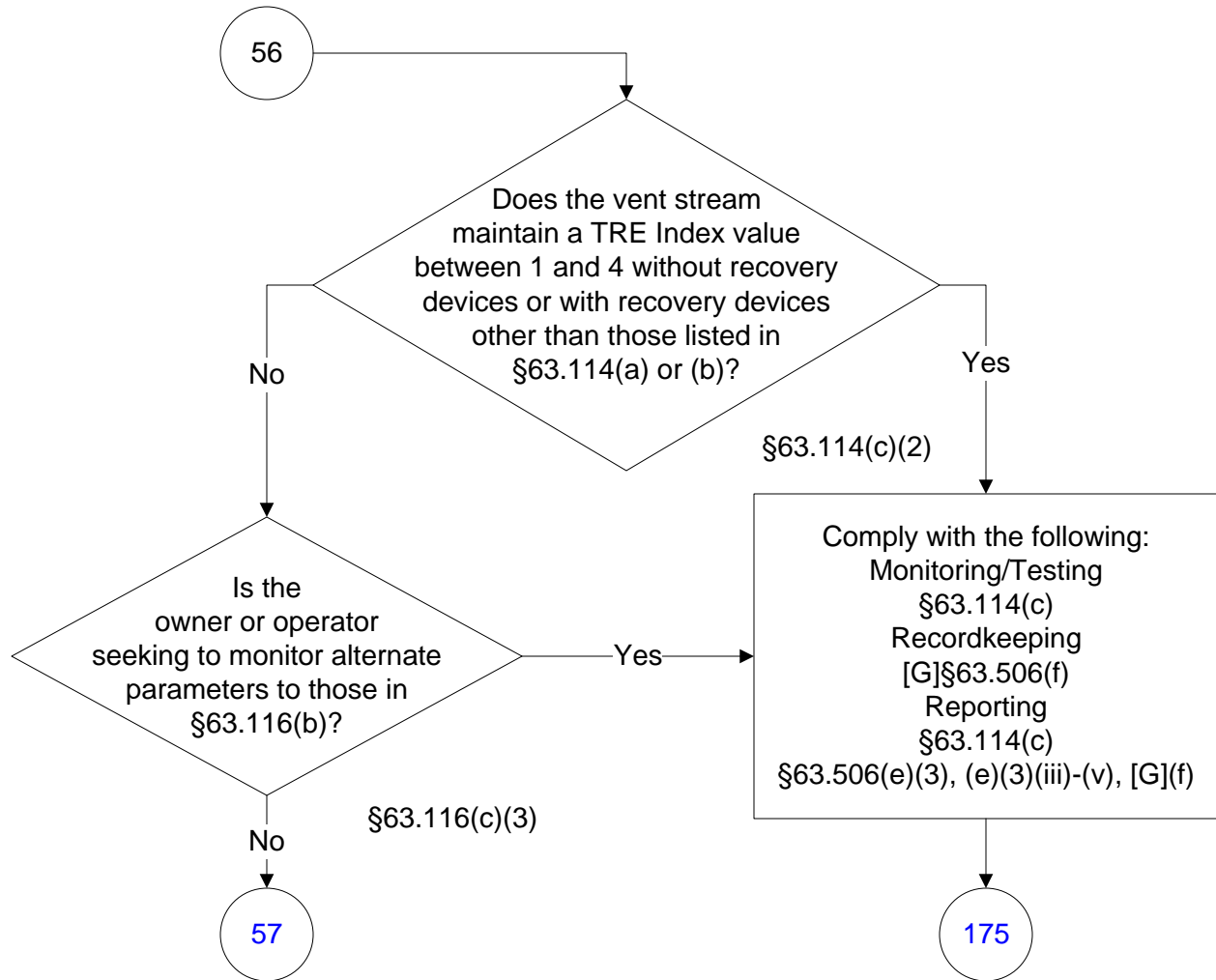

40 CFR Part 63, Subpart U

(29 of 176)

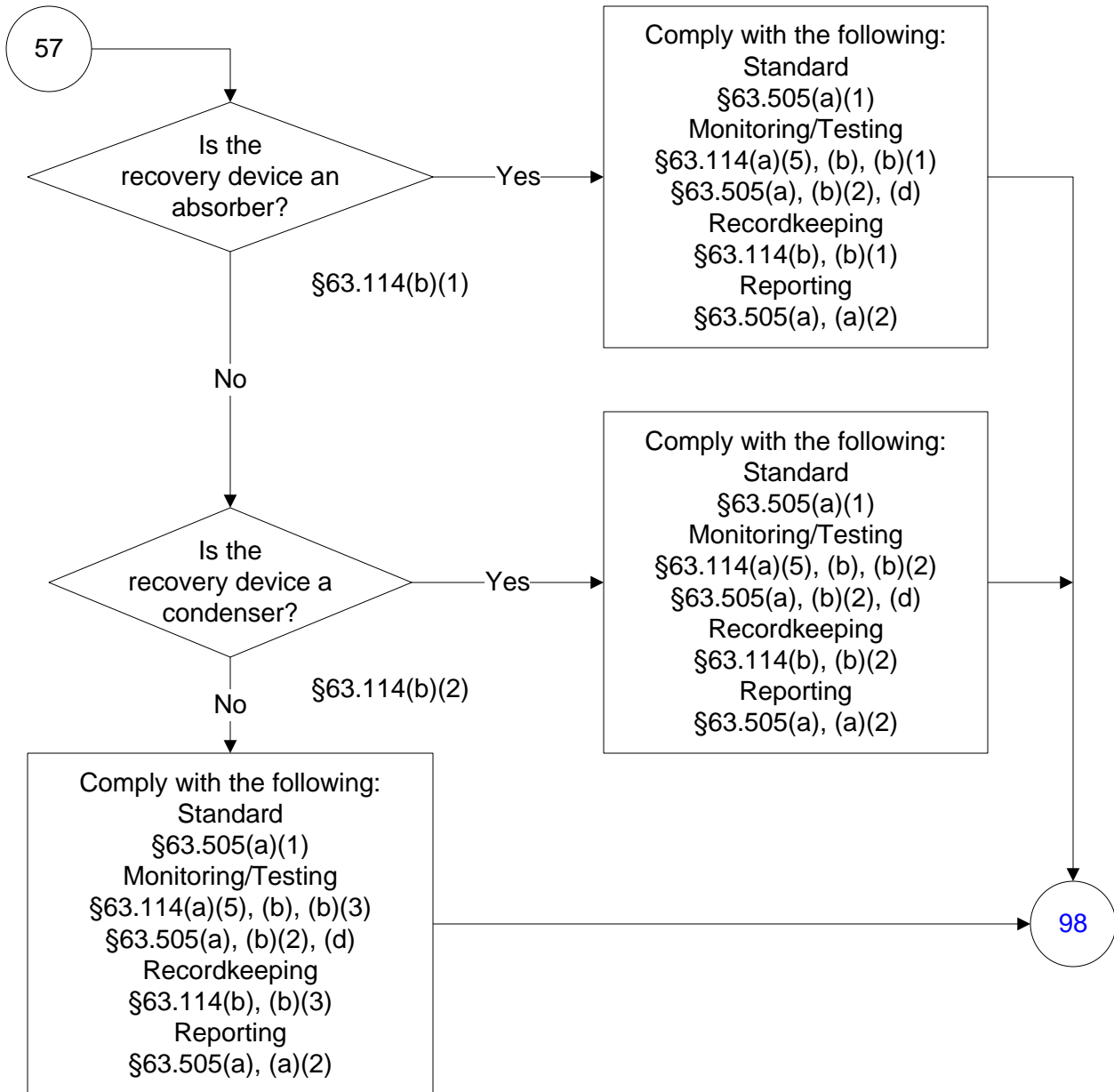

40 CFR Part 63, Subpart U

(30 of 176)

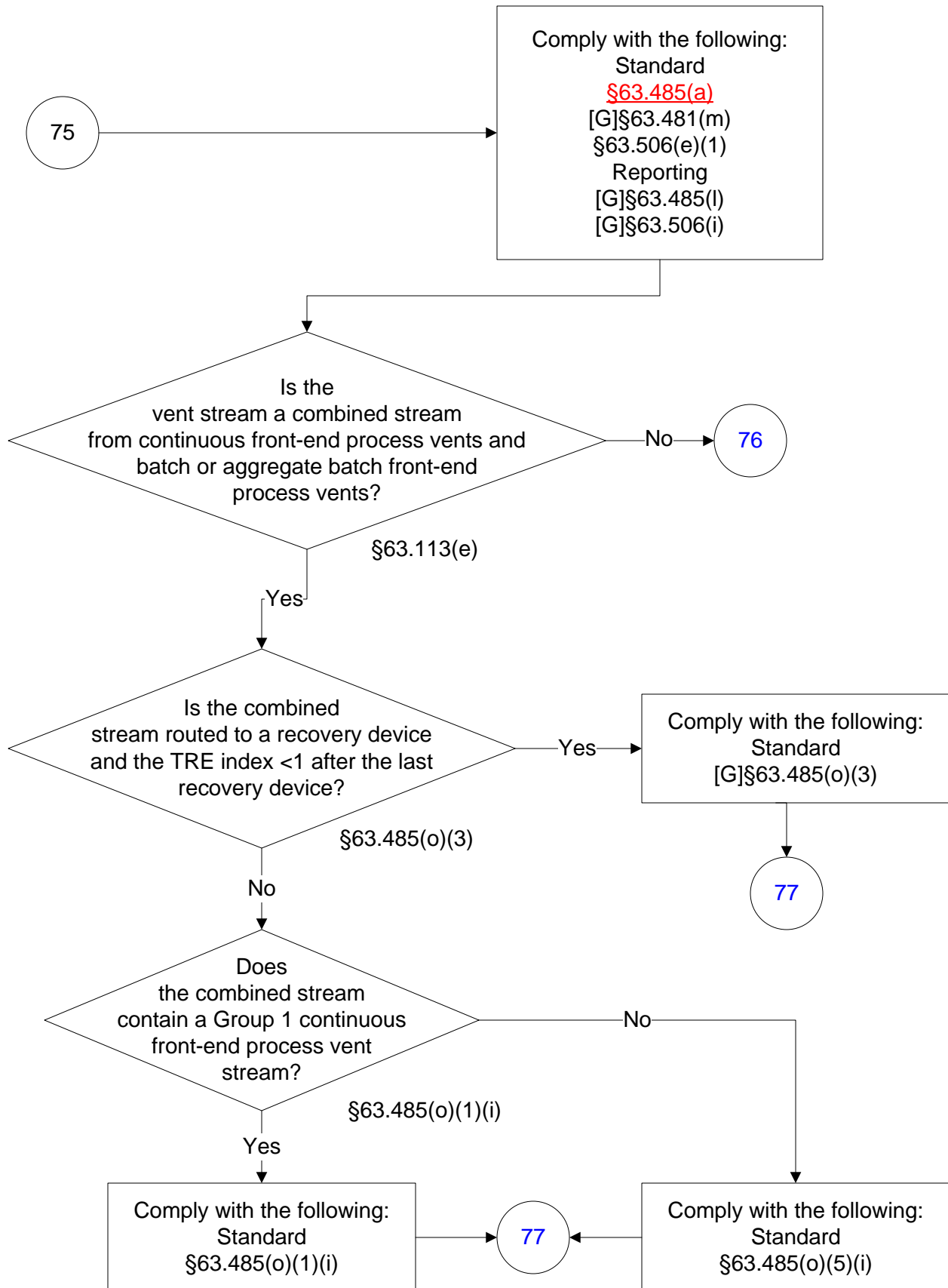

40 CFR Part 63, Subpart U

(31 of 176)

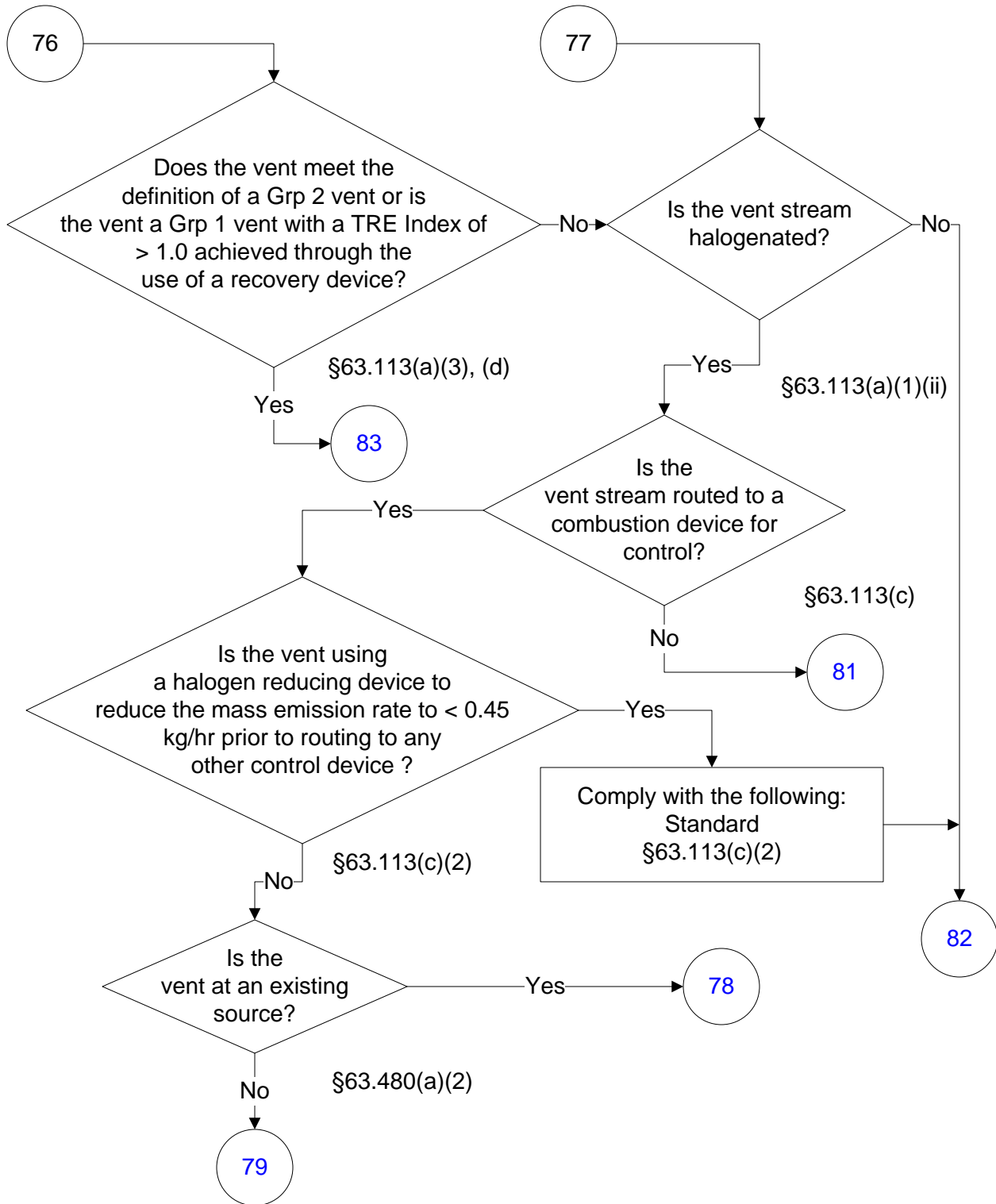

40 CFR Part 63, Subpart U

(32 of 176)

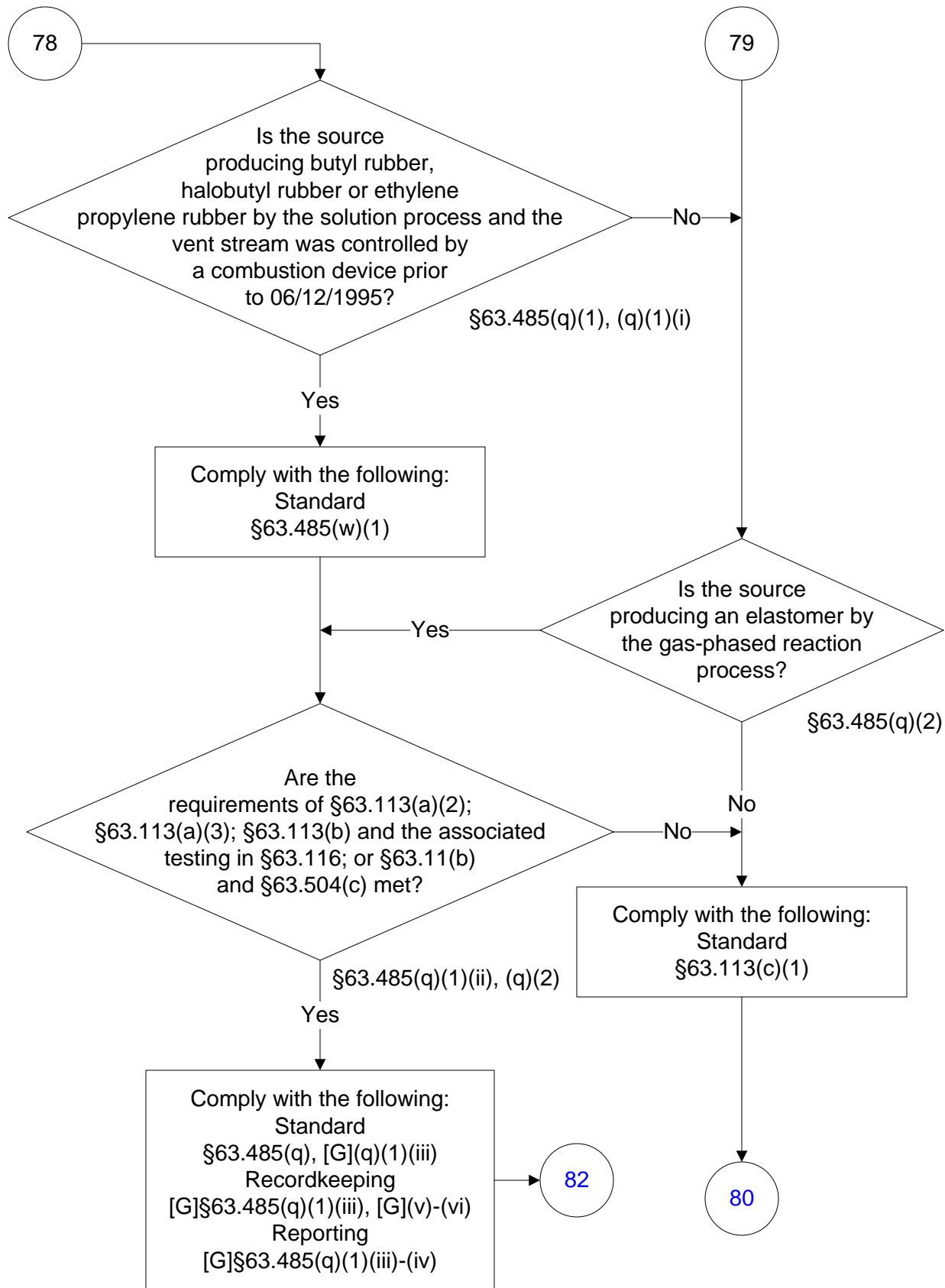

40 CFR Part 63, Subpart U

(33 of 176)

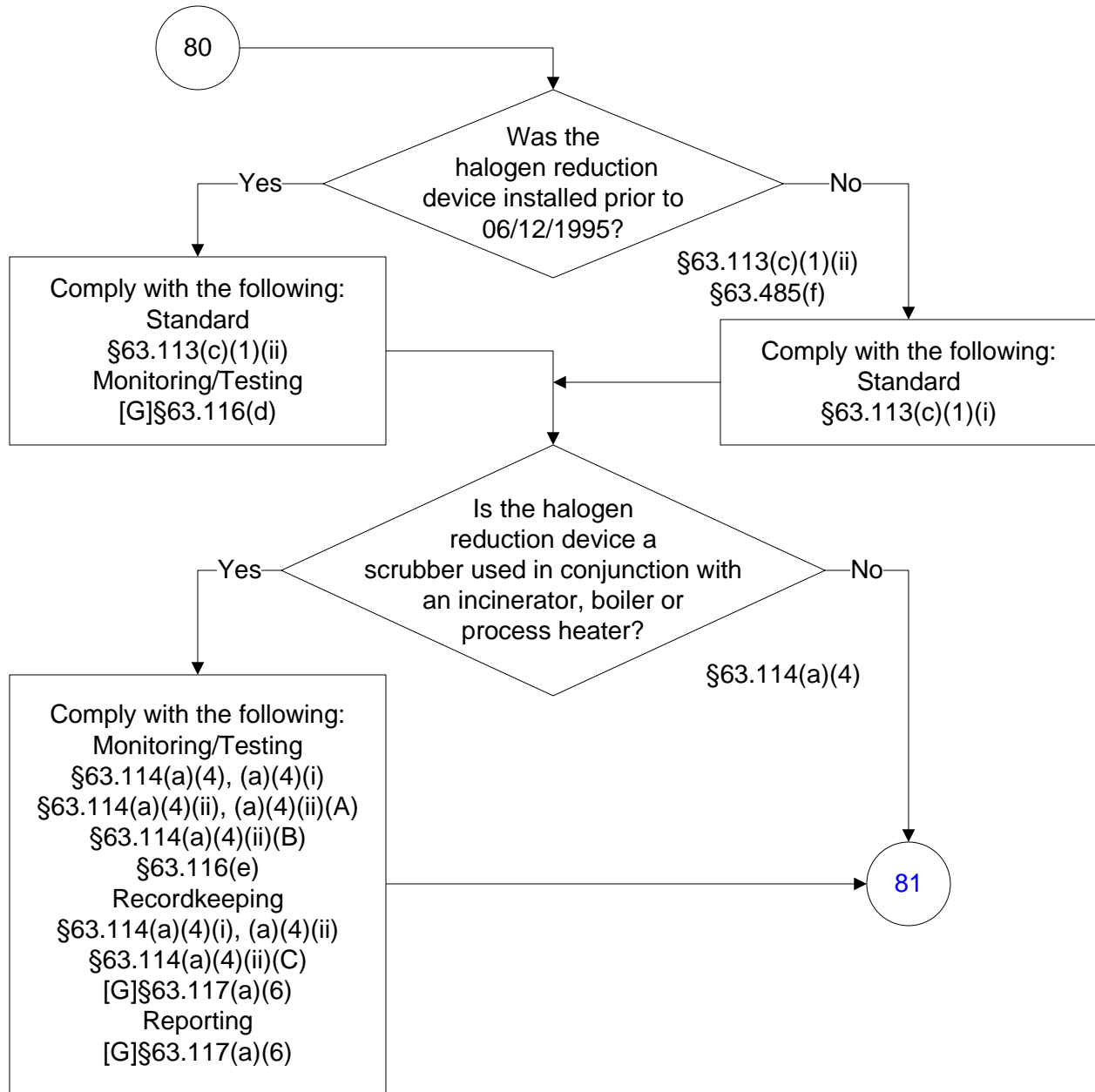

40 CFR Part 63, Subpart U

(34 of 176)

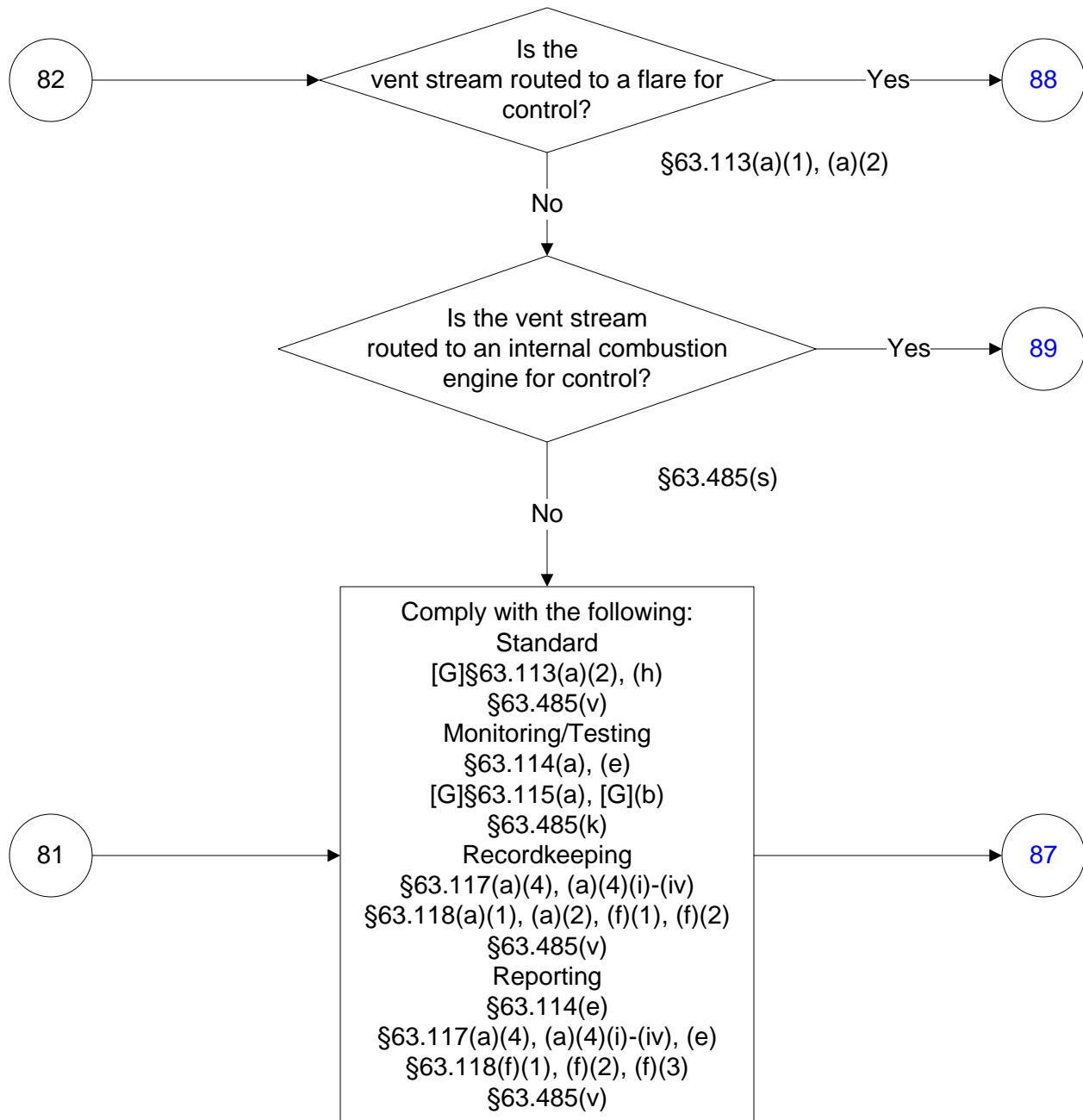

40 CFR Part 63, Subpart U

(35 of 176)

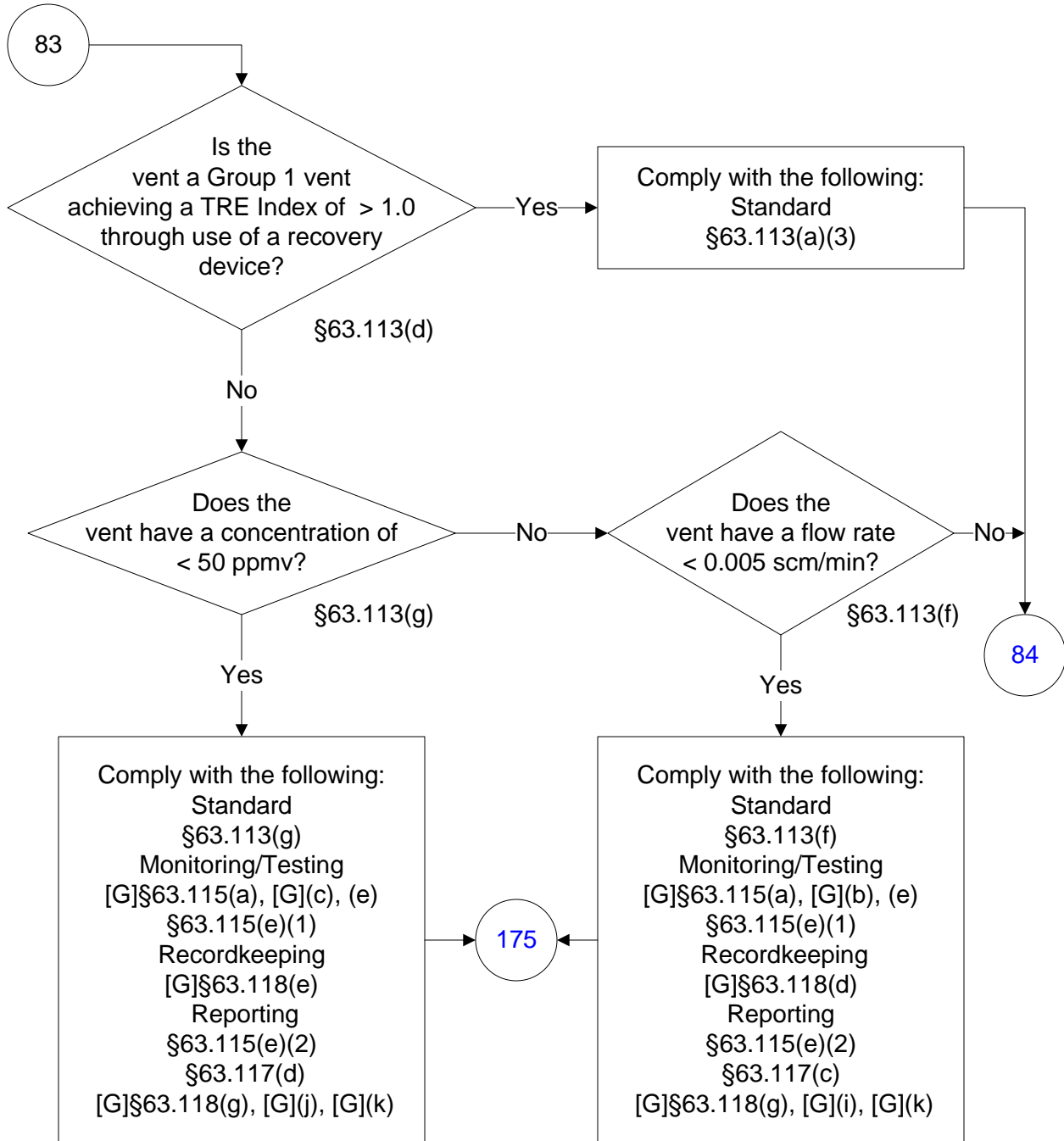

40 CFR Part 63, Subpart U

(36 of 176)

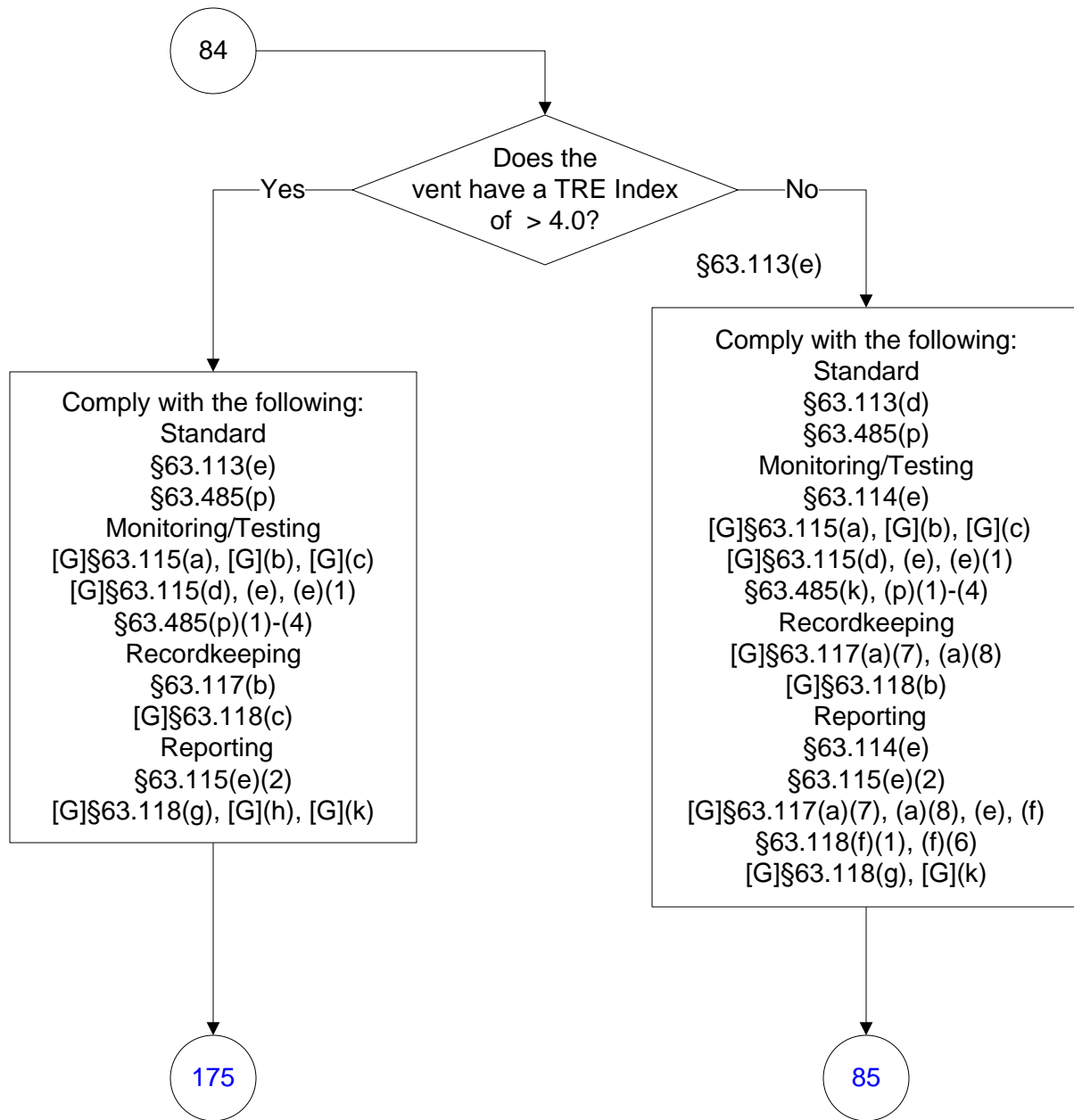

40 CFR Part 63, Subpart U

(37 of 176)

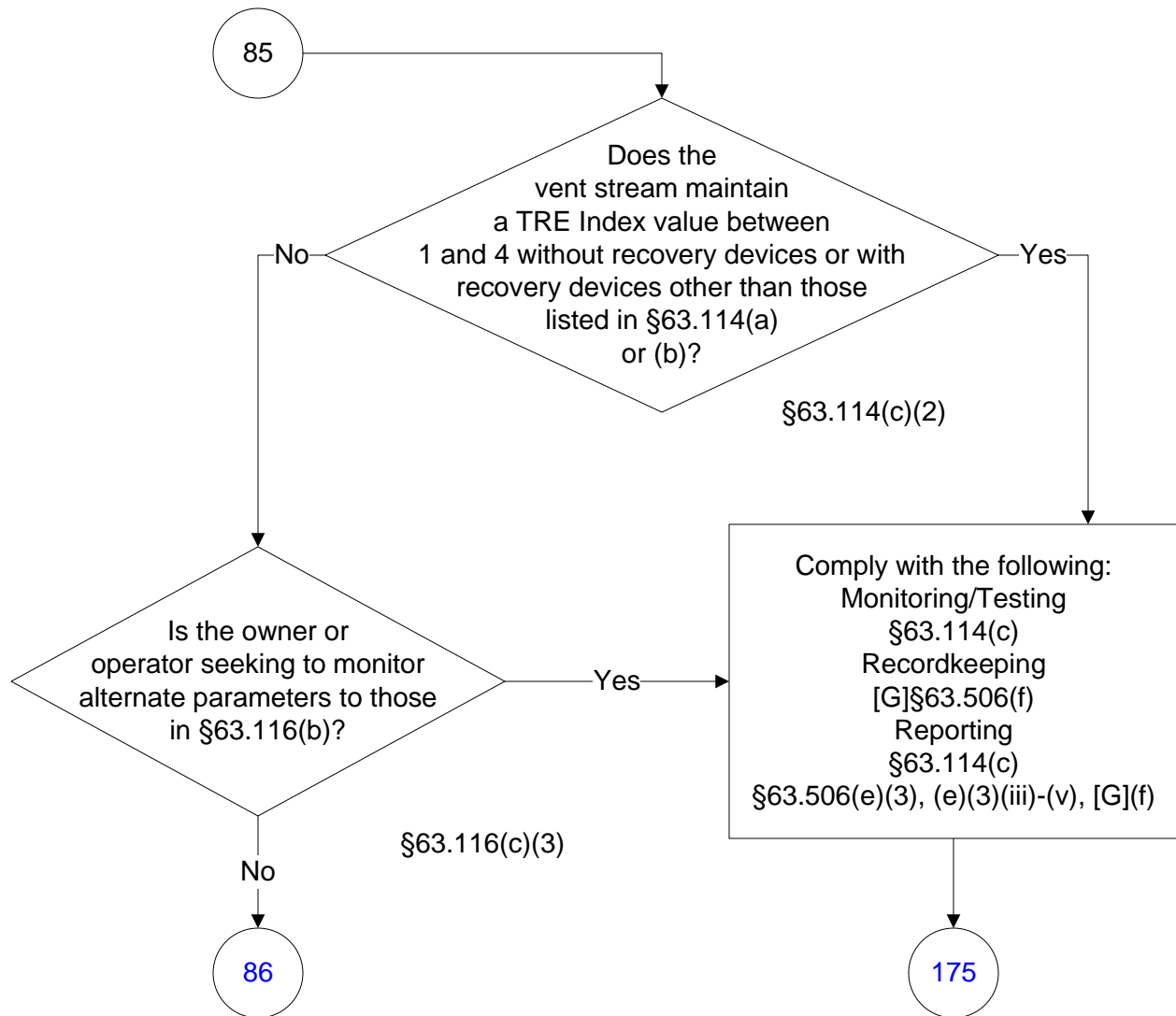

40 CFR Part 63, Subpart U

(38 of 176)

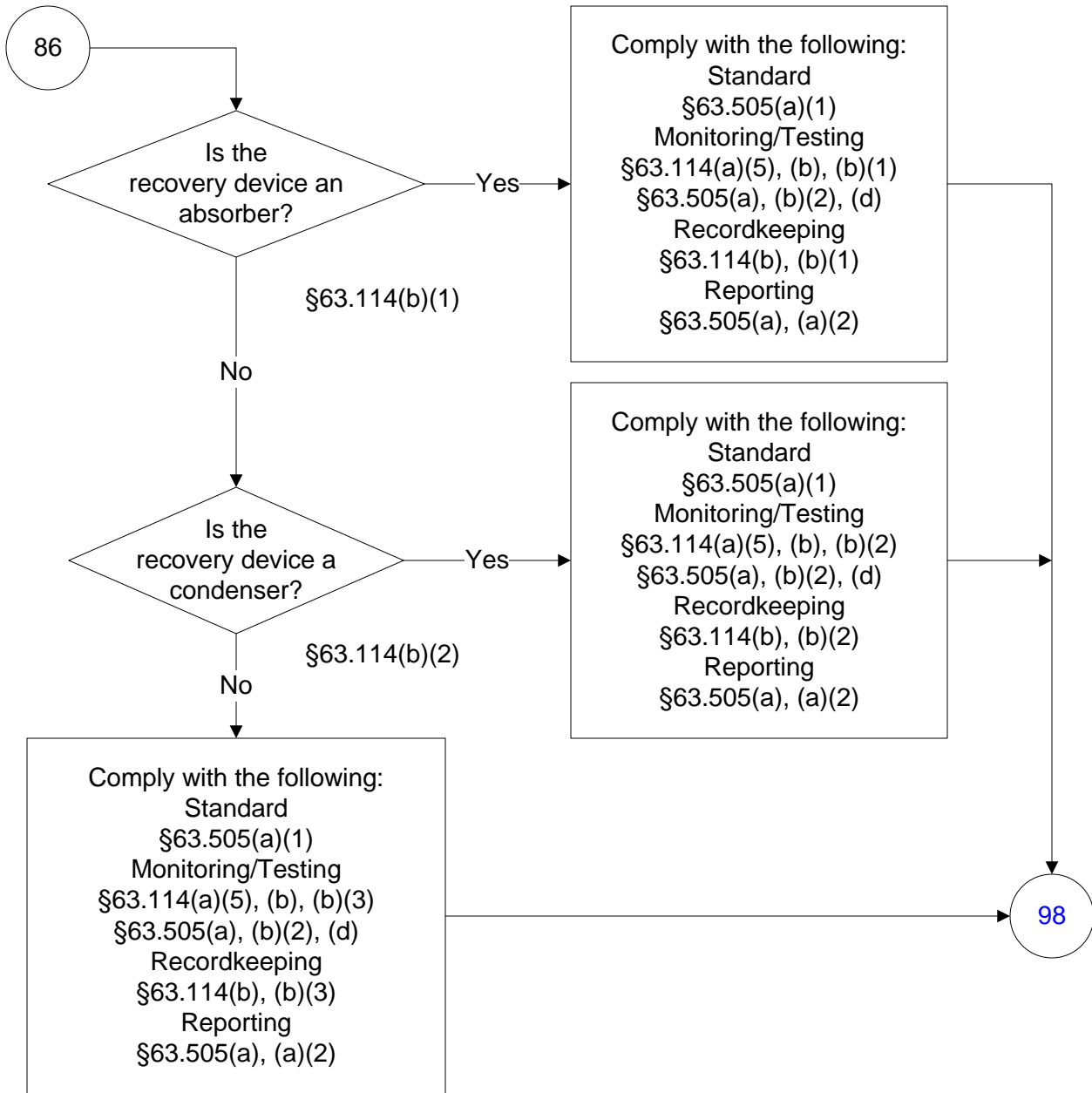

40 CFR Part 63, Subpart U

(39 of 176)

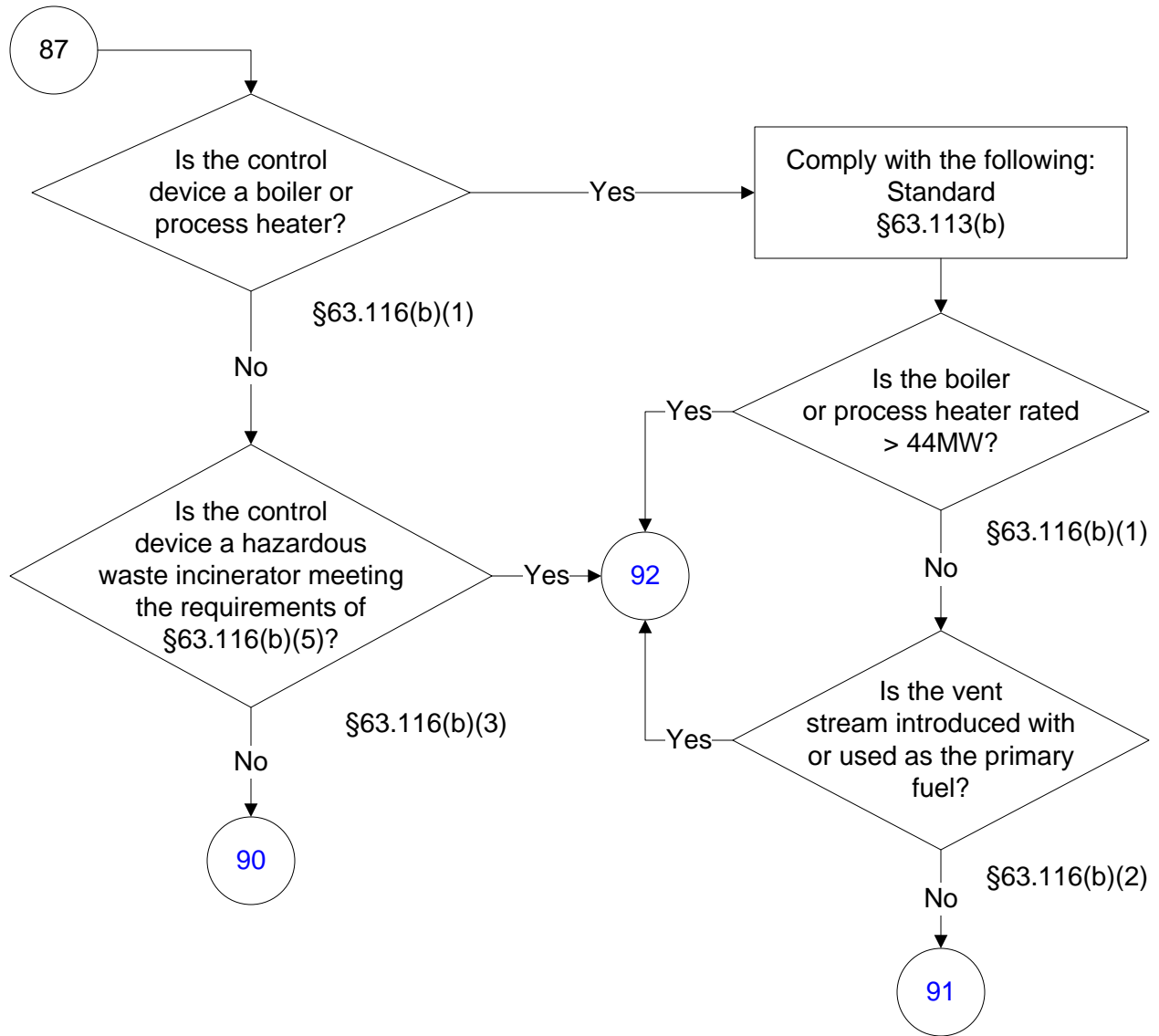

40 CFR Part 63, Subpart U

(40 of 176)

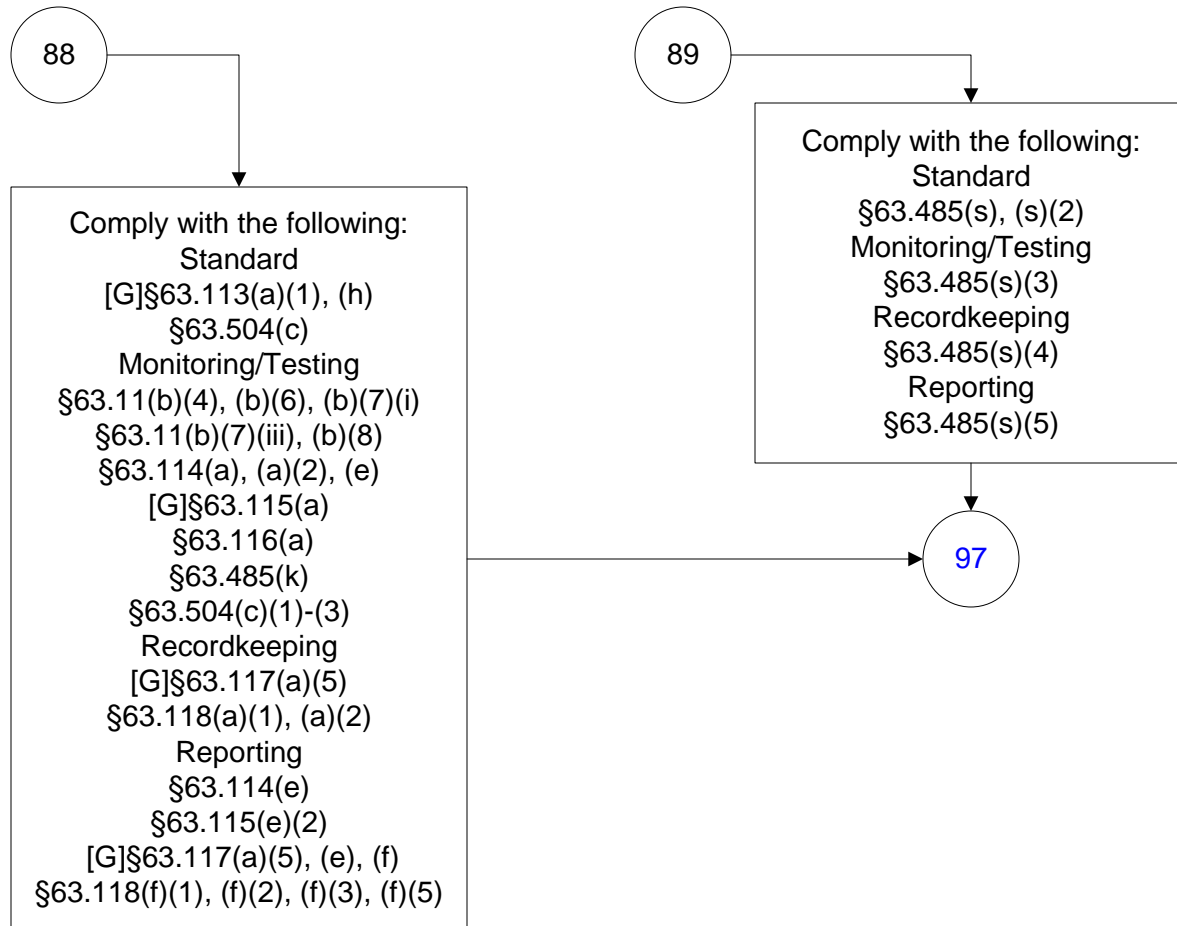

40 CFR Part 63, Subpart U

(41 of 176)

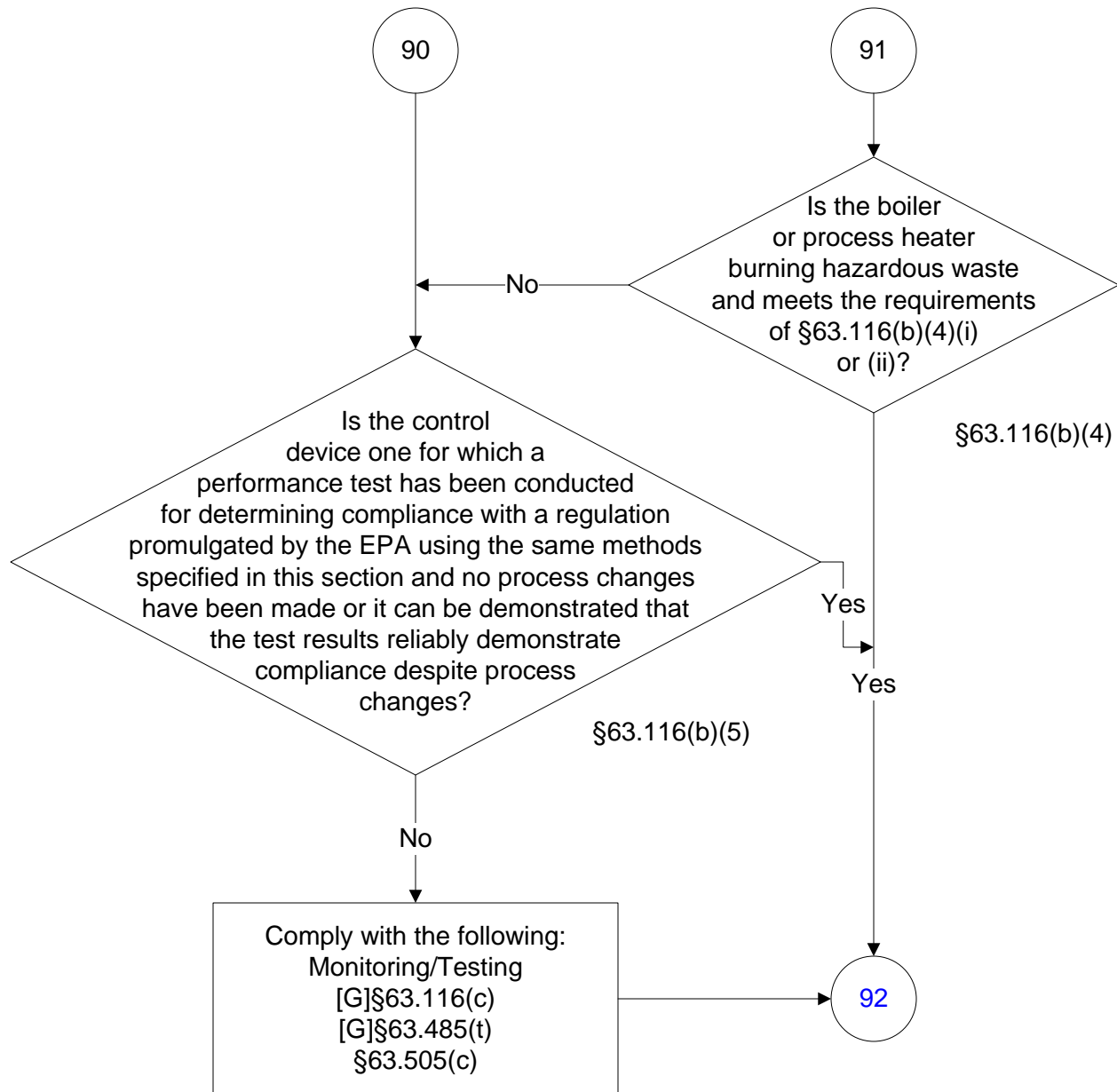

40 CFR Part 63, Subpart U

(42 of 176)

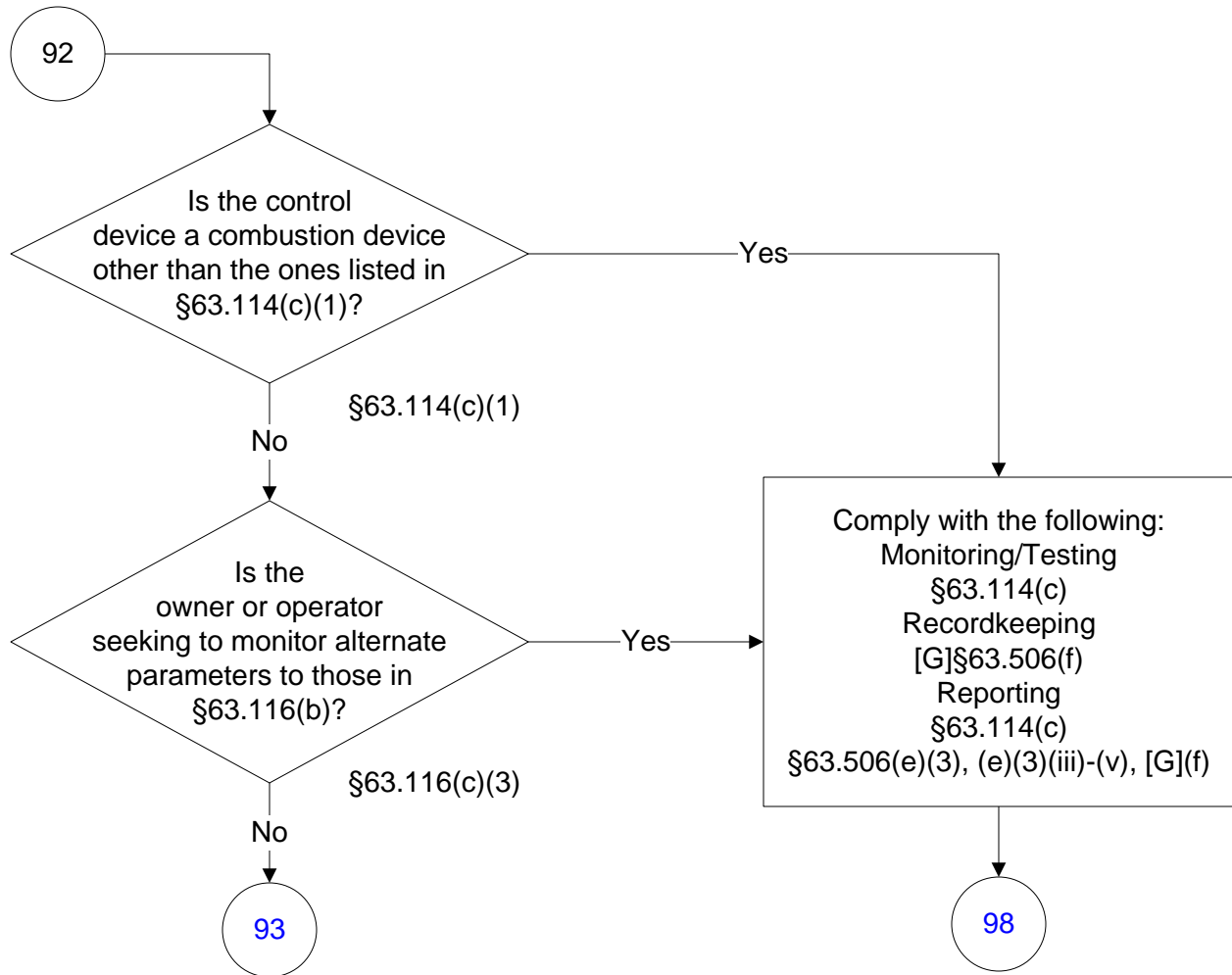

40 CFR Part 63, Subpart U

(43 of 176)

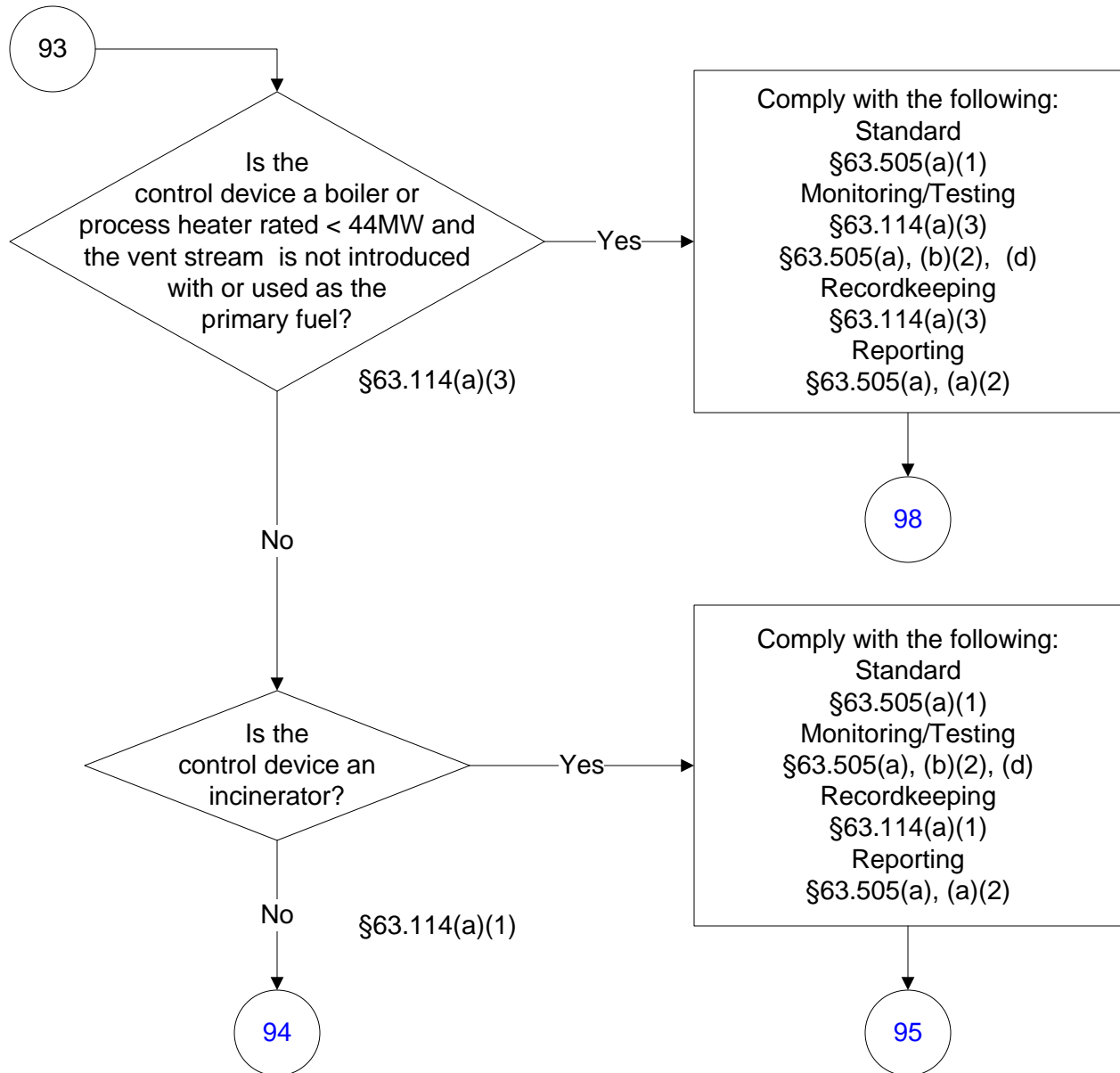

40 CFR Part 63, Subpart U

(44 of 176)

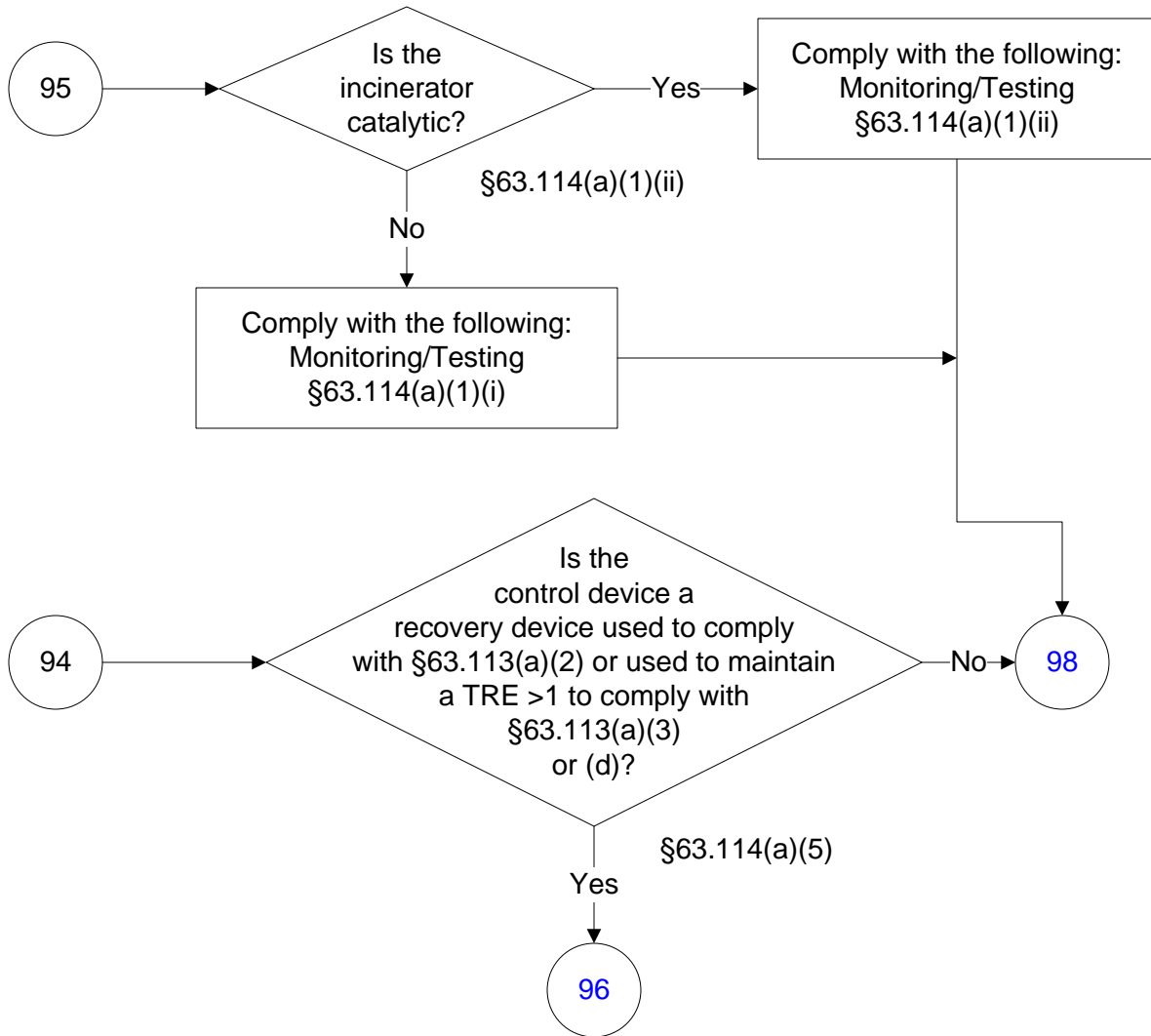

40 CFR Part 63, Subpart U

(45 of 176)

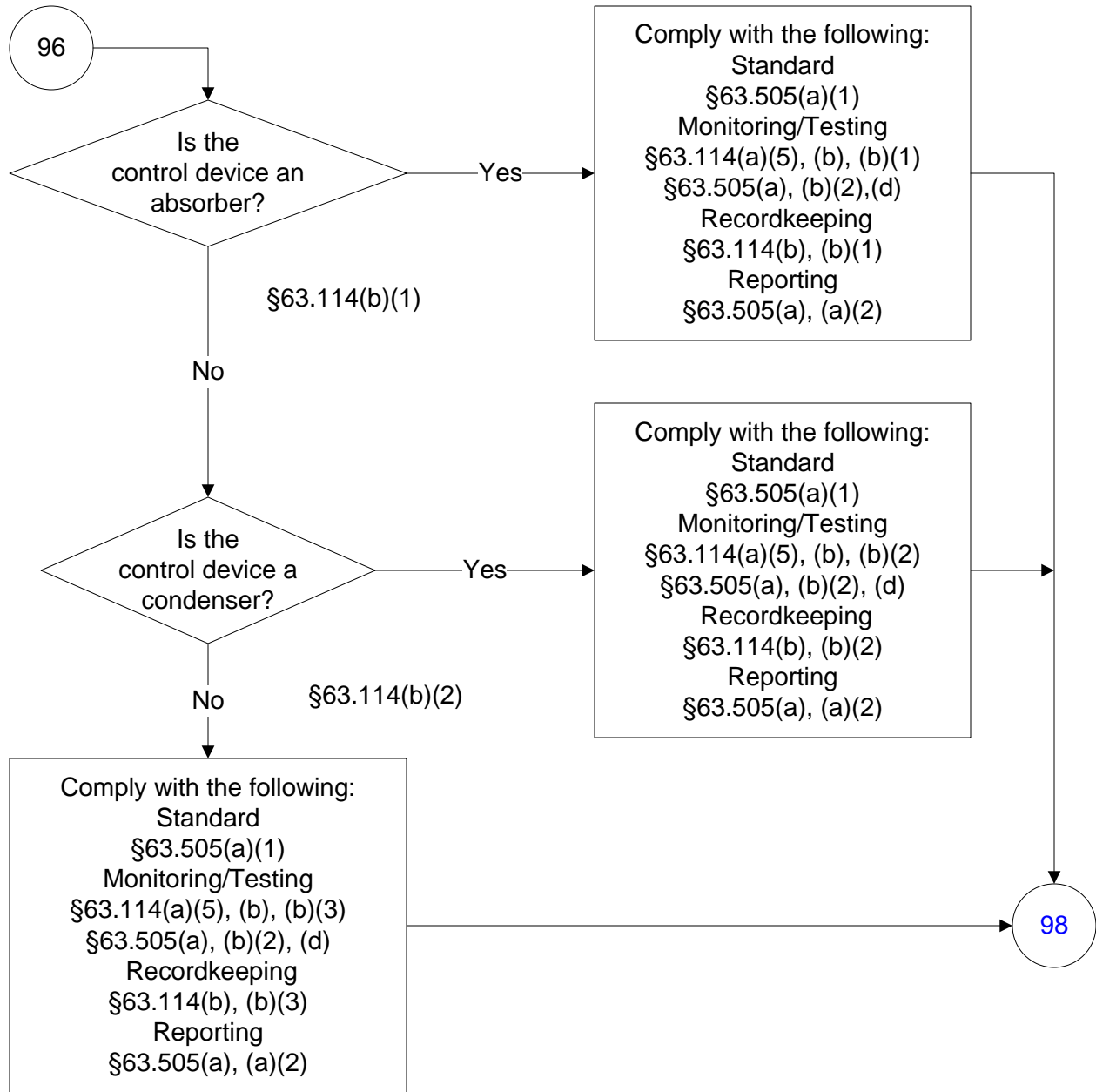

40 CFR Part 63, Subpart U

(46 of 176)

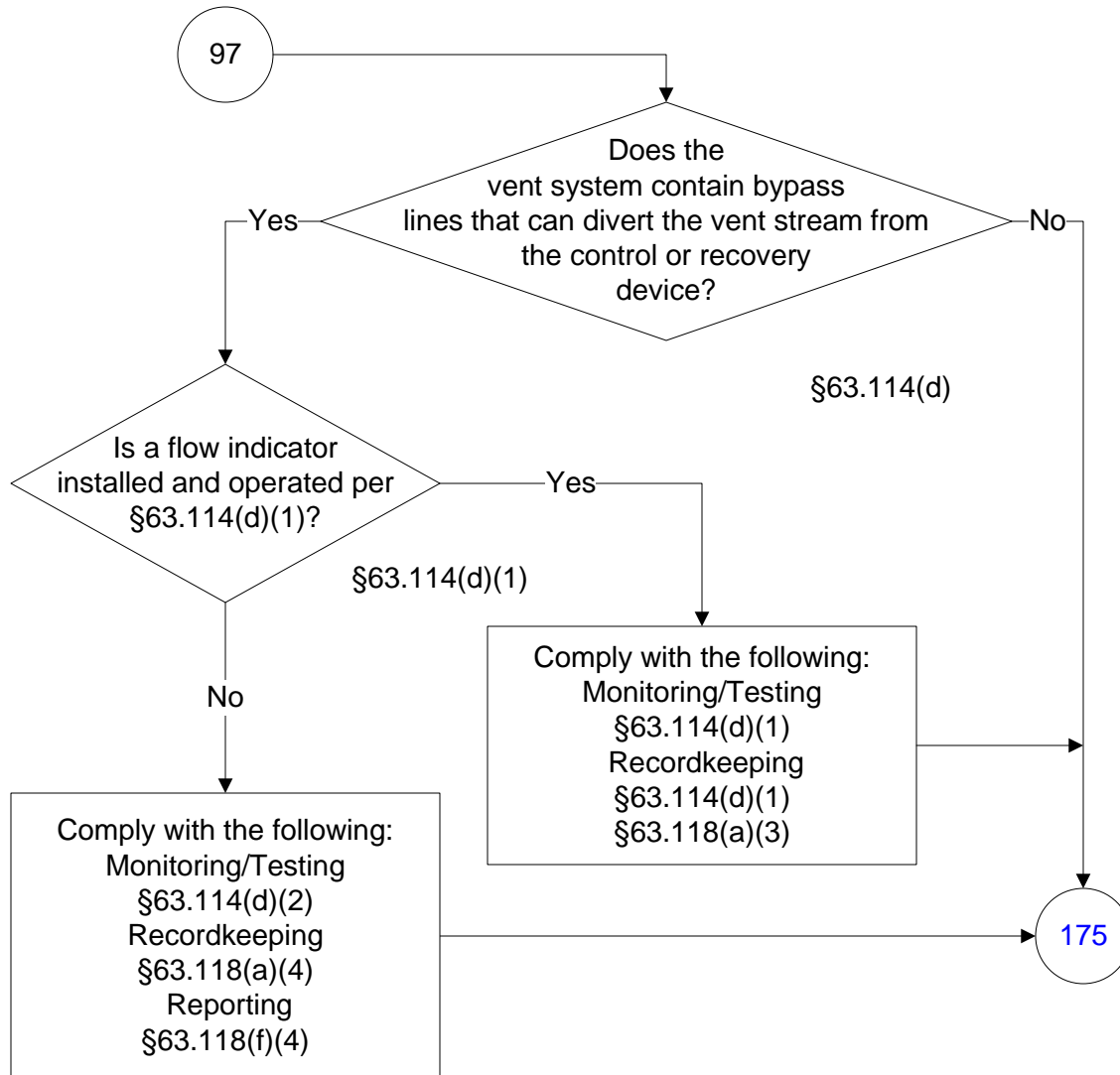

40 CFR Part 63, Subpart U

(47 of 176)

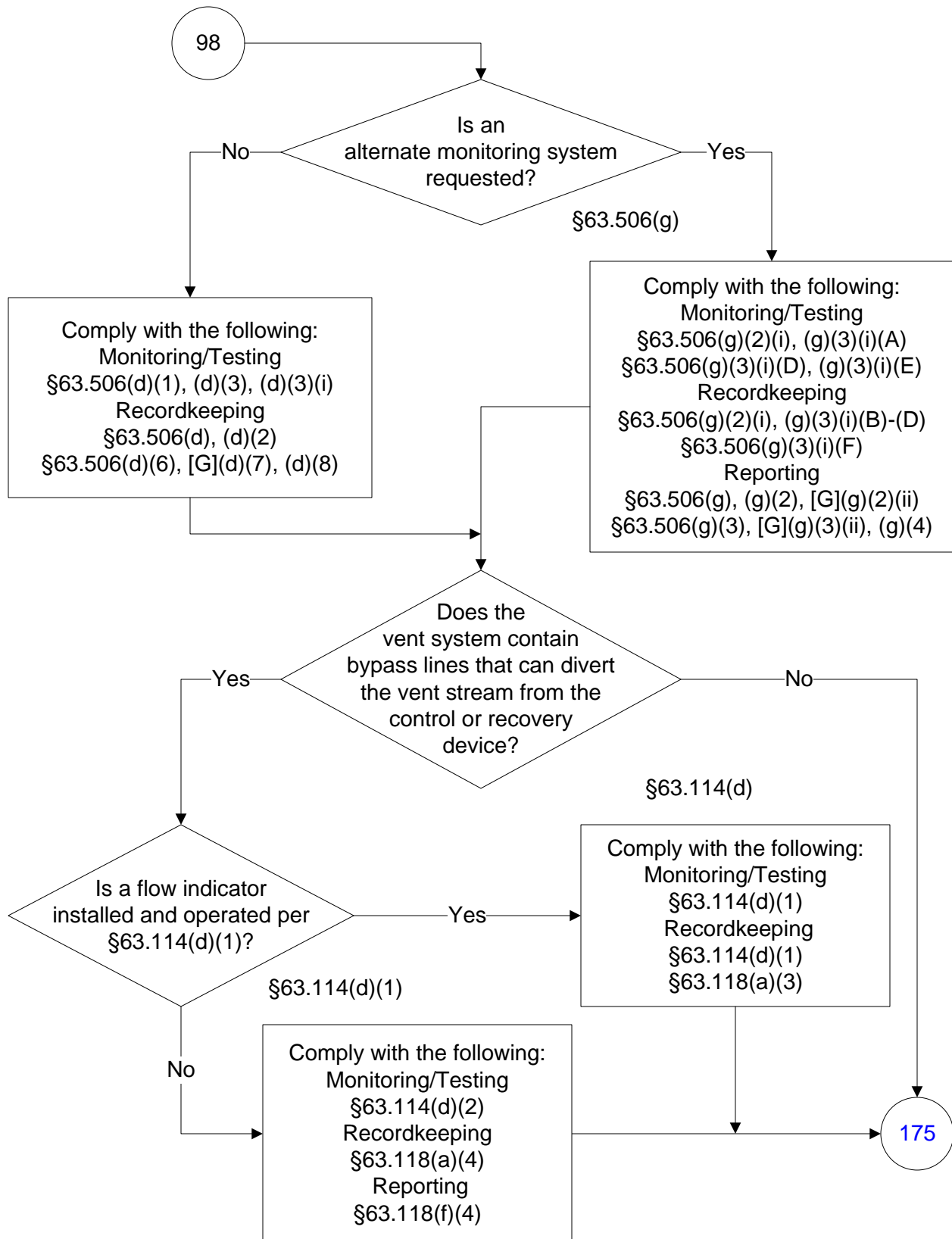

40 CFR Part 63, Subpart U

(48 of 176)

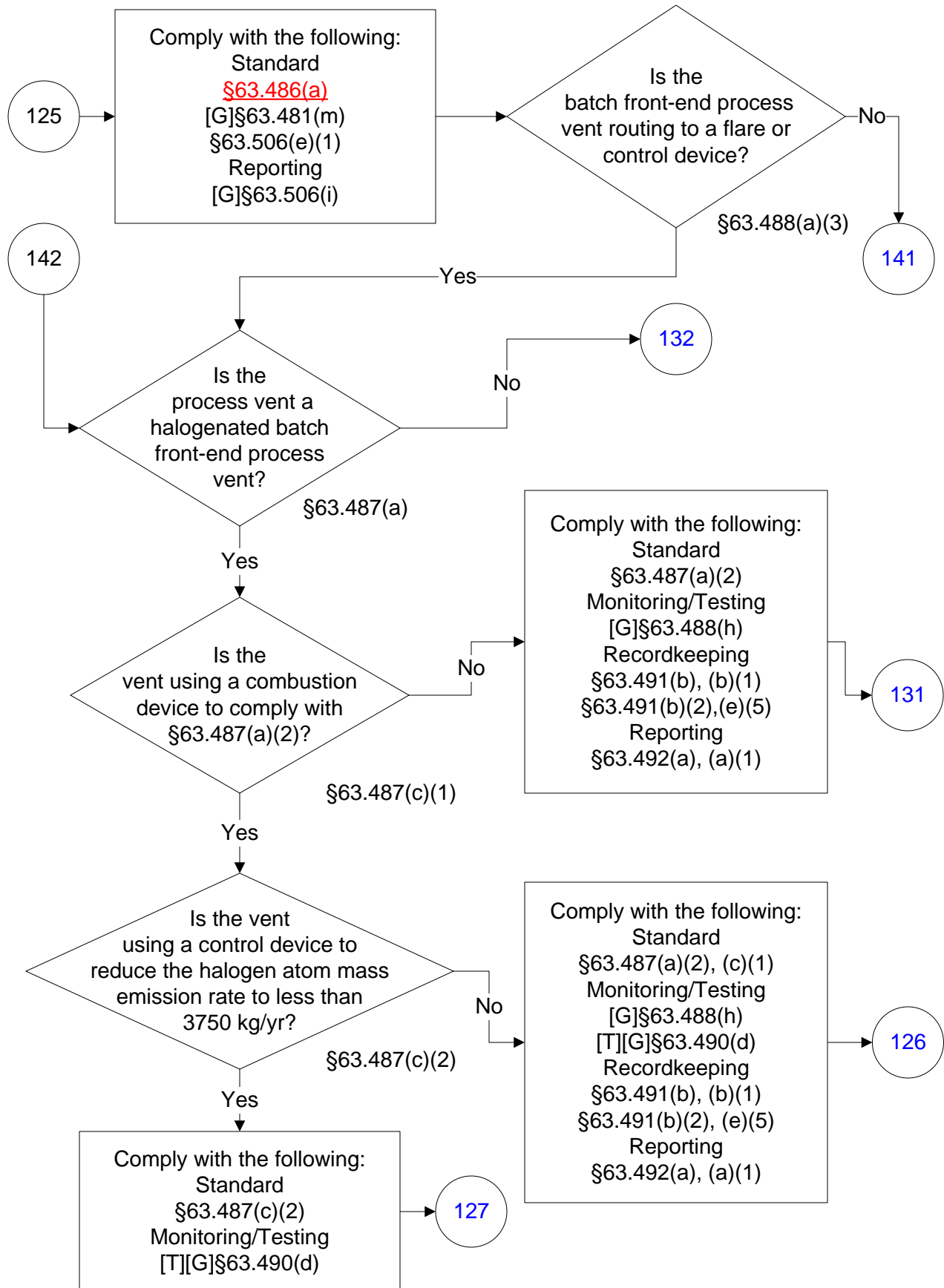

40 CFR Part 63, Subpart U

(49 of 176)

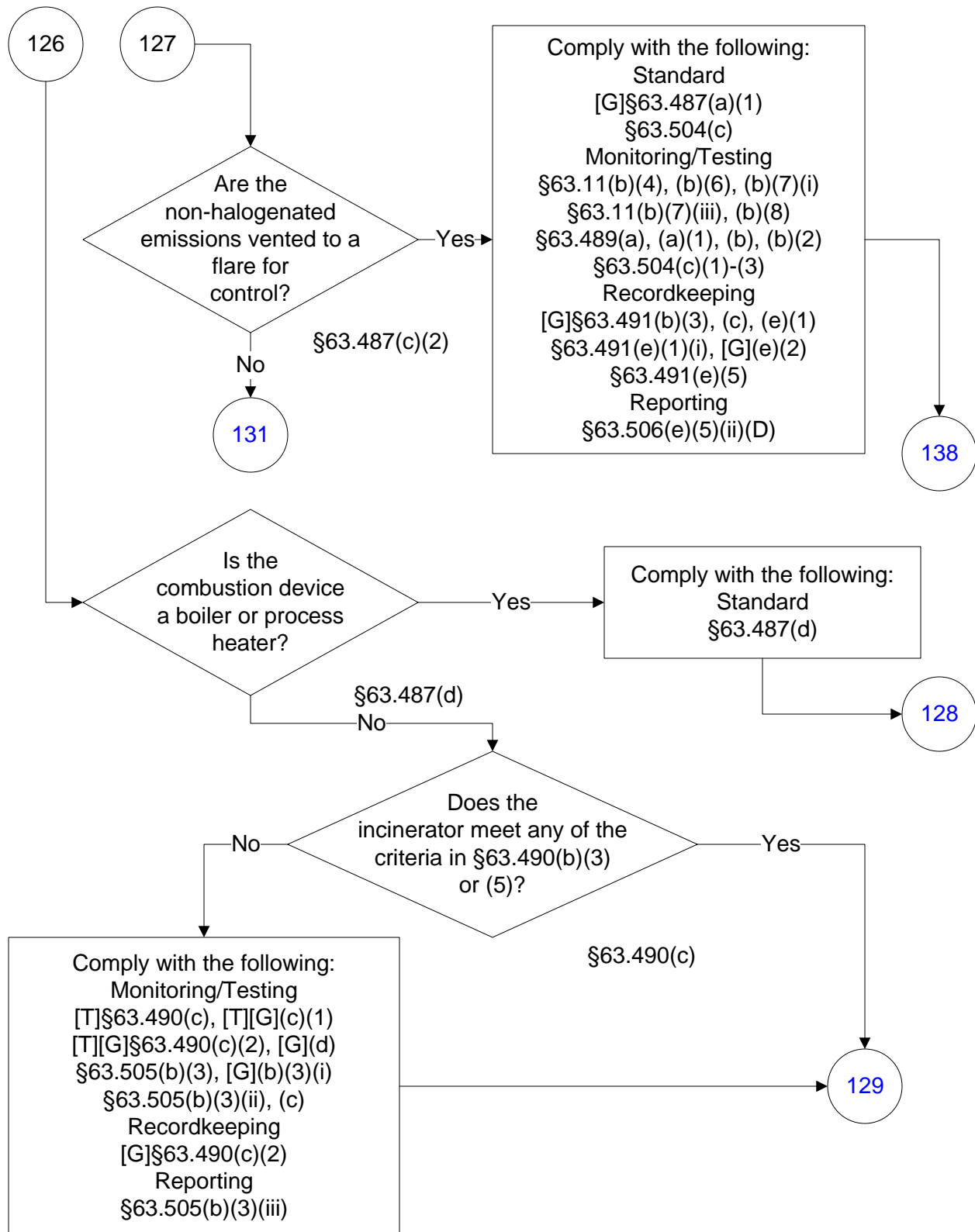

40 CFR Part 63, Subpart U

(50 of 176)

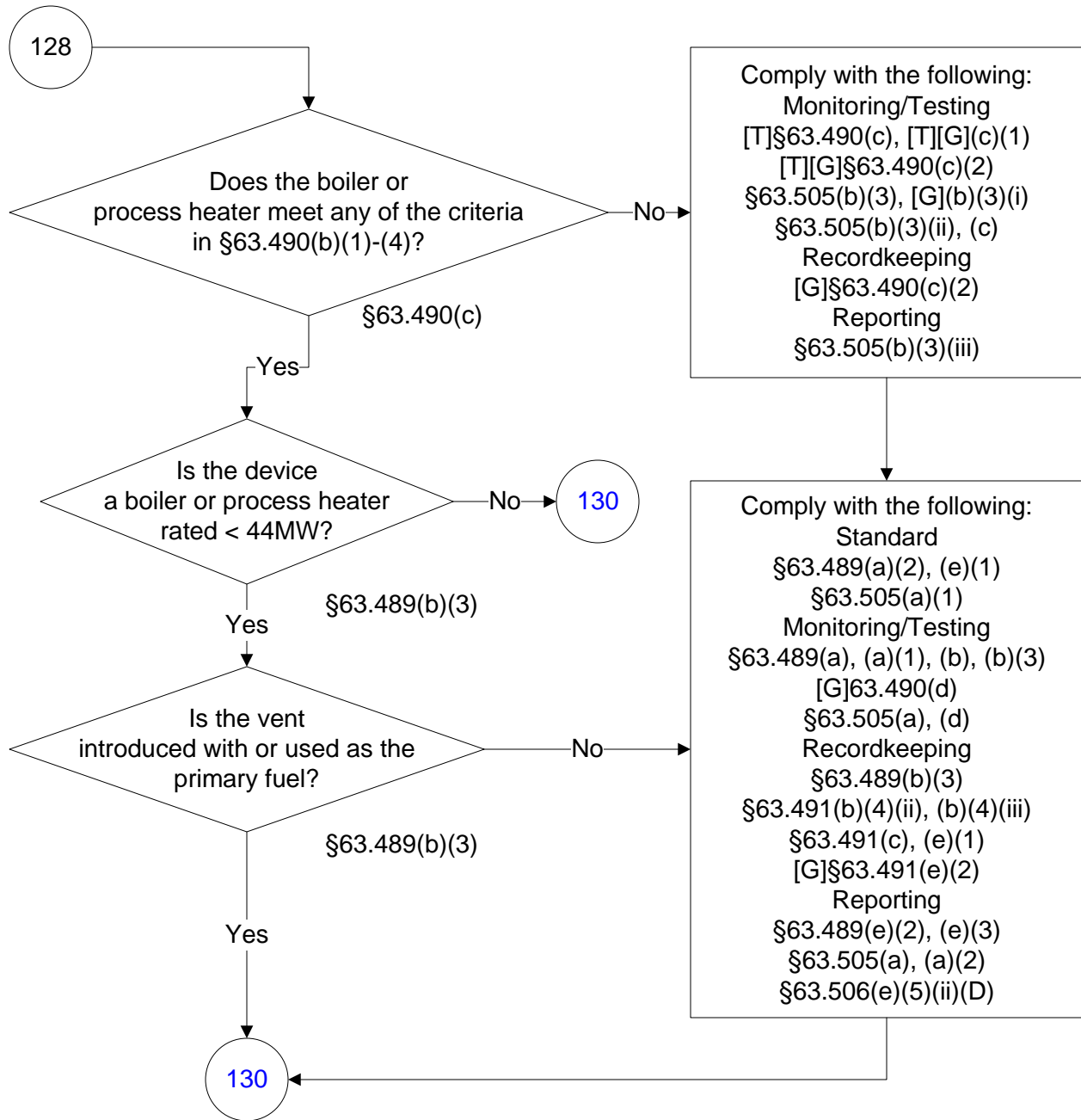

40 CFR Part 63, Subpart U

(51 of 176)

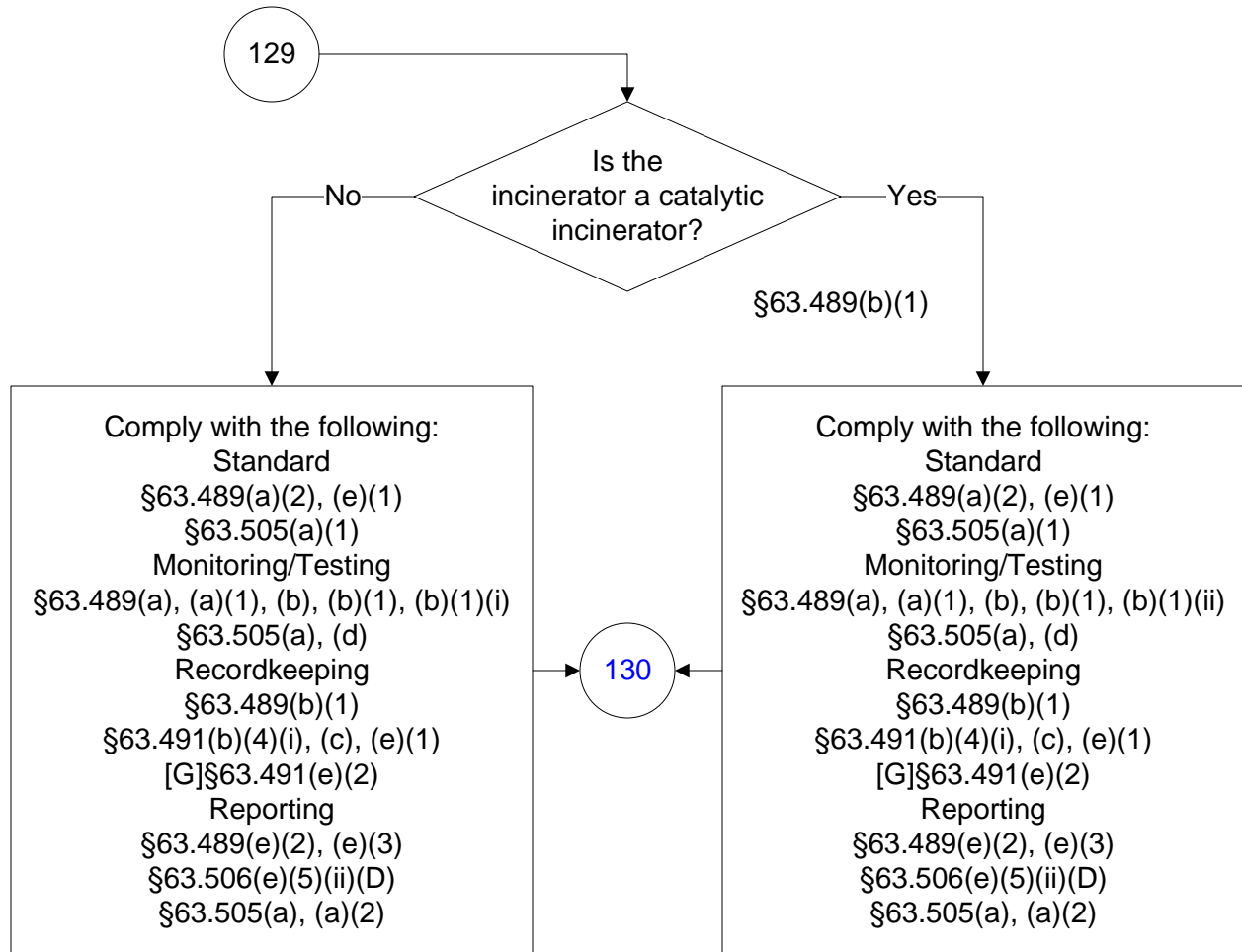

40 CFR Part 63, Subpart U

(52 of 176)

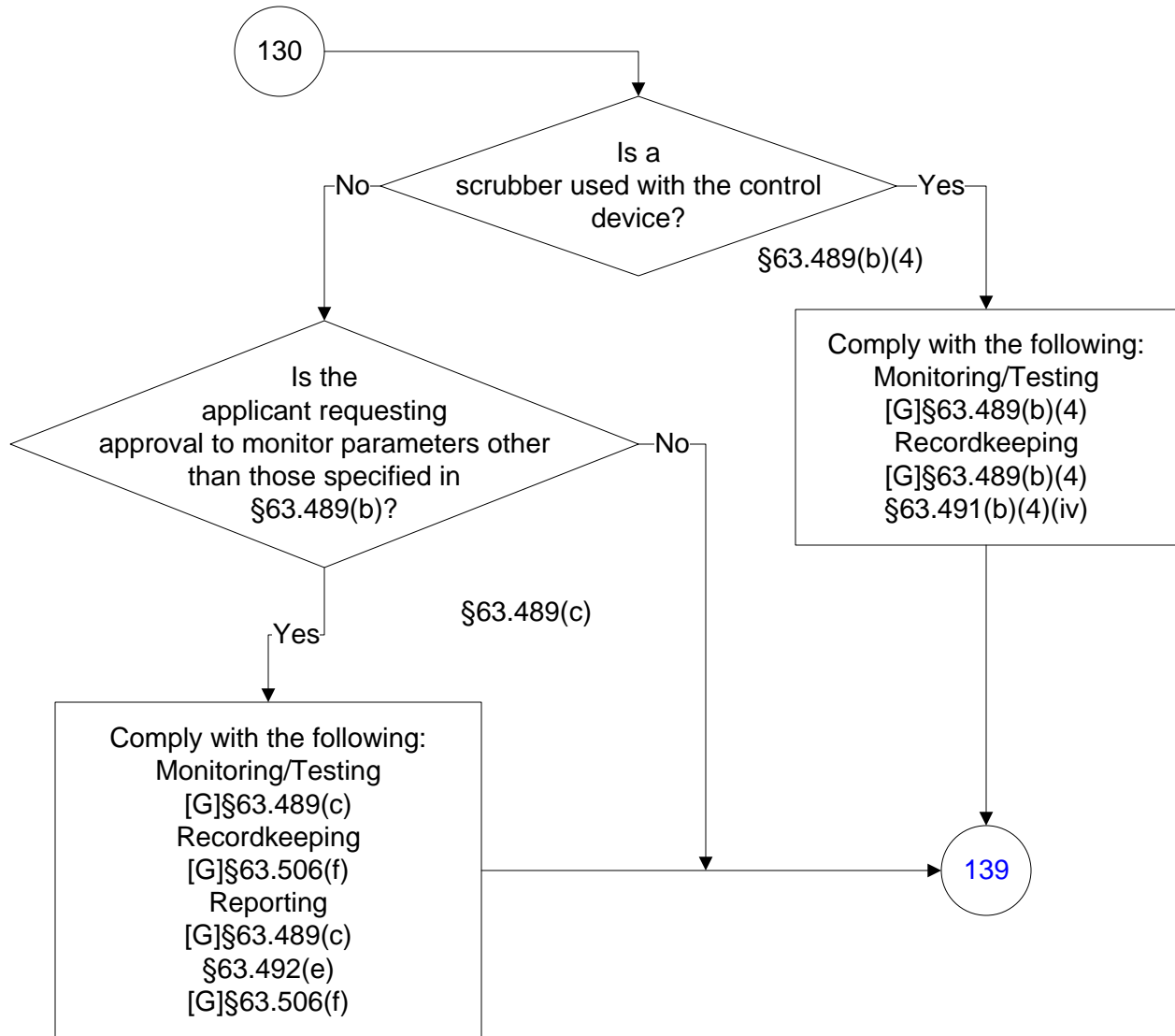

40 CFR Part 63, Subpart U

(53 of 176)

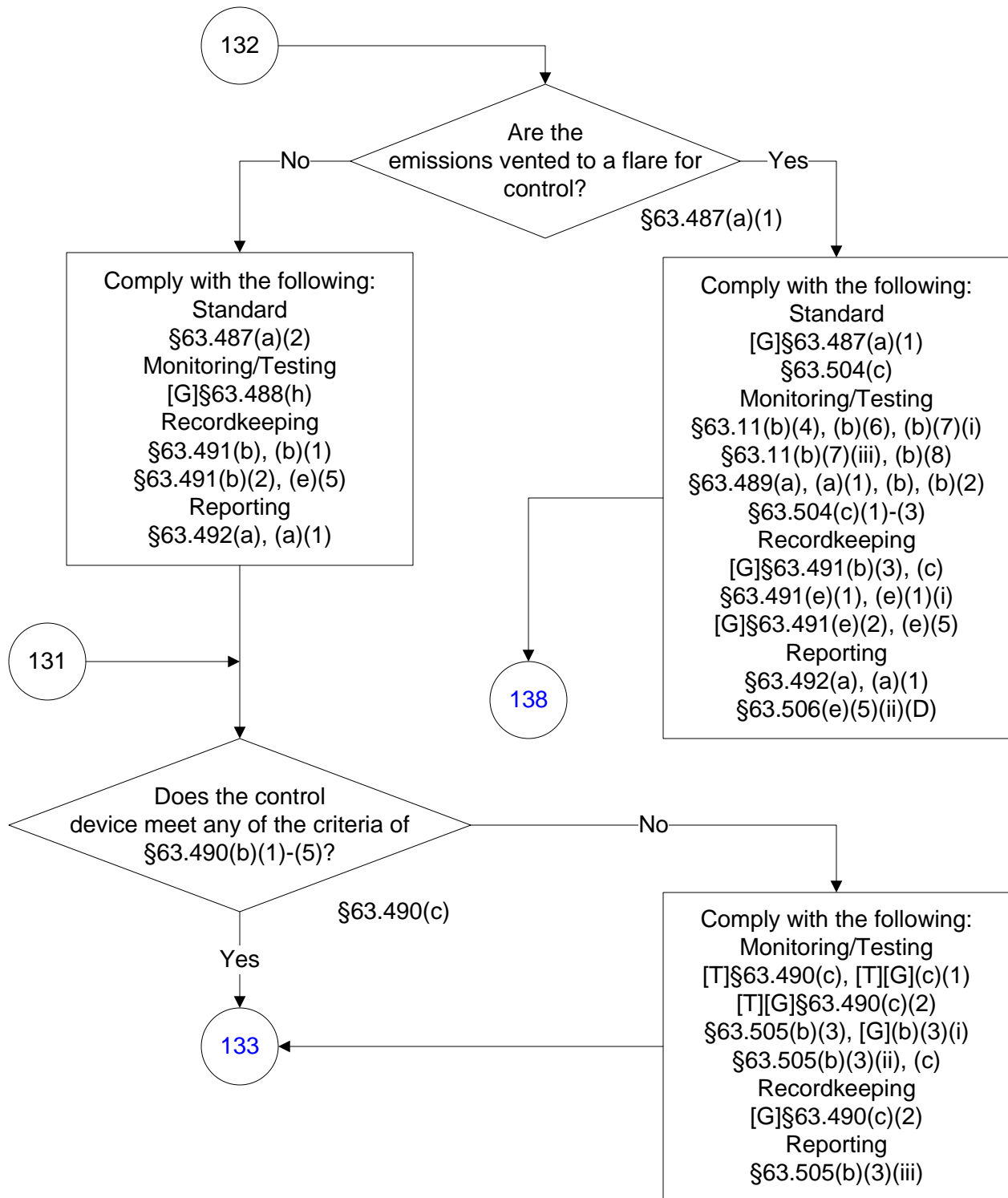

40 CFR Part 63, Subpart U

(54 of 176)

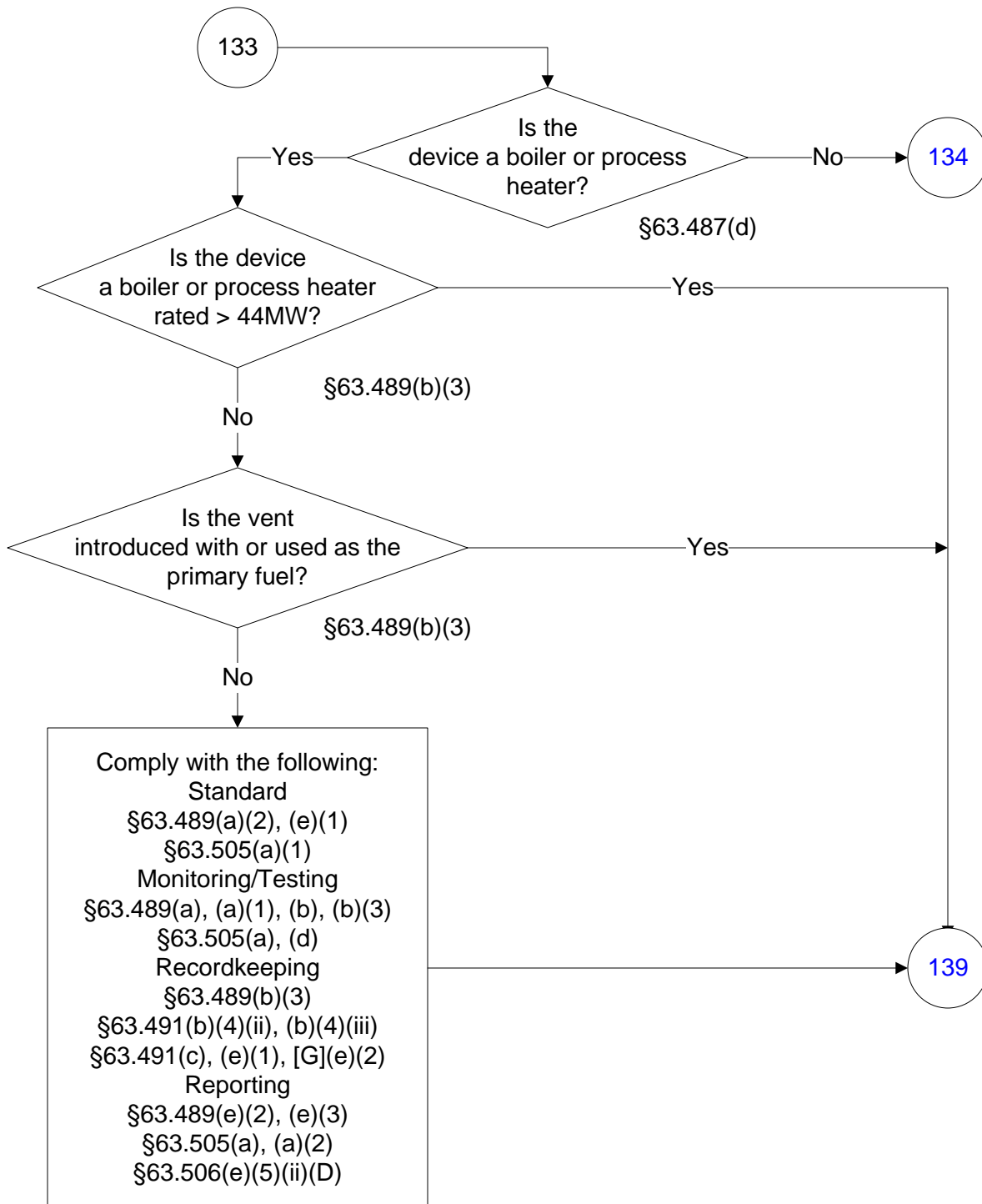

40 CFR Part 63, Subpart U

(55 of 176)

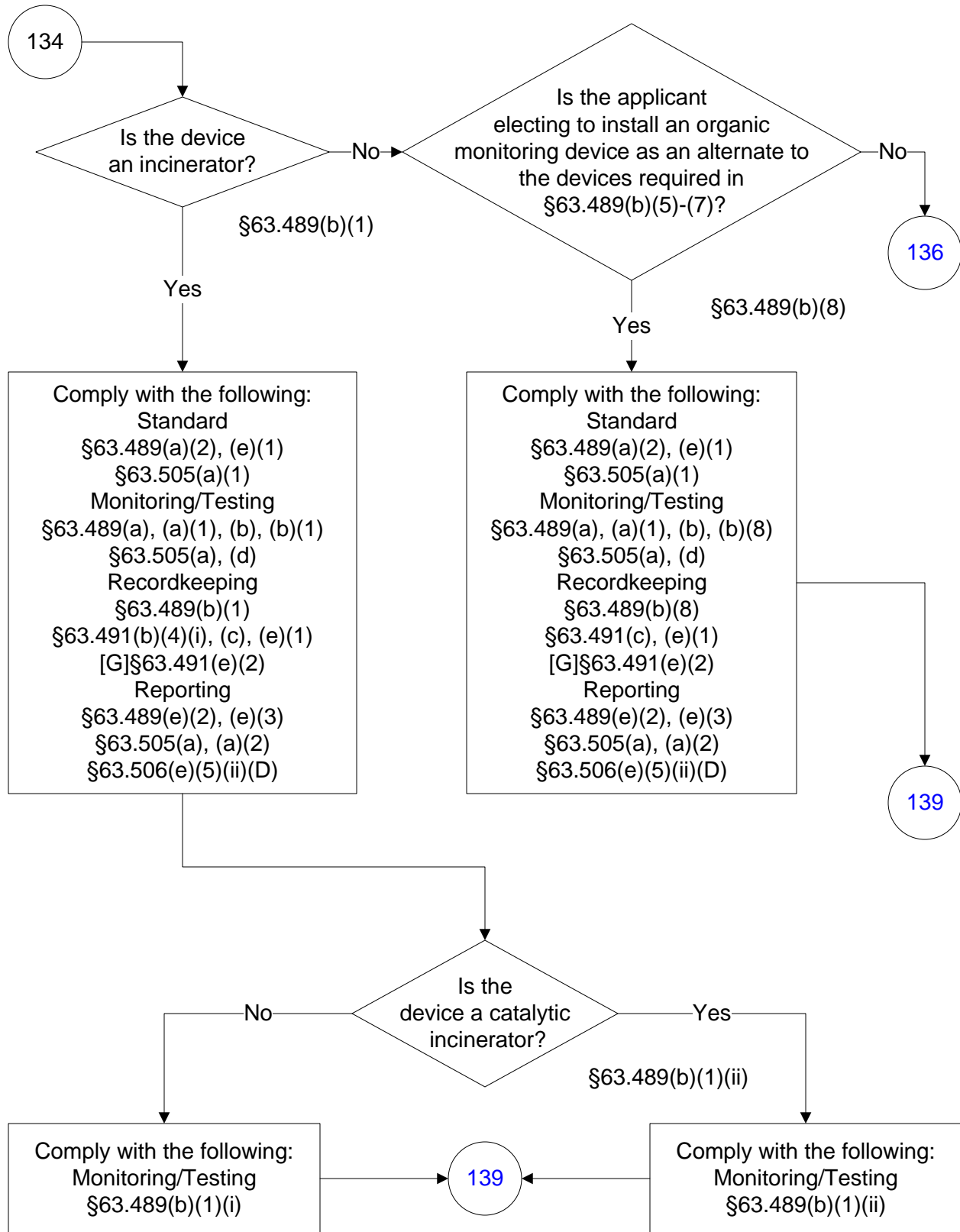

40 CFR Part 63, Subpart U

(56 of 176)

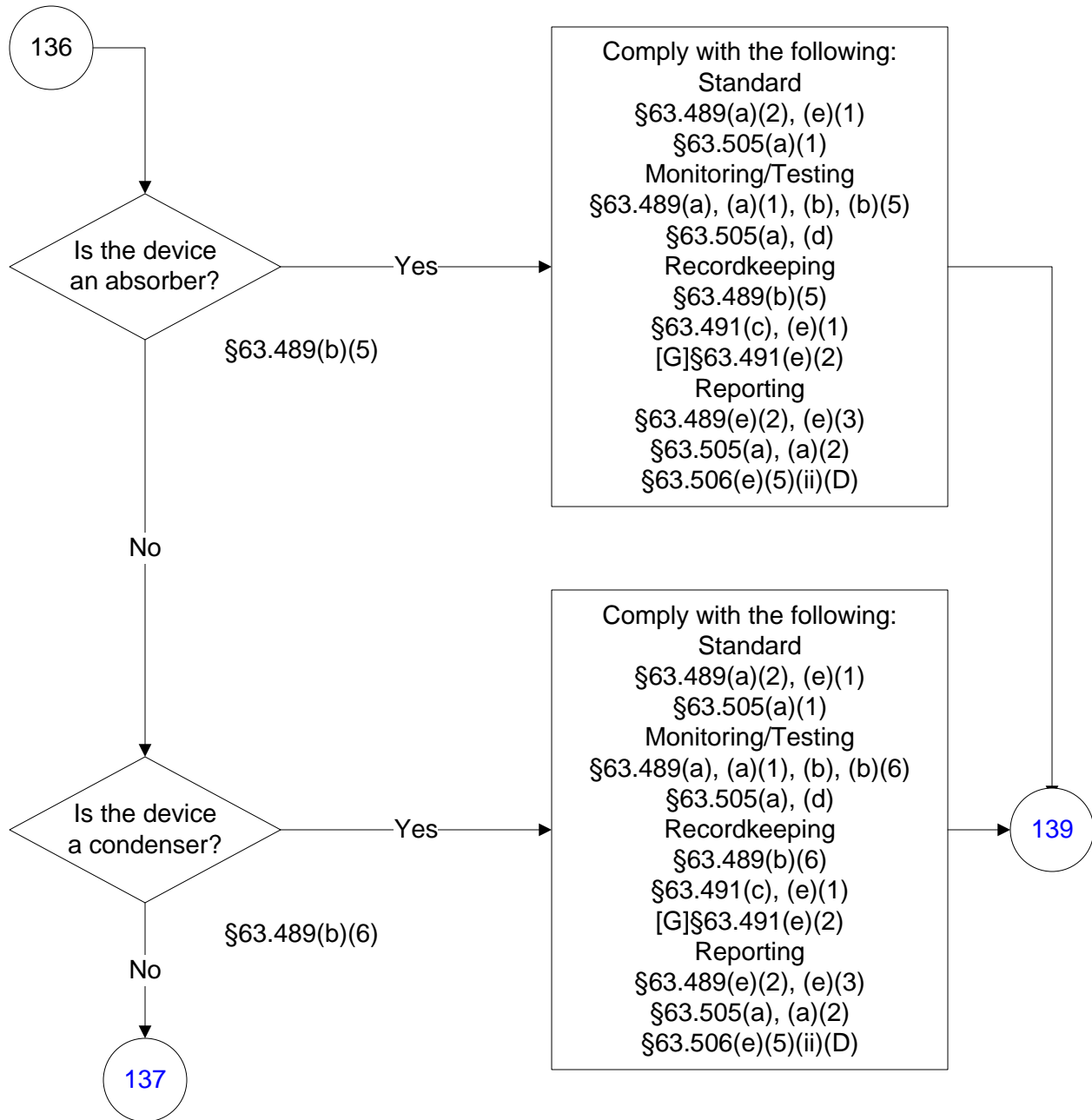

40 CFR Part 63, Subpart U

(57 of 176)

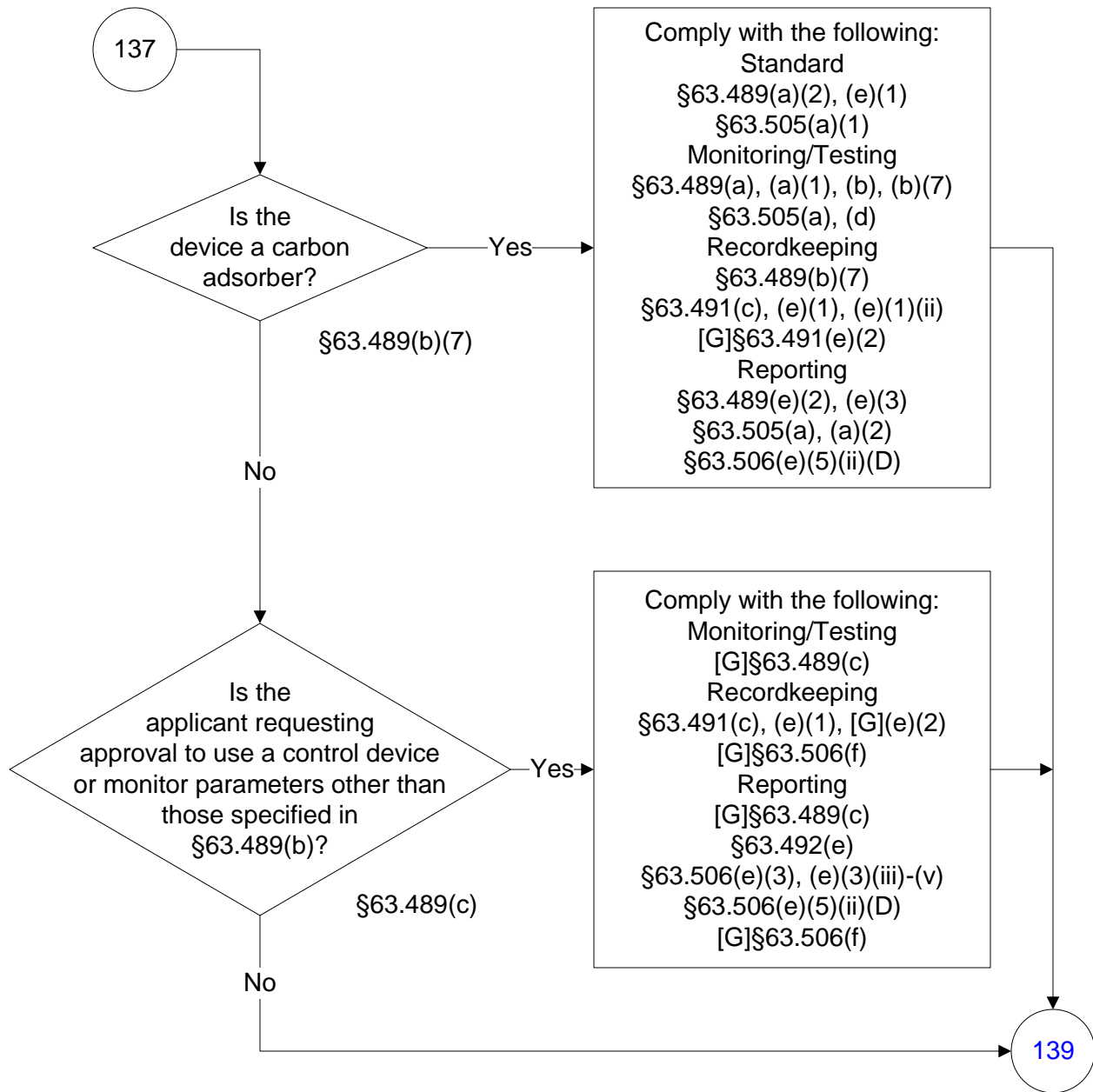

40 CFR Part 63, Subpart U

(58 of 176)

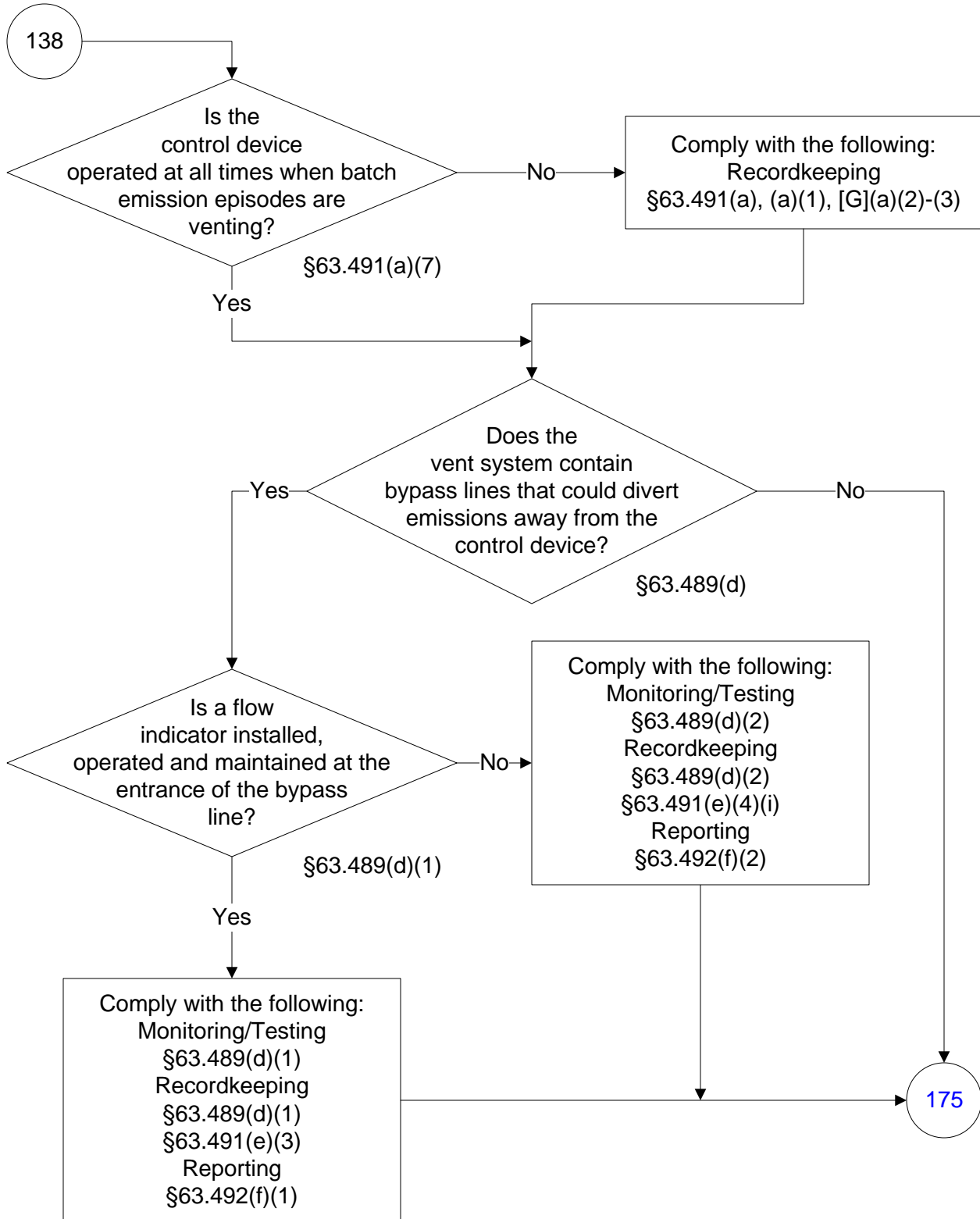

40 CFR Part 63, Subpart U

(59 of 176)

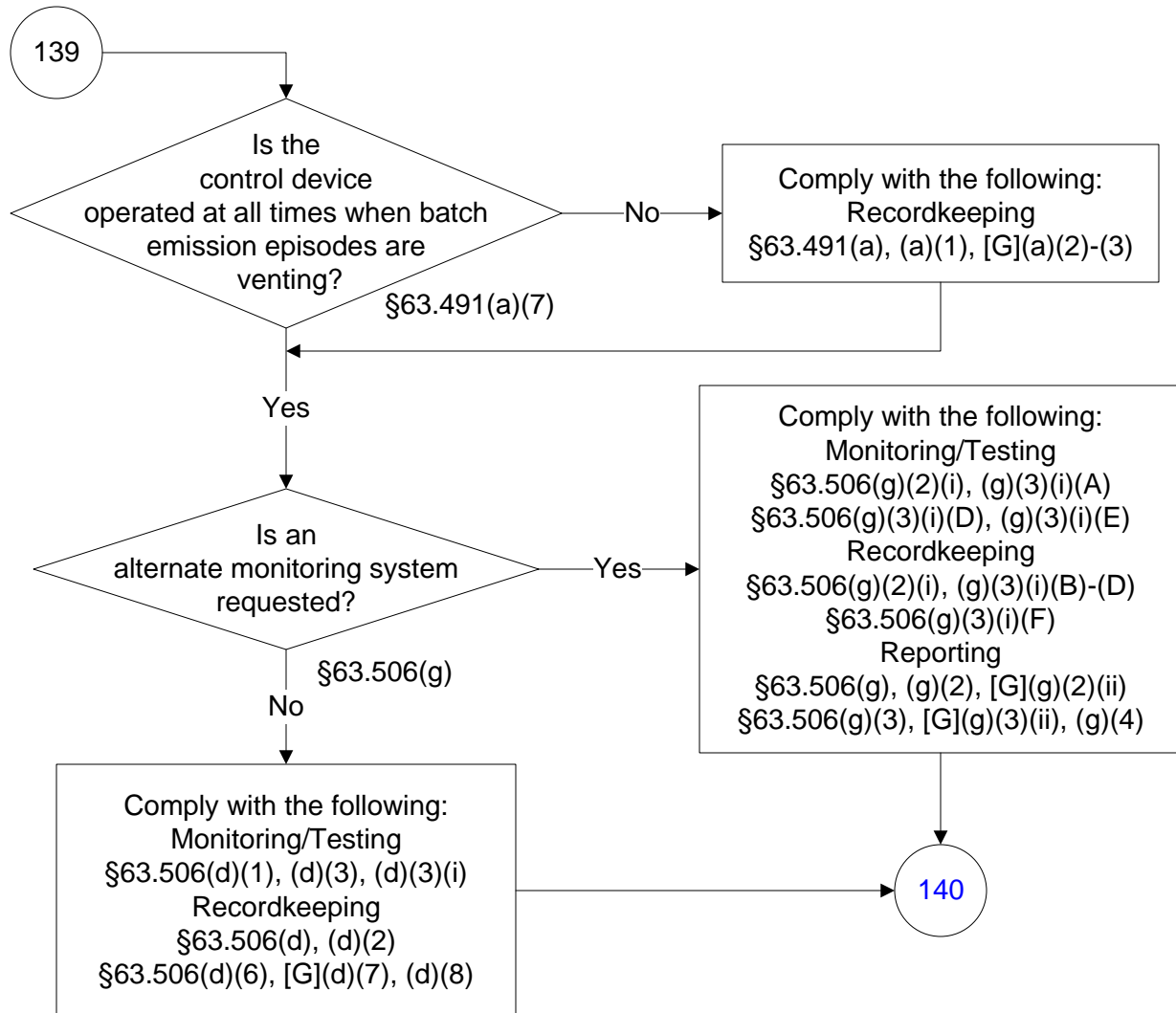

40 CFR Part 63, Subpart U

(60 of 176)

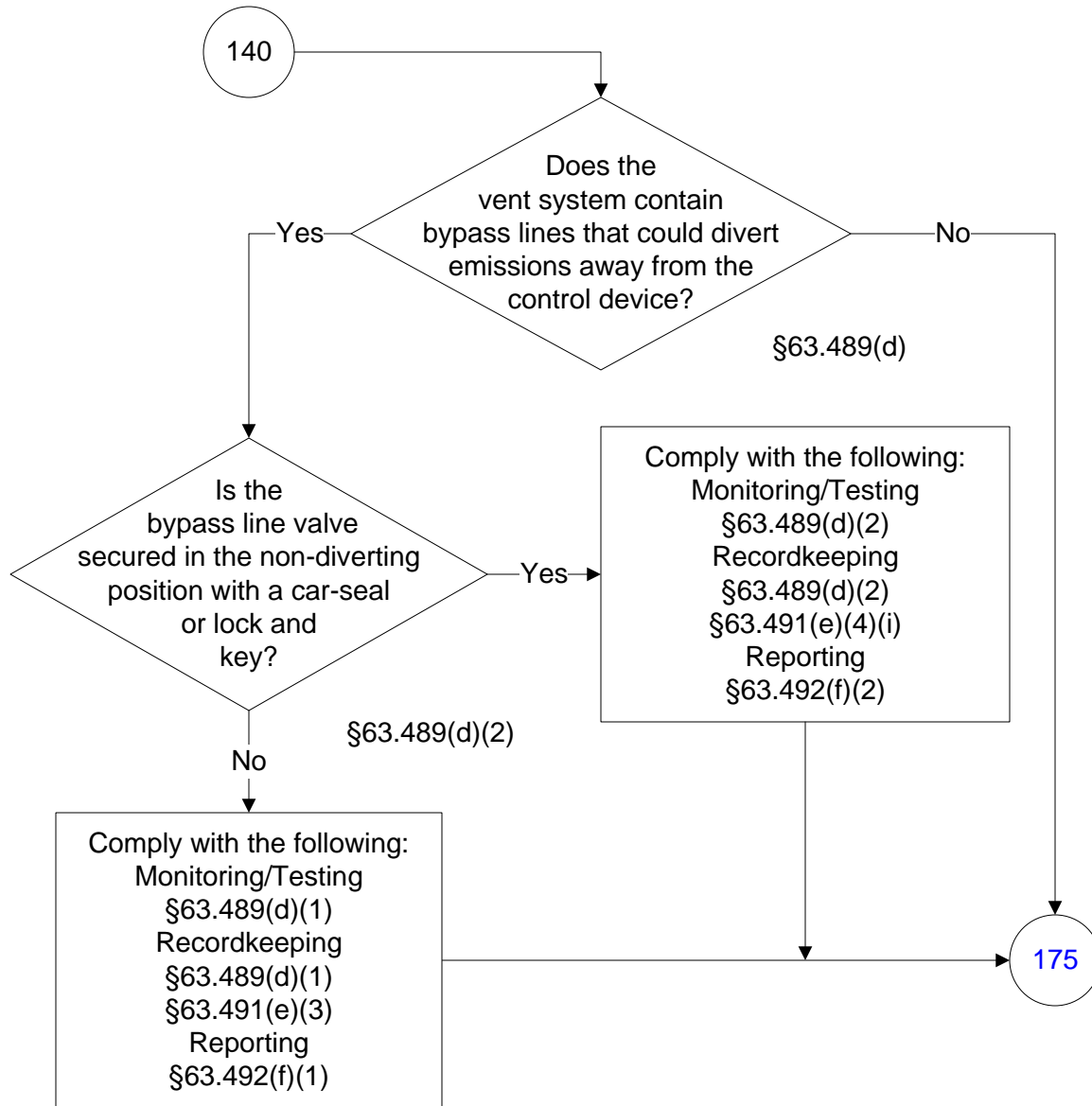

40 CFR Part 63, Subpart U

(61 of 176)

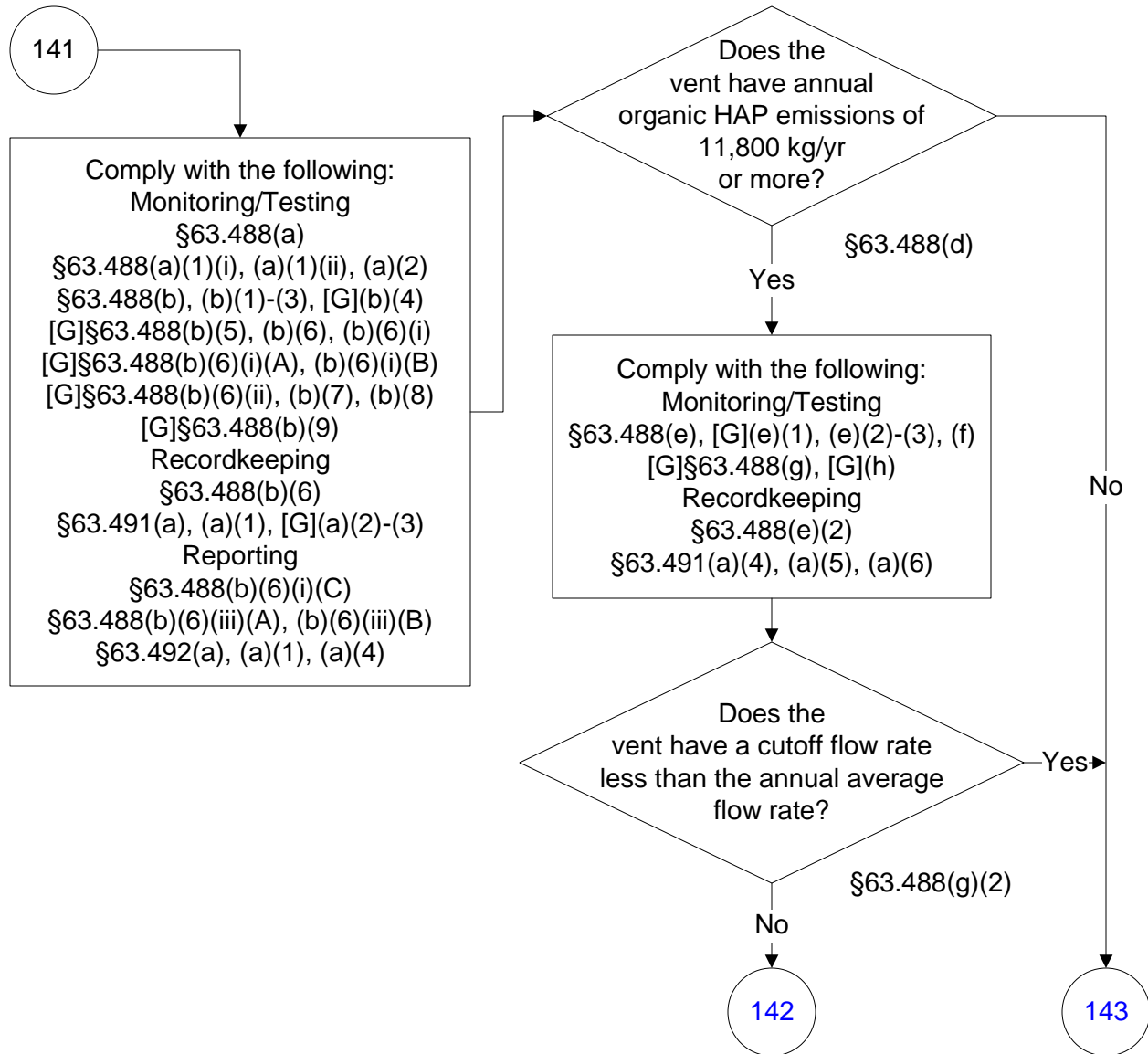

40 CFR Part 63, Subpart U

(62 of 176)

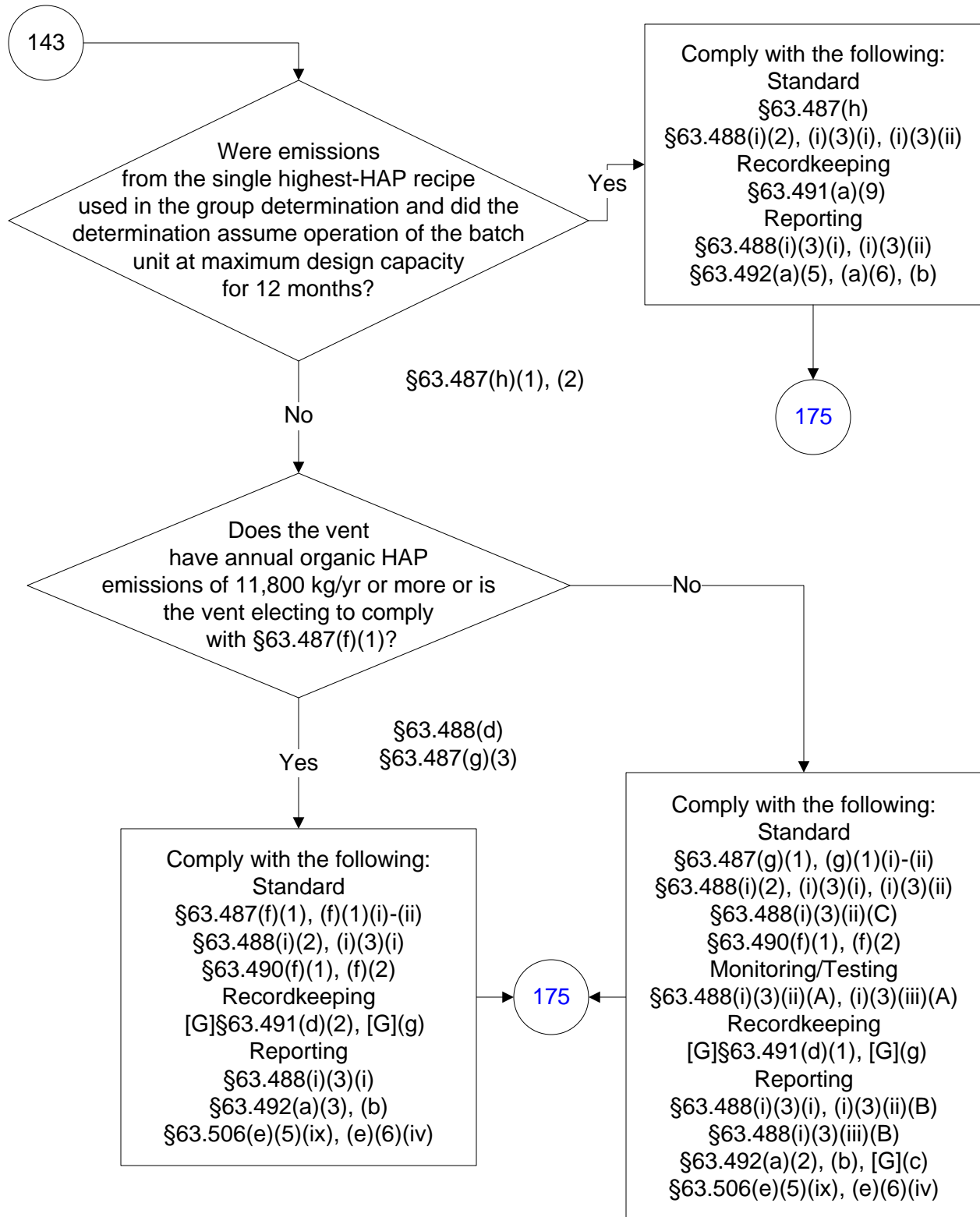

40 CFR Part 63, Subpart U

(63 of 176)

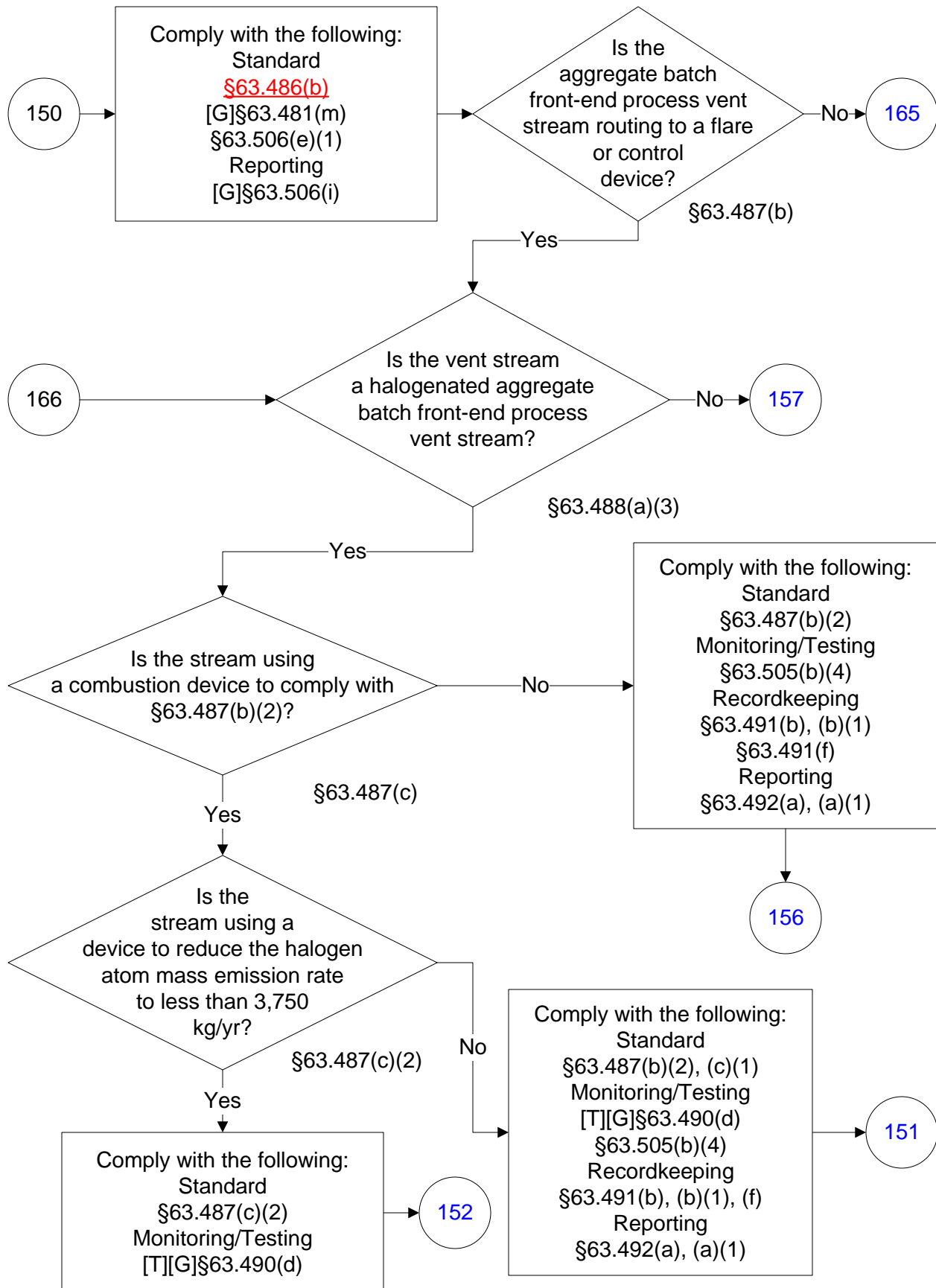

40 CFR Part 63, Subpart U

(64 of 176)

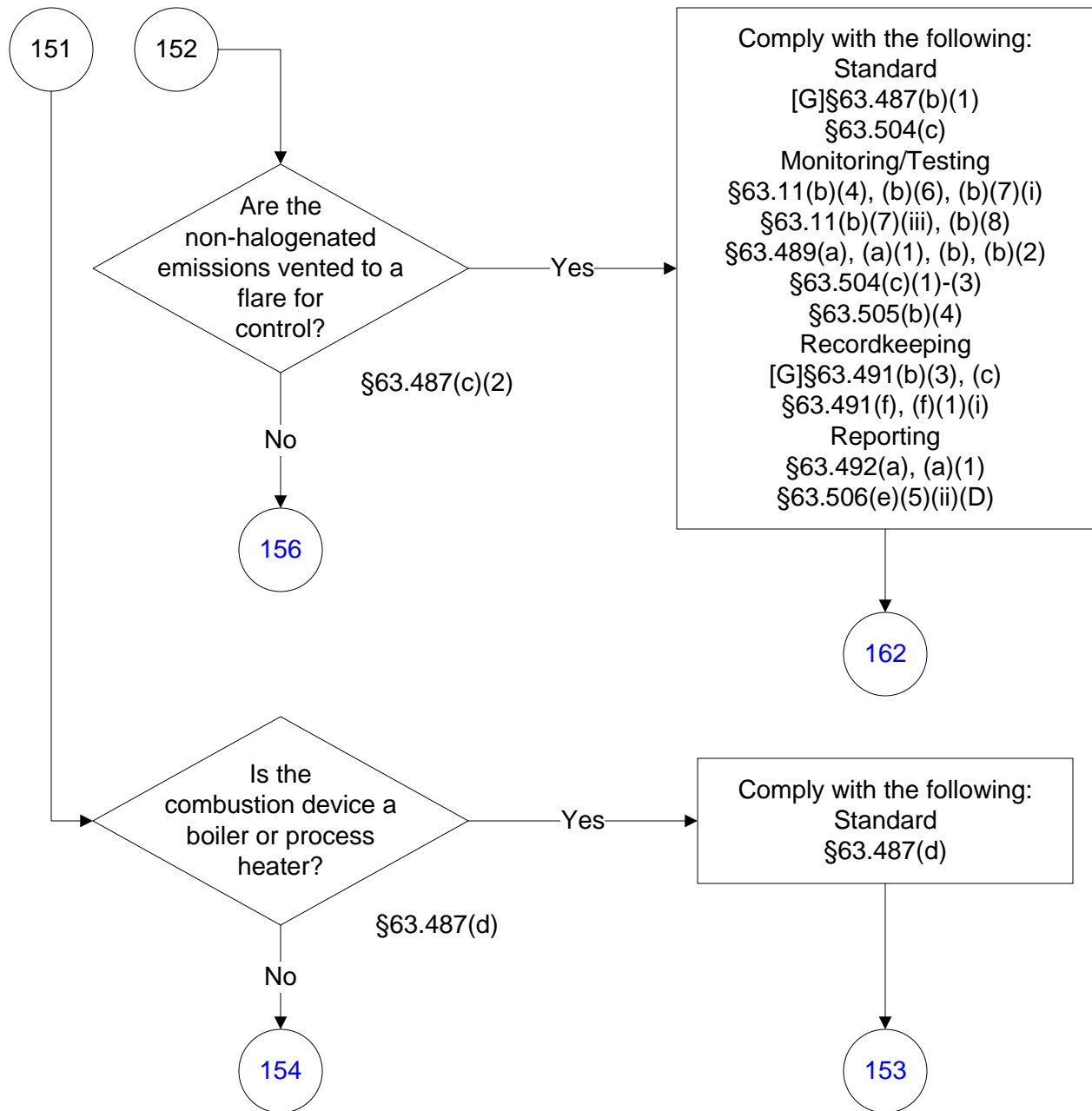

40 CFR Part 63, Subpart U

(65 of 176)

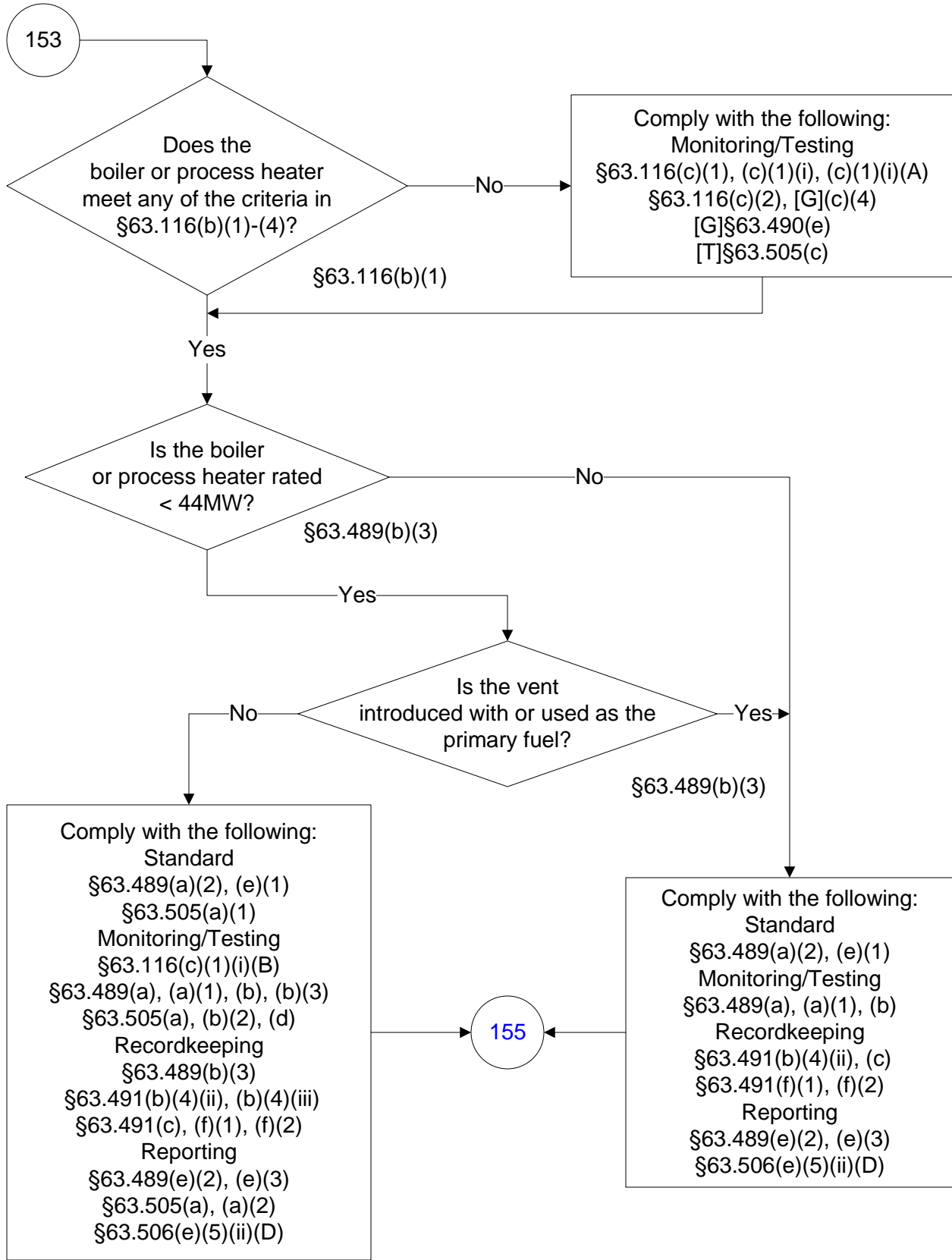

40 CFR Part 63, Subpart U

(66 of 176)

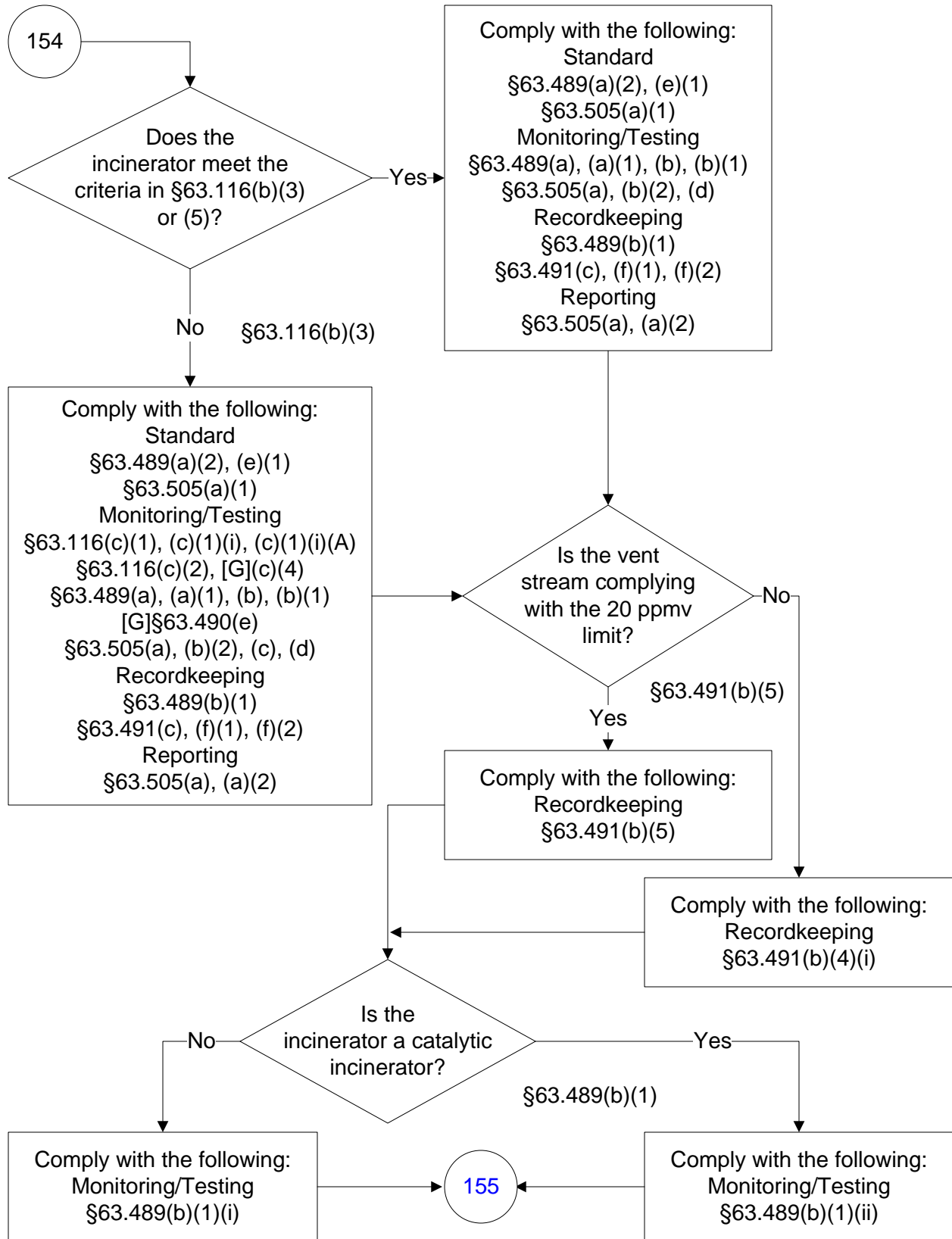

40 CFR Part 63, Subpart U

(67 of 176)

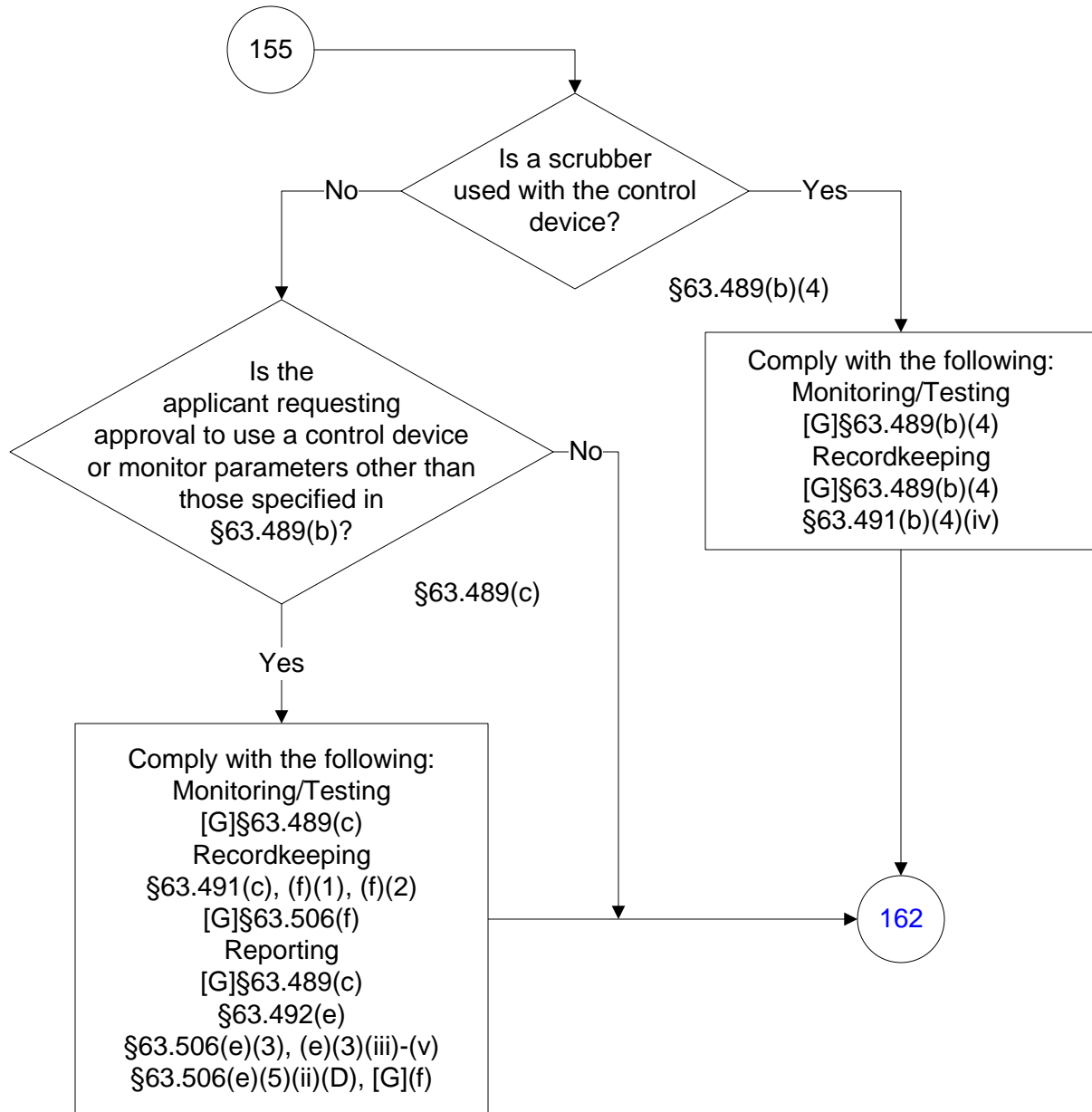

40 CFR Part 63, Subpart U

(68 of 176)

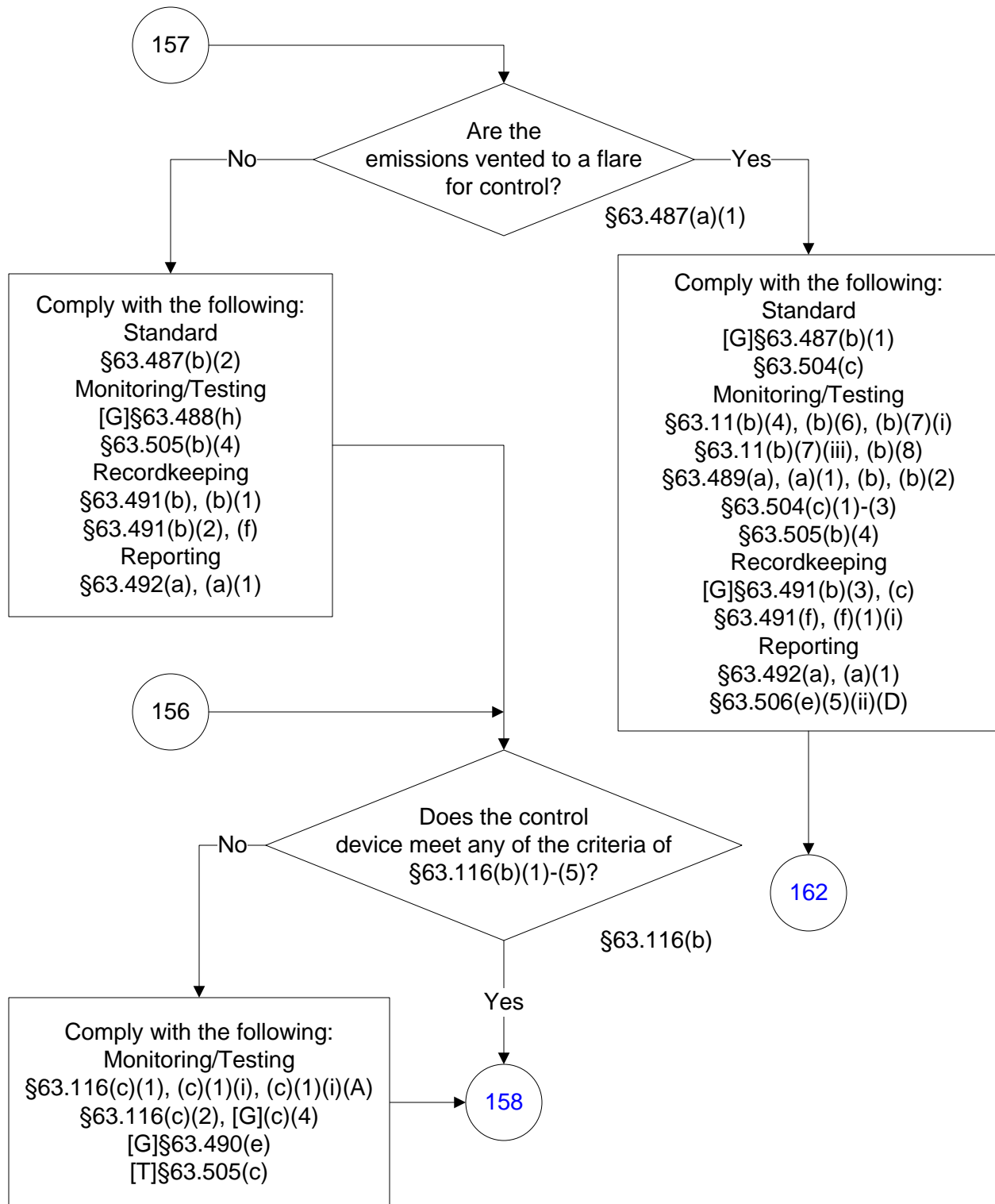

40 CFR Part 63, Subpart U

(69 of 176)

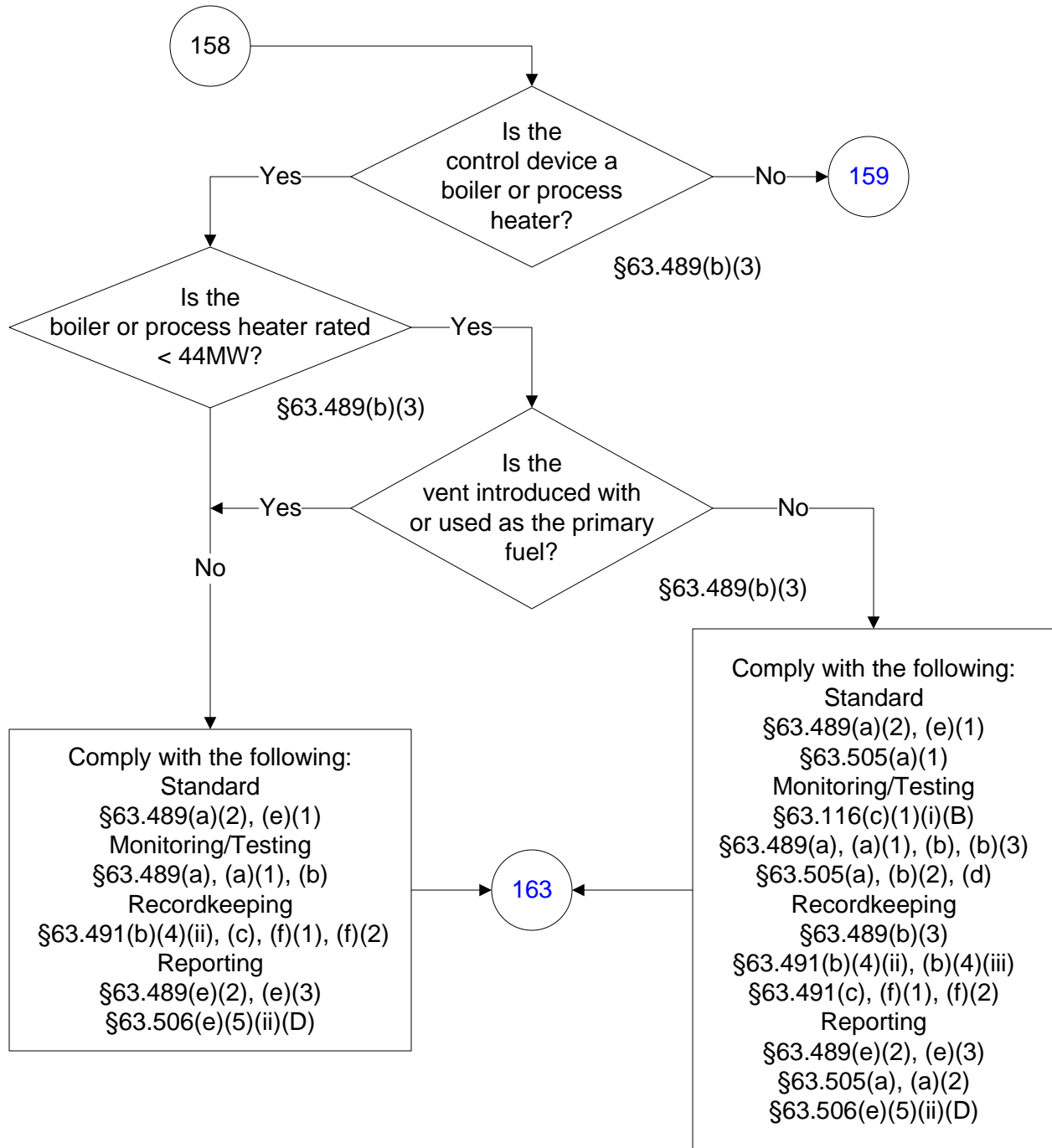

40 CFR Part 63, Subpart U

(70 of 176)

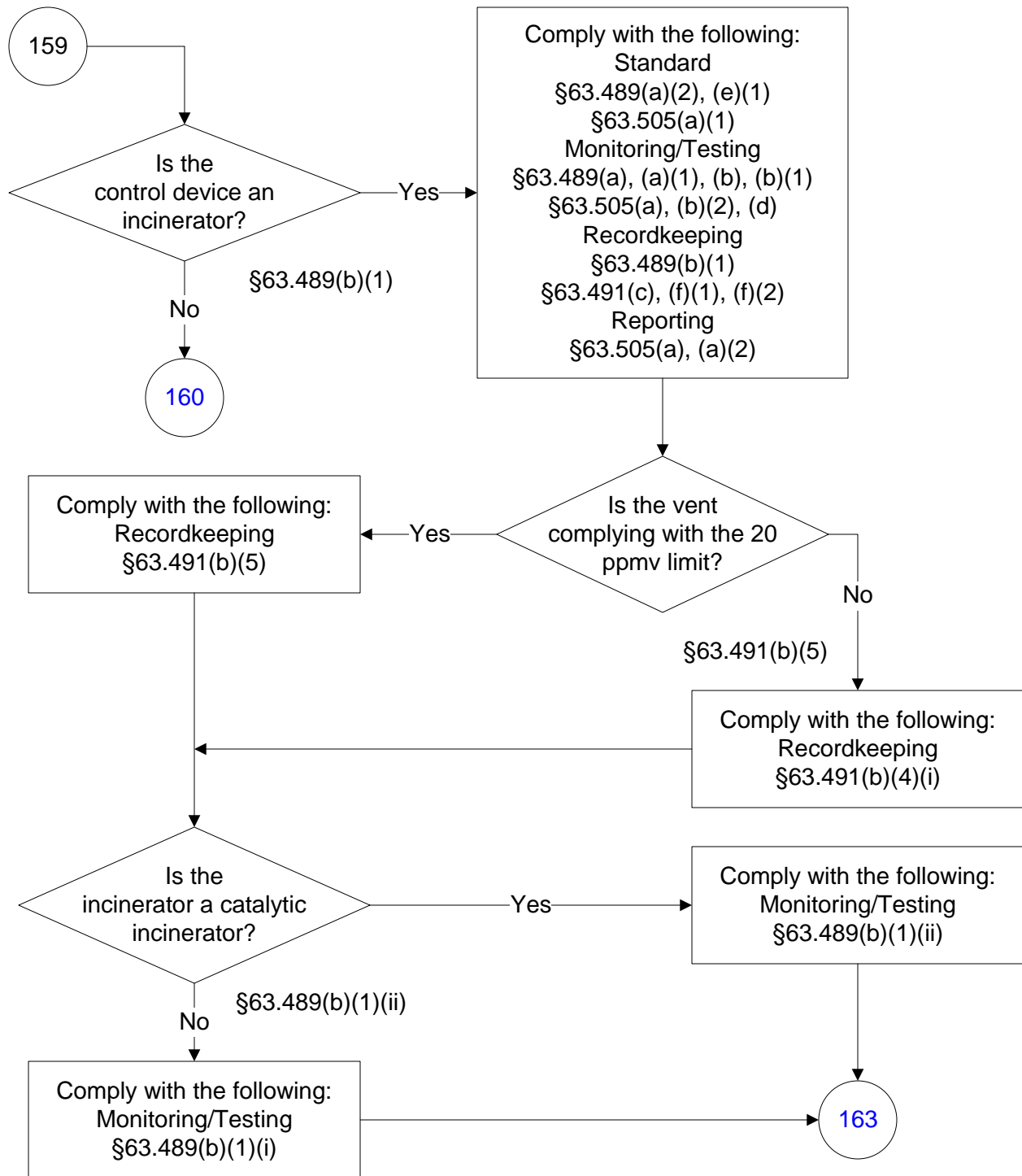

40 CFR Part 63, Subpart U

(71 of 176)

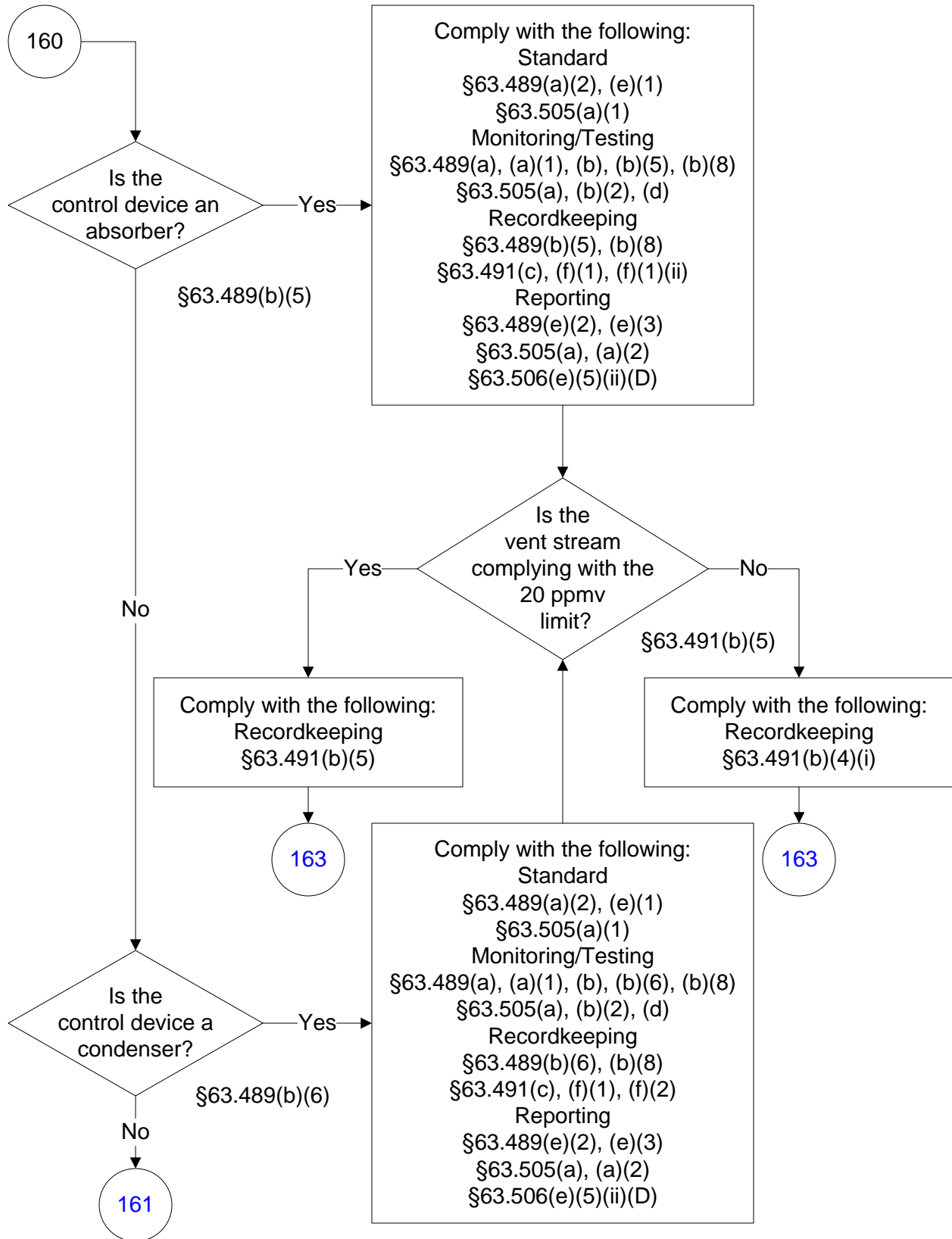

40 CFR Part 63, Subpart U

(72 of 176)

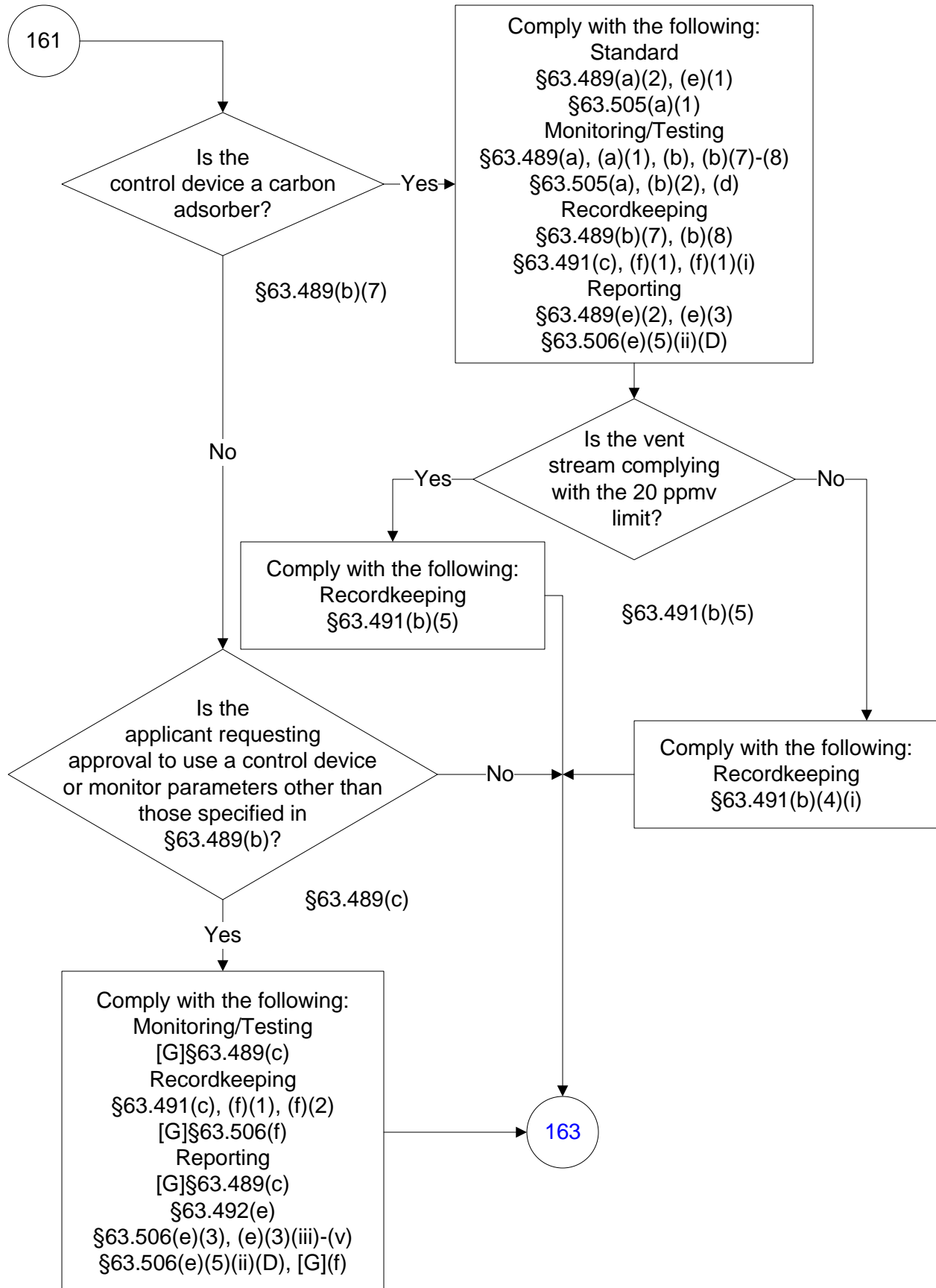

40 CFR Part 63, Subpart U

(73 of 176)

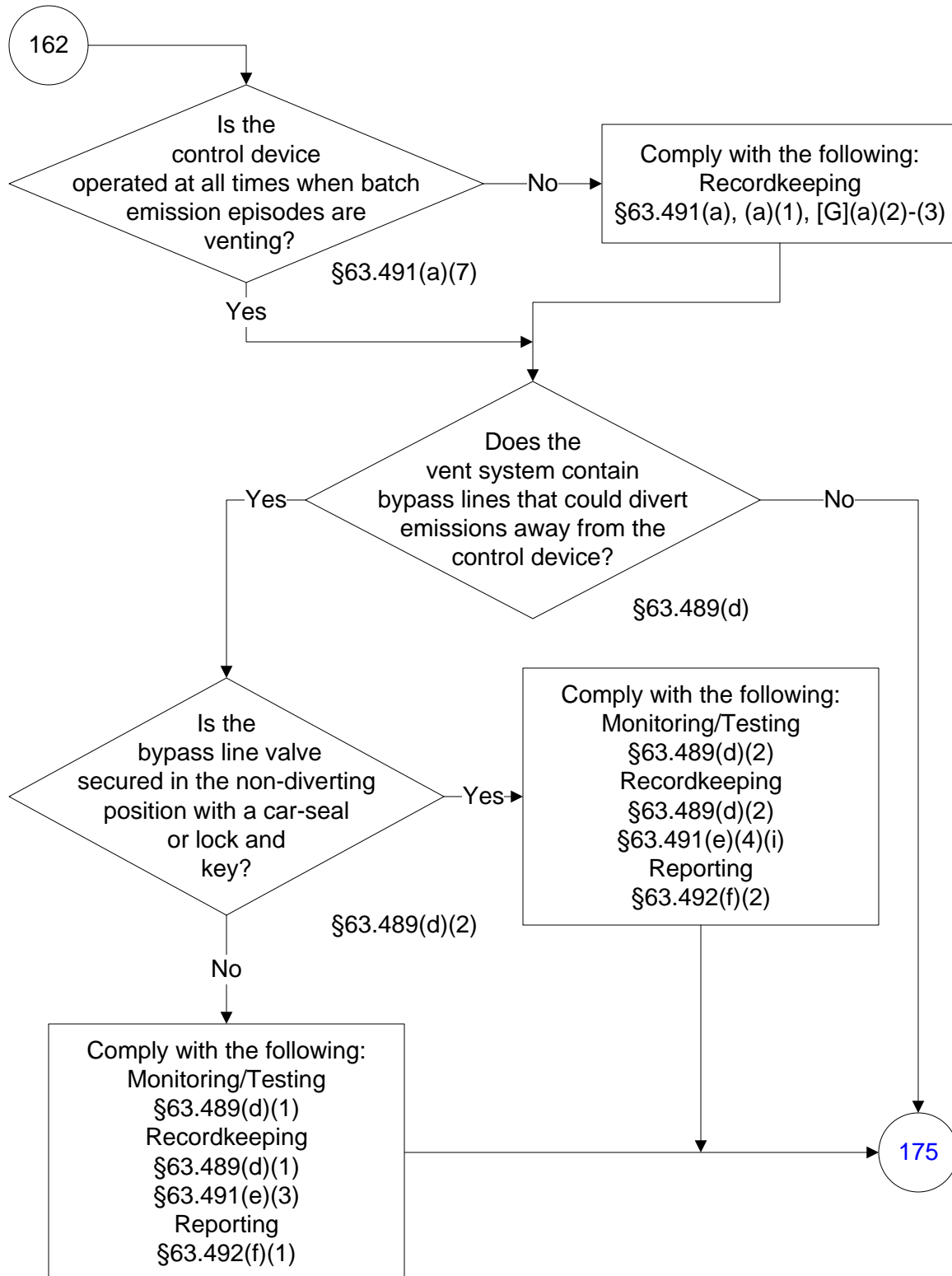

40 CFR Part 63, Subpart U

(74 of 176)

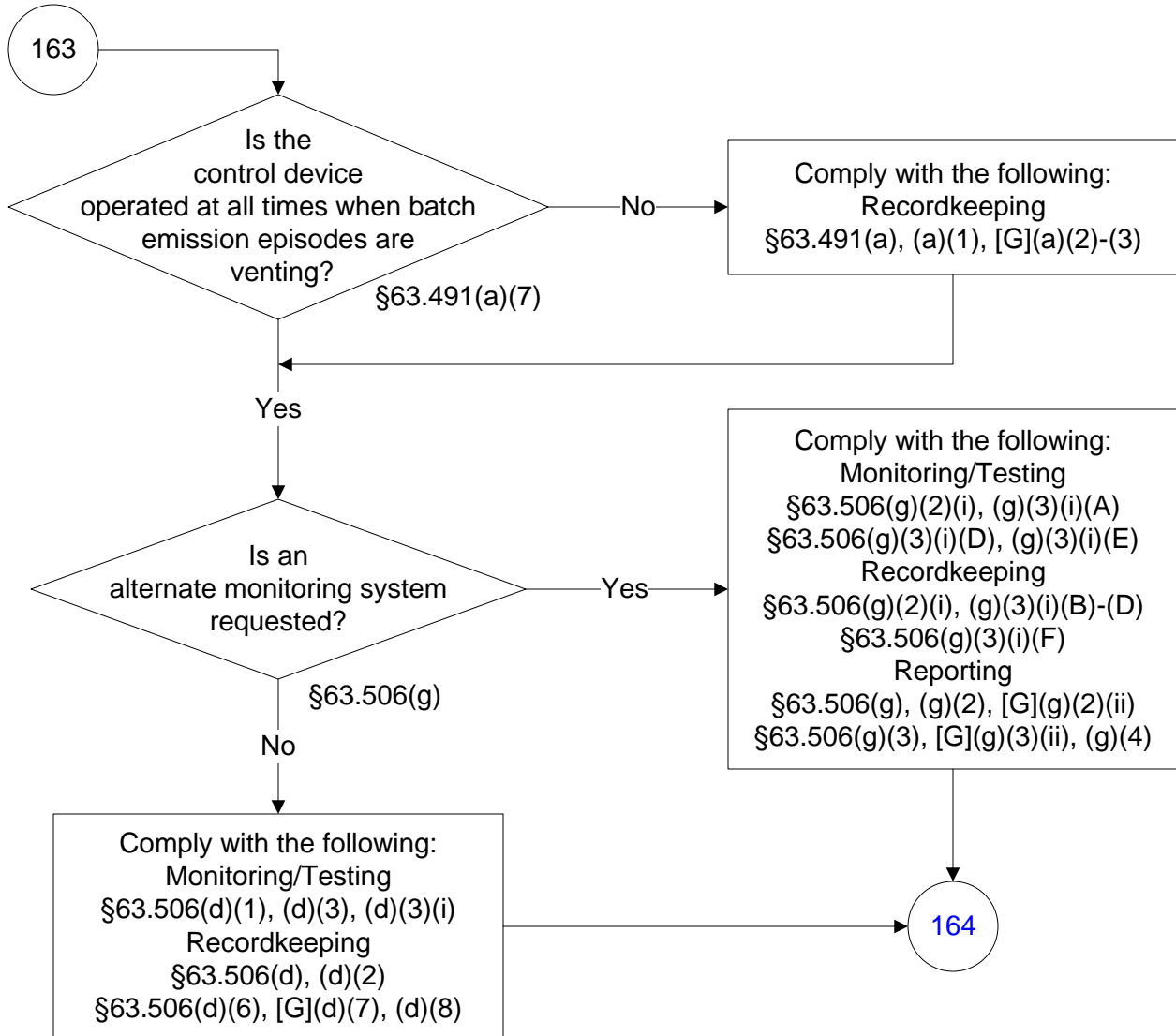

40 CFR Part 63, Subpart U

(75 of 176)

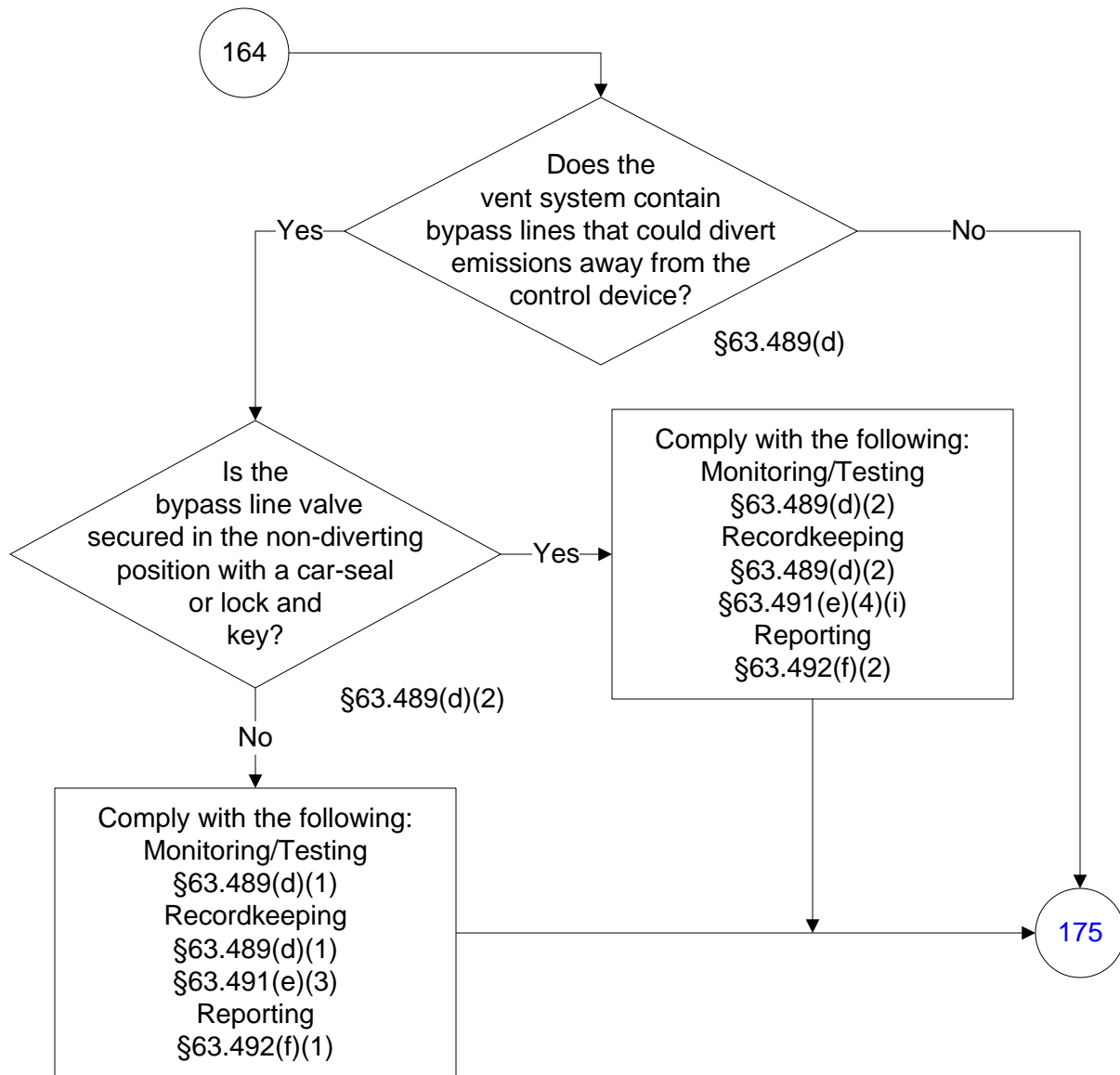

40 CFR Part 63, Subpart U

(76 of 176)

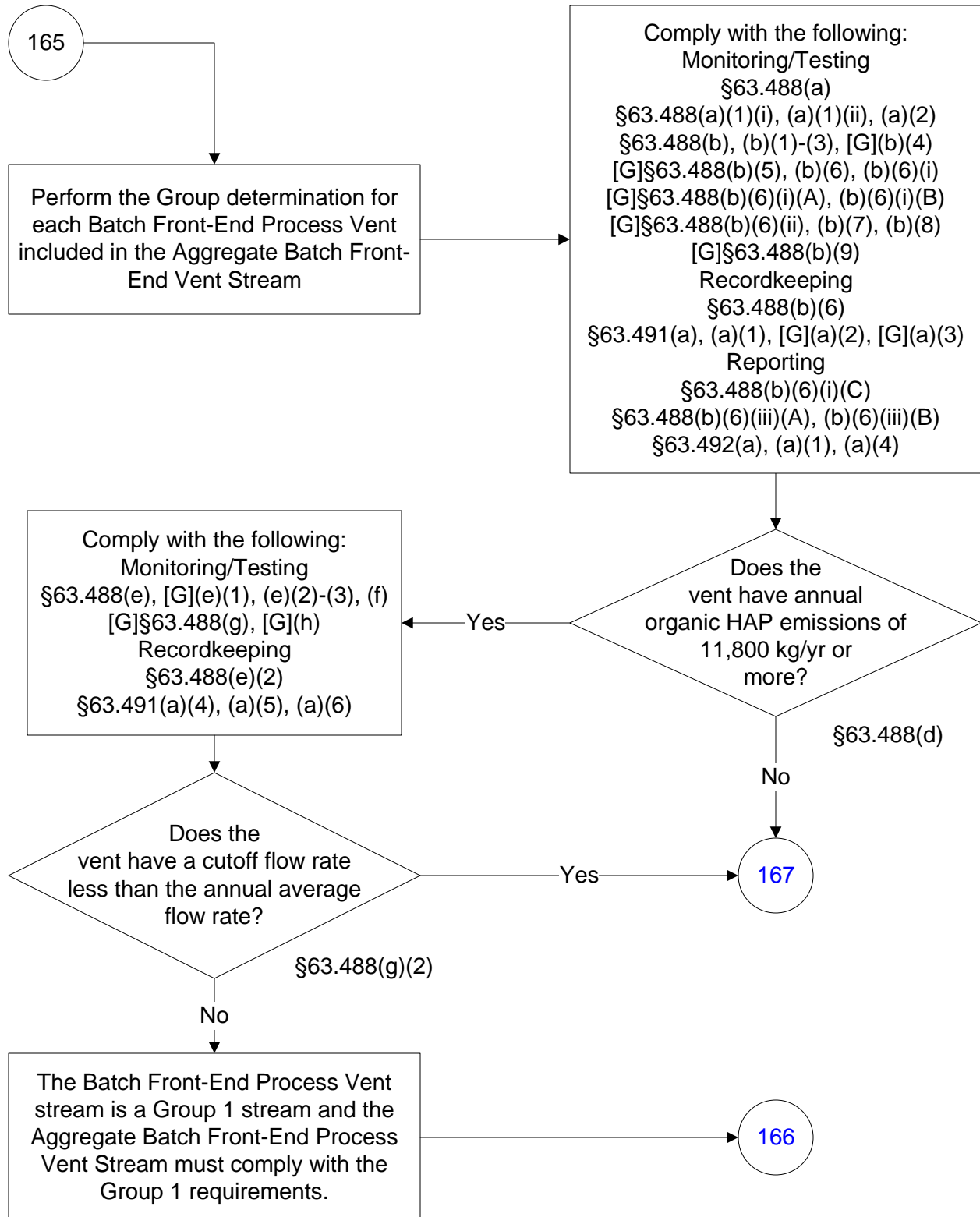

40 CFR Part 63, Subpart U

(77 of 176)

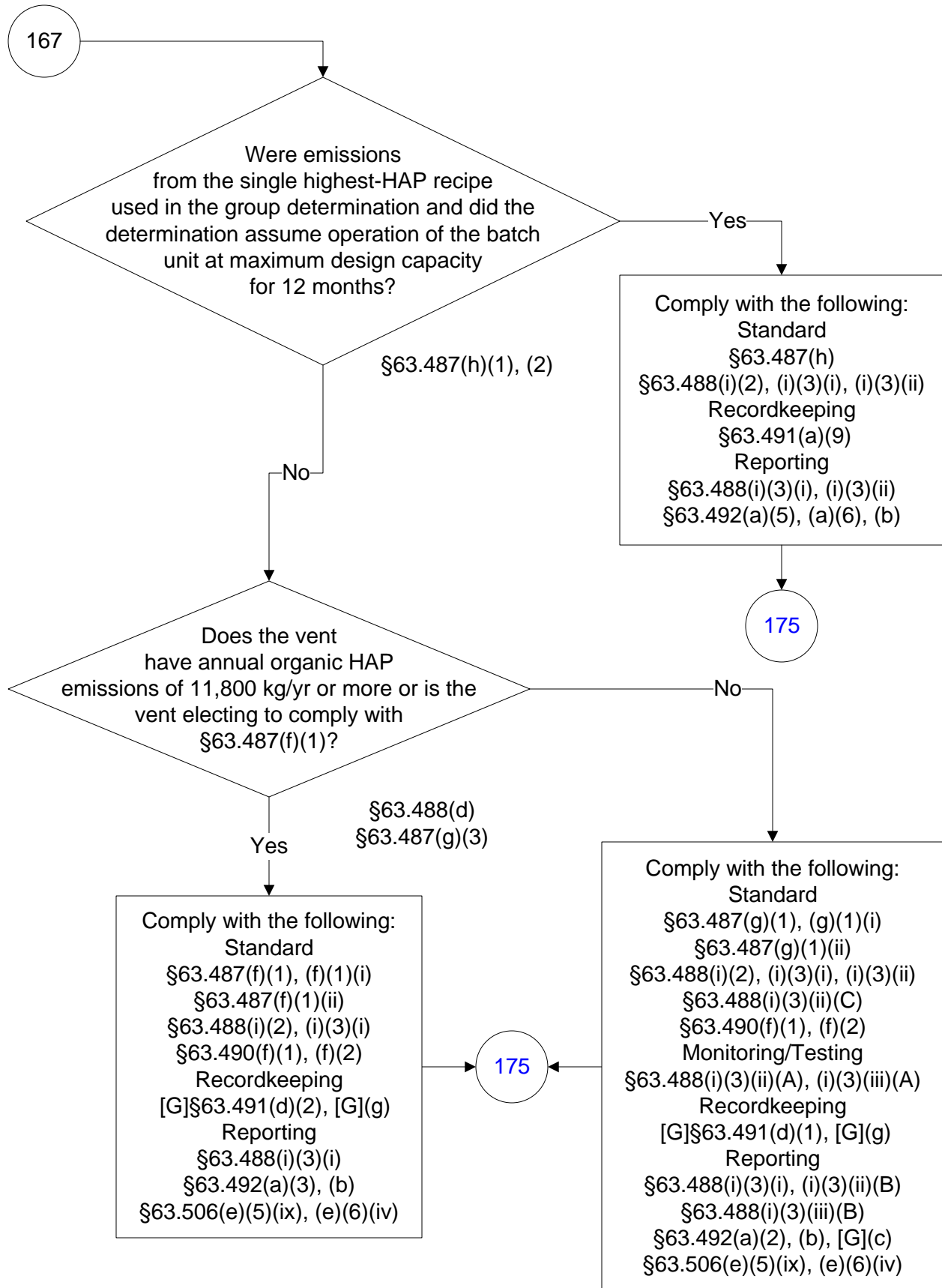

40 CFR Part 63, Subpart U

(78 of 176)

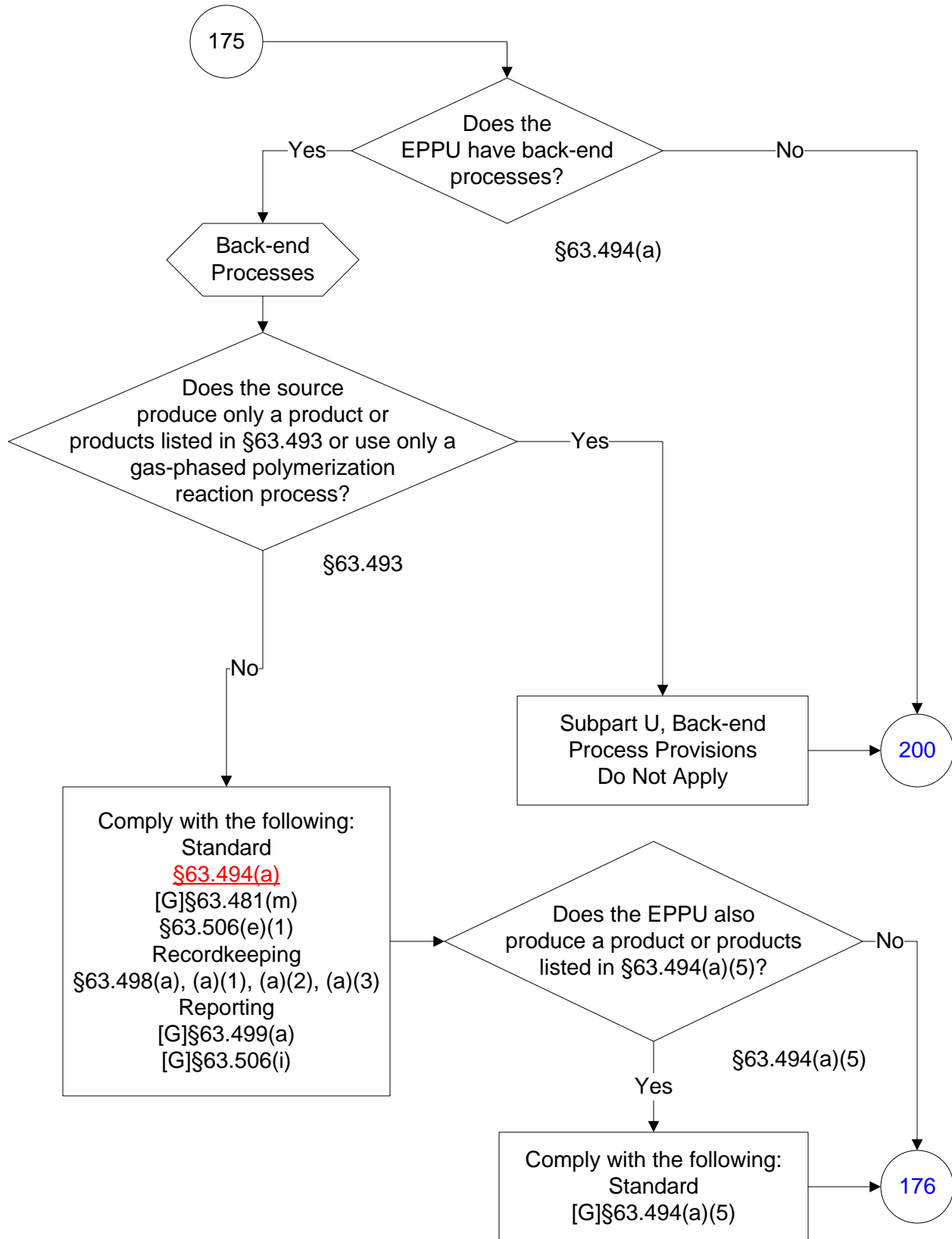

40 CFR Part 63, Subpart U

(79 of 176)

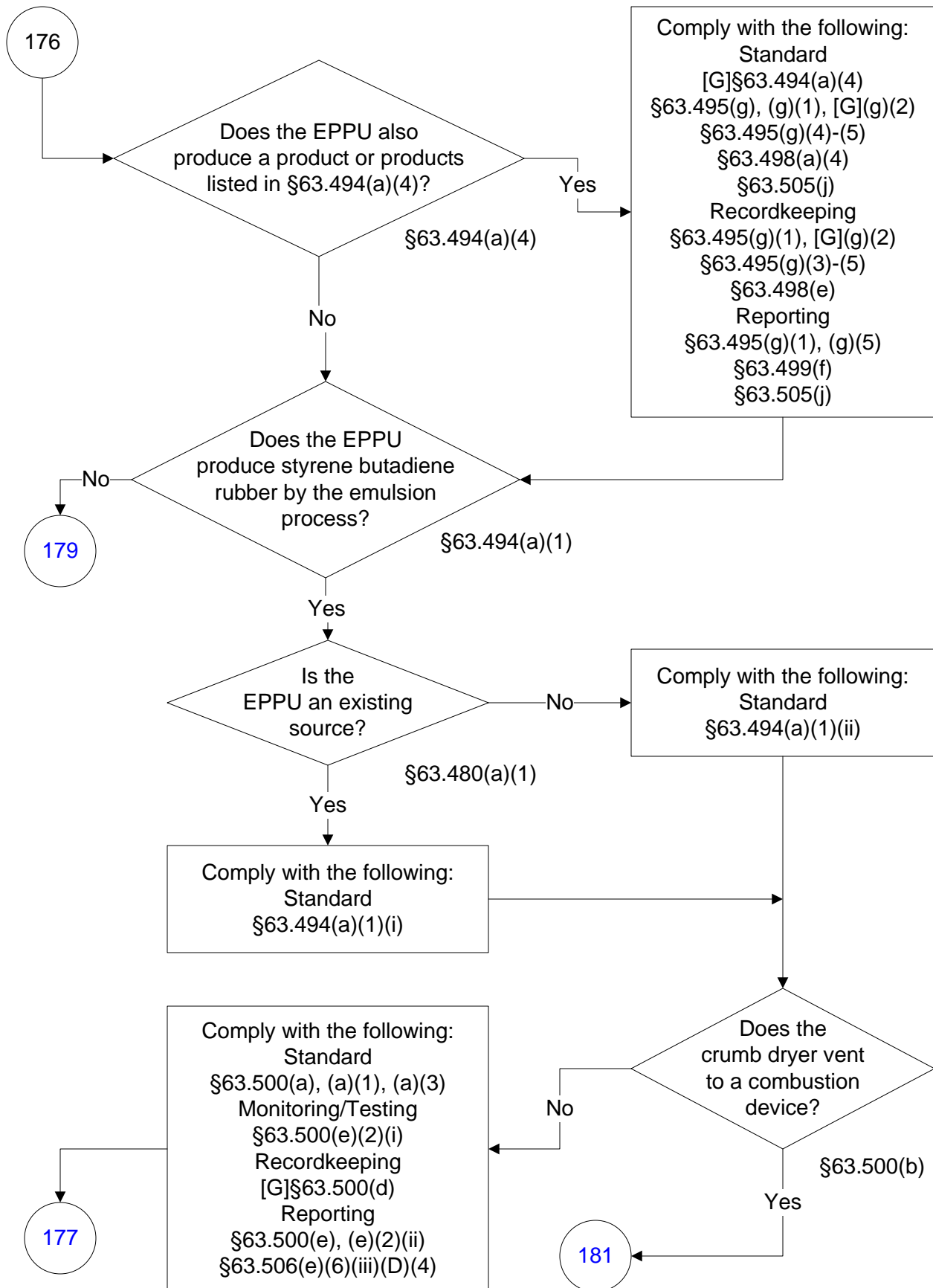

40 CFR Part 63, Subpart U

(80 of 176)

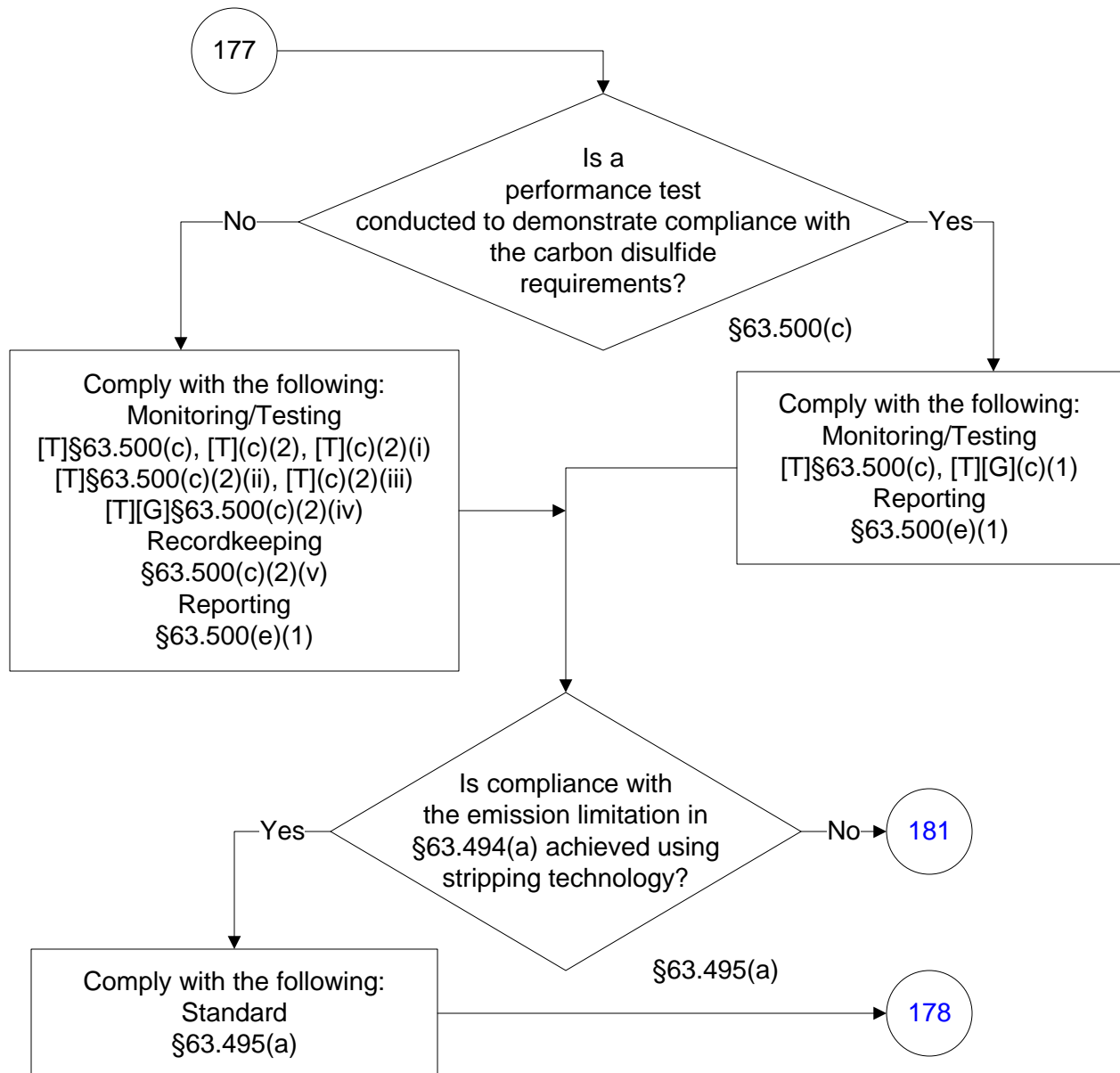

40 CFR Part 63, Subpart U

(81 of 176)

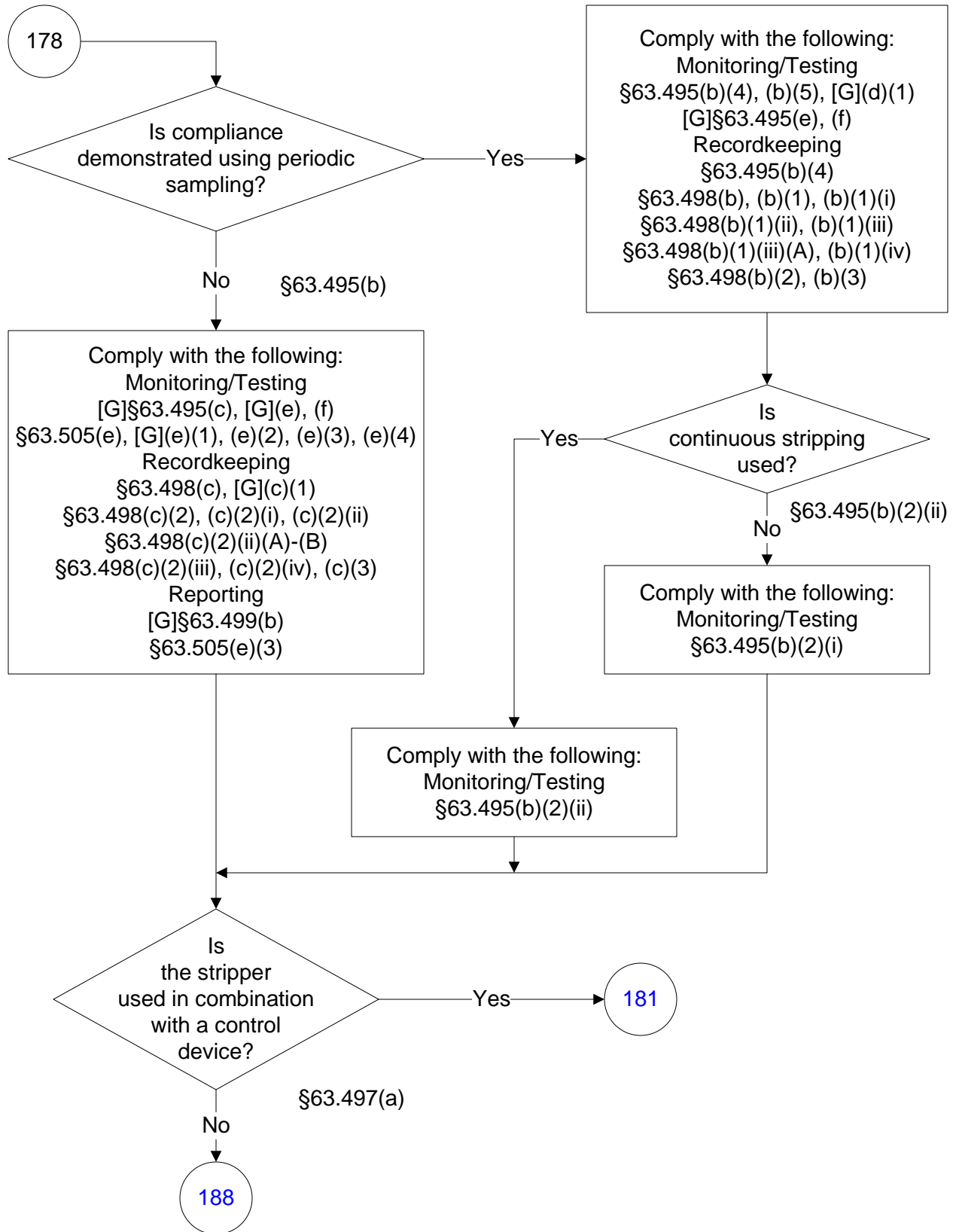

40 CFR Part 63, Subpart U

(82 of 176)

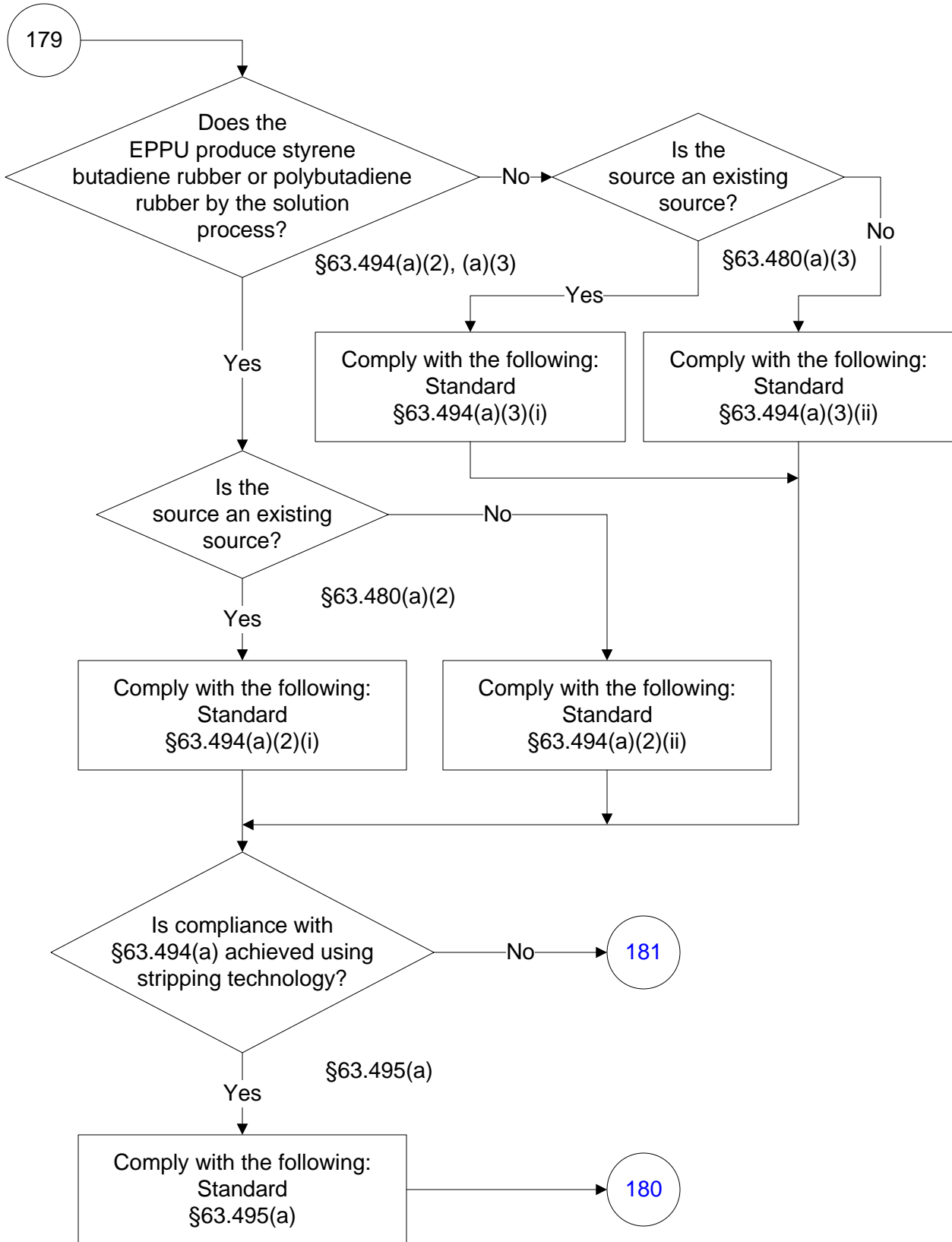

40 CFR Part 63, Subpart U

(83 of 176)

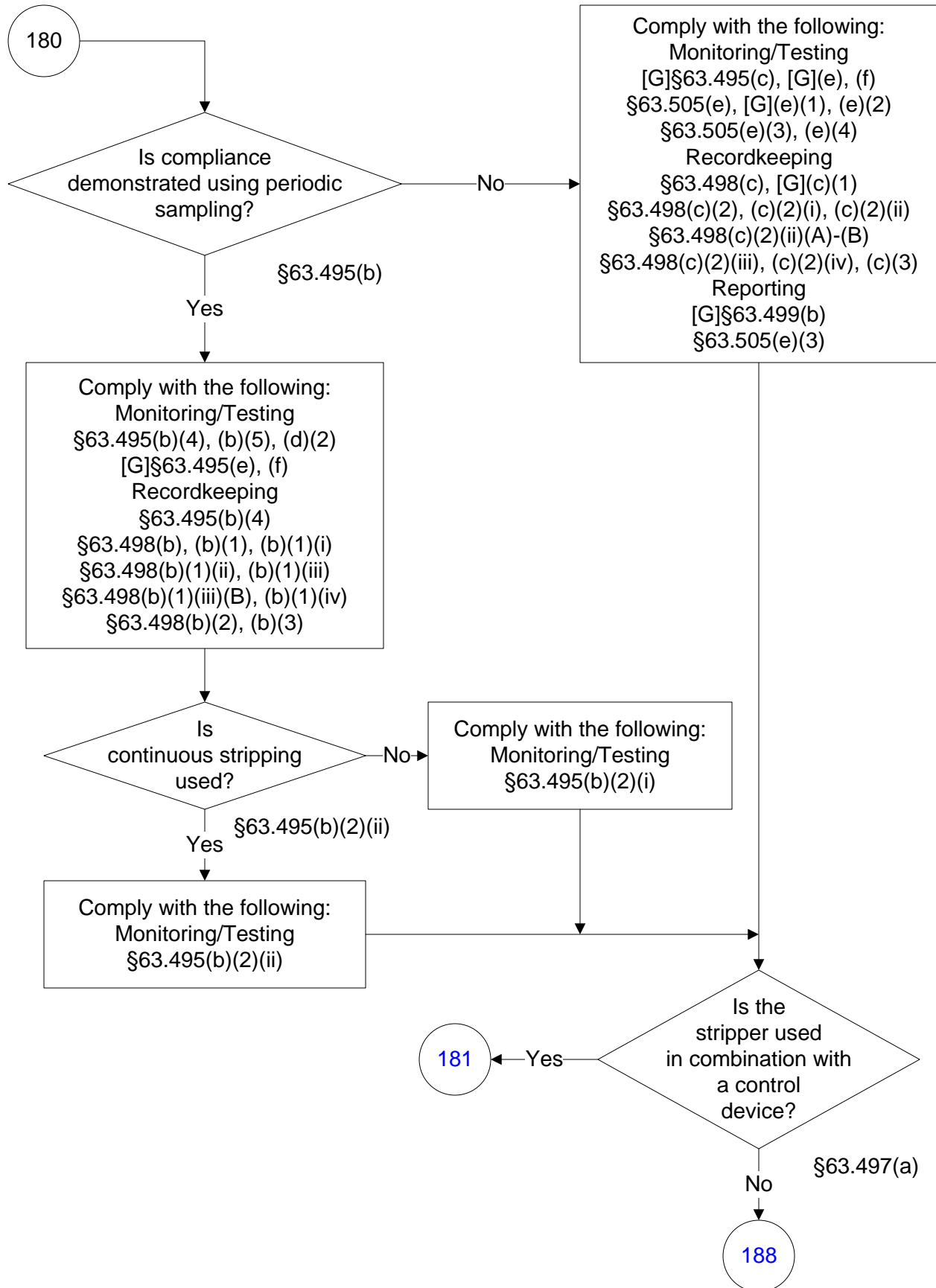

40 CFR Part 63, Subpart U

(84 of 176)

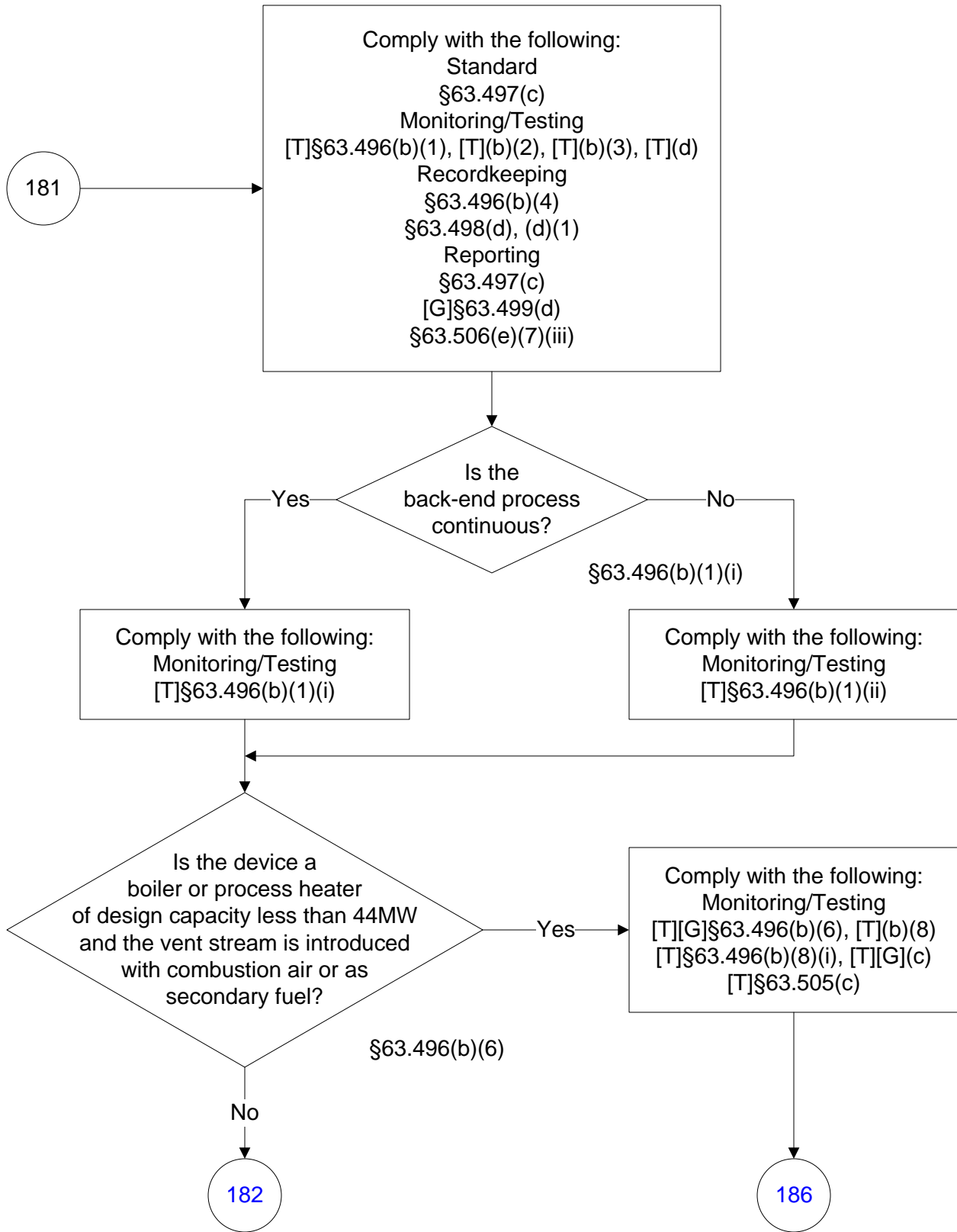

40 CFR Part 63, Subpart U

(85 of 176)

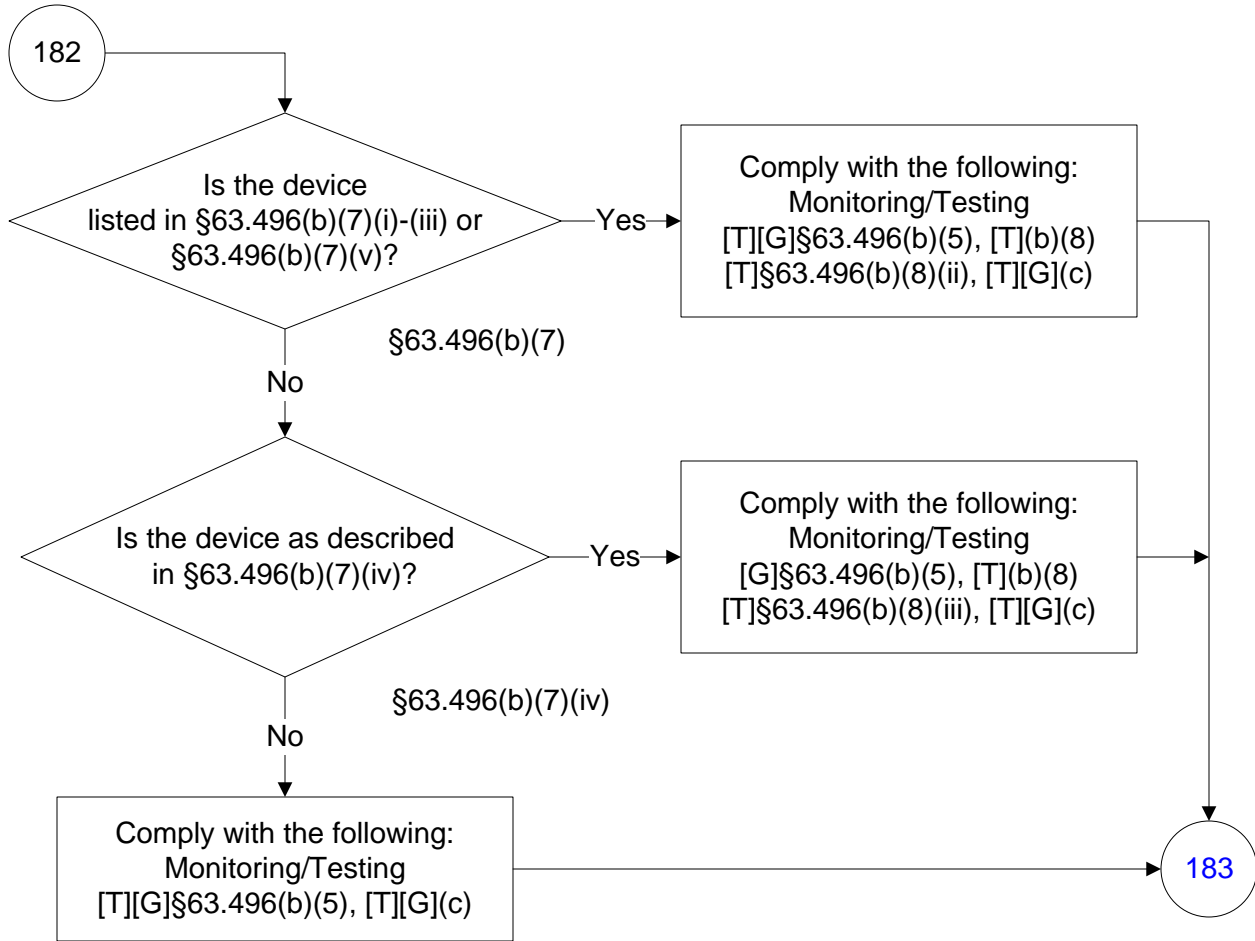

40 CFR Part 63, Subpart U

(86 of 176)

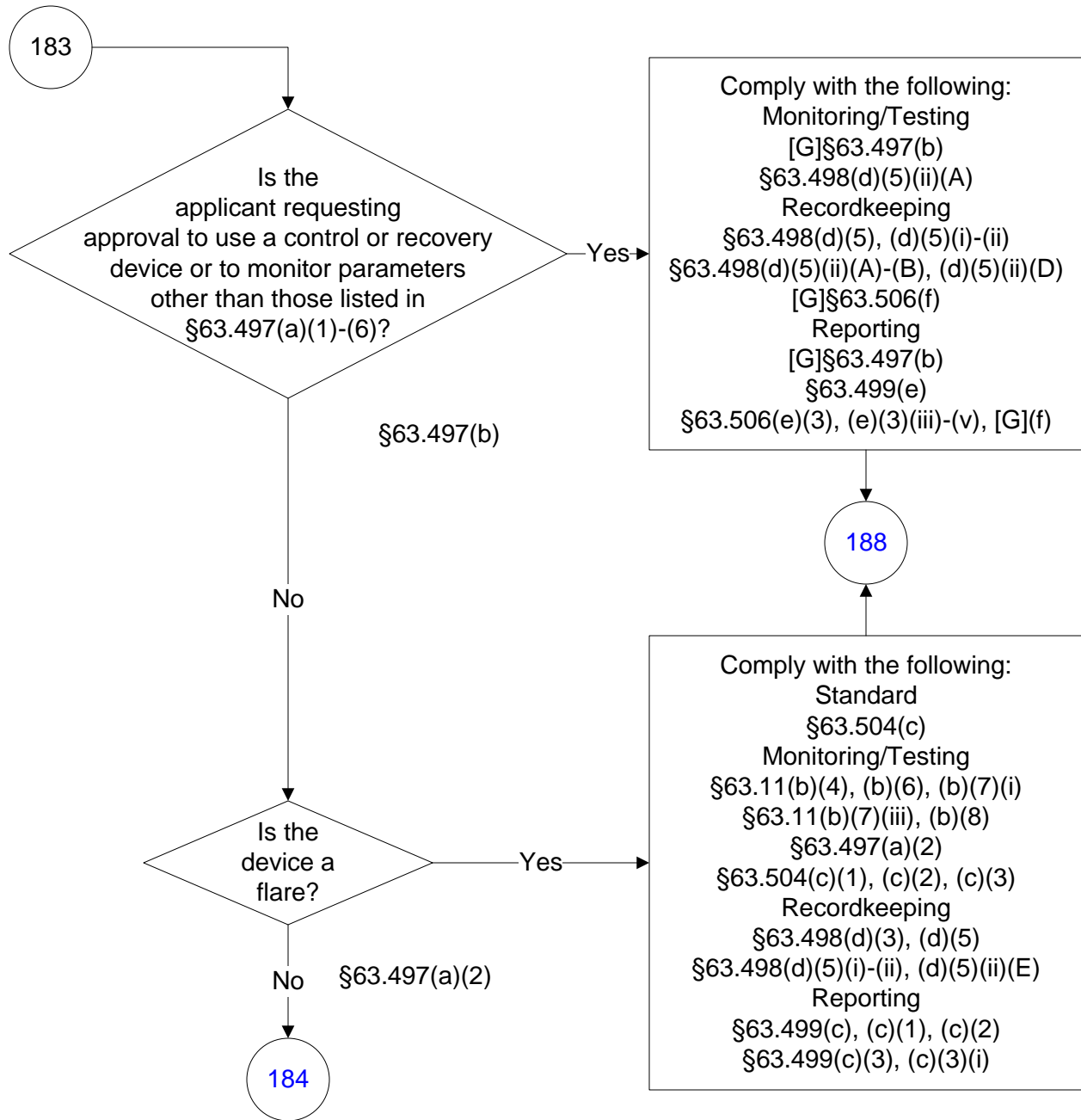

**40 CFR Part 63, Subpart U
(87 of 176)**

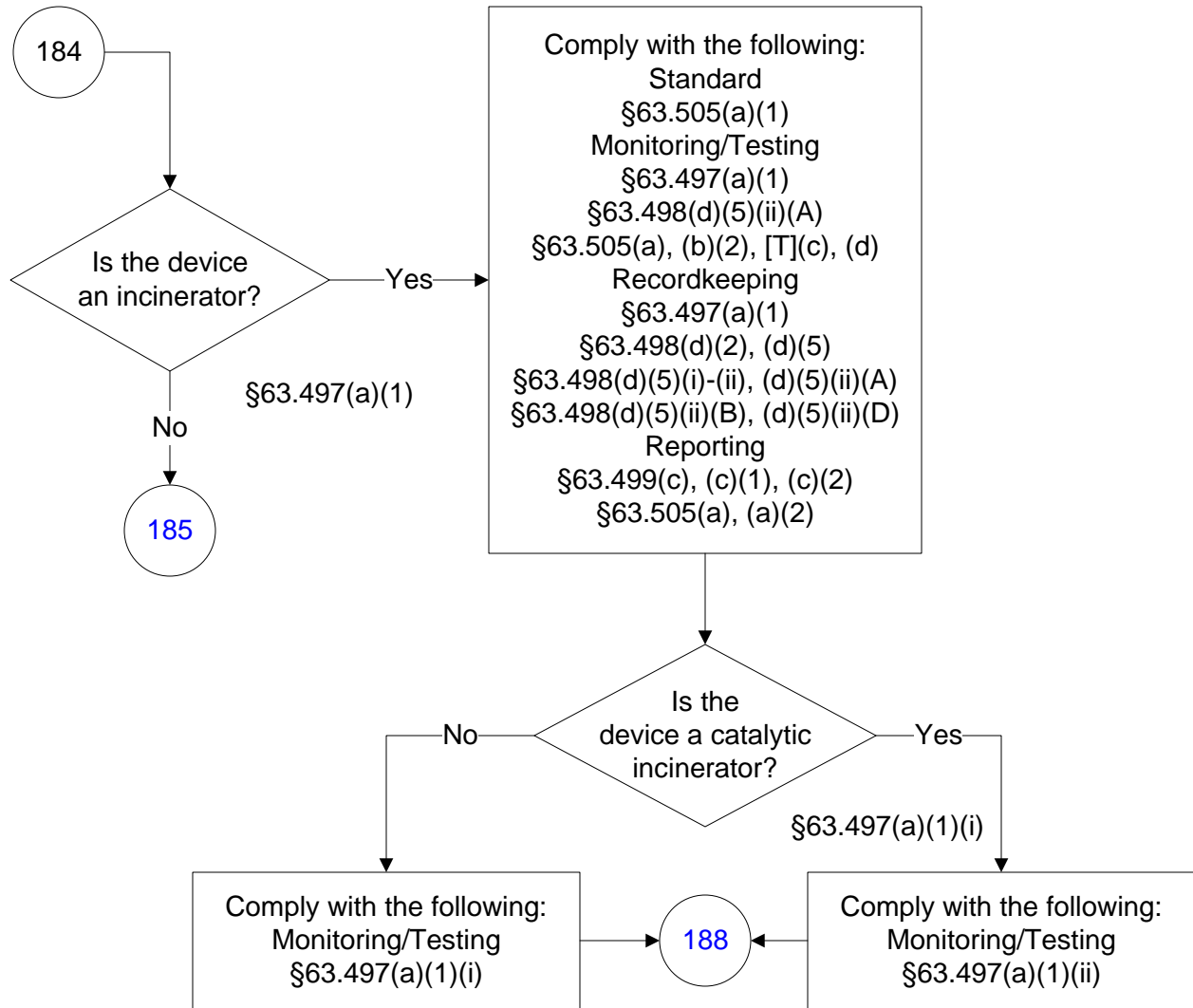

40 CFR Part 63, Subpart U

(88 of 176)

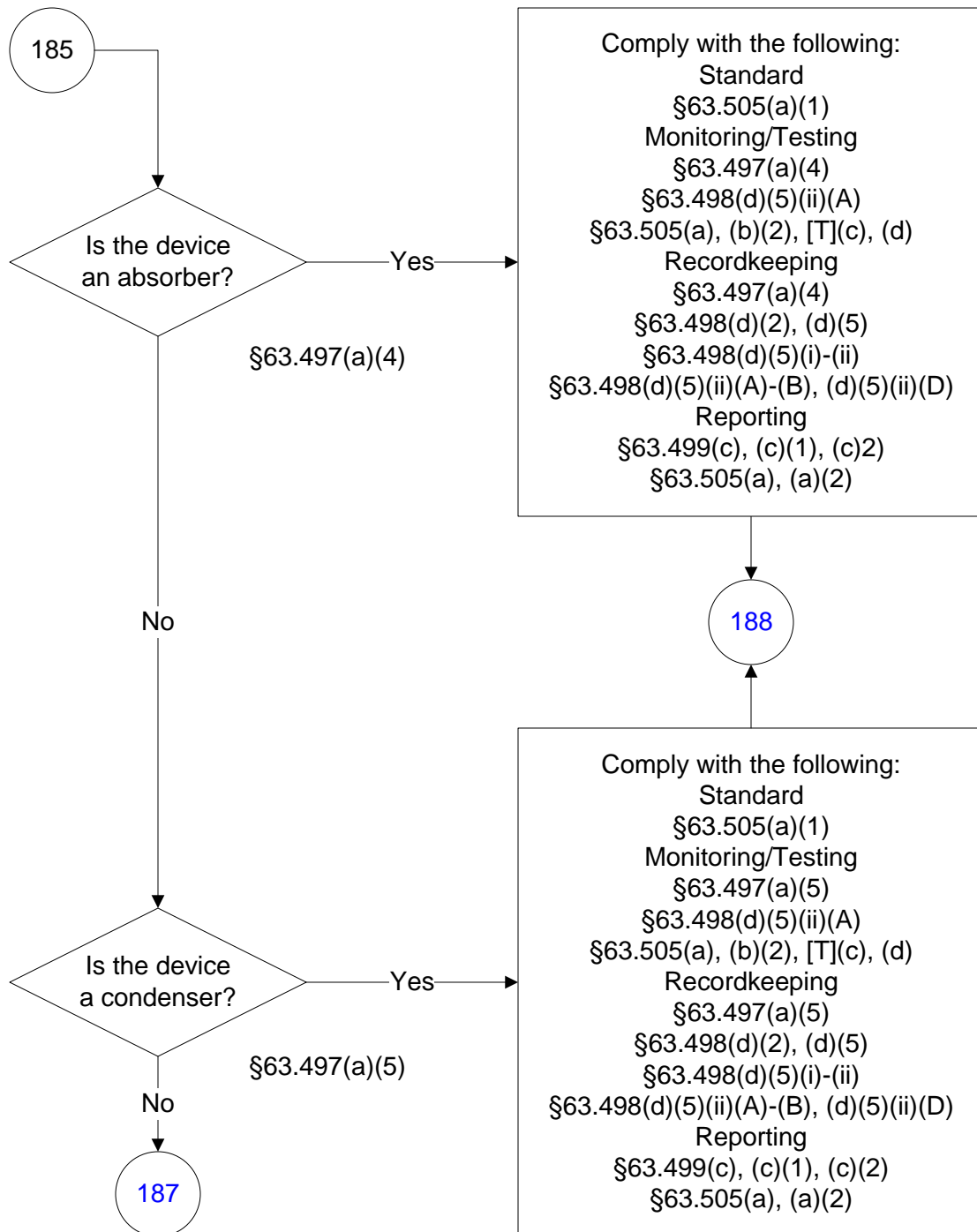

40 CFR Part 63, Subpart U

(89 of 176)

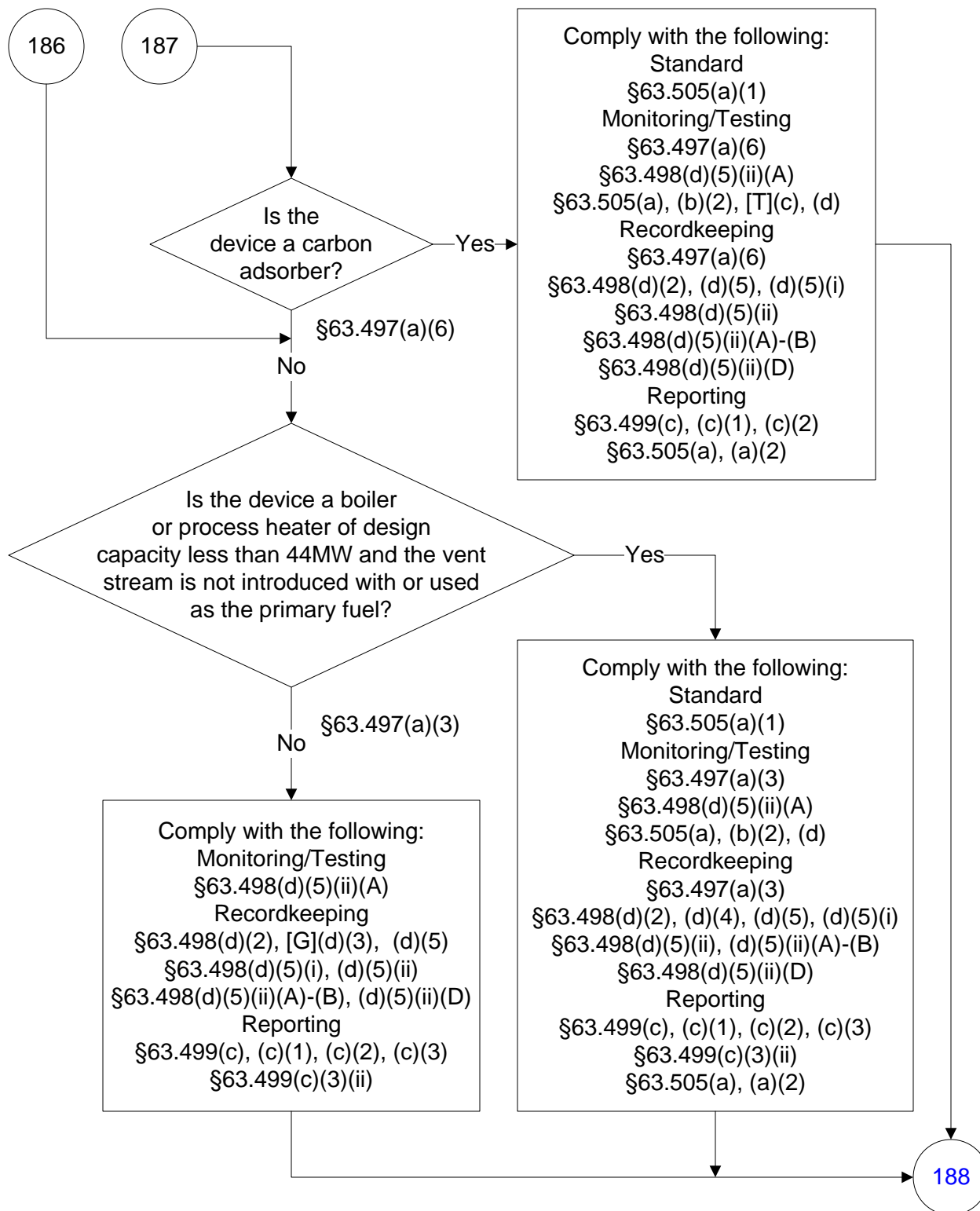

40 CFR Part 63, Subpart U

(90 of 176)

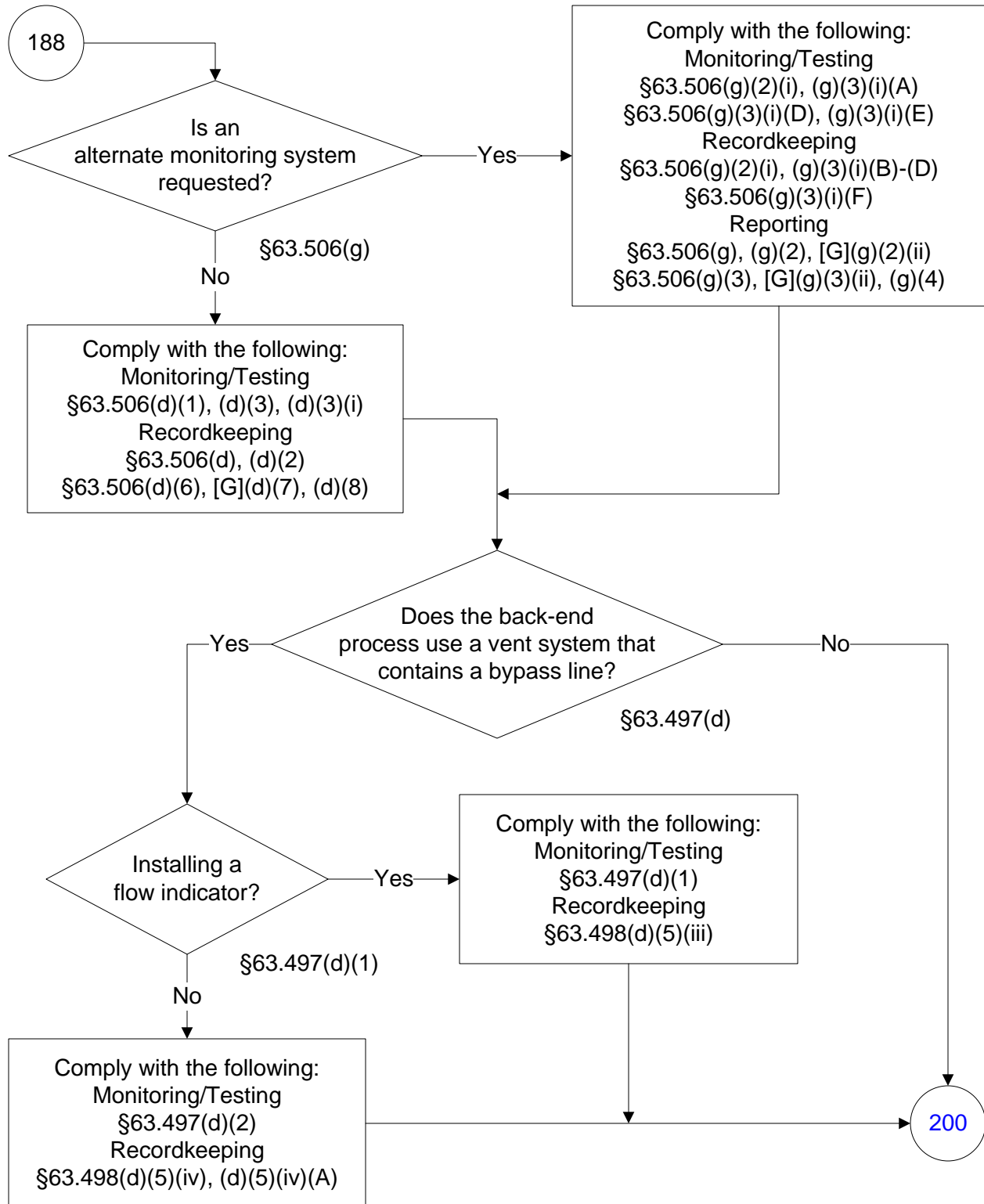

40 CFR Part 63, Subpart U

(91 of 176)

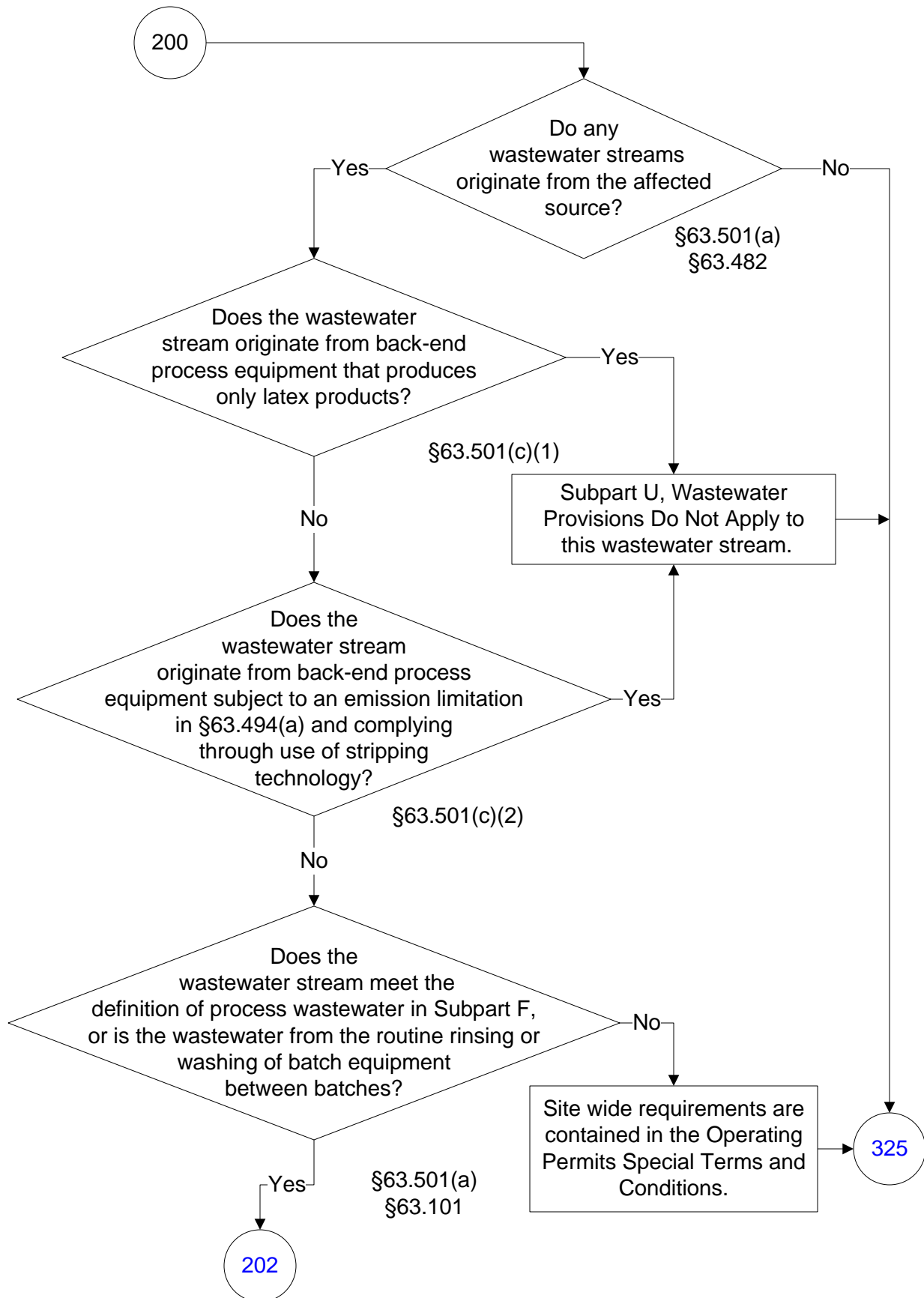

40 CFR Part 63, Subpart U

(92 of 176)

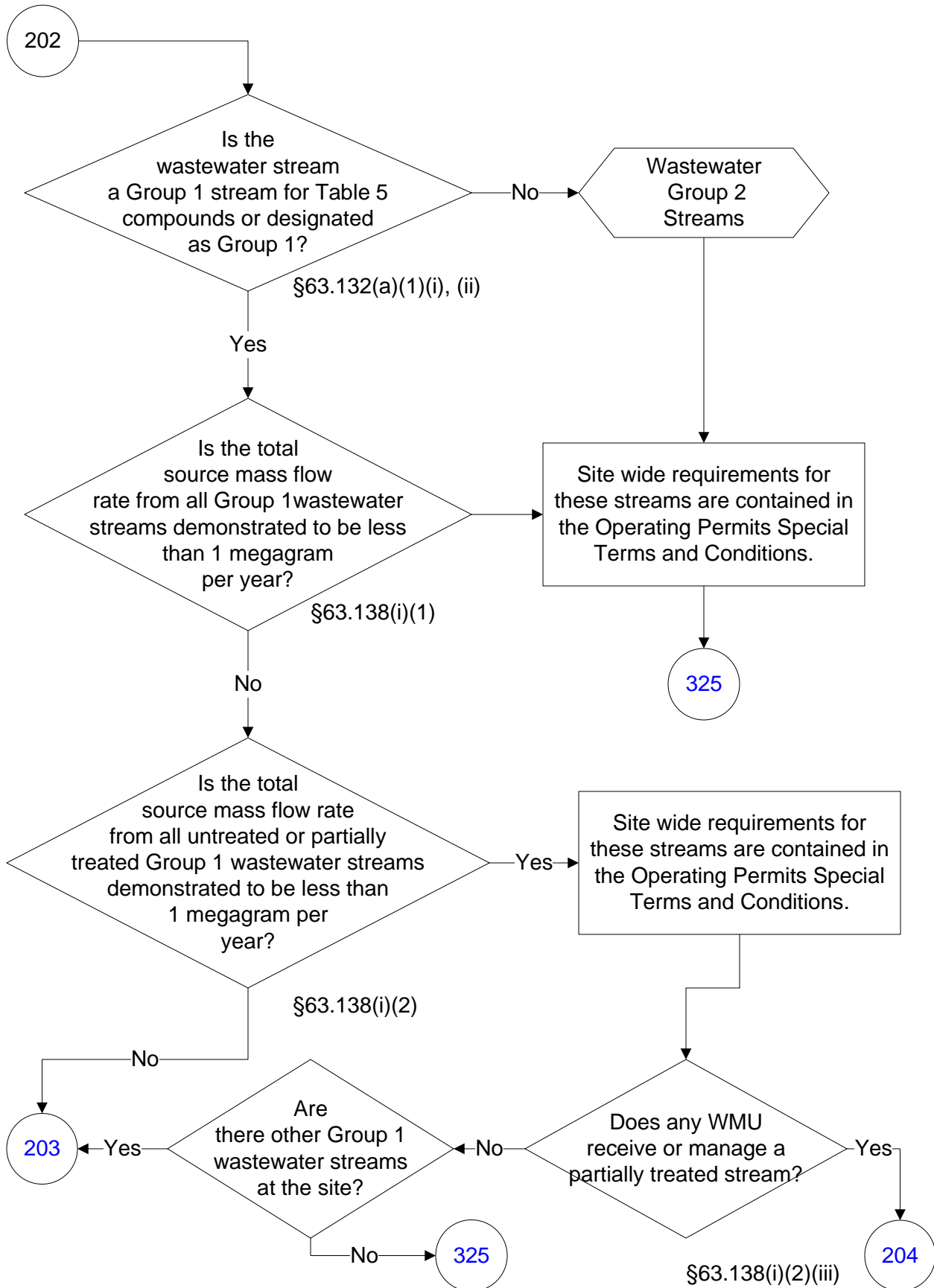

40 CFR Part 63, Subpart U

(93 of 176)

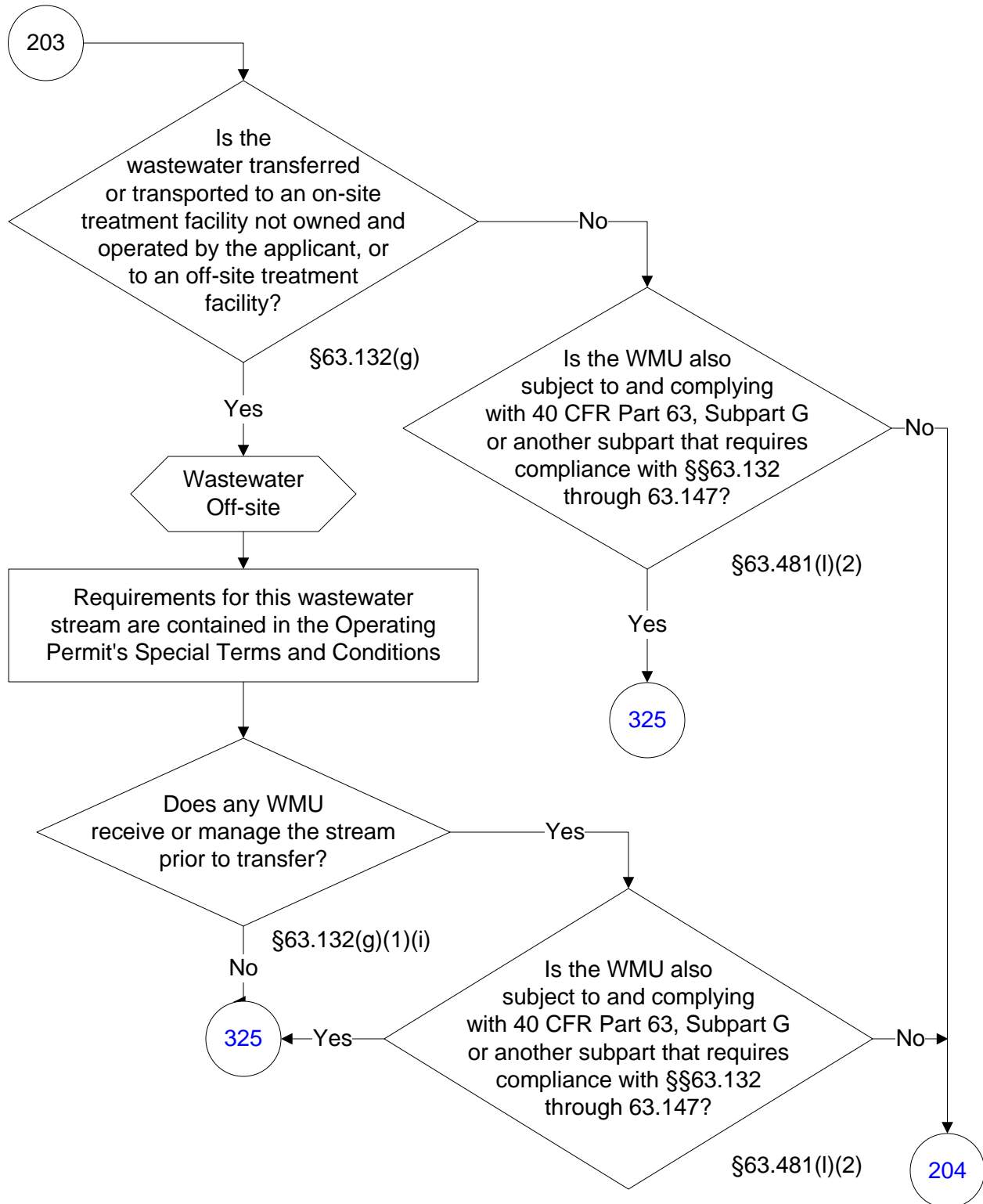

40 CFR Part 63, Subpart U

(94 of 176)

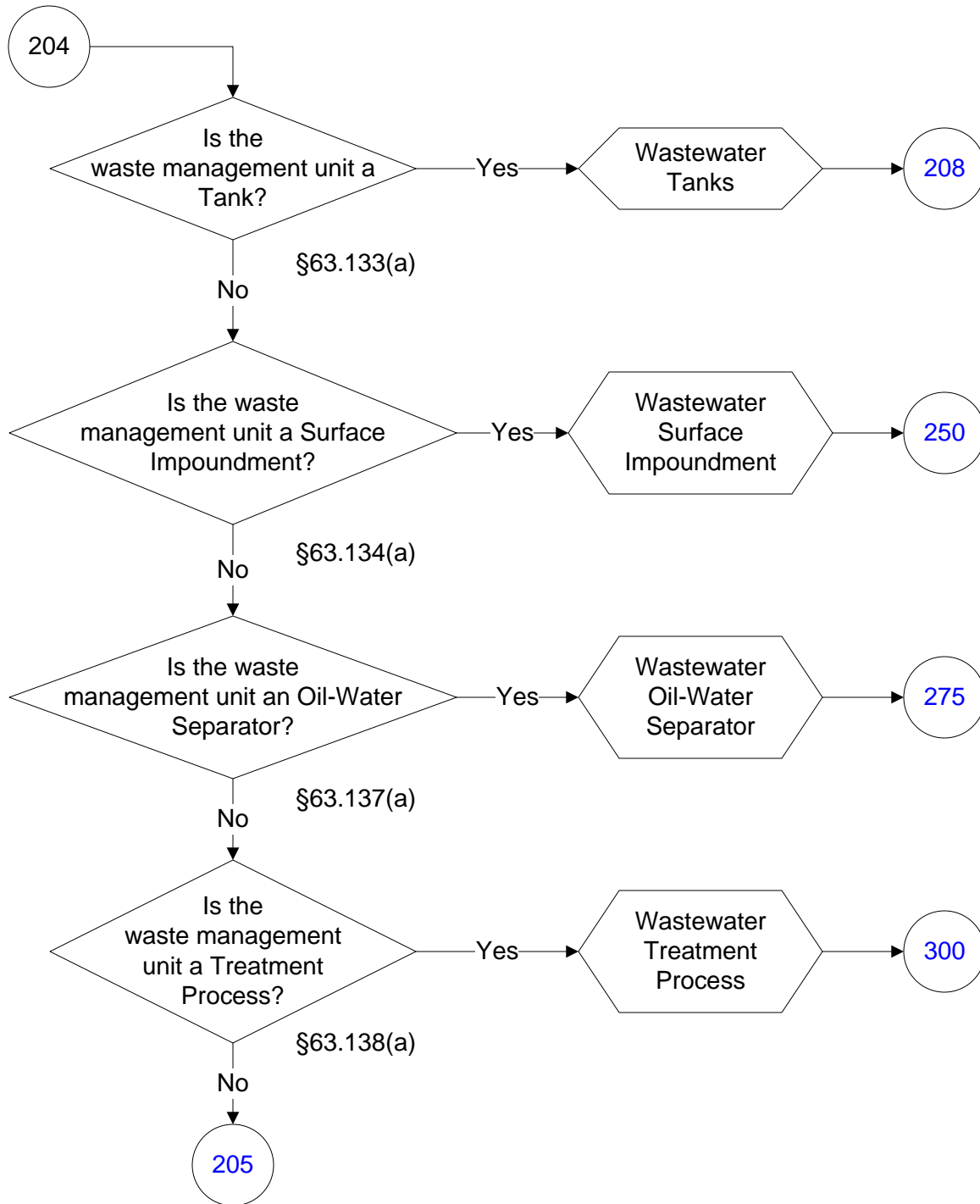

40 CFR Part 63, Subpart U

(95 of 176)

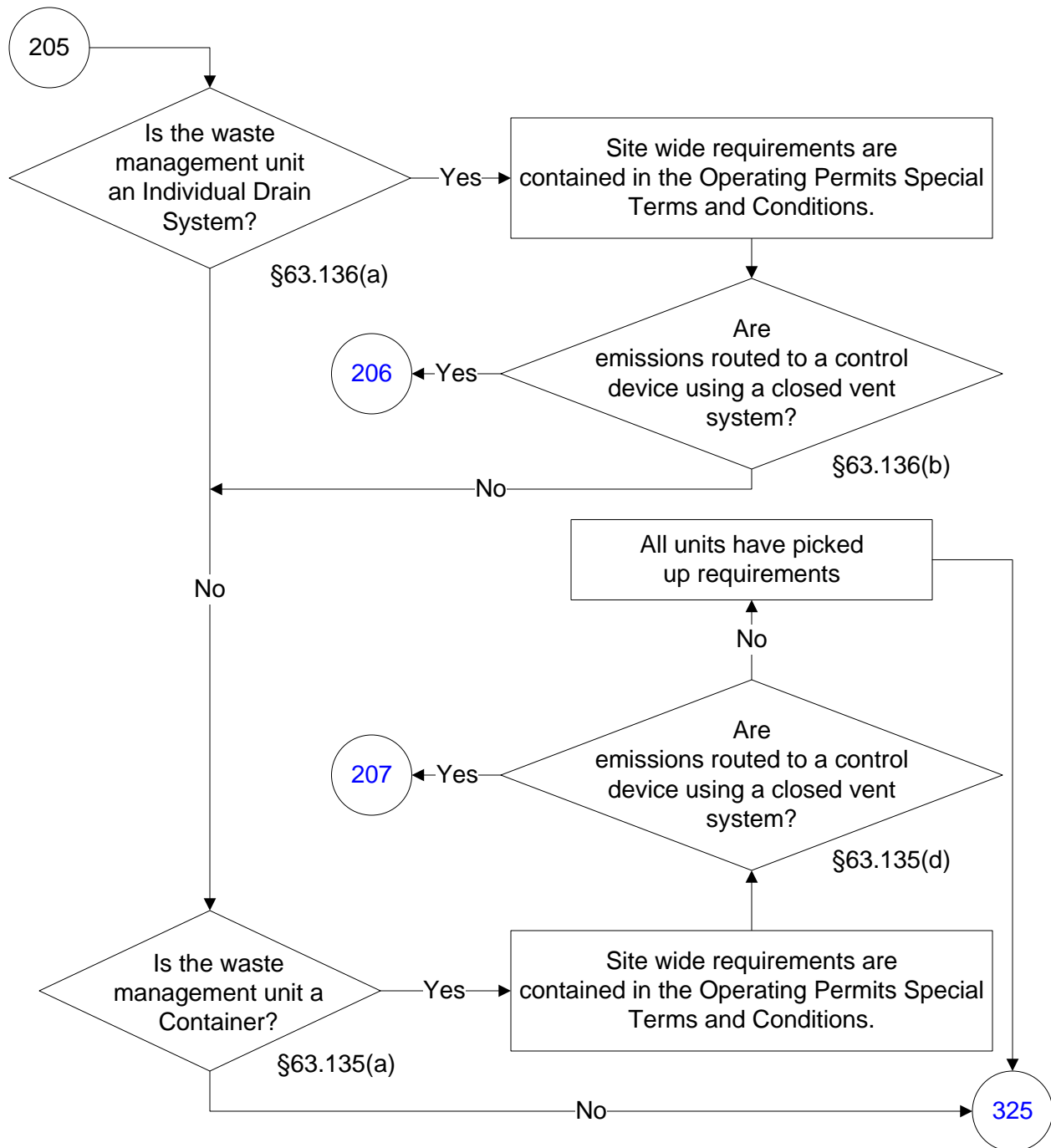

40 CFR Part 63, Subpart U

(96 of 176)

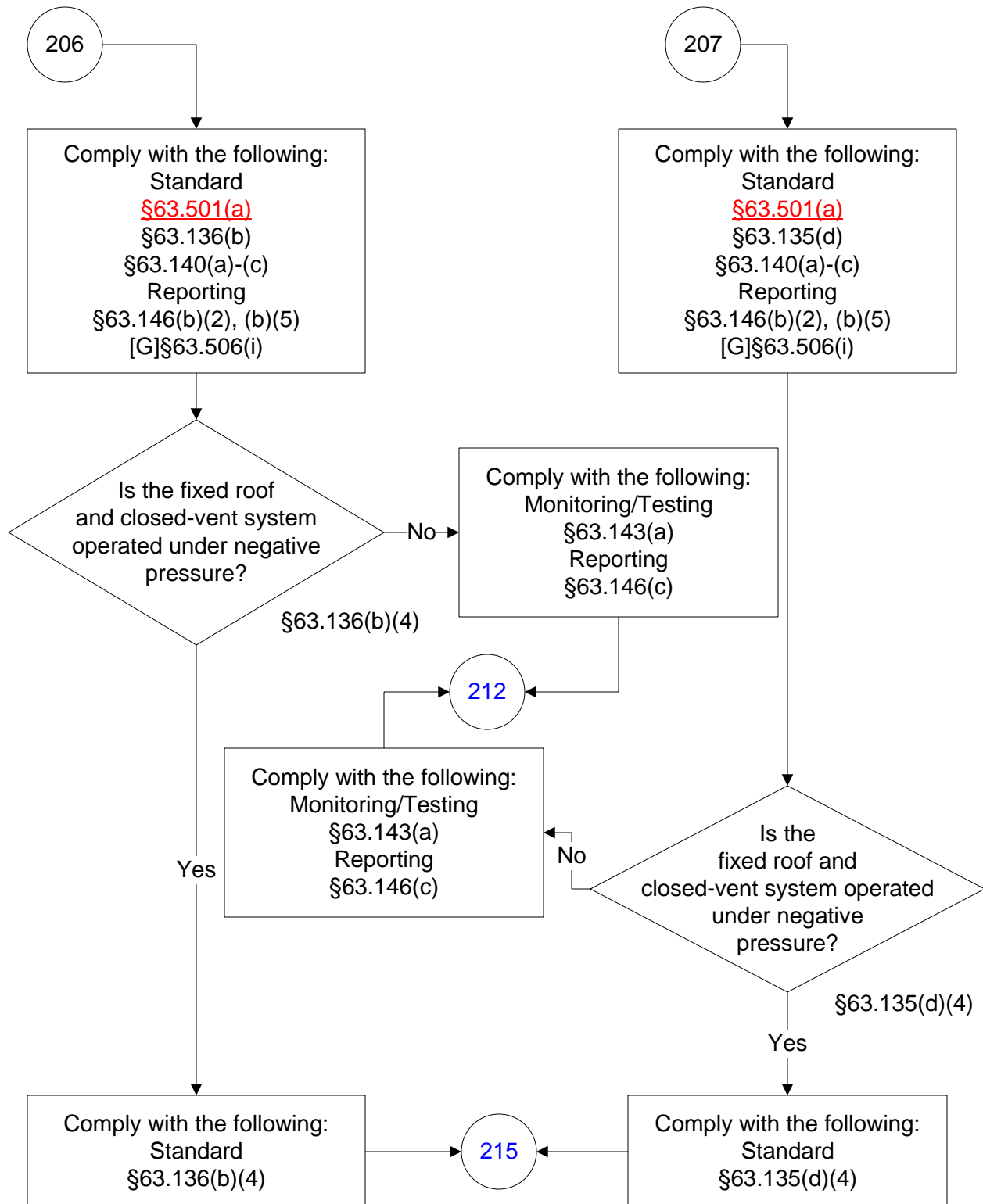

40 CFR Part 63, Subpart U

(97 of 176)

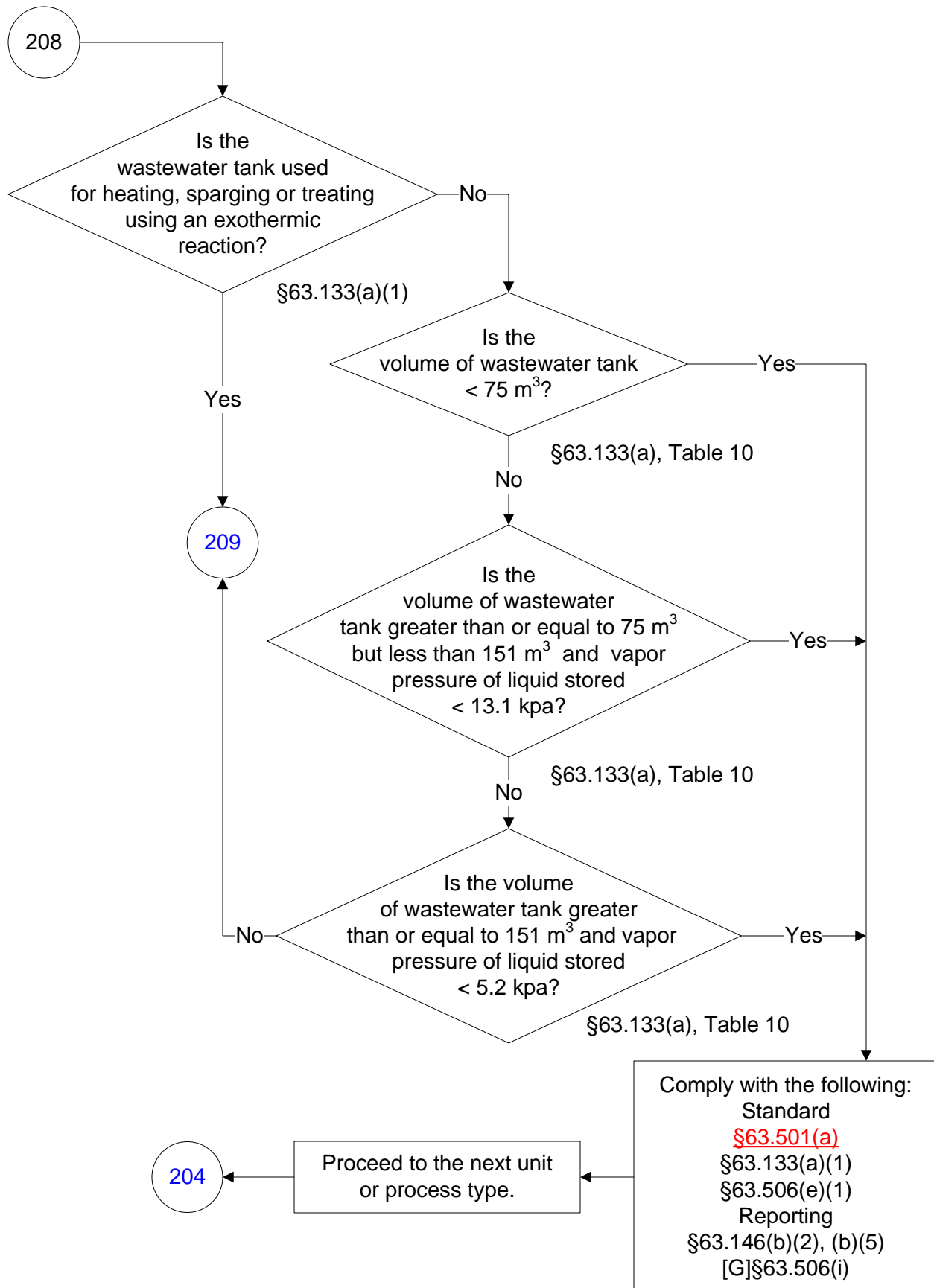

40 CFR Part 63, Subpart U

(98 of 176)

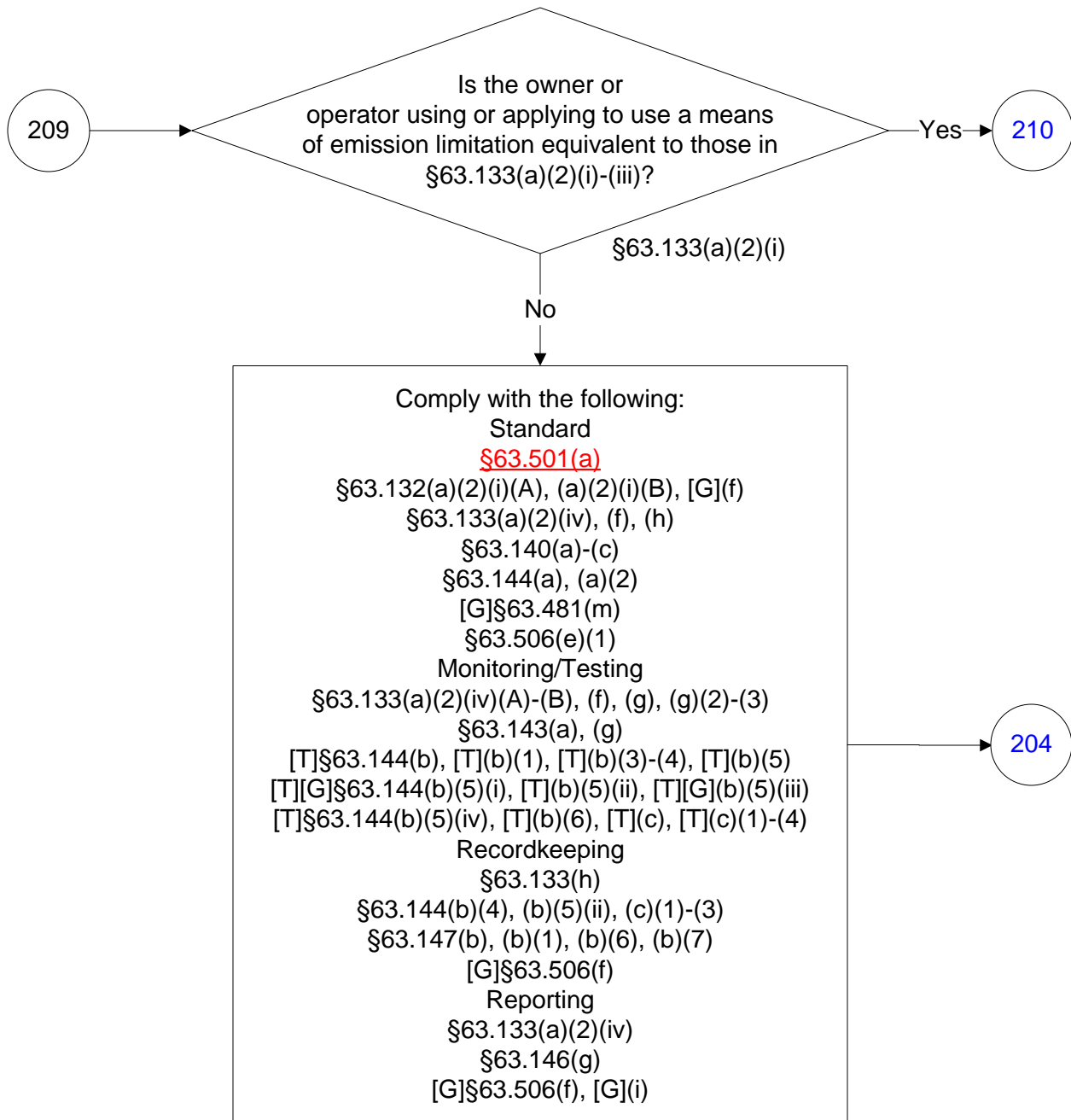

40 CFR Part 63, Subpart U

(99 of 176)

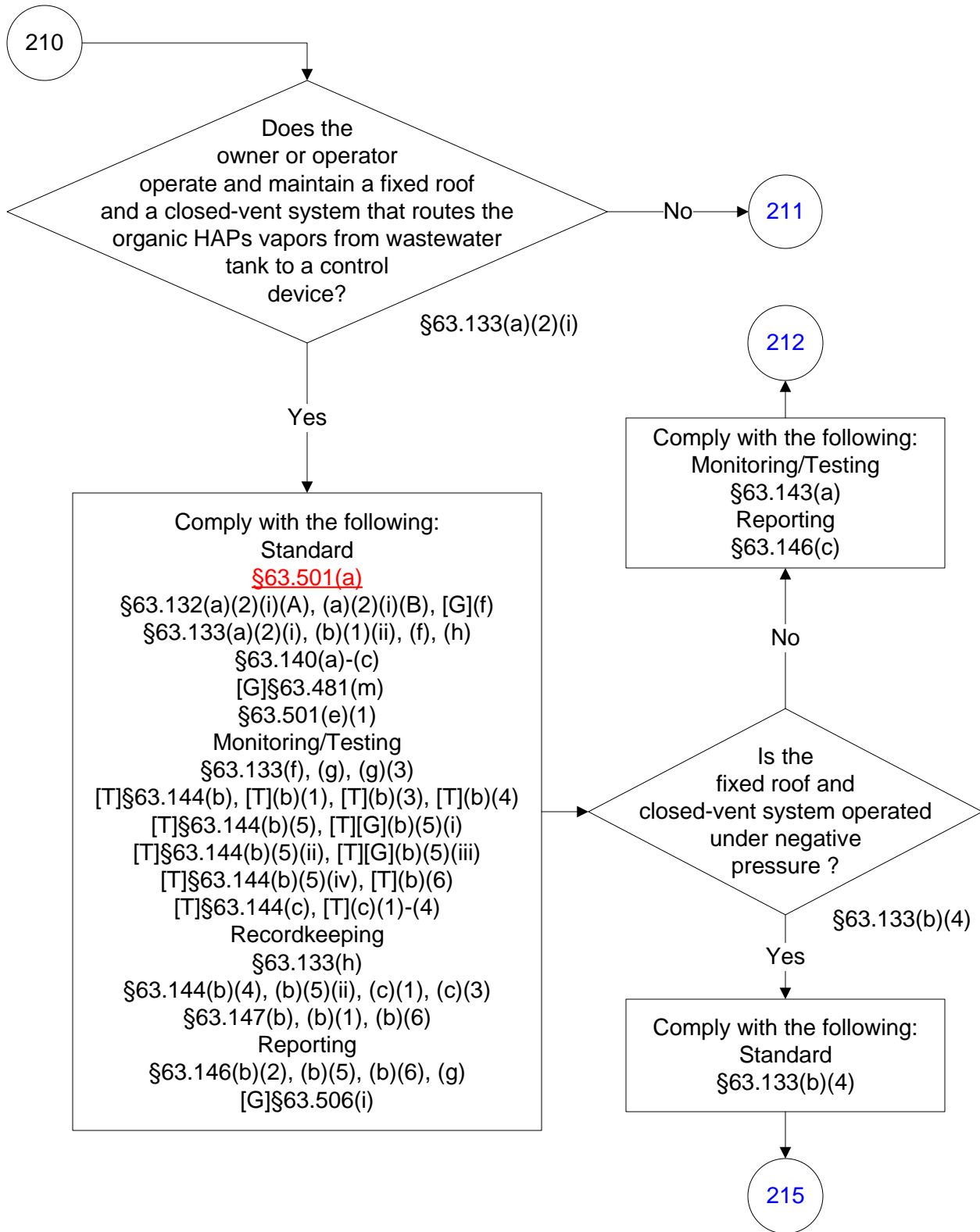

40 CFR Part 63, Subpart U

(100 of 176)

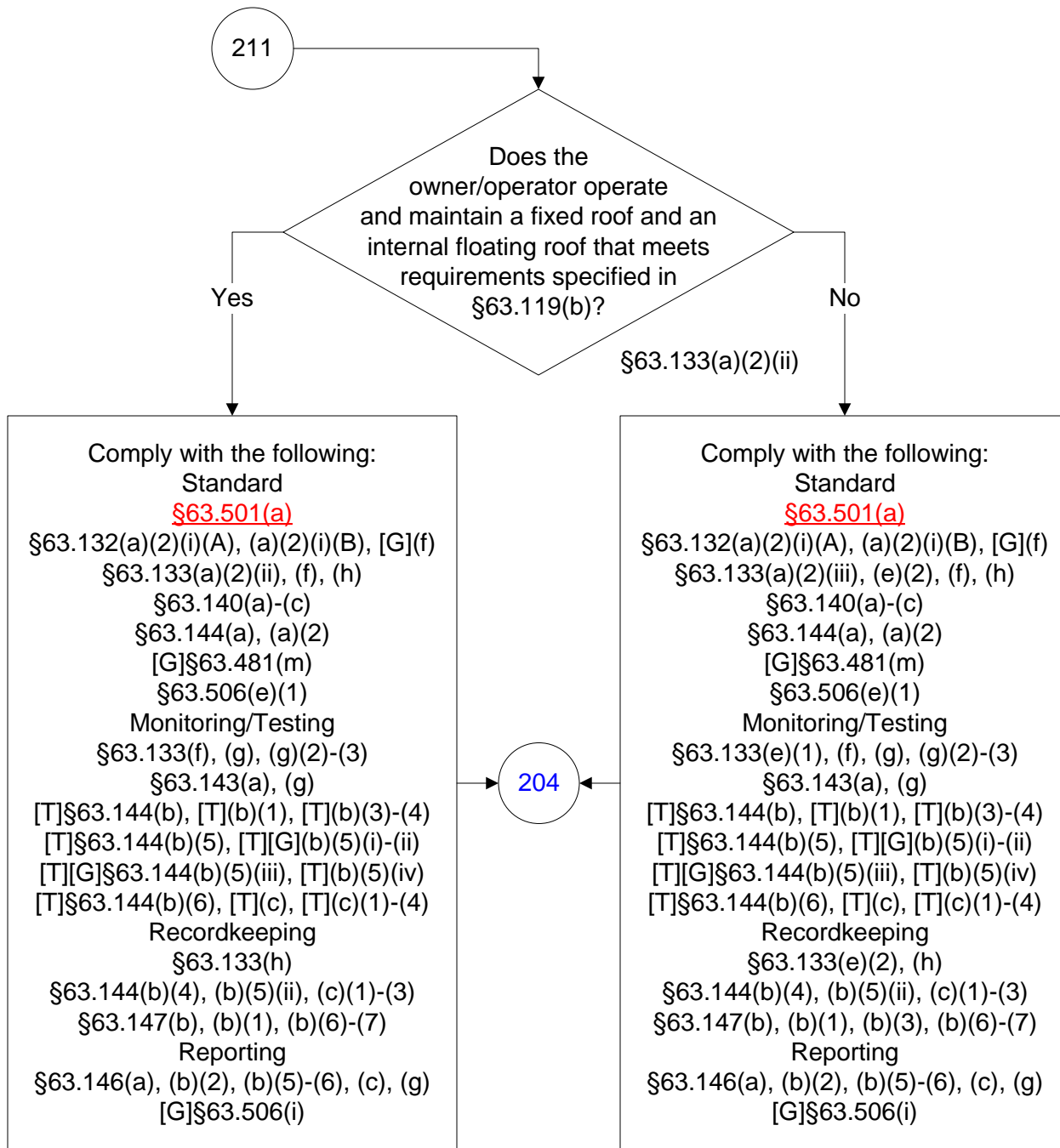

40 CFR Part 63, Subpart U
(101 of 176)

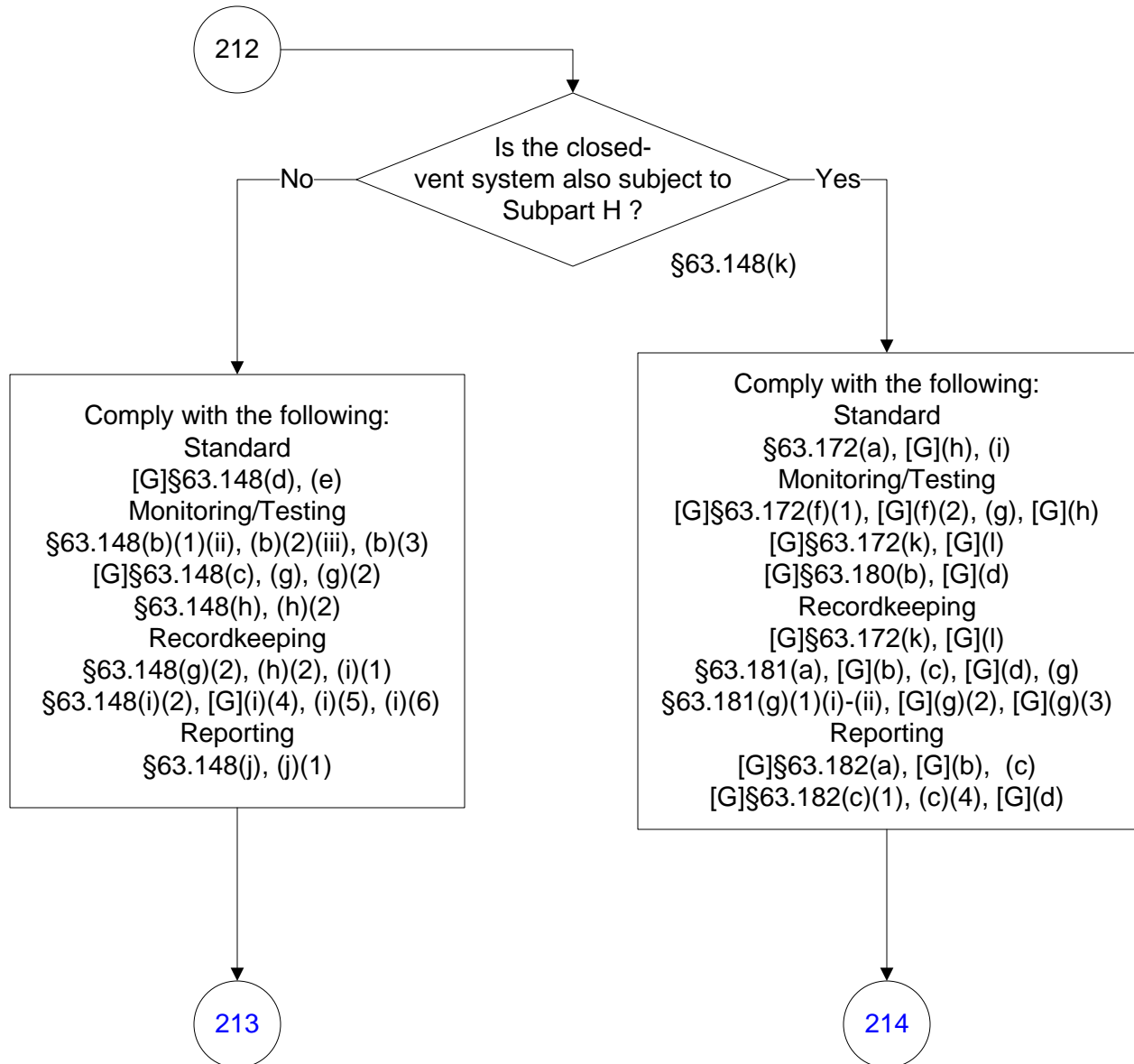

40 CFR Part 63, Subpart U

(102 of 176)

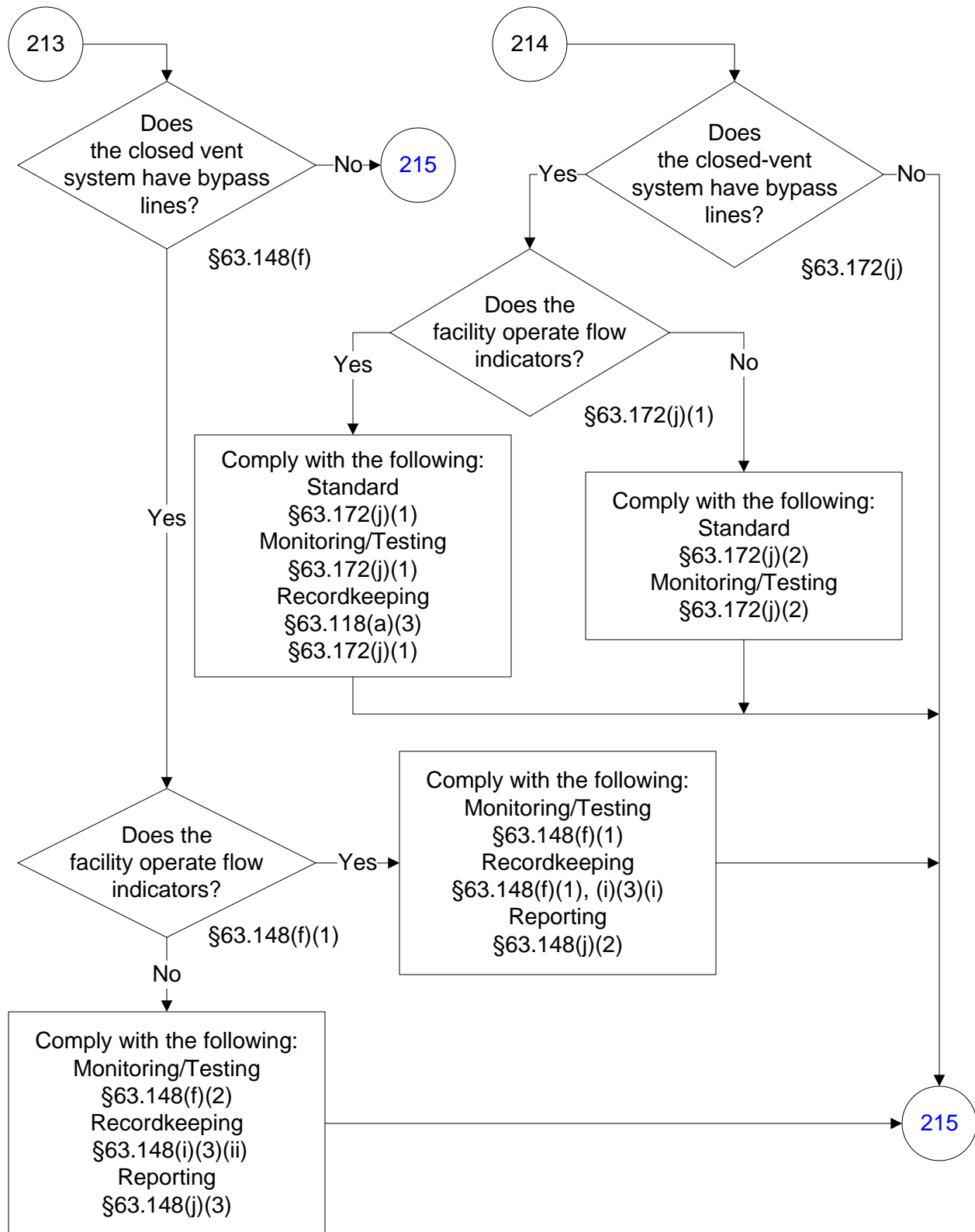

40 CFR Part 63, Subpart U

(103 of 176)

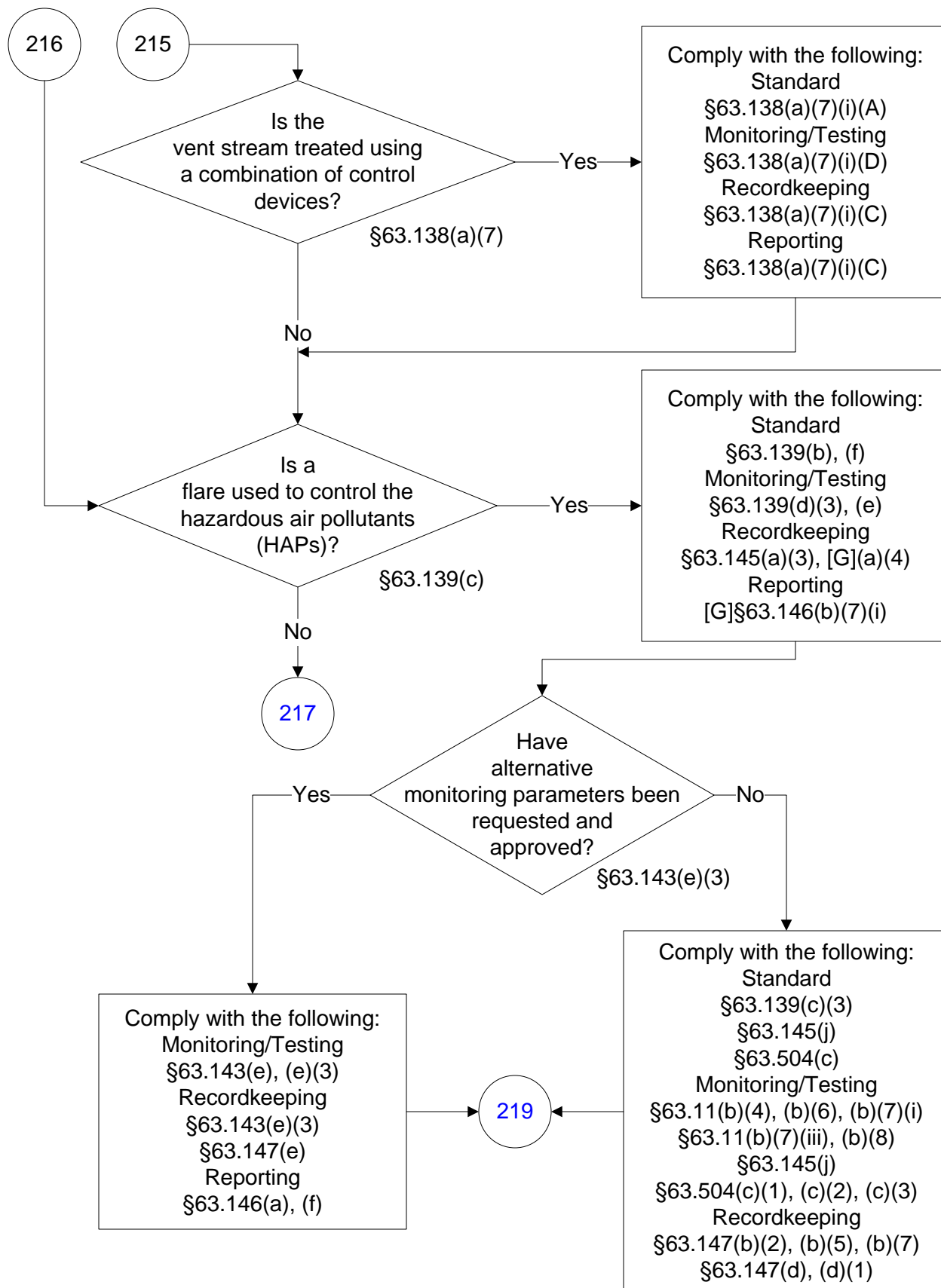

40 CFR Part 63, Subpart U

(104 of 176)

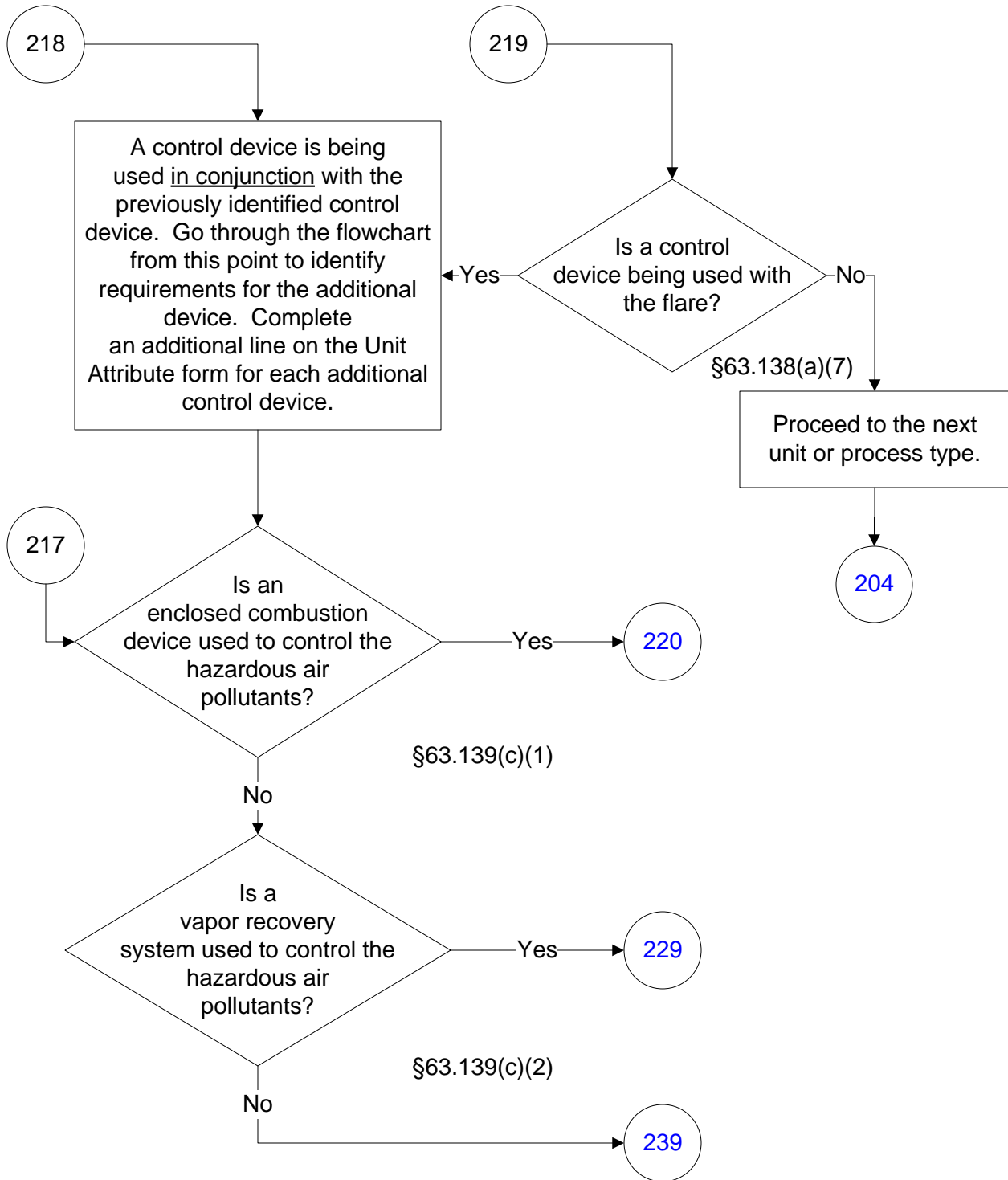

40 CFR Part 63, Subpart U

(105 of 176)

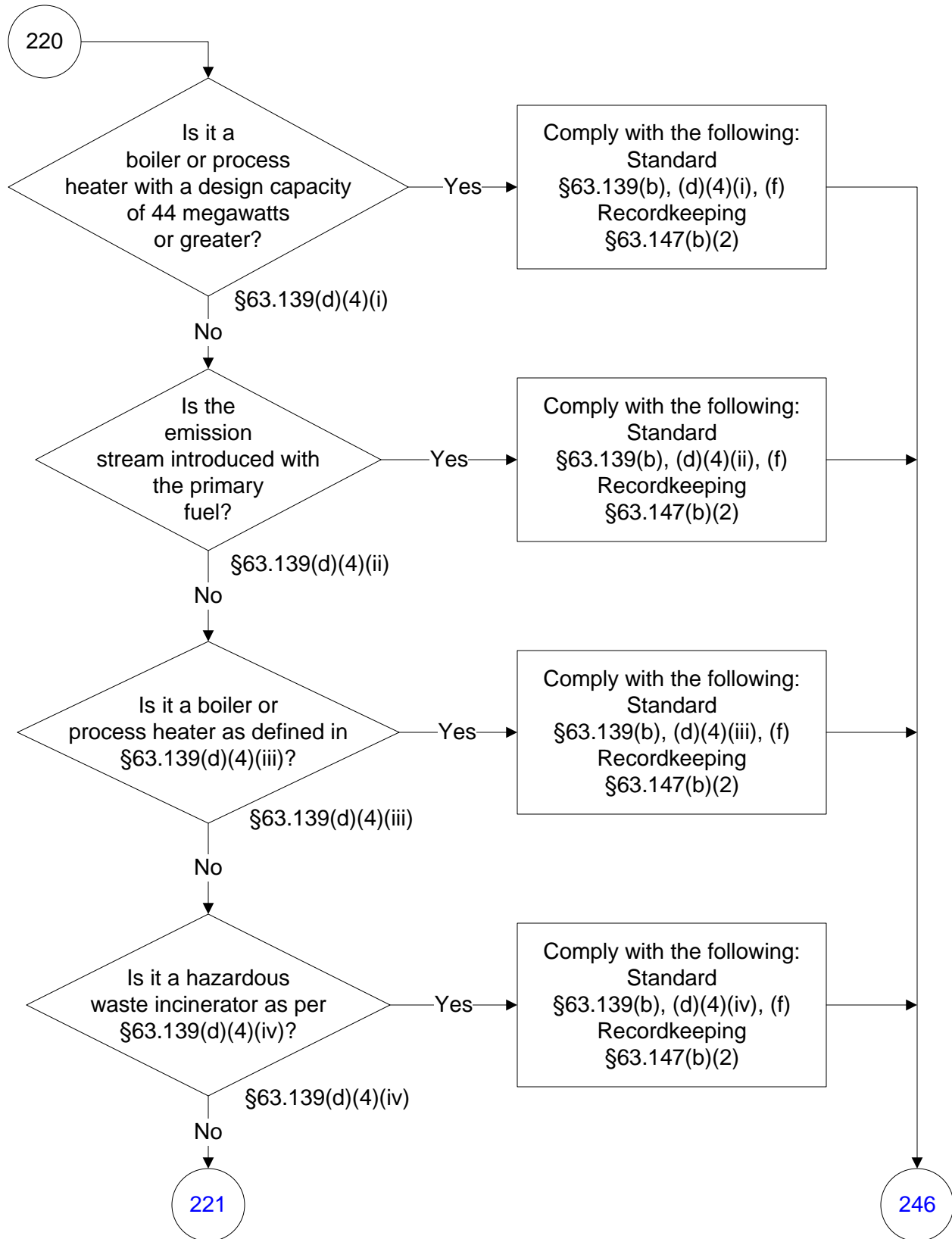

40 CFR Part 63, Subpart U

(106 of 176)

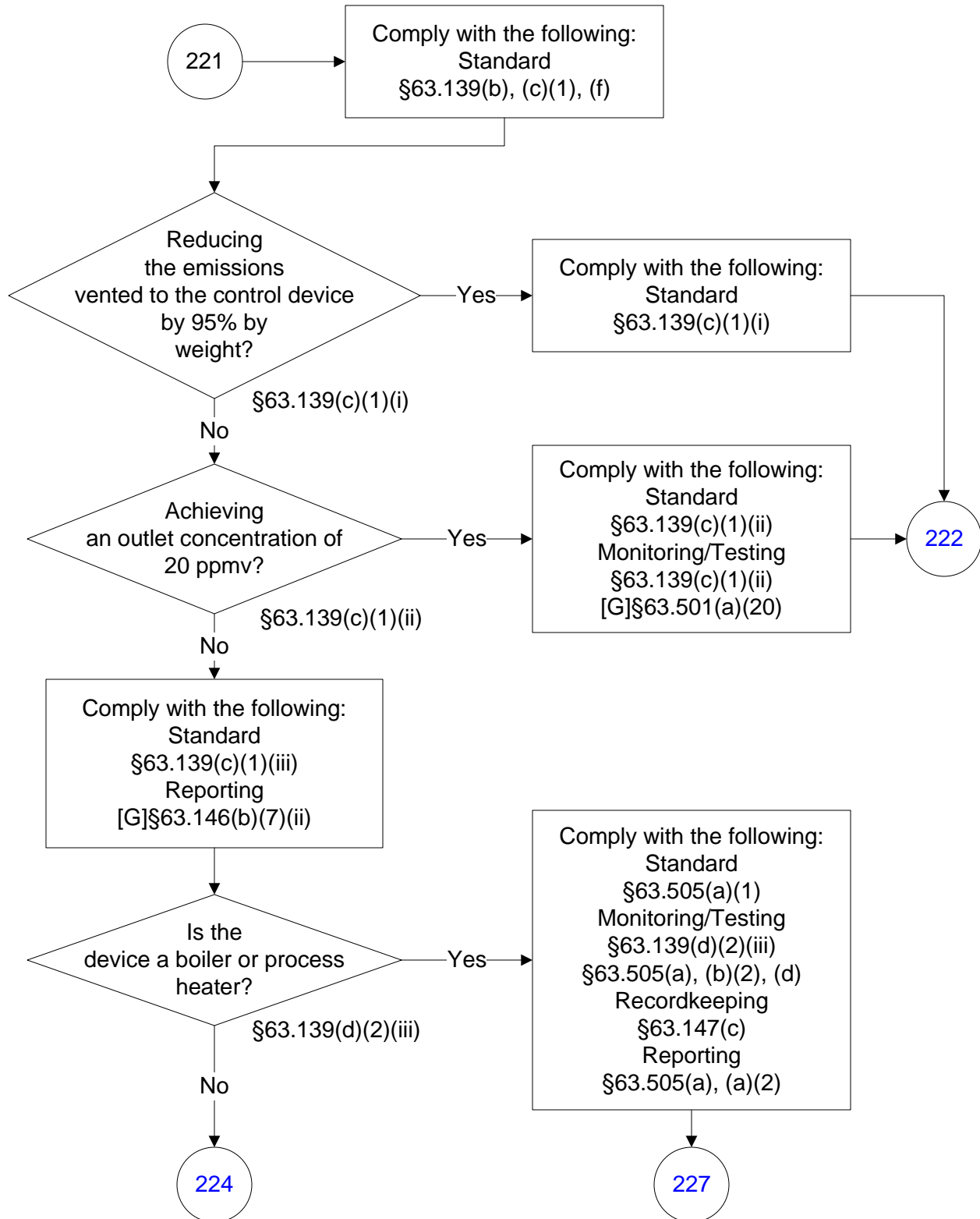

40 CFR Part 63, Subpart U

(107 of 176)

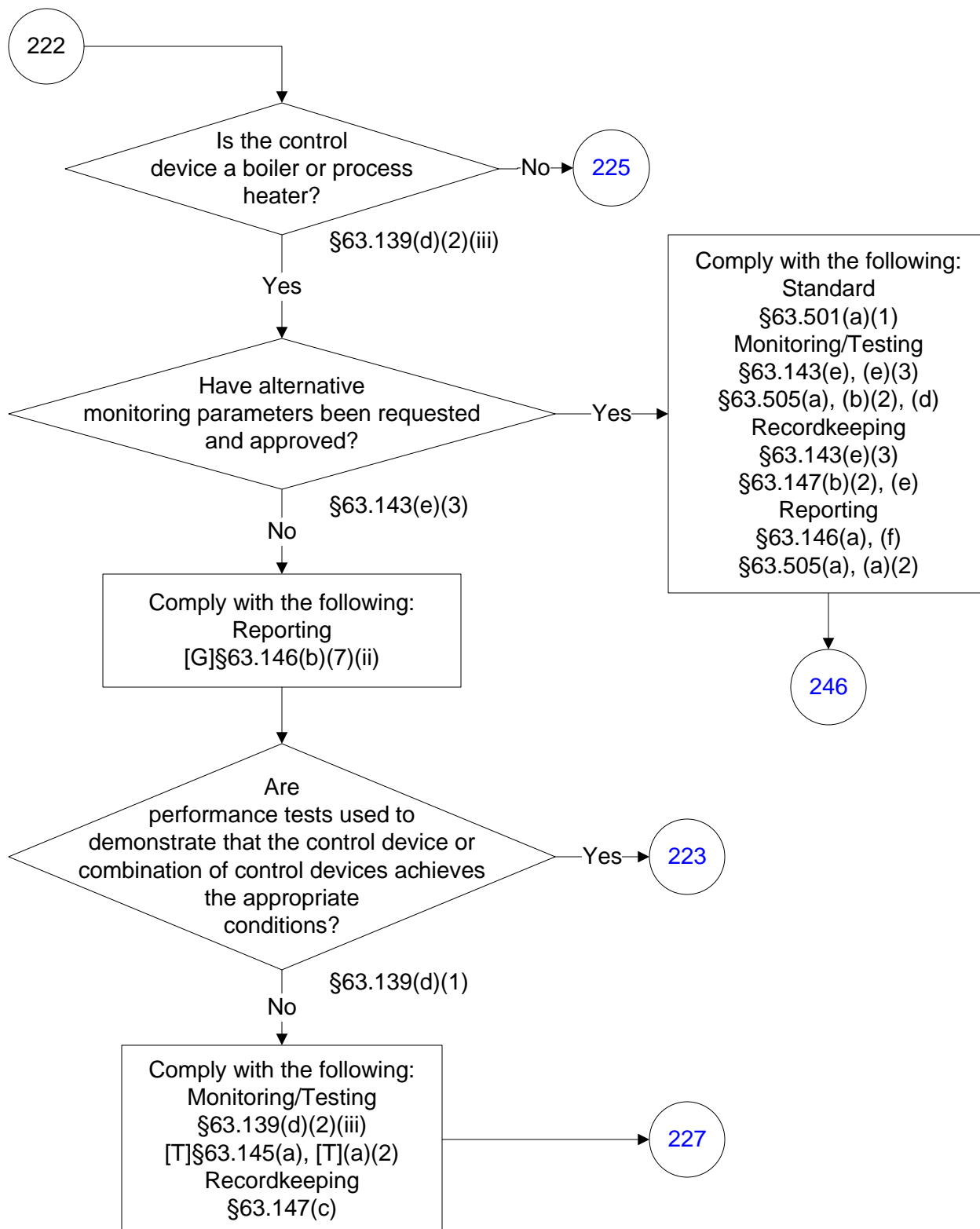

40 CFR Part 63, Subpart U (108 of 176)

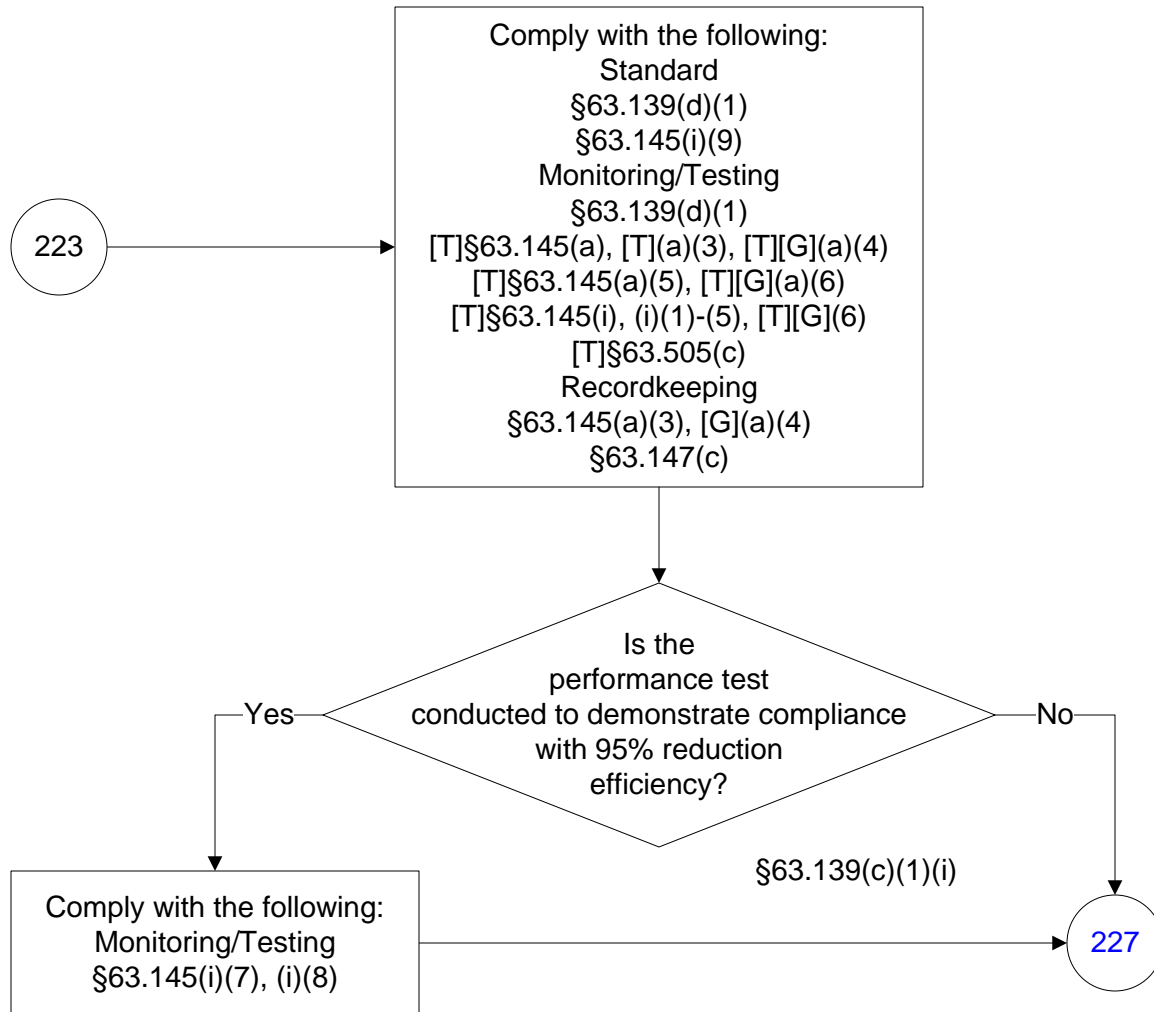

40 CFR Part 63, Subpart U

(109 of 176)

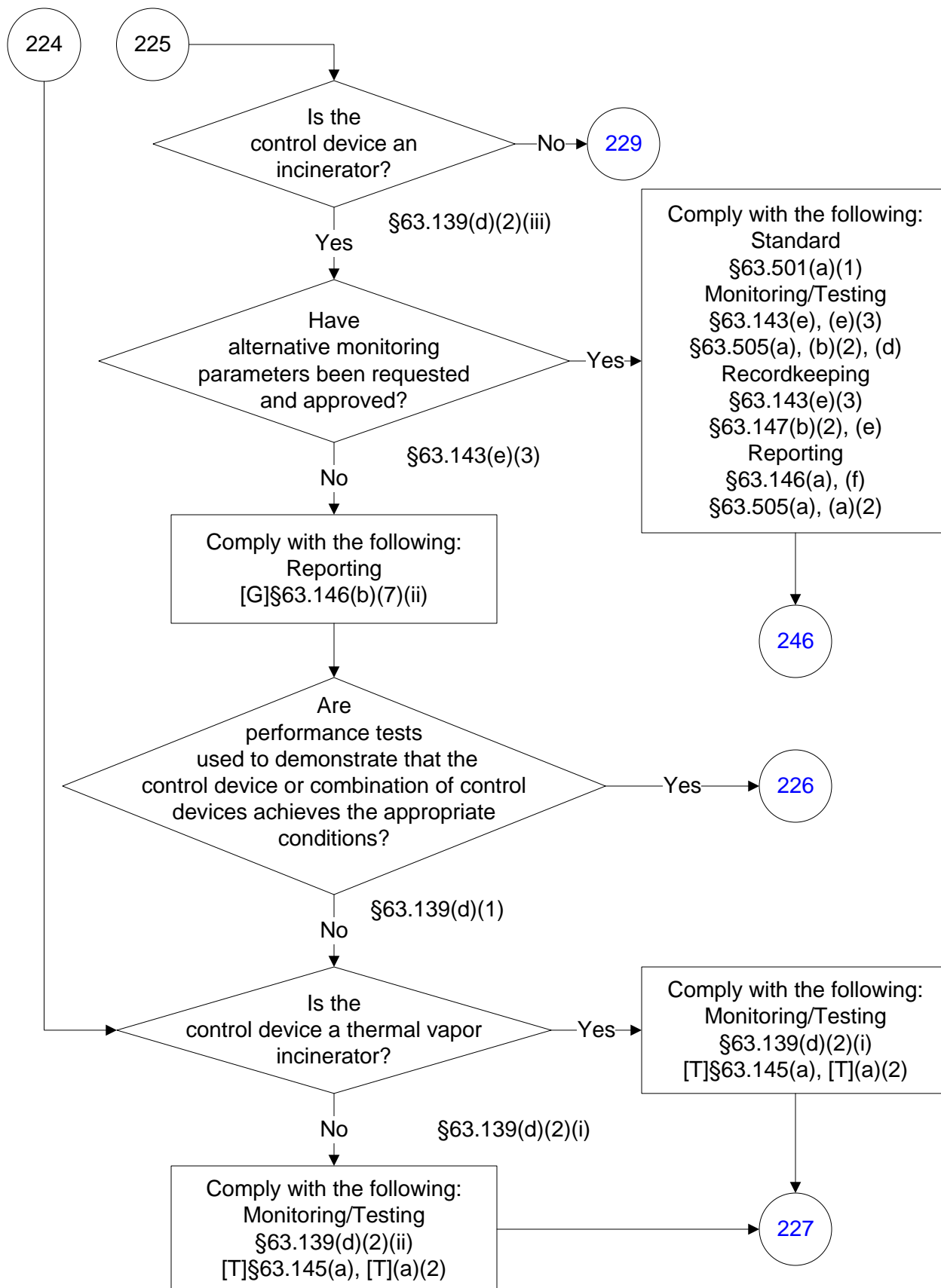

40 CFR Part 63, Subpart U (110 of 176)

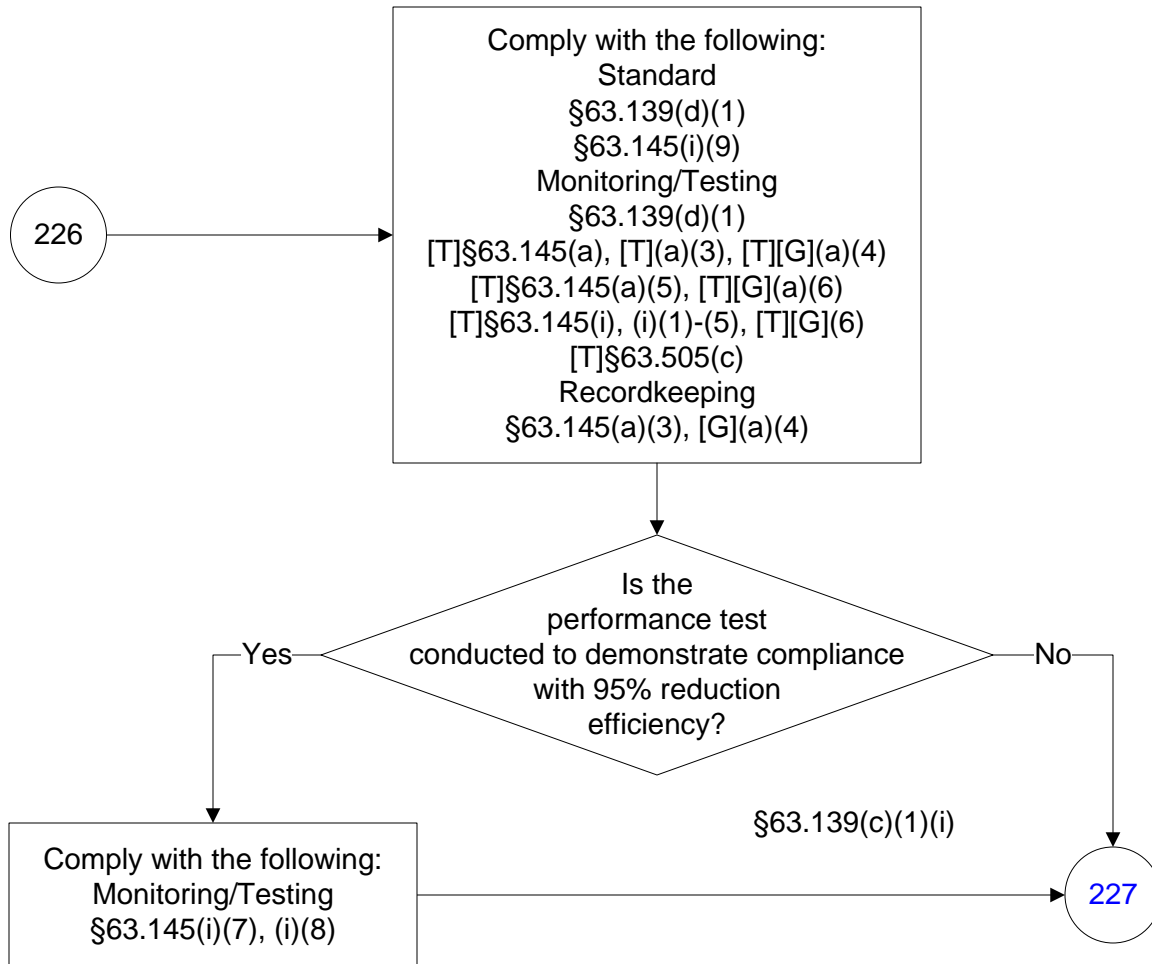

40 CFR Part 63, Subpart U

(111 of 176)

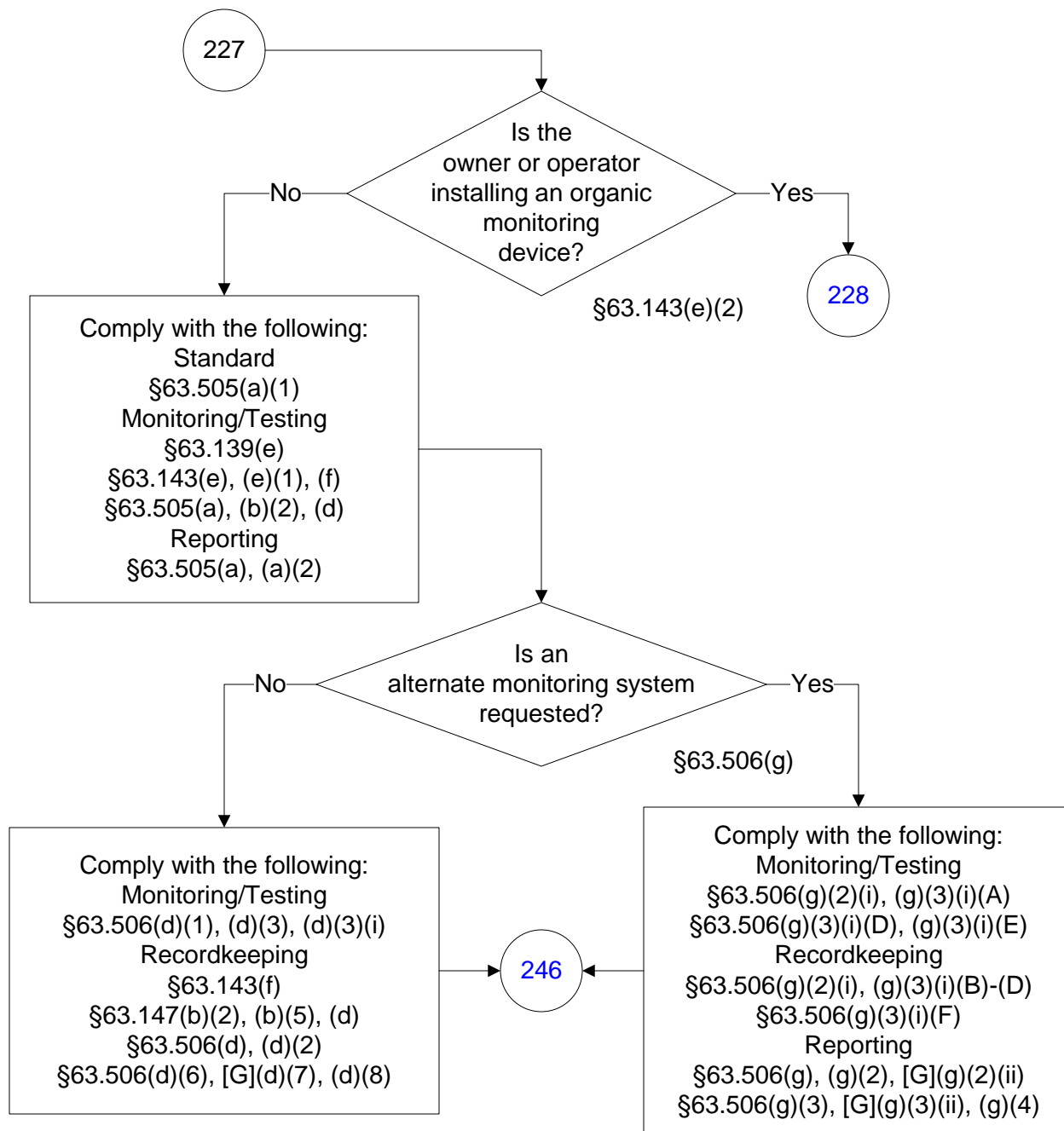

40 CFR Part 63, Subpart U
(112 of 176)

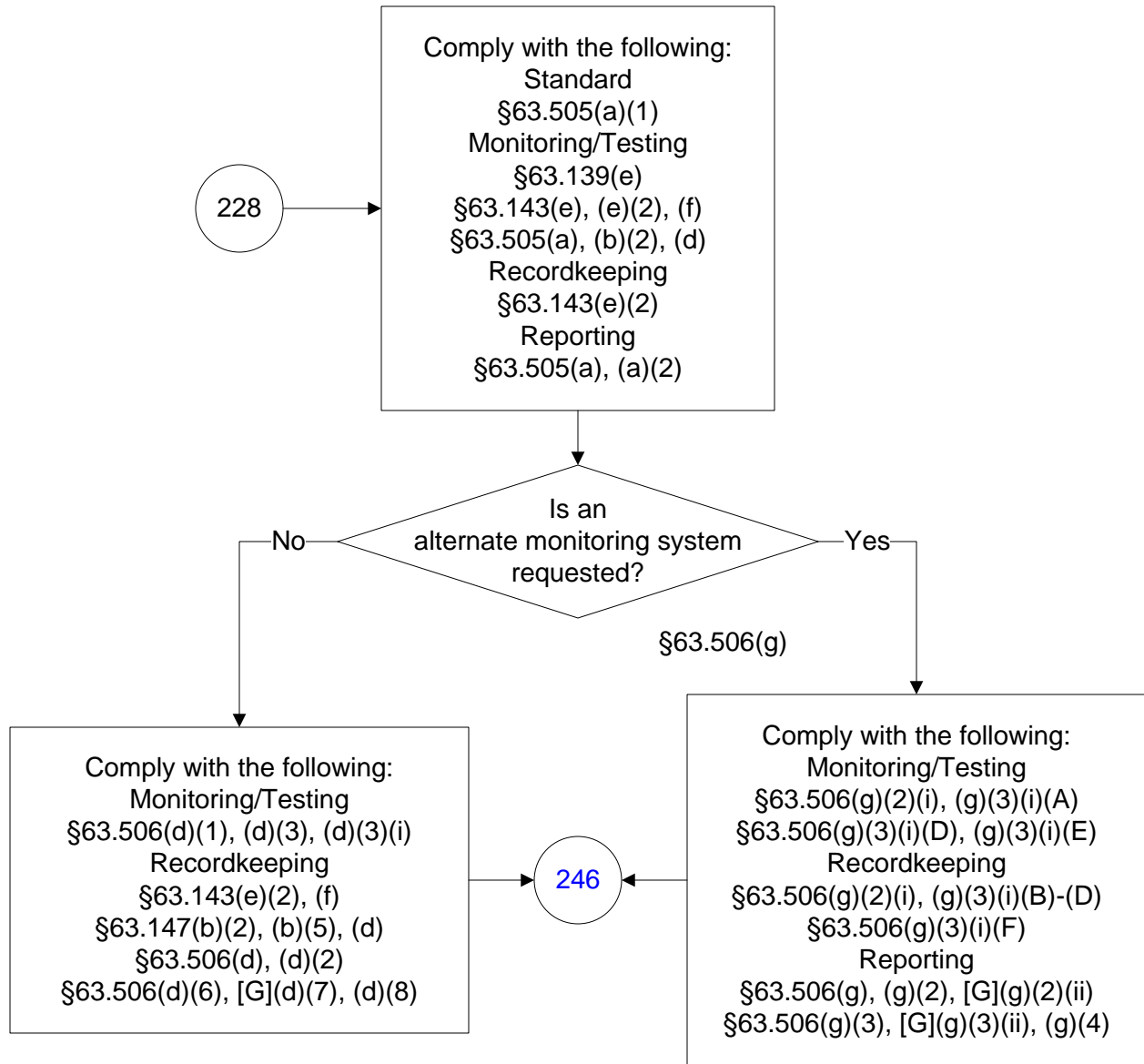

40 CFR Part 63, Subpart U

(113 of 176)

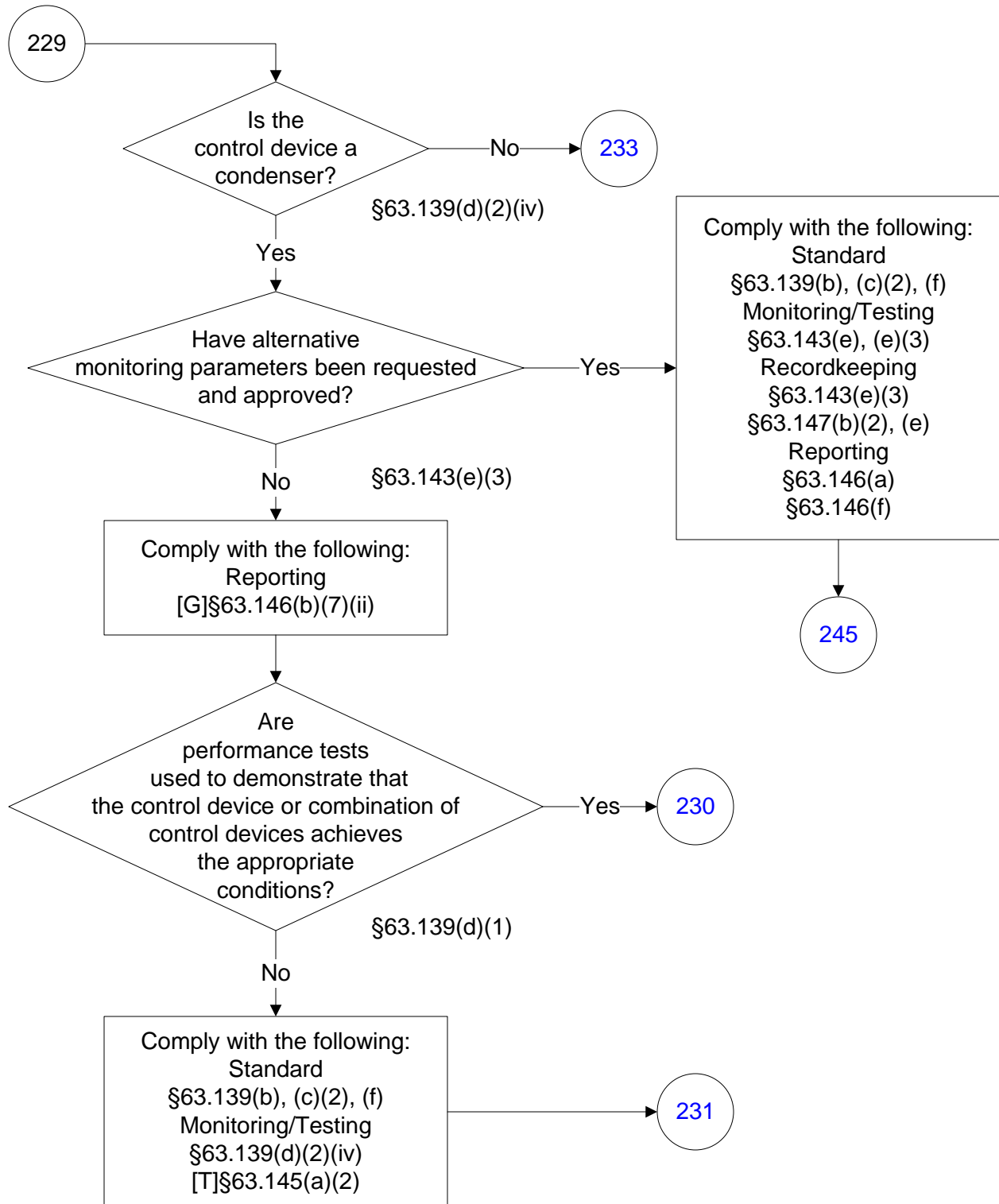

40 CFR Part 63, Subpart U (114 of 176)

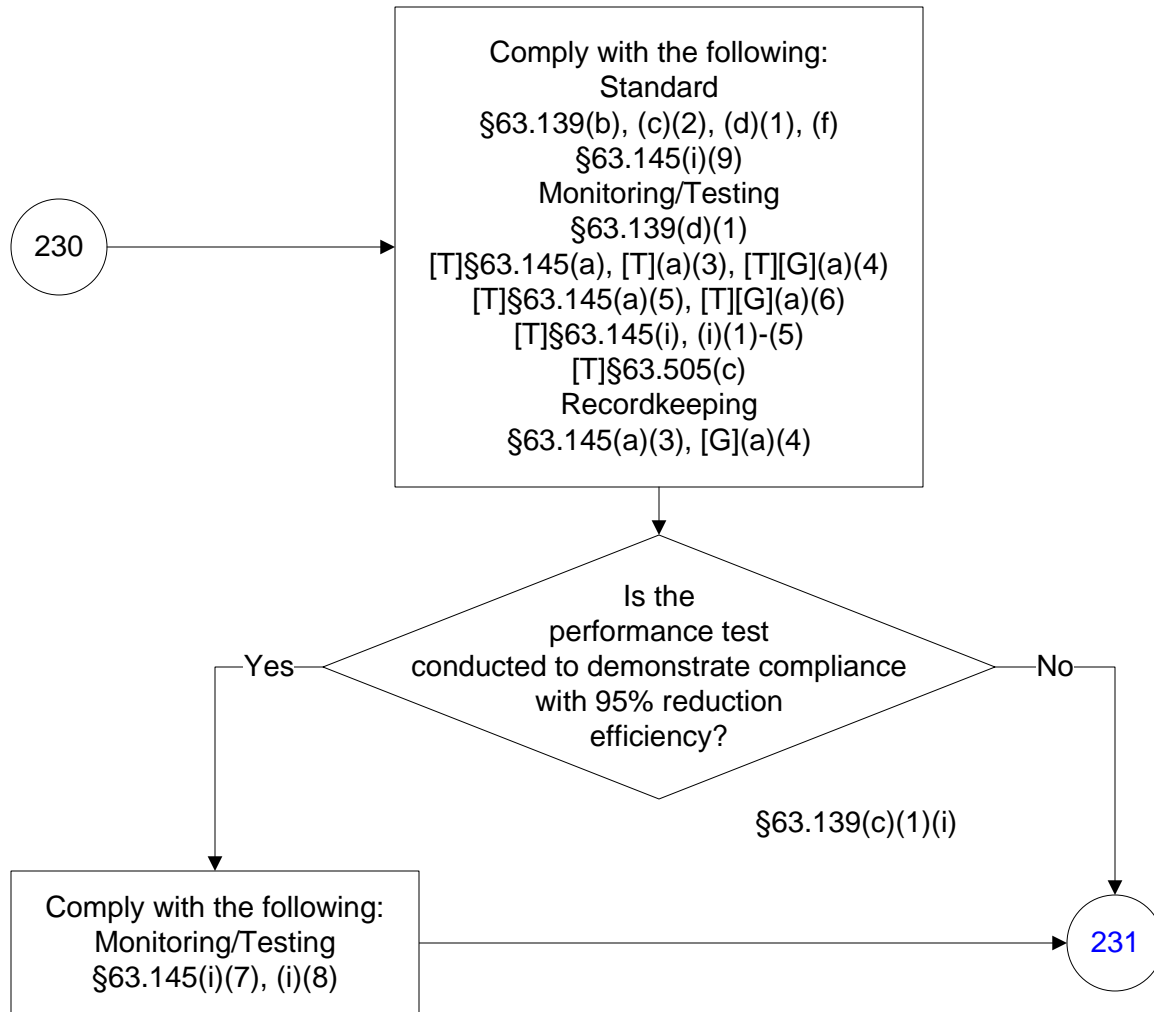

40 CFR Part 63, Subpart U

(115 of 176)

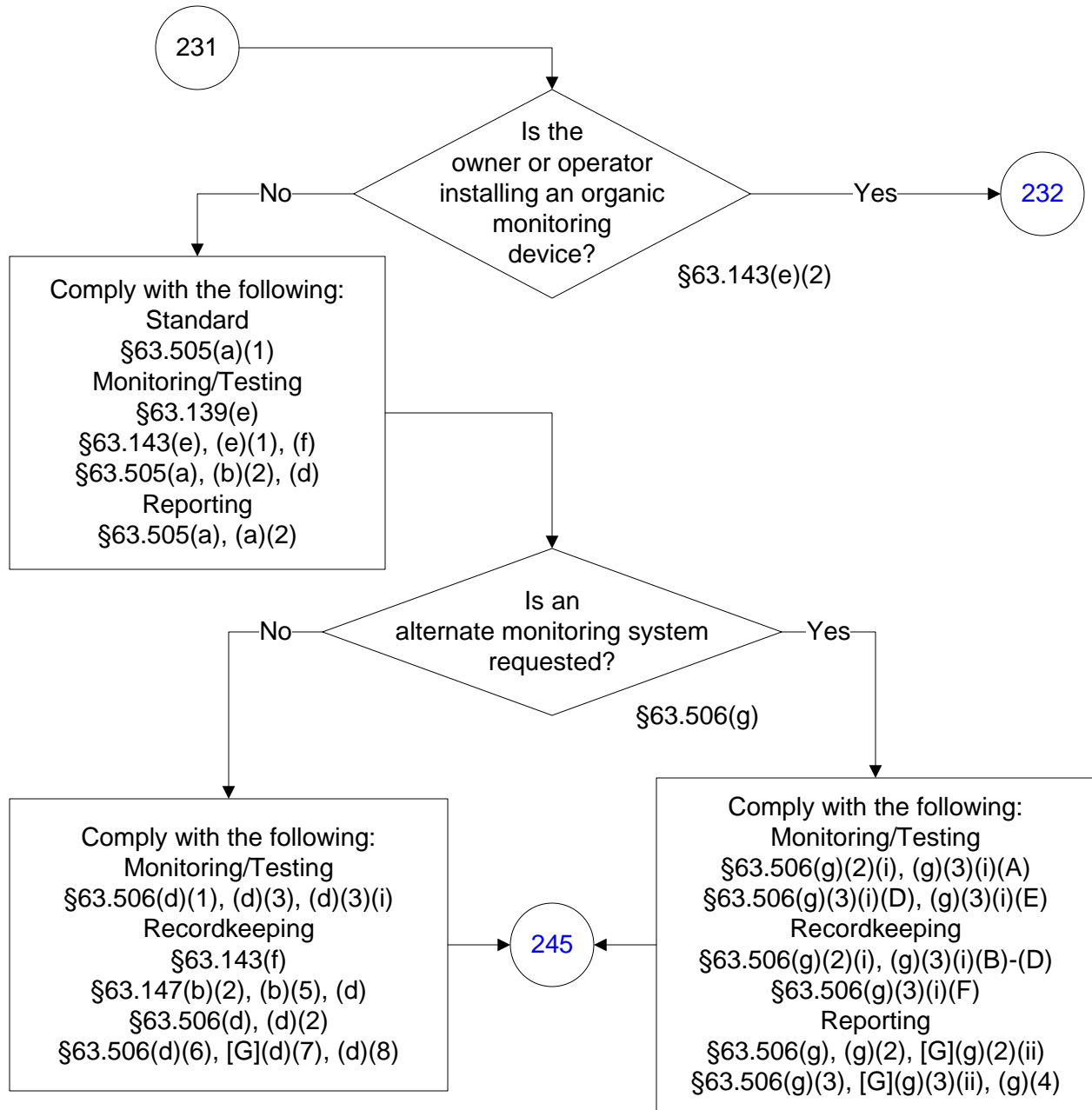

40 CFR Part 63, Subpart U

(116 of 176)

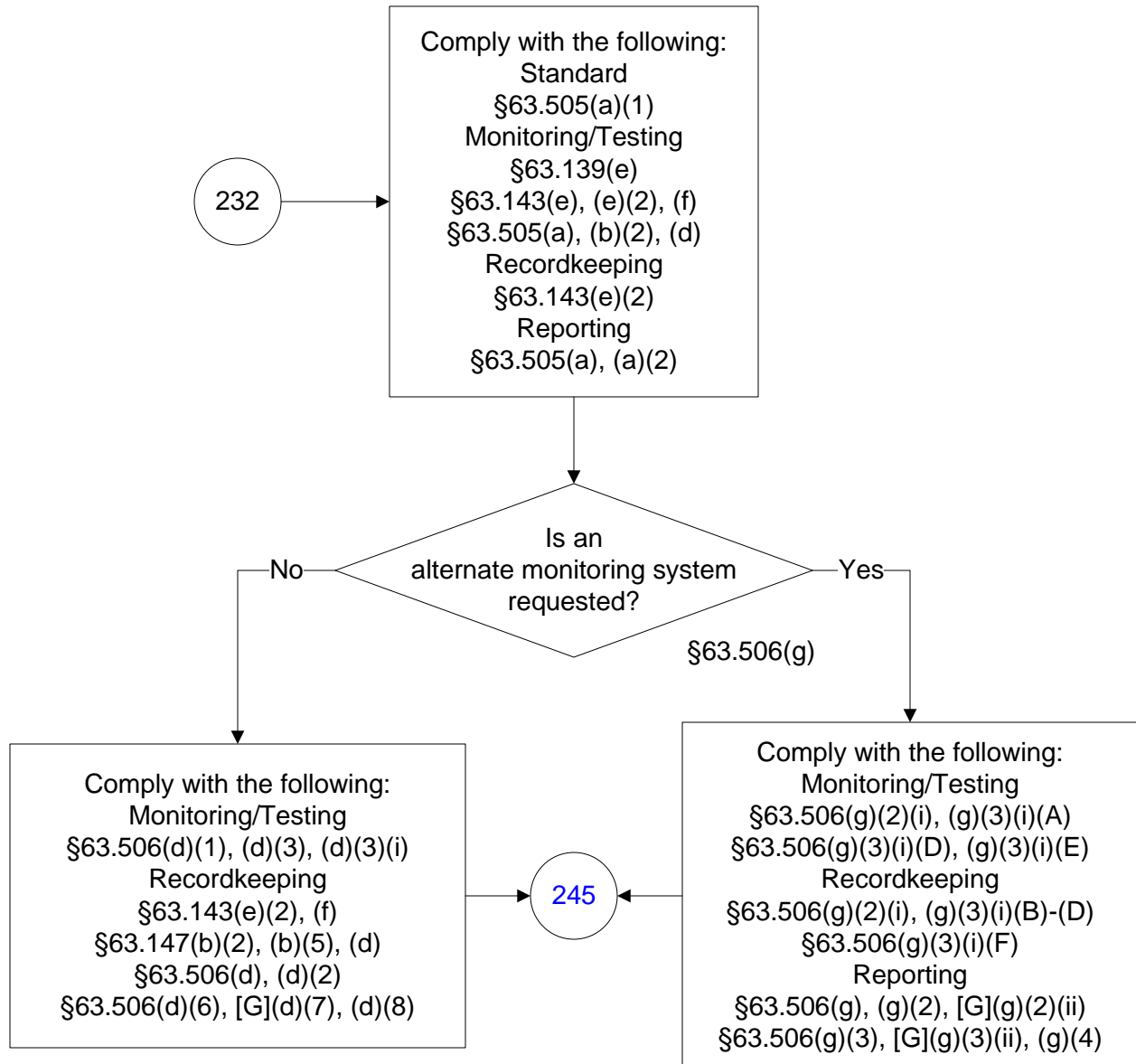

40 CFR Part 63, Subpart U

(117 of 176)

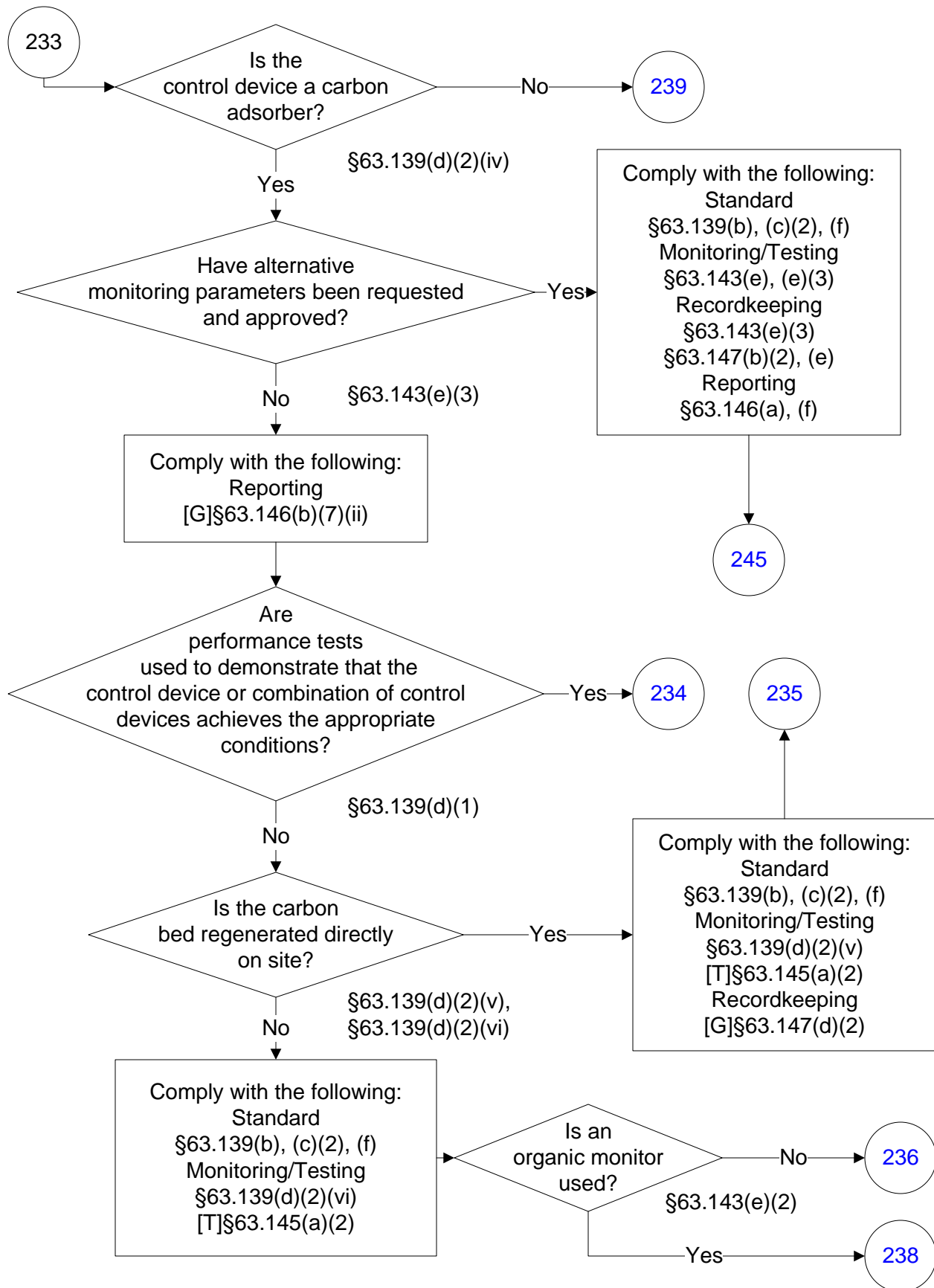

40 CFR Part 63, Subpart U

(118 of 176)

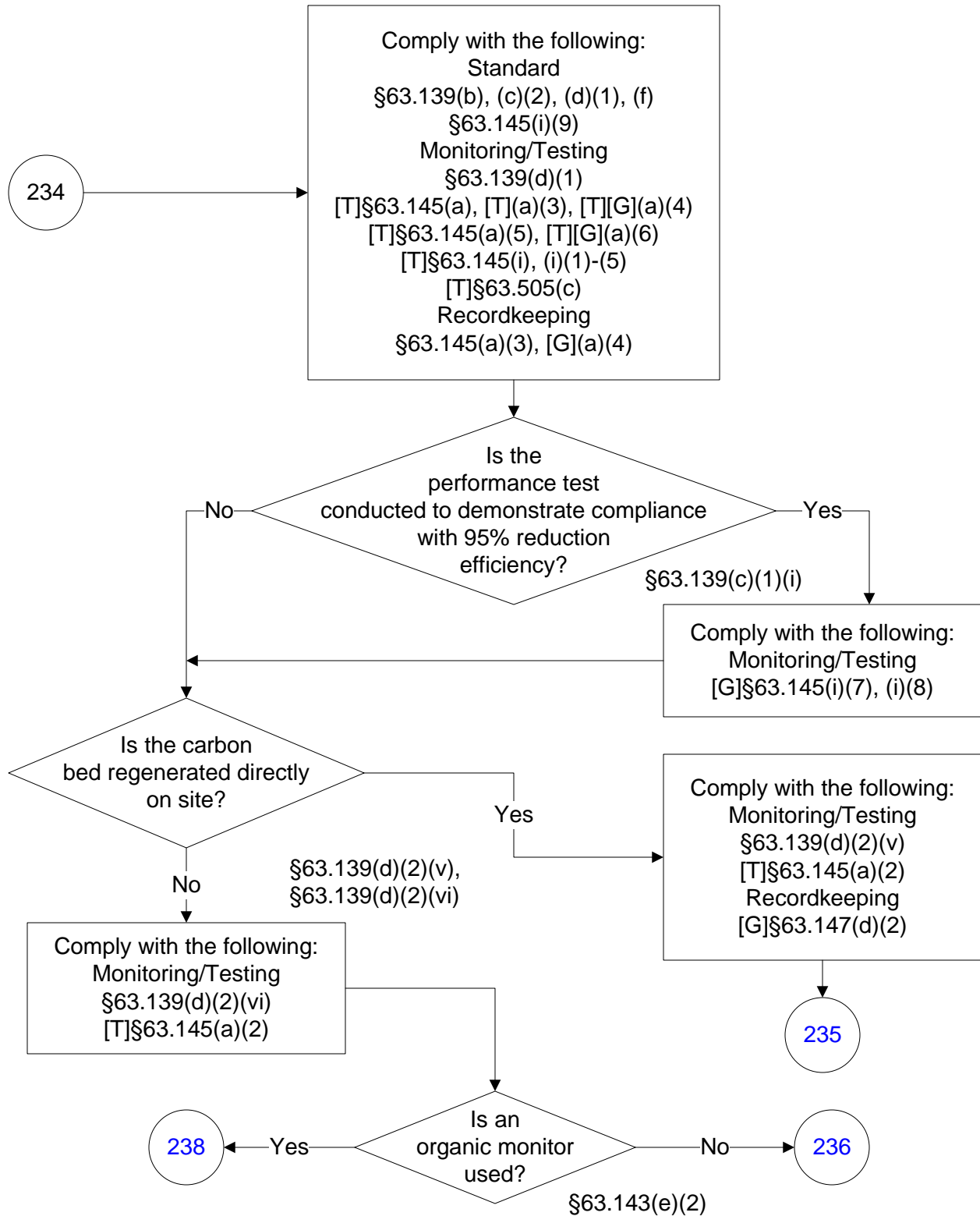

40 CFR Part 63, Subpart U

(119 of 176)

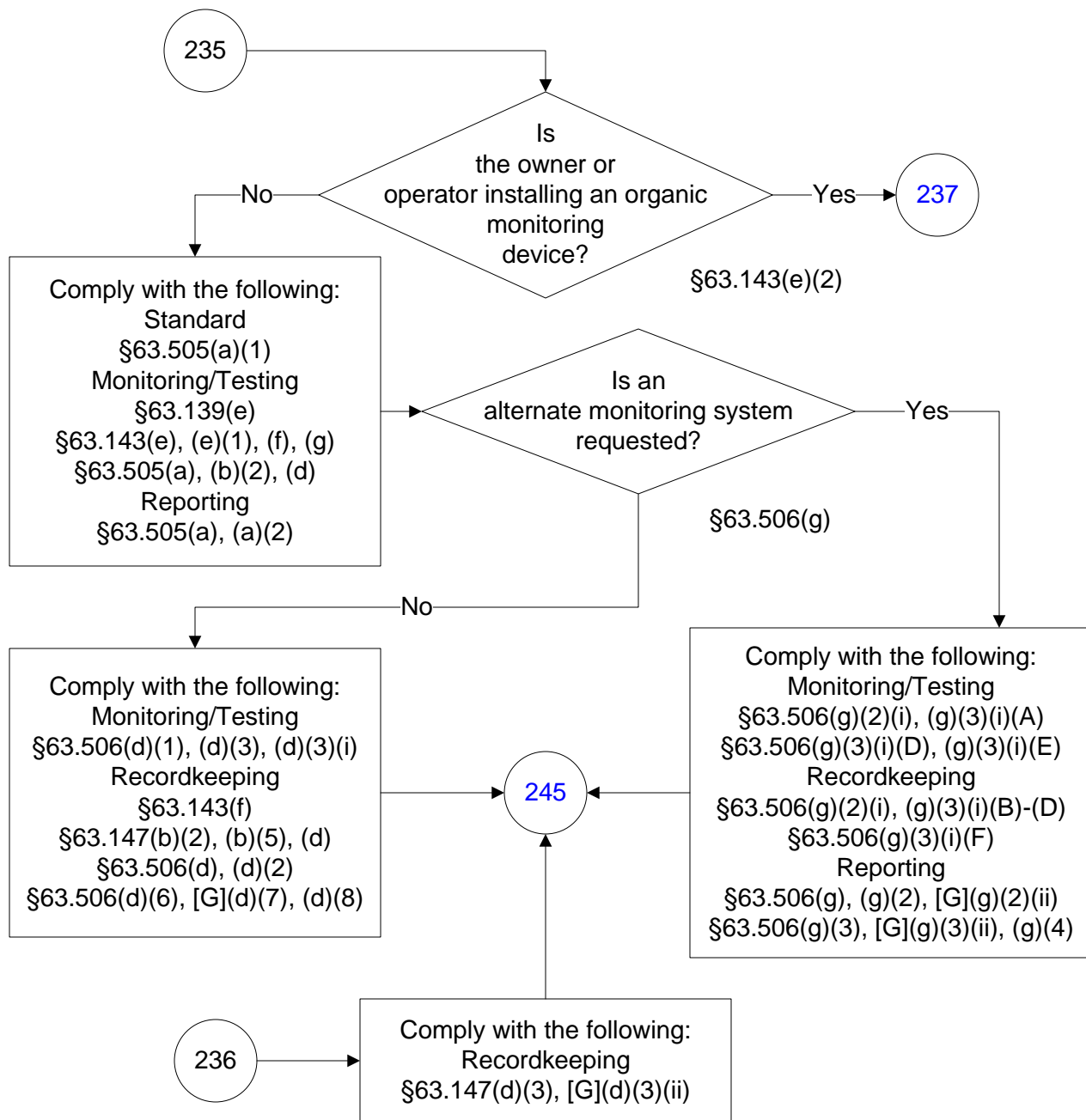

40 CFR Part 63, Subpart U

(120 of 176)

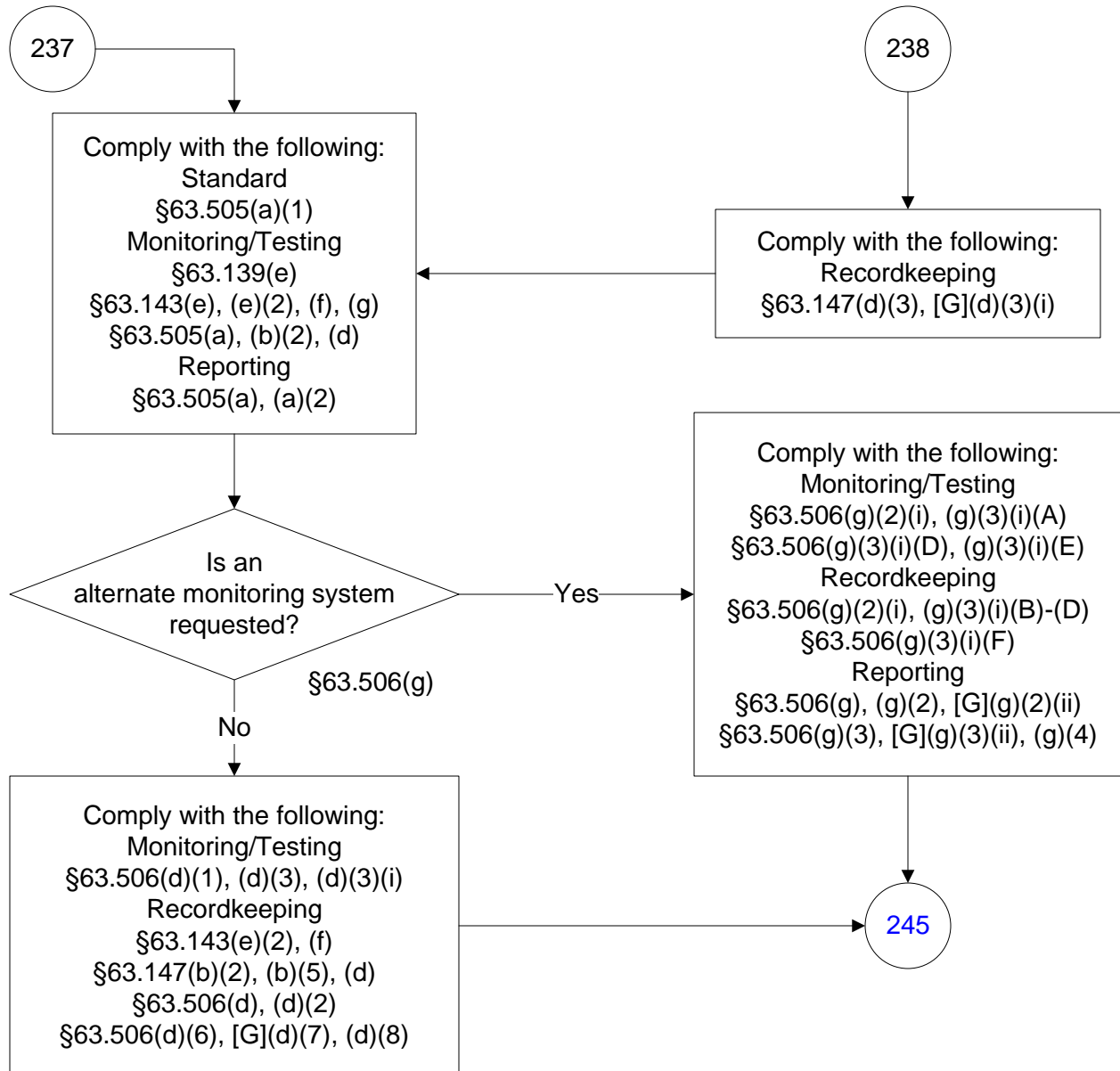

40 CFR Part 63, Subpart U

(121 of 176)

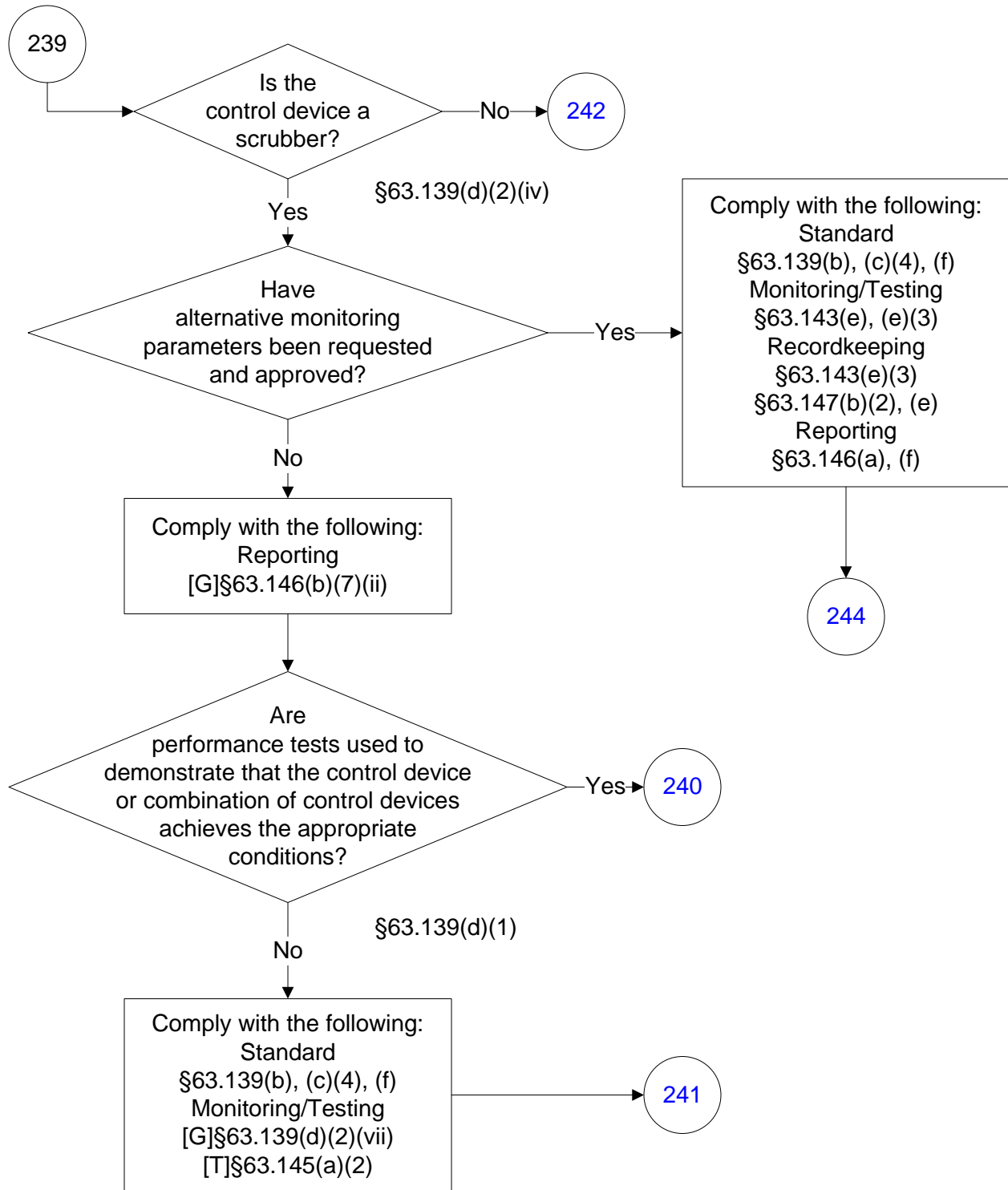

40 CFR Part 63, Subpart U

(122 of 176)

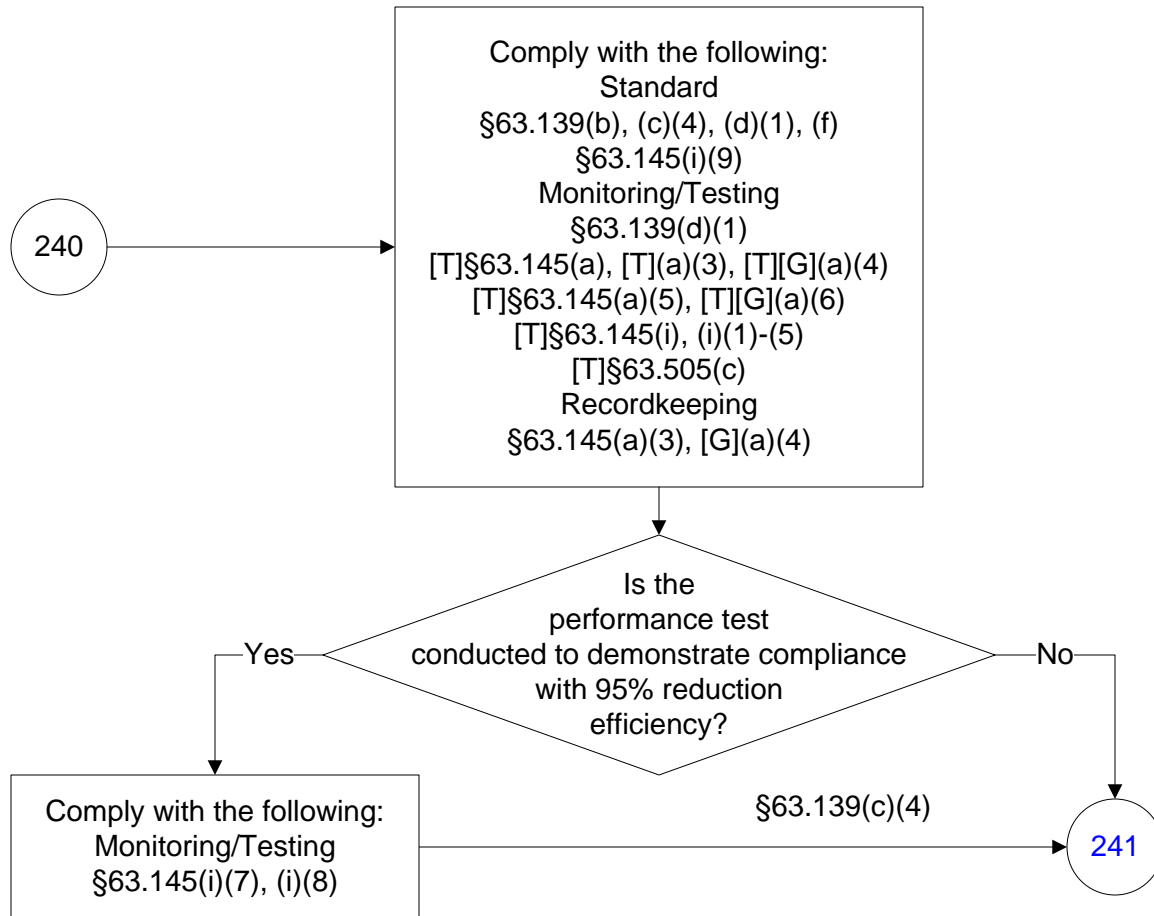

40 CFR Part 63, Subpart U

(123 of 176)

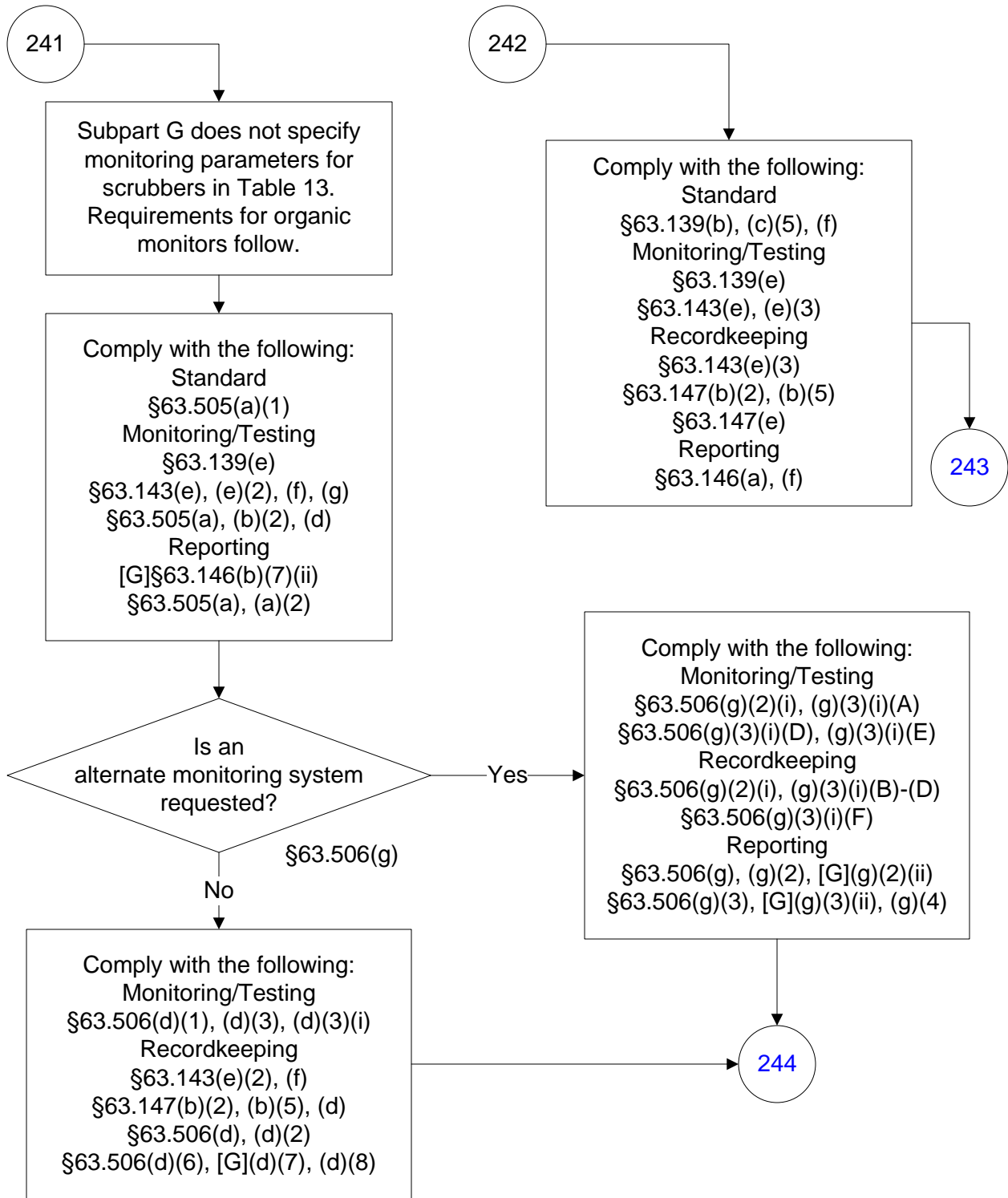

40 CFR Part 63, Subpart U

(124 of 176)

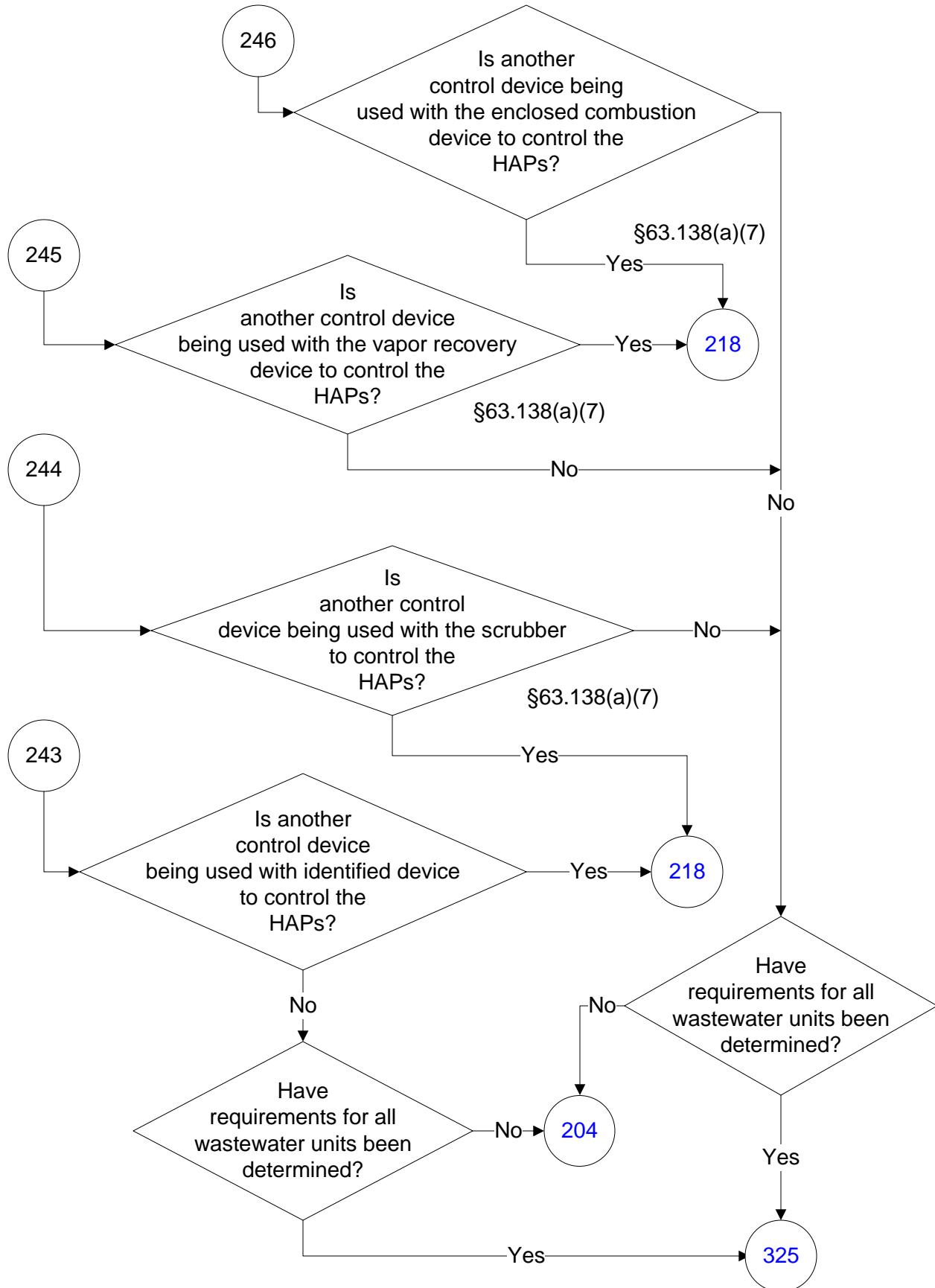

40 CFR Part 63, Subpart U

(125 of 176)

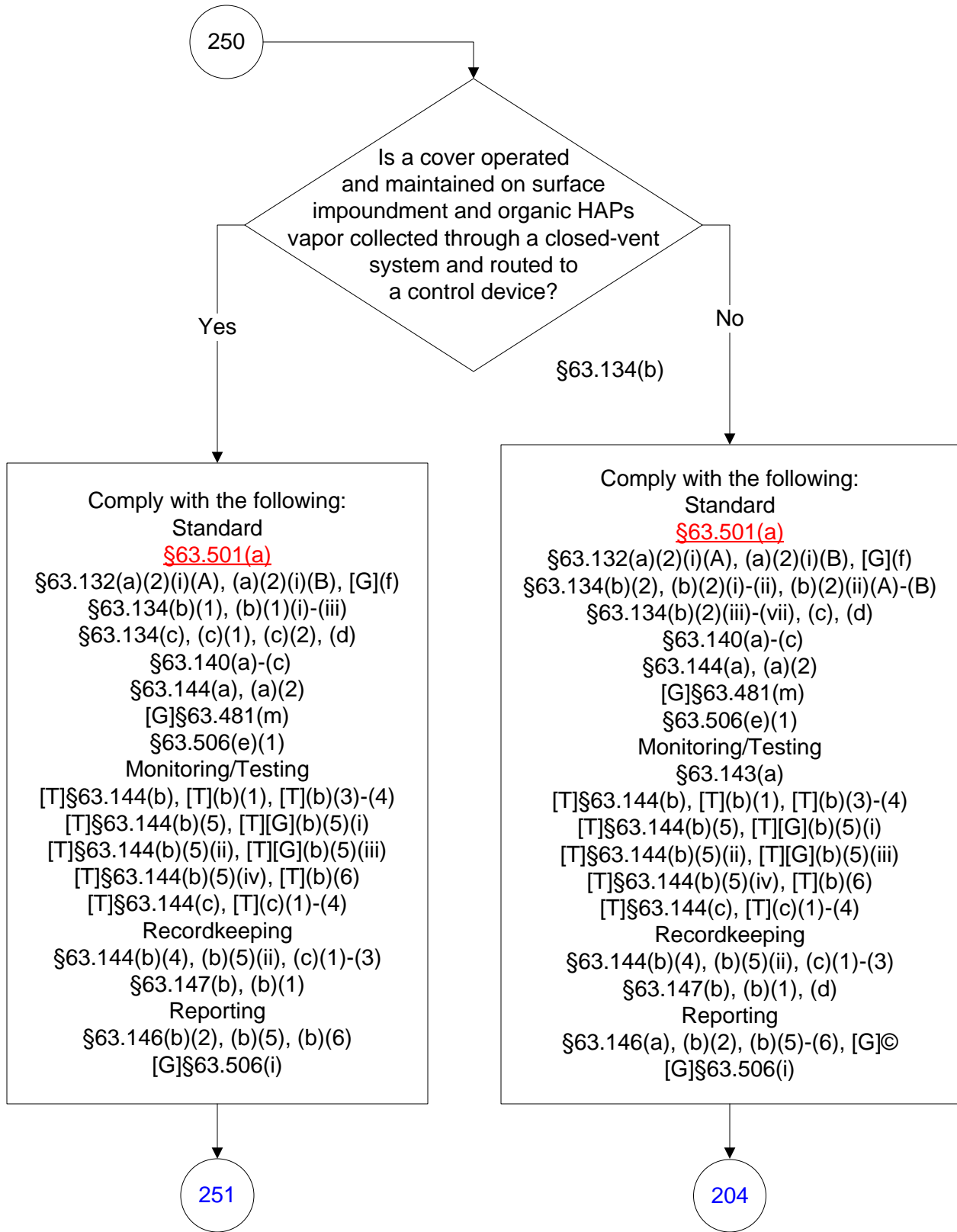

40 CFR Part 63, Subpart U

(126 of 176)

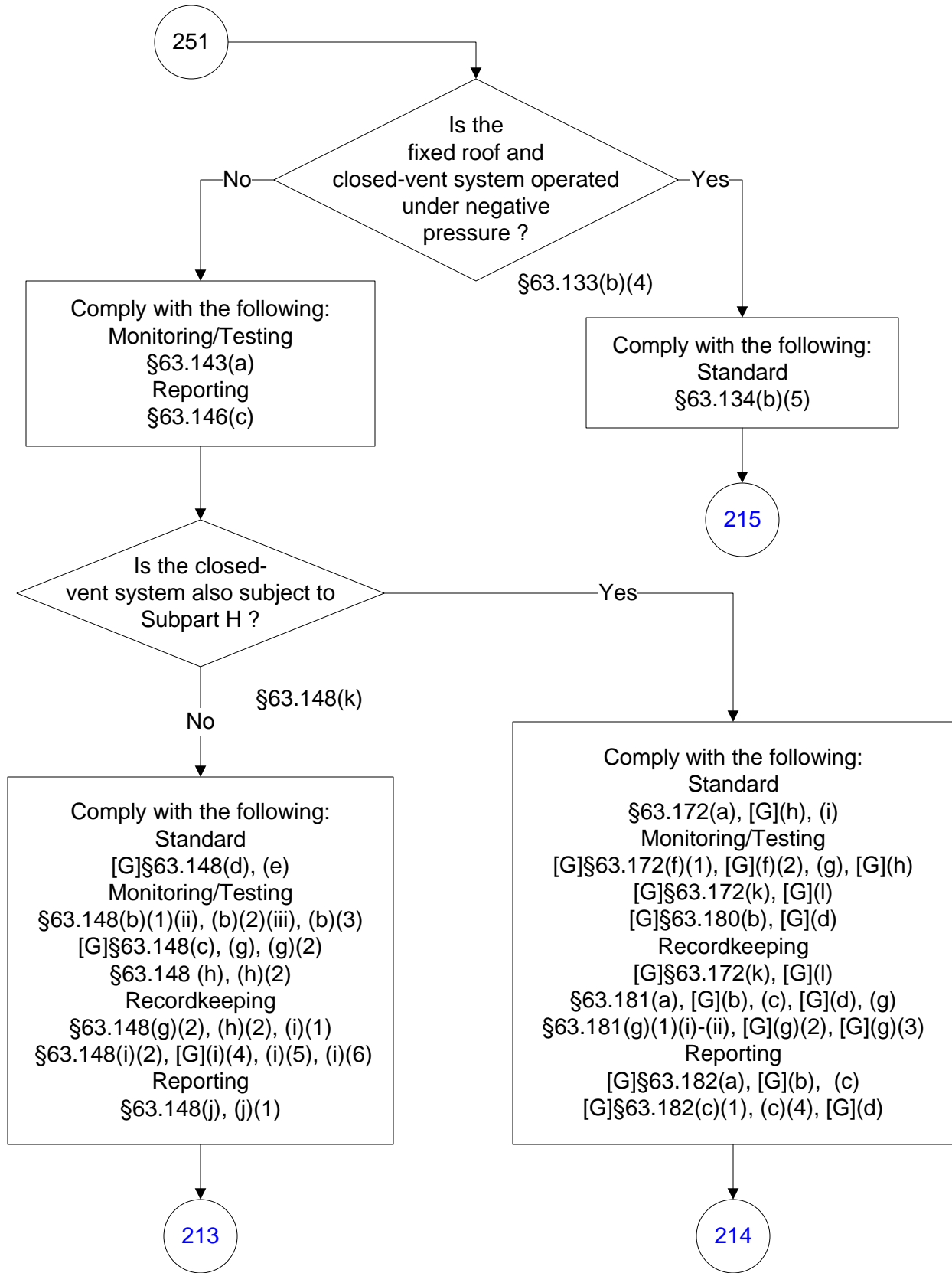

40 CFR Part 63, Subpart U

(127 of 176)

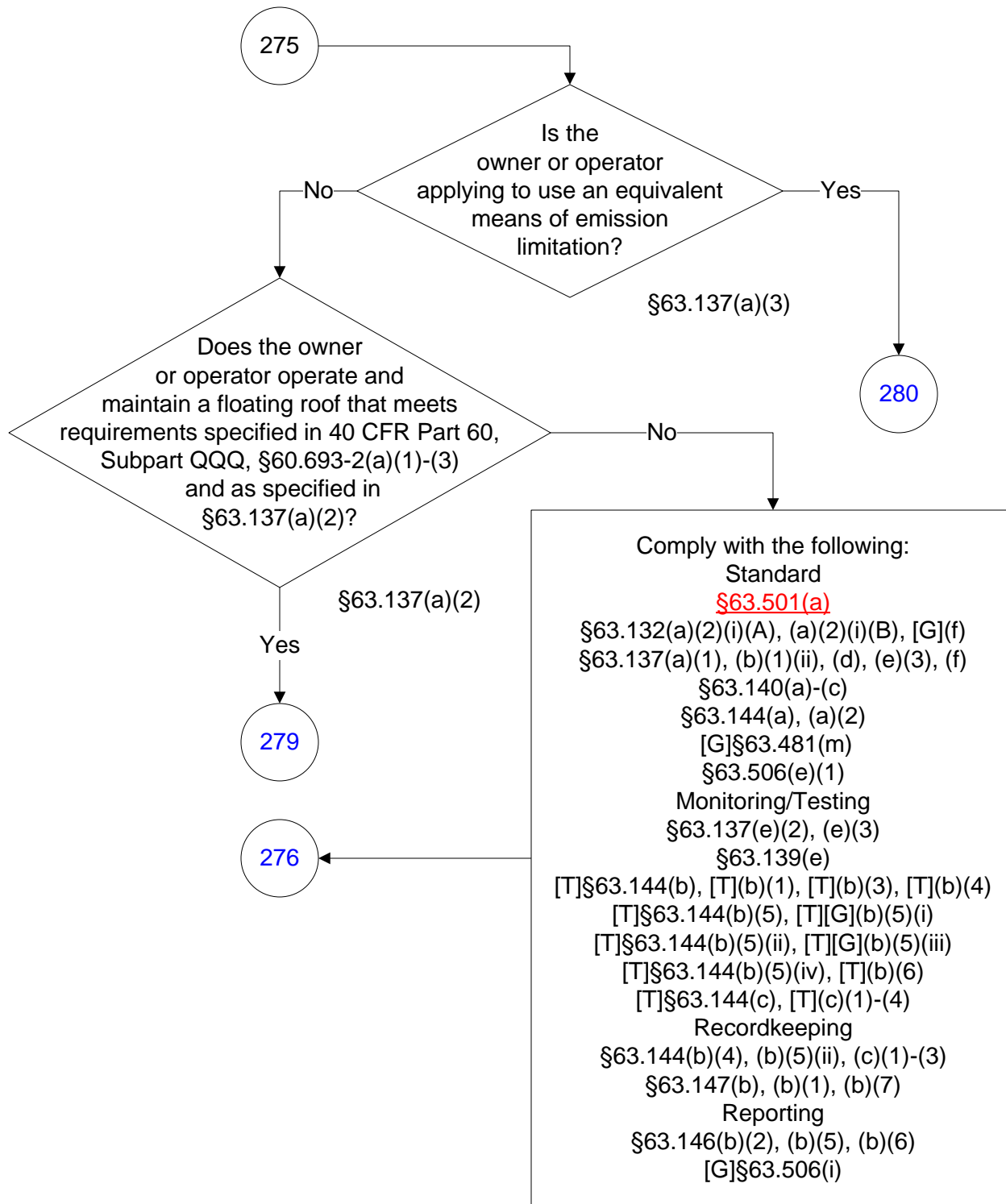

40 CFR Part 63, Subpart U

(128 of 176)

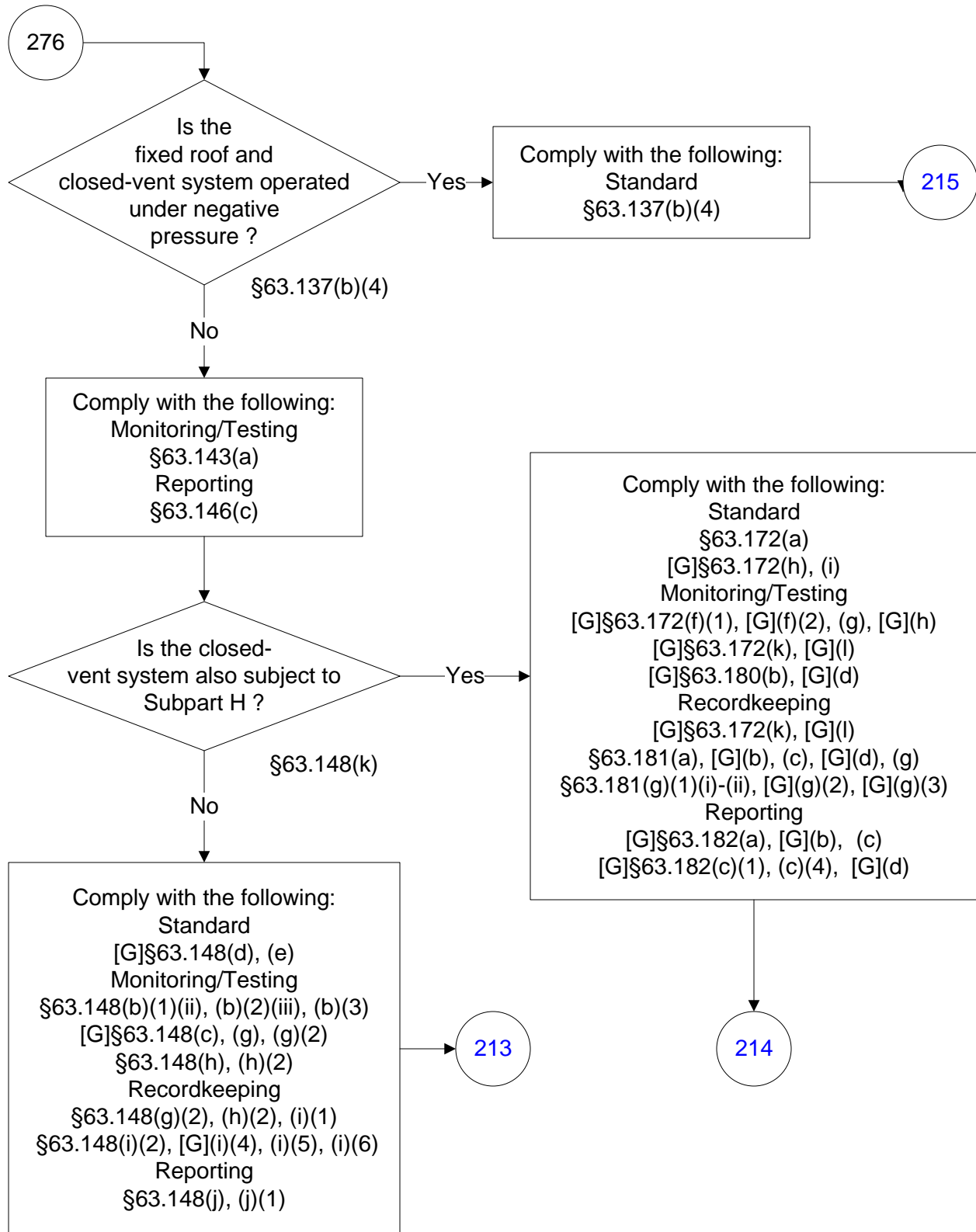

40 CFR Part 63, Subpart U

(129 of 176)

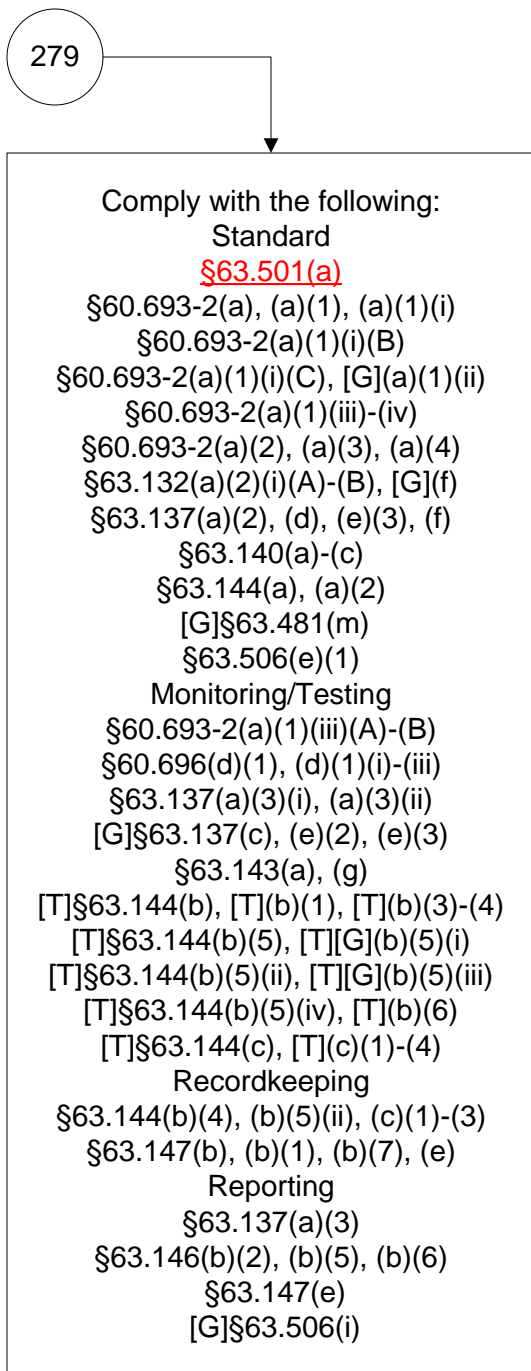

281

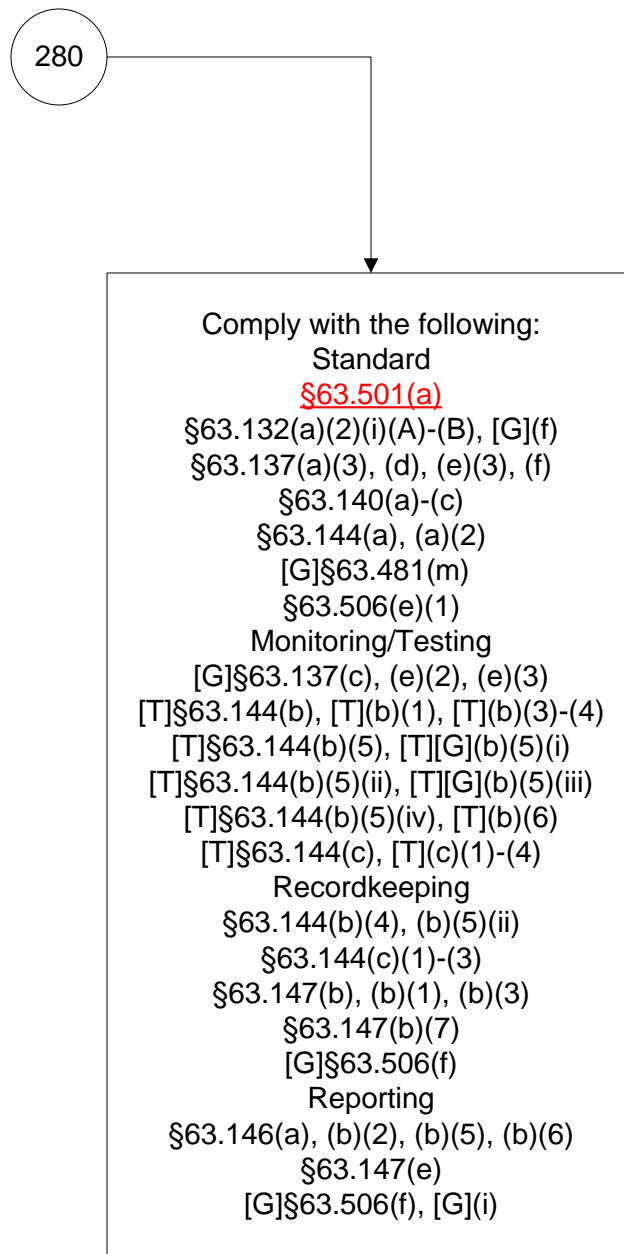

204

40 CFR Part 63, Subpart U

(130 of 176)

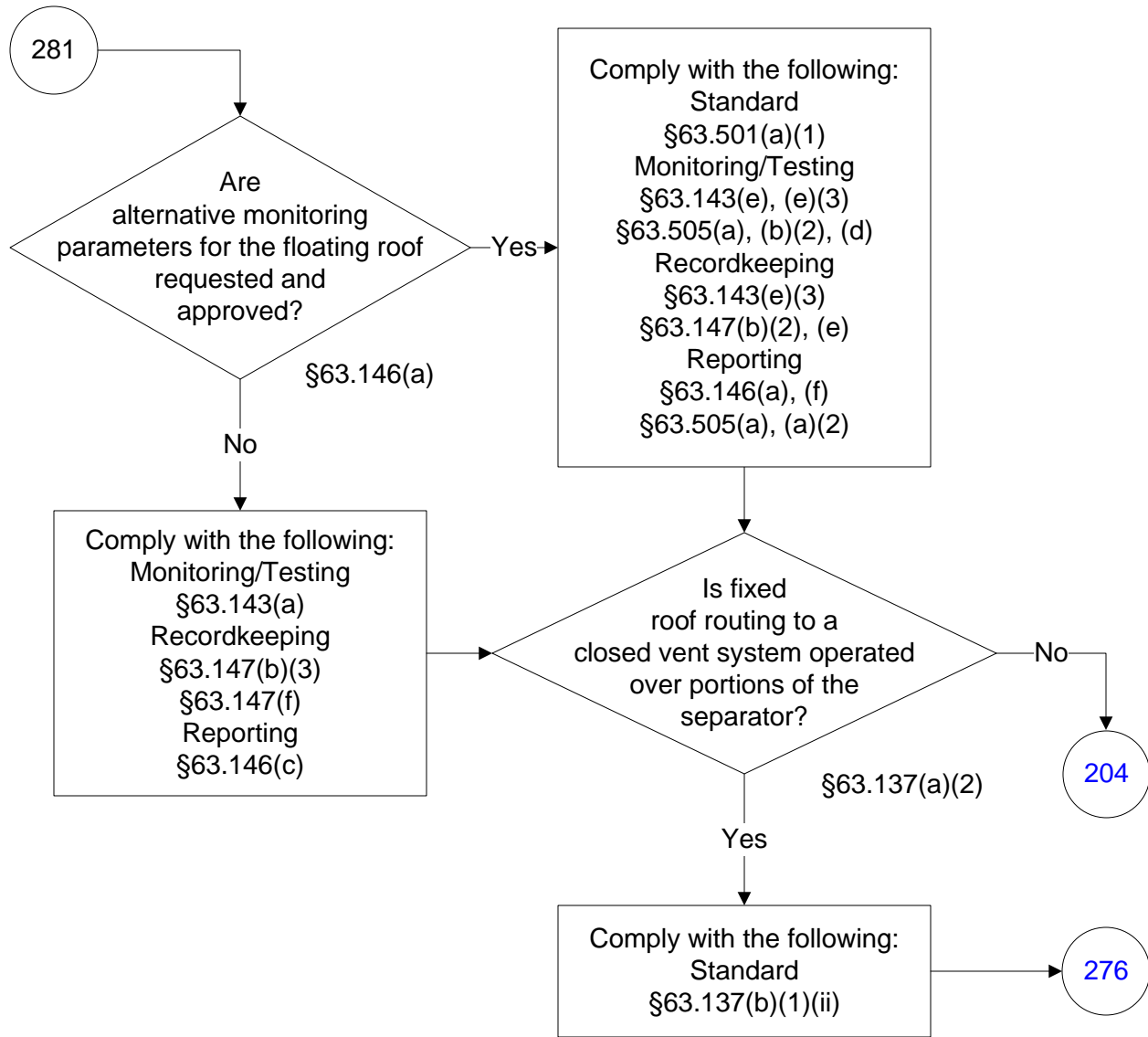

40 CFR Part 63, Subpart U

(131 of 176)

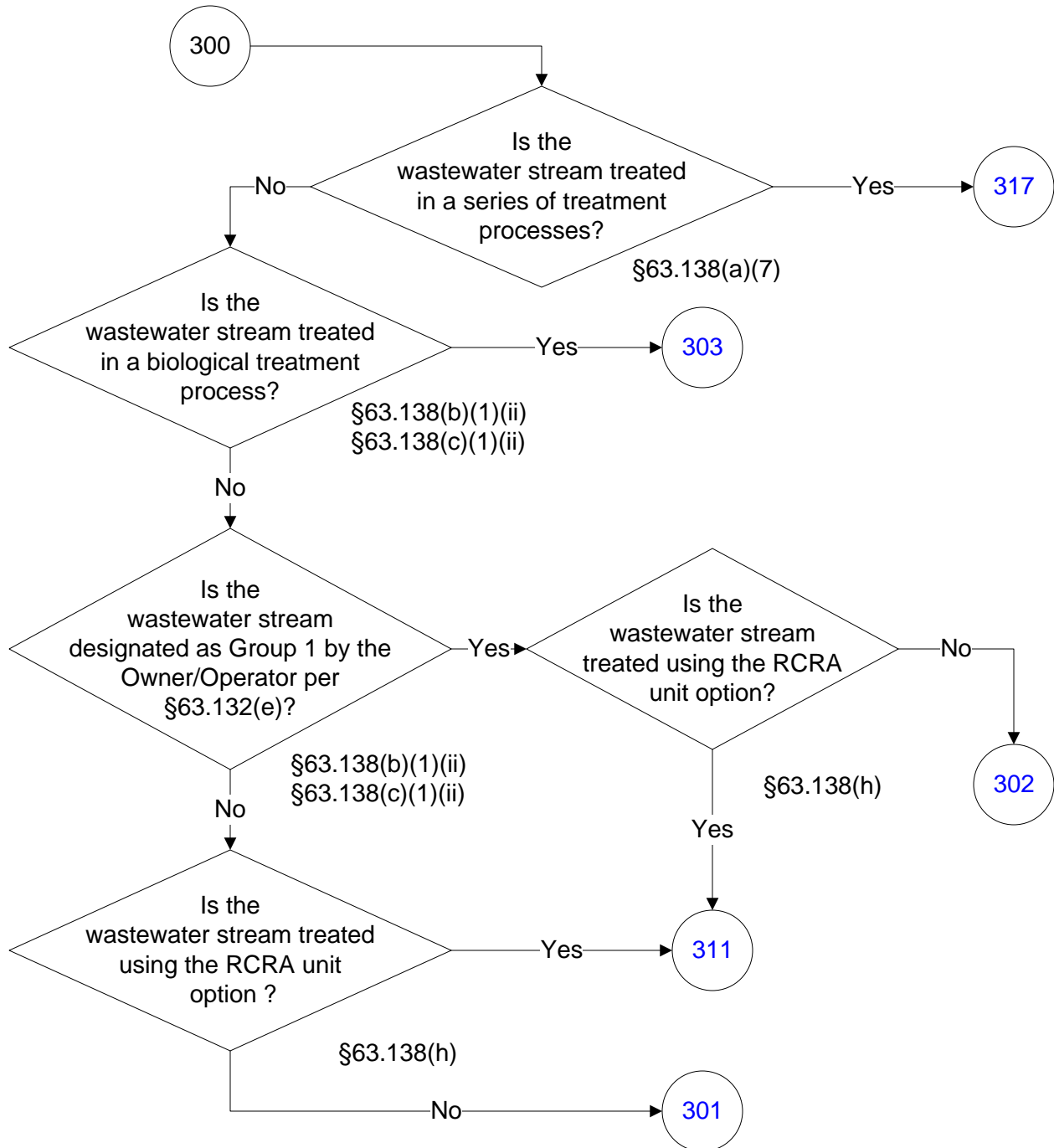

40 CFR Part 63, Subpart U

(132 of 176)

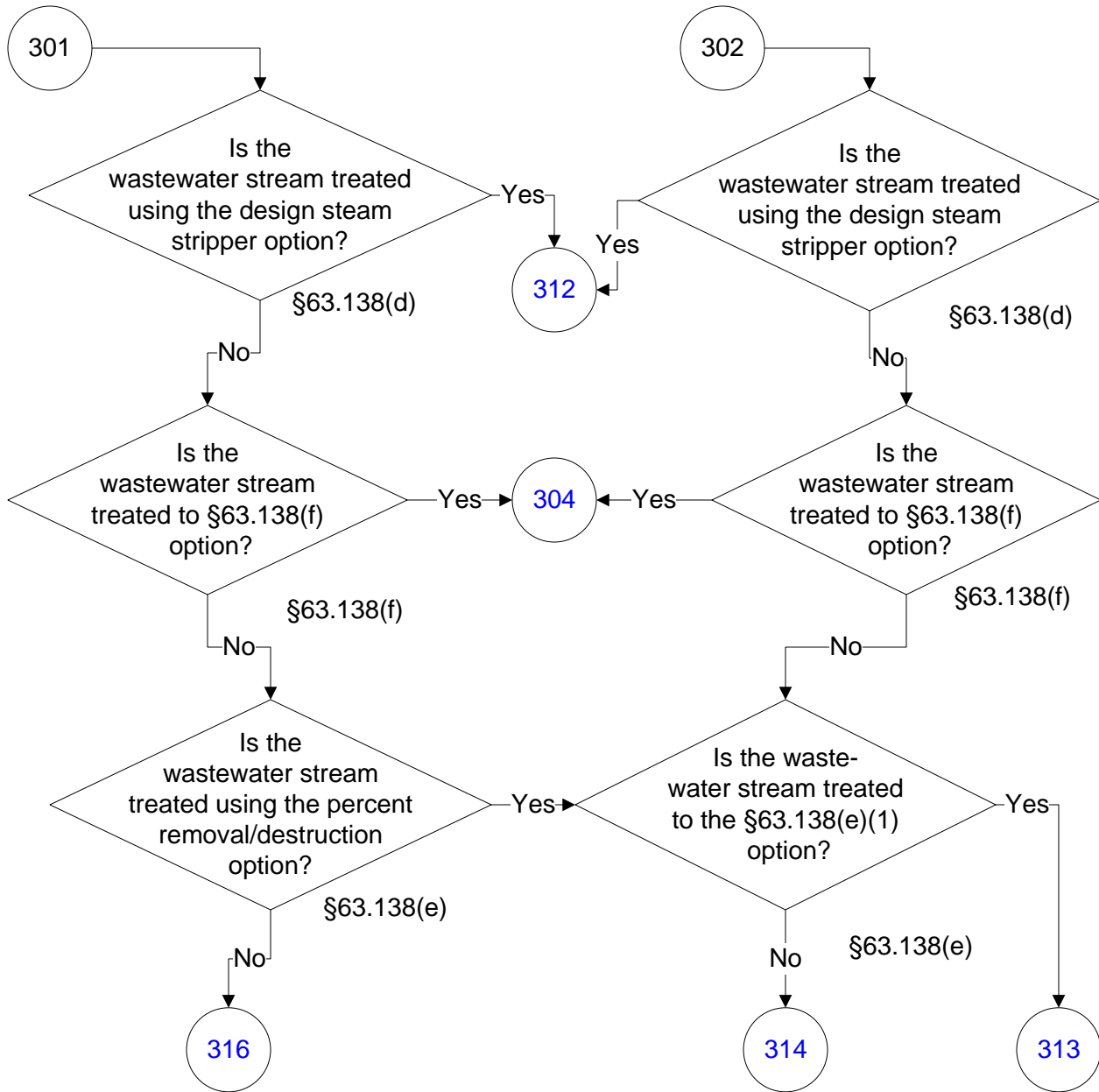

40 CFR Part 63, Subpart U

(133 of 176)

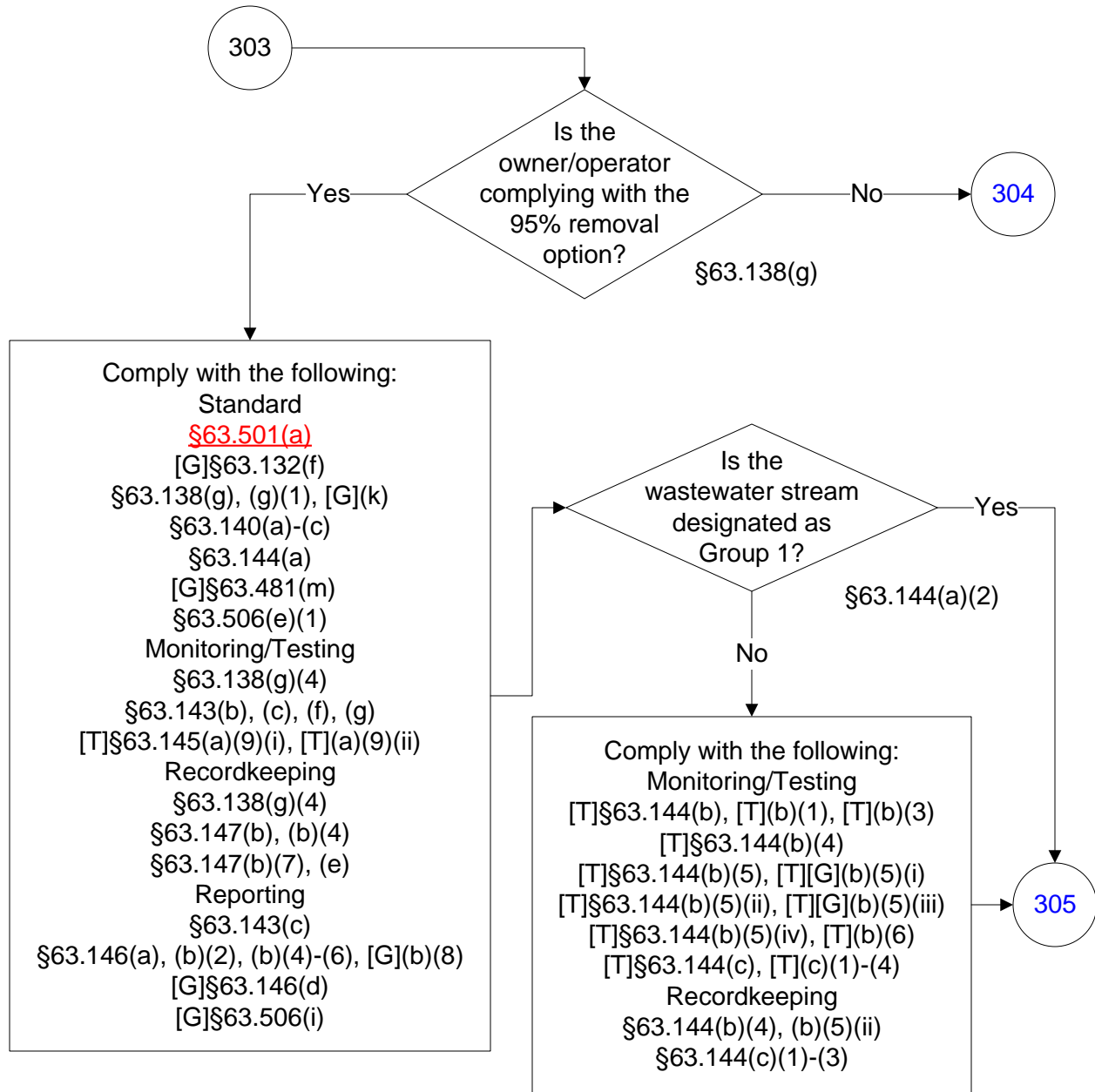

40 CFR Part 63, Subpart U
(134 of 176)

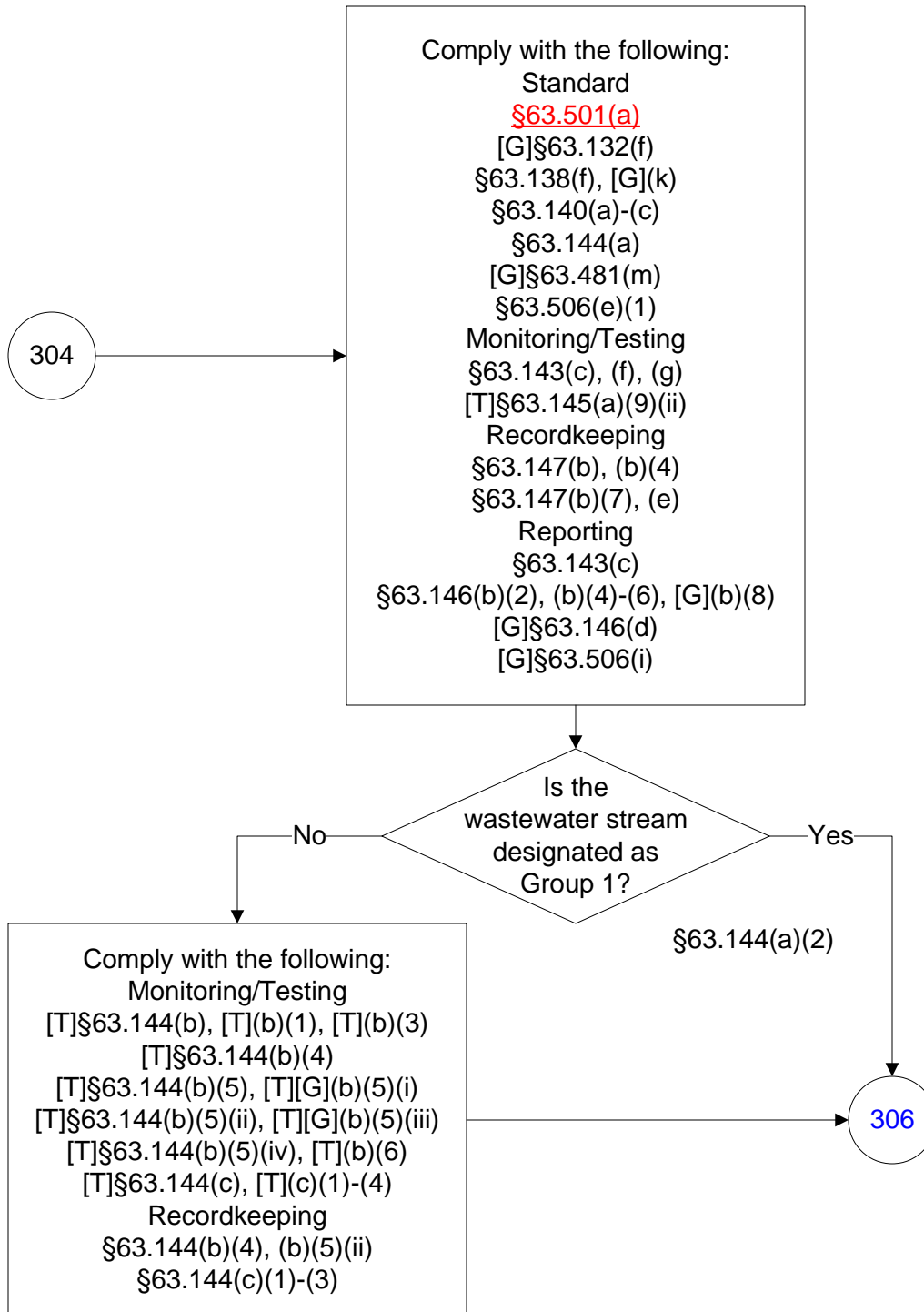

40 CFR Part 63, Subpart U

(135 of 176)

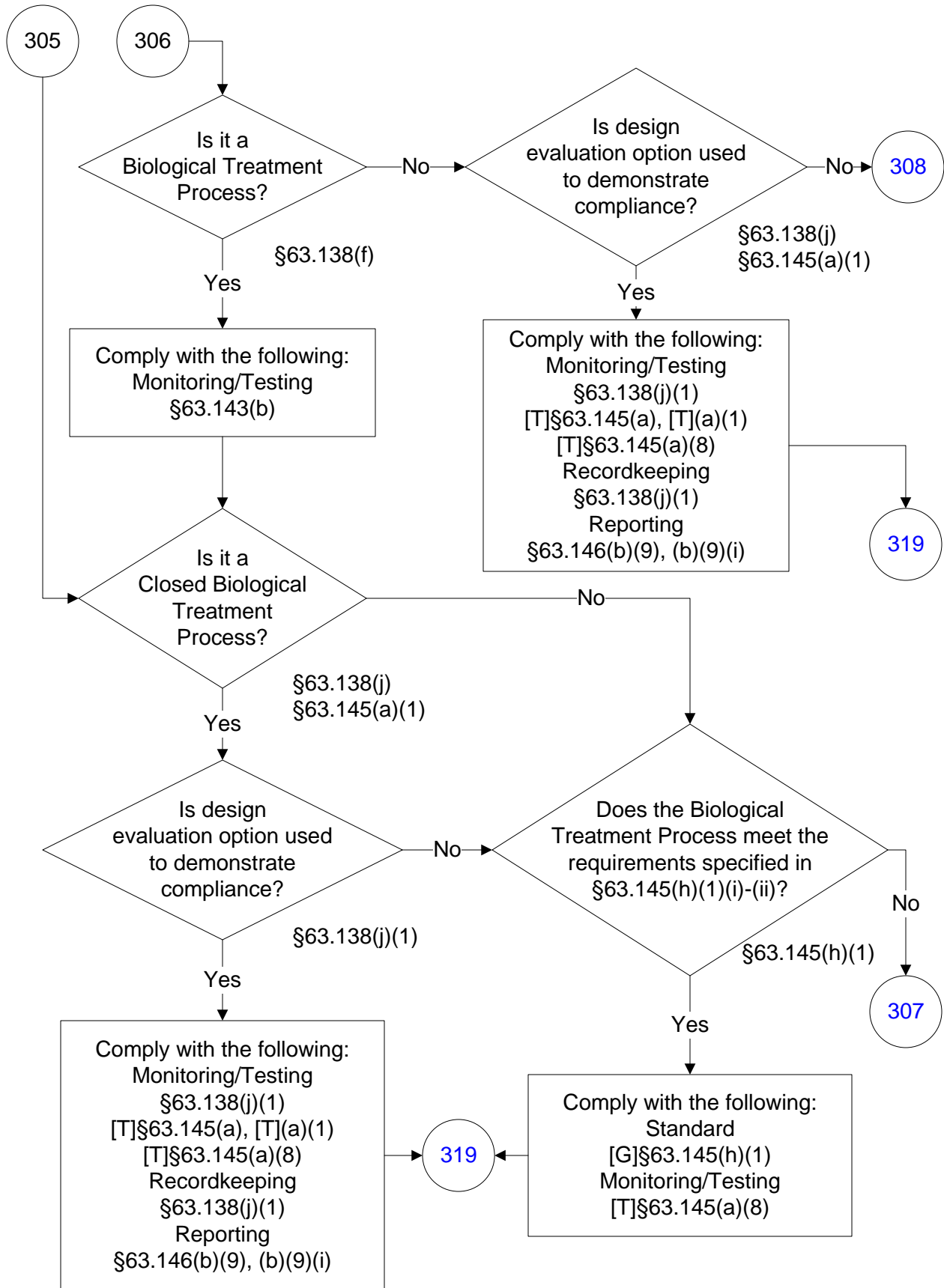

40 CFR Part 63, Subpart U

(136 of 176)

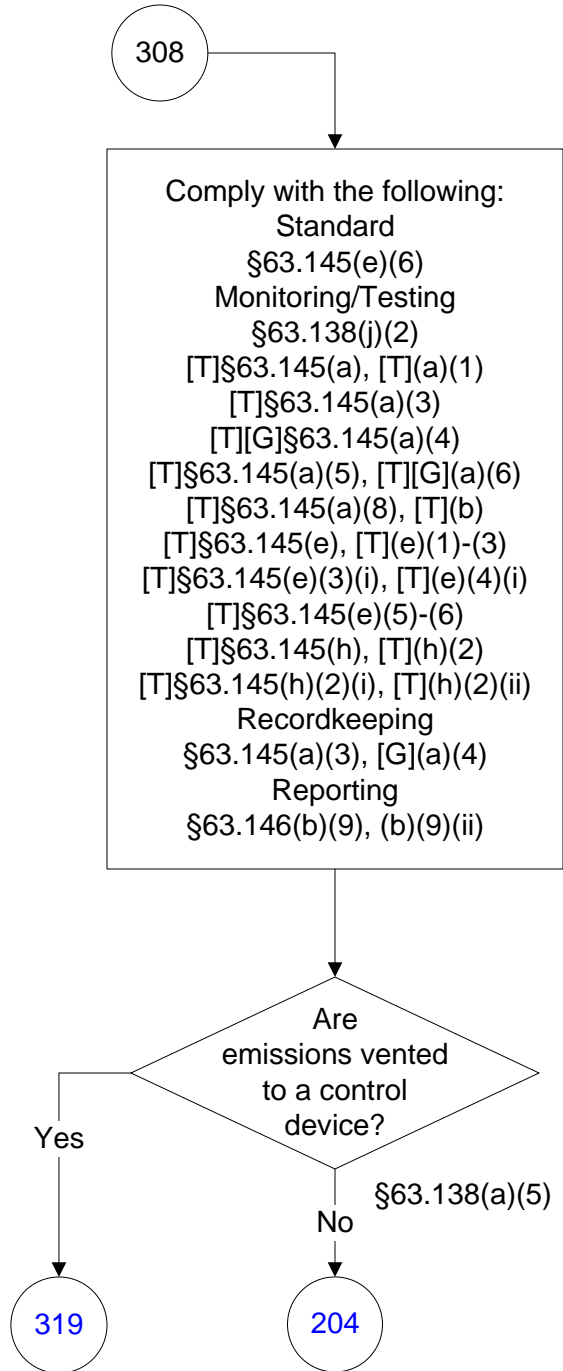
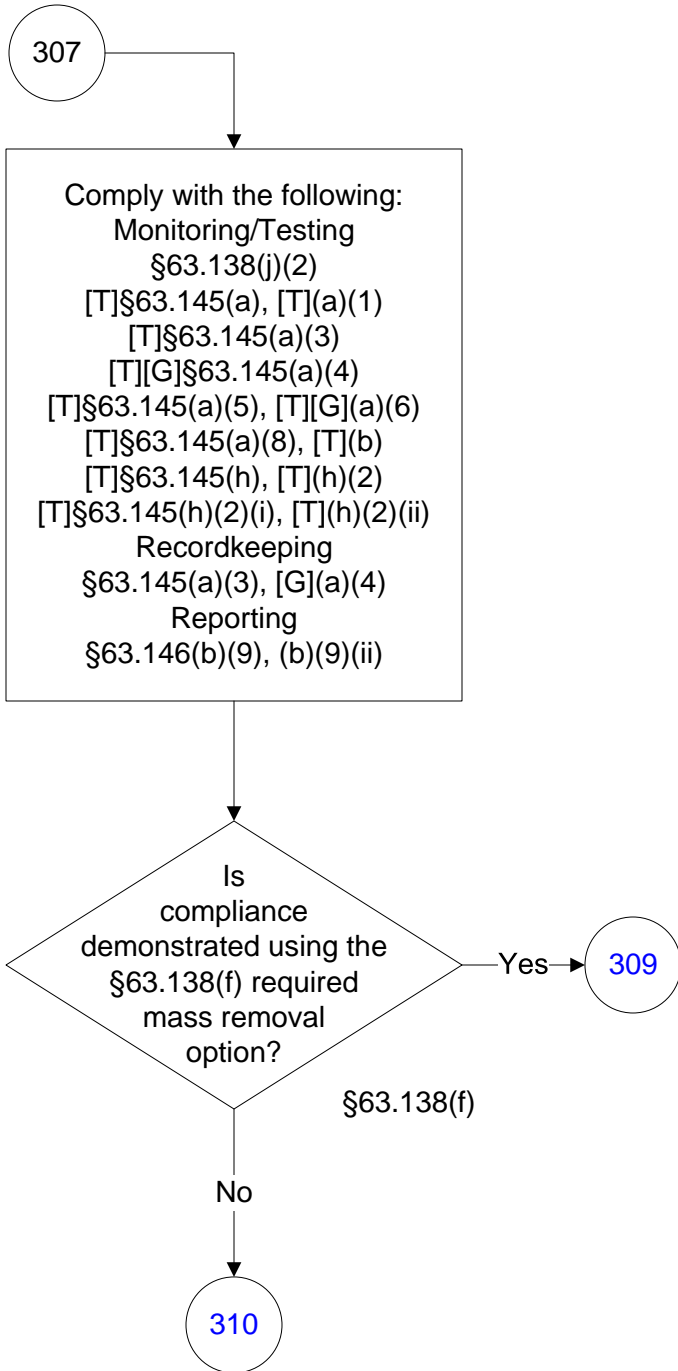

40 CFR Part 63, Subpart U

(137 of 176)

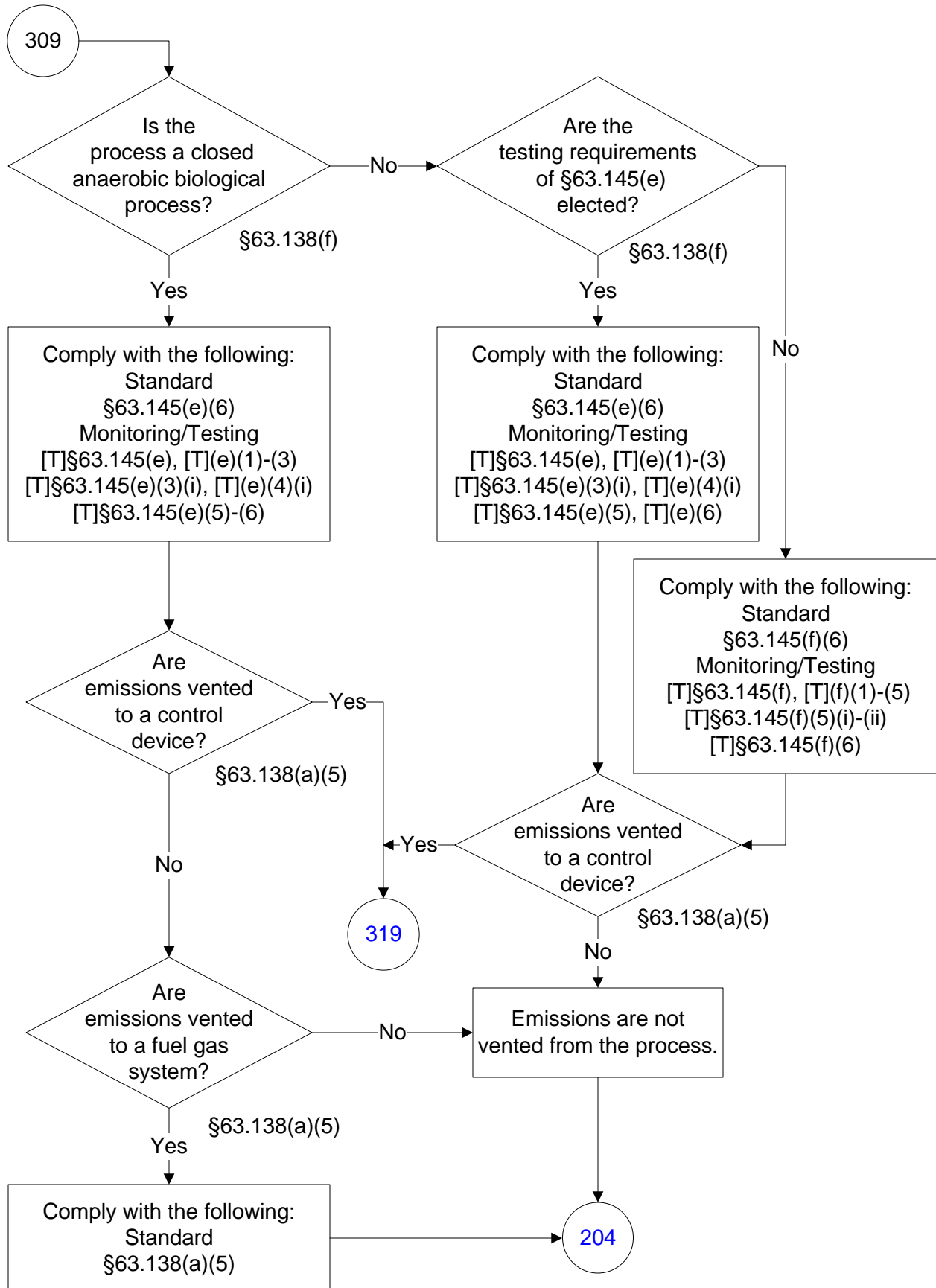

40 CFR Part 63, Subpart U

(138 of 176)

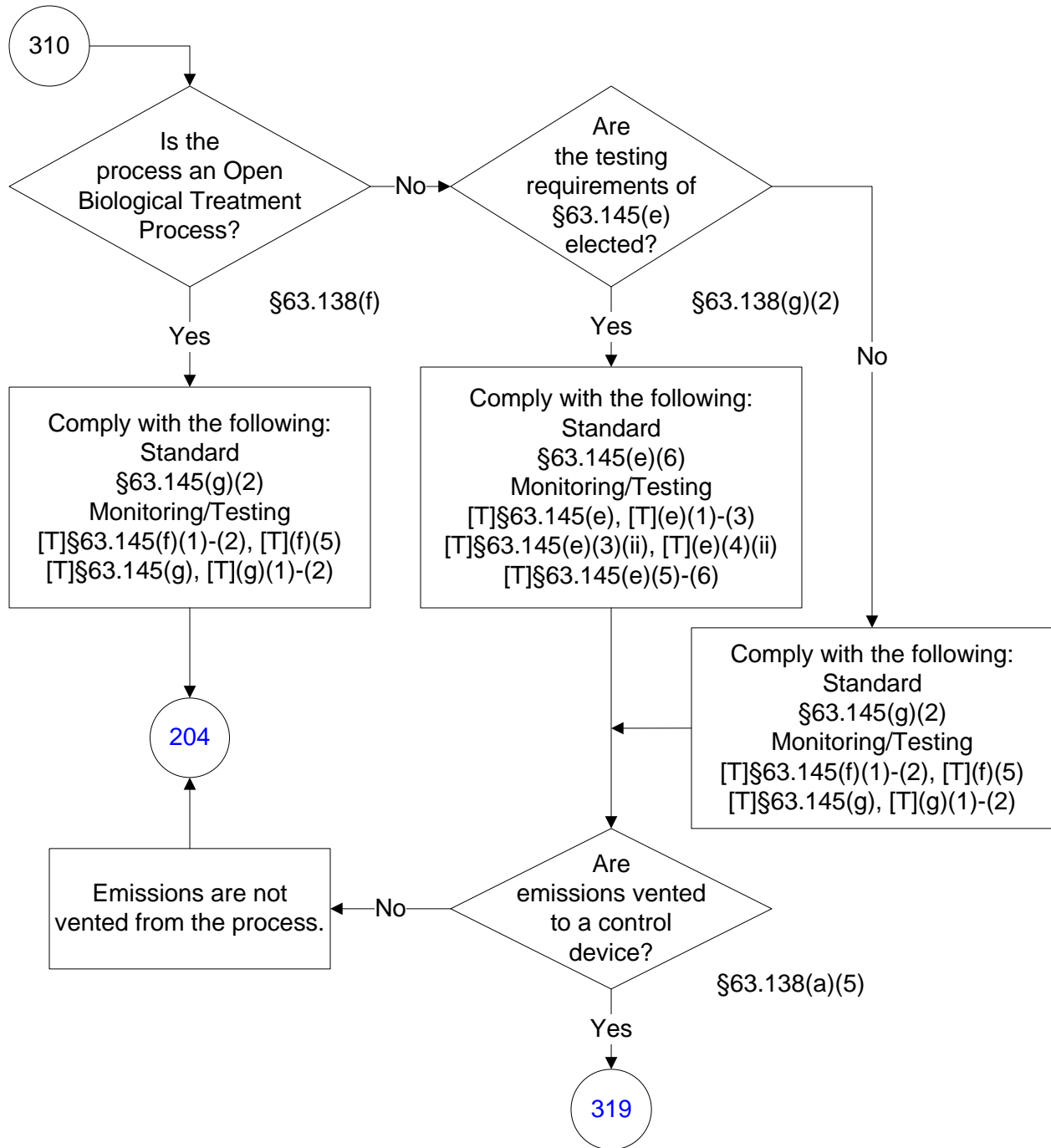

40 CFR Part 63, Subpart U (139 of 176)

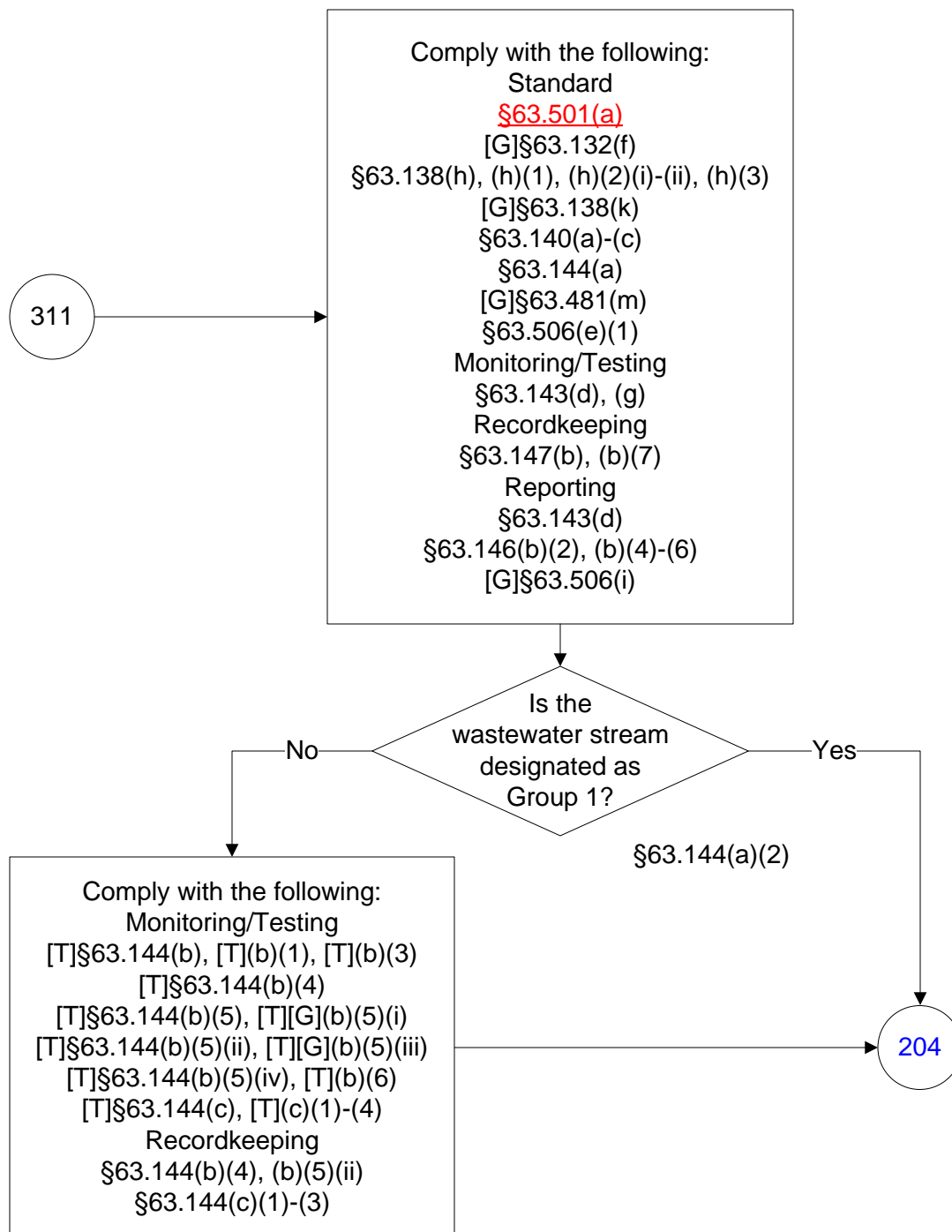

40 CFR Part 63, Subpart U

(140 of 176)

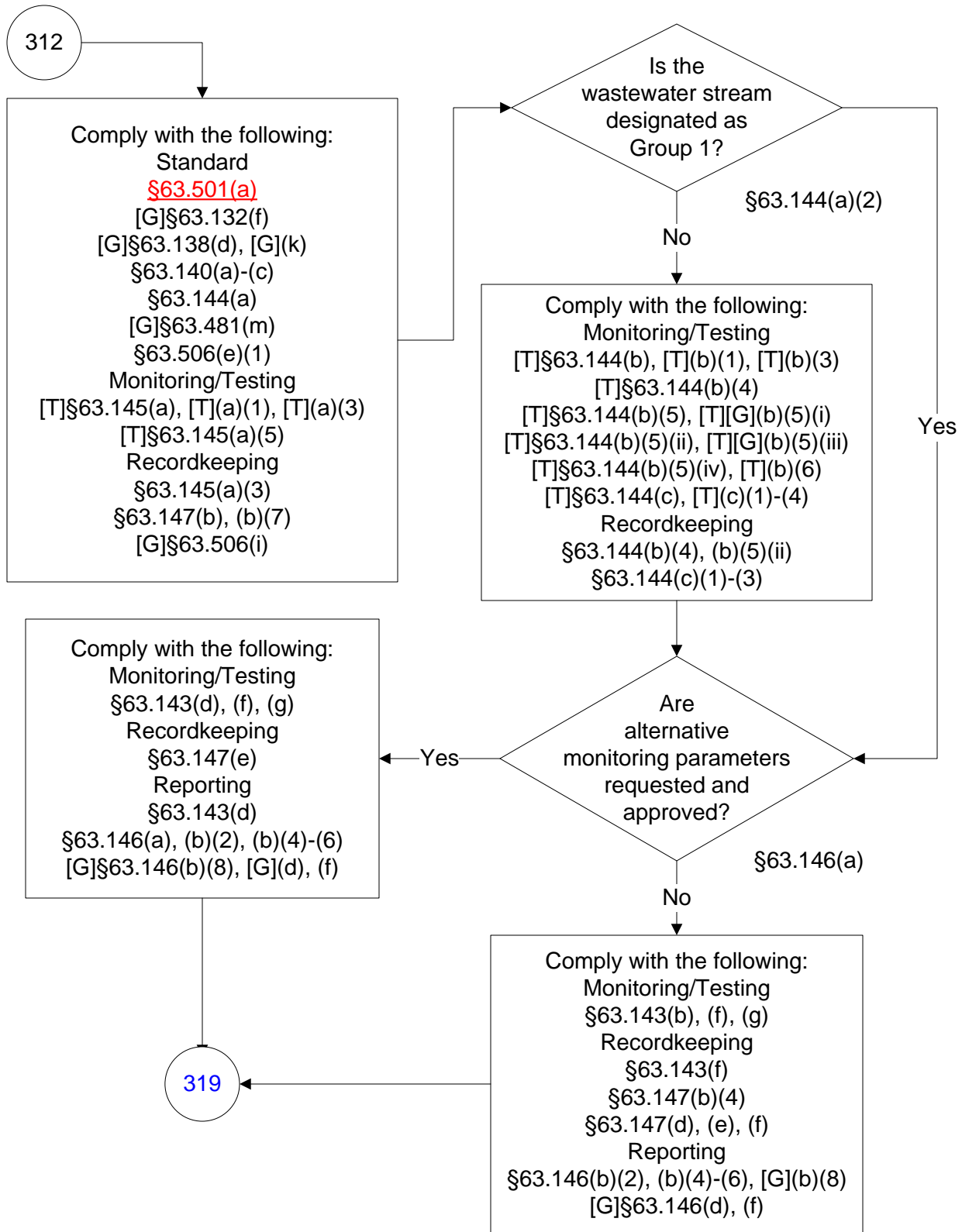

40 CFR Part 63, Subpart U

(141 of 176)

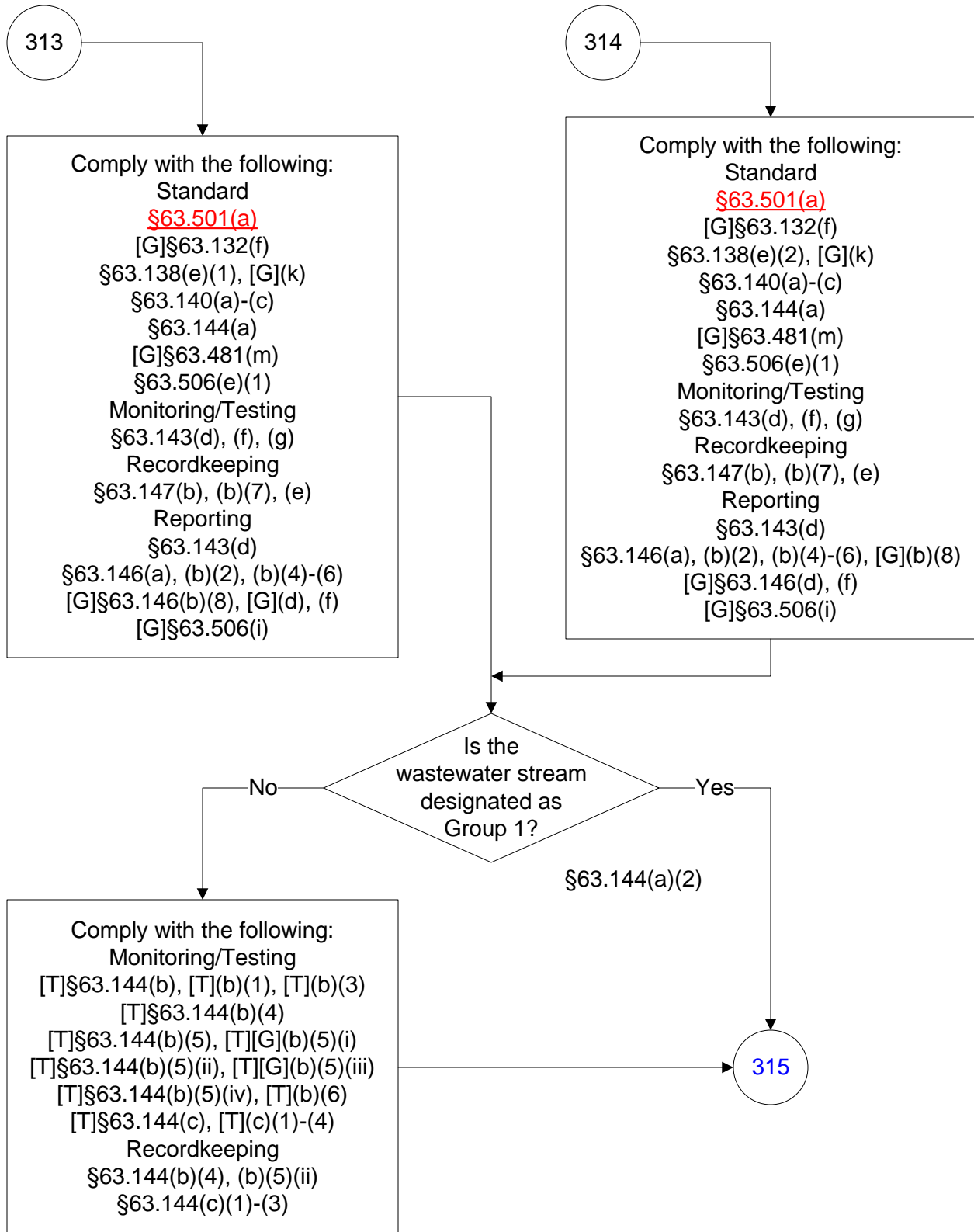

40 CFR Part 63, Subpart U

(142 of 176)

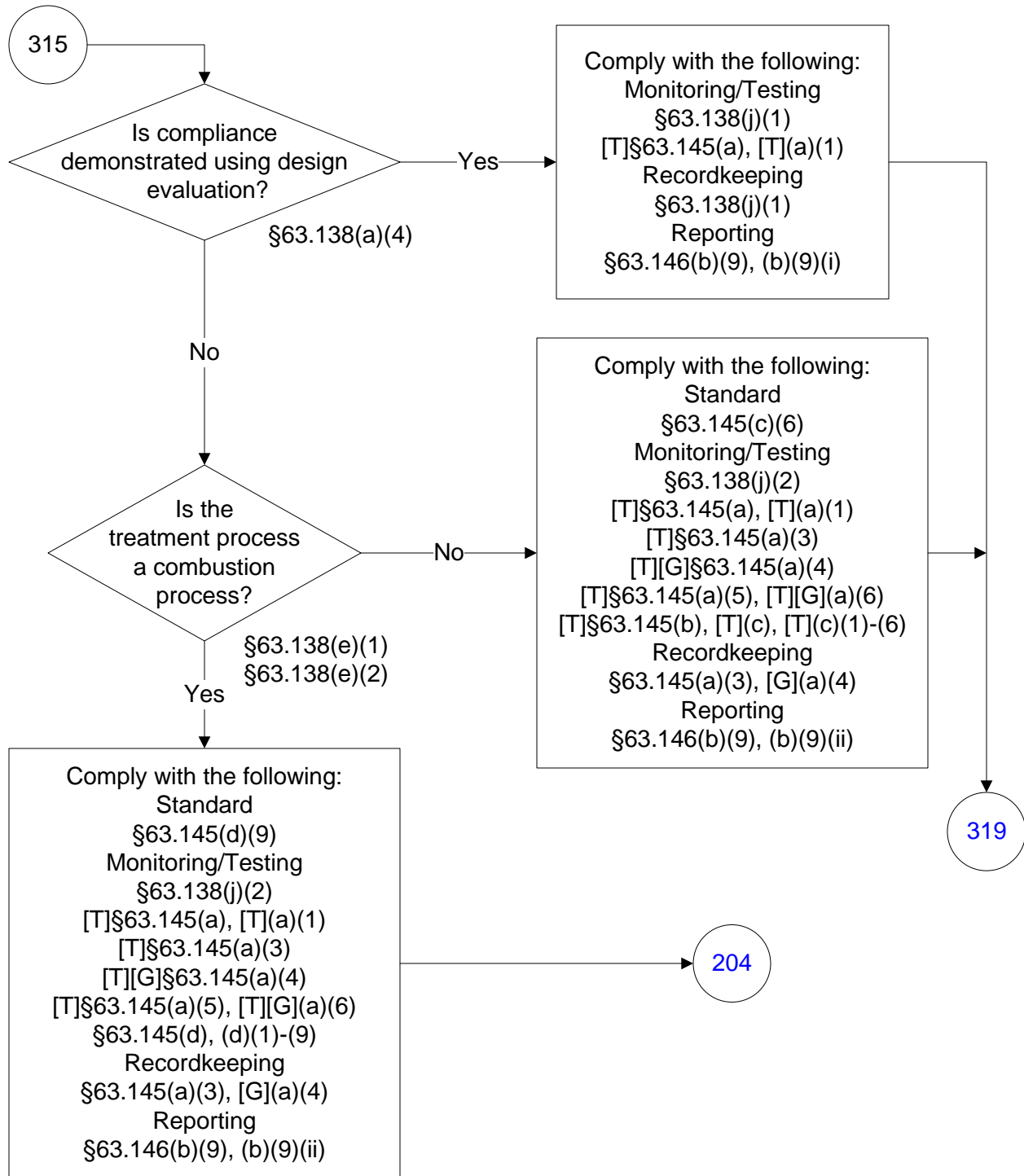

40 CFR Part 63, Subpart U

(143 of 176)

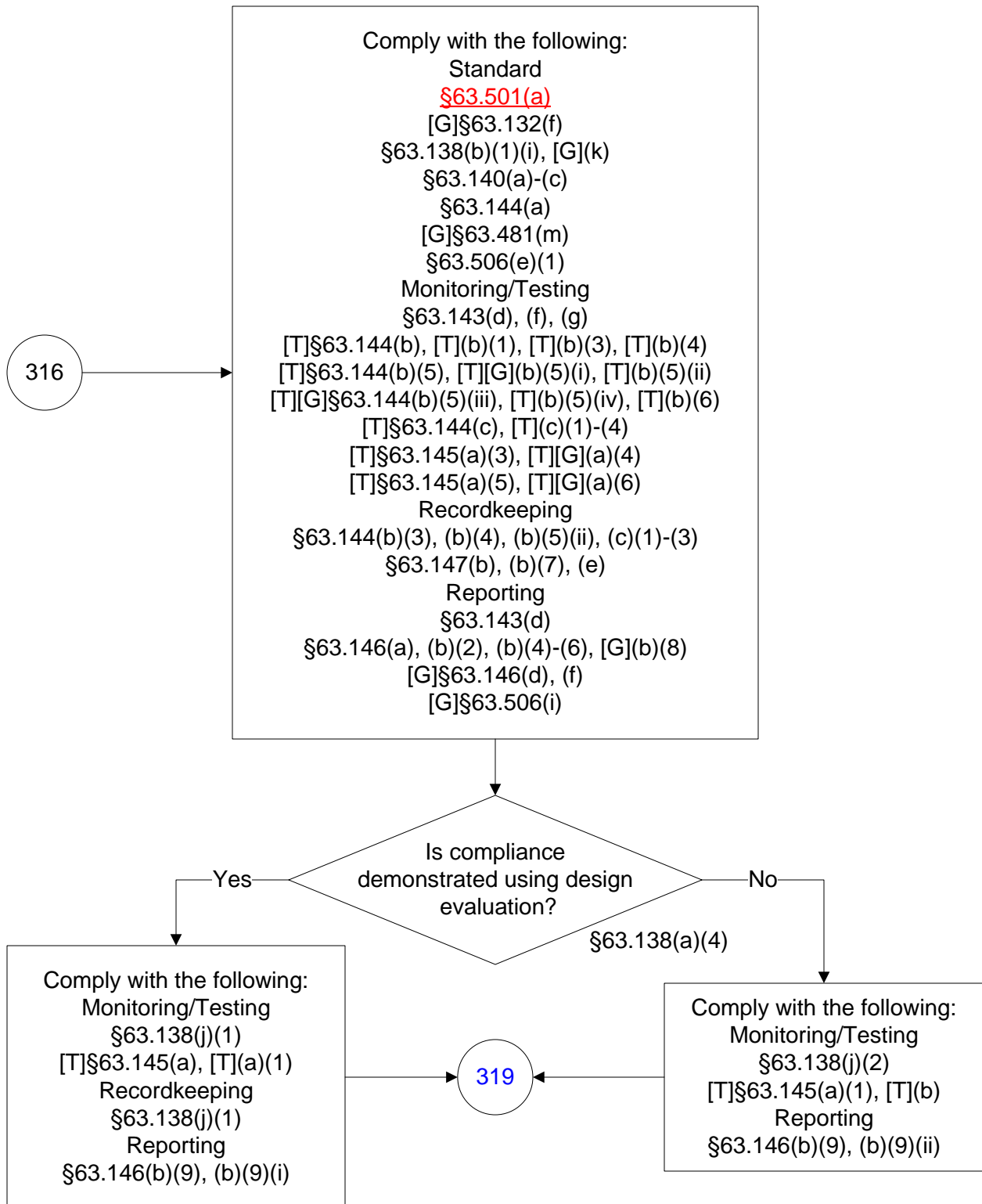

40 CFR Part 63, Subpart U

(144 of 176)

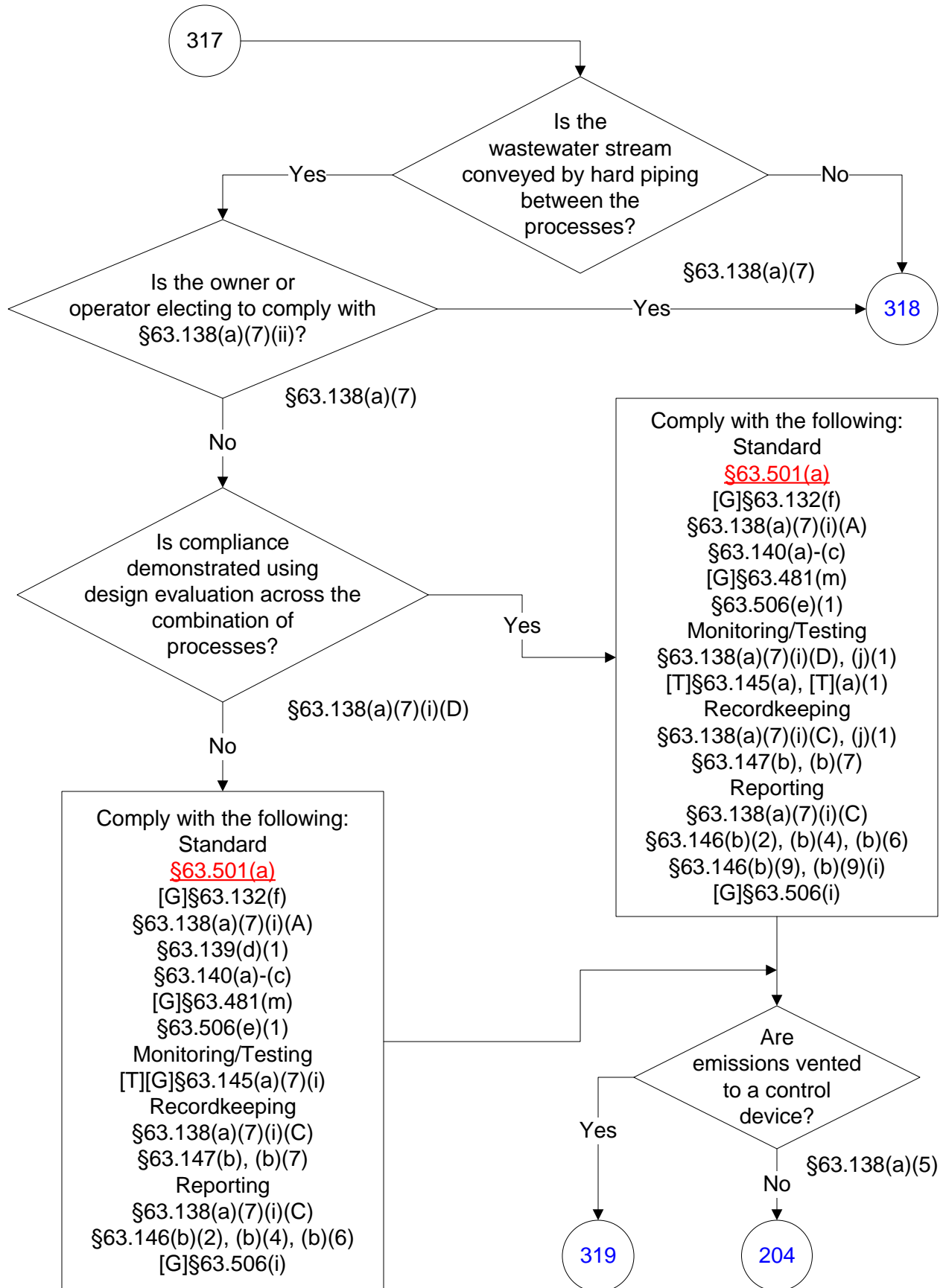

40 CFR Part 63, Subpart U

(145 of 176)

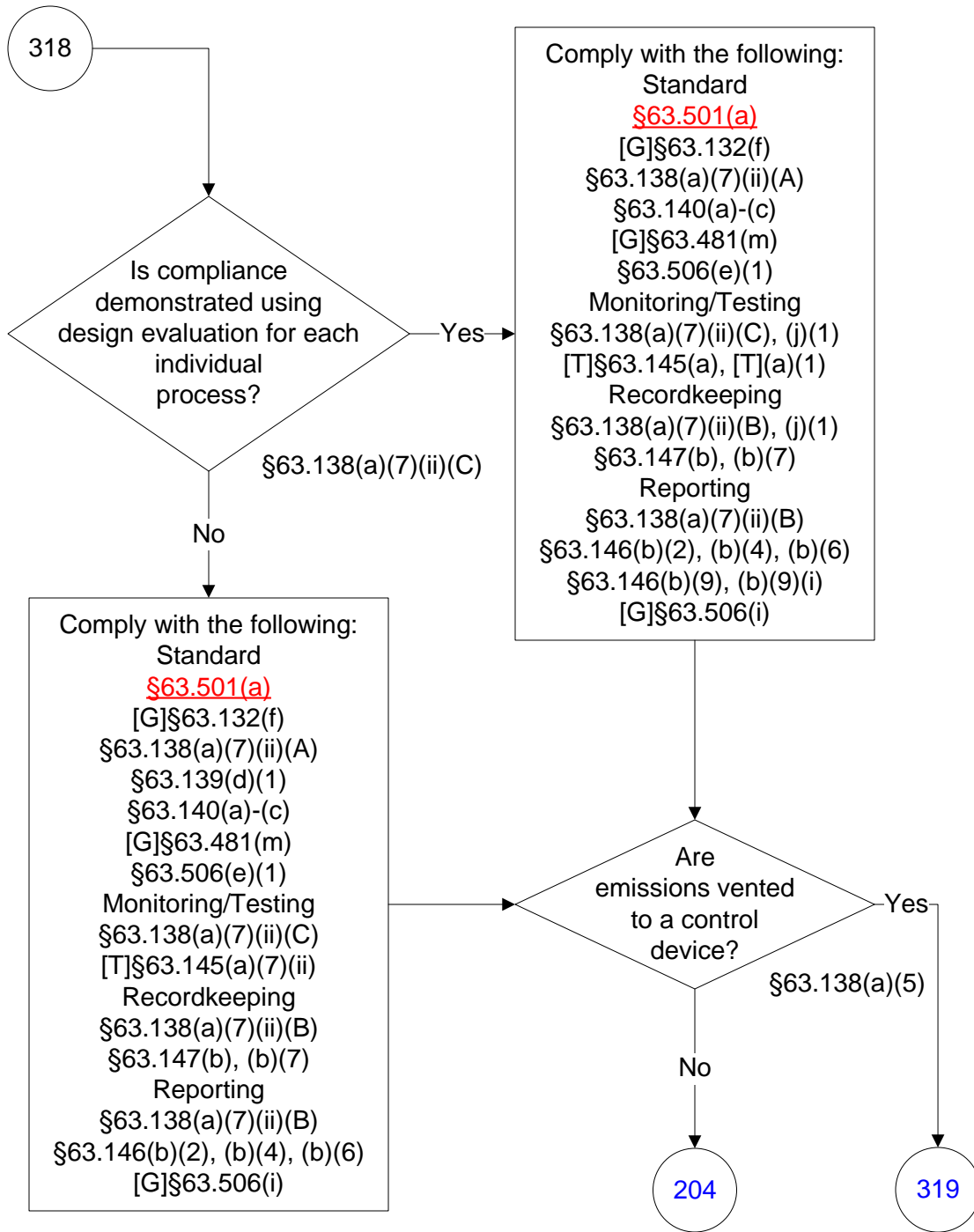

40 CFR Part 63, Subpart U

(146 of 176)

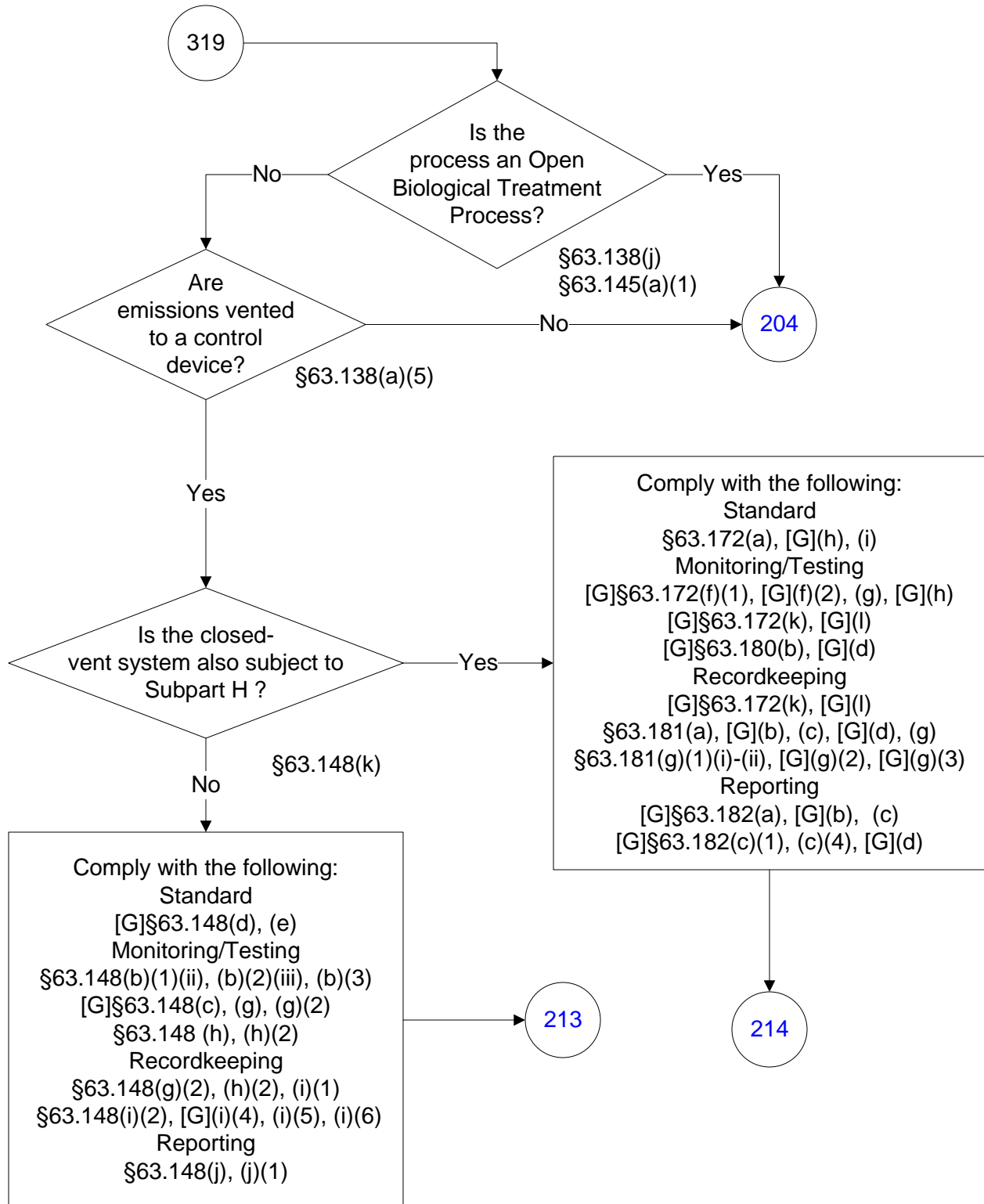

40 CFR Part 63, Subpart U

(147 of 176)

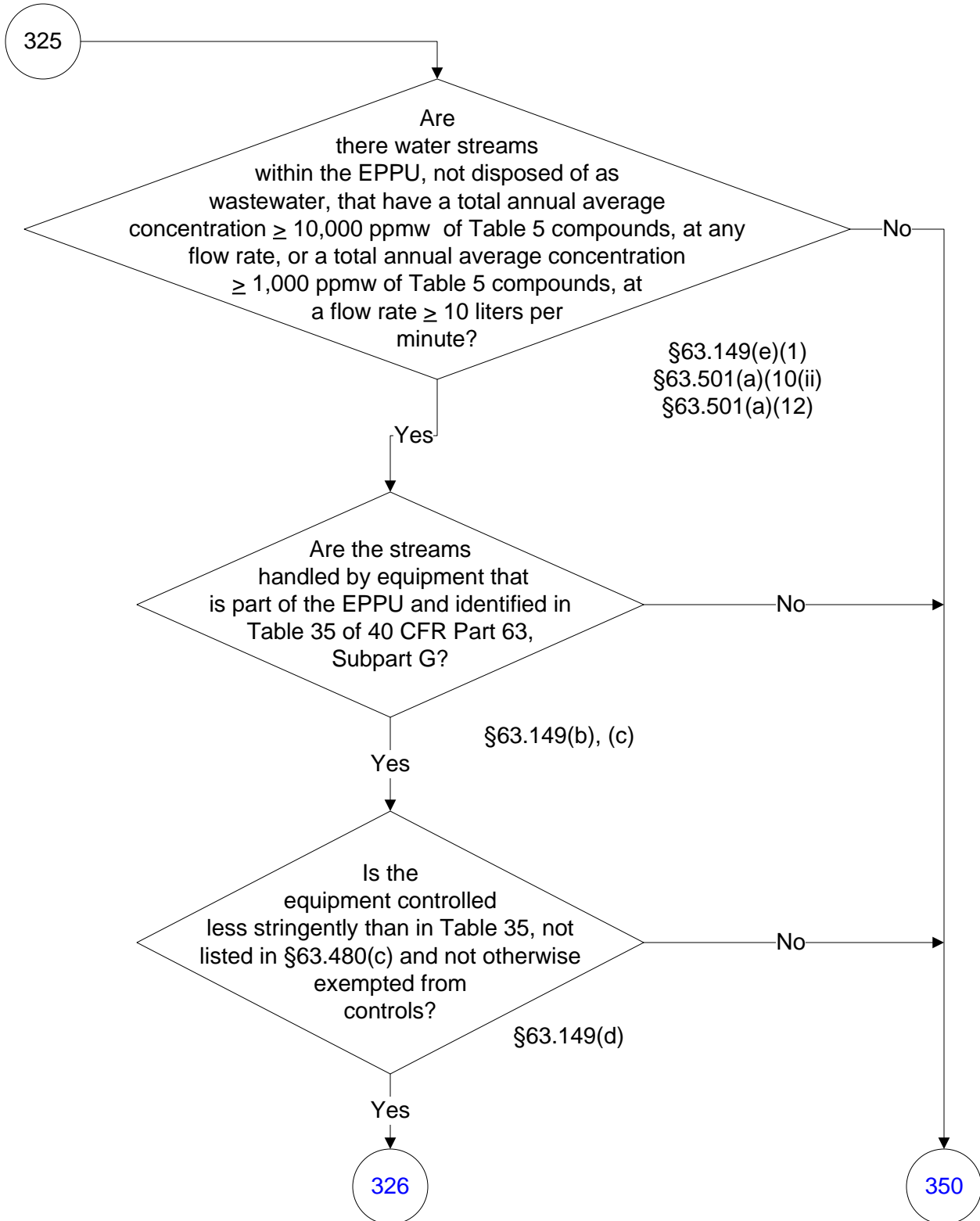

40 CFR Part 63, Subpart U

(148 of 176)

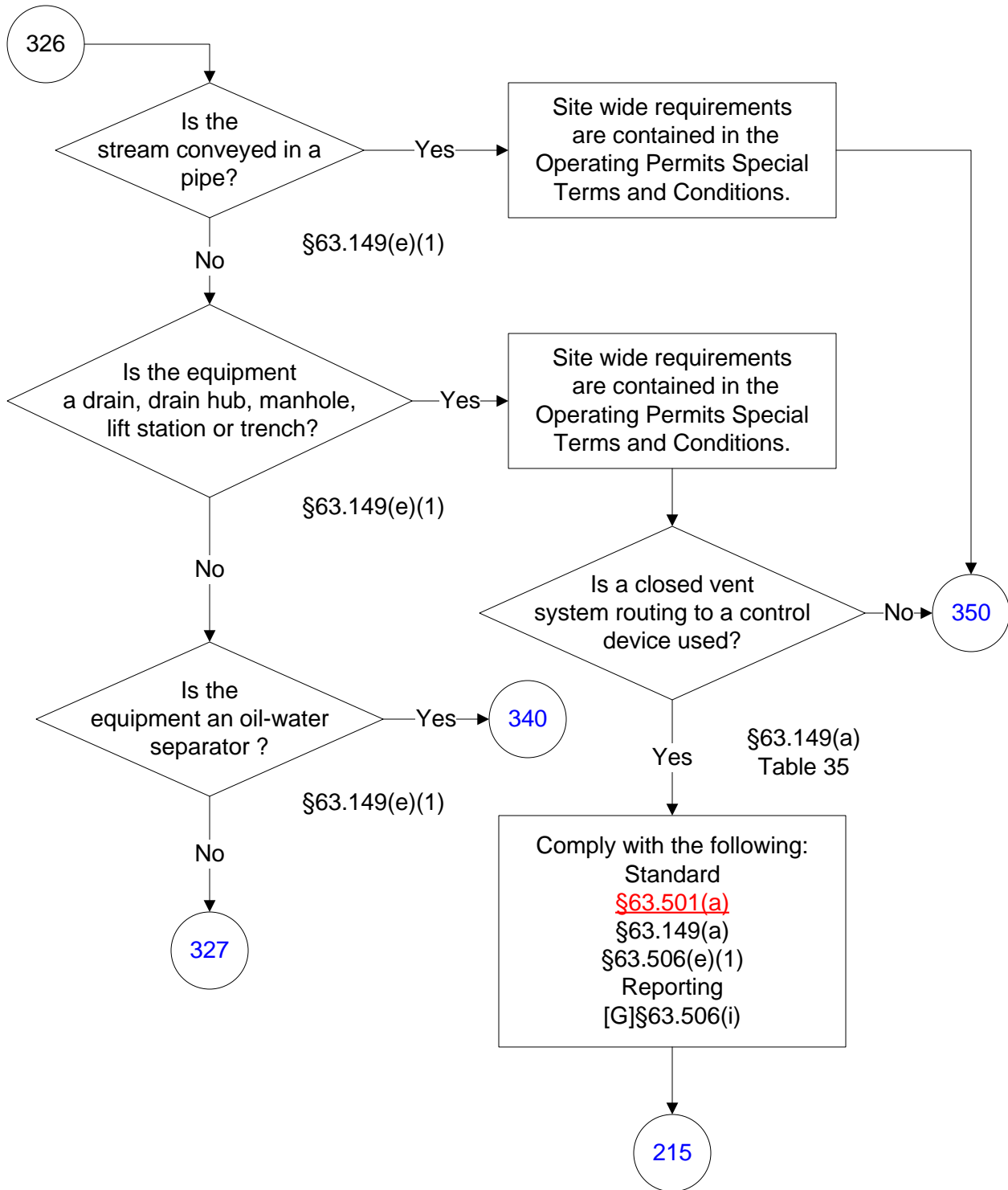

40 CFR Part 63, Subpart U

(149 of 176)

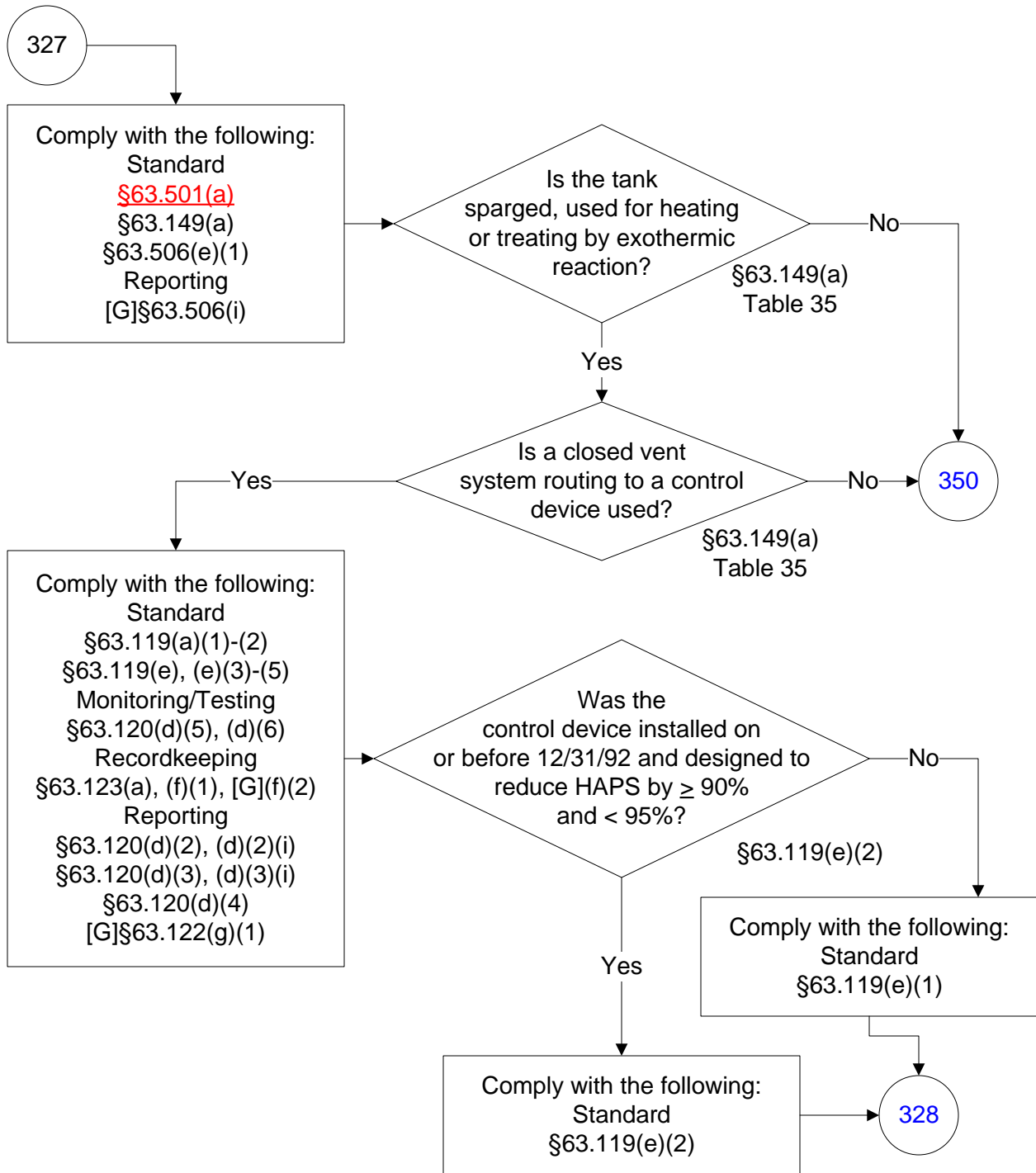

40 CFR Part 63, Subpart U

(150 of 176)

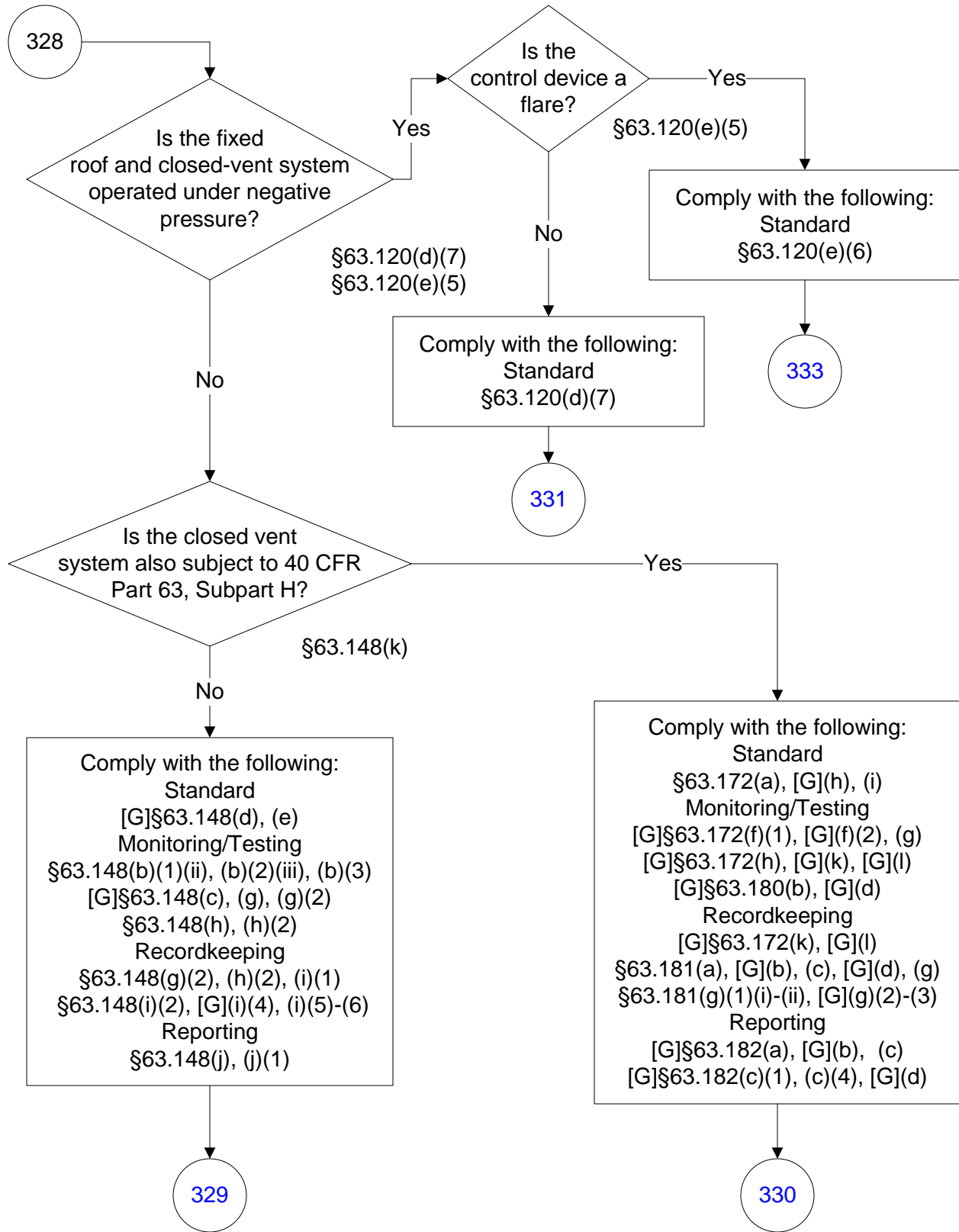

40 CFR Part 63, Subpart U

(151 of 176)

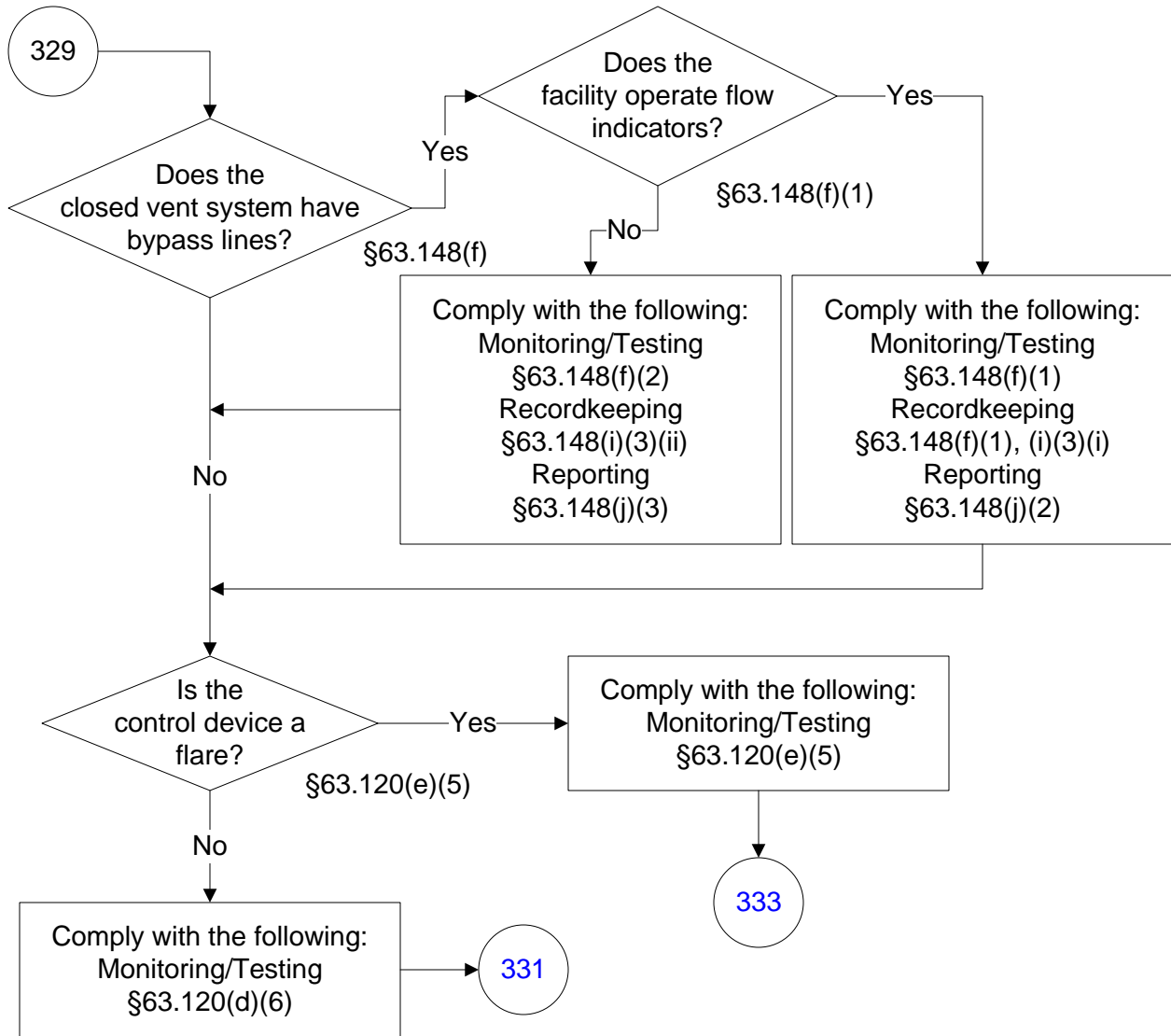

40 CFR Part 63, Subpart U

(152 of 176)

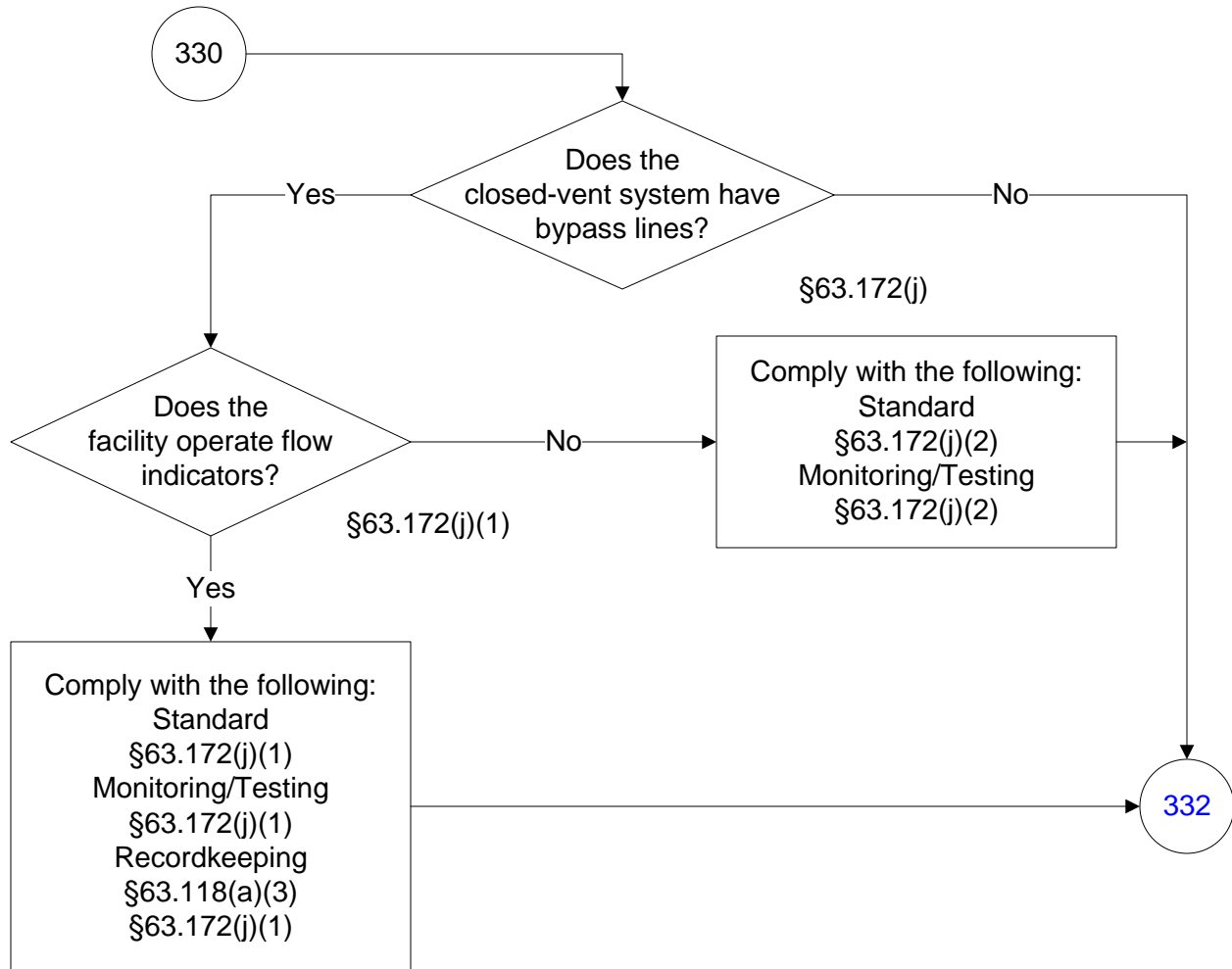

40 CFR Part 63, Subpart U

(153 of 176)

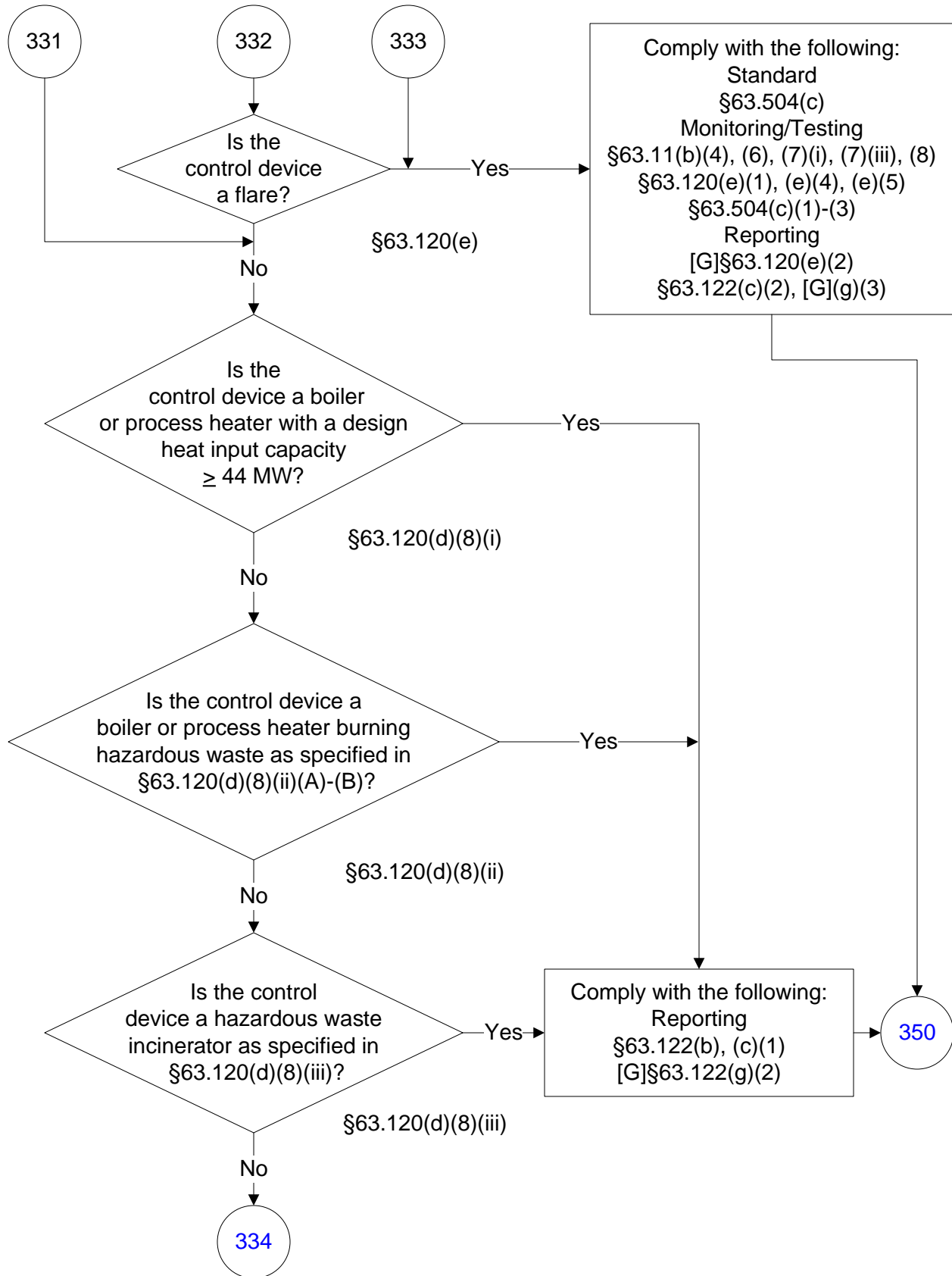

40 CFR Part 63, Subpart U

(154 of 176)

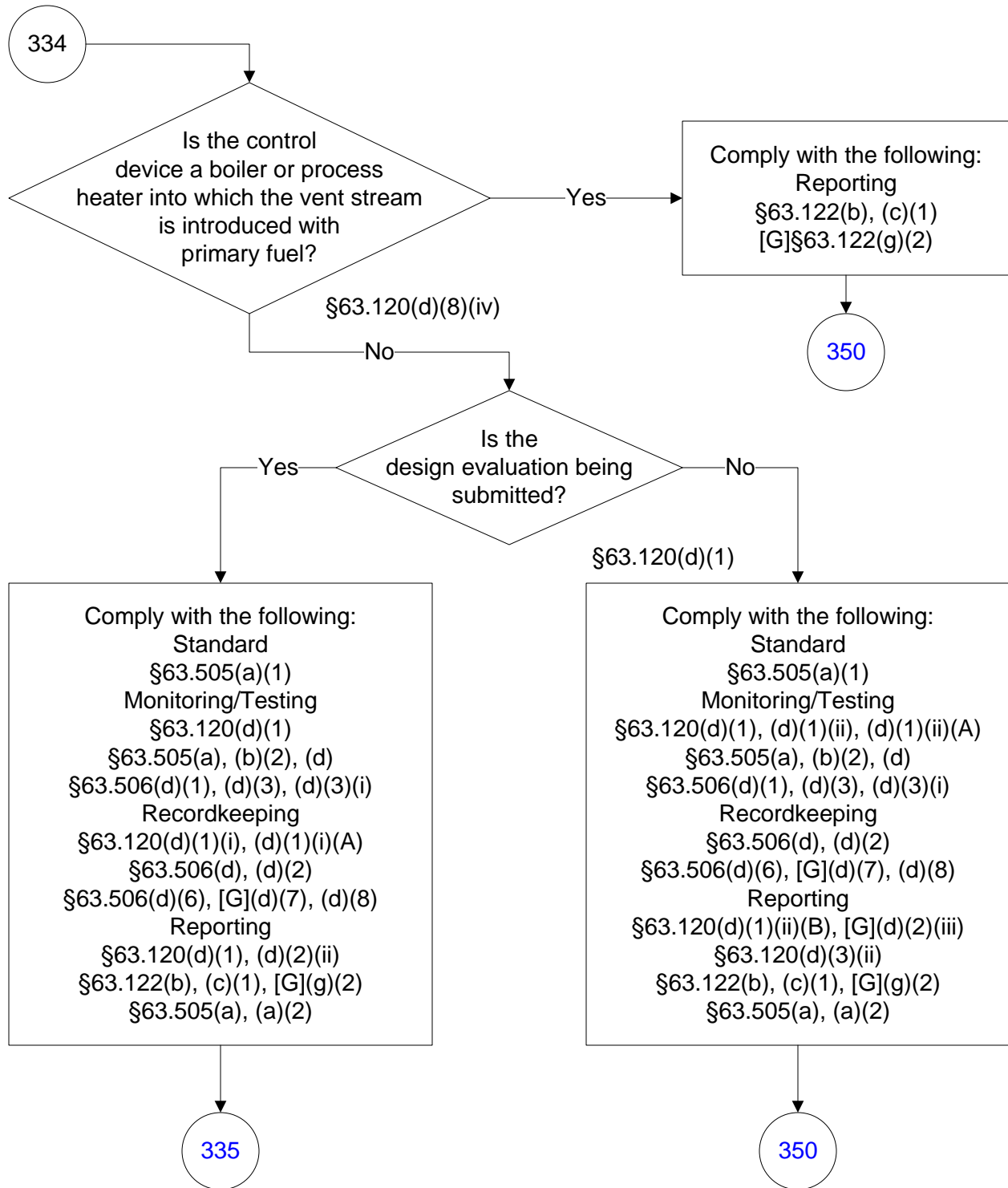

40 CFR Part 63, Subpart U

(155 of 176)

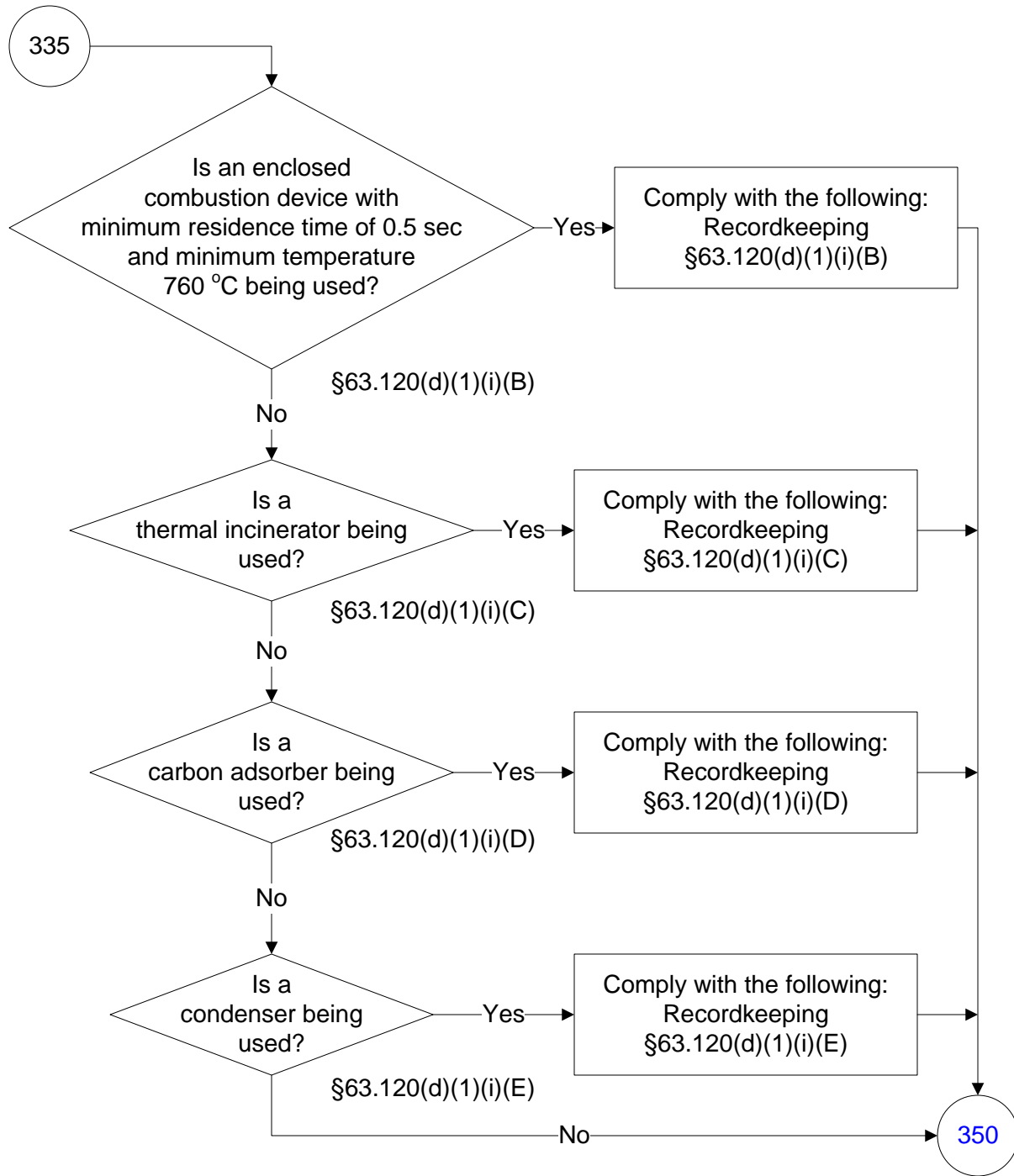

40 CFR Part 63, Subpart U

(156 of 176)

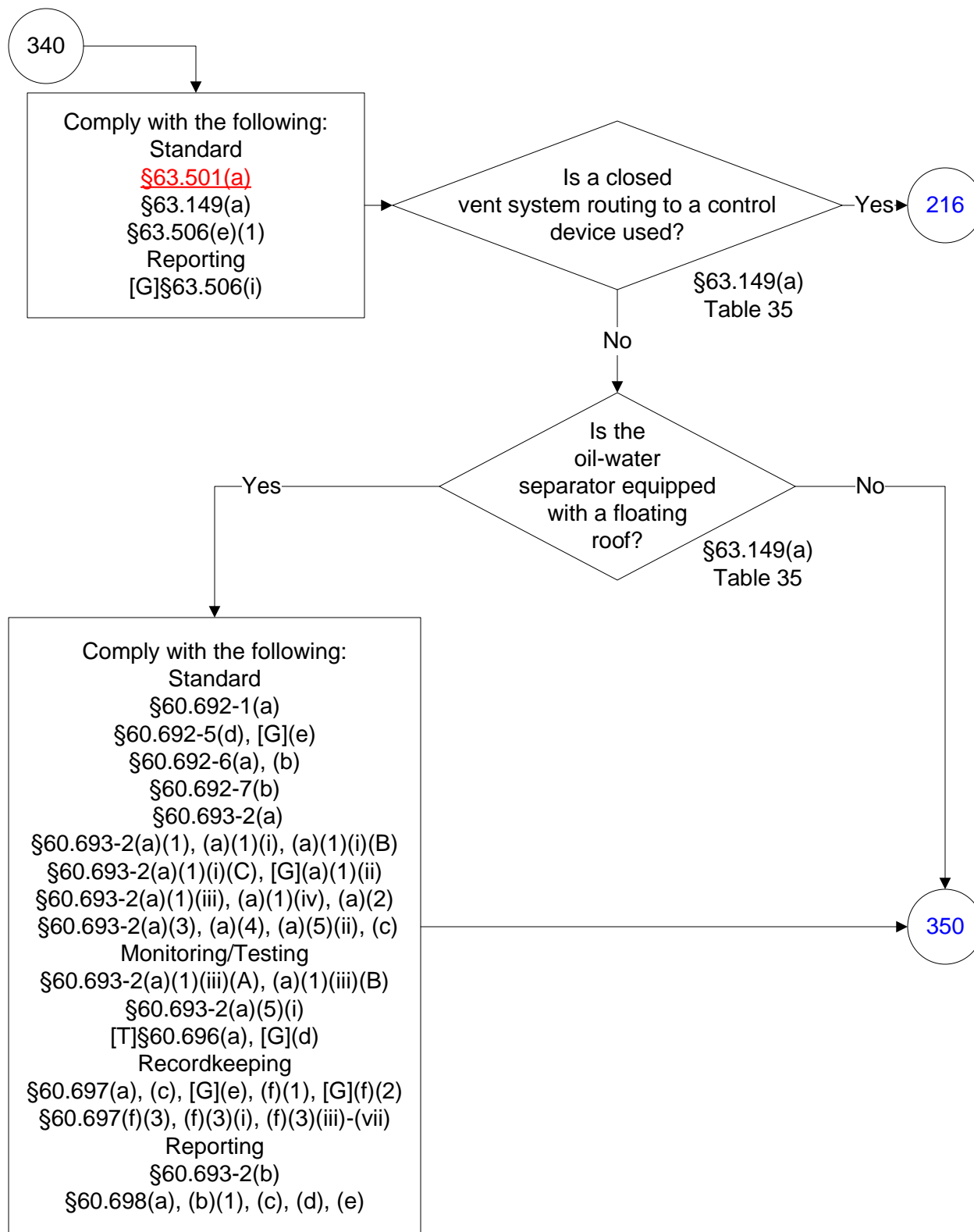

40 CFR Part 63, Subpart U

(157 of 176)

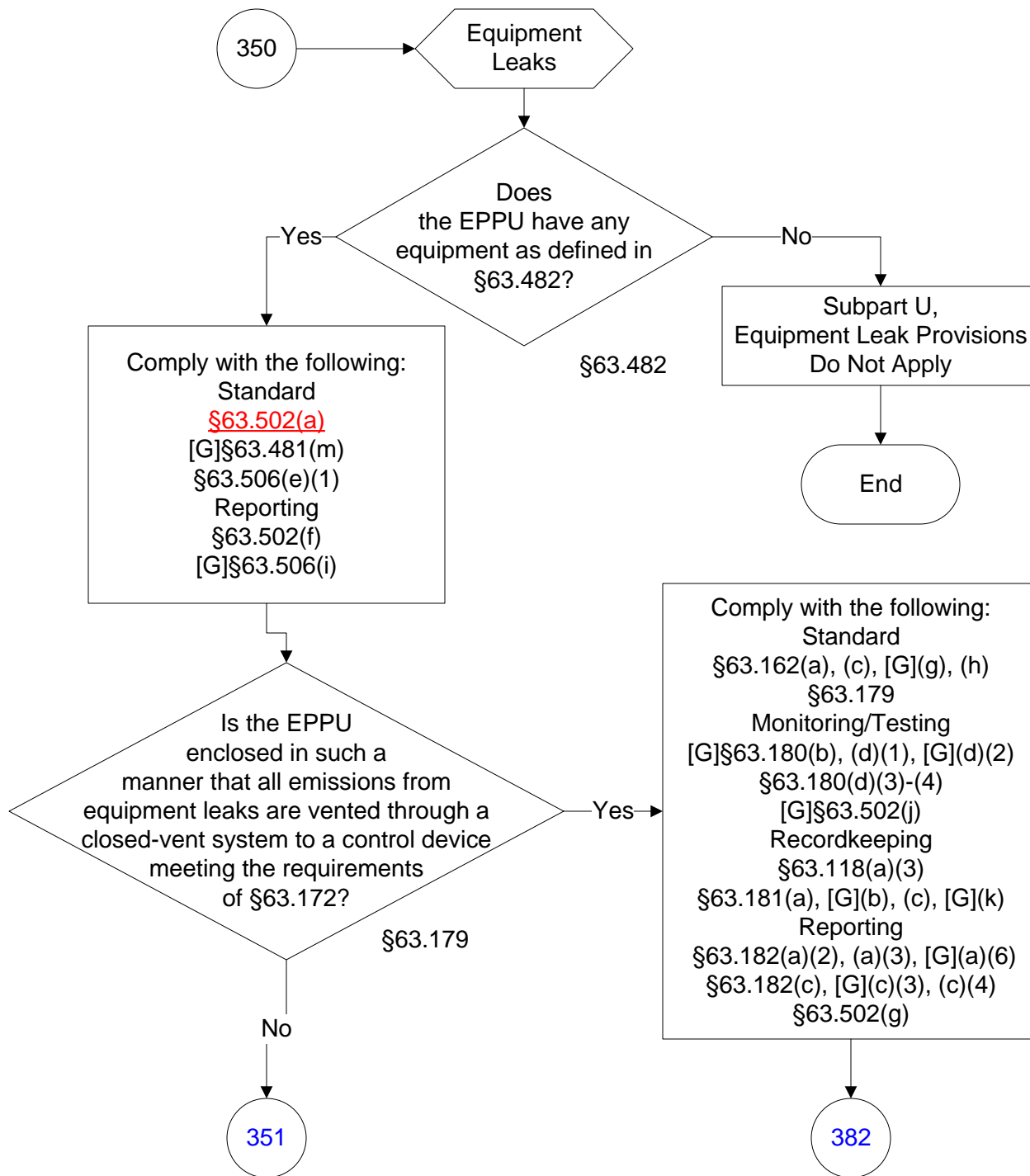

40 CFR Part 63, Subpart U

(158 of 176)

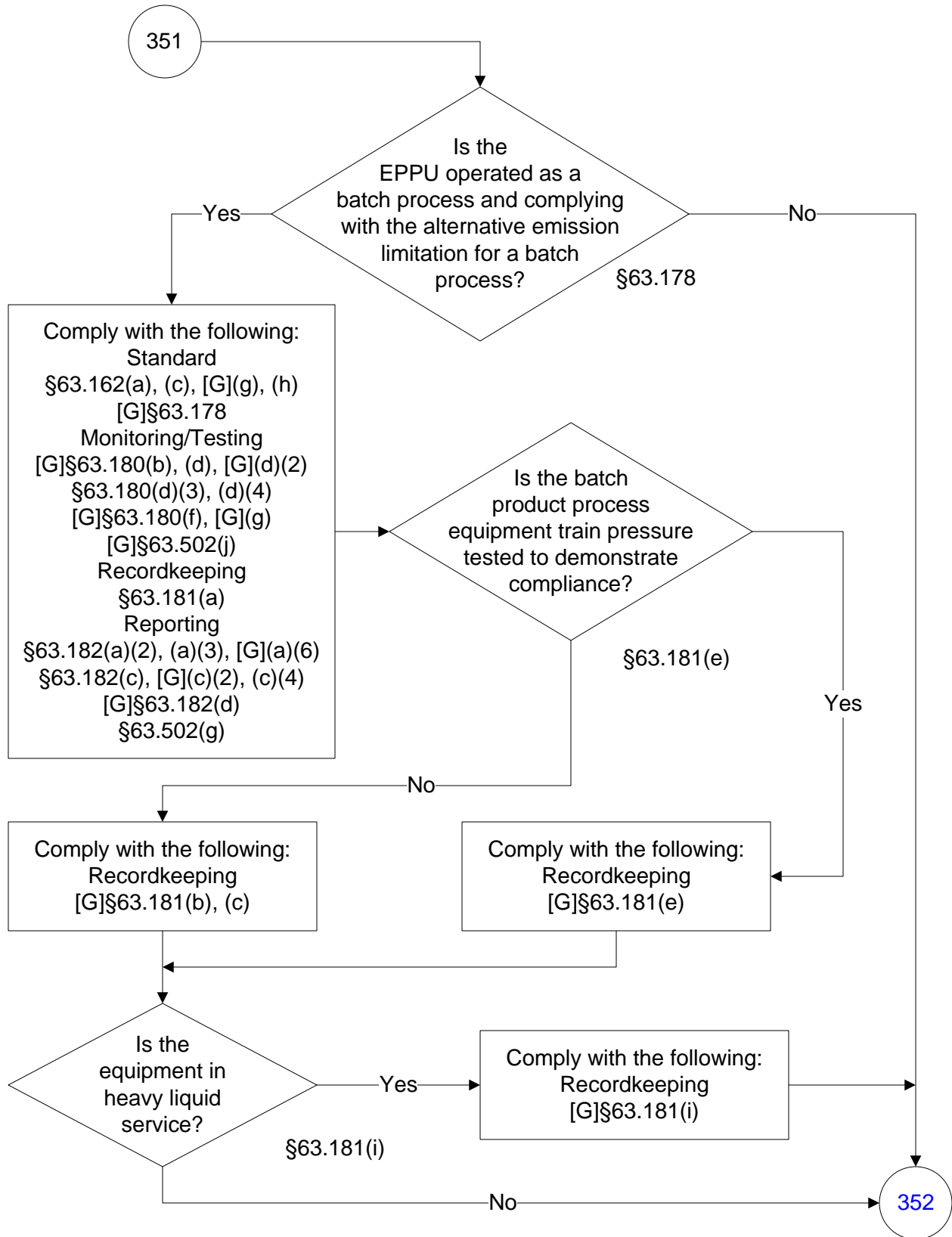

40 CFR Part 63, Subpart U

(159 of 176)

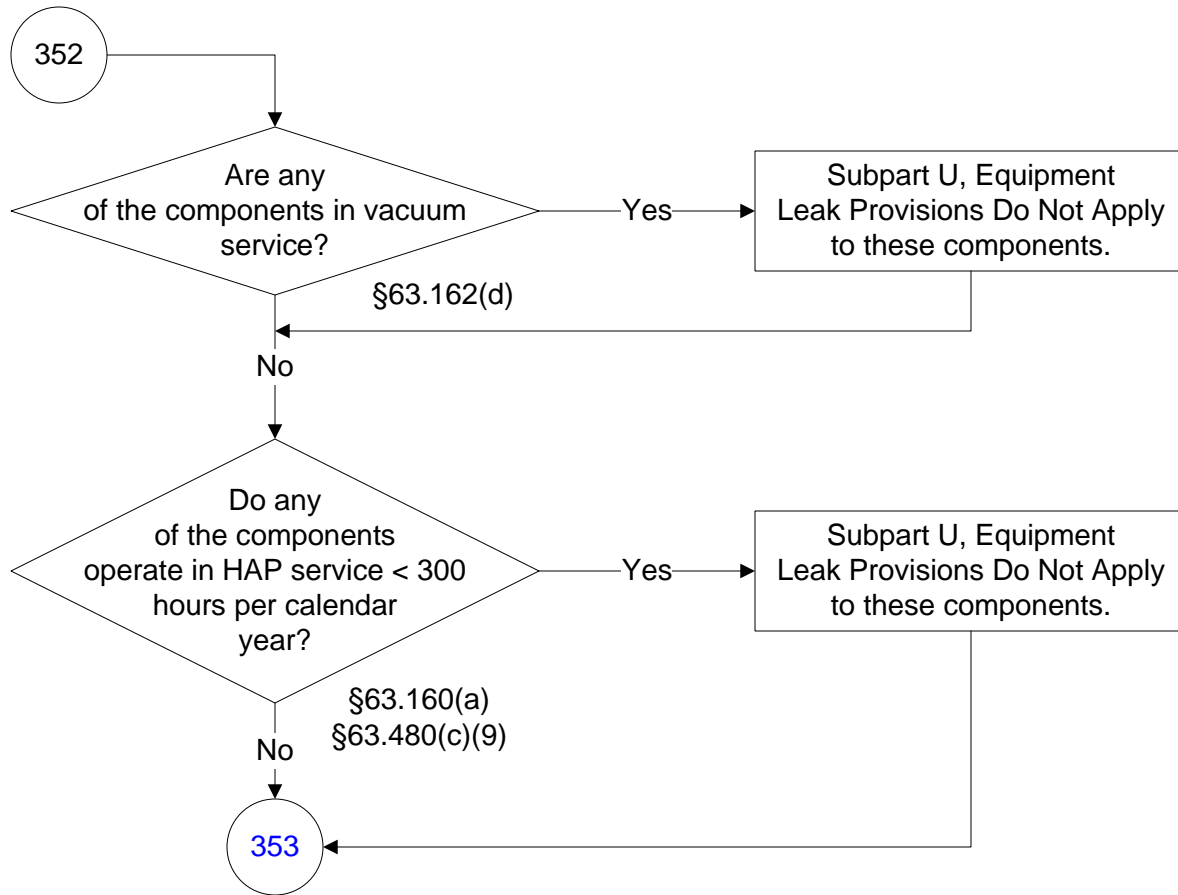

40 CFR Part 63, Subpart U

(160 of 176)

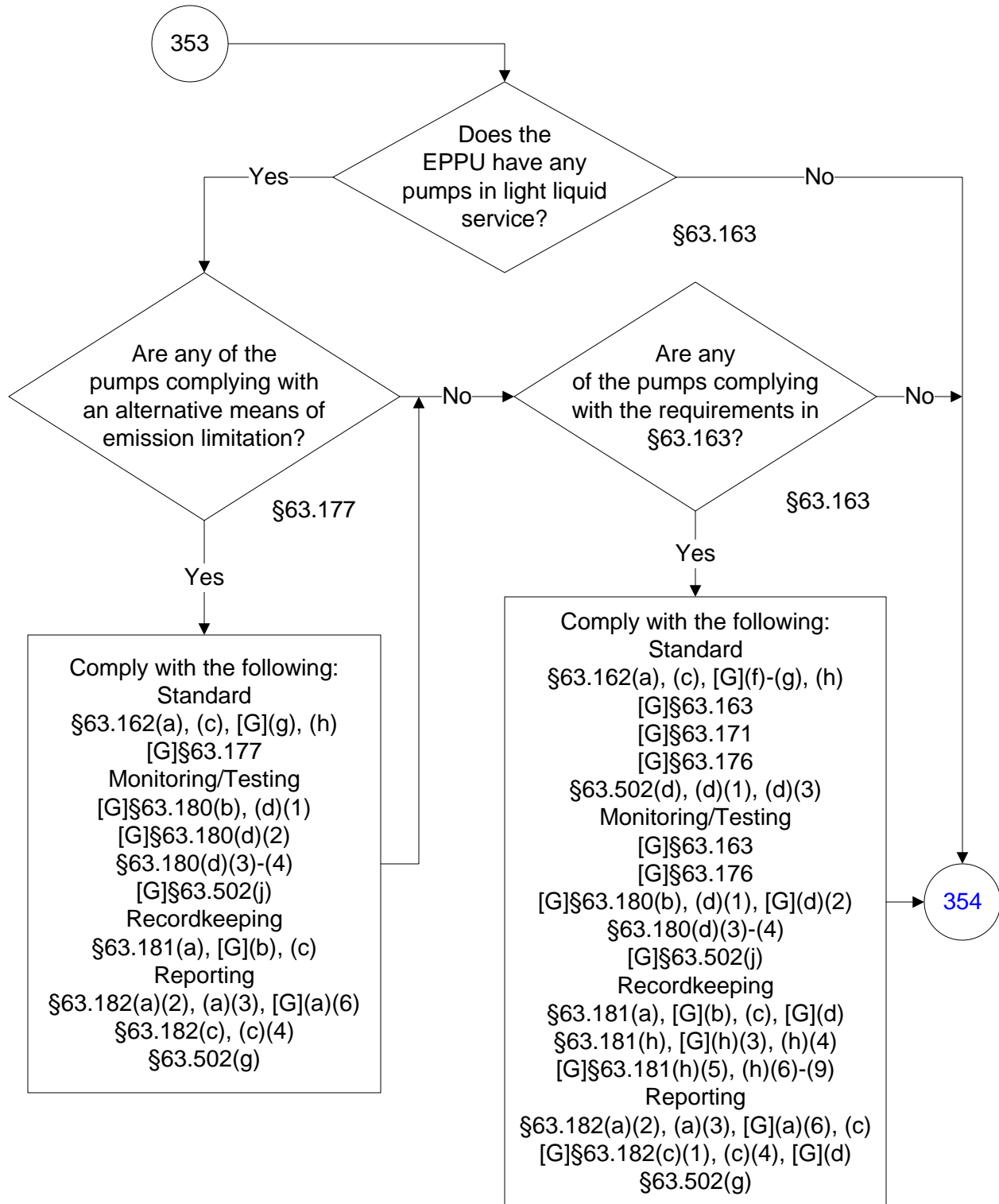

40 CFR Part 63, Subpart U

(161 of 176)

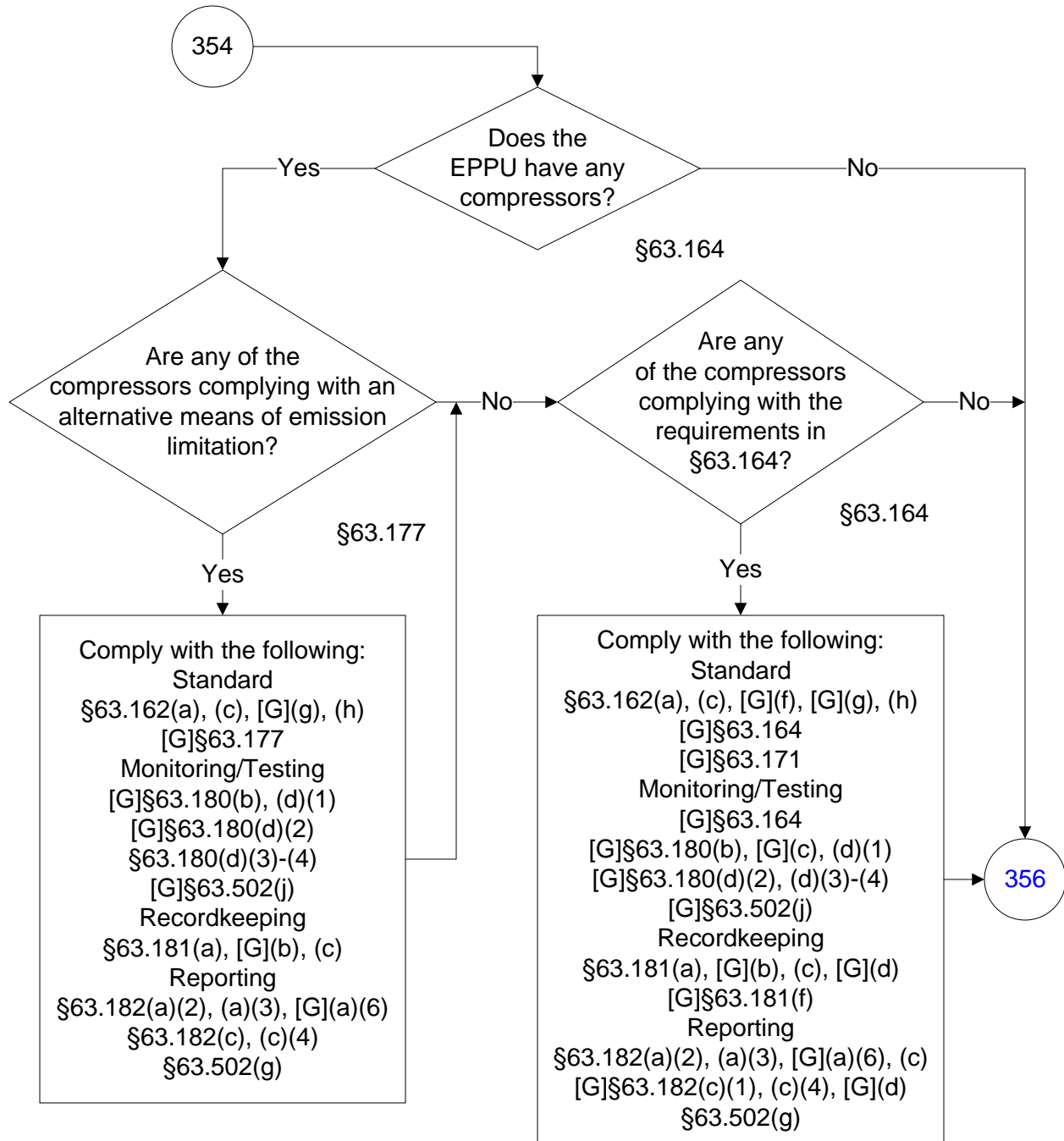

40 CFR Part 63, Subpart U

(162 of 176)

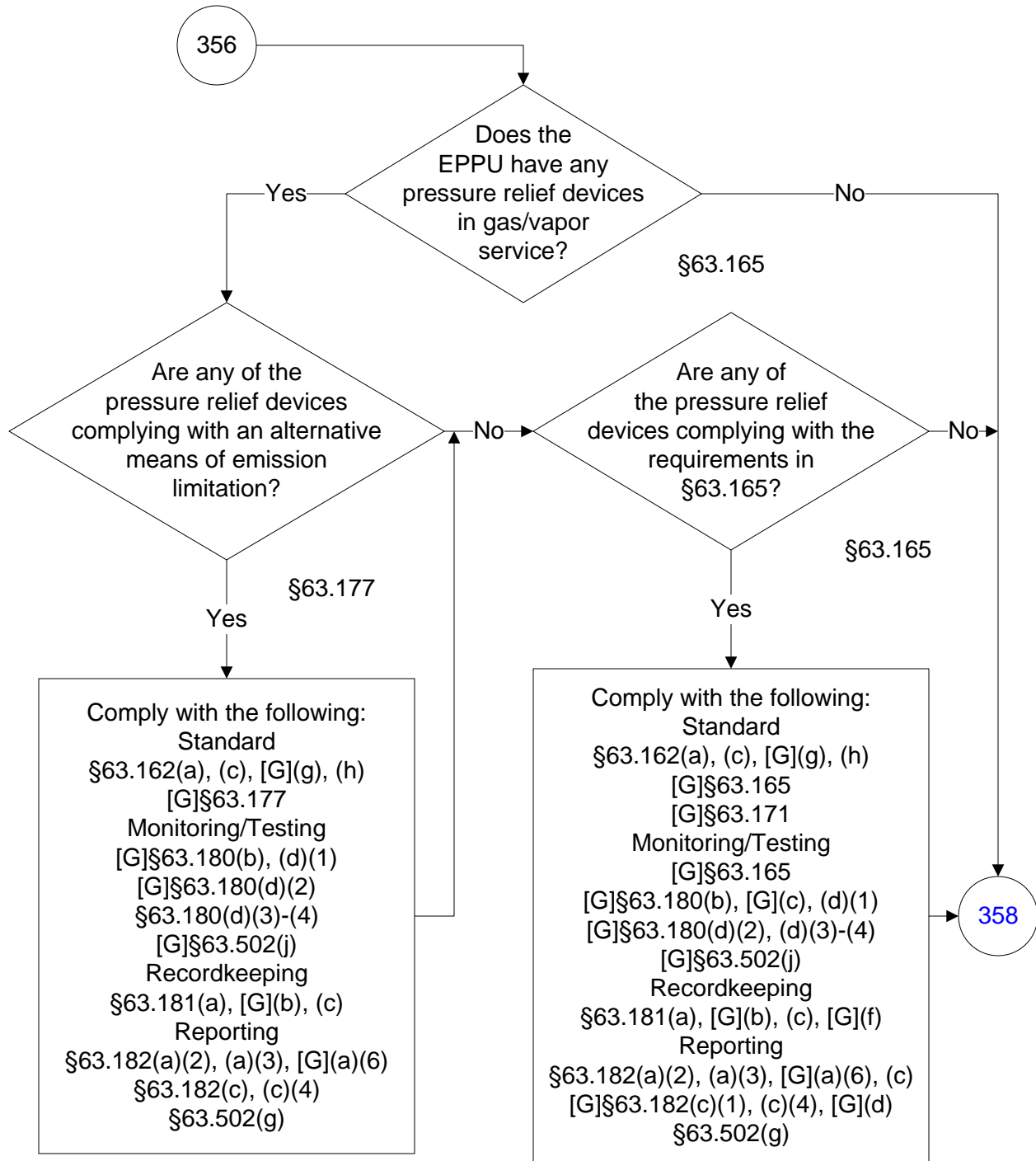

40 CFR Part 63, Subpart U

(163 of 176)

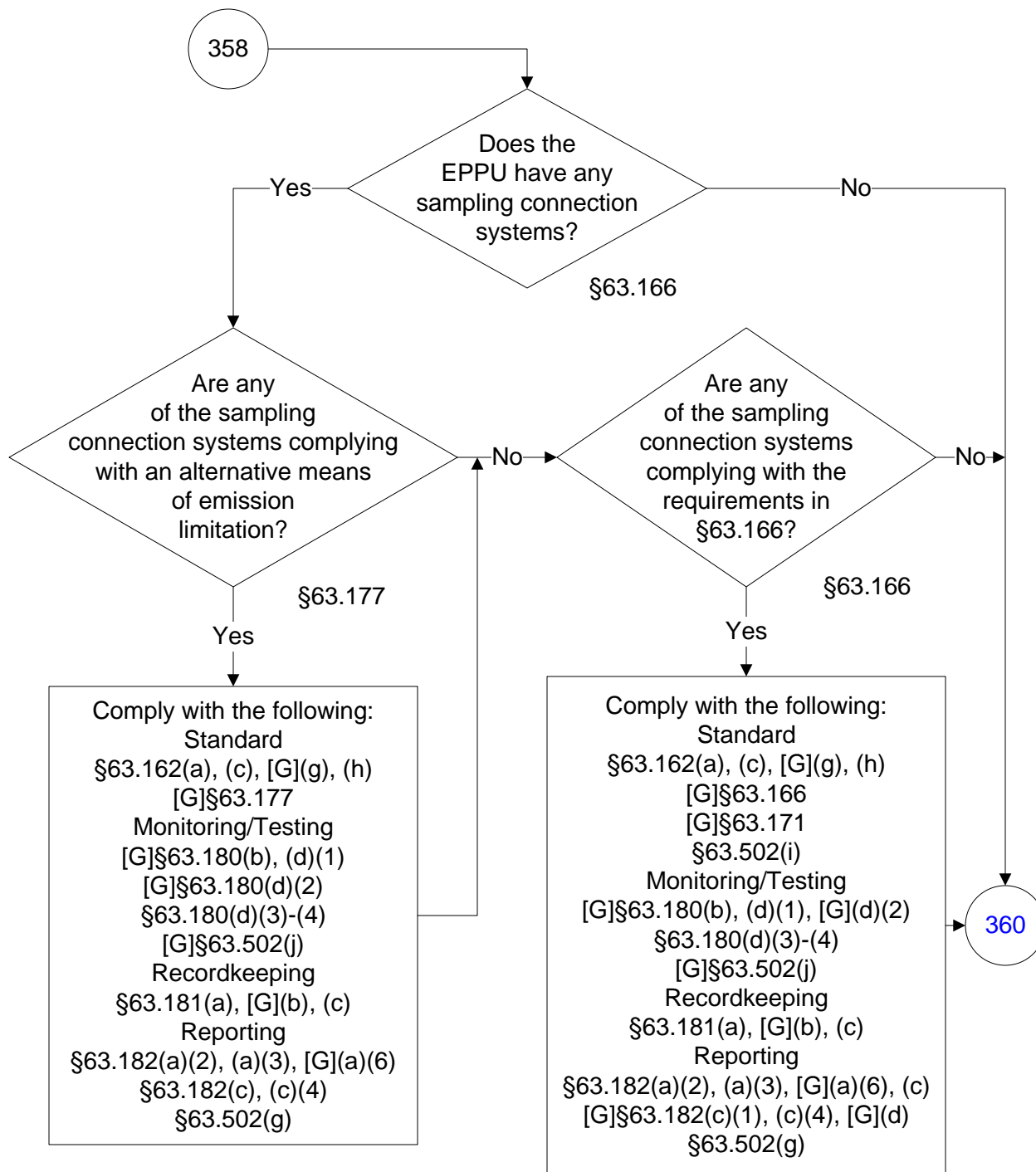

40 CFR Part 63, Subpart U

(164 of 176)

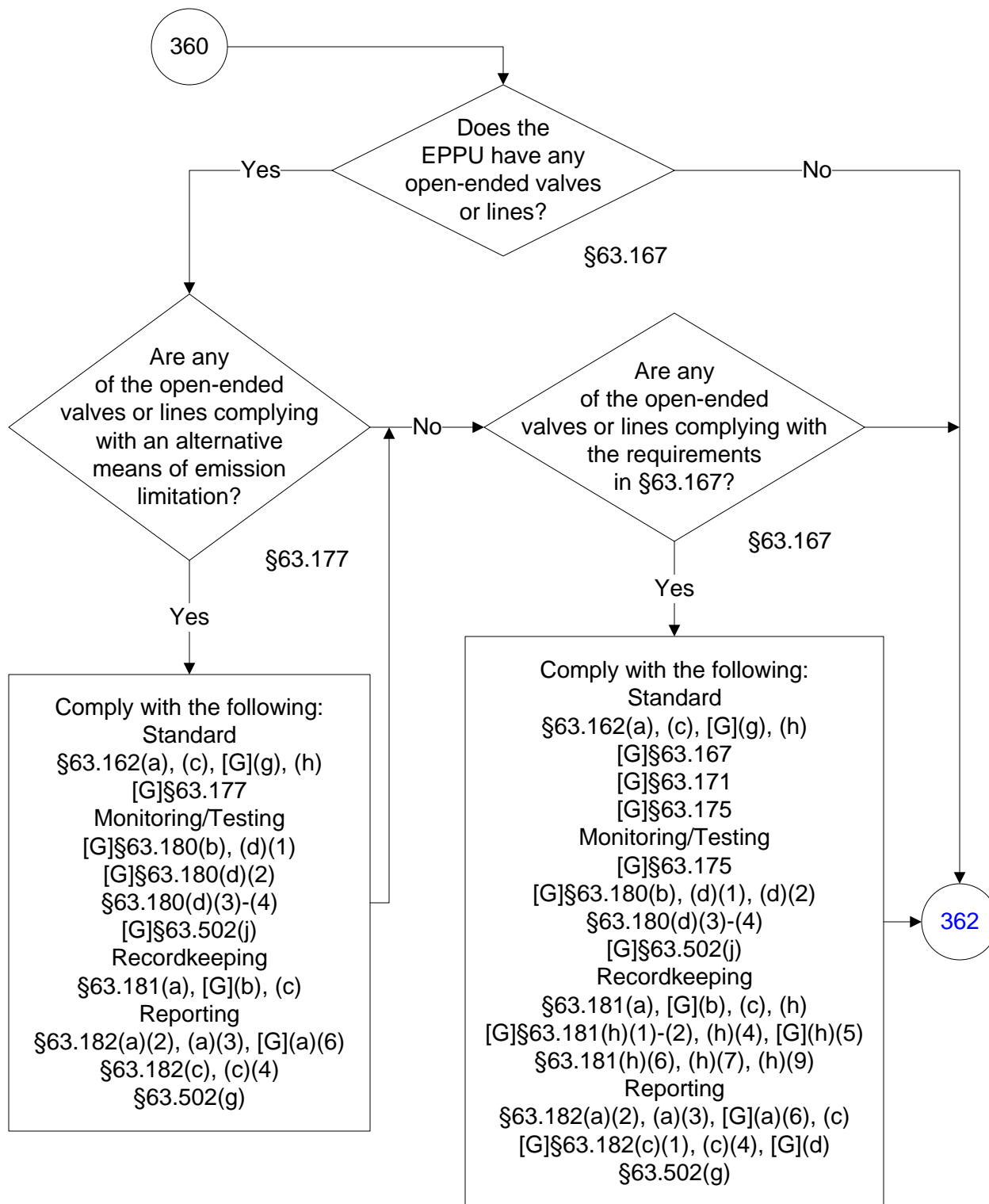

40 CFR Part 63, Subpart U

(165 of 176)

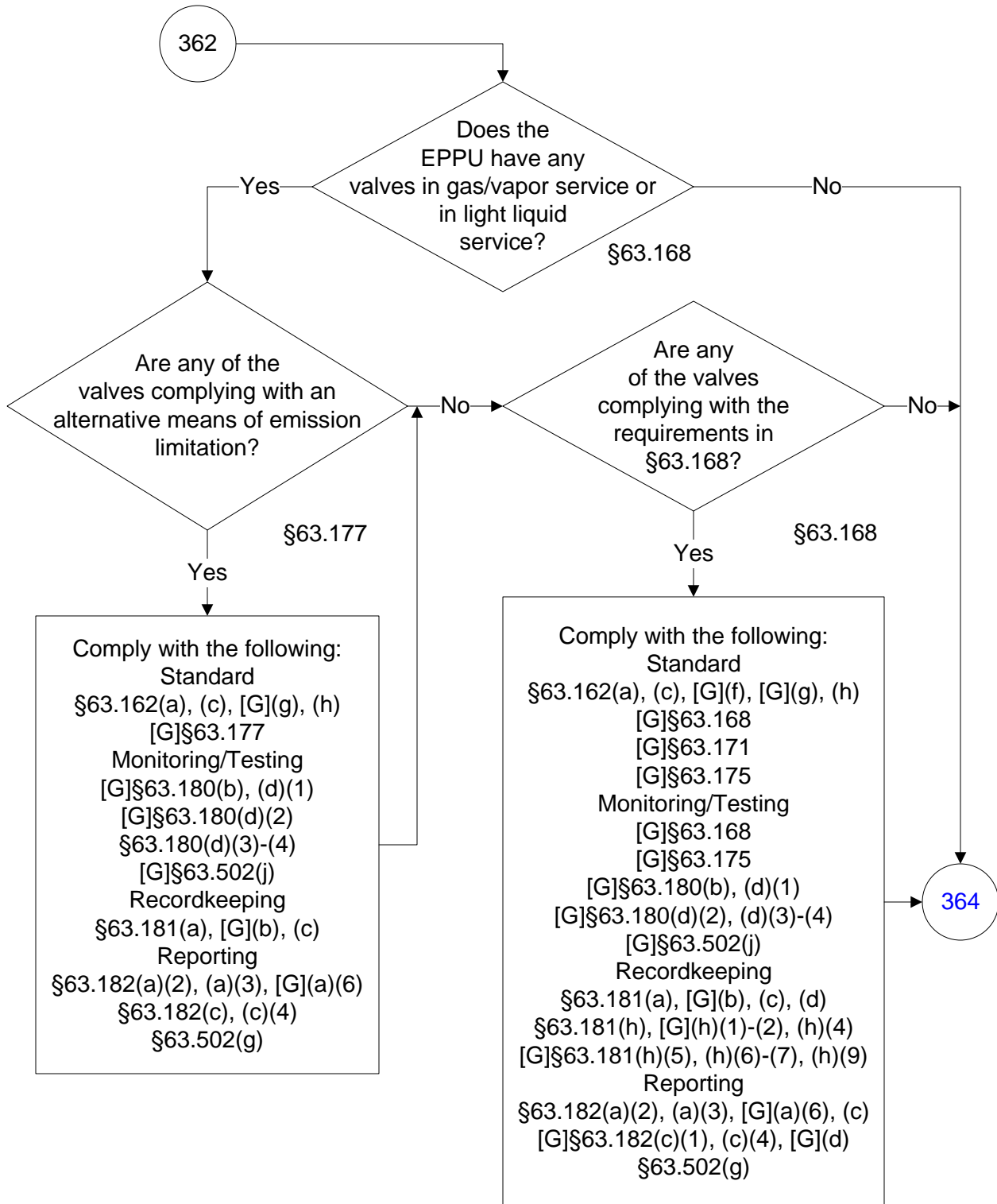

40 CFR Part 63, Subpart U
(166 of 176)

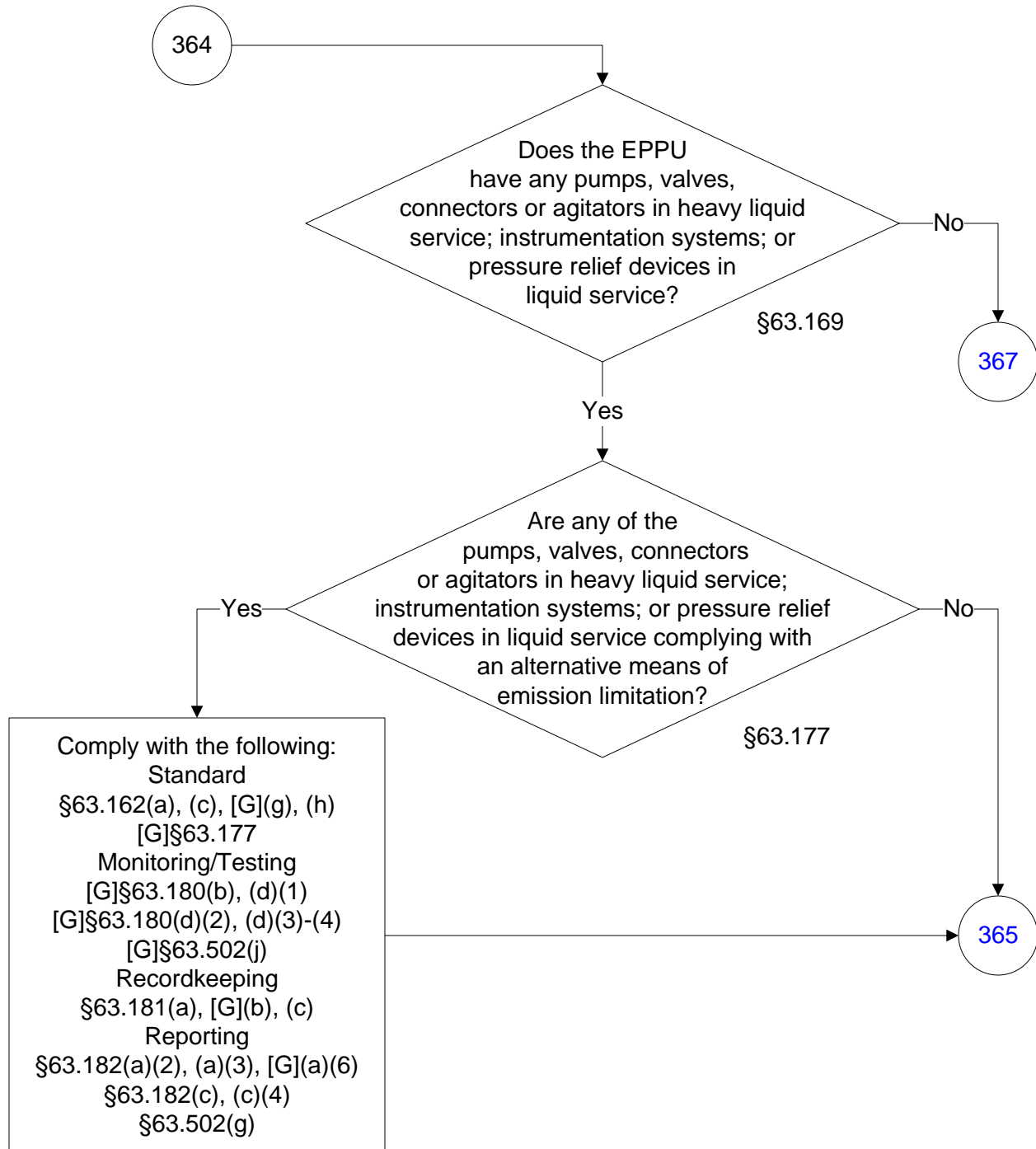

40 CFR Part 63, Subpart U

(167 of 176)

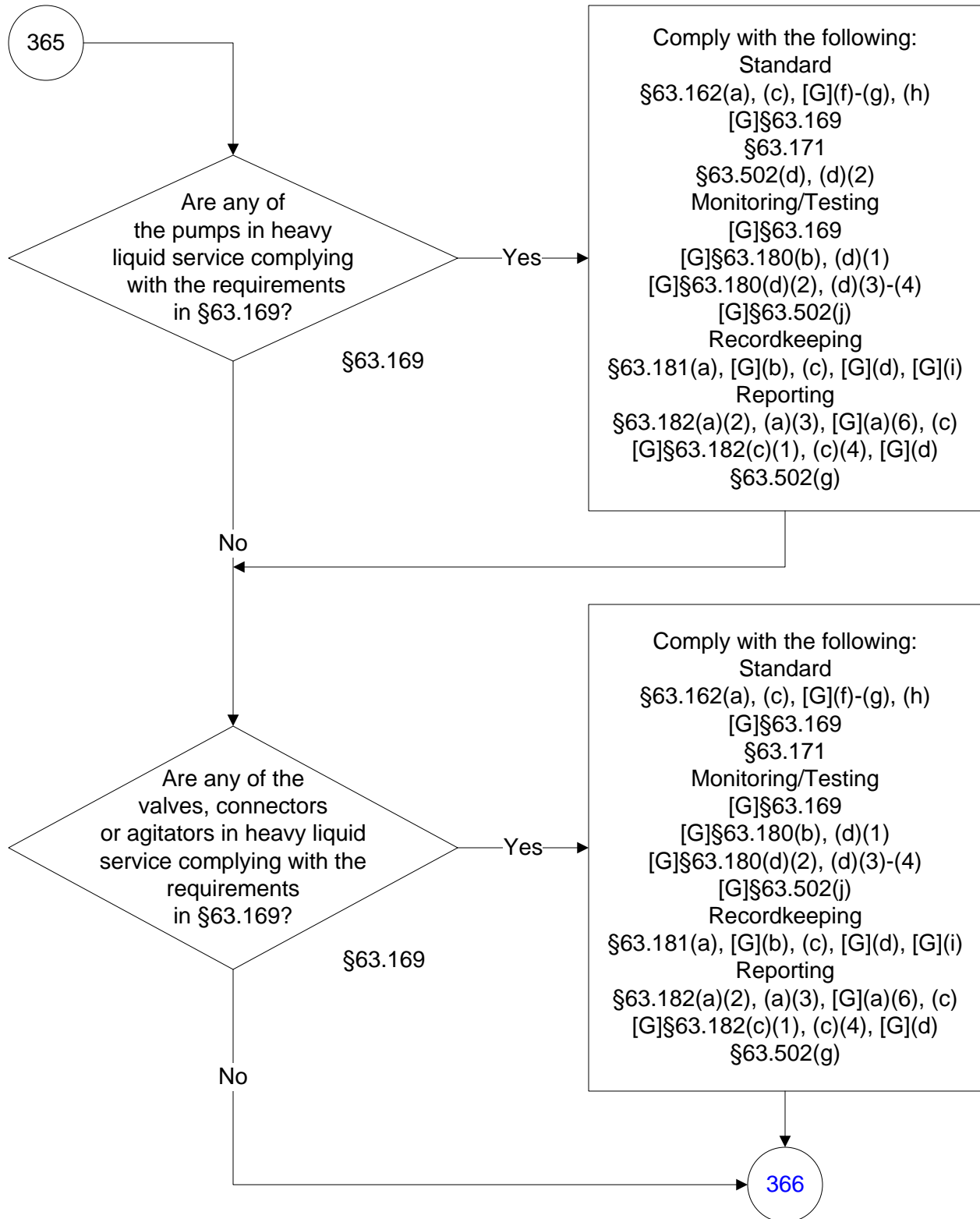

40 CFR Part 63, Subpart U

(168 of 176)

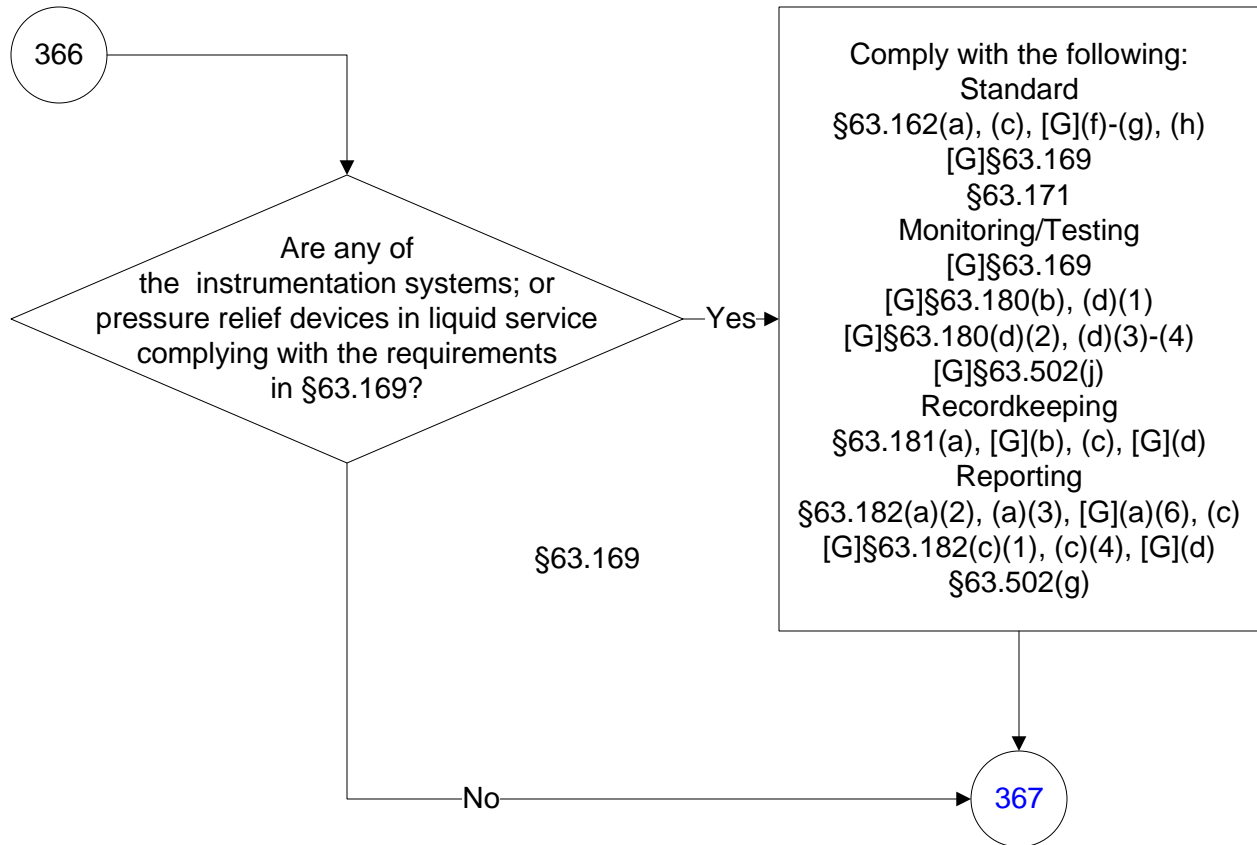

40 CFR Part 63, Subpart U
(169 of 176)

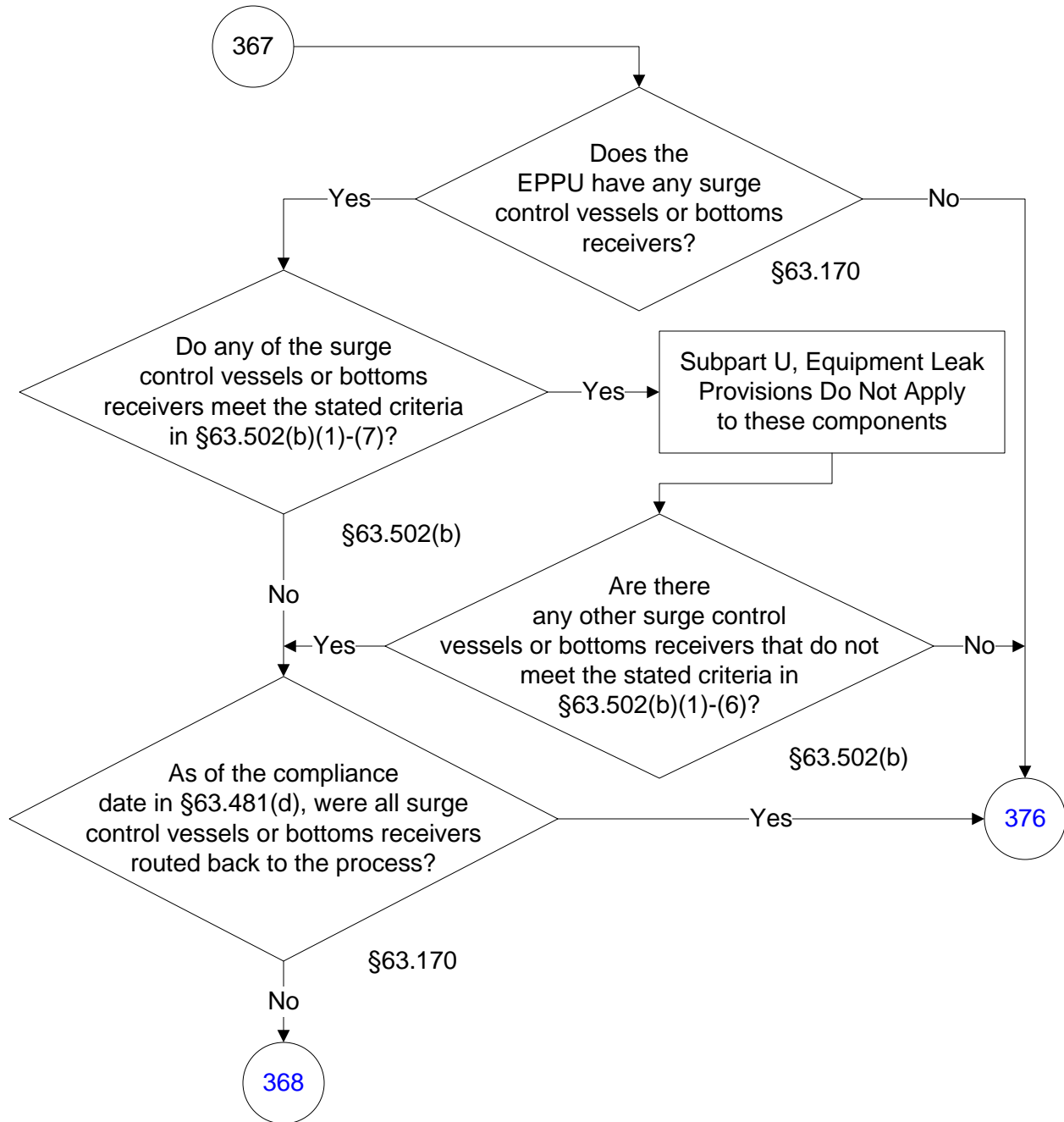

40 CFR Part 63, Subpart U

(170 of 176)

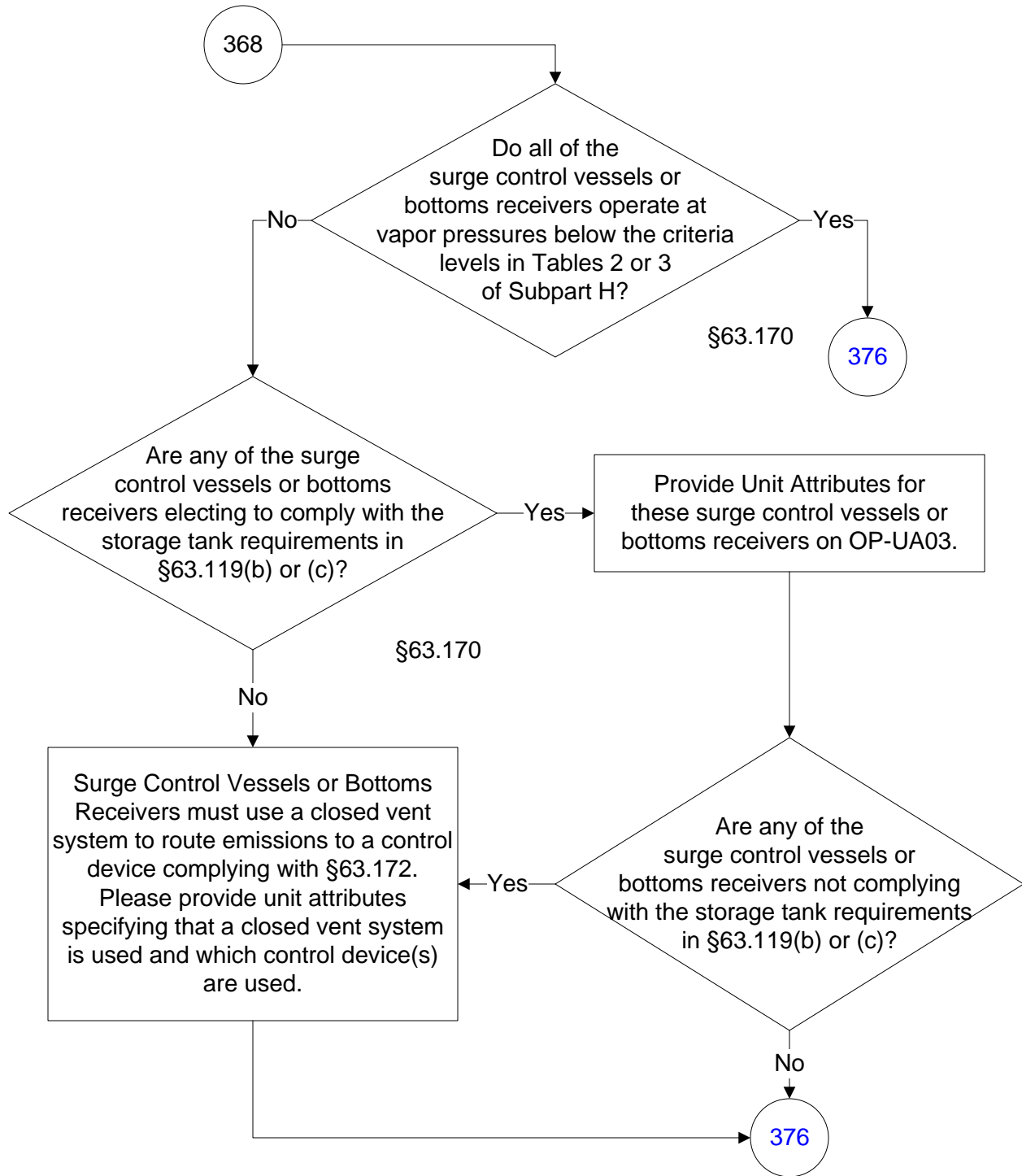

40 CFR Part 63, Subpart U

(171 of 176)

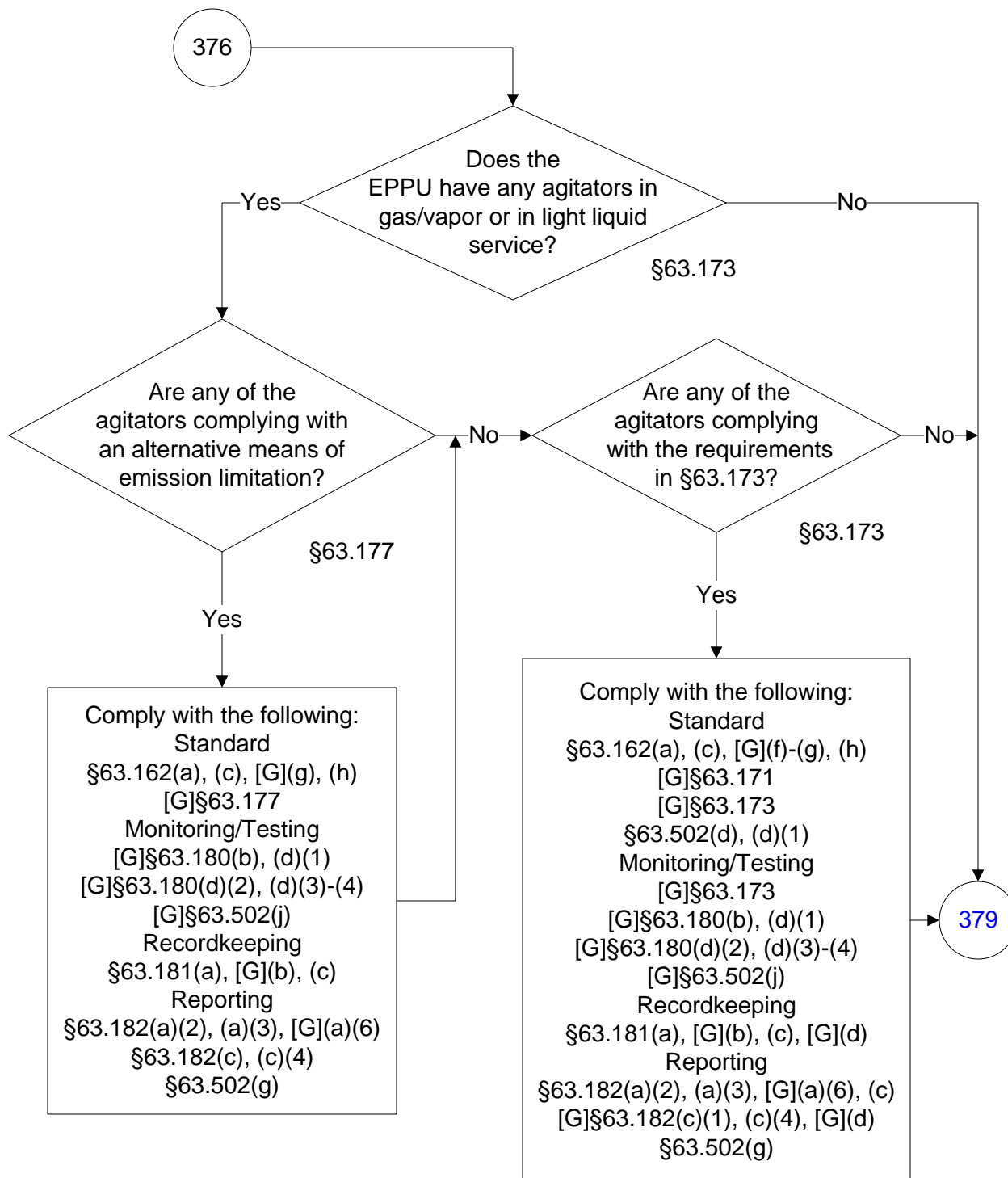

40 CFR Part 63, Subpart U

(172 of 176)

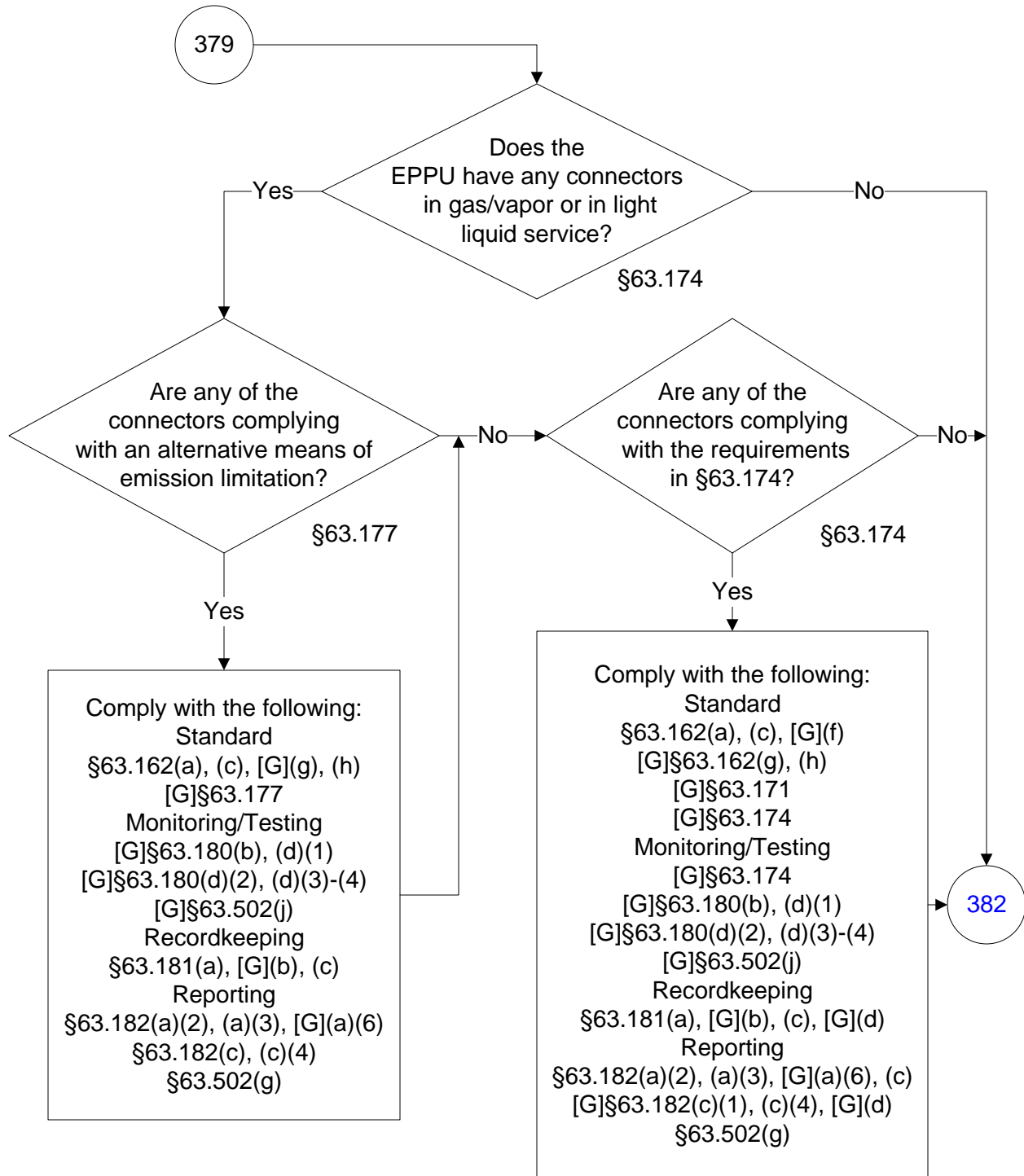

40 CFR Part 63, Subpart U

(173 of 176)

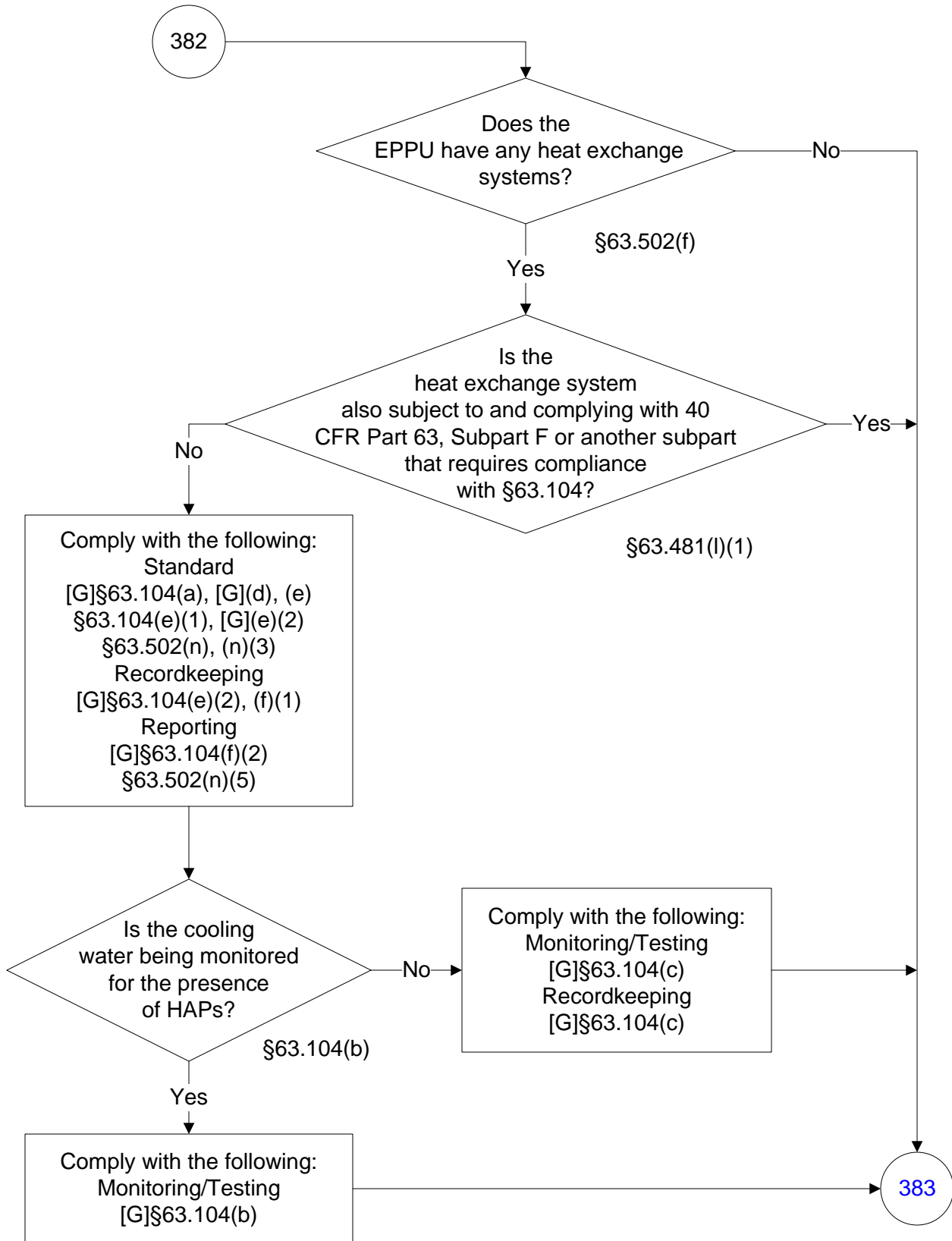

40 CFR Part 63, Subpart U

(174 of 176)

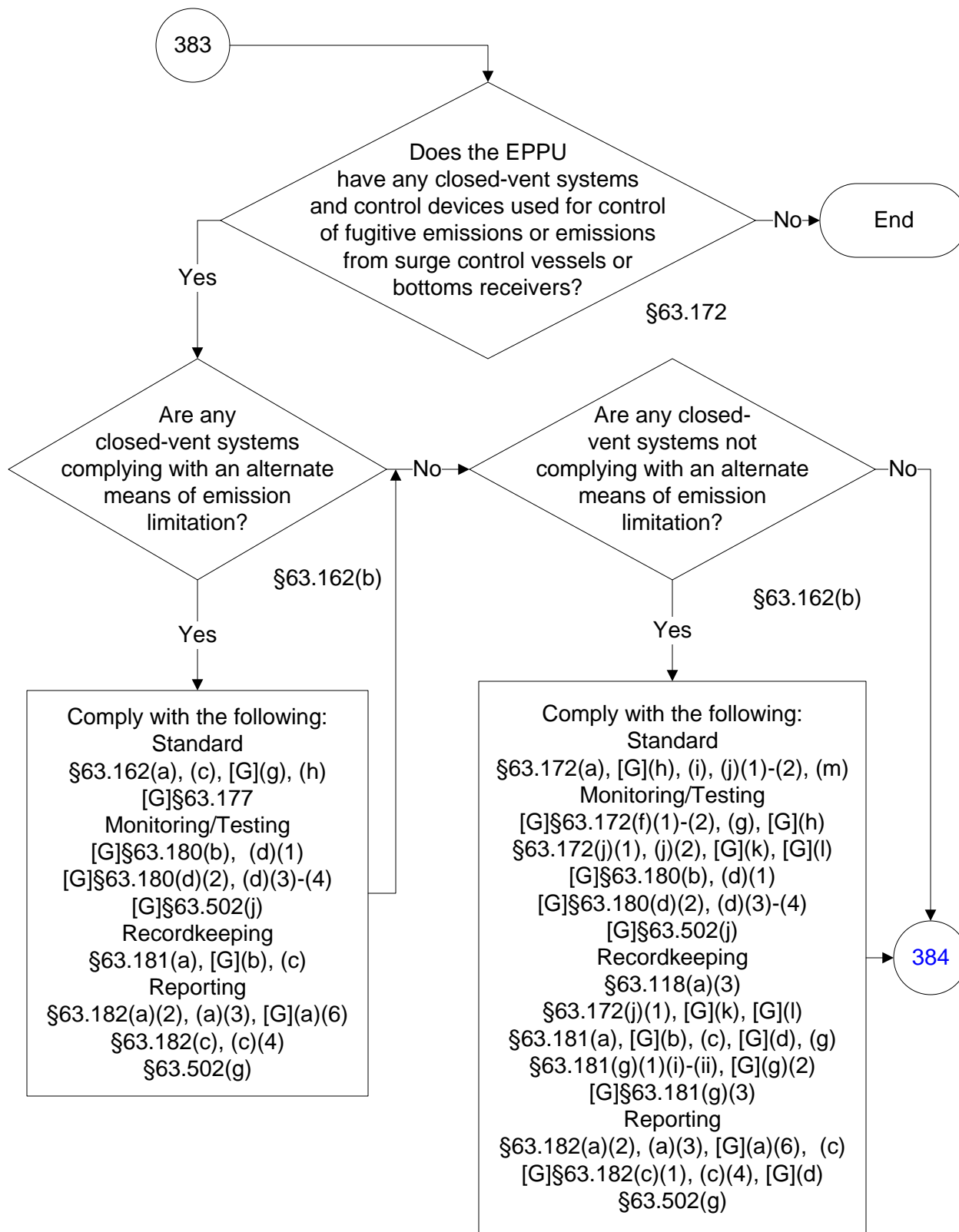

40 CFR Part 63, Subpart U

(175 of 176)

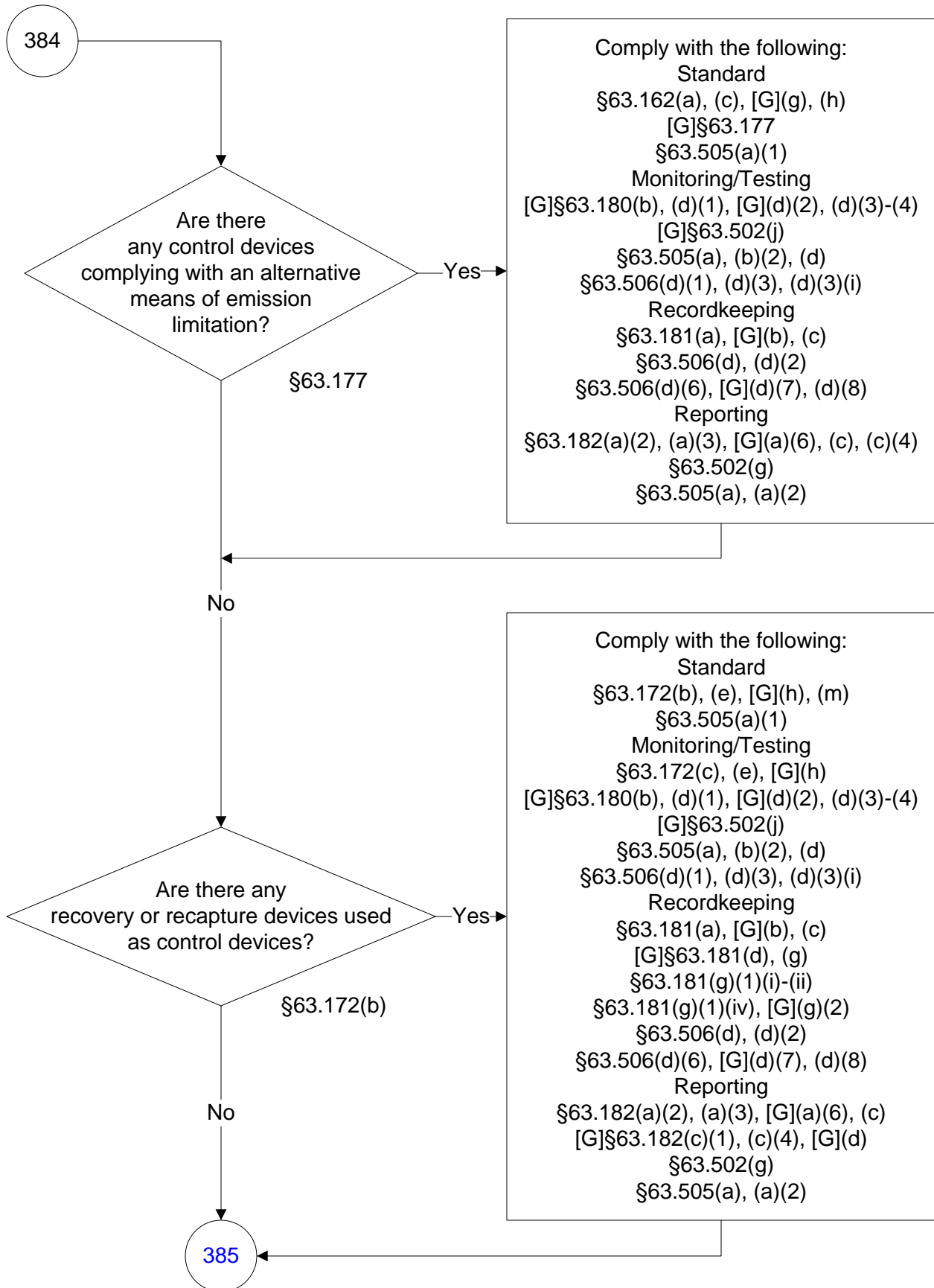

40 CFR Part 63, Subpart U

(176 of 176)

