

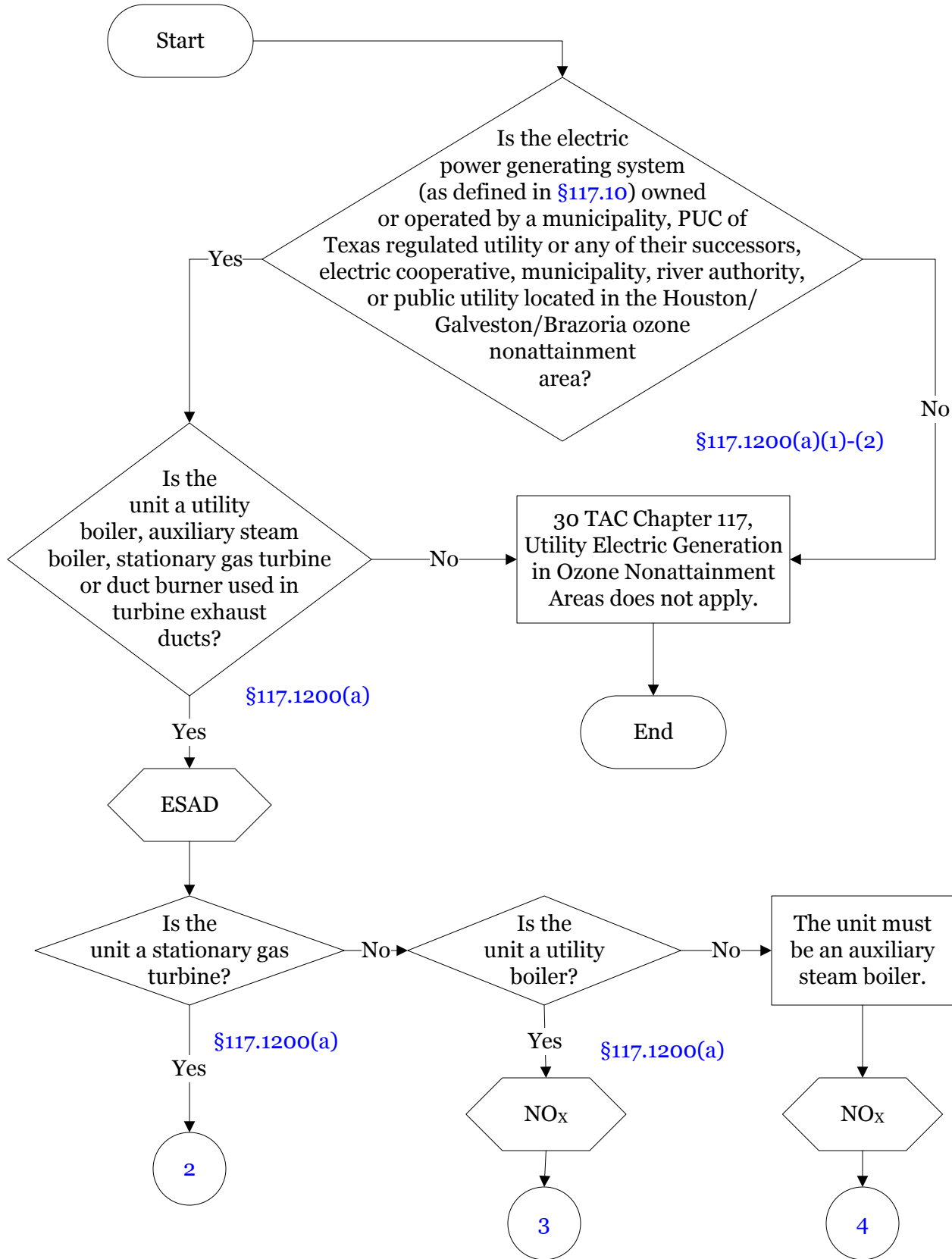

Below is a flowchart describing 30 TAC Ch. 117, Subch. C, Div. 3, H-G-B Ozone Nonattainment Area Utility Electric Generation Sources. For the text of the statute/rule, please go to [30 TAC Ch. 117, Subch. C, Div. 3: H-G-B Ozone Nonattainment Area Utility Electric Generation Sources](#) (1 of 39)

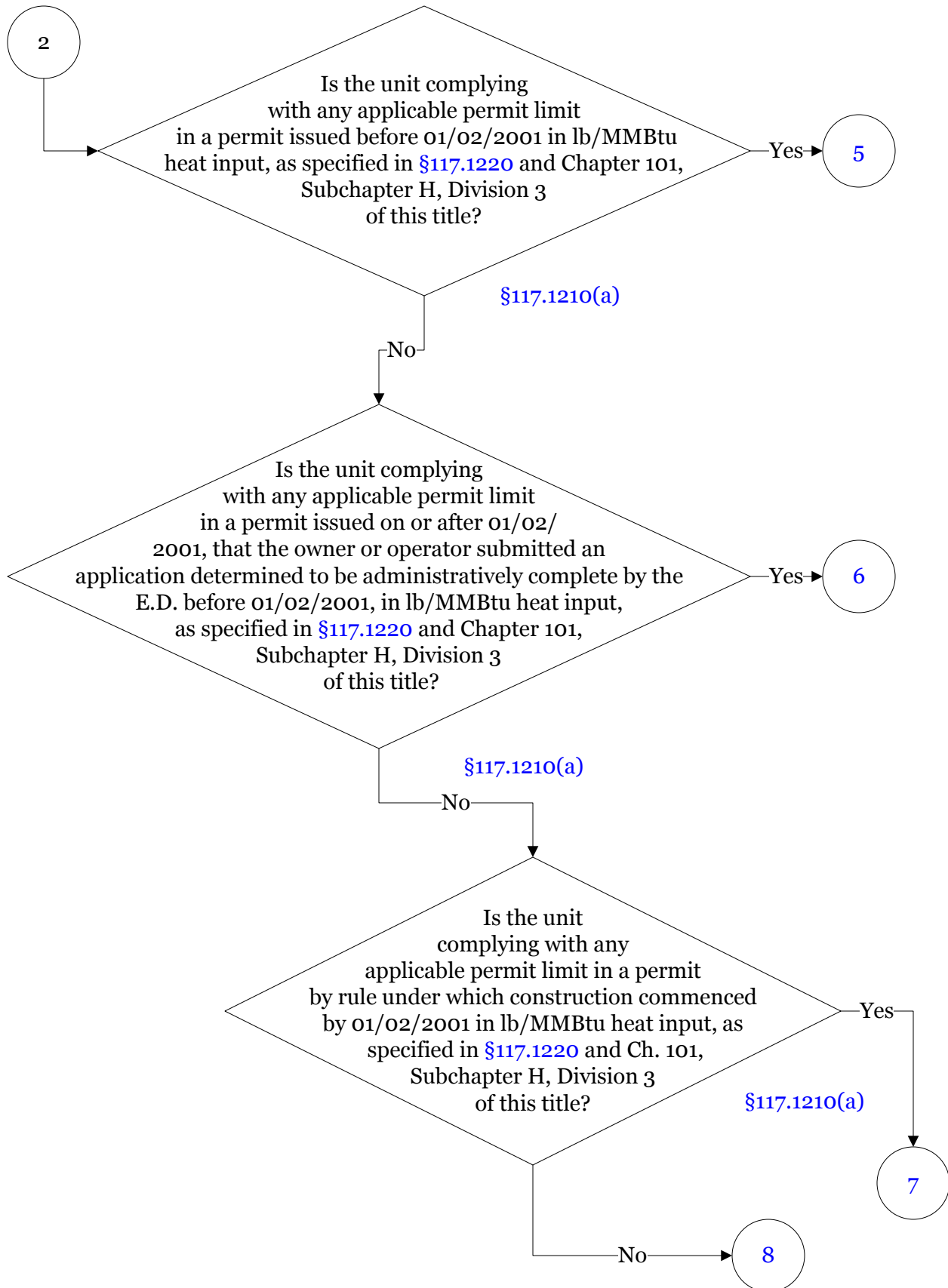

**30 TAC Chapter 117, Subchapter C, Combustion Control at Major Utility  
Electric Generation Sources, Division 3: H-G-B Ozone Nonattainment Area  
Utility Electric Generation Sources  
2 of 39**



**30 TAC Chapter 117, Subchapter C, Combustion Control at Major Utility  
Electric Generation Sources, Division 3: H-G-B Ozone Nonattainment Area  
Utility Electric Generation Sources  
3 of 39**

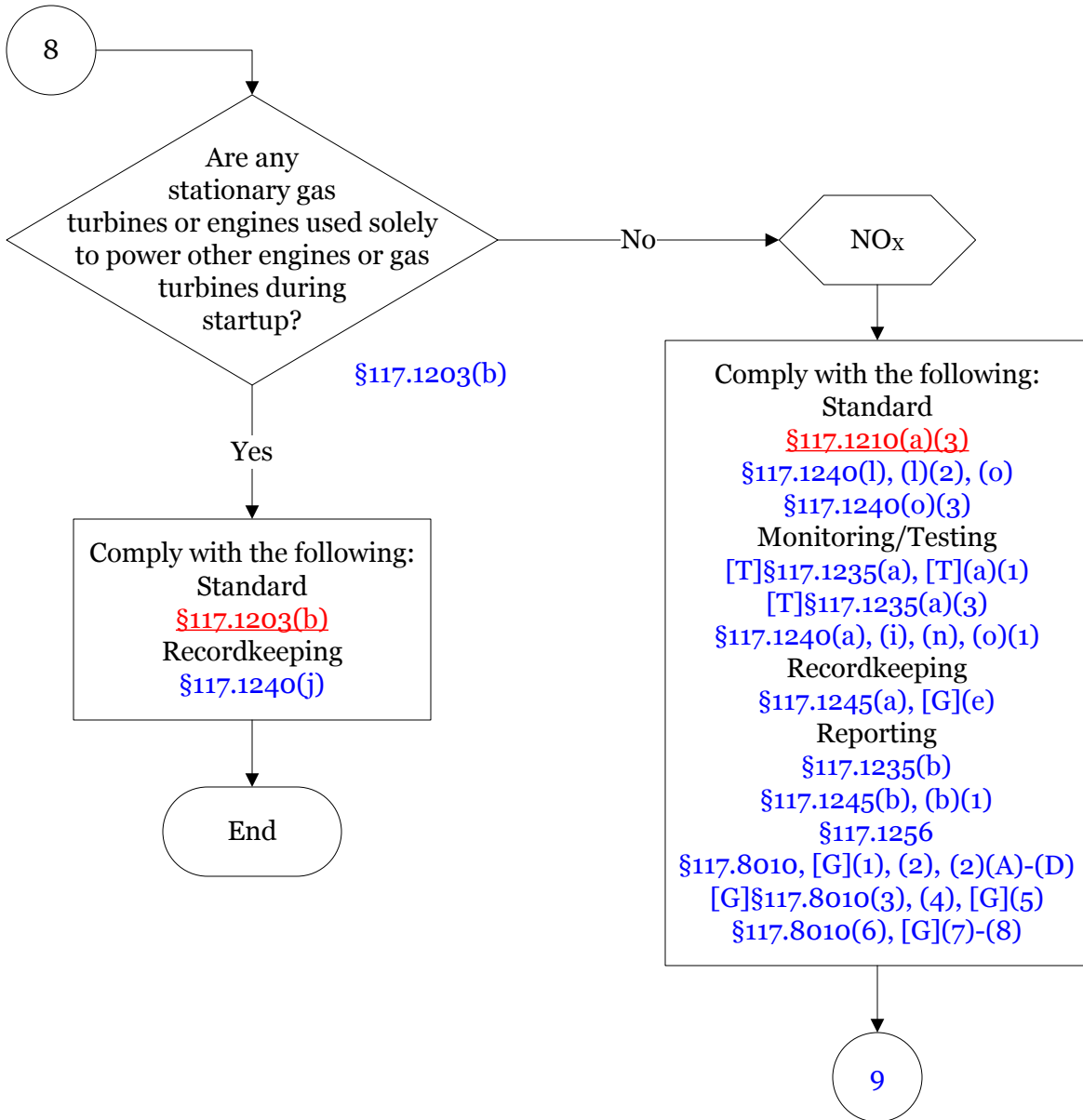

**30 TAC Chapter 117, Subchapter C, Combustion Control at Major Utility  
Electric Generation Sources, Division 3: H-G-B Ozone Nonattainment Area  
Utility Electric Generation Sources  
4 of 39**

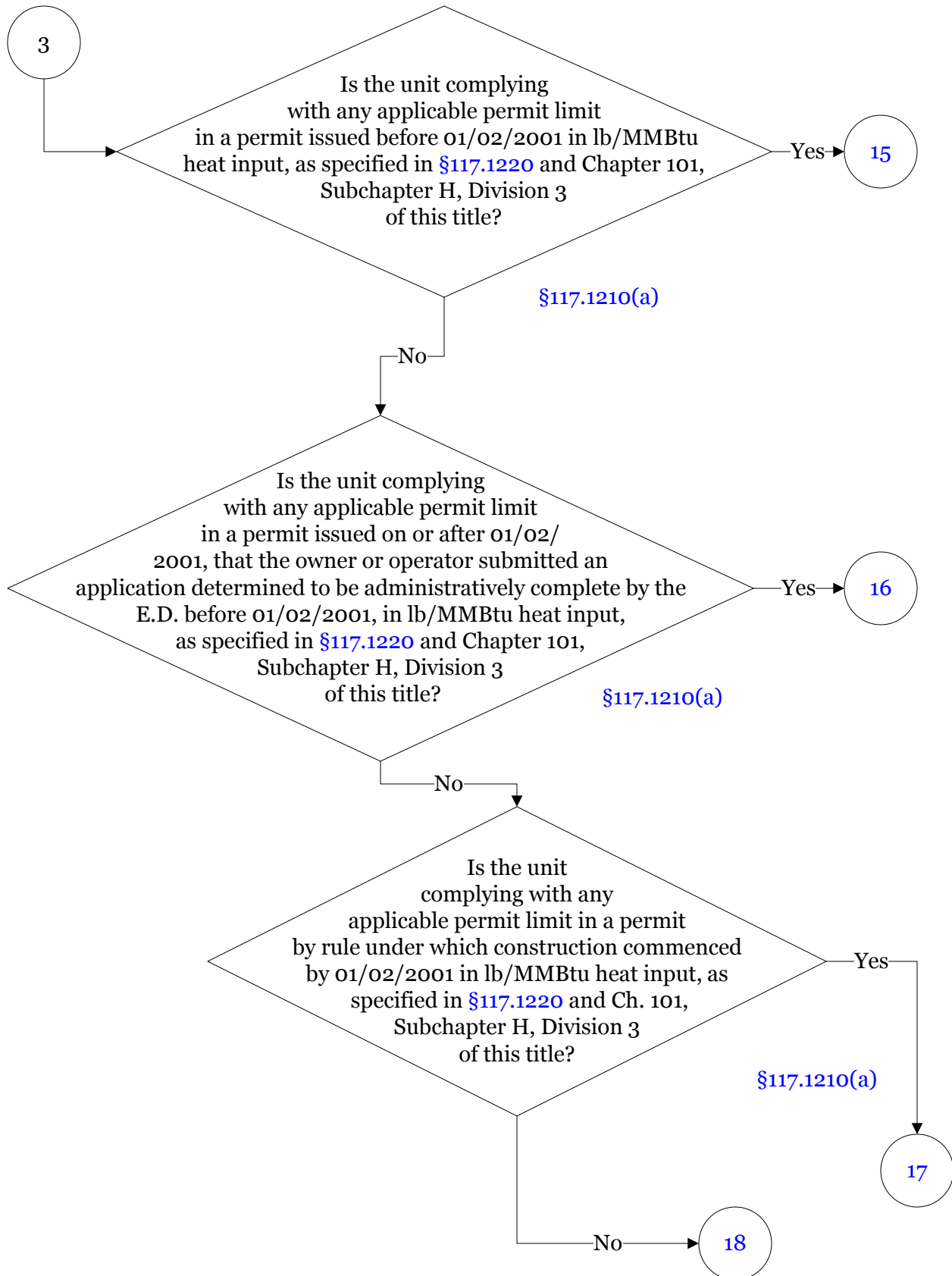

30 TAC Chapter 117, Subchapter C, Combustion Control at Major Utility Electric Generation Sources, Division 3: H-G-B Ozone Nonattainment Area Utility Electric Generation Sources

5 of 39

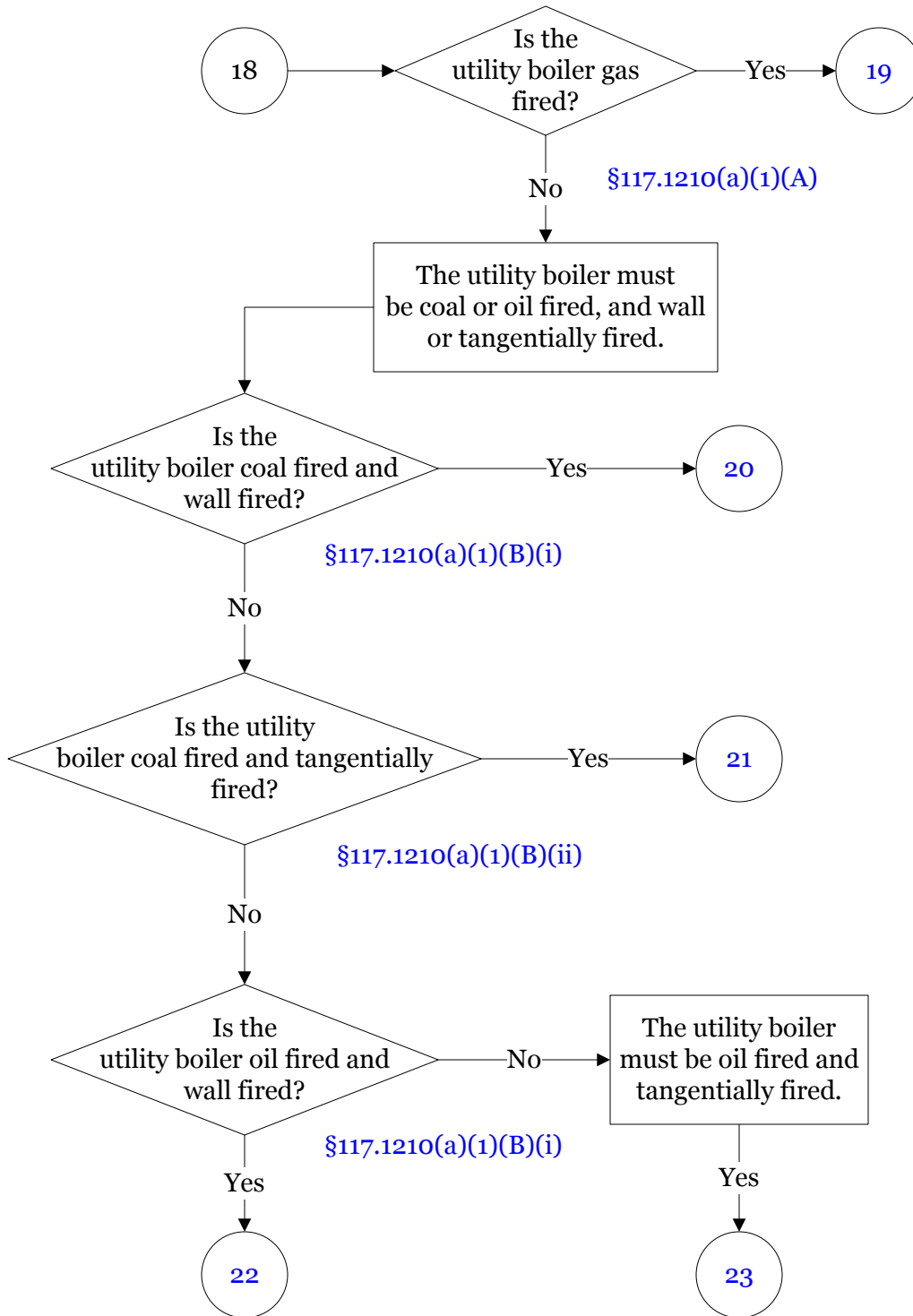

**30 TAC Chapter 117, Subchapter C, Combustion Control at Major Utility  
Electric Generation Sources, Division 3: H-G-B Ozone Nonattainment Area  
Utility Electric Generation Sources**

**6 of 39**

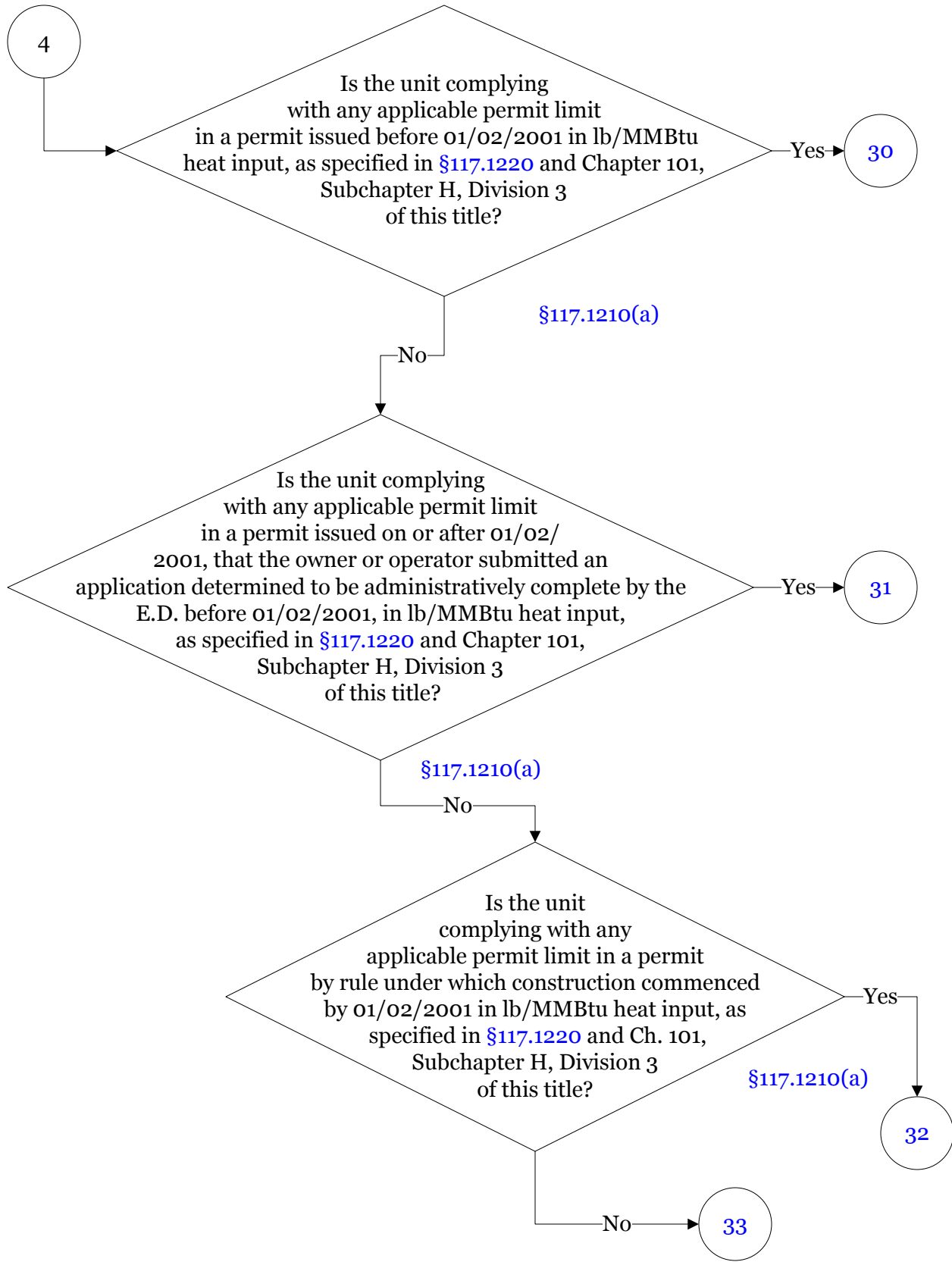

**30 TAC Chapter 117, Subchapter C, Combustion Control at Major Utility  
Electric Generation Sources, Division 3: H-G-B Ozone Nonattainment Area  
Utility Electric Generation Sources**

**7 of 39**

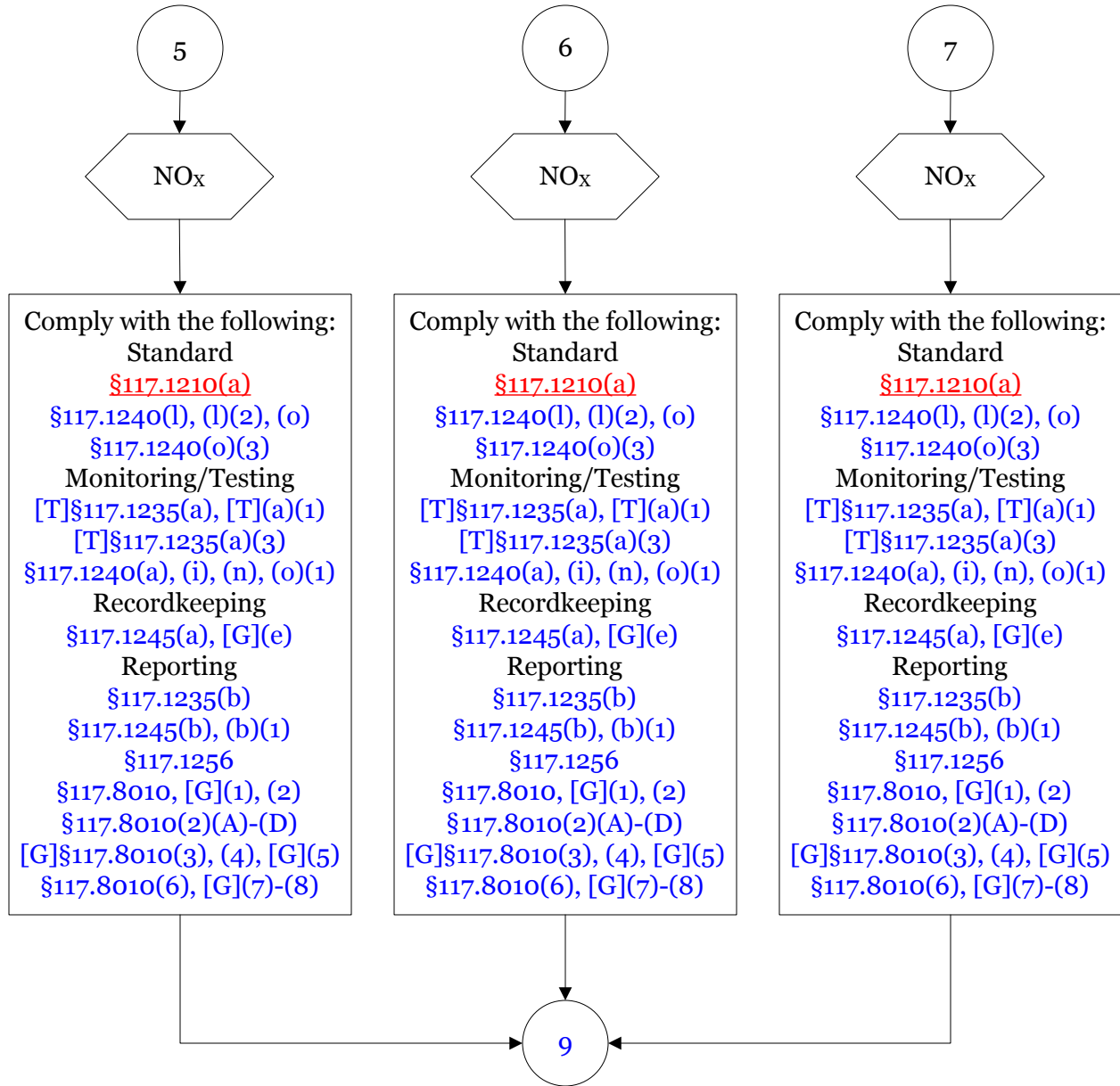

**30 TAC Chapter 117, Subchapter C, Combustion Control at Major Utility  
Electric Generation Sources, Division 3: H-G-B Ozone Nonattainment Area  
Utility Electric Generation Sources**

8 of 39

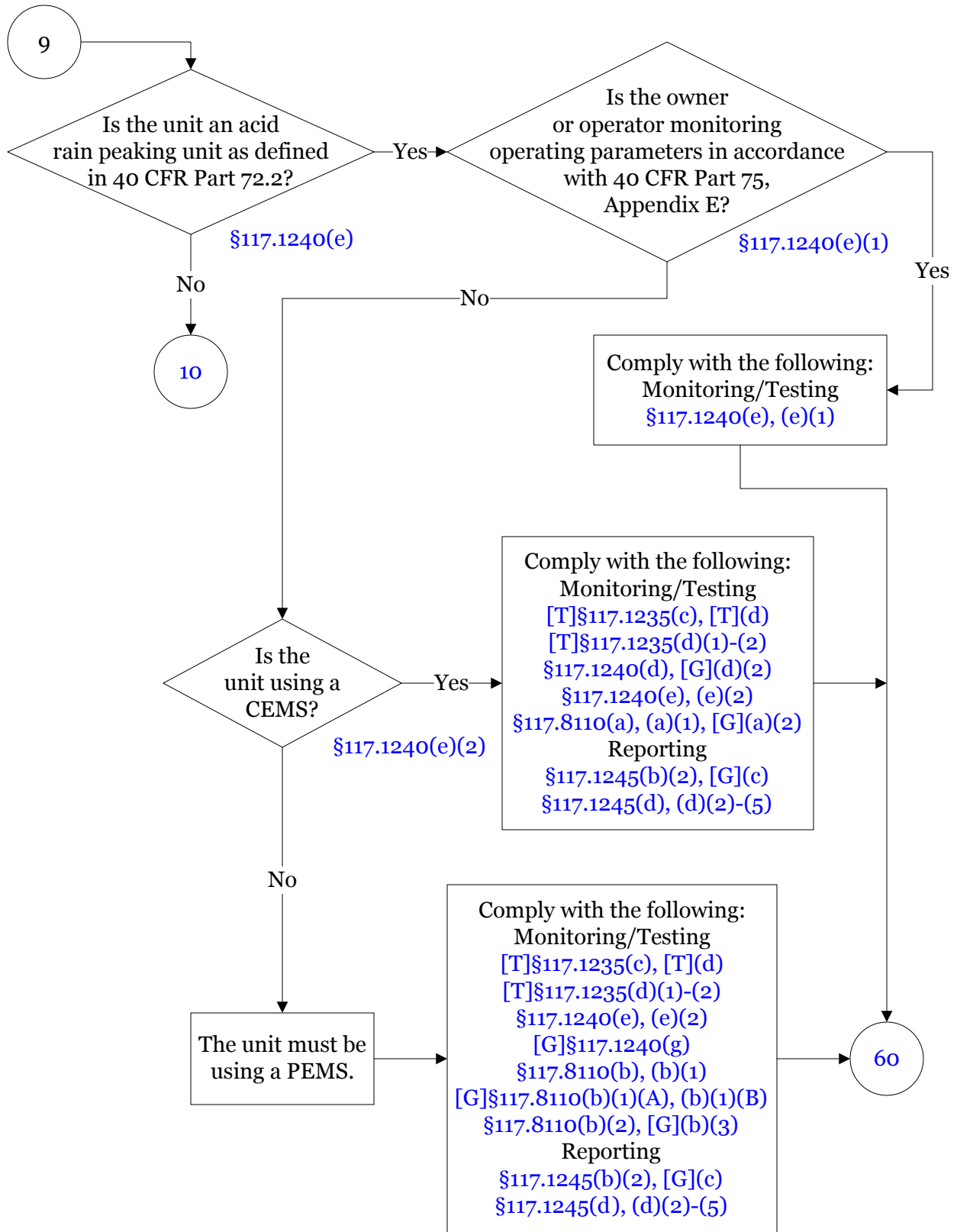



**30 TAC Chapter 117, Subchapter C, Combustion Control at Major Utility  
Electric Generation Sources, Division 3: H-G-B Ozone Nonattainment Area  
Utility Electric Generation Sources**

9 of 39

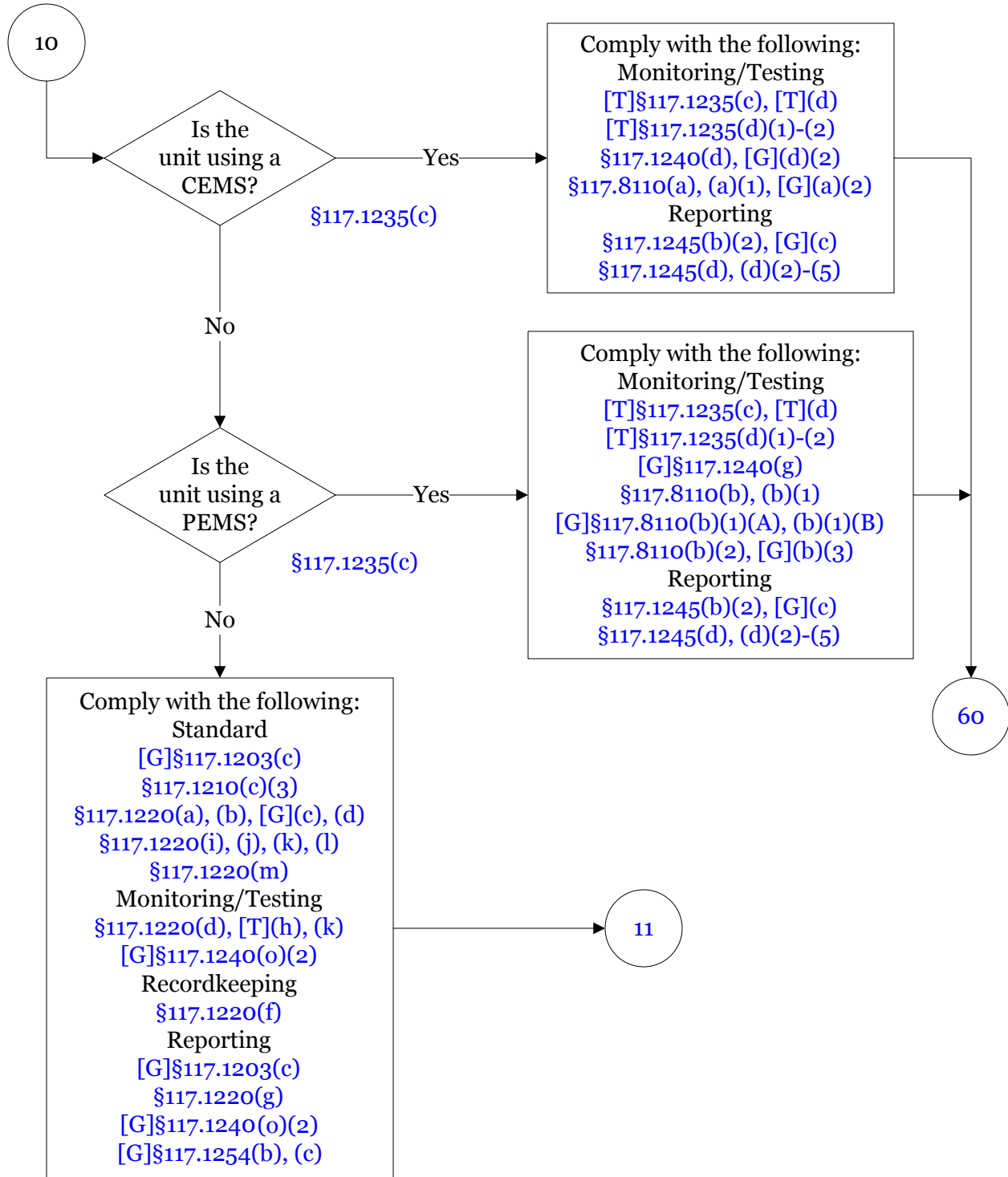

**30 TAC Chapter 117, Subchapter C, Combustion Control at Major Utility  
Electric Generation Sources, Division 3: H-G-B Ozone Nonattainment Area  
Utility Electric Generation Sources**

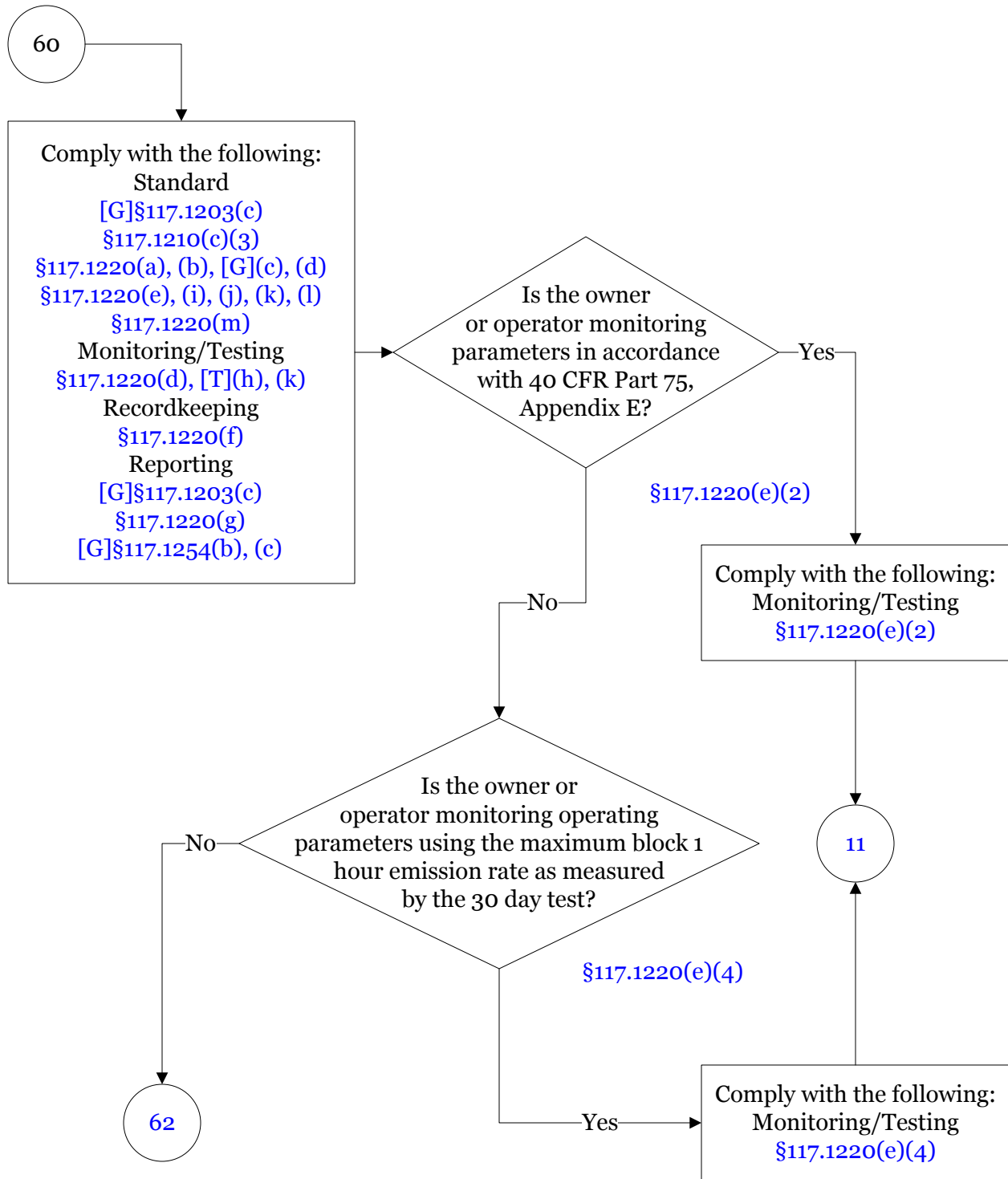

30 TAC Chapter 117, Subchapter C, Combustion Control at Major Utility  
Electric Generation Sources, Division 3: H-G-B Ozone Nonattainment Area  
Utility Electric Generation Sources

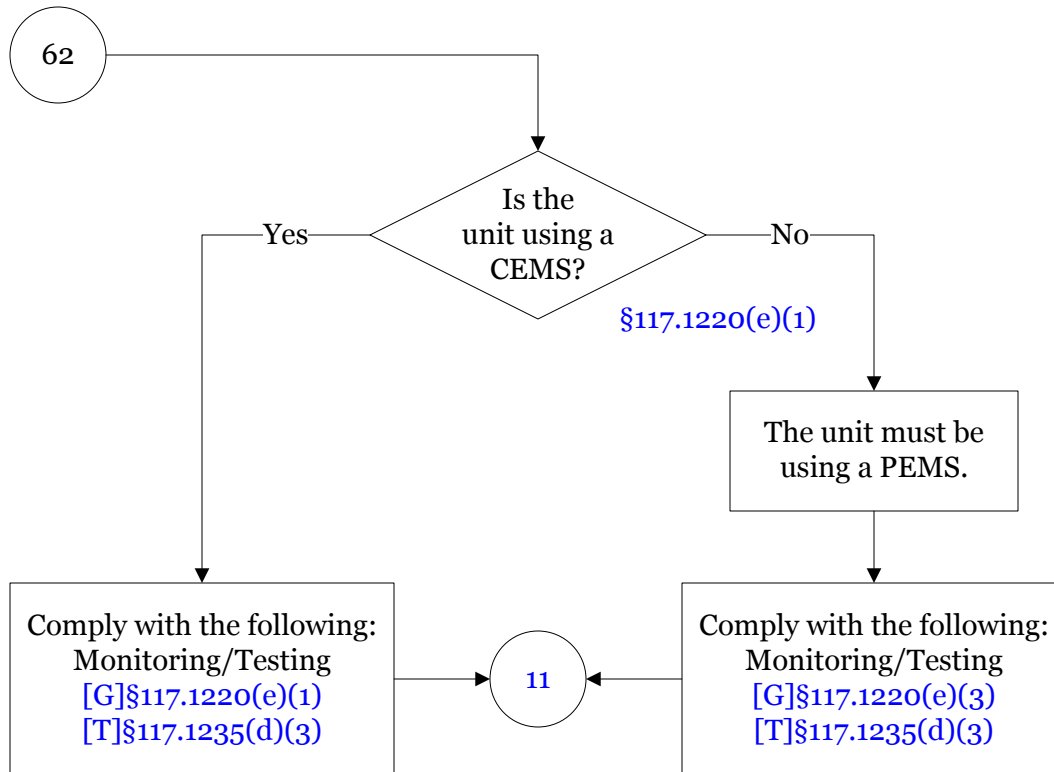

**30 TAC Chapter 117, Subchapter C, Combustion Control at Major Utility  
Electric Generation Sources, Division 3: H-G-B Ozone Nonattainment Area  
Utility Electric Generation Sources**

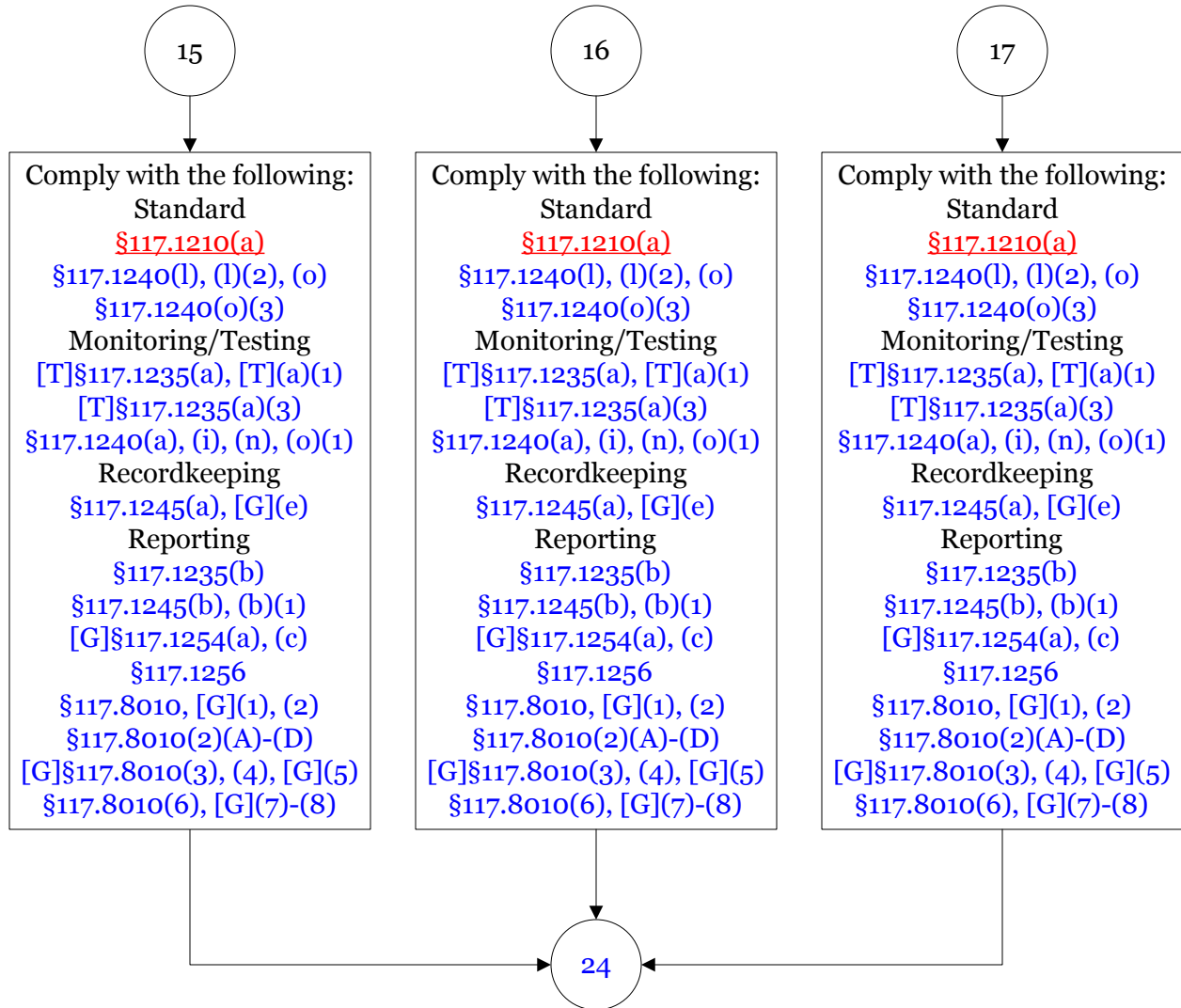

**30 TAC Chapter 117, Subchapter C, Combustion Control at Major Utility  
Electric Generation Sources, Division 3: H-G-B Ozone Nonattainment Area  
Utility Electric Generation Sources**

13 of 39

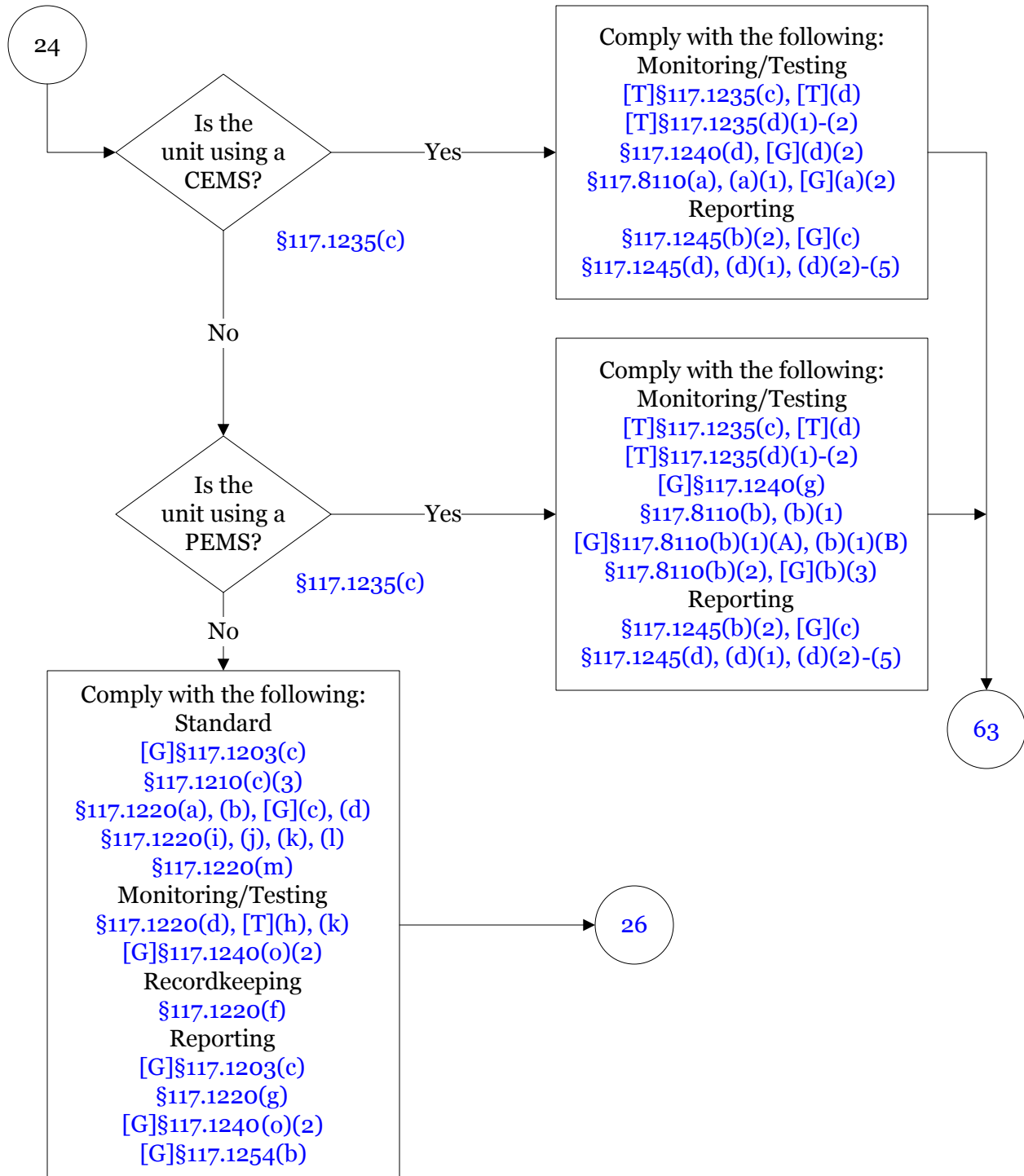

**30 TAC Chapter 117, Subchapter C, Combustion Control at Major Utility  
Electric Generation Sources, Division 3: H-G-B Ozone Nonattainment Area  
Utility Electric Generation Sources**

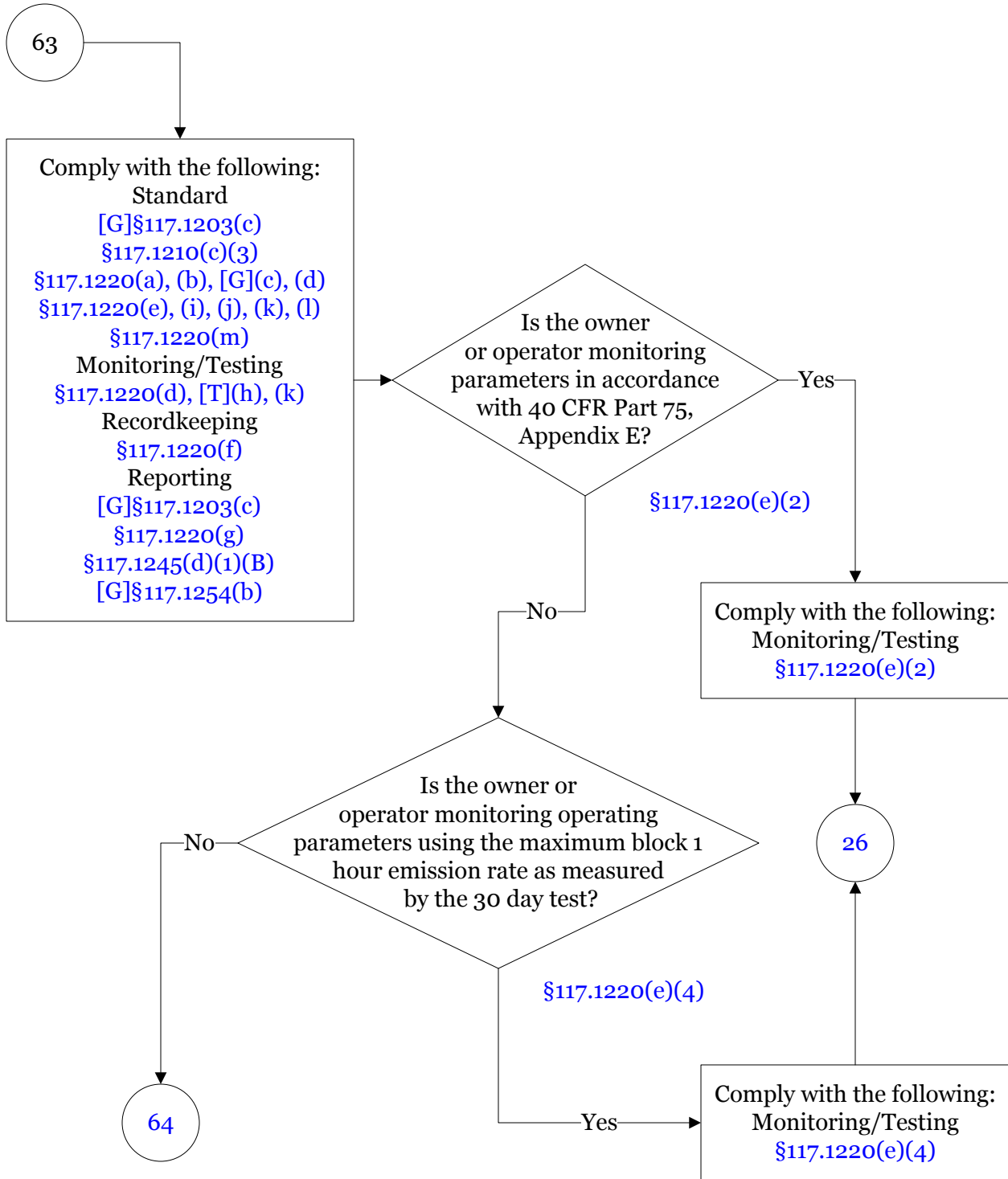

30 TAC Chapter 117, Subchapter C, Combustion Control at Major Utility  
Electric Generation Sources, Division 3: H-G-B Ozone Nonattainment Area  
Utility Electric Generation Sources

15 of 39

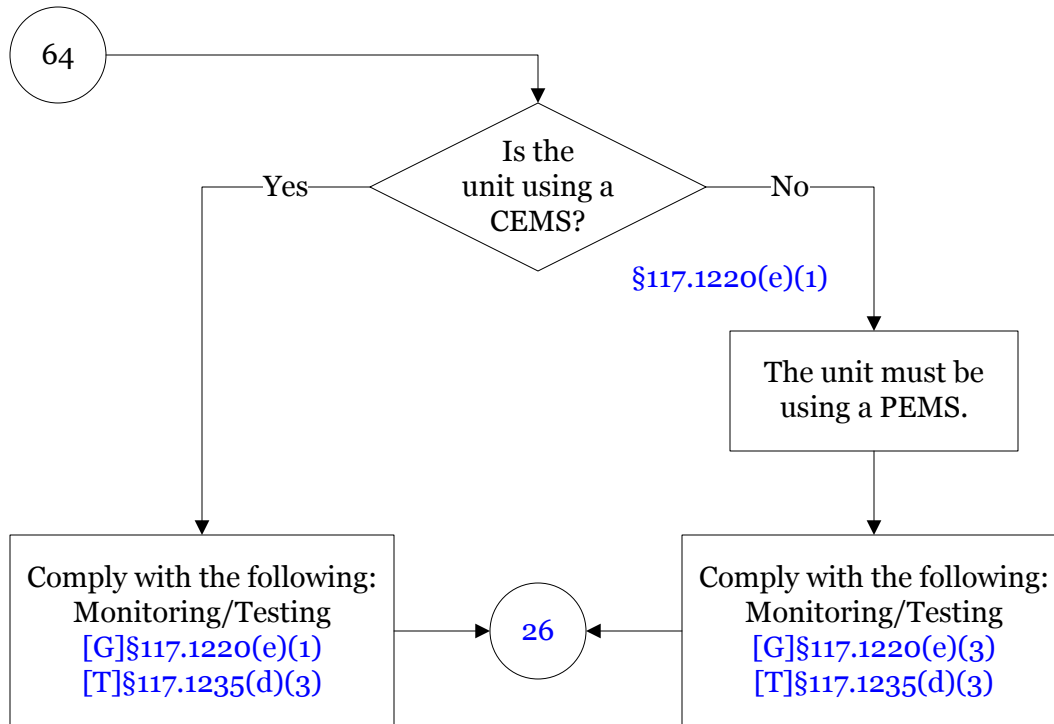

**30 TAC Chapter 117, Subchapter C, Combustion Control at Major Utility  
Electric Generation Sources, Division 3: H-G-B Ozone Nonattainment Area  
Utility Electric Generation Sources**

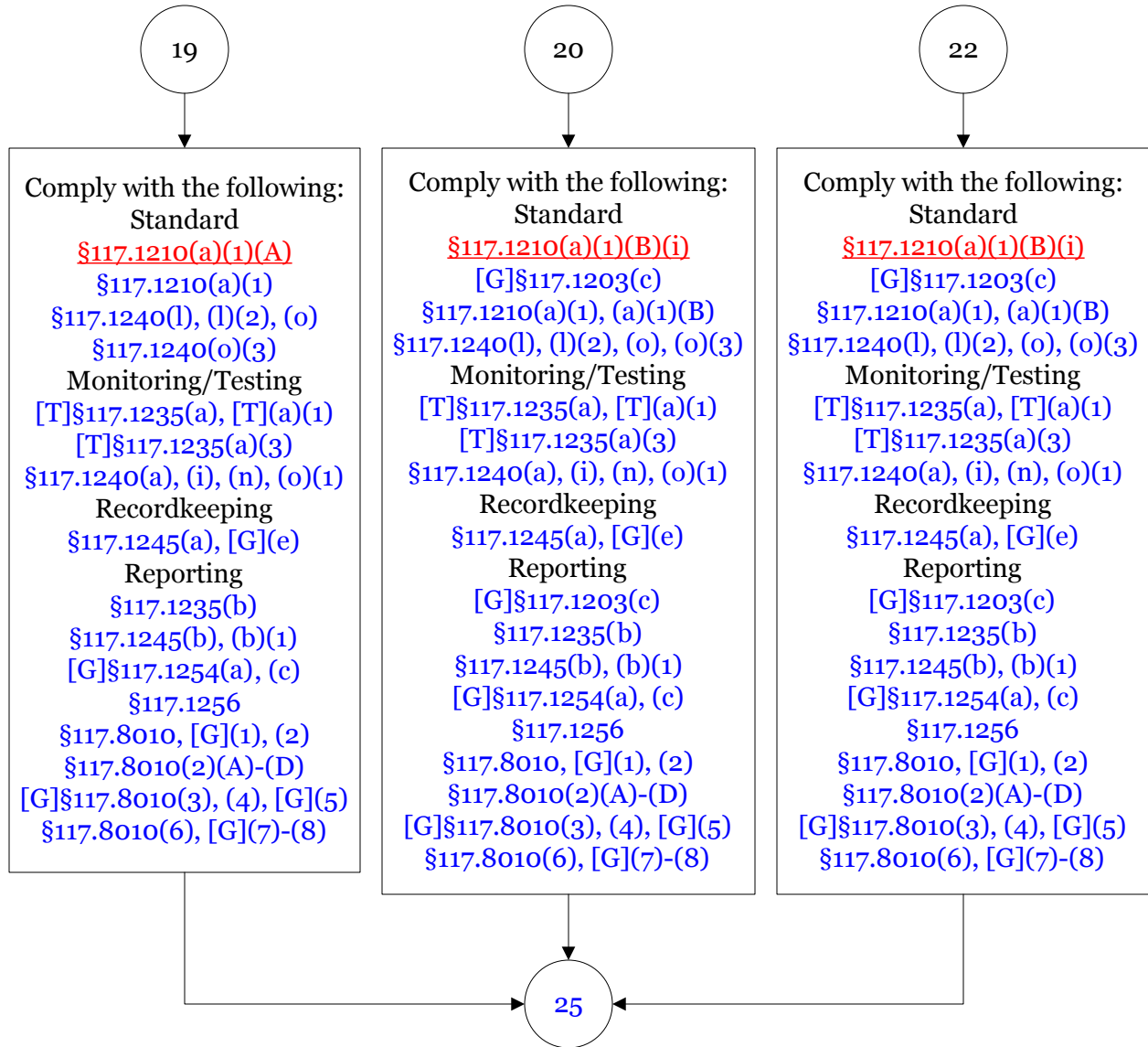



30 TAC Chapter 117, Subchapter C, Combustion Control at Major Utility  
Electric Generation Sources, Division 3: H-G-B Ozone Nonattainment Area  
Utility Electric Generation Sources

17 of 39

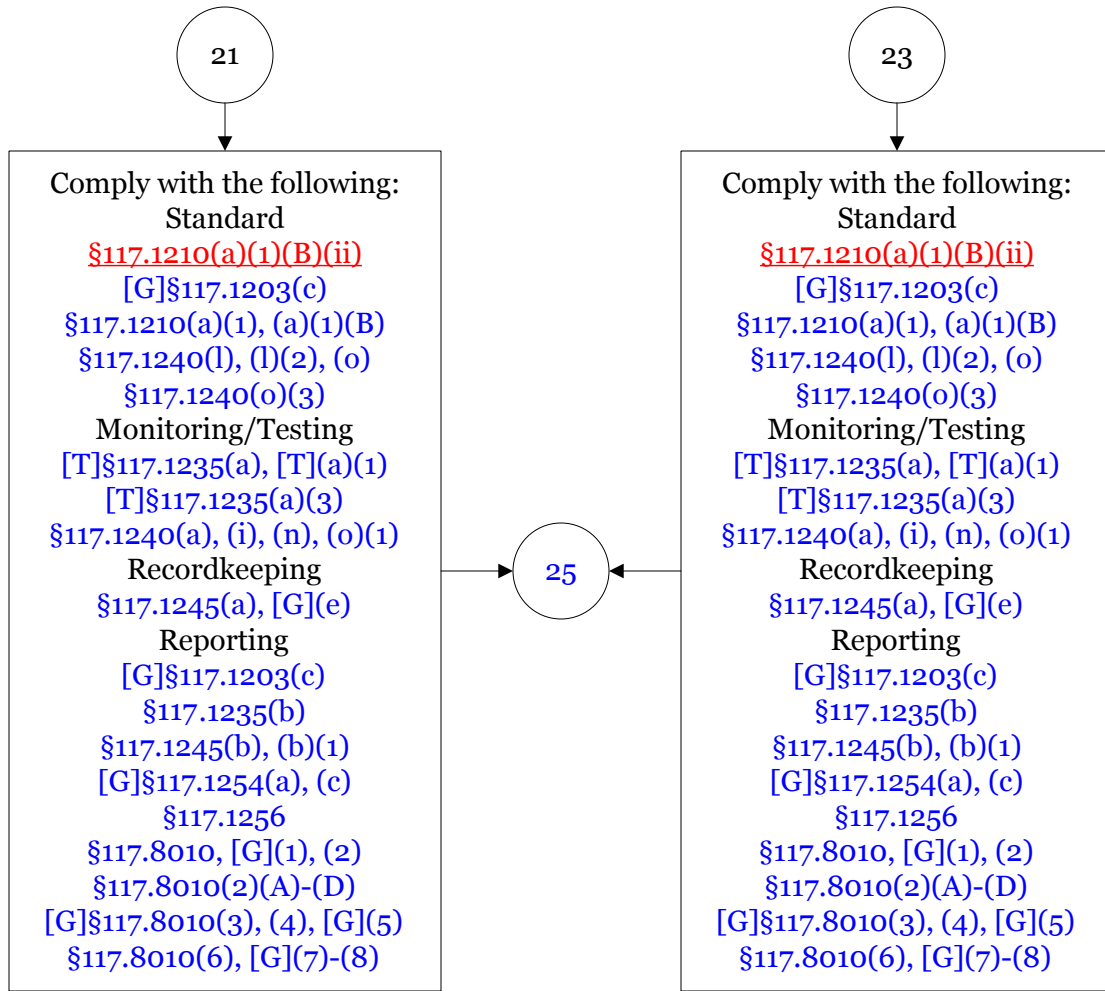

**30 TAC Chapter 117, Subchapter C, Combustion Control at Major Utility  
Electric Generation Sources, Division 3: H-G-B Ozone Nonattainment Area  
Utility Electric Generation Sources**

18 of 39

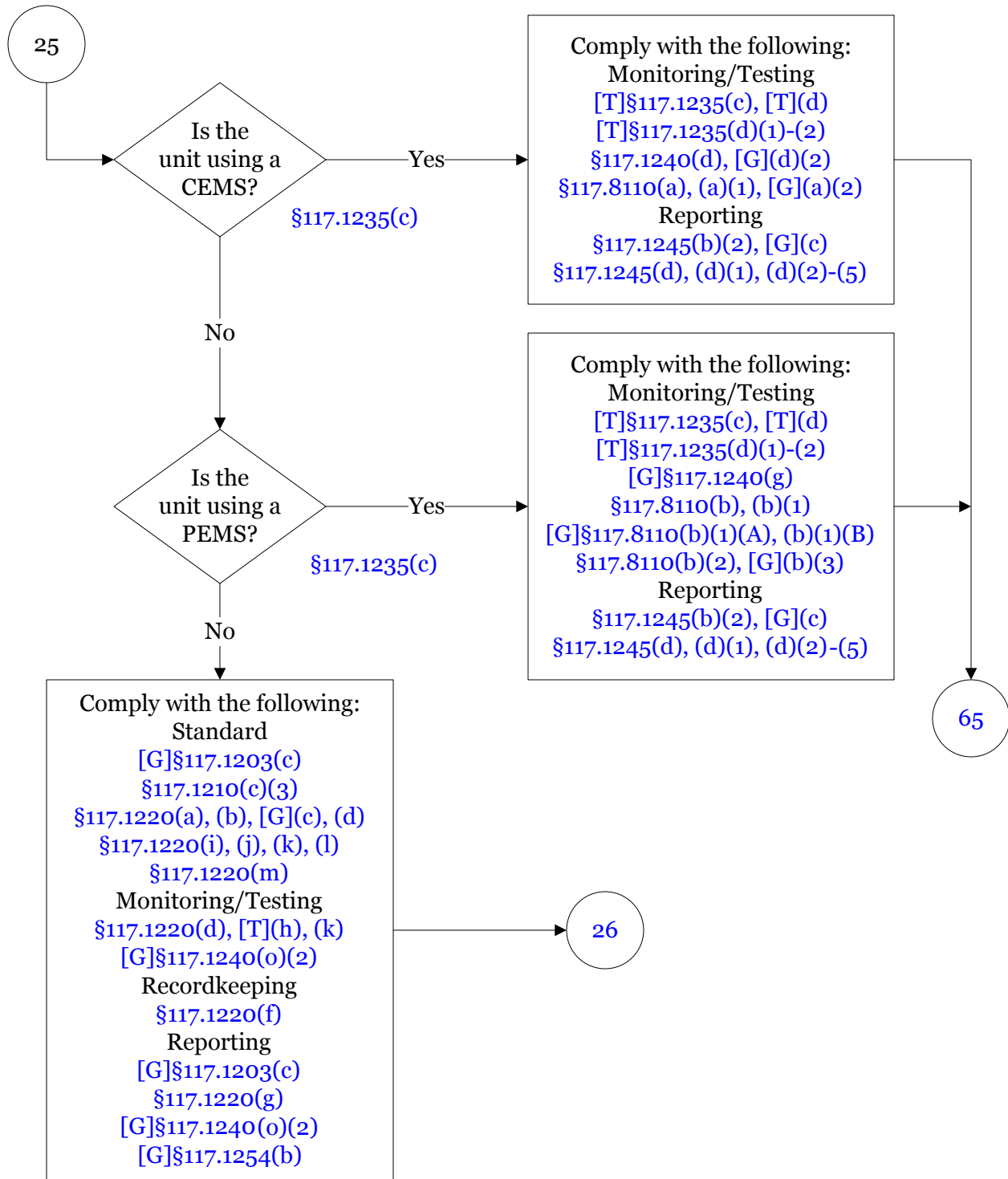

**30 TAC Chapter 117, Subchapter C, Combustion Control at Major Utility  
Electric Generation Sources, Division 3: H-G-B Ozone Nonattainment Area  
Utility Electric Generation Sources**

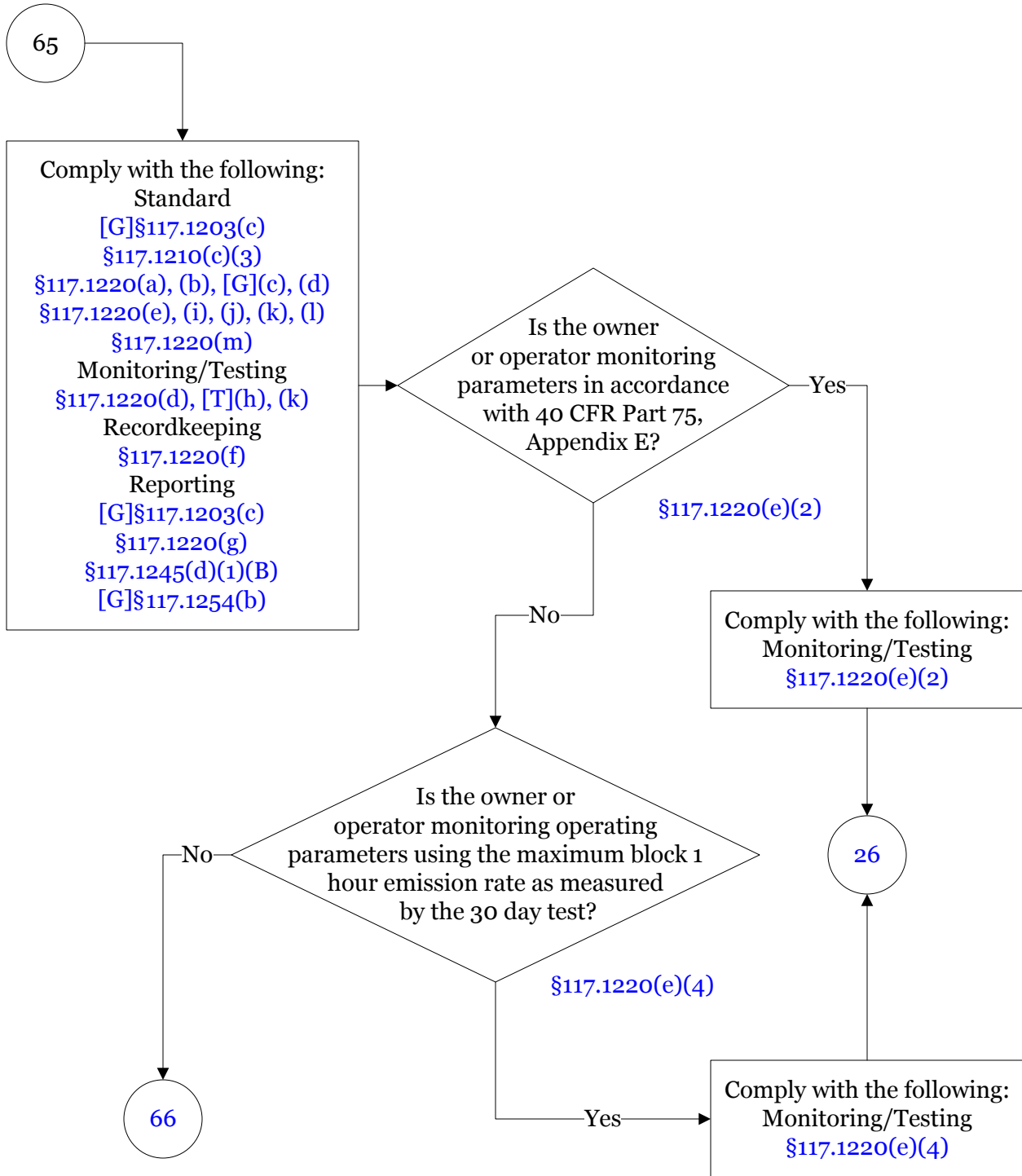

**30 TAC Chapter 117, Subchapter C, Combustion Control at Major Utility  
Electric Generation Sources, Division 3: H-G-B Ozone Nonattainment Area  
Utility Electric Generation Sources**

20 of 39

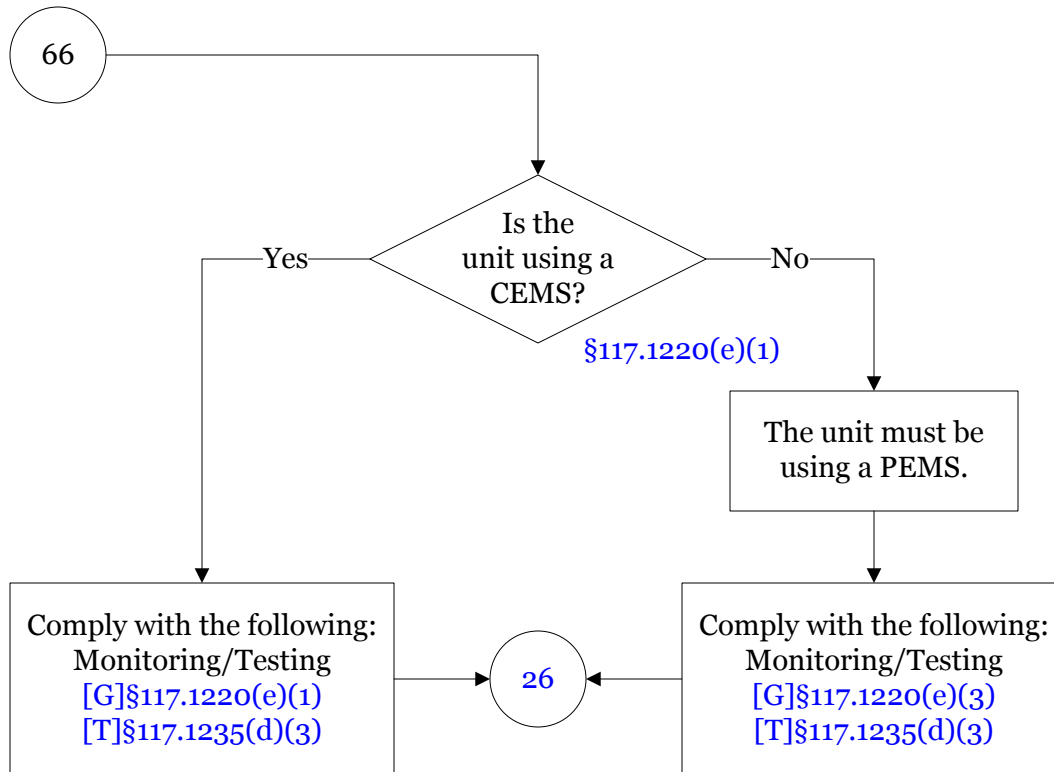

**30 TAC Chapter 117, Subchapter C, Combustion Control at Major Utility  
Electric Generation Sources, Division 3: H-G-B Ozone Nonattainment Area  
Utility Electric Generation Sources**

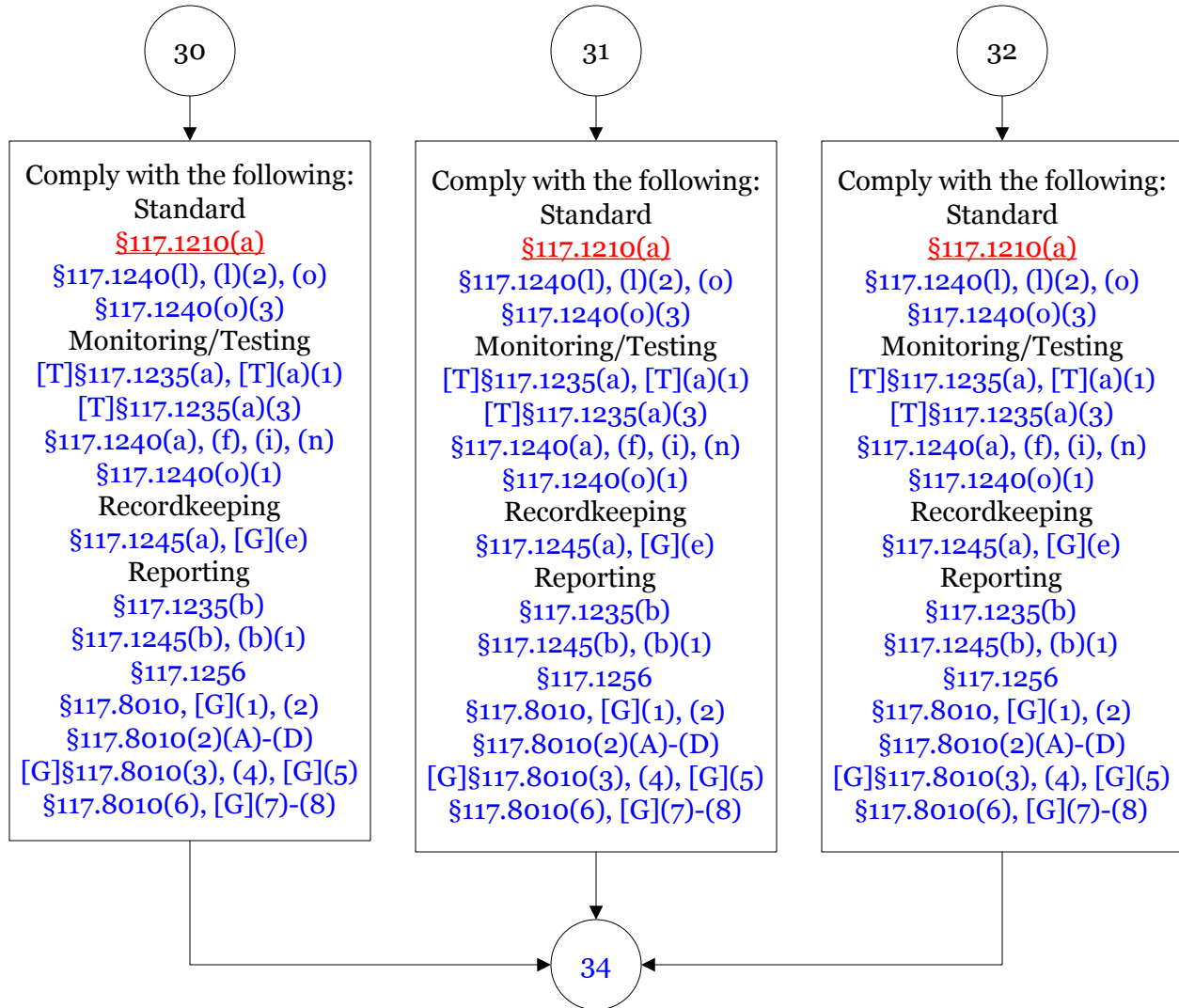

**30 TAC Chapter 117, Subchapter C, Combustion Control at Major Utility  
Electric Generation Sources, Division 3: H-G-B Ozone Nonattainment Area  
Utility Electric Generation Sources**

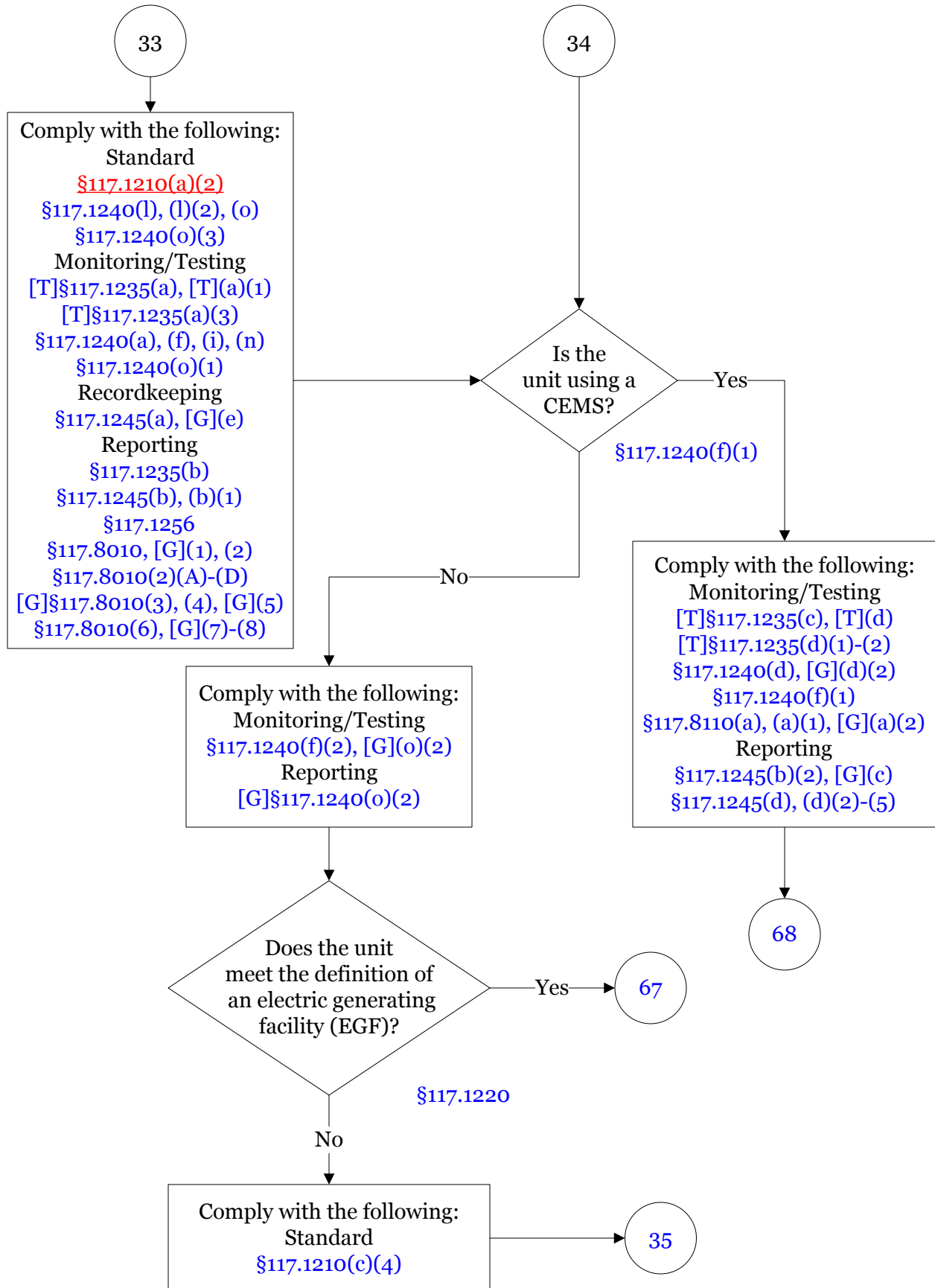

30 TAC Chapter 117, Subchapter C, Combustion Control at Major Utility  
Electric Generation Sources, Division 3: H-G-B Ozone Nonattainment Area  
Utility Electric Generation Sources

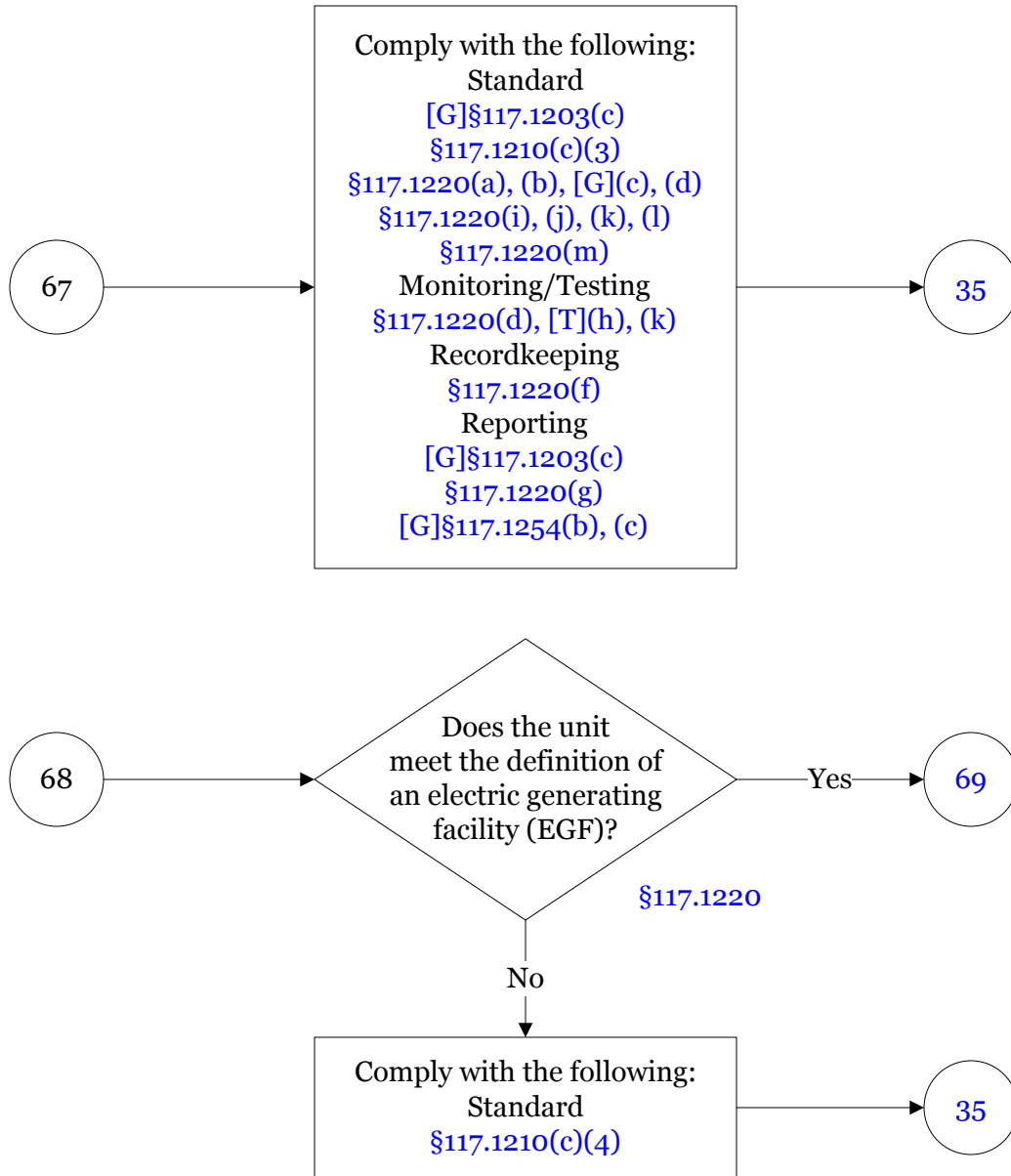

**30 TAC Chapter 117, Subchapter C, Combustion Control at Major Utility  
Electric Generation Sources, Division 3: H-G-B Ozone Nonattainment Area  
Utility Electric Generation Sources**

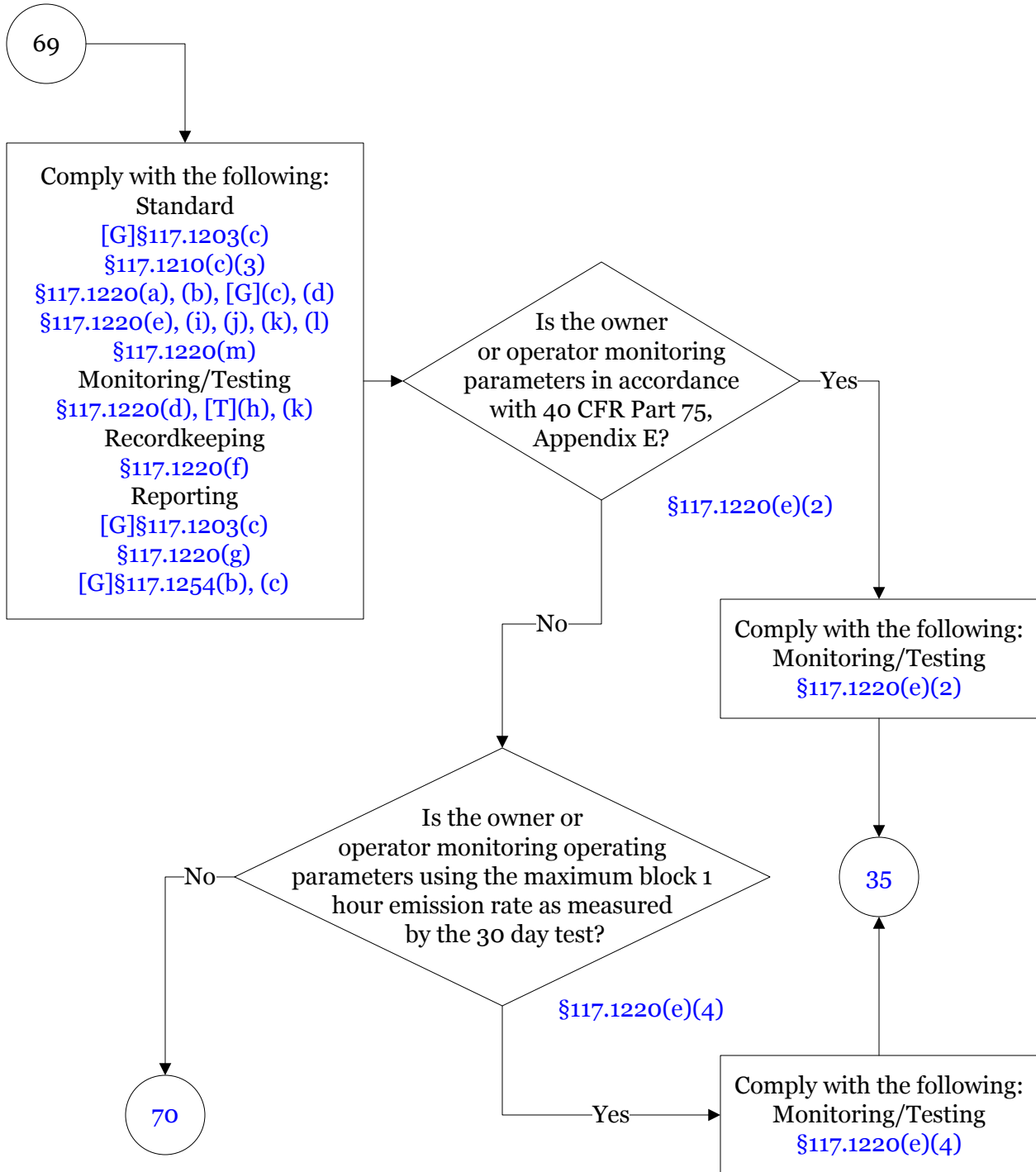



30 TAC Chapter 117, Subchapter C, Combustion Control at Major Utility  
Electric Generation Sources, Division 3: H-G-B Ozone Nonattainment Area  
Utility Electric Generation Sources

25 of 39

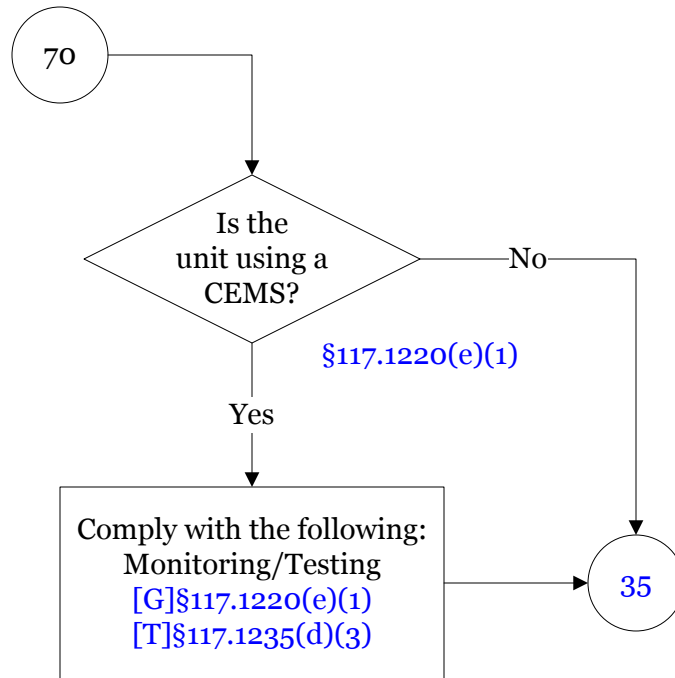

**30 TAC Chapter 117, Subchapter C, Combustion Control at Major Utility  
Electric Generation Sources, Division 3: H-G-B Ozone Nonattainment Area  
Utility Electric Generation Sources**

26 of 39

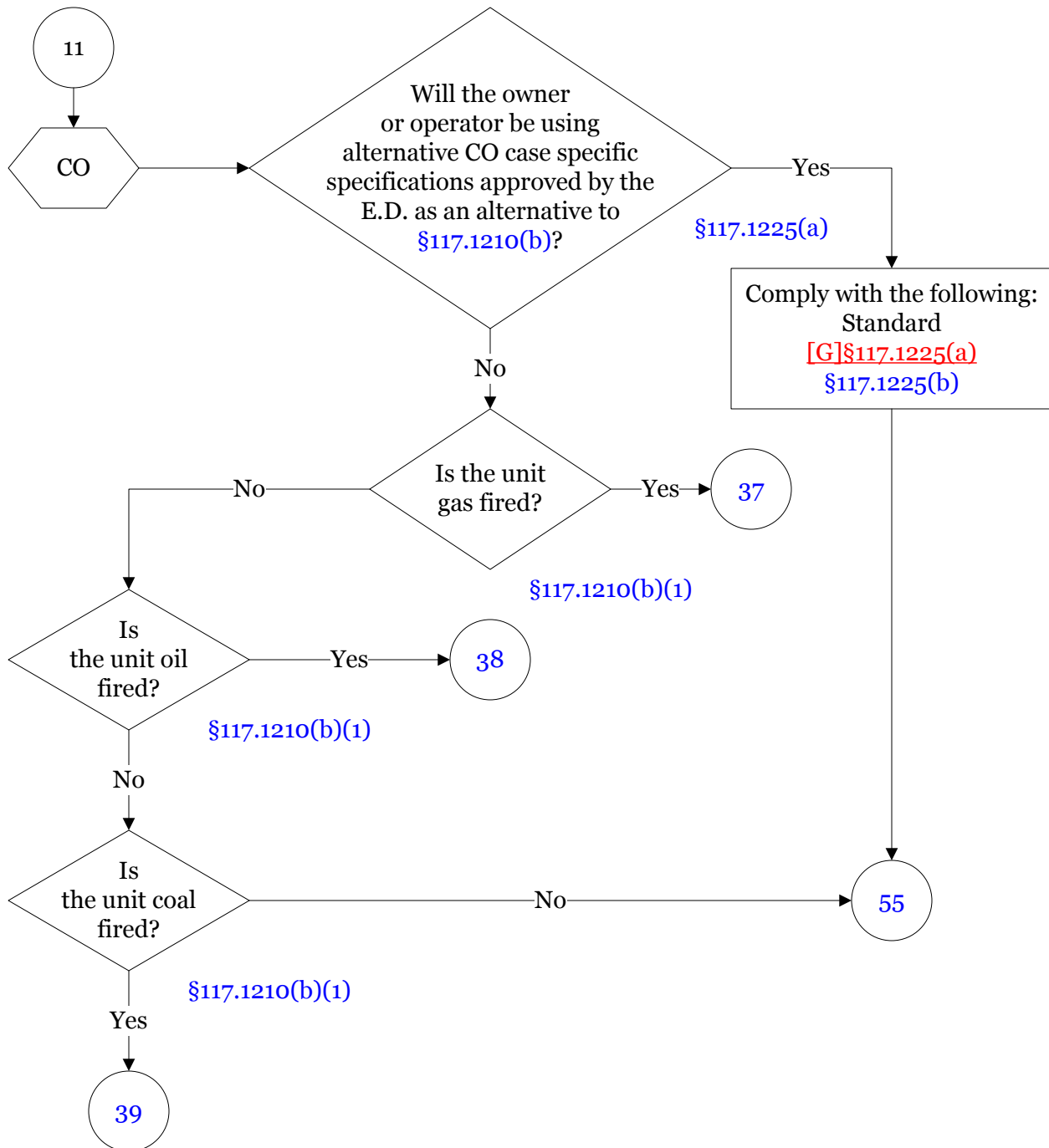

**30 TAC Chapter 117, Subchapter C, Combustion Control at Major Utility  
Electric Generation Sources, Division 3: H-G-B Ozone Nonattainment Area  
Utility Electric Generation Sources**

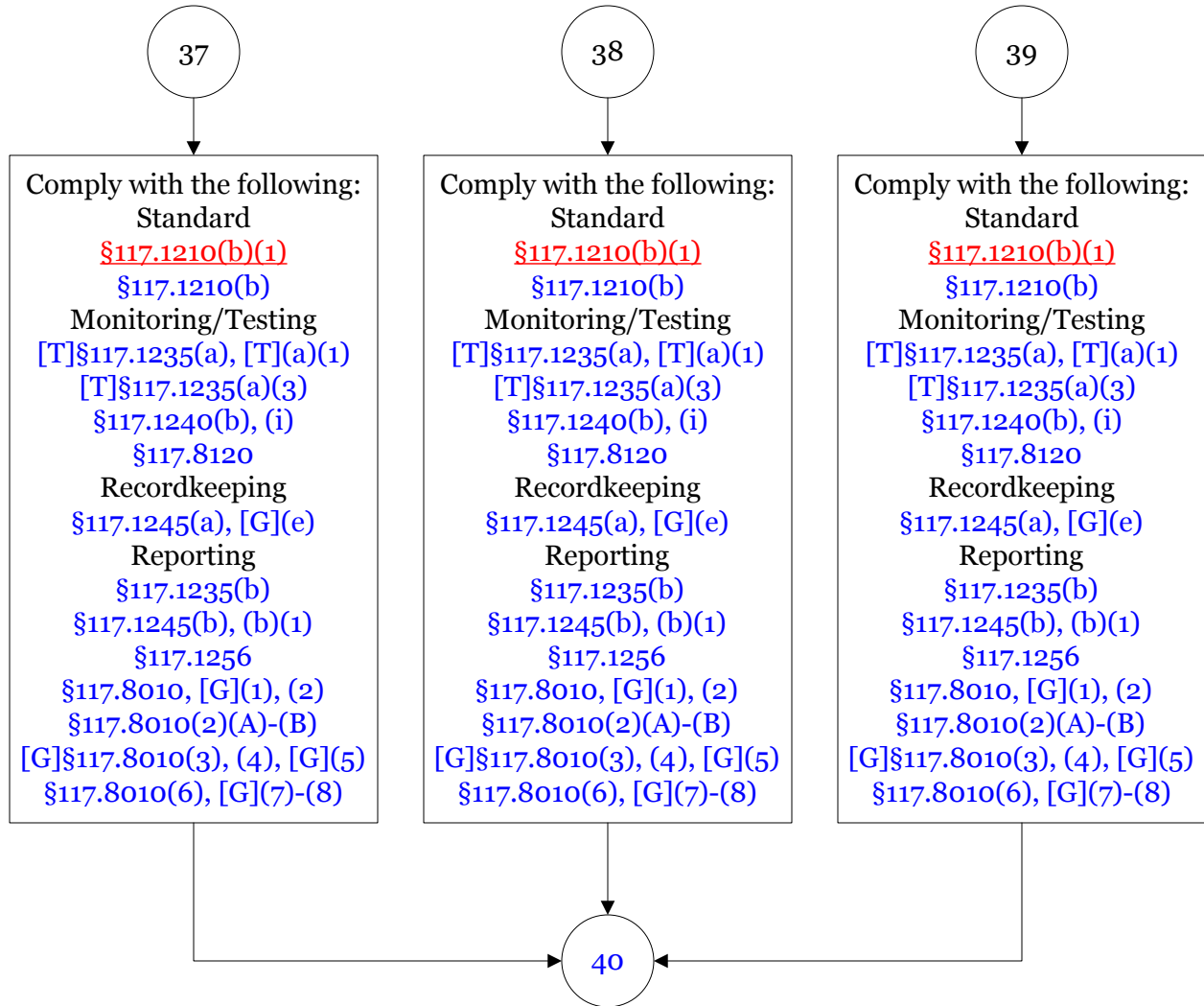

**30 TAC Chapter 117, Subchapter C, Combustion Control at Major Utility  
Electric Generation Sources, Division 3: H-G-B Ozone Nonattainment Area  
Utility Electric Generation Sources**

28 of 39

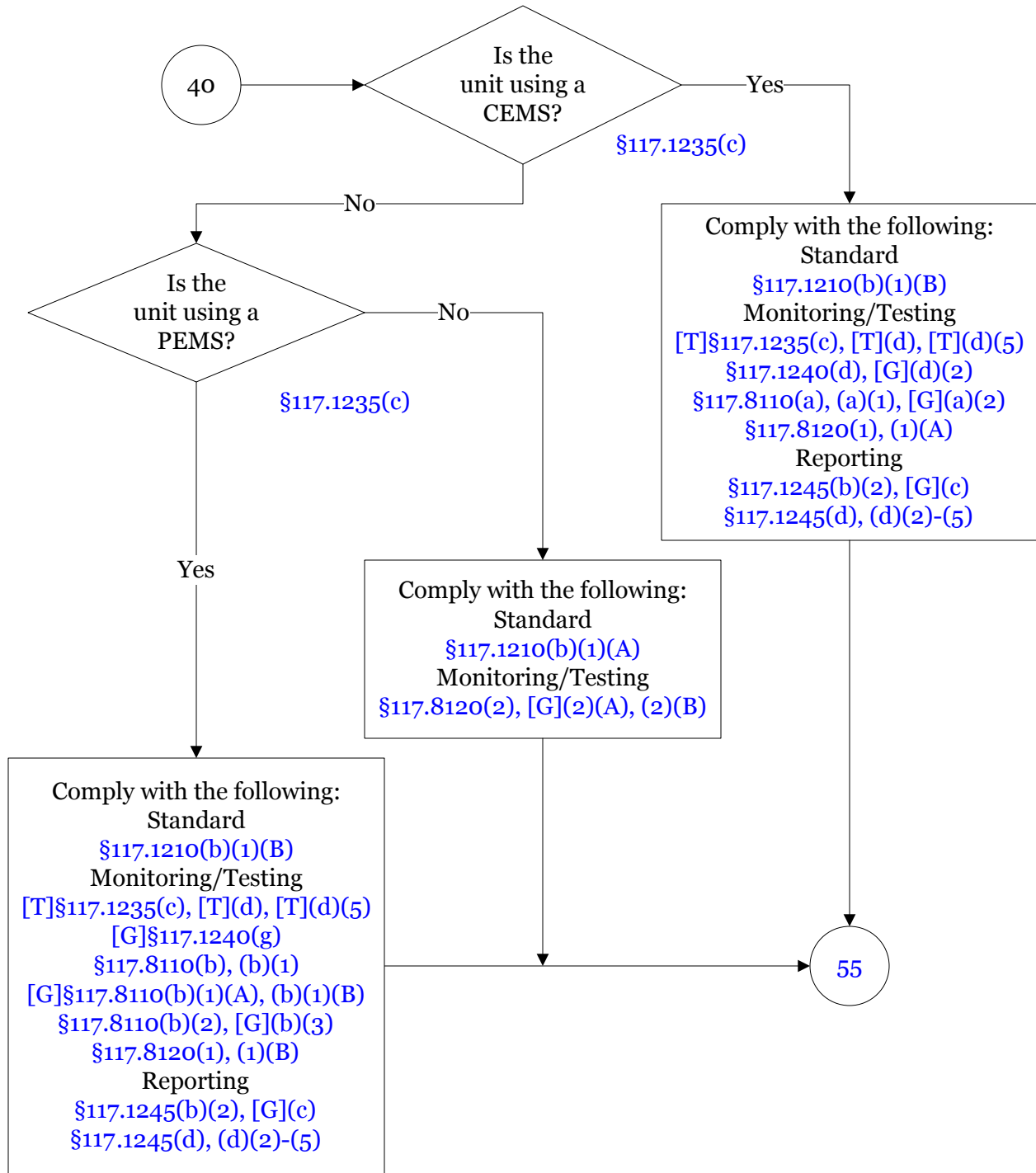

**30 TAC Chapter 117, Subchapter C, Combustion Control at Major Utility  
Electric Generation Sources, Division 3: H-G-B Ozone Nonattainment Area  
Utility Electric Generation Sources**

29 of 39

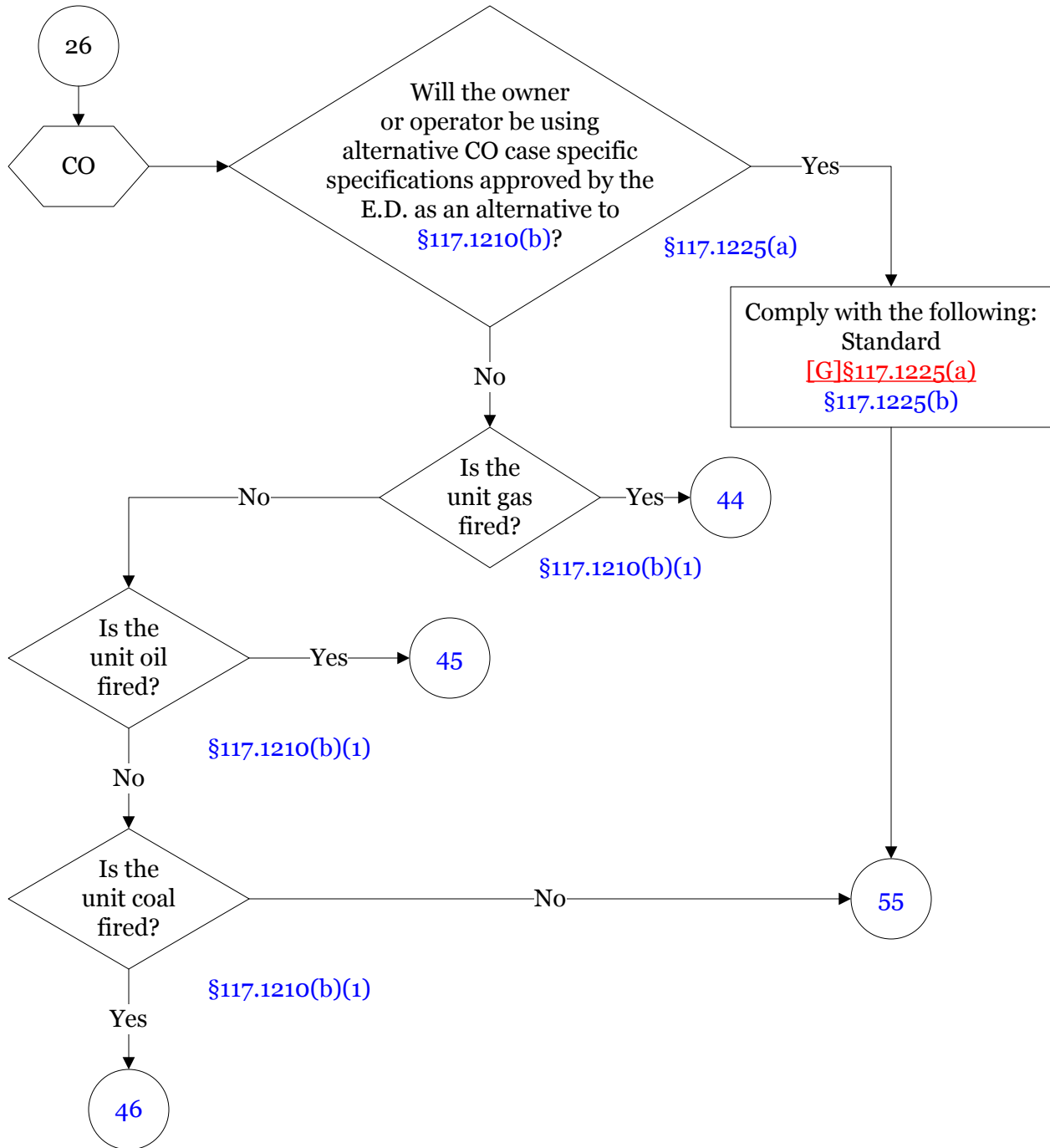

**30 TAC Chapter 117, Subchapter C, Combustion Control at Major Utility  
Electric Generation Sources, Division 3: H-G-B Ozone Nonattainment Area  
Utility Electric Generation Sources**

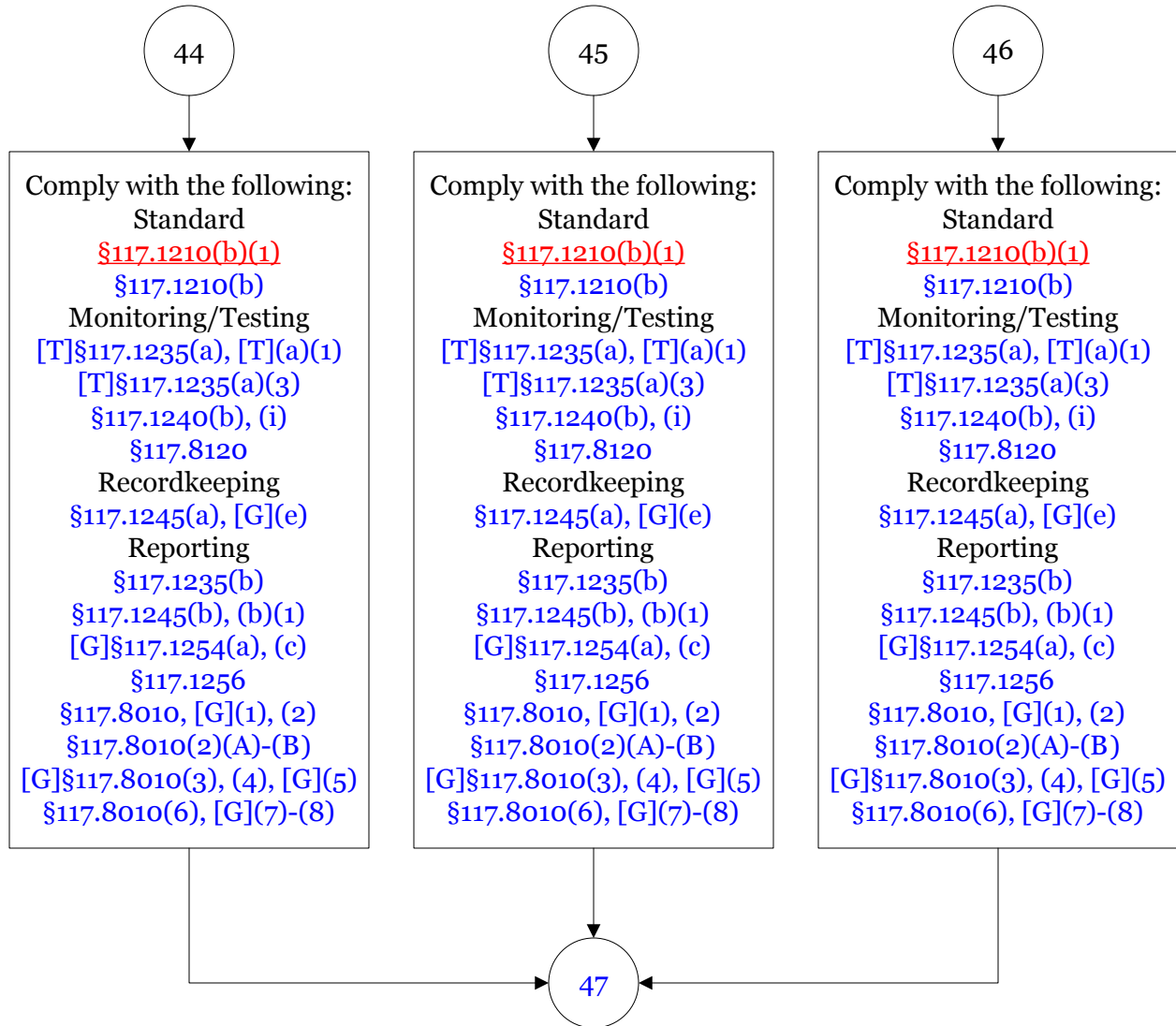

**30 TAC Chapter 117, Subchapter C, Combustion Control at Major Utility  
Electric Generation Sources, Division 3: H-G-B Ozone Nonattainment Area  
Utility Electric Generation Sources**

31 of 39

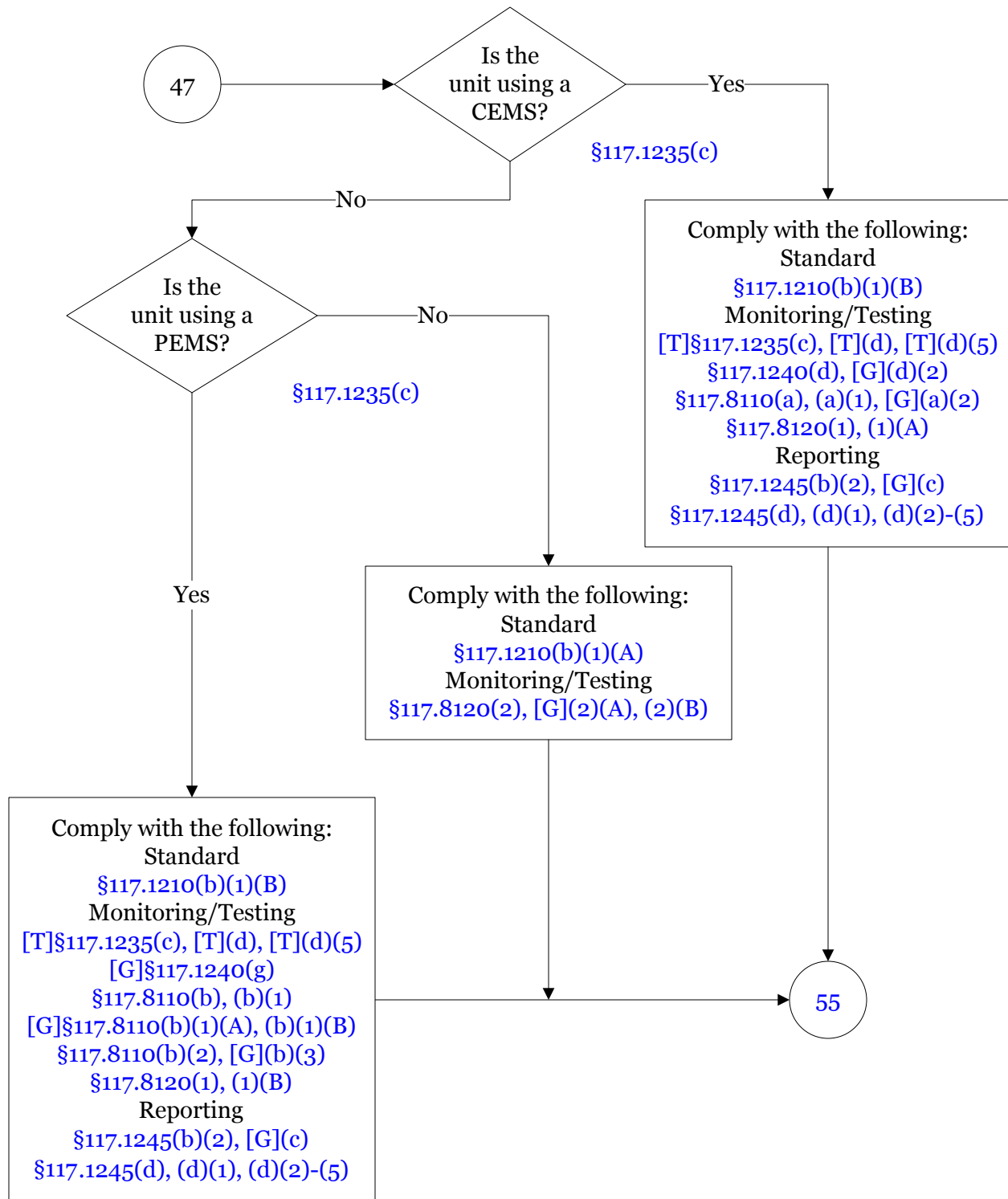

**30 TAC Chapter 117, Subchapter C, Combustion Control at Major Utility  
Electric Generation Sources, Division 3: H-G-B Ozone Nonattainment Area  
Utility Electric Generation Sources**

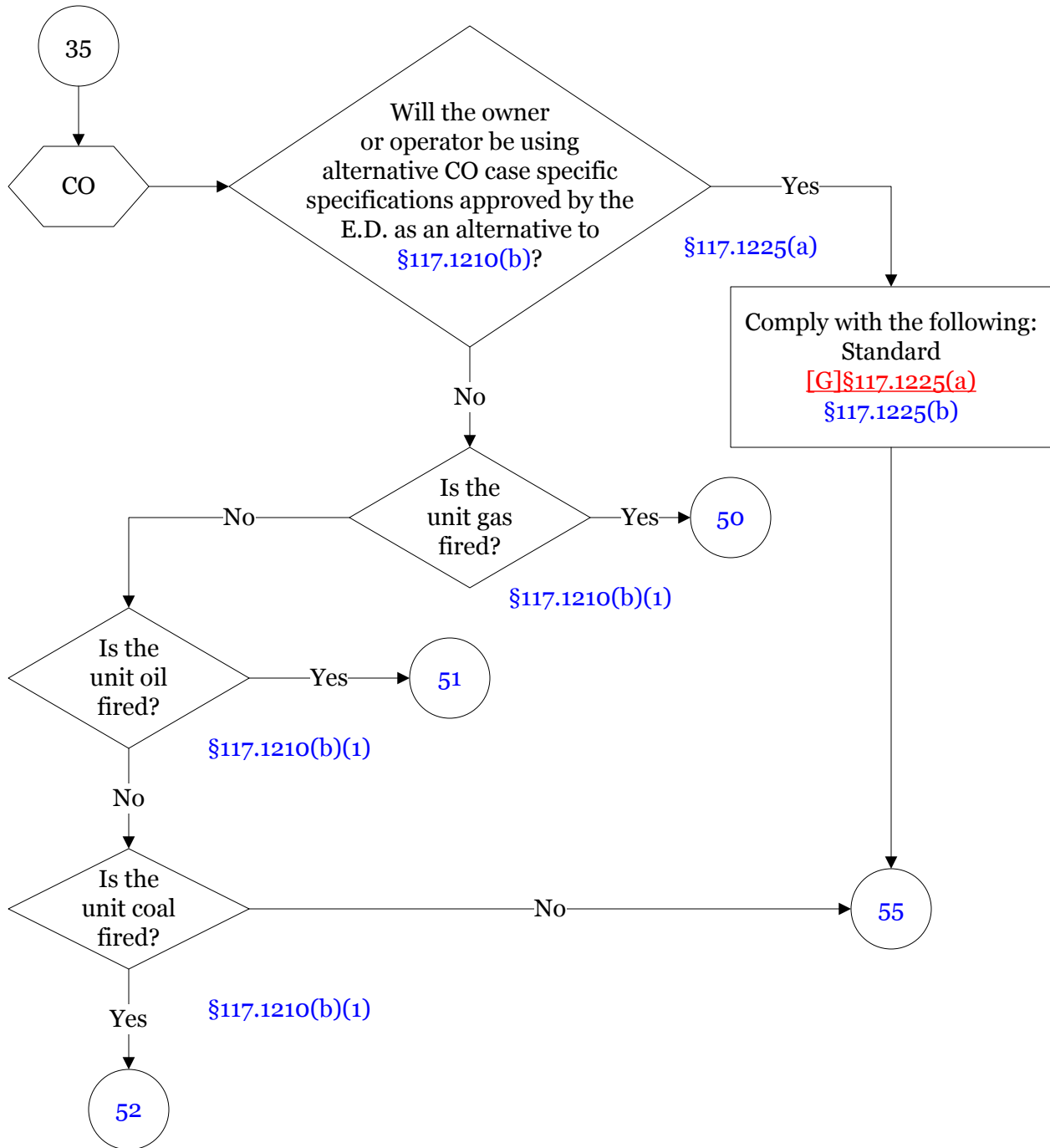



**30 TAC Chapter 117, Subchapter C, Combustion Control at Major Utility  
Electric Generation Sources, Division 3: H-G-B Ozone Nonattainment Area  
Utility Electric Generation Sources**

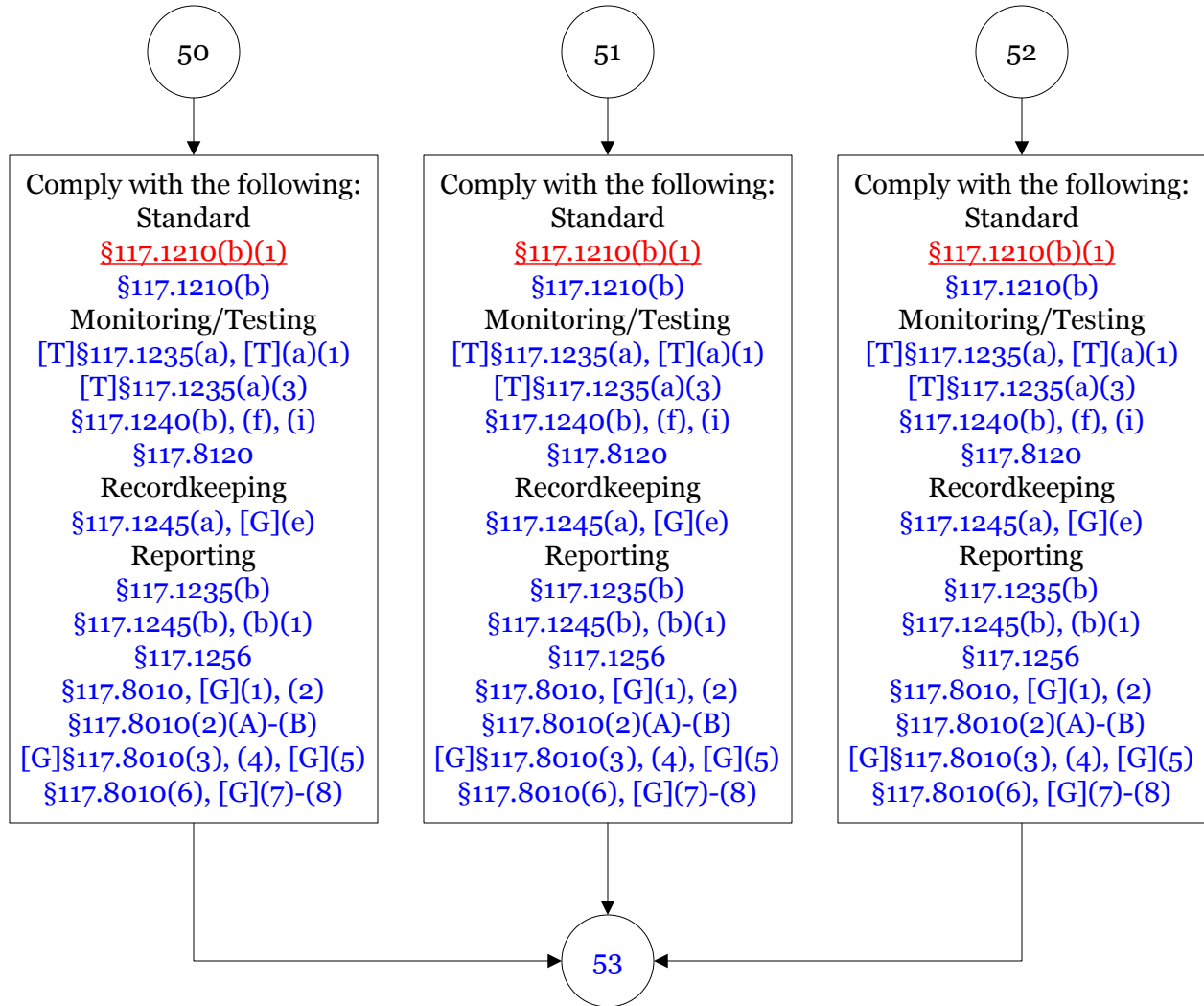

30 TAC Chapter 117, Subchapter C, Combustion Control at Major Utility  
Electric Generation Sources, Division 3: H-G-B Ozone Nonattainment Area  
Utility Electric Generation Sources

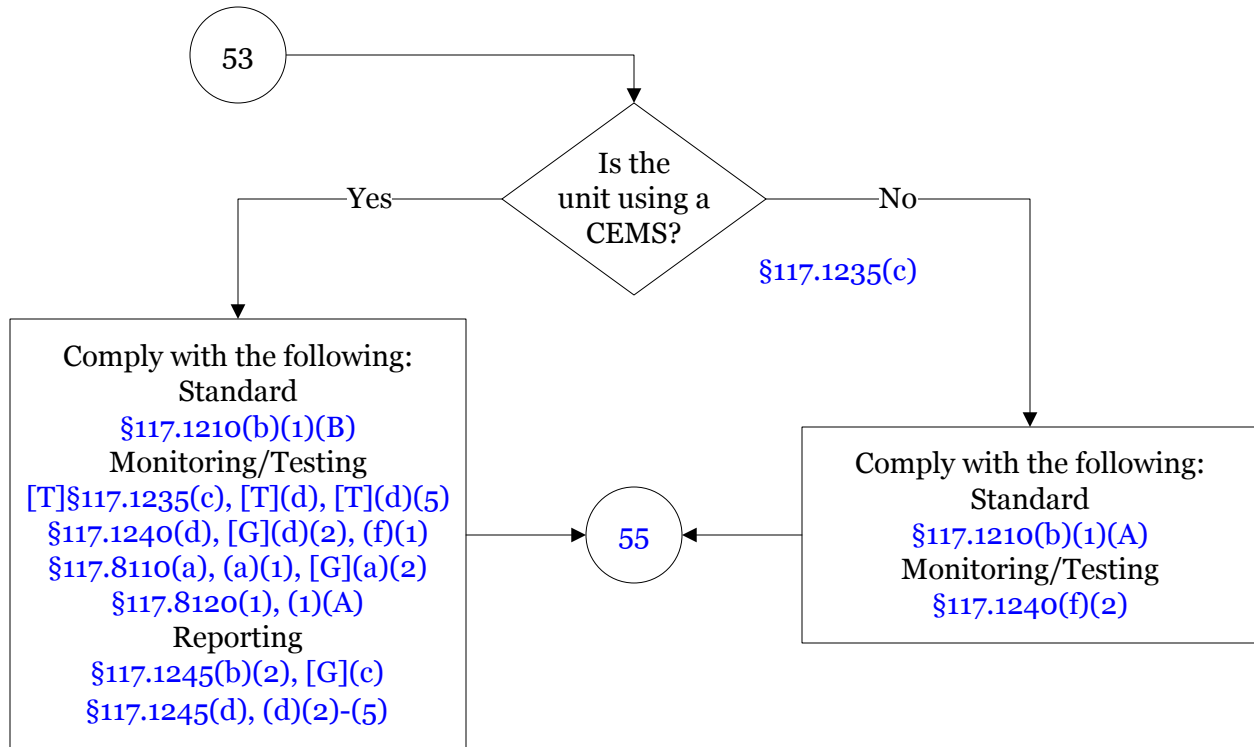

**30 TAC Chapter 117, Subchapter C, Combustion Control at Major Utility  
Electric Generation Sources, Division 3: H-G-B Ozone Nonattainment Area  
Utility Electric Generation Sources**

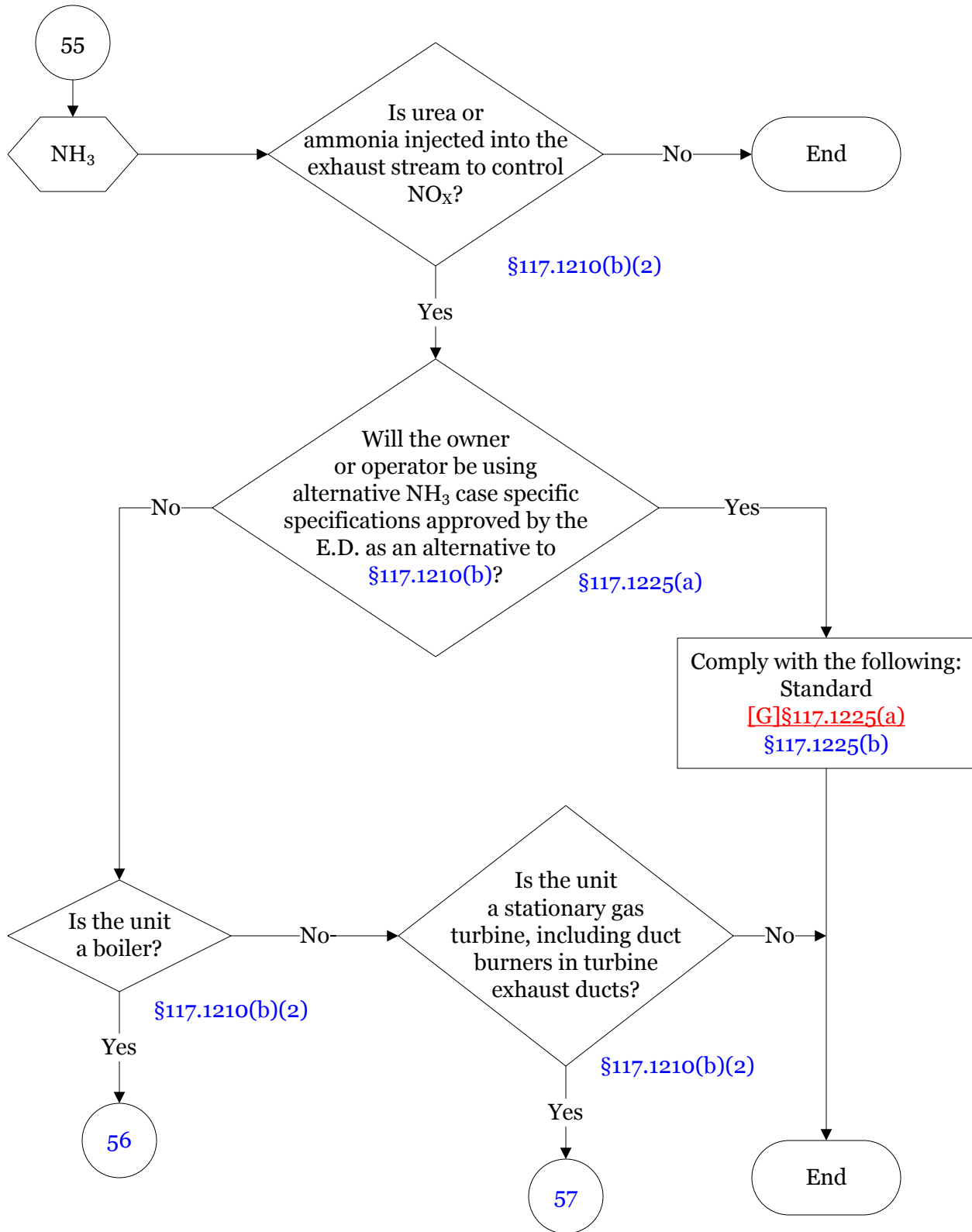

**30 TAC Chapter 117, Subchapter C, Combustion Control at Major Utility  
Electric Generation Sources, Division 3: H-G-B Ozone Nonattainment Area  
Utility Electric Generation Sources**

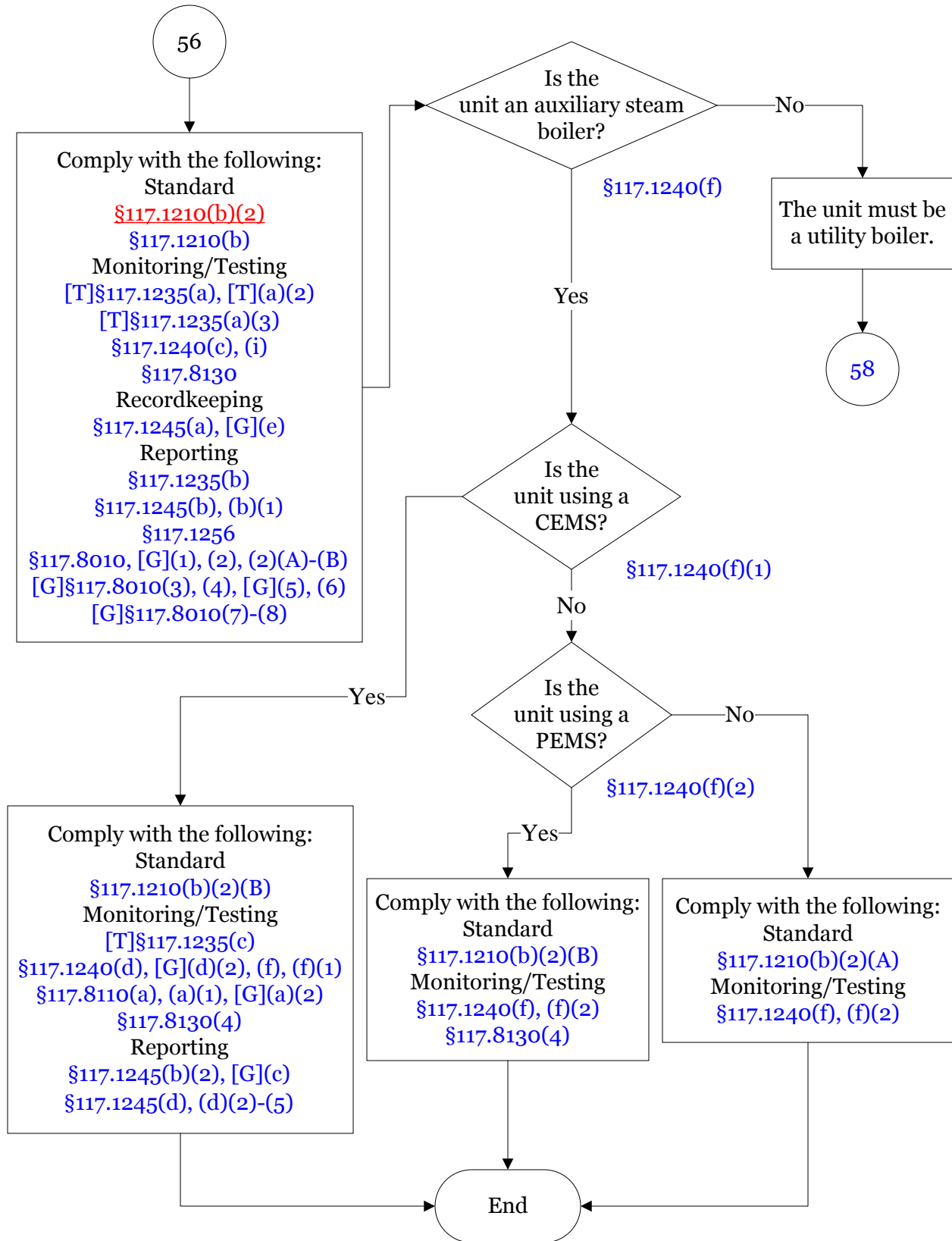

**30 TAC Chapter 117, Subchapter C, Combustion Control at Major Utility  
Electric Generation Sources, Division 3: H-G-B Ozone Nonattainment Area  
Utility Electric Generation Sources**

37 of 39

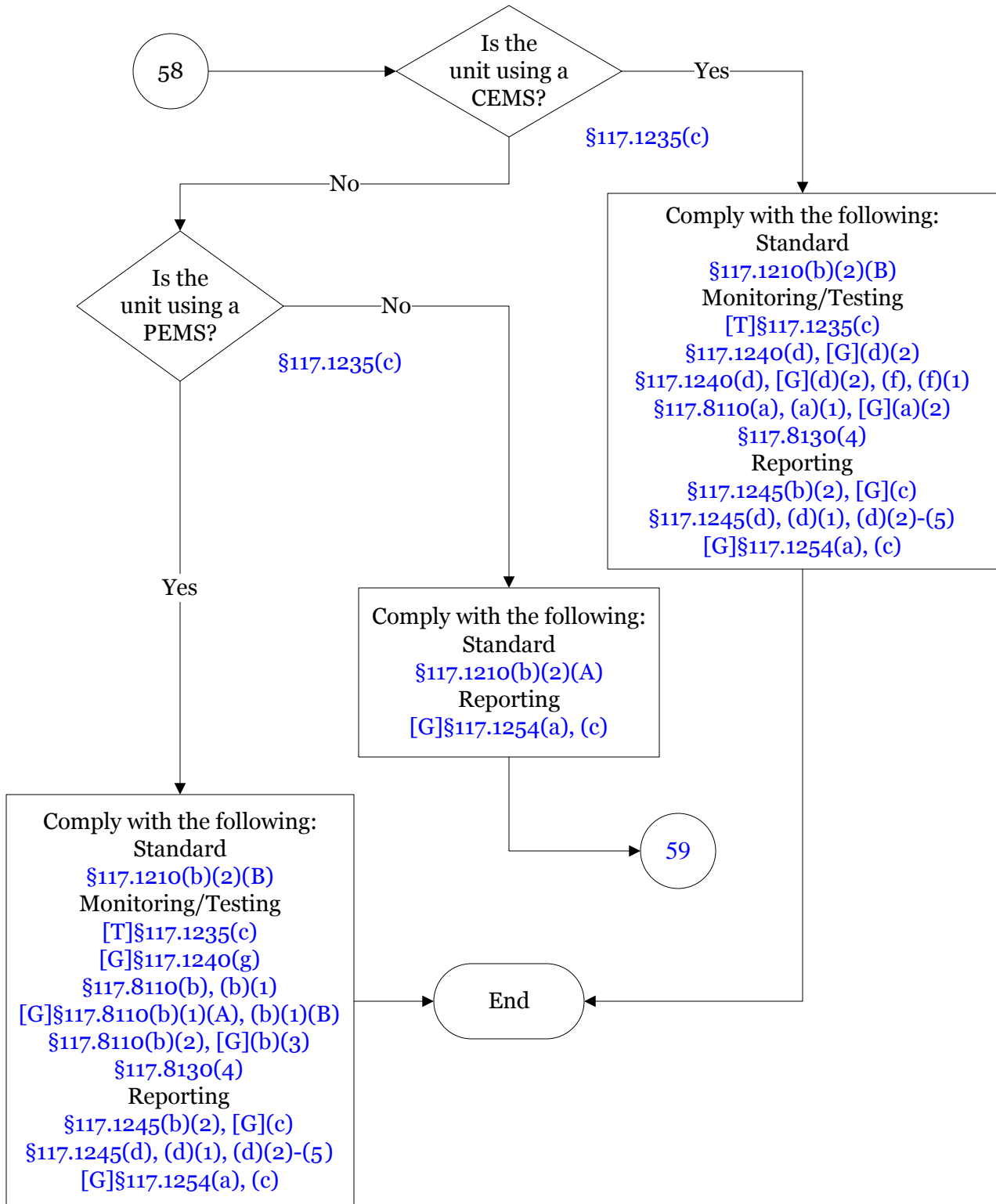

**30 TAC Chapter 117, Subchapter C, Combustion Control at Major Utility  
Electric Generation Sources, Division 3: H-G-B Ozone Nonattainment Area  
Utility Electric Generation Sources**

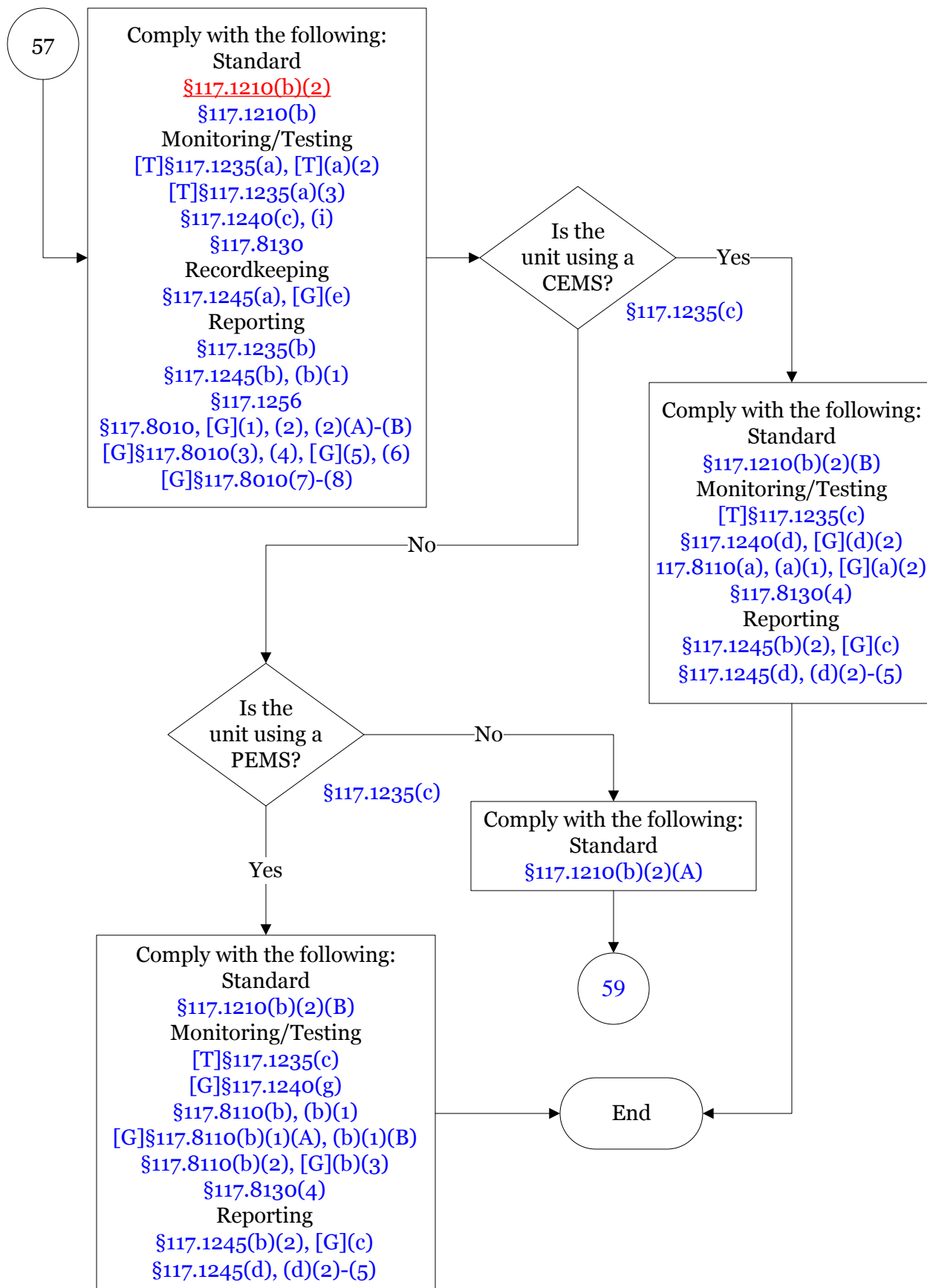

30 TAC Chapter 117, Subchapter C, Combustion Control at Major Utility  
Electric Generation Sources, Division 3: H-G-B Ozone Nonattainment Area  
Utility Electric Generation Sources

39 of 39

