

# TCEQ CONTRIBUTING ZONE PLAN APPLICATION

ACTON ACADEMY  
PHASE 1



Prepared by:  
Green Civil Design, LLC.  
Texas Registered Engineering Firm F-17563  
301 Denali Pass, Suite 3  
Cedar Park, TX, 78613  
T: (512) 640-6590  
F: (512) 551-4255



## **TABLE OF CONTENTS**

- **Edwards Aquifer Application Cover Page (TCEQ-20705)**
- **Agent Authorization Form (TCEQ-0599)**
- **Application Fee Form (TCEQ-0574)**
- **Core Data Form (TCEQ-10400)**
- **Contributing Zone Plan Application (TCEQ-10257)**
  - Application
  - Attachment A – Road Map
  - Attachment B – USGS Quadrangle Map
  - Attachment C – Project Narrative
  - Attachment D – Factors Affecting Surface Water Quality
  - Attachment E – Volume and Character of Stormwater
  - Attachment F – Suitability Letter from Authorized Agent
  - Attachment G – Alternative Secondary Containment
  - Attachment H – AST Containment Structure Drawings
  - Attachment I – 20% or Less Impervious Cover Waiver
  - Attachment J – BMPs for Upgradient Stormwater
  - Attachment K – BMPs for On-Site Stormwater
  - Attachment L – BMPs for Surface Streams
  - Attachment M – Construction Plans
  - Attachment N – Inspection, Maintenance, Repair, and Retrofit Plan
  - Attachment O – Pilot Scale Field Testing Plan
  - Attachment P – Measures for Minimizing Surface Stream Contamination
- **Temporary Stormwater Section (TCEQ-0602)**
  - Application
  - Attachment A – Spill Response Plan
  - Attachment B – Potential Sources of Contamination
  - Attachment C – Sequence of Major Activities
  - Attachment D – Temporary Best Management Practices and Measures
  - Attachment E – Request to Temporarily Seal a Feature
  - Attachment F – Structural Practices
  - Attachment G – Drainage Area Map
  - Attachment H – Temporary Sediment Pond(s) Plans and Calculations
  - Attachment I – Inspection and Maintenance for BMPs
  - Attachment J – Schedule of Interim and Permanent Soil Stabilization Practices

# Texas Commission on Environmental Quality

## Edwards Aquifer Application Cover Page

---

### Our Review of Your Application

**The Edwards Aquifer Program staff conducts an administrative and technical review of all applications. The turnaround time for administrative review can be up to 30 days as outlined in 30 TAC 213.4(e). Generally administrative completeness is determined during the intake meeting or within a few days of receipt. The turnaround time for technical review of an administratively complete Edwards Aquifer application is 90 days as outlined in 30 TAC 213.4(e). Please know that the review and approval time is directly impacted by the quality and completeness of the initial application that is received. In order to conduct a timely review, it is imperative that the information provided in an Edwards Aquifer application include final plans, be accurate, complete, and in compliance with [30 TAC 213](#).**

### Administrative Review

1. [Edwards Aquifer applications](#) must be deemed administratively complete before a technical review can begin. To be considered administratively complete, the application must contain completed forms and attachments, provide the requested information, and meet all the site plan requirements. The submitted application and plan sheets should be final plans. Please submit one full-size set of plan sheets with the original application, and half-size sets with the additional copies.

To ensure that all applicable documents are included in the application, the program has developed tools to guide you and web pages to provide all forms, checklists, and guidance. Please visit the below website for assistance: <http://www.tceq.texas.gov/field/eapp>.

2. This Edwards Aquifer Application Cover Page form (certified by the applicant or agent) must be included in the application and brought to the administrative review meeting.
3. Administrative reviews are scheduled with program staff who will conduct the review. Applicants or their authorized agent should call the appropriate regional office, according to the county in which the project is located, to schedule a review. The average meeting time is one hour.
4. In the meeting, the application is examined for administrative completeness. Deficiencies will be noted by staff and emailed or faxed to the applicant and authorized agent at the end of the meeting, or shortly after. Administrative deficiencies will cause the application to be deemed incomplete and returned.

An appointment should be made to resubmit the application. The application is re-examined to ensure all deficiencies are resolved. The application will only be deemed administratively complete when all administrative deficiencies are addressed.

5. If an application is received by mail, courier service, or otherwise submitted without a review meeting, the administrative review will be conducted within 30 days. The applicant and agent will be contacted with the results of the administrative review. If the application is found to be administratively incomplete, it can be retrieved from the regional office or returned by regular mail. If returned by mail, the regional office may require arrangements for return shipping.
6. If the geologic assessment was completed before October 1, 2004 and the site contains “possibly sensitive” features, the assessment must be updated in accordance with the *Instructions to Geologists* (TCEQ-0585 Instructions).

### Technical Review

1. When an application is deemed administratively complete, the technical review period begins. The regional office will distribute copies of the application to the identified affected city, county, and groundwater conservation district whose jurisdiction includes the subject site. These entities and the public have 30 days to provide comments on the application to the regional office. All comments received are reviewed by TCEQ.
2. A site assessment is usually conducted as part of the technical review, to evaluate the geologic assessment and observe existing site conditions. The site must be accessible to our staff. The site boundaries should be

clearly marked, features identified in the geologic assessment should be flagged, roadways marked and the alignment of the Sewage Collection System and manholes should be staked at the time the application is submitted. If the site is not marked the application may be returned.

3. We evaluate the application for technical completeness and contact the applicant and agent via Notice of Deficiency (NOD) to request additional information and identify technical deficiencies. There are two deficiency response periods available to the applicant. There are 14 days to resolve deficiencies noted in the first NOD. If a second NOD is issued, there is an additional 14 days to resolve deficiencies. If the response to the second notice is not received, is incomplete or inadequate, or provides new information that is incomplete or inadequate, the application must be withdrawn or will be denied. Please note that because the technical review is underway, whether the application is withdrawn or denied **the application fee will be forfeited**.
4. The program has 90 calendar days to complete the technical review of the application. If the application is technically adequate, such that it complies with the Edwards Aquifer rules, and is protective of the Edwards Aquifer during and after construction, an approval letter will be issued. Construction or other regulated activity may not begin until an approval is issued.

**Mid-Review Modifications**

It is important to have final site plans prior to beginning the permitting process with TCEQ to avoid delays.

Occasionally, circumstances arise where you may have significant design and/or site plan changes after your Edwards Aquifer application has been deemed administratively complete by TCEQ. This is considered a “Mid-Review Modification”. Mid-Review Modifications may require redistribution of an application that includes the proposed modifications for public comment.

If you are proposing a Mid-Review Modification, two options are available:

- If the technical review has begun your application can be denied/withdrawn, your fees will be forfeited, and the plan will have to be resubmitted.
- TCEQ can continue the technical review of the application as it was submitted, and a modification application can be submitted at a later time.

If the application is denied/withdrawn, the resubmitted application will be subject to the administrative and technical review processes and will be treated as a new application. The application will be redistributed to the affected jurisdictions.

Please contact the regional office if you have questions. If your project is located in Williamson, Travis, or Hays County, contact TCEQ’s Austin Regional Office at 512-339-2929. If your project is in Comal, Bexar, Medina, Uvalde, or Kinney County, contact TCEQ’s San Antonio Regional Office at 210-490-3096

Please fill out all required fields below and submit with your application.

<b>1. Regulated Entity Name: Acton Academy</b>					<b>2. Regulated Entity No.:</b>				
<b>3. Customer Name: HCA Properties, LLC</b>					<b>4. Customer No.:</b>				
<b>5. Project Type:</b> (Please circle/check one)	<input checked="" type="radio"/> New	Modification			Extension		Exception		
<b>6. Plan Type:</b> (Please circle/check one)	<input type="radio"/> WPAP	<input checked="" type="radio"/> CZP	<input type="radio"/> SCS	<input type="radio"/> UST	<input type="radio"/> AST	<input type="radio"/> EXP	<input type="radio"/> EXT	Technical Clarification	Optional Enhanced Measures
<b>7. Land Use:</b> (Please circle/check one)	<input type="radio"/> Residential		<input checked="" type="radio"/> Non-residential			<b>8. Site (acres):</b>		15	
<b>9. Application Fee:</b>	\$6,500		<b>10. Permanent BMP(s):</b>			Batch Pond			
<b>11. SCS (Linear Ft.):</b>	<input checked="" type="radio"/> N/A		<b>12. AST/UST (No. Tanks):</b>			0			
<b>13. County:</b>	Hays		<b>14. Watershed:</b>			Onion Creek			



# Application Distribution

Instructions: Use the table below to determine the number of applications required. One original and one copy of the application, plus additional copies (as needed) for each affected incorporated city, county, and groundwater conservation district are required. Linear projects or large projects, which cross into multiple jurisdictions, can require additional copies. Refer to the “Texas Groundwater Conservation Districts within the EAPP Boundaries” map found at:

[http://www.tceq.texas.gov/assets/public/compliance/field\\_ops/eapp/EAPP%20GWCD%20map.pdf](http://www.tceq.texas.gov/assets/public/compliance/field_ops/eapp/EAPP%20GWCD%20map.pdf)

For more detailed boundaries, please contact the conservation district directly.

<b>Austin Region</b>			
<b>County:</b>	<b>Hays</b>	<b>Travis</b>	<b>Williamson</b>
Original (1 req.)	—	—	—
Region (1 req.)	—	—	—
County(ies)	—	—	—
Groundwater Conservation District(s)	<input type="checkbox"/> Edwards Aquifer Authority <input type="checkbox"/> Barton Springs/ Edwards Aquifer <input type="checkbox"/> Hays Trinity <input type="checkbox"/> Plum Creek	<input type="checkbox"/> Barton Springs/ Edwards Aquifer	NA
City(ies) Jurisdiction	<input type="checkbox"/> Austin <input type="checkbox"/> Buda <input checked="" type="checkbox"/> Dripping Springs <input type="checkbox"/> Kyle <input type="checkbox"/> Mountain City <input type="checkbox"/> San Marcos <input type="checkbox"/> Wimberley <input type="checkbox"/> Woodcreek	<input type="checkbox"/> Austin <input type="checkbox"/> Bee Cave <input type="checkbox"/> Pflugerville <input type="checkbox"/> Rollingwood <input type="checkbox"/> Round Rock <input type="checkbox"/> Sunset Valley <input type="checkbox"/> West Lake Hills	<input type="checkbox"/> Austin <input type="checkbox"/> Cedar Park <input type="checkbox"/> Florence <input type="checkbox"/> Georgetown <input type="checkbox"/> Jerrell <input type="checkbox"/> Leander <input type="checkbox"/> Liberty Hill <input type="checkbox"/> Pflugerville <input type="checkbox"/> Round Rock

<b>San Antonio Region</b>					
<b>County:</b>	<b>Bexar</b>	<b>Comal</b>	<b>Kinney</b>	<b>Medina</b>	<b>Uvalde</b>
Original (1 req.)	—	—	—	—	—
Region (1 req.)	—	—	—	—	—
County(ies)	—	—	—	—	—
Groundwater Conservation District(s)	<input type="checkbox"/> Edwards Aquifer Authority <input type="checkbox"/> Trinity-Glen Rose	<input type="checkbox"/> Edwards Aquifer Authority	<input type="checkbox"/> Kinney	<input type="checkbox"/> EAA <input type="checkbox"/> Medina	<input type="checkbox"/> EAA <input type="checkbox"/> Uvalde
City(ies) Jurisdiction	<input type="checkbox"/> Castle Hills <input type="checkbox"/> Fair Oaks Ranch <input type="checkbox"/> Helotes <input type="checkbox"/> Hill Country Village <input type="checkbox"/> Hollywood Park <input type="checkbox"/> San Antonio (SAWS) <input type="checkbox"/> Shavano Park	<input type="checkbox"/> Bulverde <input type="checkbox"/> Fair Oaks Ranch <input type="checkbox"/> Garden Ridge <input type="checkbox"/> New Braunfels <input type="checkbox"/> Schertz	NA	<input type="checkbox"/> San Antonio ETJ (SAWS)	NA

I certify that to the best of my knowledge, that the application is complete and accurate. This application is hereby submitted to TCEQ for administrative review and technical review.

*Michael Bevilacqua*

Print Name of Customer/Authorized Agent

*Michael Bevilacqua*

Signature of Customer/Authorized Agent

*10/12/2022*

Date

**FOR TCEQ INTERNAL USE ONLY**			
Date(s) Reviewed:		Date Administratively Complete:	
Received From:		Correct Number of Copies:	
Received By:		Distribution Date:	
EAPP File Number:		Complex:	
Admin. Review(s) (No.):		No. AR Rounds:	
Delinquent Fees (Y/N):		Review Time Spent:	
Lat./Long. Verified:		SOS Customer Verification:	
Agent Authorization Complete/Notarized (Y/N):		Fee Check:	Payable to TCEQ (Y/N):
Core Data Form Complete (Y/N):			Signed (Y/N):
Core Data Form Incomplete Nos.:			Less than 90 days old (Y/N):

**Agent Authorization Form**  
For Required Signature  
Edwards Aquifer Protection Program  
Relating to 30 TAC Chapter 213  
Effective June 1, 1999

I William Jones  
Print Name

owner  
Title - Owner/President/Other

of HCA Properties LLC  
Corporation/Partnership/Entity Name

have authorized Michael E. Bevilacqua, P.E.  
Print Name of Agent/Engineer

of Green Civil Design, LLC  
Print Name of Firm

to represent and act on the behalf of the above named Corporation, Partnership, or Entity for the purpose of preparing and submitting this plan application to the Texas Commission on Environmental Quality (TCEQ) for the review and approval consideration of regulated activities.

I also understand that:

1. The applicant is responsible for compliance with 30 Texas Administrative Code Chapter 213 and any condition of the TCEQ's approval letter. The TCEQ is authorized to assess administrative penalties of up to \$10,000 per day per violation.
2. For those submitting an application who are not the property owner, but who have the right to control and possess the property, additional authorization is required from the owner.
3. Application fees are due and payable at the time the application is submitted. The application fee must be sent to the TCEQ cashier or to the appropriate regional office. The application will not be considered until the correct fee is received by the commission.
4. A notarized copy of the Agent Authorization Form must be provided for the person preparing the application, and this form must accompany the completed application.
5. No person shall commence any regulated activity on the Edwards Aquifer Recharge Zone, Contributing Zone or Transition Zone until the appropriate application for the activity has been filed with and approved by the Executive Director.

SIGNATURE PAGE:

William Jones  
Applicant's Signature

9-26-22  
Date

THE STATE OF Texas §

County of Hays §

BEFORE ME, the undersigned authority, on this day personally appeared William Jones known to me to be the person whose name is subscribed to the foregoing instrument, and acknowledged to me that (s)he executed same for the purpose and consideration therein expressed.

GIVEN under my hand and seal of office on this 26th day of September, 2022.

[Signature]  
NOTARY PUBLIC

Cody Roberts  
Typed or Printed Name of Notary

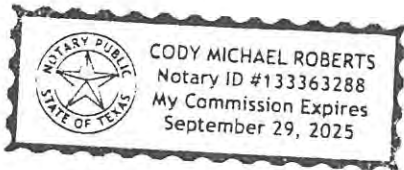

MY COMMISSION EXPIRES: September 29, 2025



# Application Fee Form

**Texas Commission on Environmental Quality**

Name of Proposed Regulated Entity: Acton Academy

Regulated Entity Location: 1000 Hays Country Acres Road, Dripping Springs, TX 78620

Name of Customer: HCA Properties, LLC

Contact Person: Michael Bevilacqua

Phone: 512-640-6590 ext 1003

Customer Reference Number (if issued):CN \_\_\_\_\_

Regulated Entity Reference Number (if issued):RN \_\_\_\_\_

**Austin Regional Office (3373)**

Hays

Travis

Williamson

**San Antonio Regional Office (3362)**

Bexar

Medina

Uvalde

Comal

Kinney

Application fees must be paid by check, certified check, or money order, payable to the **Texas Commission on Environmental Quality**. Your canceled check will serve as your receipt. **This form must be submitted with your fee payment.** This payment is being submitted to:

Austin Regional Office

San Antonio Regional Office

Mailed to: TCEQ - Cashier

Overnight Delivery to: TCEQ - Cashier

Revenues Section

12100 Park 35 Circle

Mail Code 214

Building A, 3rd Floor

P.O. Box 13088

Austin, TX 78753

Austin, TX 78711-3088

(512)239-0357

**Site Location (Check All That Apply):**

Recharge Zone

Contributing Zone

Transition Zone

<i>Type of Plan</i>	<i>Size</i>	<i>Fee Due</i>
Water Pollution Abatement Plan, Contributing Zone Plan: One Single Family Residential Dwelling	Acres	\$
Water Pollution Abatement Plan, Contributing Zone Plan: Multiple Single Family Residential and Parks	Acres	\$
Water Pollution Abatement Plan, Contributing Zone Plan: Non-residential	15 Acres	\$ 6,500.00
Sewage Collection System	L.F.	\$
Lift Stations without sewer lines	Acres	\$
Underground or Aboveground Storage Tank Facility	Tanks	\$
Piping System(s)(only)	Each	\$
Exception	Each	\$
Extension of Time	Each	\$

Signature: Michael Bevilacqua

Date: 10/12/2022



TCEQ Use Only

# TCEQ Core Data Form

For detailed instructions regarding completion of this form, please read the Core Data Form Instructions or call 512-239-5175.

## SECTION I: General Information

1. Reason for Submission (If other is checked please describe in space provided.)		
<input checked="" type="checkbox"/> New Permit, Registration or Authorization (Core Data Form should be submitted with the program application.)		
<input type="checkbox"/> Renewal (Core Data Form should be submitted with the renewal form)	<input type="checkbox"/> Other	
2. Customer Reference Number (if issued)	<a href="#">Follow this link to search for CN or RN numbers in Central Registry**</a>	3. Regulated Entity Reference Number (if issued)
CN		RN

## SECTION II: Customer Information

4. General Customer Information	5. Effective Date for Customer Information Updates (mm/dd/yyyy)	10/12/2022	
<input checked="" type="checkbox"/> New Customer <input type="checkbox"/> Update to Customer Information <input type="checkbox"/> Change in Regulated Entity Ownership <input type="checkbox"/> Change in Legal Name (Verifiable with the Texas Secretary of State or Texas Comptroller of Public Accounts)			
<i>The Customer Name submitted here may be updated automatically based on what is current and active with the Texas Secretary of State (SOS) or Texas Comptroller of Public Accounts (CPA).</i>			
6. Customer Legal Name (If an individual, print last name first: eg: Doe, John)		If new Customer, enter previous Customer below:	
HCA Properties LLC			
7. TX SOS/CPA Filing Number	8. TX State Tax ID (11 digits)	9. Federal Tax ID (9 digits)	10. DUNS Number (if applicable)
0803456257	32072384202		
11. Type of Customer:	<input type="checkbox"/> Corporation	<input type="checkbox"/> Individual	Partnership: <input type="checkbox"/> General <input checked="" type="checkbox"/> Limited
Government: <input type="checkbox"/> City <input type="checkbox"/> County <input type="checkbox"/> Federal <input type="checkbox"/> State <input type="checkbox"/> Other	<input type="checkbox"/> Sole Proprietorship	<input type="checkbox"/> Other:	
12. Number of Employees		13. Independently Owned and Operated?	
<input type="checkbox"/> 0-20 <input checked="" type="checkbox"/> 21-100 <input type="checkbox"/> 101-250 <input type="checkbox"/> 251-500 <input type="checkbox"/> 501 and higher		<input checked="" type="checkbox"/> Yes <input type="checkbox"/> No	
14. Customer Role (Proposed or Actual) – as it relates to the Regulated Entity listed on this form. Please check one of the following			
<input type="checkbox"/> Owner <input type="checkbox"/> Operator <input checked="" type="checkbox"/> Owner & Operator <input type="checkbox"/> Occupational Licensee <input type="checkbox"/> Responsible Party <input type="checkbox"/> Voluntary Cleanup Applicant <input type="checkbox"/> Other:			
15. Mailing Address:	1000 Hays Country Acres Road		
	City	Dripping Springs	State TX ZIP 78620 ZIP + 4
16. Country Mailing Information (if outside USA)		17. E-Mail Address (if applicable)	
		codyrobertstx@gmail.com	
18. Telephone Number	19. Extension or Code	20. Fax Number (if applicable)	
( 512 ) 426-5100		( ) -	

## SECTION III: Regulated Entity Information

21. General Regulated Entity Information (If 'New Regulated Entity' is selected below this form should be accompanied by a permit application)	
<input checked="" type="checkbox"/> New Regulated Entity <input type="checkbox"/> Update to Regulated Entity Name <input type="checkbox"/> Update to Regulated Entity Information	
<i>The Regulated Entity Name submitted may be updated in order to meet TCEQ Agency Data Standards (removal of organizational endings such as Inc, LP, or LLC).</i>	
22. Regulated Entity Name (Enter name of the site where the regulated action is taking place.)	
Acton Academy	

23. Street Address of the Regulated Entity: <i>(No PO Boxes)</i>	1000 Hays Country Acres Road						
	City	Dripping Springs	State	TX	ZIP	78620	ZIP + 4
24. County	Hays						

Enter Physical Location Description if no street address is provided.

25. Description to Physical Location:							
26. Nearest City	Dripping Springs			State	TX	Nearest ZIP Code	78620
27. Latitude (N) In Decimal:	30.1768		28. Longitude (W) In Decimal:	-98.0416			
Degrees	Minutes	Seconds	Degrees	Minutes	Seconds		
30	10	36.48	-98	2	29.76		
29. Primary SIC Code (4 digits)	30. Secondary SIC Code (4 digits)	31. Primary NAICS Code (5 or 6 digits)		32. Secondary NAICS Code (5 or 6 digits)			
8351	8211	62410		611110			
33. What is the Primary Business of this entity? <i>(Do not repeat the SIC or NAICS description.)</i>							
An academy to provide childcare and education to young children							
34. Mailing Address:	1000 Hays Country Acres Road						
	City	Dripping Springs	State	TX	ZIP	78620	ZIP + 4
35. E-Mail Address:	codyrobertstx@gmail.com						
36. Telephone Number		37. Extension or Code		38. Fax Number <i>(if applicable)</i>			
( 512 ) 426-5100				( ) -			

39. TCEQ Programs and ID Numbers Check all Programs and write in the permits/registration numbers that will be affected by the updates submitted on this form. See the Core Data Form instructions for additional guidance.

<input type="checkbox"/> Dam Safety	<input type="checkbox"/> Districts	<input checked="" type="checkbox"/> Edwards Aquifer	<input type="checkbox"/> Emissions Inventory Air	<input type="checkbox"/> Industrial Hazardous Waste
<input type="checkbox"/> Municipal Solid Waste	<input type="checkbox"/> New Source Review Air	<input type="checkbox"/> OSSF	<input type="checkbox"/> Petroleum Storage Tank	<input type="checkbox"/> PWS
<input type="checkbox"/> Sludge	<input type="checkbox"/> Storm Water	<input type="checkbox"/> Title V Air	<input type="checkbox"/> Tires	<input type="checkbox"/> Used Oil
<input type="checkbox"/> Voluntary Cleanup	<input type="checkbox"/> Waste Water	<input type="checkbox"/> Wastewater Agriculture	<input type="checkbox"/> Water Rights	<input type="checkbox"/> Other:

#### SECTION IV: Preparer Information

40. Name:	Michael Bevilacqua		41. Title:	Project Manager	
42. Telephone Number	43. Ext./Code	44. Fax Number	45. E-Mail Address		
( 512 ) 640-6590	1003	( 512 ) 551-4255	mbev@greencivildesign.com		

#### SECTION V: Authorized Signature

46. By my signature below, I certify, to the best of my knowledge, that the information provided in this form is true and complete, and that I have signature authority to submit this form on behalf of the entity specified in Section II, Field 6 and/or as required for the updates to the ID numbers identified in field 39.

Company:	Green Civil Design, LLC		Job Title:	Project Manager	
Name <i>(In Print)</i> :	Michael Bevilacqua			Phone:	( 512 ) 640- 6590



Signature:	<i>Michael Bentinger</i>	Date:	10/12/2022
------------	--------------------------	-------	------------

**Form 424  
(Revised 05/11)**

Submit in duplicate to:  
Secretary of State  
P.O. Box 13697  
Austin, TX 78711-3697  
512 463-5555  
FAX: 512/463-5709  
**Filing Fee: See instructions**



This space reserved for office use.

**Certificate of Amendment**

**Entity Information**

The name of the filing entity is:

SpanCo Properties LLC

State the name of the entity as currently shown in the records of the secretary of state. If the amendment changes the name of the entity, state the old name and not the new name.

The filing entity is a: (Select the appropriate entity type below.)

- For-profit Corporation
- Nonprofit Corporation
- Cooperative Association
- Limited Liability Company
- Professional Corporation
- Professional Limited Liability Company
- Professional Association
- Limited Partnership

The file number issued to the filing entity by the secretary of state is: 0803456257

The date of formation of the entity is: October 28, 2019

**Amendments**

**1. Amended Name**

(If the purpose of the certificate of amendment is to change the name of the entity, use the following statement)

The amendment changes the certificate of formation to change the article or provision that names the filing entity. The article or provision is amended to read as follows:

The name of the filing entity is: (state the new name of the entity below)

HCA PROPERTIES LLC

The name of the entity must contain an organizational designation or accepted abbreviation of such term, as applicable.

**2. Amended Registered Agent/Registered Office**

The amendment changes the certificate of formation to change the article or provision stating the name of the registered agent and the registered office address of the filing entity. The article or provision is amended to read as follows:

Registered Agent  
(Complete either A or B, but not both. Also complete C.)

A. The registered agent is an organization (cannot be entity named above) by the name of:

**OR**

B. The registered agent is an individual resident of the state whose name is:

*First Name* *M.I.* *Last Name* *Suffix*

The person executing this instrument affirms that the person designated as the new registered agent has consented to serve as registered agent.

C. The business address of the registered agent and the registered office address is:

*Street Address (No P.O. Box)* *City* **TX** *State* *Zip Code*

**3. Other Added, Altered, or Deleted Provisions**

Other changes or additions to the certificate of formation may be made in the space provided below. If the space provided is insufficient, incorporate the additional text by providing an attachment to this form. Please read the instructions to this form for further information on format.

Text Area (The attached addendum, if any, is incorporated herein by reference.)

**Add** each of the following provisions to the certificate of formation. The identification or reference of the added provision and the full text are as follows:

**Alter** each of the following provisions of the certificate of formation. The identification or reference of the altered provision and the full text of the provision as amended are as follows:

Article 3.A. of the certificate of formation is hereby amended to state as follows:

The limited liability company is to be managed by managers.

Manager 1: Cody M. Roberts; Title: Manager

Address: 649 Chama Trace, Dripping Springs, TX, USA 78620

Manager 2: Brittany Roberts; Title: Manager

Address: 649 Chama Trace Dripping Springs, TX, USA 78620

**Delete** each of the provisions identified below from the certificate of formation.

**Statement of Approval**

The amendments to the certificate of formation have been approved in the manner required by the

Texas Business Organizations Code and by the governing documents of the entity.

**Effectiveness of Filing** (Select either A, B, or C.)

- A.  This document becomes effective when the document is filed by the secretary of state.
- B.  This document becomes effective at a later date, which is not more than ninety (90) days from the date of signing. The delayed effective date is: \_\_\_\_\_
- C.  This document takes effect upon the occurrence of a future event or fact, other than the passage of time. The 90<sup>th</sup> day after the date of signing is: \_\_\_\_\_

The following event or fact will cause the document to take effect in the manner described below:

**Execution**

The undersigned signs this document subject to the penalties imposed by law for the submission of a materially false or fraudulent instrument and certifies under penalty of perjury that the undersigned is authorized under the provisions of law governing the entity to execute the filing instrument.

Date: October 14, 2020

By: **HCA PROPERTIES LLC**

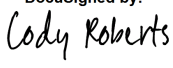
DocuSigned by:  
  
44749098A676494...  
 Signature of authorized person

**Cody M. Roberts, Manager**  
 Printed or typed name of authorized person (see instructions)

# Contributing Zone Plan Application

Texas Commission on Environmental Quality

for Regulated Activities on the Contributing Zone to the Edwards Aquifer and Relating to 30 TAC §213.24(1), Effective June 1, 1999

*To ensure that the application is administratively complete, confirm that all fields in the form are complete, verify that all requested information is provided, consistently reference the same site and contact person in all forms in the application, and ensure forms are signed by the appropriate party.*

*Note: Including all the information requested in the form and attachments contributes to more streamlined technical reviews.*

## Signature

To the best of my knowledge, the responses to this form accurately reflect all information requested concerning the proposed regulated activities and methods to protect the Edwards Aquifer. This **Contributing Zone Plan Application** is hereby submitted for TCEQ review and Executive Director approval. The application was prepared by:

Print Name of Customer/Agent: Michael Bevilacqua

Date: 10/12/2022

Signature of Customer/Agent:



Regulated Entity Name: Acton Academy

## Project Information

1. County: Hays
2. Stream Basin: Onion Creek
3. Groundwater Conservation District (if applicable): Hays Trinity
4. Customer (Applicant):

Contact Person: Cody Roberts

Entity: HCA Properties LLC

Mailing Address: 1000 Hays Country Acres Road

City, State: Dripping Springs, TX

Telephone: 512-426-5100

Email Address: codyrobertstx@gmail.com

Zip: 78620

Fax: \_\_\_\_\_

5. Agent/Representative (If any):

Contact Person: Michael Bevilacqua

Entity: Green Civil Design, LLC

Mailing Address: 301 Denali Pass, Suite 3

City, State: Cedar Park, TX

Zip: 78613

Telephone: 512-640-6590 ext 1003

Fax: 512-551-4255

Email Address: mbev@greencivildesign.com

6. Project Location:

- The project site is located inside the city limits of \_\_\_\_\_.
- The project site is located outside the city limits but inside the ETJ (extra-territorial jurisdiction) of \_\_\_\_\_.
- The project site is not located within any city's limits or ETJ.

7.  The location of the project site is described below. Sufficient detail and clarity has been provided so that the TCEQ's Regional staff can easily locate the project and site boundaries for a field investigation.

1000 Hays Country Acres Road, Dripping Springs, TX 78620

8.  **Attachment A - Road Map.** A road map showing directions to and the location of the project site is attached. The map clearly shows the boundary of the project site.
9.  **Attachment B - USGS Quadrangle Map.** A copy of the official 7 ½ minute USGS Quadrangle Map (Scale: 1" = 2000") is attached. The map(s) clearly show:
- Project site boundaries.
  - USGS Quadrangle Name(s).
10.  **Attachment C - Project Narrative.** A detailed narrative description of the proposed project is attached. The project description is consistent throughout the application and contains, at a minimum, the following details:
- Area of the site
  - Offsite areas
  - Impervious cover
  - Permanent BMP(s)
  - Proposed site use
  - Site history
  - Previous development
  - Area(s) to be demolished

11. Existing project site conditions are noted below:

- Existing commercial site
- Existing industrial site
- Existing residential site

- Existing paved and/or unpaved roads
- Undeveloped (Cleared)
- Undeveloped (Undisturbed/Not cleared)
- Other: \_\_\_\_\_

12. The type of project is:

- Residential: # of Lots: \_\_\_\_\_
- Residential: # of Living Unit Equivalents: \_\_\_\_\_
- Commercial
- Industrial
- Other: \_\_\_\_\_

13. Total project area (size of site): 15 Acres

Total disturbed area: 7.07 Acres

14. Estimated projected population: 300

15. The amount and type of impervious cover expected after construction is complete is shown below:

**Table 1 - Impervious Cover**

<i><b>Impervious Cover of Proposed Project</b></i>	<i><b>Sq. Ft.</b></i>	<i><b>Sq. Ft./Acre</b></i>	<i><b>Acres</b></i>
Structures/Rooftops	60,813	÷ 43,560 =	1.40
Parking	108,280	÷ 43,560 =	2.48
Other paved surfaces	104,028	÷ 43,560 =	2.39
Total Impervious Cover	272,870	÷ 43,560 =	6.27

**Total Impervious Cover  $6.27 \div$  Total Acreage  $15 \times 100 = 42\%$  Impervious Cover**

16.  **Attachment D - Factors Affecting Surface Water Quality.** A detailed description of all factors that could affect surface water quality is attached. If applicable, this includes the location and description of any discharge associated with industrial activity other than construction.

17.  Only inert materials as defined by 30 TAC 330.2 will be used as fill material.

***For Road Projects Only***

***Complete questions 18 - 23 if this application is exclusively for a road project.***

N/A



18. Type of project:

- TXDOT road project.
- County road or roads built to county specifications.
- City thoroughfare or roads to be dedicated to a municipality.
- Street or road providing access to private driveways.

19. Type of pavement or road surface to be used:

- Concrete
- Asphaltic concrete pavement
- Other: \_\_\_\_\_

20. Right of Way (R.O.W.):

Length of R.O.W.: \_\_\_\_\_ feet.

Width of R.O.W.: \_\_\_\_\_ feet.

$L \times W = \text{_____ Ft}^2 \div 43,560 \text{ Ft}^2/\text{Acre} = \text{_____ acres.}$

21. Pavement Area:

Length of pavement area: \_\_\_\_\_ feet.

Width of pavement area: \_\_\_\_\_ feet.

$L \times W = \text{_____ Ft}^2 \div 43,560 \text{ Ft}^2/\text{Acre} = \text{_____ acres.}$

Pavement area \_\_\_\_\_ acres  $\div$  R.O.W. area \_\_\_\_\_ acres  $\times 100 = \text{_____ \%}$  impervious cover.

22.  A rest stop will be included in this project.

A rest stop will not be included in this project.

23.  Maintenance and repair of existing roadways that do not require approval from the TCEQ Executive Director. Modifications to existing roadways such as widening roads/adding shoulders totaling more than one-half (1/2) the width of one (1) existing lane require prior approval from the TCEQ.

### ***Stormwater to be generated by the Proposed Project***

24.  **Attachment E - Volume and Character of Stormwater.** A detailed description of the volume (quantity) and character (quality) of the stormwater runoff which is expected to occur from the proposed project is attached. The estimates of stormwater runoff quality and quantity are based on area and type of impervious cover. Include the runoff coefficient of the site for both pre-construction and post-construction conditions.

### ***Wastewater to be generated by the Proposed Project***

25.  Wastewater is to be discharged in the contributing zone. Requirements under 30 TAC §213.6(c) relating to Wastewater Treatment and Disposal Systems have been satisfied.

N/A

26. Wastewater will be disposed of by:

On-Site Sewage Facility (OSSF/Septic Tank):

**Attachment F - Suitability Letter from Authorized Agent.** An on-site sewage facility will be used to treat and dispose of the wastewater from this site. The appropriate licensing authority's (authorized agent) written approval is attached. It states that the land is suitable for the use of private sewage facilities and will meet or exceed the requirements for on-site sewage facilities as specified under 30 TAC Chapter 285 relating to On-site Sewage Facilities.

Each lot in this project/development is at least one (1) acre (43,560 square feet) in size. The system will be designed by a licensed professional engineer or registered sanitarian and installed by a licensed installer in compliance with 30 TAC Chapter 285.

Sewage Collection System (Sewer Lines):

The sewage collection system will convey the wastewater to the \_\_\_\_\_ (name) Treatment Plant. The treatment facility is:

Existing.

Proposed.

N/A

**Permanent Aboveground Storage Tanks(ASTs) ≥ 500 Gallons**

*Complete questions 27 - 33 if this project includes the installation of AST(s) with volume(s) greater than or equal to 500 gallons.*

N/A

27. Tanks and substance stored:

**Table 2 - Tanks and Substance Storage**

<i>AST Number</i>	<i>Size (Gallons)</i>	<i>Substance to be Stored</i>	<i>Tank Material</i>
1			
2			
3			
4			
5			

**Total x 1.5 = \_\_\_\_\_ Gallons**

28.  The AST will be placed within a containment structure that is sized to capture one and one-half (1 1/2) times the storage capacity of the system. For facilities with more than

one tank system, the containment structure is sized to capture one and one-half (1 1/2) times the cumulative storage capacity of all systems.

- Attachment G - Alternative Secondary Containment Methods.** Alternative methods for providing secondary containment are proposed. Specifications showing equivalent protection for the Edwards Aquifer are attached.

29. Inside dimensions and capacity of containment structure(s):

**Table 3 - Secondary Containment**

<i>Length (L)(Ft.)</i>	<i>Width(W)(Ft.)</i>	<i>Height (H)(Ft.)</i>	<i>L x W x H = (Ft3)</i>	<i>Gallons</i>

**Total: \_\_\_\_\_ Gallons**

30. Piping:

- All piping, hoses, and dispensers will be located inside the containment structure.
- Some of the piping to dispensers or equipment will extend outside the containment structure.
- The piping will be aboveground
- The piping will be underground

31.  The containment area must be constructed of and in a material impervious to the substance(s) being stored. The proposed containment structure will be constructed of: \_\_\_\_\_.

32.  **Attachment H - AST Containment Structure Drawings.** A scaled drawing of the containment structure is attached that shows the following:

- Interior dimensions (length, width, depth and wall and floor thickness).
- Internal drainage to a point convenient for the collection of any spillage.
- Tanks clearly labeled
- Piping clearly labeled
- Dispenser clearly labeled

33.  Any spills must be directed to a point convenient for collection and recovery. Spills from storage tank facilities must be removed from the controlled drainage area for disposal within 24 hours of the spill.

- In the event of a spill, any spillage will be removed from the containment structure within 24 hours of the spill and disposed of properly.

- In the event of a spill, any spillage will be drained from the containment structure through a drain and valve within 24 hours of the spill and disposed of properly. The drain and valve system are shown in detail on the scaled drawing.

## ***Site Plan Requirements***

### ***Items 34 - 46 must be included on the Site Plan.***

34.  The Site Plan must have a minimum scale of 1" = 400'.  
Site Plan Scale: 1" = 20'.
35. 100-year floodplain boundaries:
- Some part(s) of the project site is located within the 100-year floodplain. The floodplain is shown and labeled.
- No part of the project site is located within the 100-year floodplain.  
The 100-year floodplain boundaries are based on the following specific (including date of material) sources(s): FEMA Map 48209C0120F dated September 02, 2005.
36.  The layout of the development is shown with existing and finished contours at appropriate, but not greater than ten-foot contour intervals. Lots, recreation centers, buildings, roads, etc. are shown on the site plan.
- The layout of the development is shown with existing contours at appropriate, but not greater than ten-foot contour intervals. Finished topographic contours will not differ from the existing topographic configuration and are not shown. Lots, recreation centers, buildings, roads, etc. are shown on the site plan.
37.  A drainage plan showing all paths of drainage from the site to surface streams.
38.  The drainage patterns and approximate slopes anticipated after major grading activities.
39.  Areas of soil disturbance and areas which will not be disturbed.
40.  Locations of major structural and nonstructural controls. These are the temporary and permanent best management practices.
41.  Locations where soil stabilization practices are expected to occur.
42.  Surface waters (including wetlands).  
 N/A
43.  Locations where stormwater discharges to surface water.  
 There will be no discharges to surface water.
44.  Temporary aboveground storage tank facilities.  
 Temporary aboveground storage tank facilities will not be located on this site.

45.  Permanent aboveground storage tank facilities.  
 Permanent aboveground storage tank facilities will not be located on this site.
46.  Legal boundaries of the site are shown.

### ***Permanent Best Management Practices (BMPs)***

#### ***Practices and measures that will be used during and after construction is completed.***

47.  Permanent BMPs and measures must be implemented to control the discharge of pollution from regulated activities after the completion of construction.  
 N/A
48.  These practices and measures have been designed, and will be constructed, operated, and maintained to insure that 80% of the incremental increase in the annual mass loading of total suspended solids (TSS) from the site caused by the regulated activity is removed. These quantities have been calculated in accordance with technical guidance prepared or accepted by the executive director.  
 The TCEQ Technical Guidance Manual (TGM) was used to design permanent BMPs and measures for this site.  
 A technical guidance other than the TCEQ TGM was used to design permanent BMPs and measures for this site. The complete citation for the technical guidance that was used is: \_\_\_\_\_.  
 N/A
49.  Owners must insure that permanent BMPs and measures are constructed and function as designed. A Texas Licensed Professional Engineer must certify in writing that the permanent BMPs or measures were constructed as designed. The certification letter must be submitted to the appropriate regional office within 30 days of site completion.  
 N/A
50. Where a site is used for low density single-family residential development and has 20 % or less impervious cover, other permanent BMPs are not required. This exemption from permanent BMPs must be recorded in the county deed records, with a notice that if the percent impervious cover increases above 20% or land use changes, the exemption for the whole site as described in the property boundaries required by 30 TAC §213.4(g) (relating to Application Processing and Approval), may no longer apply and the property owner must notify the appropriate regional office of these changes.  
 The site will be used for low density single-family residential development and has 20% or less impervious cover.  
 The site will be used for low density single-family residential development but has more than 20% impervious cover.  
 The site will not be used for low density single-family residential development.

51. The executive director may waive the requirement for other permanent BMPs for multi-family residential developments, schools, or small business sites where 20% or less impervious cover is used at the site. This exemption from permanent BMPs must be recorded in the county deed records, with a notice that if the percent impervious cover increases above 20% or land use changes, the exemption for the whole site as described in the property boundaries required by 30 TAC §213.4(g) (relating to Application Processing and Approval), may no longer apply and the property owner must notify the appropriate regional office of these changes.

- Attachment I - 20% or Less Impervious Cover Waiver.** The site will be used for multi-family residential developments, schools, or small business sites and has 20% or less impervious cover. A request to waive the requirements for other permanent BMPs and measures is attached.
- The site will be used for multi-family residential developments, schools, or small business sites but has more than 20% impervious cover.
- The site will not be used for multi-family residential developments, schools, or small business sites.

52.  **Attachment J - BMPs for Upgradient Stormwater.**

- A description of the BMPs and measures that will be used to prevent pollution of surface water, groundwater, or stormwater that originates upgradient from the site and flows across the site is attached.
- No surface water, groundwater or stormwater originates upgradient from the site and flows across the site, and an explanation is attached.
- Permanent BMPs or measures are not required to prevent pollution of surface water, groundwater, or stormwater that originates upgradient from the site and flows across the site, and an explanation is attached.

53.  **Attachment K - BMPs for On-site Stormwater.**

- A description of the BMPs and measures that will be used to prevent pollution of surface water or groundwater that originates on-site or flows off the site, including pollution caused by contaminated stormwater runoff from the site is attached.
- Permanent BMPs or measures are not required to prevent pollution of surface water or groundwater that originates on-site or flows off the site, including pollution caused by contaminated stormwater runoff, and an explanation is attached.

54.  **Attachment L - BMPs for Surface Streams.** A description of the BMPs and measures that prevent pollutants from entering surface streams is attached.

N/A

55.  **Attachment M - Construction Plans.** Construction plans and design calculations for the proposed permanent BMPs and measures have been prepared by or under the direct supervision of a Texas Licensed Professional Engineer, and are signed, sealed, and dated. Construction plans for the proposed permanent BMPs and measures are

attached and include: Design calculations, TCEQ Construction Notes, all proposed structural plans and specifications, and appropriate details.

N/A

56.  **Attachment N - Inspection, Maintenance, Repair and Retrofit Plan.** A site and BMP specific plan for the inspection, maintenance, repair, and, if necessary, retrofit of the permanent BMPs and measures is attached. The plan fulfills all of the following:

- Prepared and certified by the engineer designing the permanent BMPs and measures
- Signed by the owner or responsible party
- Outlines specific procedures for documenting inspections, maintenance, repairs, and, if necessary, retrofit.
- Contains a discussion of record keeping procedures

N/A

57.  **Attachment O - Pilot-Scale Field Testing Plan.** Pilot studies for BMPs that are not recognized by the Executive Director require prior approval from the TCEQ. A plan for pilot-scale field testing is attached.

N/A

58.  **Attachment P - Measures for Minimizing Surface Stream Contamination.** A description of the measures that will be used to avoid or minimize surface stream contamination and changes in the way in which water enters a stream as a result of the construction and development is attached. The measures address increased stream flashing, the creation of stronger flows and in-stream velocities, and other in-stream effects caused by the regulated activity, which increase erosion that result in water quality degradation.

N/A

***Responsibility for Maintenance of Permanent BMPs and Measures after Construction is Complete.***

59.  The applicant is responsible for maintaining the permanent BMPs after construction until such time as the maintenance obligation is either assumed in writing by another entity having ownership or control of the property (such as without limitation, an owner's association, a new property owner or lessee, a district, or municipality) or the ownership of the property is transferred to the entity. Such entity shall then be responsible for maintenance until another entity assumes such obligations in writing or ownership is transferred.
60.  A copy of the transfer of responsibility must be filed with the executive director at the appropriate regional office within 30 days of the transfer if the site is for use as a multiple single-family residential development, a multi-family residential development,



or a non-residential development such as commercial, industrial, institutional, schools, and other sites where regulated activities occur.

### ***Administrative Information***

61.  Submit one (1) original and one (1) copy of the application, plus additional copies as needed for each affected incorporated city, groundwater conservation district, and county in which the project will be located. The TCEQ will distribute the additional copies to these jurisdictions.
62.  Any modification of this Contributing Zone Plan may require TCEQ review and Executive Director approval prior to construction, and may require submission of a revised application, with appropriate fees.
63.  The site description, controls, maintenance, and inspection requirements for the storm water pollution prevention plan (SWPPP) developed under the EPA NPDES general permits for stormwater discharges have been submitted to fulfill paragraphs 30 TAC §213.24(1-5) of the technical report. All requirements of 30 TAC §213.24(1-5) have been met by the SWPPP document.
  - The Temporary Stormwater Section (TCEQ-0602) is included with the application.

FILE: 1137-003 ROAD MAP EXHIBIT.dwg TAB: EXHIBIT-8.5X11-L PLOTTED: 10/10/2022 4:13 PM BY: MIKE BEV

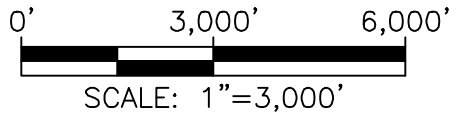
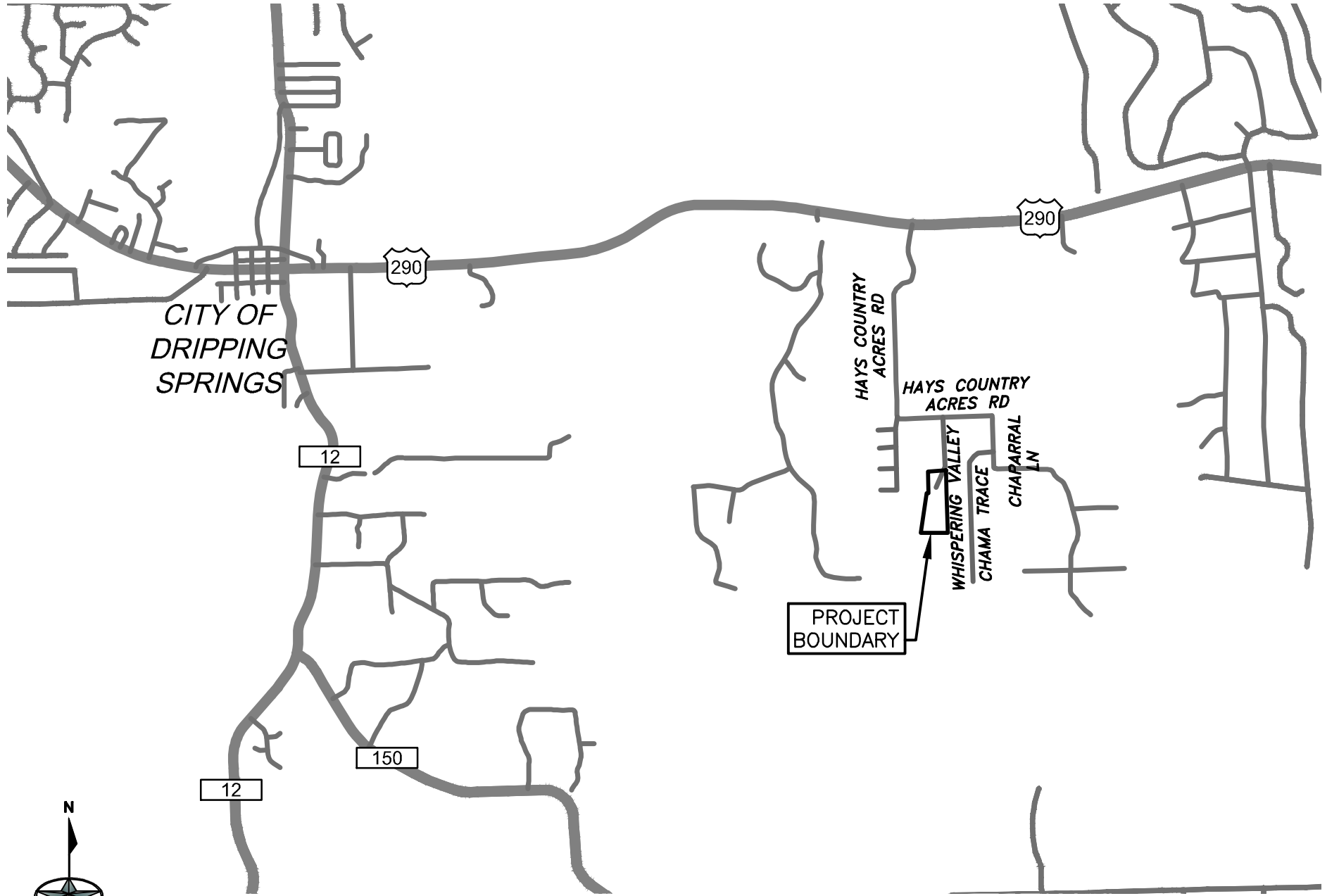

**Green  
Civil Design**

301 Denali Pass Dr., Suite 3  
Cedar Park, Texas 78613  
(512) 640-6590

*Engineering & Consulting*  
Texas Registered Engineering Firm F-17563

**ACTON ACADEMY  
PHASE 1**

ATTACHMENT A - ROAD MAP

**CONTRIBUTING ZONE PLAN APPLICATION**

**Attachment B**

**USGS Map**



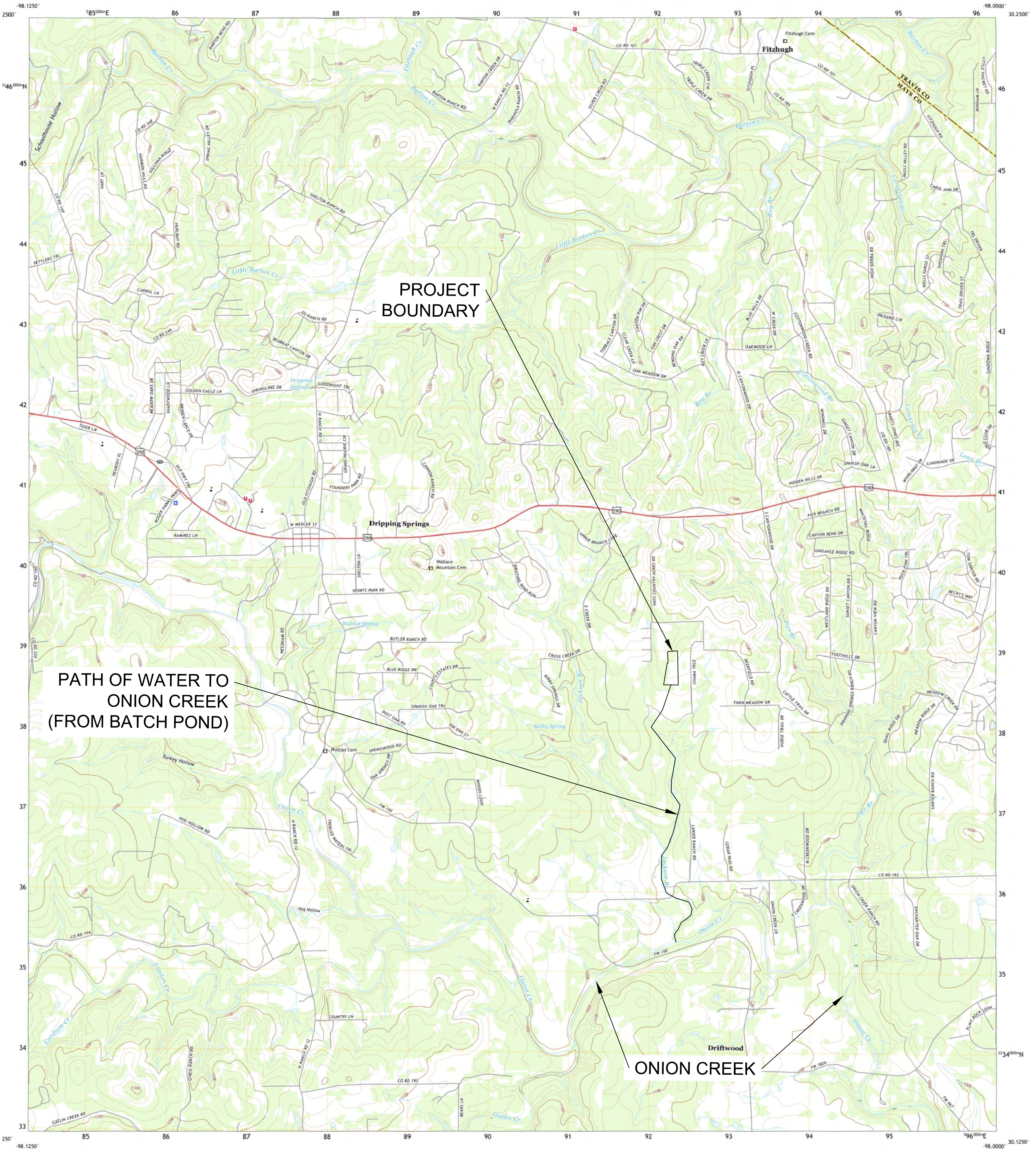

Produced by the United States Geological Survey  
North American Datum of 1983 (NAD83)  
World Geodetic System of 1984 (WGS84). Projection and  
1000-meter grid: Universal Transverse Mercator, Zone 14R  
This map is not a legal document. Boundaries may be  
generalized for this map scale. Private lands within government  
reservations may not be shown. Obtain permission before  
entering private lands.

Imagery:.....NAIP, September 2016 - November 2016  
Roads:.....U.S. Census Bureau, 2015  
Names:.....GNF, 1979 - 2018  
Hydrography:.....National Hydrography Dataset, 2002 - 2018  
Contours:.....National Elevation Dataset, 2002 - 2003  
Boundaries:.....Multiple sources; see metadata file 2016 - 2017  
Wetlands:.....FWS National Wetlands Inventory 1982 - 1983

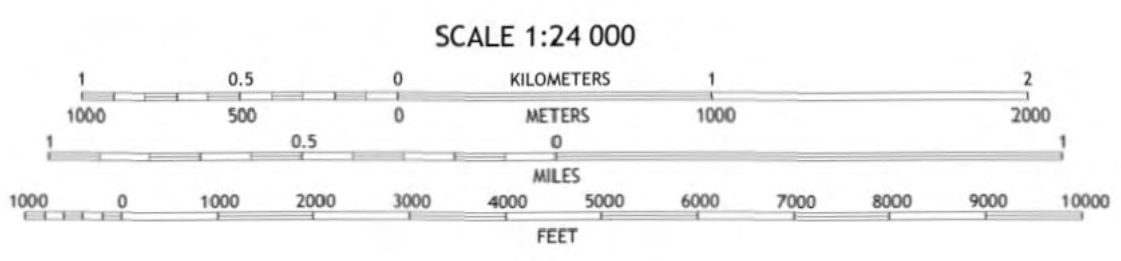
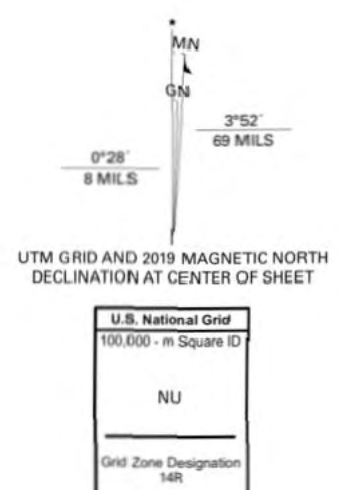

1	2	3
4	5	6
7	8	

ADJOINING QUADRANGLES



**DRIPPING SPRINGS, TX**  
2019



## CONTRIBUTING ZONE PLAN APPLICATION

### Attachment C

#### Project Narrative

The Acton Academy Phase 1 (AAP1) project is a proposed commercial development consisting of school buildings and other childcare facilities, located at 1000 Hays Country Acres Road, Dripping Springs, TX 78620. This site is in the unincorporated areas Hays County. Improvements include buildings with parking lot, utilities, and associated site improvements.

The Acton Academy is located on a 15-acre tract. The existing development spans approximately 5-acres of the tract consisting of agricultural use, classrooms/school, house, barns, and storage sheds. The proposed AAP1 project will consist of approximately 5.38-acres of development. The proposed AAP1 project will increase the disturbed area over 5-acres and will now be part of a larger development over 5-acres. The AAP1 and existing improvements will span approximately 10.38-acres. A future expansion of the Acton Academy will span the remaining 4.62-acres. Any future expansion will require a modification to this plan. Permanent BMPs include capturing storm water from the associated existing, proposed, and future site development and conveying to a batch pond. No off-site/upgradient areas are draining to this site.

The total impervious cover (I.C.) with this project is 6.27 acres (42%). Pre-1999 I.C. includes 0.33-acres. The total proposed I.C. (I.C. from 1999 to present, plus proposed and future conditions) is 5.94-acres. A summary of the I.C. is below:

- Existing I.C. (Pre-1999) = 0.33-acres
- I.C. from existing development but post 1999 = 1.69-acres
- Proposed I.C. (AAP1) = 1.60-acres
- Future I.C. (Future Acton Academy Phases) = 2.65-acres

The AAP1 anticipated total disturbed area is 7.20 acres, including impervious cover and areas disturbed during construction.

The batch pond will serve approximately 8.77 total acres of the development with 5.16-acres of I.C. The remaining 6.23-acres with 1.11-acres of I.C. will drain away from the pond but is accounted for in the pond calculations. The batch pond will have 91% removal. Total treatment for the site will meet the 80% removal requirement. Details regarding the new ponds are provided in Attachments K and M.

Water service will be provided by an existing on-site well. Wastewater service will be provided by an existing septic (OSSF) system.

As noted above, a future phase of this project is anticipated. The future phase will consist of approximately 4.62 total acres and 2.65-acres of I.C. including buildings/classrooms and associated site development. The batch pond proposed with this CZP/AAP1 will be sized to treat the future phase impervious cover.

# AAP1

1/1995 Aerial

## Legend

- Feature 1
- Feature 2
- Havenwood Nature School

1

Gateway Estates II Mobile Home Park

2

3

CAC

BizWebShop.com

Caparral Ln  
Hays County Acres

Deerfield Rd

Deerfield

Havenwood Nature School

Chama Trace

Creative Therapy Solutions

Google Earth

Image U.S. Geological Survey



1000 ft

## **CONTRIBUTING ZONE PLAN APPLICATION**

### **Attachment D**

#### **Factors Affecting Surface Water Quality**

Factors that could affect surface water and ground water quality for Acton Academy include the construction of the proposed project and run-off from the buildings and/or drives and sidewalks once the project is complete. During construction excavation could produce sediment. Fueling of trucks, asphalt, and paint from the paving and striping process, and fertilizing after re-seeding have the potential of contaminating surface and ground water. Measures to prevent contamination during construction are covered in the Temporary Stormwater Section. Once the project is complete, run-off from the parking lot and buildings has the potential of contaminating surface and ground water. The run-off will be treated by a batch pond before being released. The calculations and plans for these permanent BMPs are shown in the attached Construction Plans.



# CONTRIBUTING ZONE PLAN APPLICATION

## Attachment E

### Volume and Character of Stormwater

There are three (3) points of analysis for this project, POA's #1, #2, and #3. POA's #1 and #2 are for the areas draining to the south of the site. POA #1 includes areas draining to the batch pond, including the proposed Acton Academy Phase 1 (AAP1) improvements, future AA improvements, and a portion of the existing improvements. POA #2 drainage area is for the portion of the site draining to the southwest. POA #3 is the area in the northeast of the property that drains off-site to the east.

Approximately 8.77 total acres with 5.16-acres of impervious cover (IC) will drain to the proposed POA #1. Approximately 5.17 total acres with 0.75-acres of IC will drain to POA #2. Approximately 1.06-total acres with 0.36-acres of I.C. will drain to POA #3. The batch pond is sized to remove 91% of the total pollutants from the entire 15-acre site.

For existing conditions, four drainage basins (E1 thru E4) and four POA's (Existing POA's #1 thru #4) were used respectively. Existing Basins E1 and E2 flow from the north to the south. Existing Basin E3 flows from the north to the southwest. Existing Basin #4 flows to the southeast. Existing Basin E3 will be graded/routed to flow south to proposed POA #2 with the proposed project.

Under proposed conditions, nine (9) drainage basins and three (3) POA's were used. POA #1 with four (4) drainage basins (A1, A2, A3, and C1) drain from the north to the south and flow into the batch detention pond. POA #2 with four (4) drainage basins (B1, B2, B3, and C2) flow from north to the south. POA #3 with one (1) drainage basin (C3) flows from the north to the southeast. Water quality treatment for this development will be a batch pond. The drainage areas contributing to this batch pond have buildings, drives, sidewalks, and grassy areas.

HEC-HMS and City of Austin Drainage Criteria were used in the calculations to determine the flows to each POA. HEC HMS utilizes a SCS CN value of 80, with percent impervious imputed by the user for each basin. The drainage and water quality calculations and improvements are shown on construction plans provided in Attachment M. A summary of the stormwater calculations is provided below.

### HEC HMS RESULTS SUMMARY BATCH POND/POA #1

	EXISTING FLOW	DEVELOPED FLOW	DEVELOPED WITH DETENTION	POND ELEVATION
	(CFS)	(CFS)	(CFS)	(FT)
2 YR	18.4	24.9	13.9	1130.4
10 YR	35.1	40.7	29.3	1130.7
25 YR	46.7	51.6	40.2	1130.9
100 YR	66.6	70.4	58.2	1131.1

**HEC HMS RESULTS SUMMARY - ALL**

<b>BATCH POND (POA #1) AND POA #2</b>			<b>POA #3</b>		
	<b>EXISTING FLOW</b>	<b>DEVELOPED FLOW</b>	<b>DEVELOPED WITH DETENTION</b>	<b>EXISTING FLOW</b>	<b>DEVELOPED FLOW</b>
	<b>(CFS)</b>	<b>(CFS)</b>	<b>(CFS)</b>	<b>(CFS)</b>	<b>(CFS)</b>
2 YR	28.1	37.5	26.5	2.7	2.7
10 YR	53.9	64.0	52.6	5.0	4.6
25 YR	77.9	82.3	70.9	6.6	5.9
100 YR	102.6	113.7	101.5	9.3	8.2

**CONTRIBUTING ZONE PLAN APPLICATION**

**Attachment F**

**Sustainability Letter from Authorized Agent**

# Hays County Development Services

2171 Yarrington Road, Ste. 100, Kyle TX 78640  
512-393-2150



---

## Authorization to Construct an On-site Sewage Facility Permit #: OSSF-2023-3348

---

Location: 1000 Hays Country Acres, Dripping Springs, TX 78620

Legal Description: 15.00 ACRES OUT OF THE RICHARD VAUGHN SURVEY ABS 16

Owner: Havenwood Nature School - Cody Roberts

Mailing Address: 1000 Hays Country Acres Rd., Dripping Springs, TX 78620

AUTHORIZATION IS HEREBY GIVEN TO CONSTRUCT AN ON-SITE SEWAGE FACILITY ON THE ABOVE DESCRIBED PROPERTY.

Approval is hereby granted for the construction as shown on the submitted planning material.

ANY MODIFICATIONS TO SUBMITTED PLANS REQUIRE APPROVAL BY HAYS COUNTY DEVELOPMENT SERVICES PRIOR TO INSTALLATION.

CONTACT HAYS COUNTY DEVELOPMENT SERVICES FOR REQUIRED INSPECTIONS.

This Authorization to Construct is valid for twelve months from the date of issuance.

**COMMENTS:**

INSTALL ACCORDING TO REVISED PLANS BY DERRICK LORMAND, R.S., DATED 6-7-2023.

Note: The On-site Sewage Facility construction must meet all TCEQ Regulations and Hays County Rules for On-site Sewage Facilities. If unforeseen and/or adverse conditions are encountered (including, but not limited to excessive rock, seepage, or high water table) stop construction and contact HAYS COUNTY DEVELOPMENT SERVICES. Revised planning materials and Authorization to Construct may be required.

A handwritten signature in blue ink, appearing to read "Eric Van Gaasbeek".

6/28/2023

---

Eric Van Gaasbeek, R.S., C.F.M.  
Chief Environmental Health Specialist  
TCEQ License # OS0028967  
eric.vangaasbeek@co.hays.tx.us  
(P) 512.393.2187  
eric.vangaasbeek@co.hays.tx.us  
(P) 512.393.2187

Date

# **CONTRIBUTING ZONE PLAN APPLICATION**

## **Attachment G**

### **Alternative Secondary Containment Methods**

An AST is not proposed with this project therefore Alternative Secondary Containment Methods are not required.

**CONTRIBUTING ZONE PLAN APPLICATION**

**Attachment H**

**AST Containment Structure Drawings**

An AST is not proposed with this project; therefore, AST Containment Structure Drawings are not provided.

**CONTRIBUTING ZONE PLAN APPLICATION**

**Attachment I**

**20% or Less Impervious Cover Waiver**

This waiver is not requested for this project.

## **CONTRIBUTING ZONE PLAN APPLICATION**

### **Attachment J**

#### **BMPs for Upgradient Stormwater**

There are no upgradient stormwater flows entering our project site, therefore, BMPs for Upgradient Stormwater are not provided.



## **CONTRIBUTING ZONE PLAN APPLICATION**

### **Attachment K**

#### **BMPs for On-Site Stormwater**

The BMPs used to prevent pollution of surface water or ground water that originates on-site will be a new batch pond. Approximately 8.77-acres with 5.16-acres of impervious cover (IC) will drain to the proposed batch pond. The remaining 6.23-acres with 1.11-acres of IC will drain off-site or away from the pond but is accounted for in the calculations. The batch pond will have 91% removal. Total treatment for the site will meet the 80% removal requirement. Details regarding the batch pond is provided in Attachment M.

Additional information is provided for cells with a red triangle in the upper right corner. Place the cursor over the cell.

Text shown in blue indicate location of instructions in the Technical Guidance Manual – RG-348.

Characters shown in red are data entry fields.

Characters shown in black (Bold) are calculated fields. Changes to these fields will remove the equations used in the spreadsheet.

**1. The Required Load Reduction for the total project:**

Calculations from RG-348

Pages 3-27 to 3-30

Page 3-29 Equation 3.3:  $L_M = 27.2(A_N \times P)$

where:

$L_M$  TOTAL PROJECT = Required TSS removal resulting from the proposed development = 80% of increased load  
 $A_N$  = Net increase in impervious area for the project  
 P = Average annual precipitation, inches

Site Data: Determine Required Load Removal Based on the Entire Project

County = **Hays**  
 Total project area included in plan = **15.00** acres  
 Predevelopment impervious area within the limits of the plan = **0.330525** acres  
 Total post-development impervious area within the limits of the plan = **6.268464** acres  
 Total post-development impervious cover fraction = **0.417898**  
 P = **33** inches

$L_M$  TOTAL PROJECT = **5330** lbs.

\* The values entered in these fields should be for the total project area.

Number of drainage basins / outfalls areas leaving the plan area = **3**

**2. Drainage Basin Parameters (This information should be provided for each basin):**

Drainage Basin/Outfall Area No. = **1**  
 Total drainage basin/outfall area = **8.77** acres  
 Predevelopment impervious area within drainage basin/outfall area = **0.330525** acres  
 Post-development impervious area within drainage basin/outfall area = **5.16** acres  
 Post-development impervious fraction within drainage basin/outfall area = **0.59**  
 $L_M$  THIS BASIN = **4336** lbs.

**3. Indicate the proposed BMP Code for this basin.**

Proposed BMP = **Batch Detention**  
 Removal efficiency = **91** percent

Prepared By:  
 Green Civil Design, LLC  
 Firm - 17563  
 301 Denali Pass, Suite #3  
 Cedar Park, TX 78613



- Aqualogic Cartridge Filter
- Bioretention
- Contech StormFilter
- Constructed Wetland
- Extended Detention
- Grassy Swale
- Retention / Irrigation
- Sand Filter
- Stormceptor
- Vegetated Filter Strips
- Vortechs
- Wet Basin
- Batch Detention

**4. Calculate Maximum TSS Load Removed ( $L_R$ ) for this Drainage Basin by the selected BMP Type.**

RG-348 Page 3-33 Equation 3.7:  $L_R = (\text{BMP efficiency}) \times P \times (A_i \times 34.6 + A_p \times 0.54)$

where:

$A_C$  = Total On-Site drainage area in the BMP catchment area  
 $A_i$  = Impervious area proposed in the BMP catchment area  
 $A_p$  = Pervious area remaining in the BMP catchment area  
 $L_R$  = TSS Load removed from this catchment area by the proposed BMP

$A_C$  = **8.77** acres  
 $A_i$  = **5.16** acres  
 $A_p$  = **3.61** acres  
 $L_R$  = **5421** lbs

**5. Calculate Fraction of Annual Runoff to Treat the drainage basin / outfall area**

Desired  $L_{R \text{ THIS BASIN}}$  = **4954** lbs.

F = **0.91**

**6. Calculate Capture Volume required by the BMP Type for this drainage basin / outfall area.**

Calculations from RG-348

Pages 3-34 to 3-36

Rainfall Depth = **1.80** inches  
 Post Development Runoff Coefficient = **0.41**  
 On-site Water Quality Volume = **23615** cubic feet

Calculations from RG-348 Pages 3-36 to 3-37

Off-site area draining to BMP = **0.00** acres  
 Off-site Impervious cover draining to BMP = **0.00** acres  
 Impervious fraction of off-site area = **0**  
 Off-site Runoff Coefficient = **0.00**  
 Off-site Water Quality Volume = **0** cubic feet  
 Storage for Sediment = **4723**  
 Total Capture Volume (required water quality volume(s) x 1.20) = **28338** cubic feet

Prepared By:  
 Green Civil Design, LLC  
 Firm - 17563  
 301 Denali Pass, Suite #3  
 Cedar Park, TX 78613.



## **CONTRIBUTING ZONE PLAN APPLICATION**

### **Attachment L**

#### **BMPs for Surface Streams**

This project will not discharge storm water directly into surface streams. The nearest surface stream is the Onion Creek, which is downstream of the site. The BMPs that will prevent pollutants from entering these streams will be the batch pond as described in Attachment C and K of this section.

**CONTRIBUTING ZONE PLAN APPLICATION**

**Attachment M**

**Construction Plans**





FILE: p:\Projects\1137 - cody roberts\003 - acton academy phase 1\CAD\Sheets\1137-003 - GENERAL NOTES.dwg TAB: 2 GENERAL NOTES (1 OF 2) PLOTTED: 6/30/2023 11:37 AM BY: MIKE BEV

**GENERAL CONSTRUCTION NOTES:**

- ALL CONSTRUCTION SHALL BE IN ACCORDANCE WITH THE HAYS COUNTY DEVELOPMENT REGULATIONS STANDARD SPECIFICATIONS.
  - ALL RESPONSIBILITY FOR THE ADEQUACY OF THESE PLANS REMAINS WITH THE ENGINEER WHO PREPARED THEM. IN REVIEWING THESE PLANS, HAYS COUNTY MUST RELY ON THE ADEQUACY OF THE WORK OF THE DESIGN ENGINEER.
  - DESIGN PROCEDURES SHALL BE IN COMPLIANCE WITH THE HAYS COUNTY DEVELOPMENT REGULATIONS. ALL WAIVERS OR VARIANCES ARE LISTED BELOW:
  - AFTER THE CONSTRUCTION PERMIT HAS BEEN ISSUED AND PRIOR TO BEGINNING CONSTRUCTION, THE OWNER OR HIS REPRESENTATIVE SHALL SCHEDULE A PRE-CONSTRUCTION CONFERENCE BETWEEN HAYS COUNTY, HAYS COUNTY FIRE MARSHAL, DESIGN ENGINEER, CONTRACTOR(S), AND ANY OTHER AFFECTED PARTIES. PROVIDE NOTICE OF PRE-CONSTRUCTION MEETING AT LEAST 3 BUSINESS DAYS PRIOR TO THE PROPOSED MEETING TIME.
  - ANY CHANGES OR REVISIONS TO THESE APPROVED PLANS MUST BE SUBMITTED BY THE DESIGN ENGINEER AND APPROVED BY HAYS COUNTY PRIOR TO CONSTRUCTION OF THE REVISION.
  - ANY EXISTING UTILITIES, PAVEMENT, CURBS, SIDEWALKS, STRUCTURES, TREES, ETC., NOT PLANNED FOR DESTRUCTION OR REMOVAL OR OTHER PUBLIC INFRASTRUCTURE DAMAGED OR REMOVED WILL BE BY THE CONTRACTOR AT HIS EXPENSE BEFORE ACCEPTANCE OF THE SUBDIVISION.
  - BENCHMARKS:
    - BENCHMARK #1: ATLAS TITLE SURVEY CUT SQUARE SET IN SE CORNER OF STORM SEWER INLET NAVD88(2012B) ELEV. = 817.84', N:10145756.0040, E:3144381.5780
    - BENCHMARK #2: ATLAS TITLE SURVEY CUT SQUARE IN TOP OF CONCRETE NAVD88(2012B) ELEV. = 800.20', N:10145837.9638, E:3143798.1247
- THE BASIS OF BEARINGS SHOWN HERON IS THE TEXAS COORDINATE SYSTEM, NAD83 (2011), CENTRAL ZONE, UTILIZING THE LEICA SMARTNET CONTINUALLY OPERATING REFERENCE NETWORK.
- BLASTING OR BURNING SHALL NOT BE PERMITTED ON THIS PROJECT.
  - THE CONTRACTOR SHALL VERIFY ALL DEPTHS AND LOCATIONS OF EXISTING UTILITIES PRIOR TO BEGINNING CONSTRUCTION. ANY DISCREPANCIES WITH THE CONSTRUCTION PLANS FOUND IN THE FIELD SHALL BE BROUGHT TO THE ATTENTION OF THE DESIGN ENGINEER IMMEDIATELY. THE DESIGN ENGINEER SHALL BE RESPONSIBLE FOR REVISING THE PLANS AS APPROPRIATE. USE ONE CALL UTILITY SYSTEM: DIAL 1-800-344-8377, 48 HOURS BEFORE YOU DIG.
  - NO PUBLIC STREET CONSTRUCTION IS PROPOSED WITH THIS PROJECT.
  - ALL SIDEWALKS SHALL COMPLY WITH THE AMERICANS WITH DISABILITIES ACT. IT IS THE RESPONSIBILITY OF THE OWNER TO PROVIDE COMPLIANCE WITH ALL LEGISLATION RELATED TO ACCESSIBILITY WITHIN THE LIMITS OF CONSTRUCTION SHOWN IN THESE PLANS.
  - EXCESS SOIL SHALL BE REMOVED AT THE CONTRACTOR'S EXPENSE IN ACCORDANCE WITH ALL LOCAL, STATE, AND FEDERAL REGULATIONS.
  - ALL AREAS DISTURBED OR EXPOSED DURING CONSTRUCTION SHALL BE REVEGETATED IN ACCORDANCE WITH THE PLANS AND SPECIFICATIONS. REVEGETATION OF ALL DISTURBED AREAS OR EXPOSED AREAS SHALL CONSIST OF SODDING OR SEEDING; AT THE CONTRACTOR'S OPTION.
  - IT SHALL BE THE RESPONSIBILITY OF THE CONTRACTOR TO INSPECT TEMPORARY EROSION CONTROLS ON A DAILY BASIS. ADJUST THE CONTROLS AND/OR REMOVE ANY SEDIMENT BUILDUP AS NECESSARY.
  - CONTRACTOR WILL BE RESPONSIBLE FOR KEEPING ROADS AND DRIVES ADJACENT TO AND NEAR THE SITE FREE FROM SOIL, SEDIMENT AND DEBRIS. CONTRACTOR WILL NOT REMOVE SOIL, SEDIMENT OR DEBRIS FROM ANY AREA OR VEHICLE BY MEANS OF WATER, ONLY SHOVELING AND SWEEPING WILL BE ALLOWED. CONTRACTOR WILL BE RESPONSIBLE FOR DUST CONTROL FROM THE SITE.
  - PRIOR TO ANY CONSTRUCTION, THE CONTRACTOR SHALL APPLY FOR AND SECURE ALL PROPER PERMITS FROM THE APPROPRIATE AUTHORITIES.
  - ALL WET UTILITIES SHALL BE INSTALLED AND ALL DENSITIES MUST HAVE PASSED INSPECTIONS(S) PRIOR TO THE INSTALLATION OF DRY UTILITIES.
  - A TRAFFIC CONTROL PLAN, IN ACCORDANCE WITH THE TEXAS MANUAL OF UNIFORM TRAFFIC CONTROL DEVICES, SHALL BE SUBMITTED TO THE CITY FOR REVIEW AND APPROVAL PRIOR TO ANY PARTIAL OR COMPLETE ROADWAY CLOSURES. TRAFFIC CONTROL PLANS SHALL BE SITE SPECIFIC AND BE SEALED BY A REGISTERED TEXAS PROFESSIONAL ENGINEER.

**EROSION AND SEDIMENTATION NOTES:**

- EROSION CONTROL MEASURES, SITE WORK, AND RESTORATION WORK SHALL BE IN ACCORDANCE WITH HAYS COUNTY DEVELOPMENT STANDARDS
- SLOPES SHALL BE SODDED OR SEEDDED WITH THE APPROPRIATE GRASS, GRASS MIXTURES, OR GROUND COVER SUITABLE TO THE AREA AND SEASON TO WHICH THEY ARE APPLIED.
- SILT FENCES, ROCK BERMS AND SIMILARLY RECOGNIZED TECHNIQUES AND MATERIALS SHALL BE EMPLOYED DURING CONSTRUCTION TO PREVENT POINT SOURCE SEDIMENTATION LOADING OF DOWNSTREAM FACILITIES. SUCH INSTALLATION SHALL BE REGULARLY INSPECTED BY HAYS COUNTY, THE OWNER, AND/OR ENGINEER FOR EFFECTIVENESS. ADDITIONAL MEASURES MAY BE REQUIRED IF, IN THE OPINION OF THE THOSE NOTED ABOVE ARE WARRANTED.
- ALL TEMPORARY EROSION CONTROL MEASURES SHALL NOT BE REMOVED UNTIL FINAL INSPECTION AND APPROVAL OF THE PROJECT BY THE ENGINEER.
- IT SHALL BE THE RESPONSIBILITY OF THE CONTRACTOR TO MAINTAIN ALL TEMPORARY EROSION CONTROL STRUCTURES AND TO REMOVE EACH STRUCTURE AS APPROVED BY THE ENGINEER.

**HAYS COUNTY GENERAL CONSTRUCTION NOTES**

- SEVENTY-TWO (72) HOURS PRIOR TO THE BEGINNING OF CONSTRUCTION, THE DEVELOPER SHALL ARRANGE A PRE-CONSTRUCTION CONFERENCE WITH ALL PERTINENT PARTIES.
- ALL ROADWAY AND DRAINAGE IMPROVEMENTS SHALL BE DESIGNED AND CONSTRUCTED IN ACCORDANCE WITH HAYS COUNTY SPECIFICATIONS. CONTRACTOR SHALL BE RESPONSIBLE FOR OBTAINING ANY NECESSARY PERMITS FROM HAYS COUNTY ROAD AND BRIDGE DEPARTMENT PRIOR TO BEGINNING ANY ON-SITE CONSTRUCTION. CONTRACTOR SHALL BE RESPONSIBLE FOR SCHEDULING THE NECESSARY INSPECTIONS FROM THE HAYS COUNTY ROAD AND BRIDGE DEPARTMENT. ALL REPAIRS TO IMPROVEMENTS CAUSED BY CONTRACTOR'S FAILURE TO INSTALL IMPROVEMENTS IN ACCORDANCE WITH HAYS COUNTY SPECIFICATIONS AND THESE CONSTRUCTION PLANS SHALL BE THE RESPONSIBILITY OF THE CONTRACTOR. HAYS COUNTY TRANSPORTATION DEPARTMENT'S ACCEPTANCE OF THE IMPROVEMENTS ARE CONTINGENT ON REPAIRS BEING MADE TO HAYS COUNTY'S SATISFACTION. DELAYS CAUSED BY REPAIRS ARE THE RESPONSIBILITY OF THE CONTRACTOR.
- A MINIMUM OF TWO (2) BENCHMARKS SHALL BE SHOWN ON THE CONSTRUCTION PLANS.
- ALL BEDDING MATERIALS USED WITHIN THE ROW SHALL COMPLY WITH COA ITEM 510.
- ALL CONCRETE PLACED WITHIN THE ROW SHALL BE A MINIMUM OF CLASS A. THE USE OF REBAR CHAIRS AND TESTS CYLINDERS WILL BE REQUIRED ON PCC VALLEY GUTTER PLACEMENTS.
- THE PROPOSED FULLY DEVELOPED STORMWATER RUNOFF RATE CANNOT EXCEED EXISTING CONDITIONS RUNOFF RATE.
- DEWATERING OPERATIONS MUST USE SWPPP-SPECIFIED METHODS ONLY. IF SUCH METHODS ARE ONLY GENERAL OR NOT APPLICABLE, PUMP FROM THE TOP OF THE POOL (RATHER THAN THE BOTTOM) AND DISCHARGE TO A VEGETATED, UPLAND AREA (AWAY FROM WATERBODIES OR DRAINAGES) OR USE ANOTHER TYPE OF FILTRATION PRIOR TO DISCHARGE. REFER TO THE EPA 2017 GENERAL CONSTRUCTION PERMIT, SECTION 2.4, AS APPLICABLE.
- THE CONTRACTOR SHALL SUPPLY QUALIFIED PERSONNEL TO PERFORM SWPPP INSPECTIONS ON PROJECT  $\geq$  1 ACRE. QUALIFIED PERSONNEL SHALL HAVE CISEC, CESSWI, OR EQUIVALENT CERTIFICATION APPROVED BY THE MS4.
- CONTRACTOR SHALL ENSURE THAT MUD AND DEBRIS TRACKED ONTO PUBLICLY MAINTAINED ROADWAYS FROM VEHICLES LEAVING THE CONSTRUCTION SITE WILL BE CLEANED UP DAILY.
- NO EXPLOSIVES SHALL BE USED FOR THIS PROJECT WITHOUT TCEQ APPROVAL.
- ALL HOLES, TRENCHES AND OTHER HAZARDOUS AREAS SHALL BE ADEQUATELY PROTECTED BY BARRICADES, FENCING, LIGHTS AND/OR OTHER PROTECTIVE DEVICES IN COMPLIANCE WITH COA 509S AND OSHA REGULATIONS AT ALL TIMES.
- THE CONTRACTOR SHALL SUBMIT A TRENCH SAFETY PLAN PREPARED AND SEALED BY AN ENGINEER LICENSED BY THE STATE OF TEXAS PRIOR TO THE START OF THE PROJECT. THE CONTRACTOR SHALL ASSIGN A COMPETENT PERSON THAT HAS BEEN PROPERLY TRAINED AND IS QUALIFIED TO MAKE INSPECTIONS AND SUPERVISE THE INSTALLATION, MAINTENANCE, AND REMOVAL OF THE TRENCH SAFETY OR EXCAVATION SAFETY SYSTEM.
- HAYS COUNTY IS NOT RESPONSIBLE FOR SIDEWALK MAINTENANCE. A FULLY EXECUTED LICENSE AGREEMENT MUST BE IN-PLACE PRIOR TO CONSTRUCTION OF SIDEWALKS WITHIN HAYS COUNTY ROW.
- CONTRACTOR SHALL COMPLY WITH CONSTRUCTION SEQUENCING WHICH MAY BE SPECIFIED SOMEWHERE IN THE CONSTRUCTION PLANS.
- PERMIT IS REQUIRED FOR CONSTRUCTION IN 'RIGHT OF WAY': ORDINANCE 7.10. NODRIVEWAY, UTILITY CONSTRUCTION, MAILBOXES, LANDSCAPING OR ANY OTHER ENCROACHMENT INTO RIGHT-OF-WAY OR EASEMENT SHALL BE ALLOWED WITHOUT FIRST OBTAINING A PERMIT FROM THE HAYS COUNTY ROAD AND BRIDGE DEPARTMENT.
- PRIOR TO THE INSTALLATION OF ANY ROAD BUILDING MATERIAL THE SUBGRADE SHALL BE INSPECTED BY HAYS COUNTY. PRIOR TO PAVING, BASE MATERIAL SHALL BE INSPECTED BY HAYS COUNTY. THE OWNER OR HIS AGENT SHALL NOTIFY HAYS COUNTY FORTY-EIGHT (48) HOURS PRIOR TO THE TIME WHEN THE INSPECTION IS NEEDED :ORDINANCE 1.05; 2.06.
- ALL OUTFALLS CONSTRUCTED WITHIN HAYS COUNTY MUST BE SUBMITTED TO HAYS COUNTY WITH GPS COORDINATES AT THE END OF EACH PROJECT. COORDINATES WILL BE SUBMITTED ON THE NAD 1983 STATE PLANE SOUTH CENTRAL FIPS 4204 FEET COORDINATE SYSTEM. ALL COORDINATES WILL BE SUBMITTED IN GRID UNITS. THE REQUIRED FILE TYPE FOR COORDINATE DATA SUBMISSIONS IS \*TXT FORMAT.
- AT THE TIME A FINAL INSPECTION AND RELEASE OF PERFORMANCE SECURITY IS REQUESTED; THE DESIGN ENGINEER SHALL PROVIDE A COMPLETE SET OF "AS-BUILT" RECORD DRAWINGS IN PDF FORMAT (300DPI) ON A VIRUS FREE DISK AND SHALL CERTIFY THAT ALL ROAD AND DRAINAGE CONSTRUCTION HAS BEEN COMPLETED IN SUBSTANTIAL ACCORDANCE WITH PREVIOUSLY APPROVED PLANS AND SPECIFICATIONS, EXCEPT AS NOTED. NO PERFORMANCE SECURITY WILL BE RELEASED WITHOUT THESE EXHIBITS.

**SEQUENCE OF CONSTRUCTION NOTES:**

- INSTALL TEMPORARY EROSION CONTROLS AND TREE PROTECTION PER APPROVED PLANS.
- PRIOR TO BEGINNING CONSTRUCTION, THE OWNER OR HIS AUTHORIZED REPRESENTATIVE SHALL CONVENE A PRE-CONSTRUCTION CONFERENCE BETWEEN HAYS COUNTY, HAYS COUNTY FIRE MARSHAL, CONSULTING ENGINEER, CONTRACTOR, AND ANY OTHER AFFECTED PARTIES.
- ROUGH CUT DETENTION AND WATER QUALITY PONDS IN ORDER TO COLLECT SEDIMENT FROM RUNOFF DURING CONSTRUCTION ACTIVITIES.
- INSTALL ALL UTILITIES TO BE LOCATED UNDER THE PROPOSED PAVEMENT.
- BEGIN CONSTRUCTION OF CHANNELS & INSTALLATION OF STORM SEWER LINES. UPON COMPLETION, RESTORE AS MUCH DISTURBED AREAS AS POSSIBLE, PARTICULARLY CHANNELS AND LARGE OPEN AREAS.
- REGRADE STREETS TO SUBGRADE.
- INSURE THAT ALL UNDERGROUND UTILITY CROSSINGS ARE COMPLETE. LAY FIRST COURSE BASE MATERIAL ON STREETS.
- INSTALL CURB AND GUTTER.
- LAY FINAL BASE COURSE ON ALL STREETS.
- LAY ASPHALT OR OTHER APPROVED PAVEMENT.
- COMPLETE REMAINING UNDERGROUND INSTALLATION.
- COMPLETE FINAL GRADING AND RESTORATION OF CHANNELS, DETENTION, SEDIMENTATION/FILTRATION PONDS.
- COMPLETE FINAL GRADING.
- COMPLETE PERMANENT EROSION CONTROL AND RESTORATION OF SITE VEGETATION.
- PROJECT ENGINEER WRITING CONCURRENCE LETTER, AND SCHEDULING FINAL INSPECTION WITH EV INSPECTOR, HAYS COUNTY, AND HAYS COUNTY FIRE MARSHAL PRIOR TO THE REMOVAL OF EROSION CONTROLS.
- COMPLETE BUILDING CONSTRUCTION.
- REMOVE AND DISPOSE OF TEMPORARY EROSION CONTROLS & TREE PROTECTION.
- RESTORE ANY AREAS DISTURBED DURING REMOVAL OF EROSION/SEDIMENTATION CONTROLS.

NO.	DESCRIPTION	APP	DATE

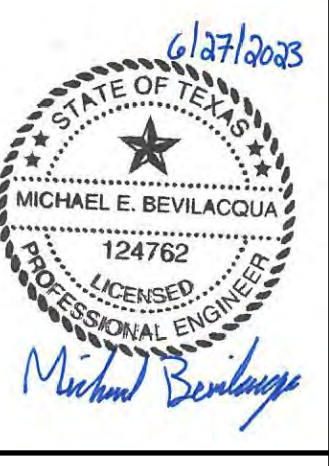

301 Denali Pass Dr., Suite 3  
Cedar Park, Texas 78613  
(512) 640-0390

**Green**  
Civil Design  
Engineering & Consulting

Texas Registered Engineering Firm F-17563

ACTON ACADEMY  
ACTON ACADEMY - PHASE 1

GENERAL NOTES (1 OF 2)



**Texas Commission on Environmental Quality  
Contributing Zone Plan  
General Construction Notes**

**Edwards Aquifer Protection Program Construction Notes – Legal Disclaimer**

*The following/listed "construction notes" are intended to be advisory in nature only and do not constitute an approval or conditional approval by the Executive Director (ED), nor do they constitute a comprehensive listing of rules or conditions to be followed during construction. Further actions may be required to achieve compliance with TCEQ regulations found in Title 30, Texas Administrative Code (TAC), Chapters 213 and 217, as well as local ordinances and regulations providing for the protection of water quality. Additionally, nothing contained in the following/listed "construction notes" restricts the powers of the ED, the commission or any other governmental entity to prevent, correct, or curtail activities that result or may result in pollution of the Edwards Aquifer or hydrologically connected surface waters. The holder of any Edwards Aquifer Protection Plan containing "construction notes" is still responsible for compliance with Title 30, TAC, Chapters 213 or any other applicable TCEQ regulation, as well as all conditions of an Edwards Aquifer Protection Plan through all phases of plan implementation. Failure to comply with any condition of the ED's approval, whether or not in contradiction of any "construction notes," is a violation of TCEQ regulations and any violation is subject to administrative rules, orders, and penalties as provided under Title 30, TAC § 213.10 (relating to Enforcement). Such violations may also be subject to civil penalties and injunction. The following/listed "construction notes" in no way represent an approved exception by the ED to any part of Title 30 TAC, Chapters 213 and 217, or any other TCEQ applicable regulation*

1. A written notice of construction must be submitted to the TCEQ regional office at least 48 hours prior to the start of any ground disturbance or construction activities. This notice must include:
  - the name of the approved project;
  - the activity start date; and
  - the contact information of the prime contractor.
2. All contractors conducting regulated activities associated with this project should be provided with complete copies of the approved Contributing Zone Plan (CZP) and the TCEQ letter indicating the specific conditions of its approval. During the course of these regulated activities, the contractor(s) should keep copies of the approved plan and approval letter on-site.
3. No hazardous substance storage tank shall be installed within 150 feet of a water supply source, distribution system, well, or sensitive feature.
4. Prior to beginning any construction activity, all temporary erosion and sedimentation (E&S) control measures must be properly installed and maintained in accordance with the manufacturers specifications. If inspections indicate a control has been used inappropriately, or incorrectly, the applicant must replace or modify the control for site situations. These controls must remain in place until the disturbed areas have been permanently stabilized.
5. Any sediment that escapes the construction site must be collected and properly disposed of before the next rain event to ensure it is not washed into surface streams, sensitive features, etc.
6. Sediment must be removed from the sediment traps or sedimentation basins when it occupies 50% of the basin's design capacity.
7. Litter, construction debris, and construction chemicals exposed to stormwater shall be prevented from being discharged offsite.
8. All excavated material that will be stored on-site must have proper E&S controls.
9. If portions of the site will have a cease in construction activity lasting longer than 14 days, soil

stabilization in those areas shall be initiated as soon as possible prior to the 14<sup>th</sup> day of inactivity. If activity will resume prior to the 21<sup>st</sup> day, stabilization measures are not required. If drought conditions or inclement weather prevent action by the 14<sup>th</sup> day, stabilization measures shall be initiated as soon as possible.

10. The following records should be maintained and made available to the TCEQ upon request:
  - the dates when major grading activities occur;
  - the dates when construction activities temporarily or permanently cease on a portion of the site; and
  - the dates when stabilization measures are initiated.
11. The holder of any approved CZP must notify the appropriate regional office in writing and obtain approval from the executive director prior to initiating any of the following:
  - A. any physical or operational modification of any best management practices (BMPs) or structure(s), including but not limited to temporary or permanent ponds, dams, berms, silt fences, and diversionary structures;
  - B. any change in the nature or character of the regulated activity from that which was originally approved;
  - C. any change that would significantly impact the ability to prevent pollution of the Edwards Aquifer; or
  - D. any development of land previously identified as undeveloped in the approved contributing zone plan.

Austin Regional Office 12100 Park 35 Circle, Building A Austin, Texas 78753-1808 Phone (512) 339-2929 Fax (512) 339-3795	San Antonio Regional Office 14250 Judson Road San Antonio, Texas 78233-4480 Phone (210) 490-3096 Fax (210) 545-4329
--	---

**THESE GENERAL CONSTRUCTION NOTES MUST BE INCLUDED ON THE CONSTRUCTION PLANS PROVIDED TO THE CONTRACTOR AND ALL SUBCONTRACTORS.**

NO.	DESCRIPTION	APP	DATE



**Green Civil Design**  
 Engineering & Consulting  
 Texas Registered Engineering Firm F-17563  
 301 Denali Pass Dr., Suite 3  
 Cedar Park, Texas 78613  
 (512) 640-6390

ACTON ACADEMY  
 ACTON ACADEMY - PHASE 1  
 GENERAL NOTES (2 OF 2)







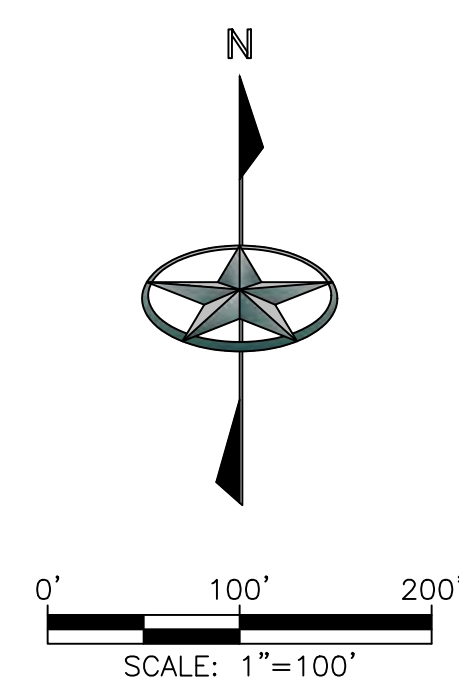
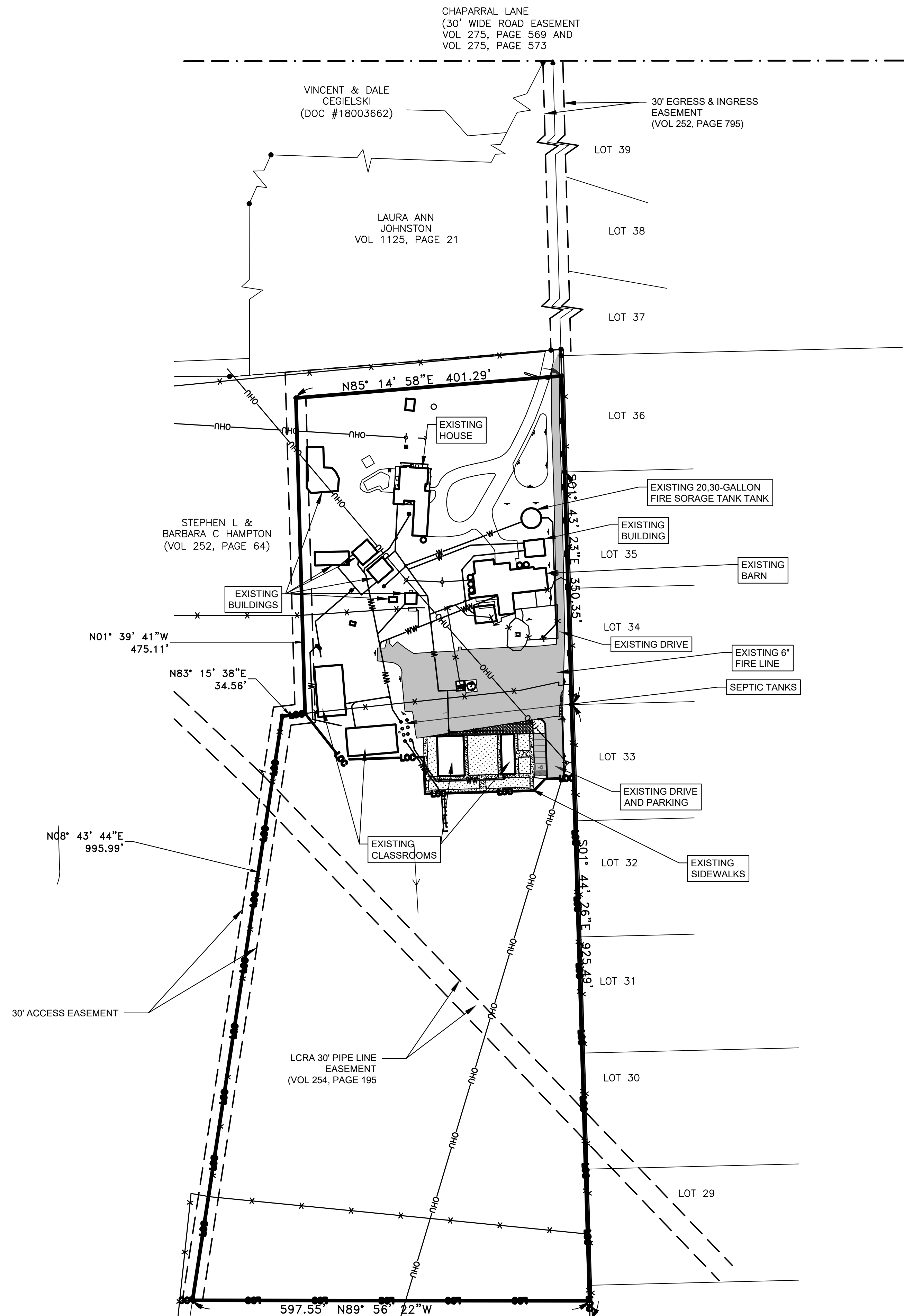



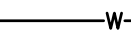

FILE: p:\Projects\1137 - cody roberts\003 - acton academy phase 1\CAD\Sheets\1137-003 - GENERAL NOTES.dwg TAB: 3 GENERAL NOTES (2 OF 2) PLOTTED: 6/30/2023 11:37 AM BY: MIKE BEV

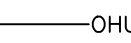

FILE: p:\Projects\1137 - cody roberts\003 - acton academy phase 1\CAD\Sheets\1137-003 - EXISTING SITE PLAN.dwg TAB: 4 EXISTING SITE PLAN PLOTTED: 6/20/2023 11:37 AM BY: MIKE BEY

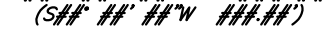

**LEGEND**

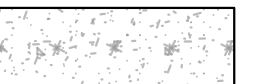
-  IRON ROD FOUND
-  IRON ROD SET
-  EXISTING WATER LINE
-  EXISTING WASTEWATER LINE
-  EXISTING VALVE
-  EXISTING FIRE HYDRANT
-  EXISTING WASTEWATER MANHOLE
-  EXISTING OVERHEAD UTILITY
-  EXISTING UTILITY POLE
-  EXISTING WIRE FENCE
-  PROPERTY LINE
-  EXISTING CONTOUR
-  SURVEYED MEASURED LOT DIMENSION
-  EXISTING CALICHE BASE ROAD
-  EXISTING CONCRETE

NO.	DESCRIPTION	APP	DATE



  
**Green Civil Design**
  
 Engineering & Consulting

Texas Registered Engineering Firm F-17663

301 Denali Pass Dr., Suite 3  
 Cedar Park, Texas 78613  
 (512) 640-0590

ACTON ACADEMY  
 ACTON ACADEMY - PHASE 1  
 EXISTING SITE PLAN



FILE: p:\Projects\1137 - cody roberts\003 - acton academy phase 1\CAD\Sheets\1137-003 - PROPOSED EROSION CONTROL PLAN.dwg TAB: E&S PLOTTED: 6/30/2023 11:38 AM BY: MIKE BEV

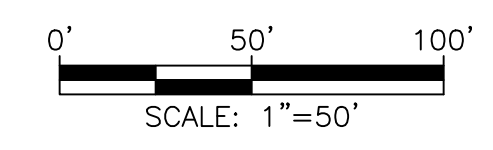
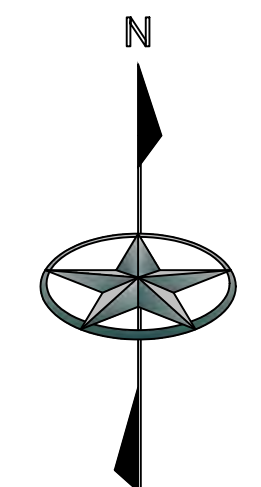
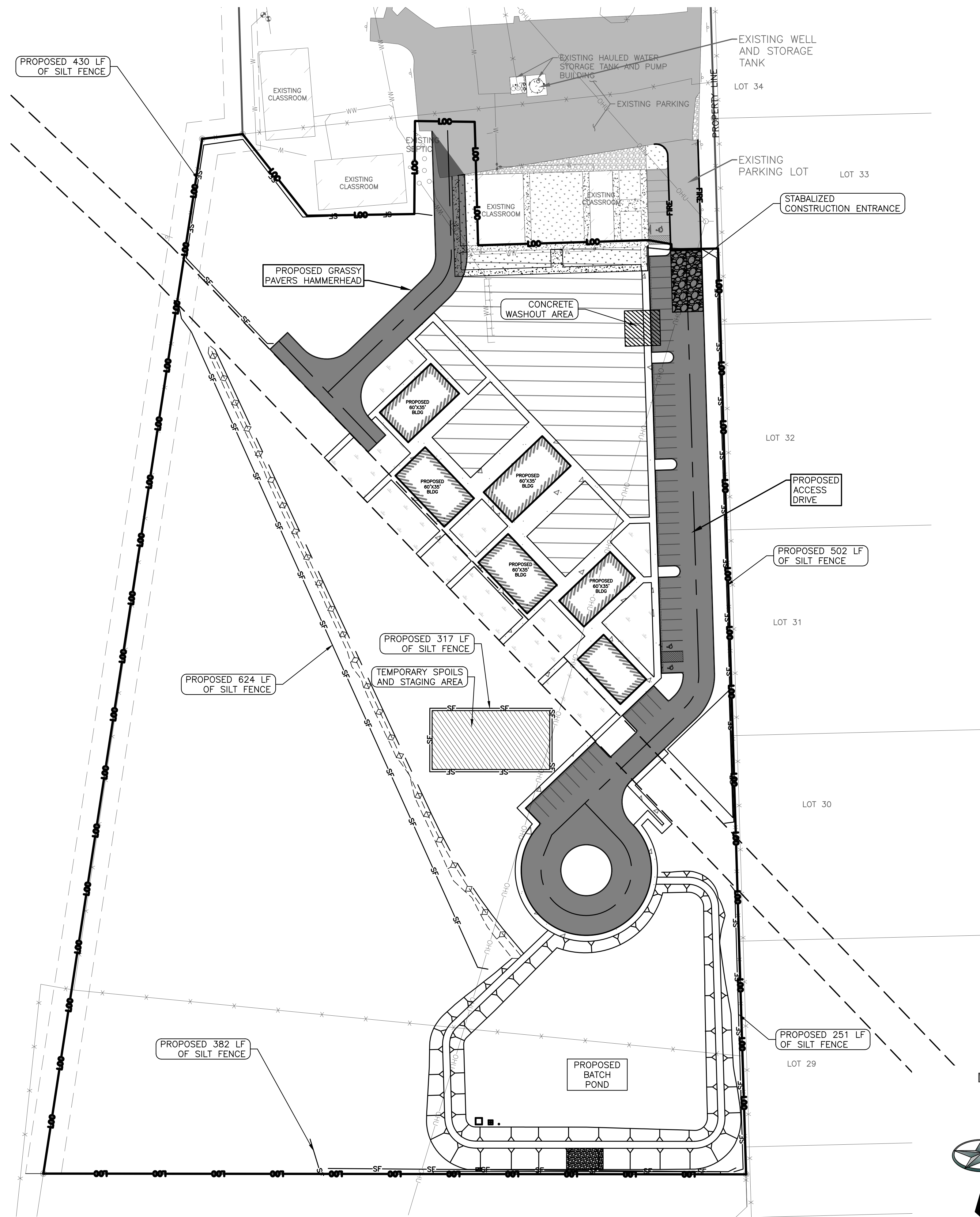

**EROSION AND DEMOLITION NOTES:**

1. A PRECONSTRUCTION MEETING WITH HAYS COUNTY, HAYS COUNTY FIRE MARSHAL, ENGINEER, AND OWNER IS REQUIRED PRIOR TO ANY SITE DISTURBANCE. IF DISTURBED AREA IS NOT TO BE WORKED ON FOR MORE THAN 14 DAYS, DISTURBED AREA NEEDS TO BE STABILIZED BY REVEGETATION, MULCH, TARP OR REVEGETATION MATTING. ENVIRONMENTAL INSPECTOR HAS THE AUTHORITY TO ADD AND/OR MODIFY EROSION/SEDIMENTATION CONTROLS.
2. CONTRACTOR SHALL UTILIZE DUST CONTROL MEASURES DURING SITE CONSTRUCTION SUCH AS IRRIGATION TRUCKS AND MULCHING.
3. MOVE TEMPORARY SPOILS AND STAGING AREA PERIODICALLY TO FOLLOW PROGRESS OF CONSTRUCTION.
4. ADD SILT FENCE DOWNSLOPE OF ALL STAGING AREAS.
5. CONTRACTOR SHALL SPECIFY TYPE AND LOCATION OF CONCRETE WASHOUT.
6. LIMITS OF CONSTRUCTION (LOC) SHALL BE LOCATED AT THE PROPERTY LINES. LOC SHOWN OFFSET FOR CLARITY.
7. SILT FENCE SHALL BE SITUATED SO THAT ENDS ARE ARCHED AND POINTED UPSTREAM.
8. FOR SILT FENCE, INSTALL J-HOOKS AT MAXIMUM 100 FT SPACING.

**LEGEND**

	LIMITS OF CONSTRUCTION
	PROPOSED SILT FENCE
	PROPERTY LINE
	LOT LINE
	EXISTING CONTOUR
	STAGING AND SPOILS AREA
	STABILIZED CONSTRUCTION ENTRANCE
	CONCRETE WASHOUT

NO.	DESCRIPTION	APP	DATE



**Green Civil Design**  
*Engineering & Consulting*  
 Texas Registered Engineering Firm F-17563  
 301 Denali Pass Dr., Suite 3  
 Cedar Park, Texas 78613  
 (512) 640-0590













ACTON ACADEMY  
 ACTON ACADEMY - PHASE 1  
 PROPOSED EROSION AND SEDIMENTATION CONTROL PLAN







**LEGEND**

-  IRON ROD FOUND
-  IRON ROD SET
-  EXISTING OVERHEAD UTILITY
-  EXISTING UTILITY POLE
-  EXISTING WIRE FENCE
-  PROPERTY LINE
-  EXISTING CONTOUR
-  PROPOSED FIRE LANE
-  PROPOSED CONCRETE
-  PROPOSED SEPTIC DRAIN FIELD
-  PROPOSED PLAY AREA
-  FIRE LANE SIGNAGE

**KEYNOTES:**

-  PROPOSED HANDICAP WITH VAN ACCESSIBLE SIGN WITH BOLLARD (2 TOTAL).
-  PROPOSED HANDICAP SIGN WITH BOLLARD (2 TOTAL).
-  PROPOSED CURB STOP. ALL ACCESSIBLE SPOTS.
-  PROPOSED RIBBON CURB ALONG HANDICAP PARKING SPOTS

**STRIPING NOTES:**

1. PARKING AND HANDICAP STRIPING SHALL BE 4" WIDE, WHITE, TYPE II (WATER-BASED PAINT) UNLESS OTHERWISE NOTED IN THE DETAIL.
2. CROSSWALK STRIPING SHALL BE 6" WIDE STRIPES, TYPE II (WATER-BASED PAINT). LONGITUDINAL STRIPES SHALL BE 6.5-FT APART TO PROVIDE 6' GAP BETWEEN STRIPES. TRANSVERSE STRIPES AT 4' O.C.
3. SEE DETAIL SHEET 17 FOR FIRE LANE STRIPING.
4. SEE SHEET 18 FOR HANDICAP STRIPING REQUIREMENTS.

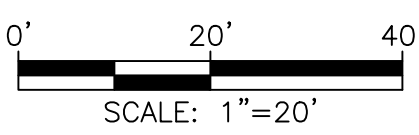

FILE: p:\Projects\1137 - acton academy phase 1\CAD\Sheets\1137-003 - PROPOSED SITE PLAN.dwg TAB: 7 PROPOSED SITE PLAN (1 OF 2) PLOTTED: 6/30/2023 11:38 AM BY: MIKE BEV

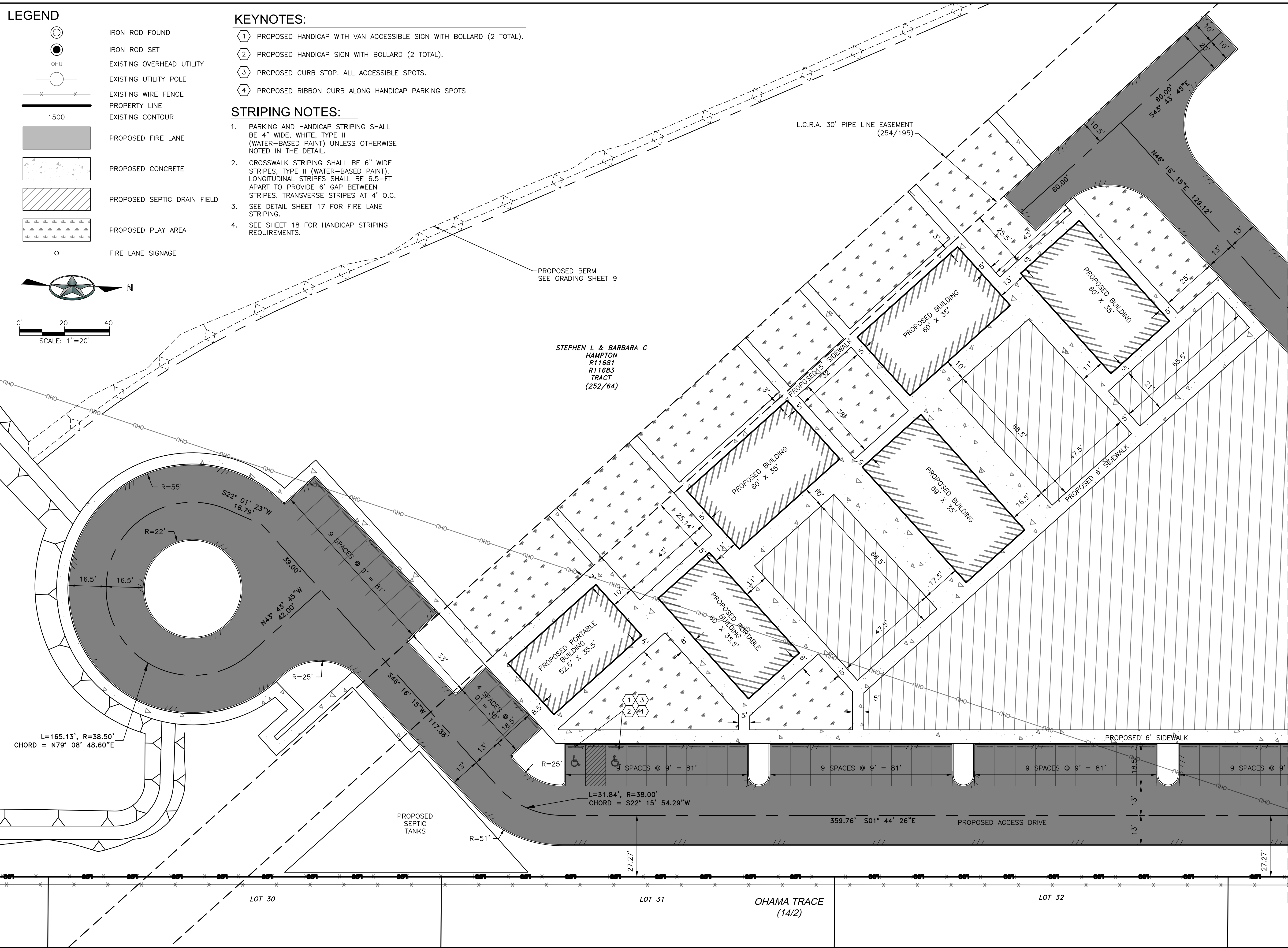

MATCHLINE  
SEE SHEET 8

NO.	DESCRIPTION	APP	DATE

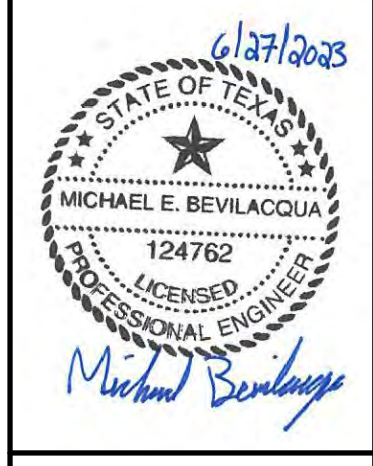

**Green**  
**CD** **Civil Design**  
*Engineering & Consulting*

Texas Registered Engineering Firm F-17563

301 Denali Pass Dr., Suite 3  
Cedar Park, Texas 78613  
(512) 640-0390

ACTON ACADEMY  
ACTON ACADEMY - PHASE 1

PROPOSED SITE PLAN (1 OF 2)

---

SHEET  
**7**  
OF 18



FILE: p:\Projects\1137 - cody roberts\003 - acton academy phase 1\CAD\Sheets\1137-003 - PROPOSED SITE PLAN.dwg TAB: B PROPOSED SITE PLAN (2 OF 2) PLOTTED: 6/30/2023 11:38 AM BY: MIKE BEV

LEGEND	
	IRON ROD FOUND
	IRON ROD SET
	EXISTING OVERHEAD UTILITY
	EXISTING UTILITY POLE
	EXISTING WIRE FENCE
	PROPERTY LINE
	EXISTING CONTOUR
	PROPOSED FIRE LANE
	PROPOSED CONCRETE
	PROPOSED SEPTIC DRAIN FIELD
	PROPOSED PLAY AREA
	FIRE LANE SIGNAGE

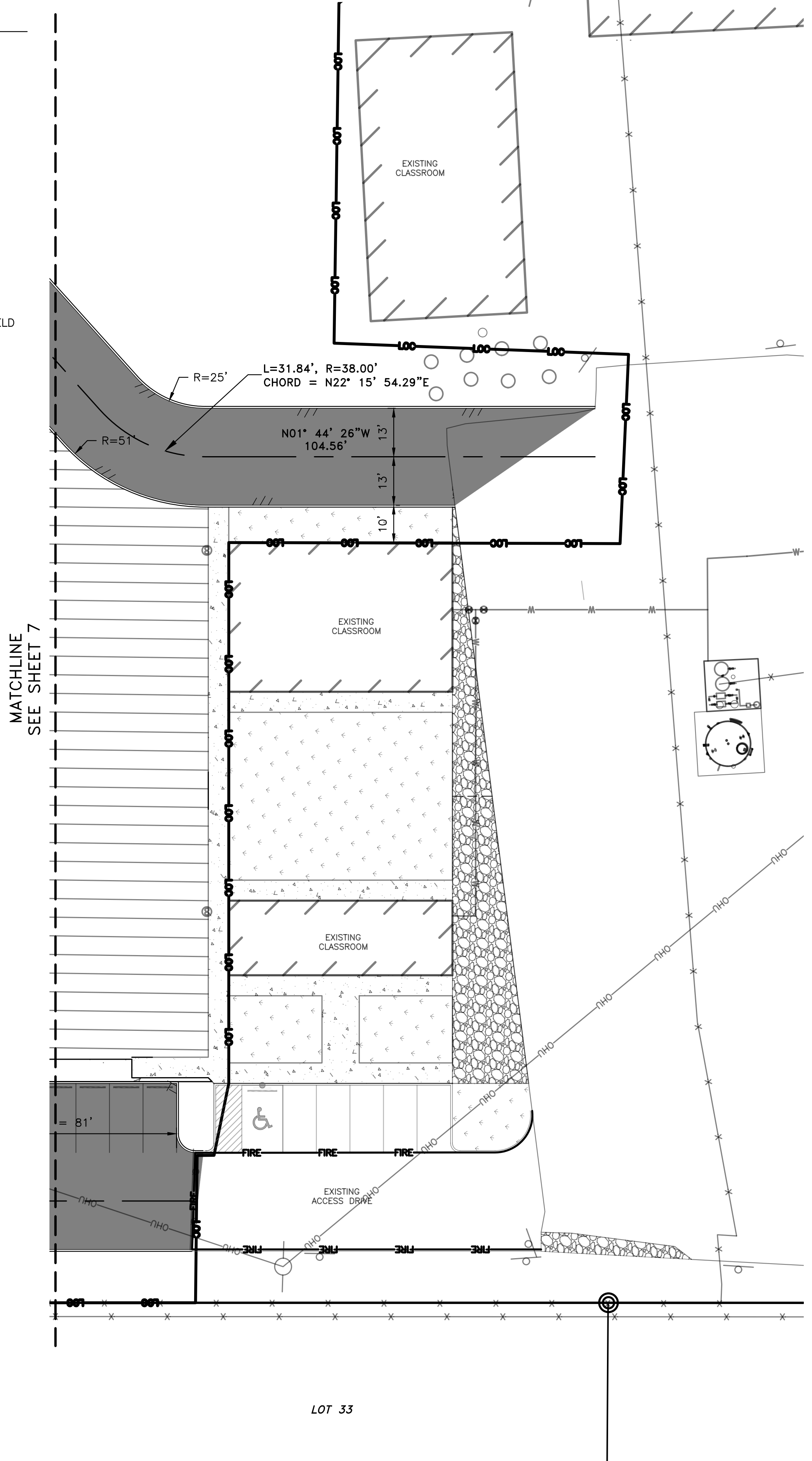

NO.	DESCRIPTION	APP	DATE

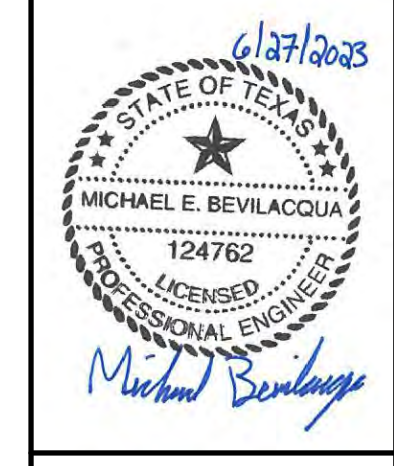

**Green**  
**Civil Design**  
 Engineering & Consulting  
 Texas Registered Engineering Firm F-17563











301 Denali Pass Dr., Suite 3  
 Cedar Park, Texas 78613  
 (512) 640-0390

ACTON ACADEMY  
 ACTON ACADEMY - PHASE 1  
 PROPOSED SITE PLAN (2 OF 2)

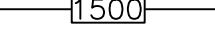
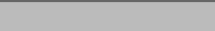

FILE: p:\Projects\1137 - cody roberts\003 - acton academy phase 1\CAD\Sheets\1137-003 - PROPOSED GRADING.dwg TAB: 9 PROPOSED GRADING PLAN (1 OF 2) PLOTTED: 6/20/2023 11:38 AM BY: MIKE BEY

**LEGEND**

-  IRON ROD FOUND
-  IRON ROD SET
-  EXISTING OVERHEAD UTILITY
-  EXISTING UTILITY POLE
-  EXISTING WIRE FENCE
-  PROPERTY LINE
-  EXISTING CONTOUR
-  PROPOSED CONTOUR
-  PROPOSED FIRE LANE
-  PROPOSED CONCRETE
-  PROPOSED SEPTIC DRAIN FIELD
-  PROPOSED PLAY AREA
-  FIRE LANE SIGNAGE

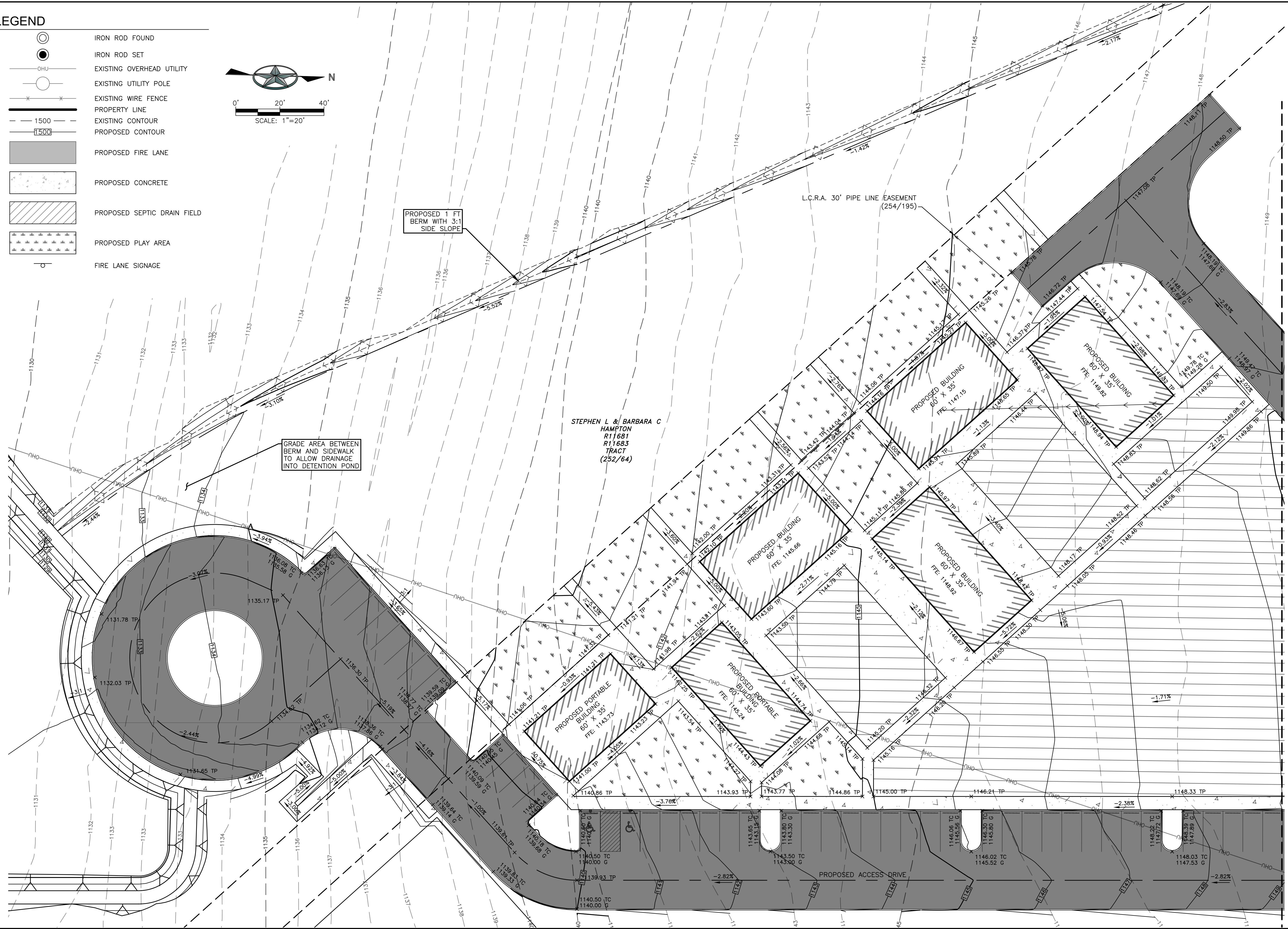
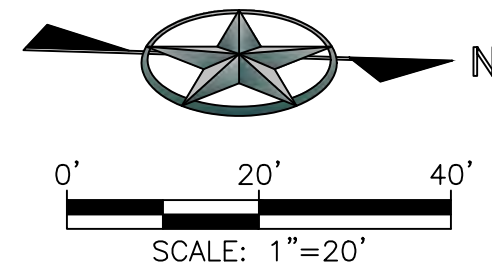

MATCHLINE  
SEE SHEET 10

NO.	DESCRIPTION	APP	DATE

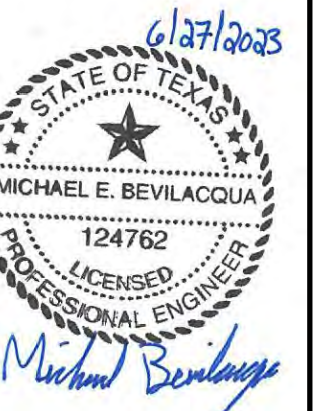

**Green**  
Civil Design  
Engineering & Consulting

301 Denali Pass Dr, Suite 3  
Cedar Park, Texas 78613  
(512) 640-0390

Texas Registered Engineering Firm F-17563











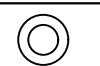

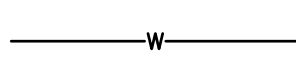
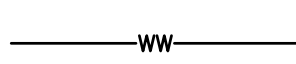



ACTON ACADEMY  
ACTON ACADEMY - PHASE 1  
PROPOSED GRADING PLAN (1 OF 2)

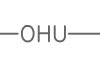

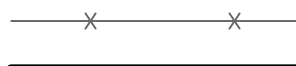
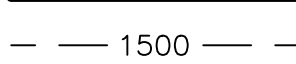
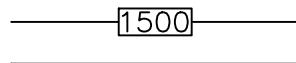

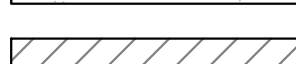

**LEGEND**

-  IRON ROD FOUND
-  IRON ROD SET
-  PROPOSED WATER LINE
-  PROPOSED WASTEWATER LINE
-  PROPOSED VALVE
-  PROPOSED FIRE HYDRANT
-  PROPOSED WASTEWATER MANHOLE
-  PROPOSED WASTEWATER CLEANOUT
-  EXISTING OVERHEAD UTILITY
-  EXISTING UTILITY POLE
-  EXISTING WIRE FENCE
-  PROPERTY LINE
-  EXISTING CONTOUR
-  PROPOSED CONTOUR
-  PROPOSED FIRE LANE
-  PROPOSED CONCRETE
-  PROPOSED SEPTIC DRAIN FIELD
-  PROPOSED PLAY AREA
-  FIRE LANE SIGNAGE

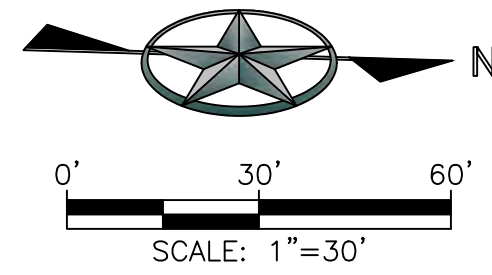

**KEYNOTES:**

- ① IF PROJECT/BUILDING INSTALLATION IS PHASED, CAP FIRE LINE - B AT TEE FOR FUTURE FIRE LINE INSTALLATION TO THE WEST TOWARDS THE HAMMERHEAD.

**PIPE MATERIAL:**

- FIRE LINE: C900 DR18 PVC (OR OTHER APPROVED NFPA 24 PIPE).
- WASTEWATER: SDR 26 PVC
- DOMESTIC WATER: SCH. 80 PVC

FILE: p:\Projects\1137 - acton academy phase 1\CAD\Sheets\1137-003 - PROPOSED UTILITIES.dwg TAB: 9 PROPOSED GRADING PLAN (1 OF 2) PLOTTED: 6/30/2023 11:39 AM BY: MIKE BEV

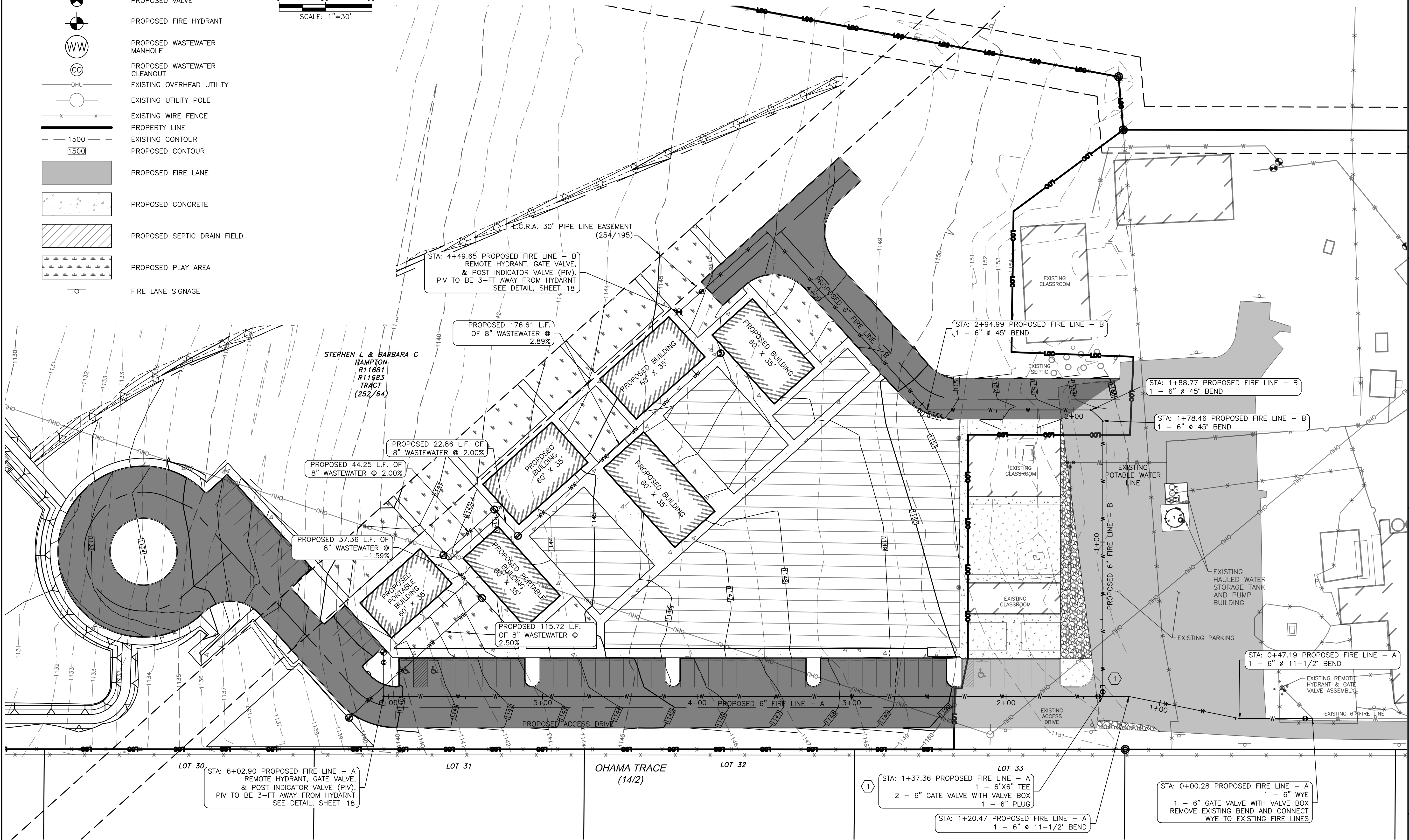

NO.	DESCRIPTION	APP	DATE





  
**Green Civil Design**  
 Engineering & Consulting  
 Texas Registered Engineering Firm F-17563  
 301 Denali Pass Dr., Suite 3  
 Cedar Park, Texas 78613  
 (512) 640-6590

ACTON ACADEMY  
 ACTON ACADEMY - PHASE 1  
 PROPOSED UTILITY PLAN  
 SHEET  
**11**  
 OF 18

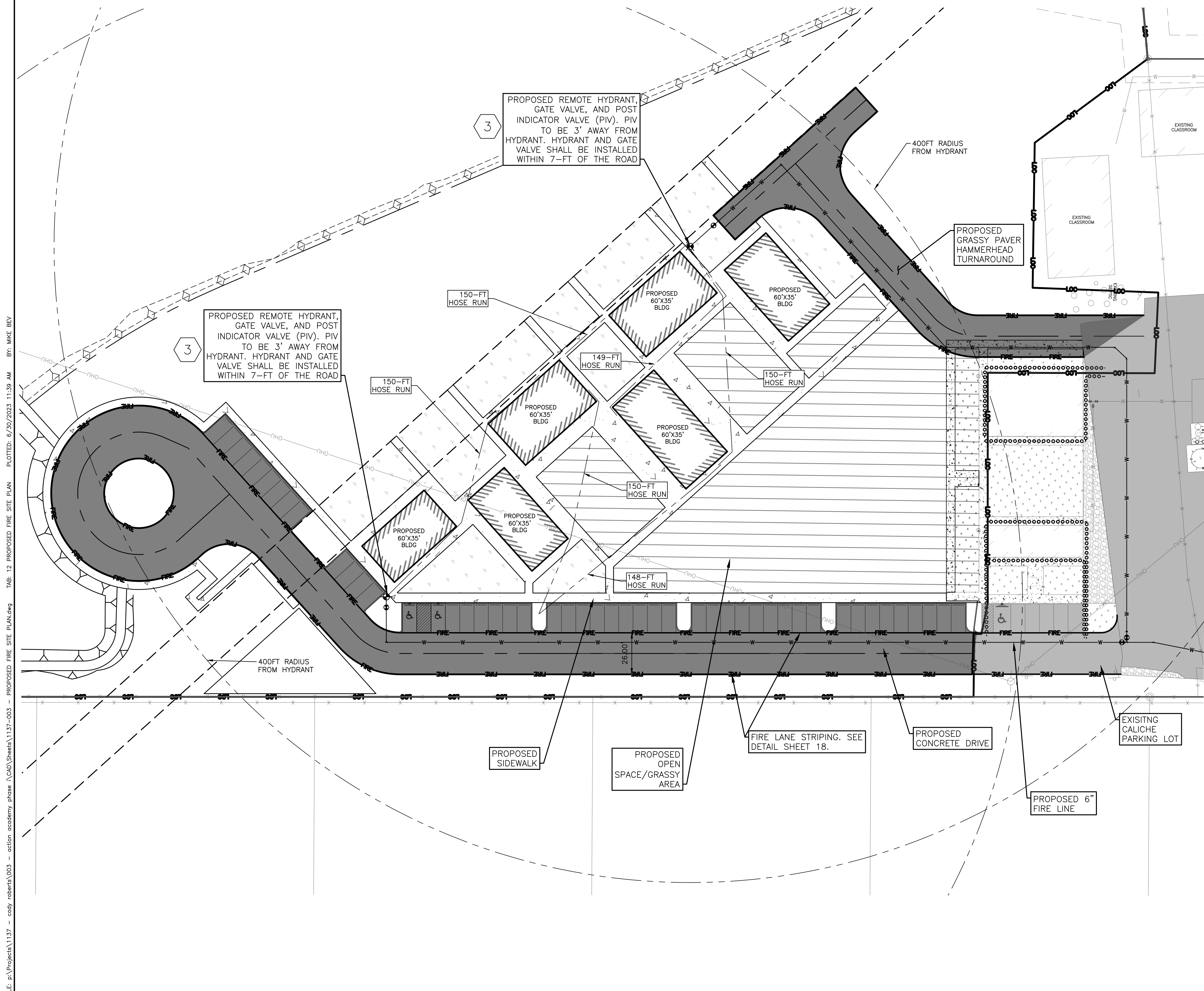

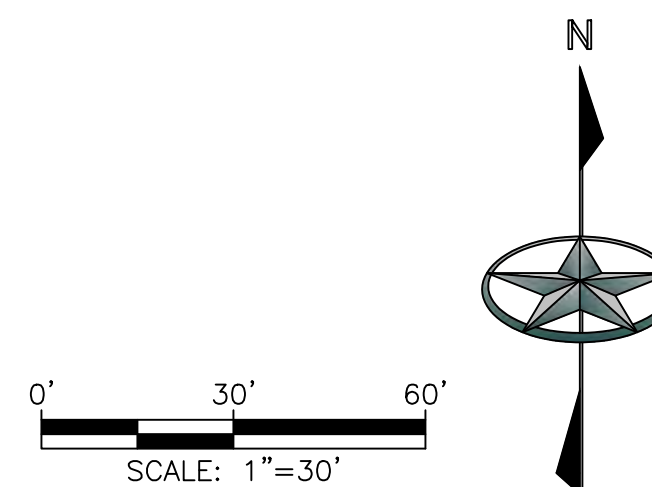

FILE: p:\Projects\1137 - cody roberts\003 - acton academy phase 1\CAD\Sheets\1137-003 - PROPOSED FIRE SITE PLAN.dwg TAB: 12 PROPOSED FIRE SITE PLAN PLOTTED: 6/30/2023 11:39 AM BY: MIKE BEV



**KEYNOTES:**

- ① DISTANCE BETWEEN BUILDINGS SHALL BE A MINIMUM OF 1.5 X EAVE HEIGHT.
- ② MECHANICALLY RESTRAIN ALL BENDS, FITTINGS AND VALVES. FIRE HYDRANT SHALL BE IN ACCORDANCE WITH HAYS COUNTY FIRE MARSHAL STANDARDS.
- ③ PROVIDE 4 BOLLARDS, EQUALLY SPACED AROUND HYDRANT. SEE DETAIL SHEET 12

**FIRE LANE NOTES:**

- 1. THE FIRE LANE SHALL CONSIST OF A CONCRETE DRIVE OR A MINIMUM OF 6" AGGREGATE BASE, PER TERRACON'S ALL WEATHER UNPAVED ACCESS FOR EMERGENCY VEHICLES MEMO DATED 1/15/2021. ANY PROPOSED AGGREGATE BASE SHALL MATCH THE EXISTING BASE.

**NOTES:**

- 1. FIRE LINES ARE ROUTED FROM AN EXISTING 20,300-GALLON FIRE STORAGE TANK. SEE SHEET 4 FOR LOCATION OF EXISTING TANK.
- 2. FIRE LINE SHALL BE C900 DR 18 PVC.

**LEGEND**

	IRON ROD FOUND
	IRON ROD SET
	EXISTING OVERHEAD UTILITY
	EXISTING UTILITY POLE
	EXISTING WIRE FENCE
	PROPERTY LINE
	EXISTING CONTOUR
	PROPOSED FIRE LANE
	FIRE LANE SIGNAGE

NO.	DESCRIPTION	APP	DATE



301 Denali Pass Dr., Suite 3  
Cedar Park, Texas 78613  
(512) 640-6390

**Green**  
Civil Design  
Engineering & Consulting

Texas Registered Engineering Firm F-17563

ACTON ACADEMY  
ACTON ACADEMY - PHASE 1

PROPOSED FIRE SITE PLAN

SHEET  
**12**  
OF 18







FILE: p:\Projects\1137 - cody roberts\003 - acton academy phase 1\CAD\Sheets\1137-003 - PROPOSED DRAINAGE PLAN.dwg TAB: 14 PROPOSED DRAINAGE PLAN PLOTTED: 6/30/2023 11:39 AM BY: MIKE BEV

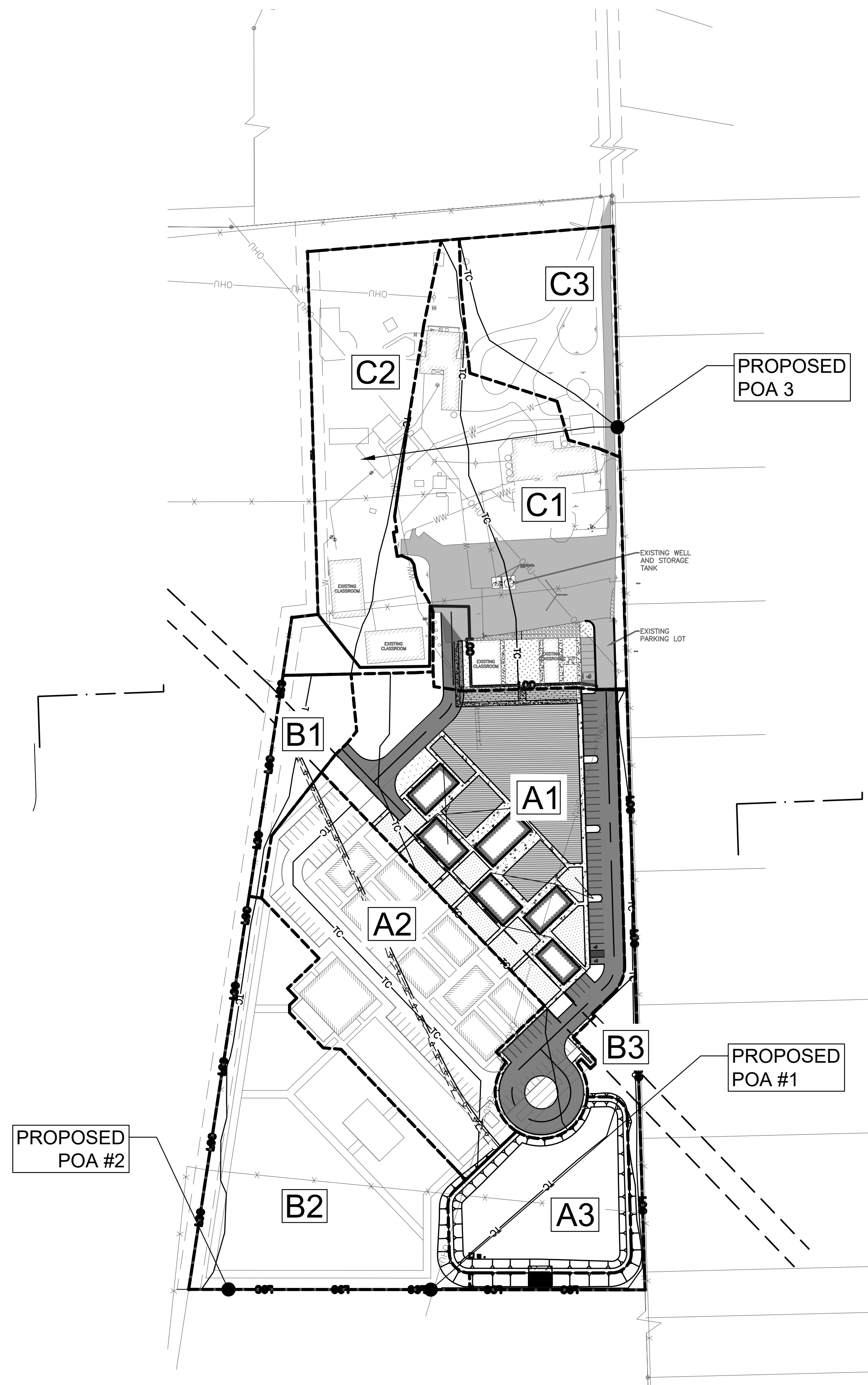

**LEGEND**

	IRON ROD FOUND
	IRON ROD SET
	EXISTING OVERHEAD UTILITY
	EXISTING UTILITY POLE
	EXISTING WIRE FENCE
	PROPERTY LINE
	EXISTING CONTOUR
	PROPOSED FIRE LANE
	FIRE LANE SIGNAGE

**HEC HMS RESULTS SUMMARY  
BATCH POND/POA #1<sup>1</sup>**

	EXISTING FLOW (CFS)	DEVELOPED FLOW (CFS)	DEVELOPED WITH DETENTION (CFS)	POND ELEVATION (FT)
2 YR	18.4	24.9	13.9	1130.4
10 YR	35.1	40.7	29.3	1130.7
25 YR	46.7	51.6	40.2	1130.9
100 YR	66.6	70.4	58.2	1131.1

1. NOAA ATLAS 14 RAINFALL DATA WAS USED IN THE HEC-HMS MODEL PER COA DRAINAGE CRITERIA MANUAL.

**HEC HMS RESULTS SUMMARY - ALL<sup>1</sup>**

	BATCH POND (POA #1) AND POA #2			POA #3	
	EXISTING FLOW (CFS)	DEVELOPED FLOW (CFS)	DEVELOPED WITH DETENTION (CFS)	EXISTING FLOW (CFS)	DEVELOPED FLOW (CFS)
2 YR	28.1	37.5	26.5	2.7	2.7
10 YR	53.9	64.0	52.6	5.0	4.6
25 YR	71.9	82.3	70.9	6.6	5.9
100 YR	102.6	113.7	101.5	9.3	8.2

1. NOAA ATLAS 14 RAINFALL DATA WAS USED IN THE HEC-HMS MODEL PER COA DRAINAGE CRITERIA MANUAL.

**IMPERVIOUS COVER NOTES:**

1. THE PRE-1999 IMPERVIOUS COVER EQUALS 14,398-SQFT (0.33-ACRES).
2. TOTAL EXISTING IMPERVIOUS COVER EQUALS 87,886-SQFT (2.018-ACRES).  
A. THE ADDITIONAL 73,488-SQFT (1.688-ACRES) OF EXISTING IMPERVIOUS COVER IS FROM 1999 TO PRESENT AND WAS DEVELOPED ON LAND LESS THAN 5-ACRES. THE I.C. FROM 1999 TO PRESENT WILL BE CONSIDERED 'PROPOSED' ON THE WATER QUALITY CALCULATIONS SHOWN ON SHEET 15.
3. AREA A2 AND B2 ARE AREAS OF FUTURE IMPROVEMENTS WITH AN ASSUMED IMPERVIOUS COVER OF 95,338-SQFT (2.19-ACRES), AND 20,407-SQFT (0.47-ACRES), RESPECTIVELY.

Drainage Area	Area (acres)	Area (sq m)	Impervious Cover (%)	Composite "C"				SCS CN	Sheet Flow Grass			Tc (min)	Sheet Flow Pavement			Tc (min)	Shallow Conc. Flow Grass Lawn			Tc (min)	Shallow Conc. Flow Pavement			Tc (min)	Tc Total (min)	Tc Design (min)	T lag (min)
				2	10	25	100		L (ft)	n	S (%)		L (ft)	n	S (%)		L (ft)	n	S (%)		L (ft)	n	S (%)				
<b>PROPOSED</b>																											
A1*	3.05	0.004770	52%impervious,48%grass fl cond, av slope	0.53	0.60	0.65	0.73	80.00	100	0.30	4.48%	11.02	0	0.02	0.00%	0.00	345	0.30	2.23%	2.39	241	0.02	3.59%	1.04	15.35	15.35	9.208
A2*	2.19	0.003420	100%impervious,0%grass fl cond, av slope	0.75	0.83	0.88	0.97	80.00	0	0.30	0.00%	0.00	100	0.02	2.57%	1.43	0	0.30	0.00%	0.00	508	0.02	2.31%	2.74	4.17	5.00	3.000
A3*	0.97	0.001509	0%impervious,100%grass fl cond, av slope	0.29	0.35	0.39	0.46	80.00	100	0.30	3.00%	13.99	0	0.02	0.00%	0.00	193	0.30	1.12%	1.88	0	0.02	0.00%	0.00	15.87	15.87	9.524
B1**	0.39	0.000609	0%impervious,100%grass fl cond, av slope	0.29	0.35	0.39	0.46	80.00	100	0.30	2.19%	15.87	0	0.02	0.00%	0.00	202	0.30	2.88%	1.23	0	0.02	0.00%	0.00	17.10	17.10	10.258
B2**	2.43	0.003798	19%impervious,81%grass fl cond, av slope	0.38	0.44	0.48	0.56	80.00	100	0.30	4.38%	12.05	0	0.02	0.00%	0.00	446	0.30	3.38%	2.51	0	0.02	0.00%	0.00	14.55	14.55	8.732
B3**	0.54	0.000844	0%impervious,100%grass fl cond, av slope	0.29	0.35	0.39	0.46	80.00	100	0.30	4.07%	12.38	0	0.02	0.00%	0.00	695	0.30	2.95%	4.18	0	0.02	0.00%	0.00	16.66	16.66	9.938
C1*	2.57	0.004009	54%impervious,46%grass fl cond, av slope	0.54	0.61	0.65	0.73	80.00	100	0.30	1.64%	17.81	0	0.02	0.00%	0.00	304	0.30	4.19%	1.53	201	0.02	4.19%	0.81	20.15	20.15	12.991
C2**	1.81	0.002827	15%impervious,85%grass fl cond, av slope	0.36	0.42	0.47	0.54	80.00	100	0.30	4.61%	11.78	0	0.02	0.00%	0.00	289	0.30	5.02%	1.33	0	0.02	0.00%	0.00	13.11	13.11	7.868
C3	1.06	0.001652	34%impervious,66%grass fl cond, av slope	0.45	0.51	0.56	0.63	80.00	100	0.30	1.65%	17.77	0	0.02	0.00%	0.00	242	0.30	5.06%	1.11	0	0.02	0.00%	0.00	18.88	18.88	11.328

\*Drains to Pond (POA #1)  
\*\*A2, B2, C2 Drain to POA #2  
\*\*\*Drains to POA #1  
\*\*\*\*Drains to POA #2  
C3 Drains offsite (POA #3)



**Green Civil Design**  
Engineering & Consulting  
Texas Registered Engineering Firm F-17563  
301 Denali Pass Dr., Suite 3  
Cedar Park, Texas 78613  
(512) 640-0390

ACTON ACADEMY  
ACTON ACADEMY - PHASE 1  
PROPOSED DRAINAGE PLAN



FILE: p:\Projects\1137 - cody roberts\003 - acton academy phase 1\CAD\Sheets\1137-003 - PROPOSED BATCH POND.dwg TAB: 15 PROPOSED BATCH POND PLAN AND SECTION (SHEET 1 OF 2) PLOTTED: 6/30/2023 11:39 AM BY: MIKE BEV

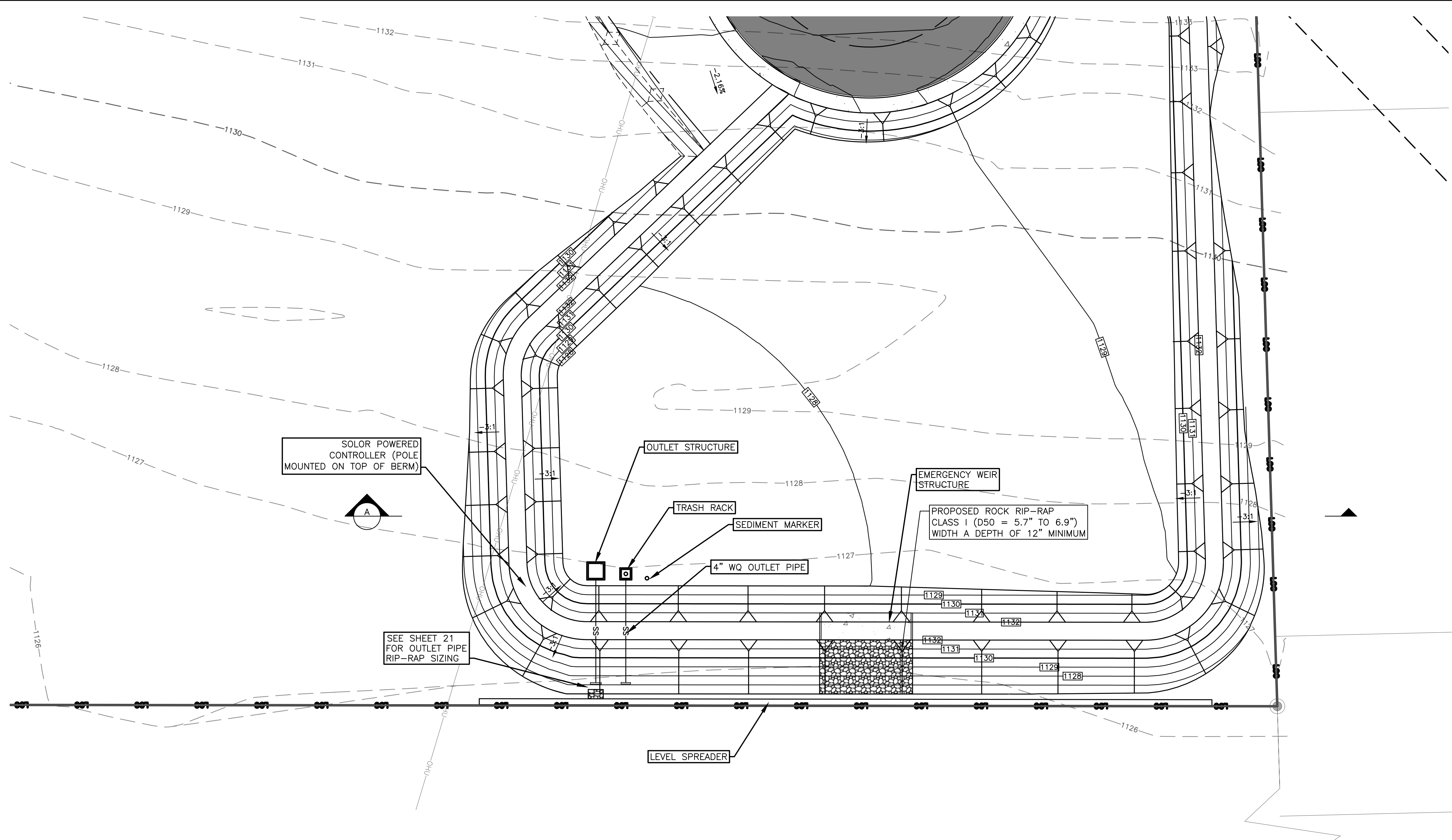

**NOTES:**

- BATCH DETENTION POND SHALL BE IN ACCORDANCE WITH THE TEXAS COMMISSION ON ENVIRONMENTAL QUALITY (TCEQ) RG-348 MANUAL (ADDENDUM)
- SYSTEM SHALL BE 12 VDC WITH SOLAR CHARGED 12 VDC BATTERY. ALTERNATE ELECTRICAL DESIGN MAY ALSO BE UTILIZED IN LIEU OF SOLAR POWER WITH ENGINEERS APPROVAL.
- ACTUATOR SHALL BE ELECTRONIC QUARTER-TURN WITH MANUAL OVERRIDE AND POSITION INDICATOR.
- ACTUATOR SHALL BE "AVID 12V ACTUATOR, EPI-6" OR EQUIVALENT.
- ACTUATOR VALVE TO BE SET AT "NORMALLY CLOSED" POSITION.
- CONTROLLER SHALL BE SET TO OPEN VALVE 12 HOURS AFTER INITIAL RAINFALL DETECTION. VALVE TO REMAIN OPEN UNTIL 2 HOURS FOLLOWING BASIN EMPTY SIGNAL.
- CONTROLLER SHALL HAVE TEST SEQUENCE, ON/OFF/RESET SWITCH AND THE PROGRAMMING SHALL BE FIELD UPLOADABLE.
- CONTROLLER SHALL BE "MORNINGSTAR SOLAR CONTROLLER, 12V, 20 AMP" OR EQUIVALENT.
- ALL WIRING SHALL BE INSTALLED IN CONDUIT AND BURIED. CONTACT ENGINEER FOR ADDITIONAL CONTROLLER SCHEMATICS.
- CONTRACTOR TO INSTALL LIBERTY ALARM MODEL ALM-2W OR EQUIVALENT AND A CONTROLLER PANEL WITH INDICATOR LIGHT AND SIGN POSTED WITH OWNER AND TCEQ CONTACT NUMBERS.

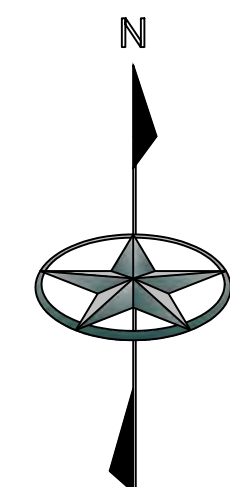

**LEGEND**

- IRON ROD FOUND
- IRON ROD SET
- EXISTING OVERHEAD UTILITY
- EXISTING UTILITY POLE
- EXISTING WIRE FENCE
- PROPERTY LINE
- EXISTING CONTOUR
- PROPOSED FIRE LANE
- FIRE LANE SIGNAGE



**Green**  
**Civil Design**  
 Engineering & Consulting  
 Texas Registered Engineering Firm F-17563  
 301 Denali Pass Dr., Suite 3  
 Cedar Park, Texas 78613  
 (512) 640-0590

ACTON ACADEMY  
 ACTON ACADEMY - PHASE 1  
 PROPOSED BATCH POND PLAN AND SECTION (SHEET 1 OF 2)

TOP OF RISER SHOULD EXTEND TO ELEV. 985.25 AND SHOULD BE FITTED WITH A THREADED REMOVABLE CAP

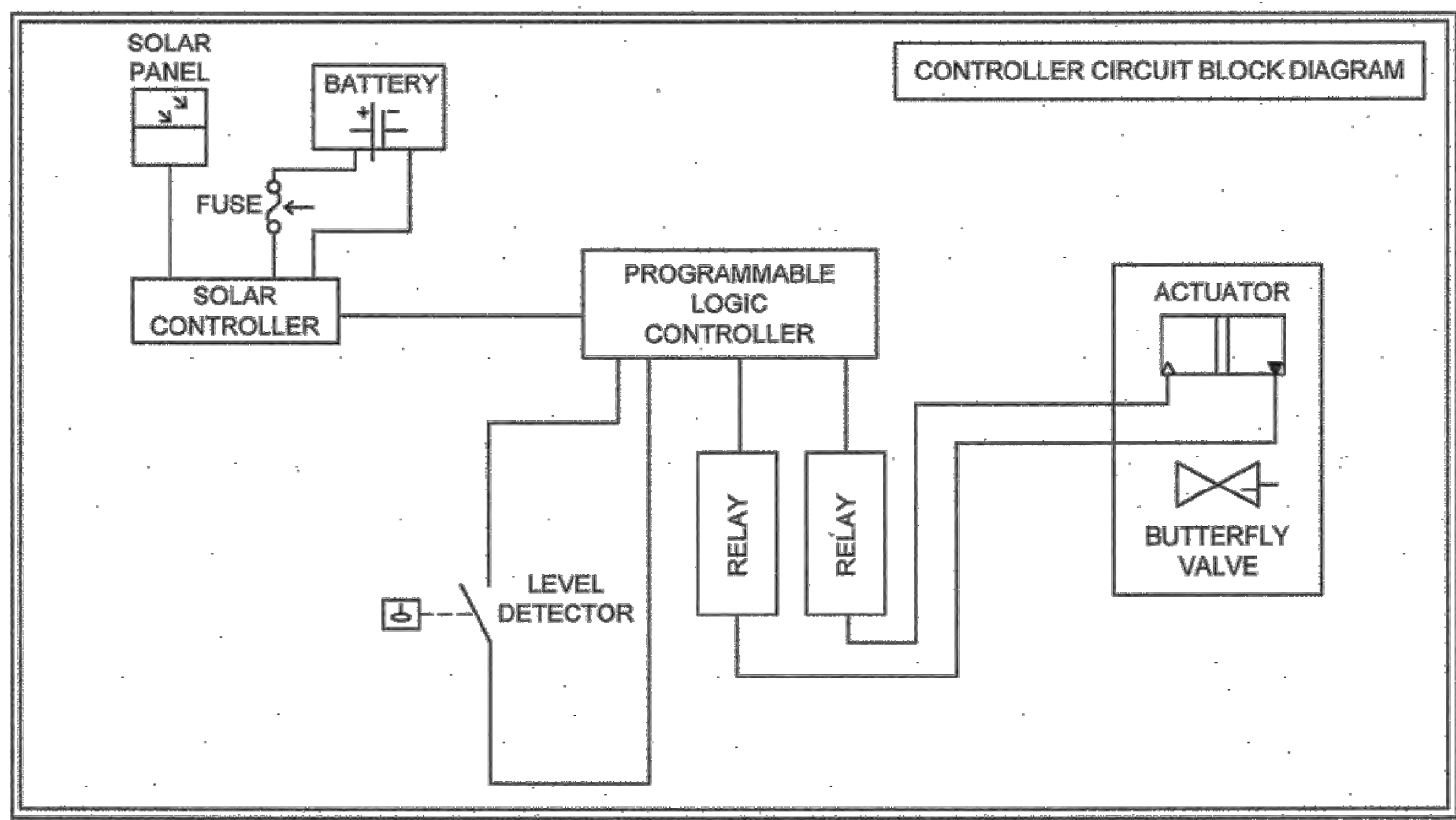
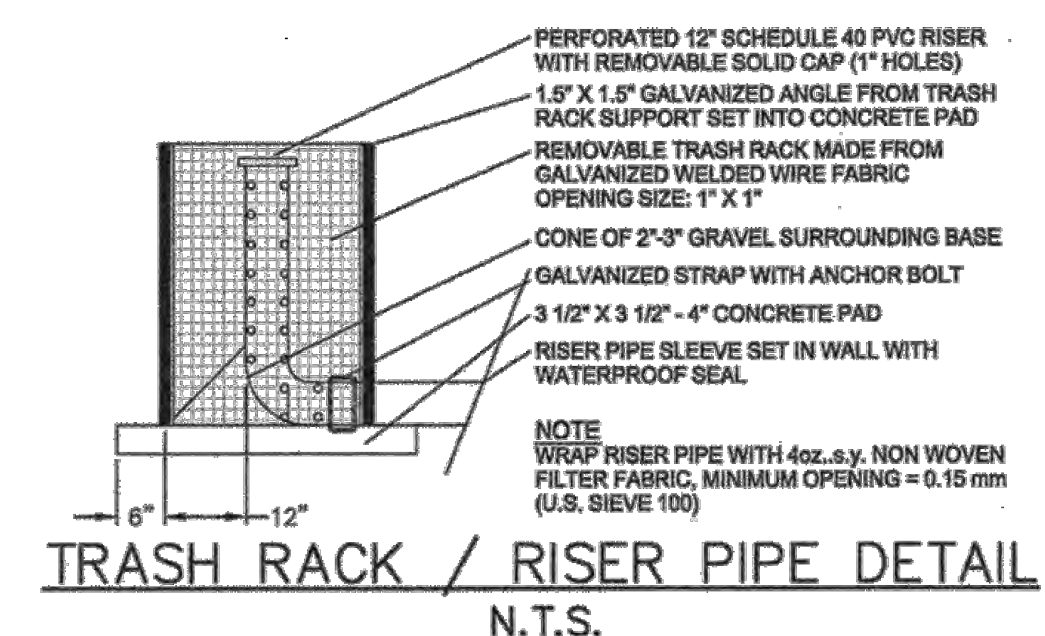
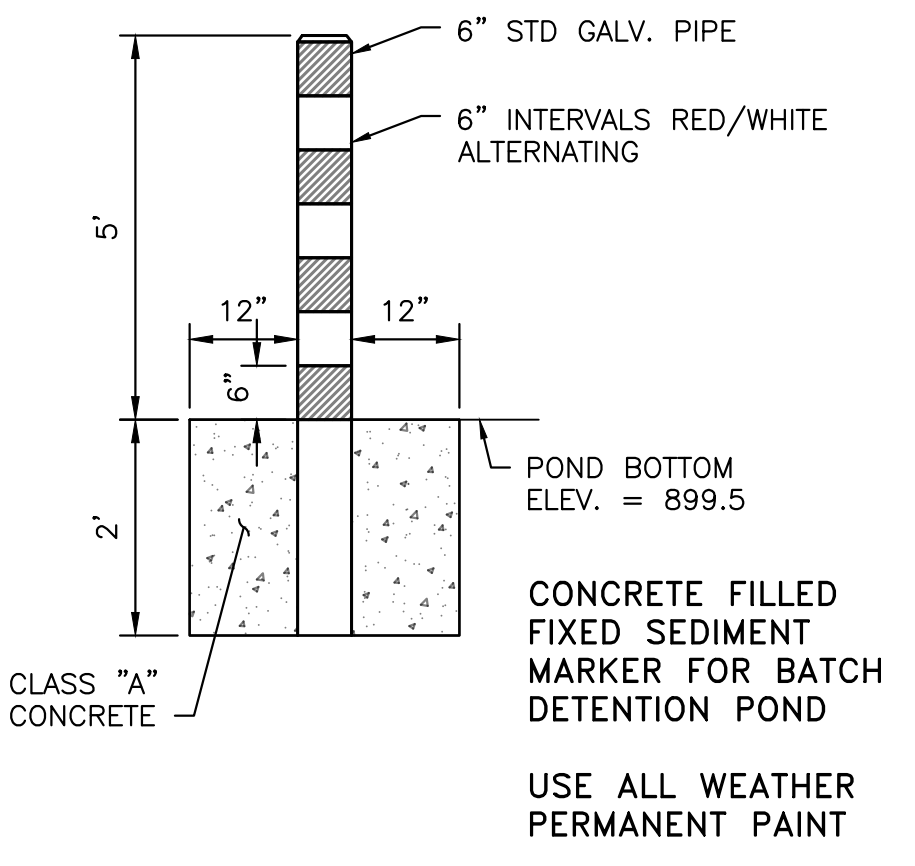
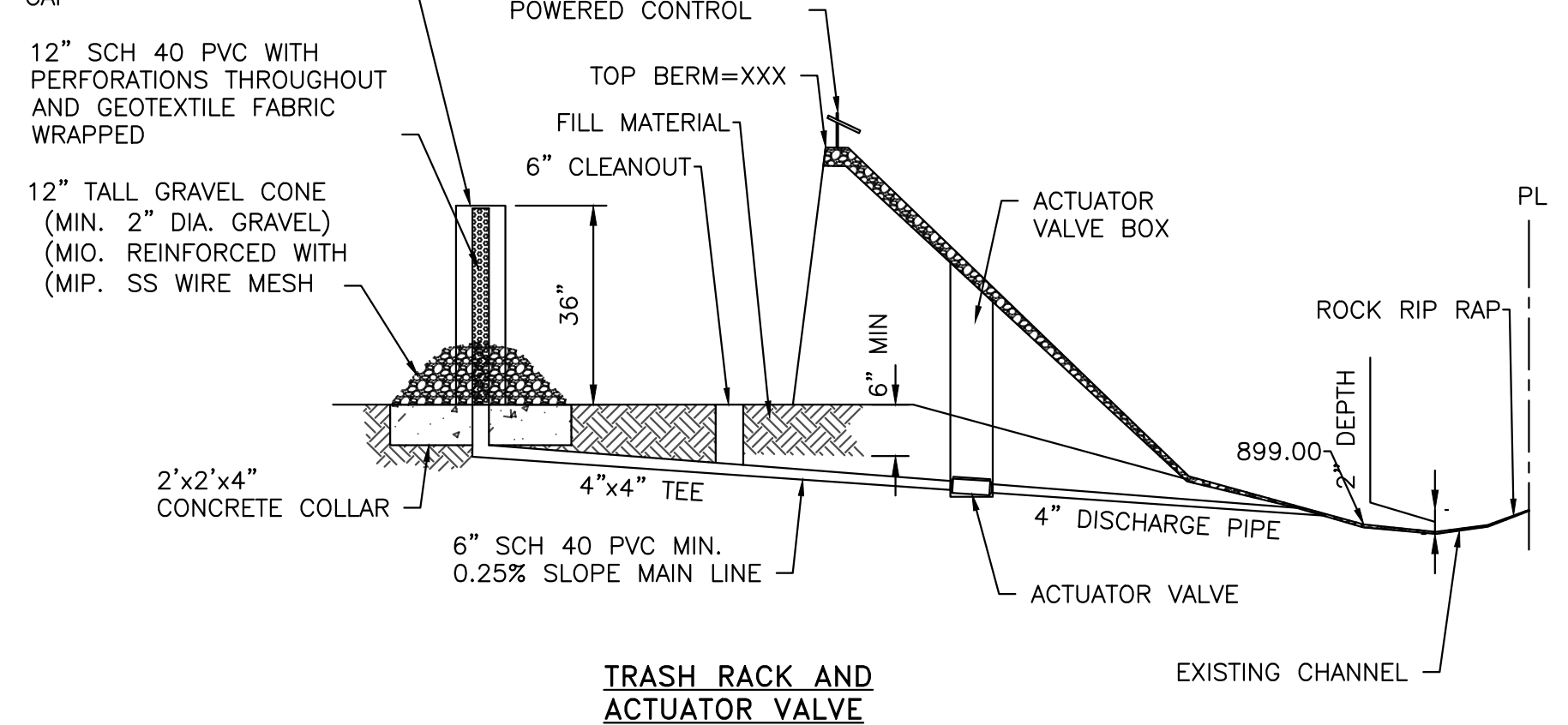



Additional information is provided for cells with a red triangle in the upper right corner. Place the cursor over the cell. Text shown in blue indicate location of instructions in the Technical Guidance Manual - RG-348. Characters shown in red are data entry fields. Characters shown in black (Bold) are calculated fields. Changes to these fields will remove the equations used in the spreadsheet.

**1. The Required Load Reduction for the total project:** Calculations from RG-348 Pages 3-27 to 3-30

Page 3-29 Equation 3.3:  $L_M = 27.2(A_N \times P)$

where:  $L_M$  TOTAL PROJECT = Required TSS removal resulting from the proposed development = 80% of increased load  
 $A_N$  = Net increase in impervious area for the project  
 $P$  = Average annual precipitation, inches

Site Data: Determine Required Load Removal Based on the Entire Project

County =	Hays
Total project area included in plan =	15.00 acres
Predevelopment impervious area within the limits of the plan =	0.330525 acres
Total post-development impervious area within the limits of the plan =	6.268464 acres
Total post-development impervious cover fraction =	0.417898
P =	33 inches
$L_M$ TOTAL PROJECT =	5330 lbs.

\* The values entered in these fields should be for the total project area.

Number of drainage basins / outfalls areas leaving the plan area = 3

Prepared By:  
Green Civil Design, LLC  
Firm - 17563  
301 Denali Pass, Suite #3  
Cedar Park, TX 78613

**2. Drainage Basin Parameters (This information should be provided for each basin):**

Drainage Basin/Outfall Area No. =	1
Total drainage basin/outfall area =	8.77 acres
Predevelopment impervious area within drainage basin/outfall area =	0.330525 acres
Post-development impervious area within drainage basin/outfall area =	5.16 acres
Post-development impervious fraction within drainage basin/outfall area =	0.59
$L_M$ THIS BASIN =	4336 lbs.

**3. Indicate the proposed BMP Code for this basin.**

Proposed BMP =	Batch Detention
Removal efficiency =	91 percent

Aquagolic Cartridge Filter  
Bioretention  
Contech StormFilter  
Constructed Wetland  
Extended Detention  
Grassy Swale  
Retention / Irrigation  
Sand Filter  
Stormceptor  
Vegetated Filter Strips  
Vortechs  
Wet Basin  
Batch Detention

**4. Calculate Maximum TSS Load Removed ( $L_R$ ) for this Drainage Basin by the selected BMP Type.**

RG-348 Page 3-33 Equation 3.7:  $L_R = (BMP \text{ efficiency}) \times P \times (A_i \times 34.6 + A_p \times 0.54)$

where:  $A_C$  = Total On-Site drainage area in the BMP catchment area  
 $A_i$  = Impervious area proposed in the BMP catchment area  
 $A_p$  = Pervious area remaining in the BMP catchment area  
 $L_R$  = TSS Load removed from this catchment area by the proposed BMP

$A_C$ =	8.77 acres
$A_i$ =	5.16 acres
$A_p$ =	3.61 acres
$L_R$ =	5421 lbs.

**5. Calculate Fraction of Annual Runoff to Treat the drainage basin / outfall area**

Desired $L_M$ THIS BASIN =	4954 lbs.
F =	0.91

**6. Calculate Capture Volume required by the BMP Type for this drainage basin / outfall area.** Calculations from RG-348 Pages 3-34 to 3-36

Rainfall Depth =	1.80 inches
Post Development Runoff Coefficient =	0.41
On-site Water Quality Volume =	23615 cubic feet

Calculations from RG-348 Pages 3-36 to 3-37

Off-site area draining to BMP =	0.00 acres
Off-site Impervious cover draining to BMP =	0.00 acres
Impervious fraction of off-site area =	0
Off-site Runoff Coefficient =	0.00
Off-site Water Quality Volume =	0 cubic feet
Storage for Sediment =	4723
Total Capture Volume (required water quality volume(s) x 1.20) =	28338 cubic feet

Prepared By:  
Green Civil Design, LLC  
Firm - 17563  
301 Denali Pass, Suite #3  
Cedar Park, TX 78613

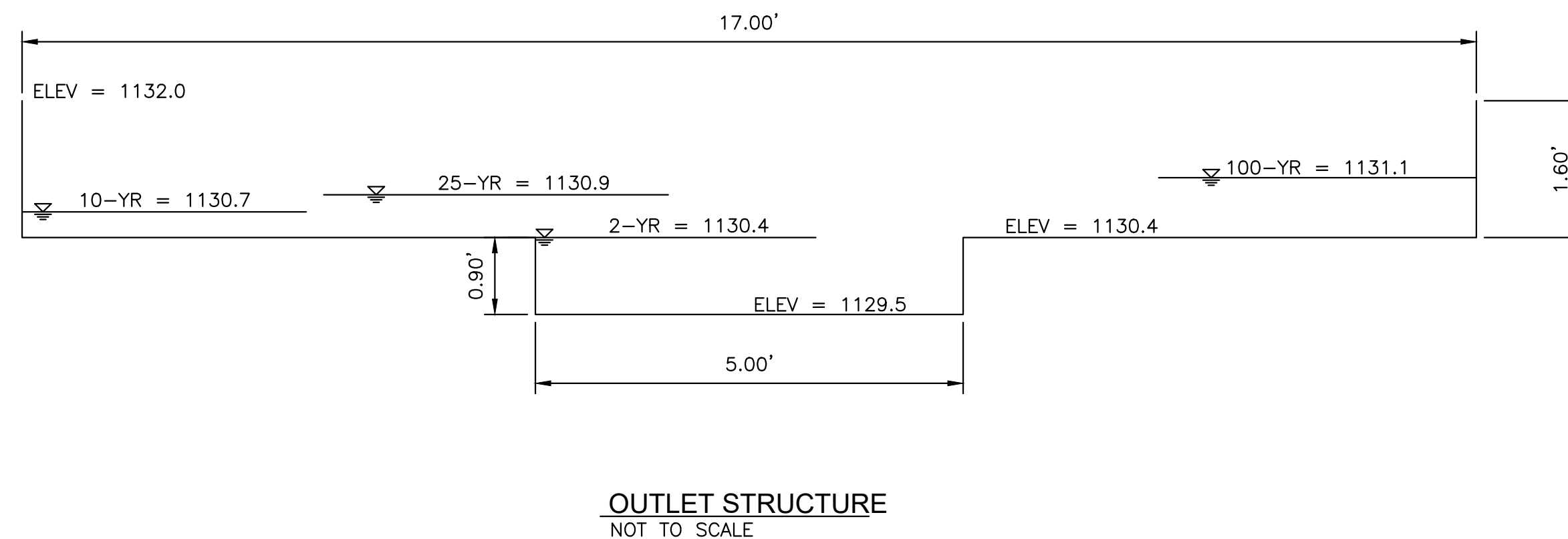

Elevation (ft)	Stage (ft)	Area (ft <sup>2</sup> )	Vol Inc (ft <sup>3</sup> )	Vol Accum (ft <sup>3</sup> )	Vol Accum (ac-ft)
1127.0	0.0	0	0	0	0.00000
1128.0	1.0	8,024	4,012	4,012	0.09210
1129.0	2.0	25,749	16,887	20,898	0.47976
1129.5	2.5	31,042	14,198	35,096	0.80570

Elevation (ft)	Stage (ft)	Area (ft <sup>2</sup> )	Vol Inc (ft <sup>3</sup> )	Vol Accum (ft <sup>3</sup> )	Orifice Discharge (cfs)	Incremental Drawdown (hr)	Total Drawdown
1129.5	2.5	31042	0	0			0
1129.0	2.0	25,749	14,198	14,198	0.61	6.5	6.5
1128.0	1.0	8,024	16,887	31,084	0.49	9.7	16.2
1127.0	0.0	0	4,012	35,096	0.24	4.6	20.8

WQ VOLUME

$Q_{orifice} = CA(2gH)^{0.5}$

where: Q = Orifice Flow (cfs)  
 C = Orifice Coefficient (0.6)  
 A = Orifice Area (ft)  
 g = Grav. Constant (32.2 ft/s<sup>2</sup>)  
 H = Head on orifice (ft)

Diameter = 4 in  
 FL Elev = 1127  
 CL Elev = 1127.17  
 Area = 0.09 sf

Total Drawdown Time = 20.8 hours  
 Total Hold + Drawdown Time = 32.8 hours

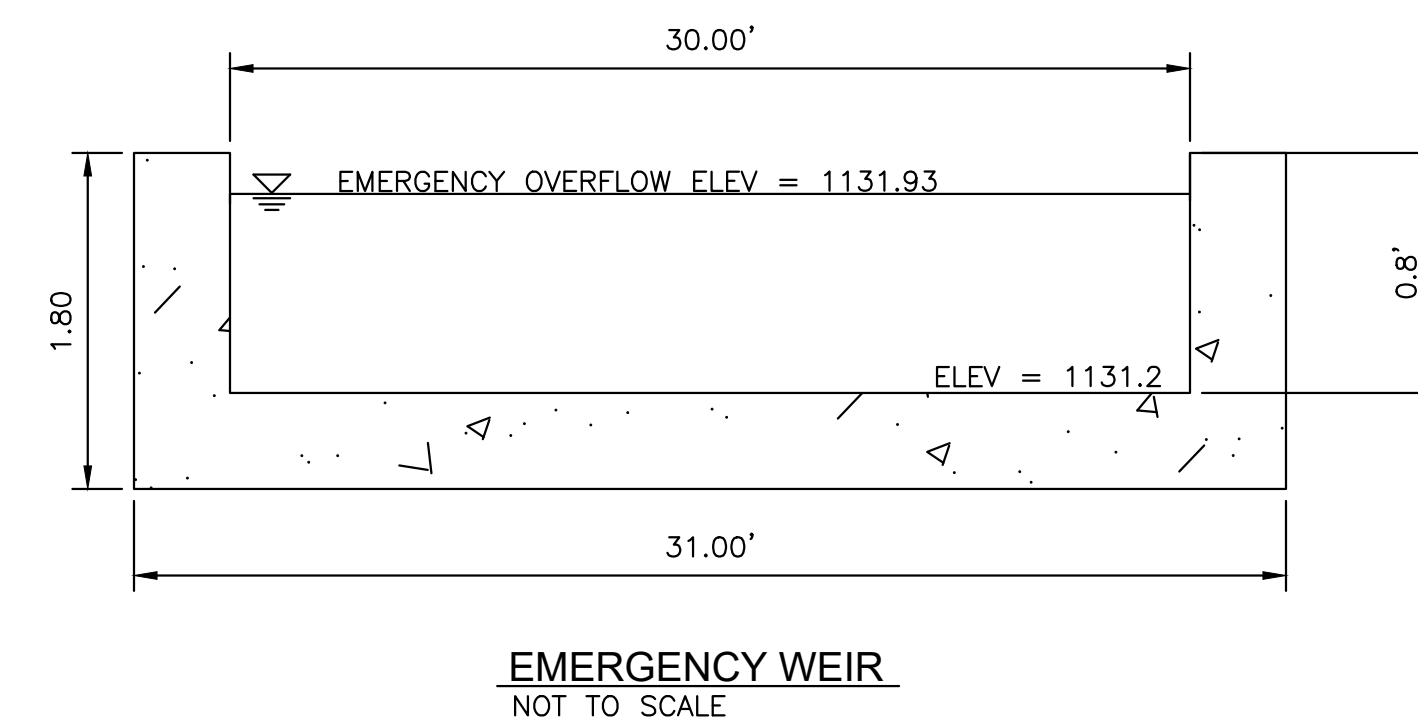

**HEC HMS RESULTS SUMMARY BATCH POND/POA #1**

	EXISTING FLOW (CFS)	DEVELOPED FLOW (CFS)	DEVELOPED WITH DETENTION (CFS)	POND ELEVATION (FT)
2 YR	18.4	24.9	13.9	1130.4
10 YR	35.1	40.7	29.3	1130.7
25 YR	46.7	51.6	40.2	1130.9
100 YR	66.6	70.4	58.2	1131.1

1. NOAA ATLAS 14 RAINFALL DATA WAS USED IN THE HEC-HMS MODEL PER COA DRAINAGE CRITERIA MANUAL.

**HEC HMS RESULTS SUMMARY - ALL<sup>1</sup>**

	BATCH POND (POA #1) AND POA #2			POA #3	
	EXISTING FLOW (CFS)	DEVELOPED FLOW (CFS)	DEVELOPED WITH DETENTION (CFS)	EXISTING FLOW (CFS)	DEVELOPED FLOW (CFS)
2 YR	28.1	37.5	26.5	2.7	2.7
10 YR	53.9	64.0	52.6	5.0	4.6
25 YR	71.9	82.3	70.9	6.6	5.9
100 YR	102.6	113.7	101.5	9.3	8.2

1. NOAA ATLAS 14 RAINFALL DATA WAS USED IN THE HEC-HMS MODEL PER COA DRAINAGE CRITERIA MANUAL.

**SECTION A**

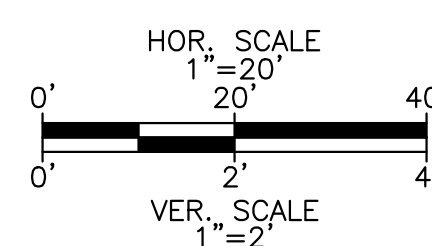
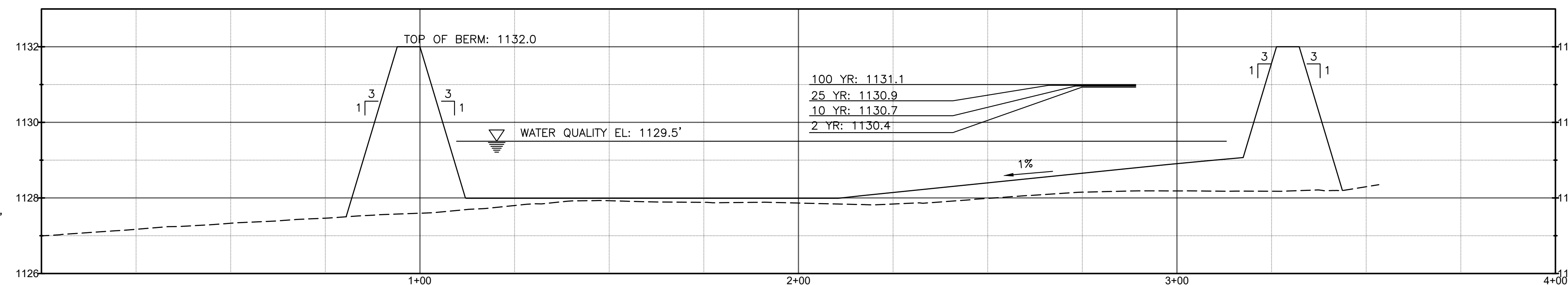

FILE: p:\Projects\1137 - cody roberts\003 - acton academy phase 1\CAD\Sheets\1137-003 - PROPOSED BATCH POND PLAN AND SECTION (SHEET 1 OF 2) TAB: 16 PROPOSED BATCH POND PLAN AND SECTION (SHEET 1 OF 2) PLOTTED: 6/30/2023 11:39 AM BY: MIKE BEV

NO.	DESCRIPTION	APP	DATE

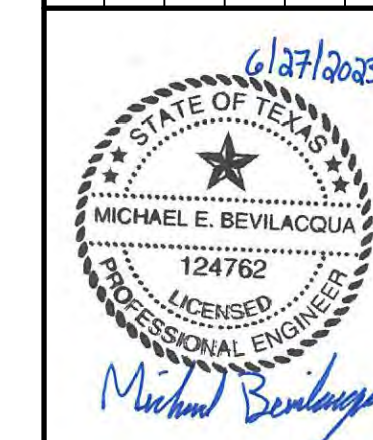

301 Denali Pass Dr., Suite 3  
Cedar Park, Texas 78613  
(512) 640-0390

**Green Civil Design**  
Engineering & Consulting

Texas Registered Engineering Firm F-17563



FILE: p:\Projects\1137 - cody roberts\003 - acton academy phase 1\CAD\Sheets\1137-003 - STANDARD DETAILS.dwg TAB: 17 STANDARD DETAILS (1 OF 2) PLOTTED: 6/30/2023 11:40 AM BY: MIKE BEV

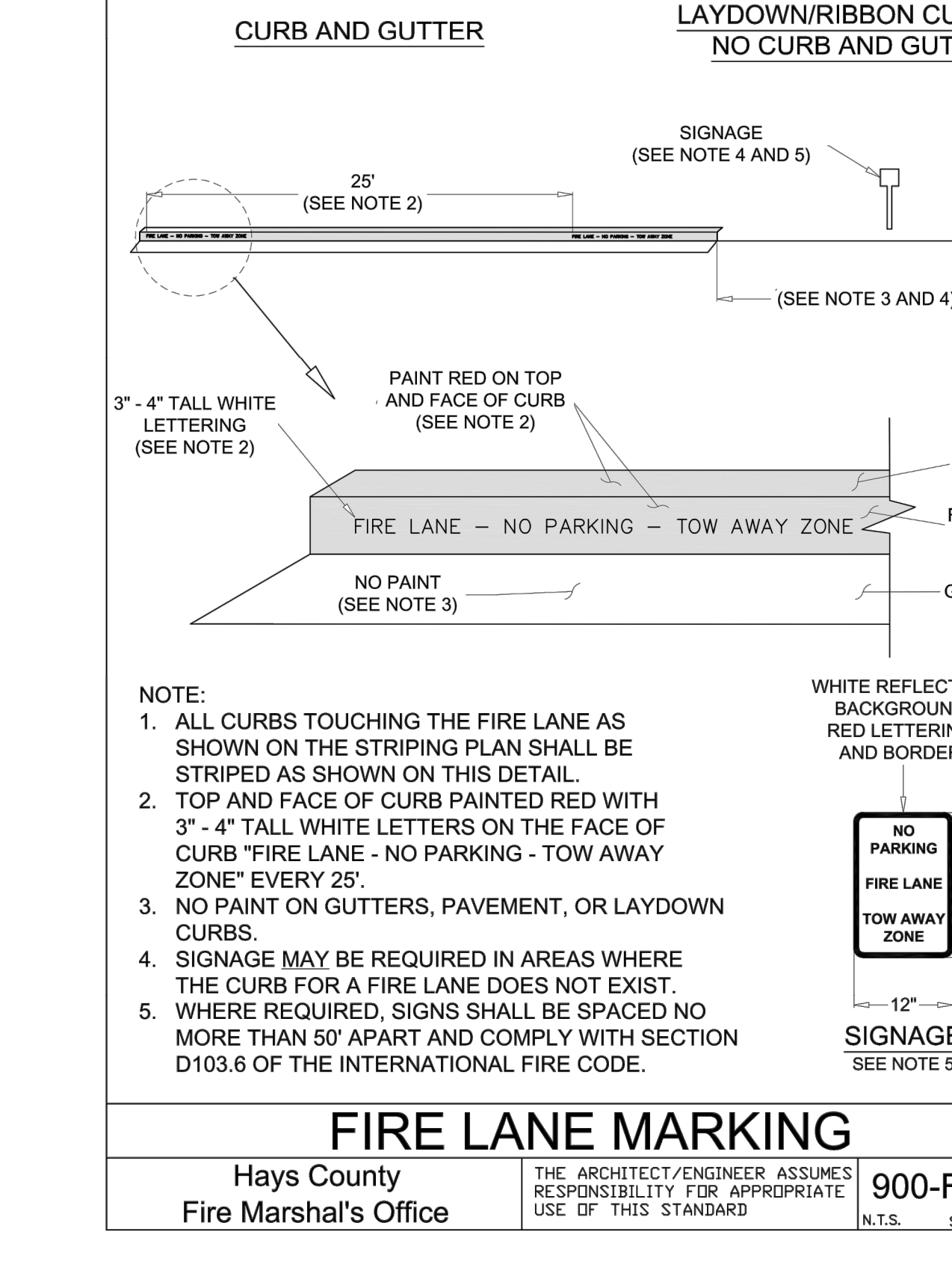
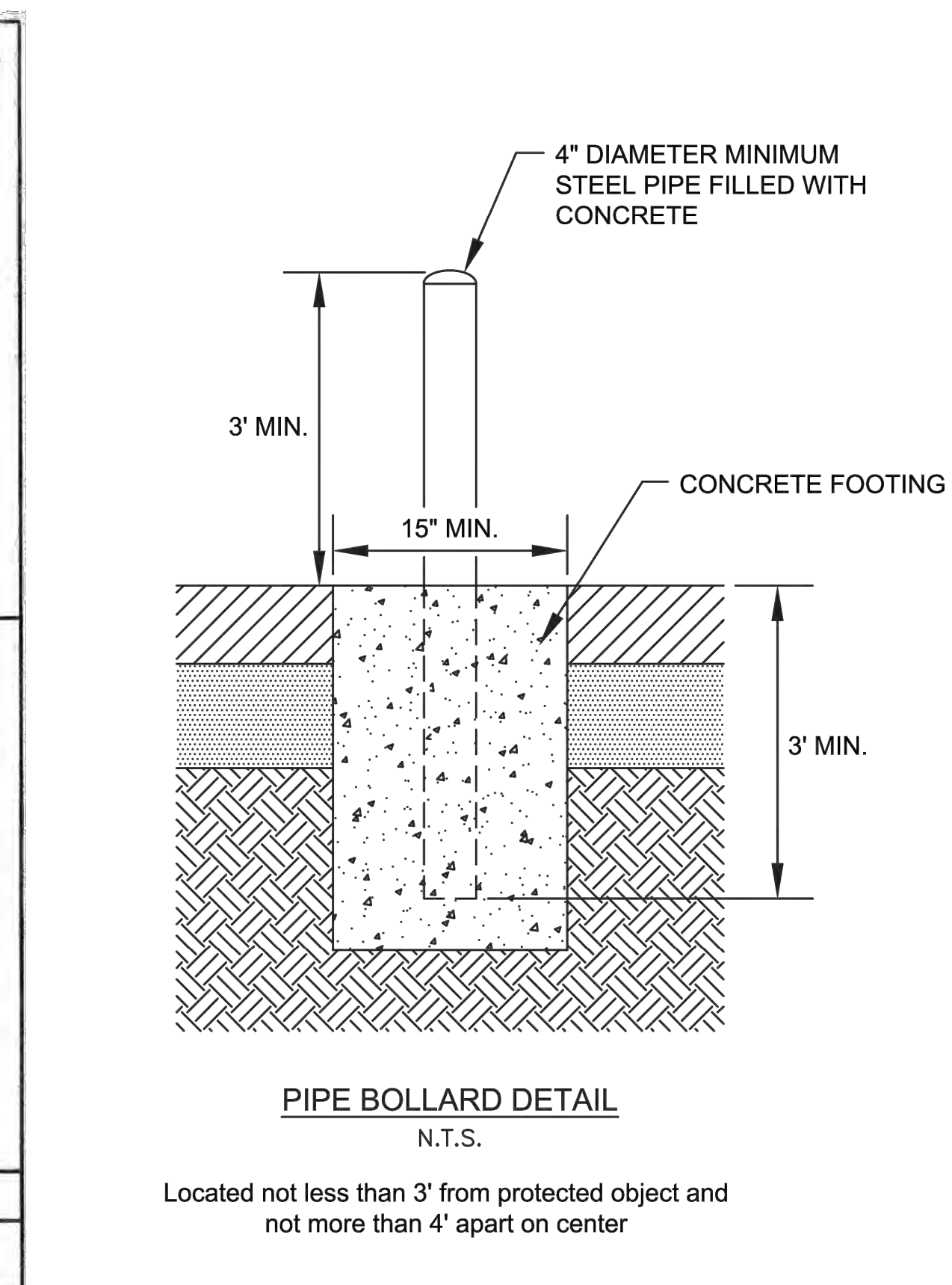
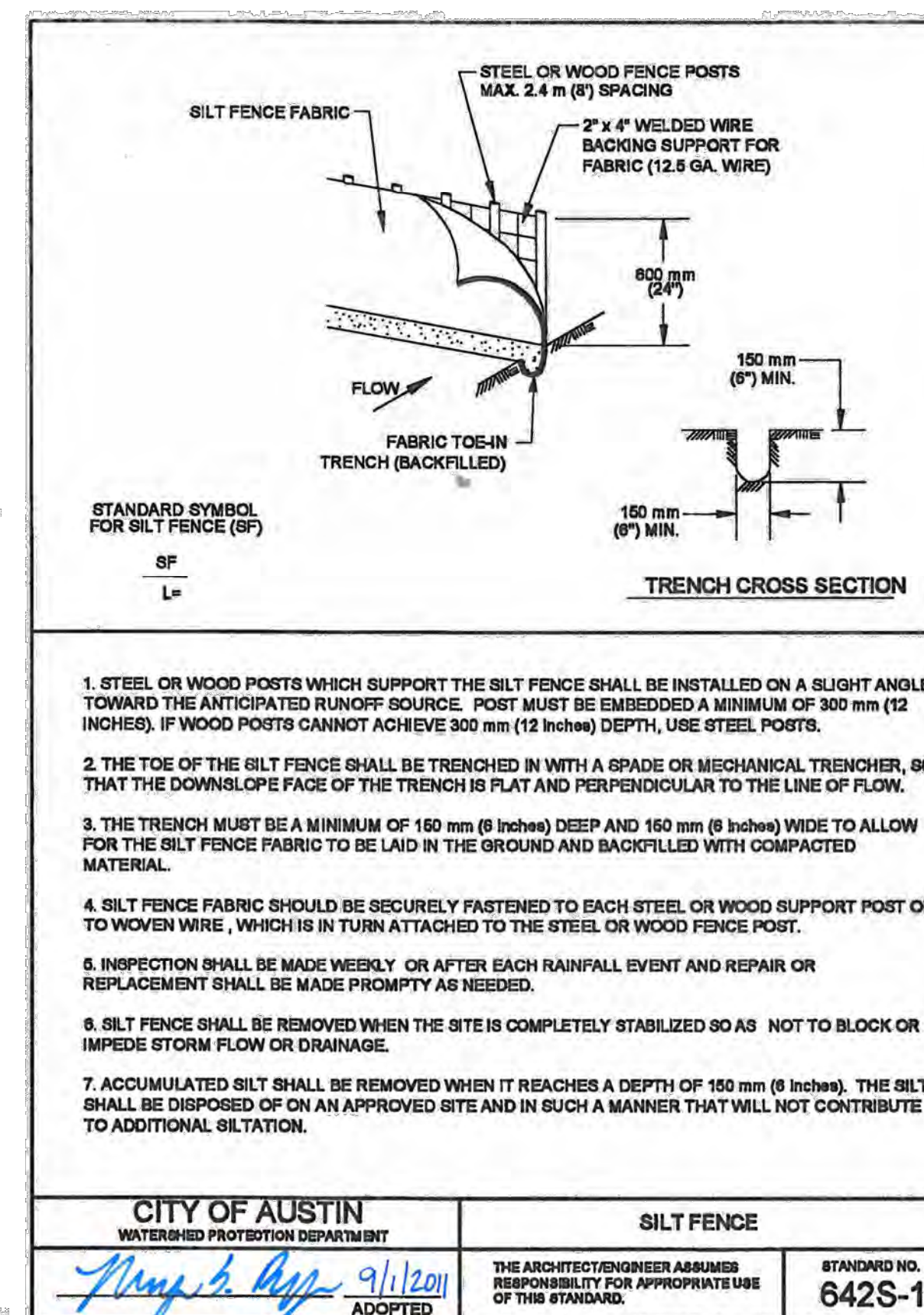
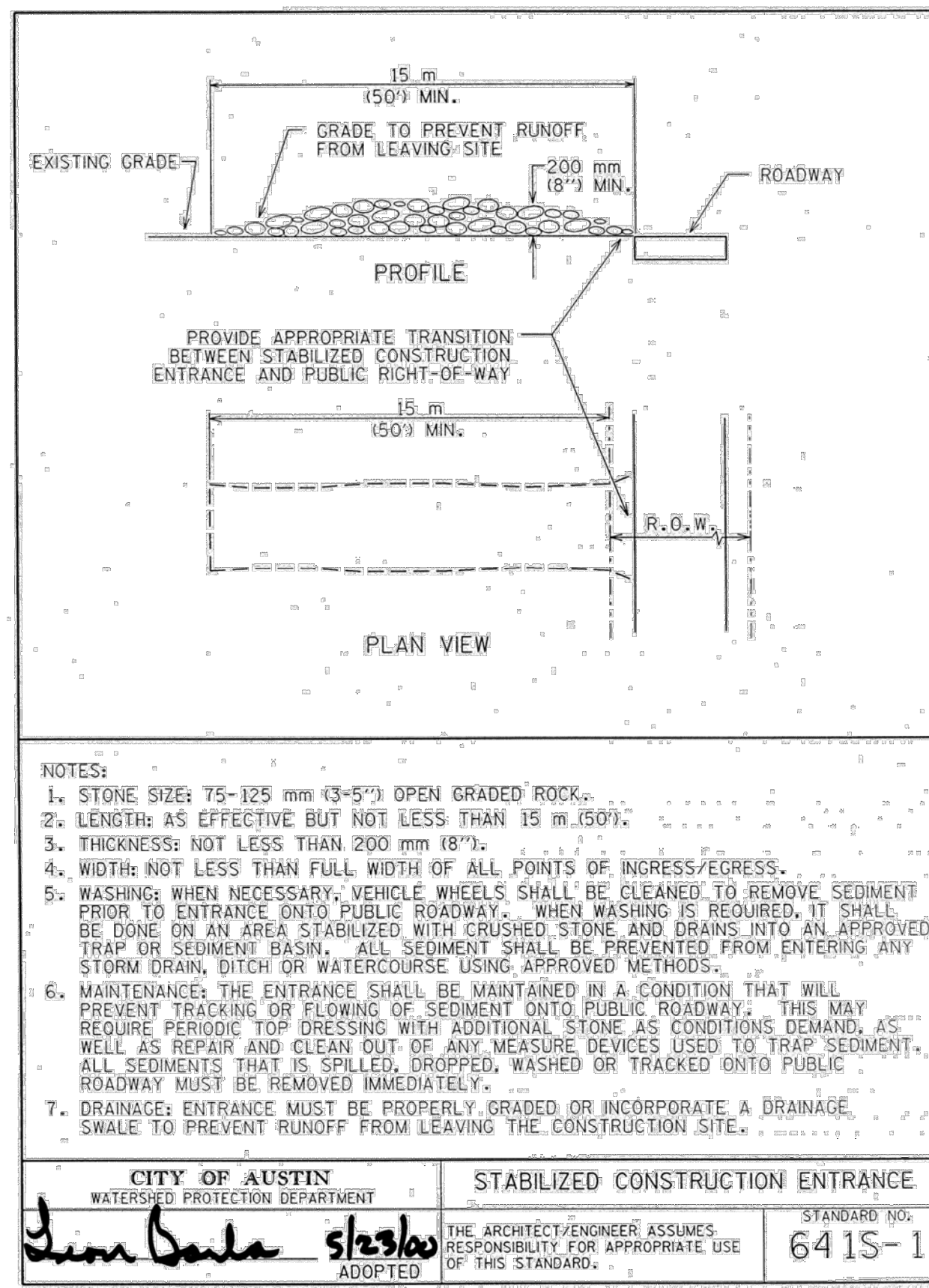
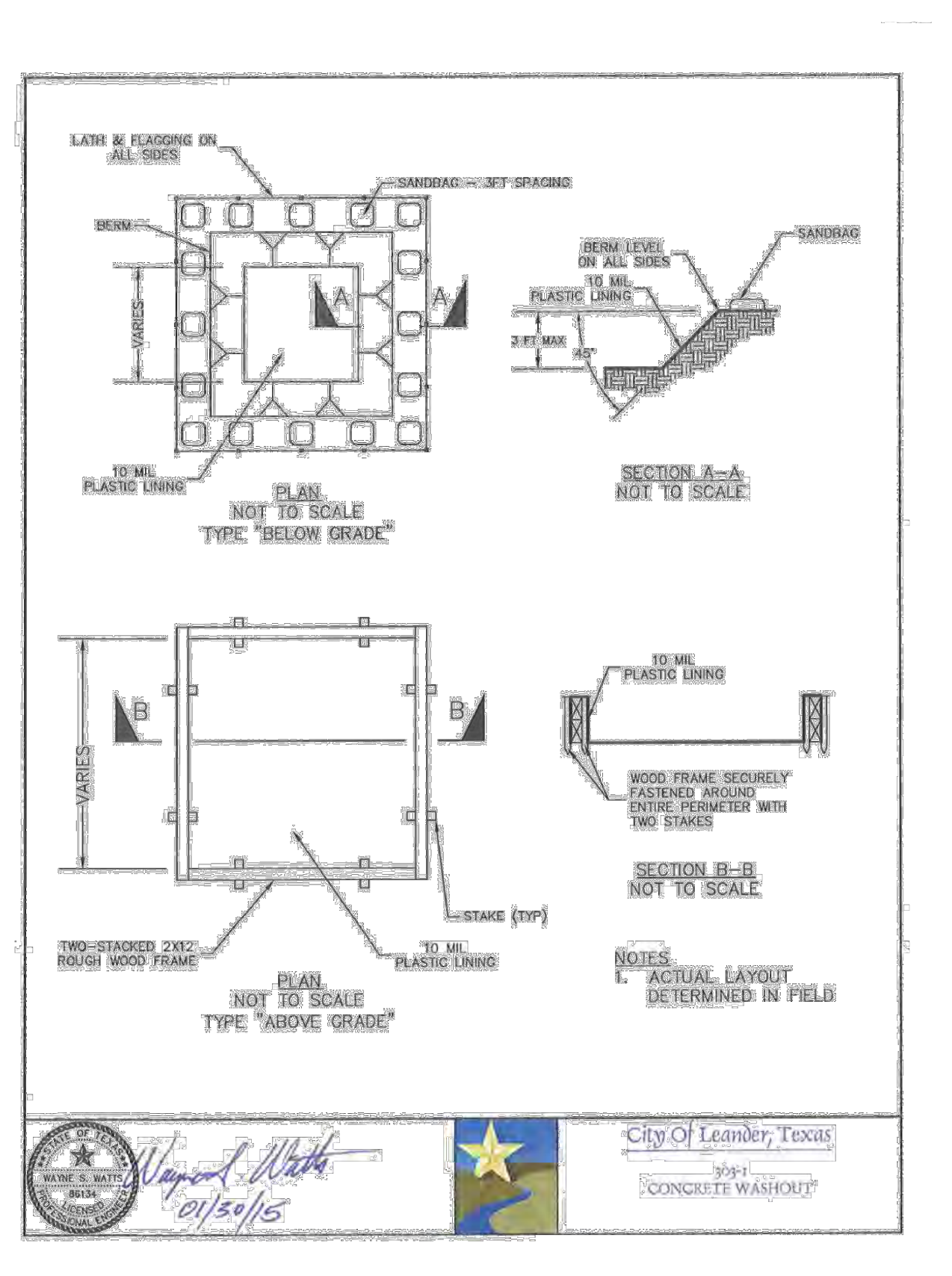
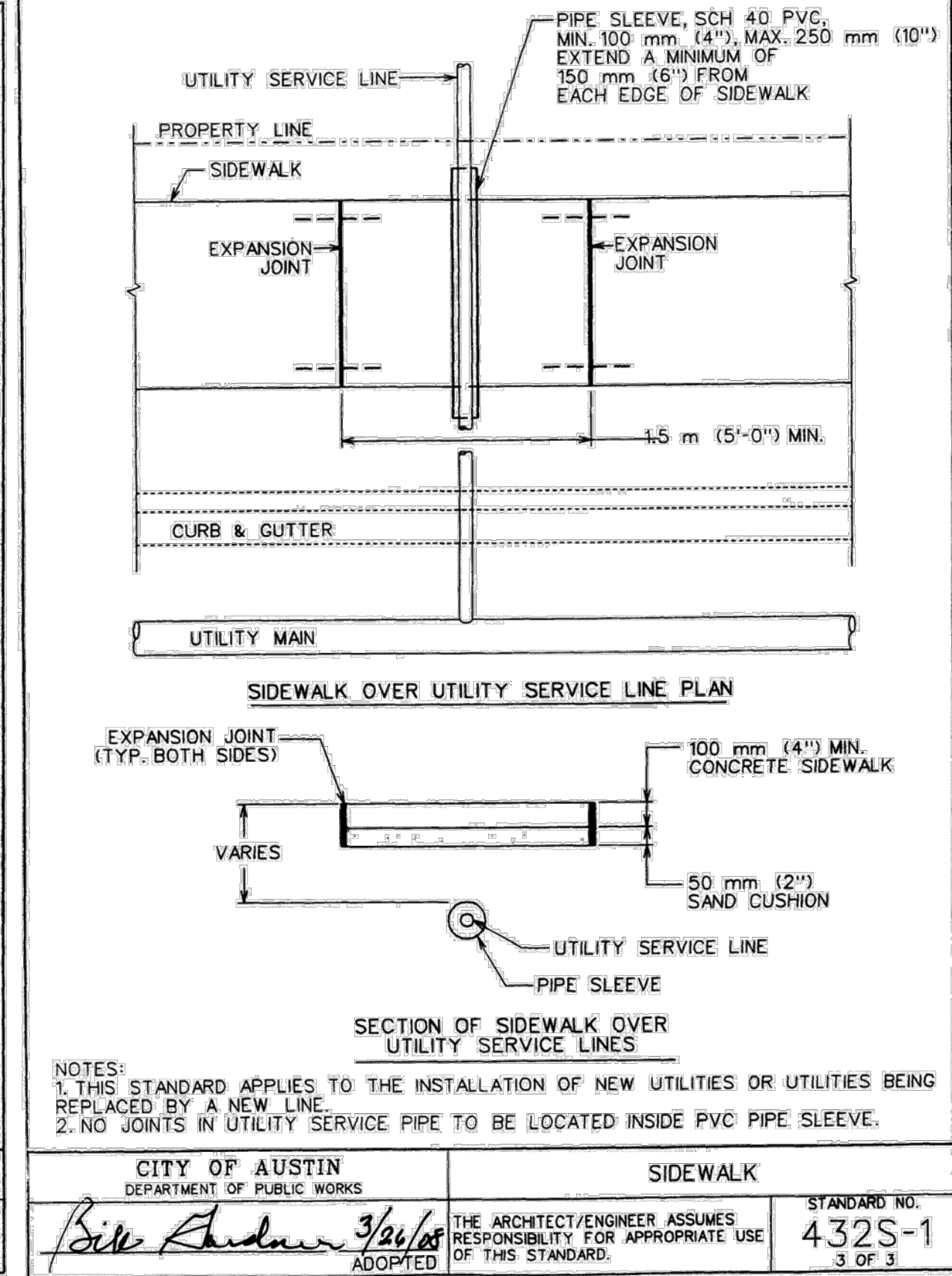
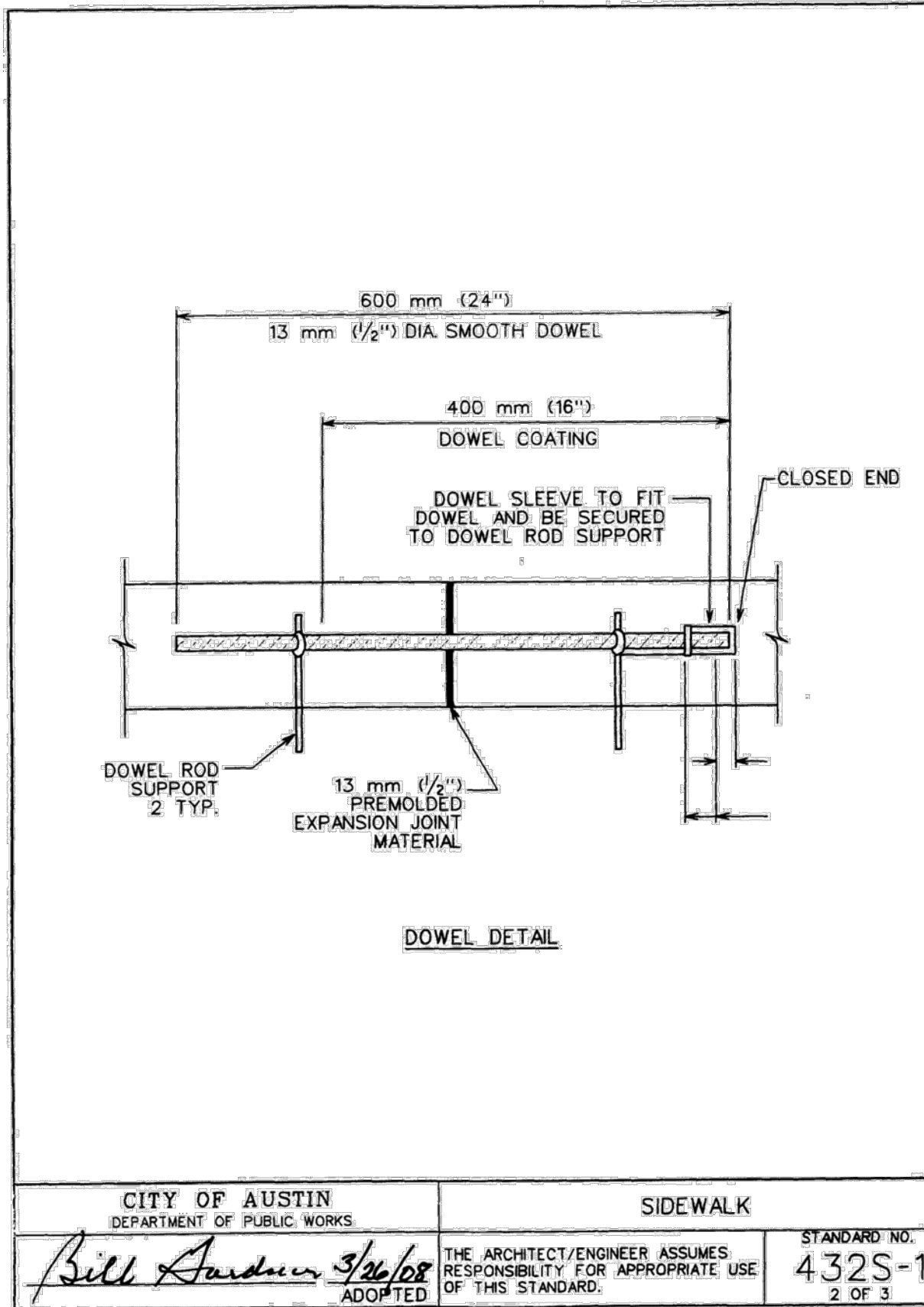
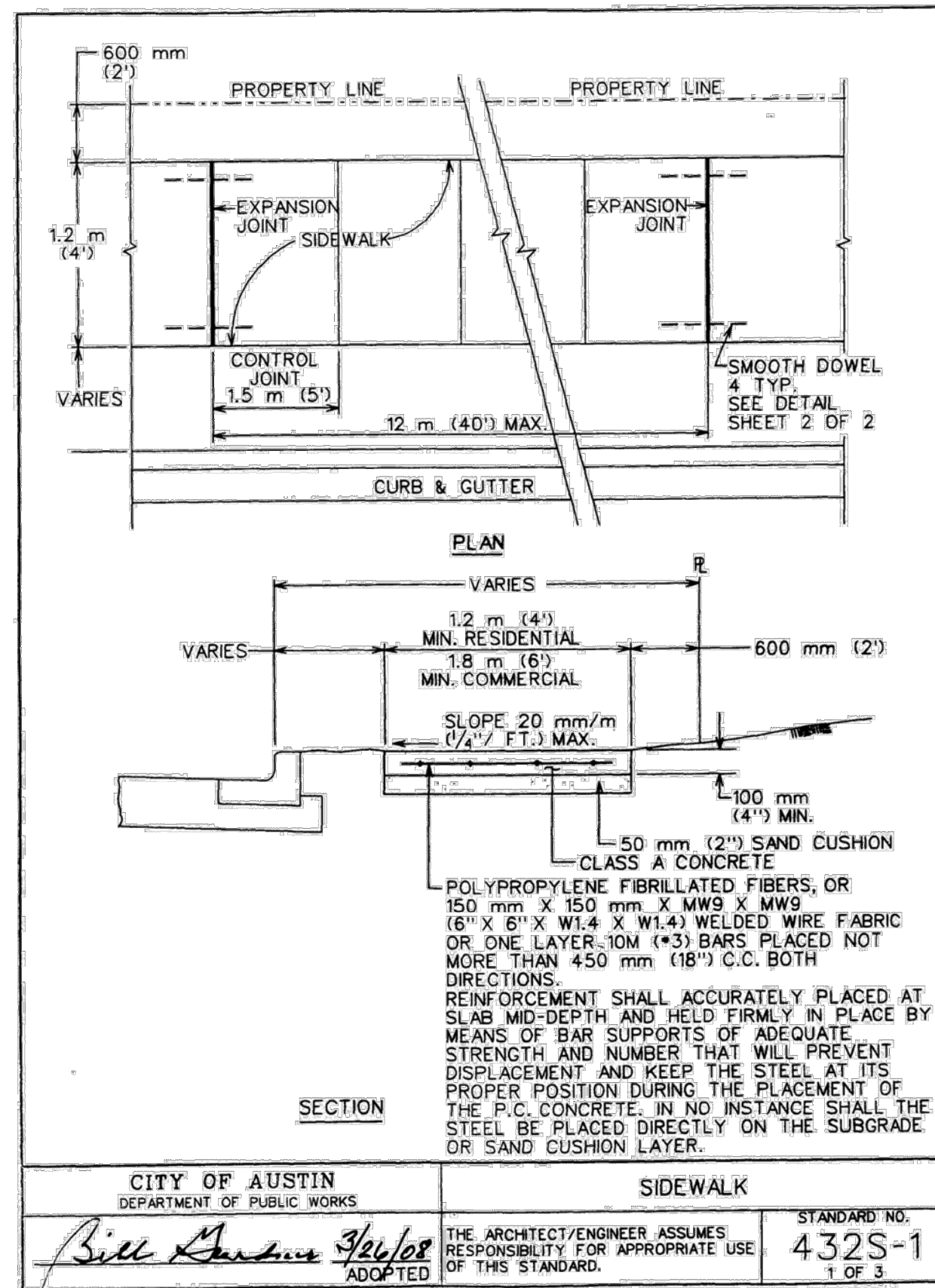

 <b>Green Civil Design</b> Engineering & Consulting Texas Registered Engineering Firm F-17563	ACTON ACADEMY ACTON ACADEMY - PHASE 1 STANDARD DETAILS (1 OF 2)
301 Denali Pass Dr., Suite 3 Cedar Park, Texas 78613 (512) 640-0590	SHEET <b>17</b> OF 18



FILE: p:\Projects\1137 - coby roberts\003 - acton academy phase 1\CAD\Sheets\1137-003 - STANDARD DETAILS.dwg TAB: 18 STANDARD DETAILS (2 OF 2) PLOTTED: 6/30/2023 11:40 AM BY: MIKE BEV

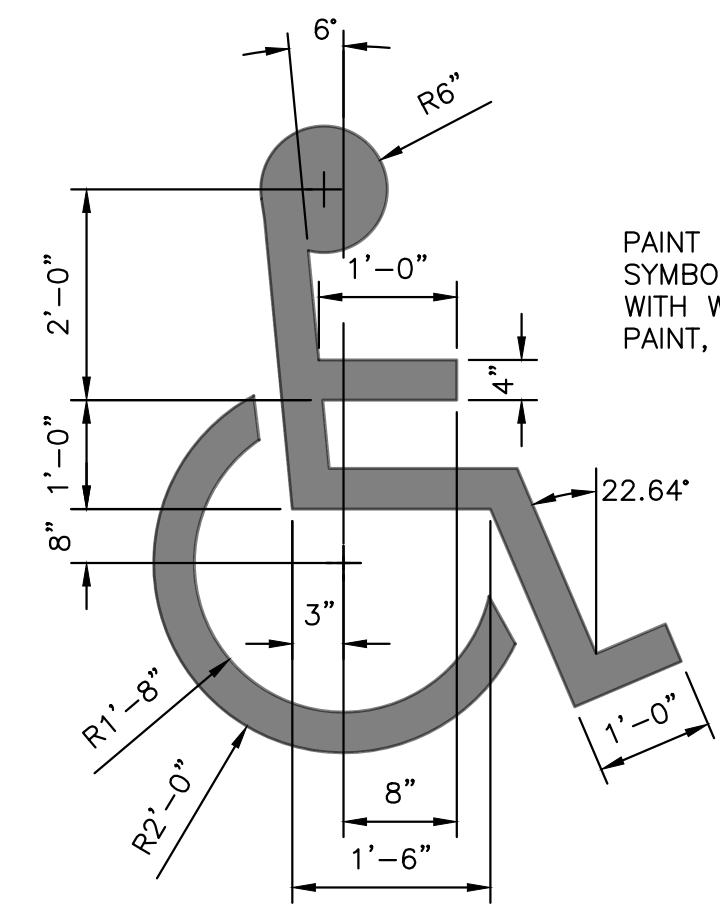
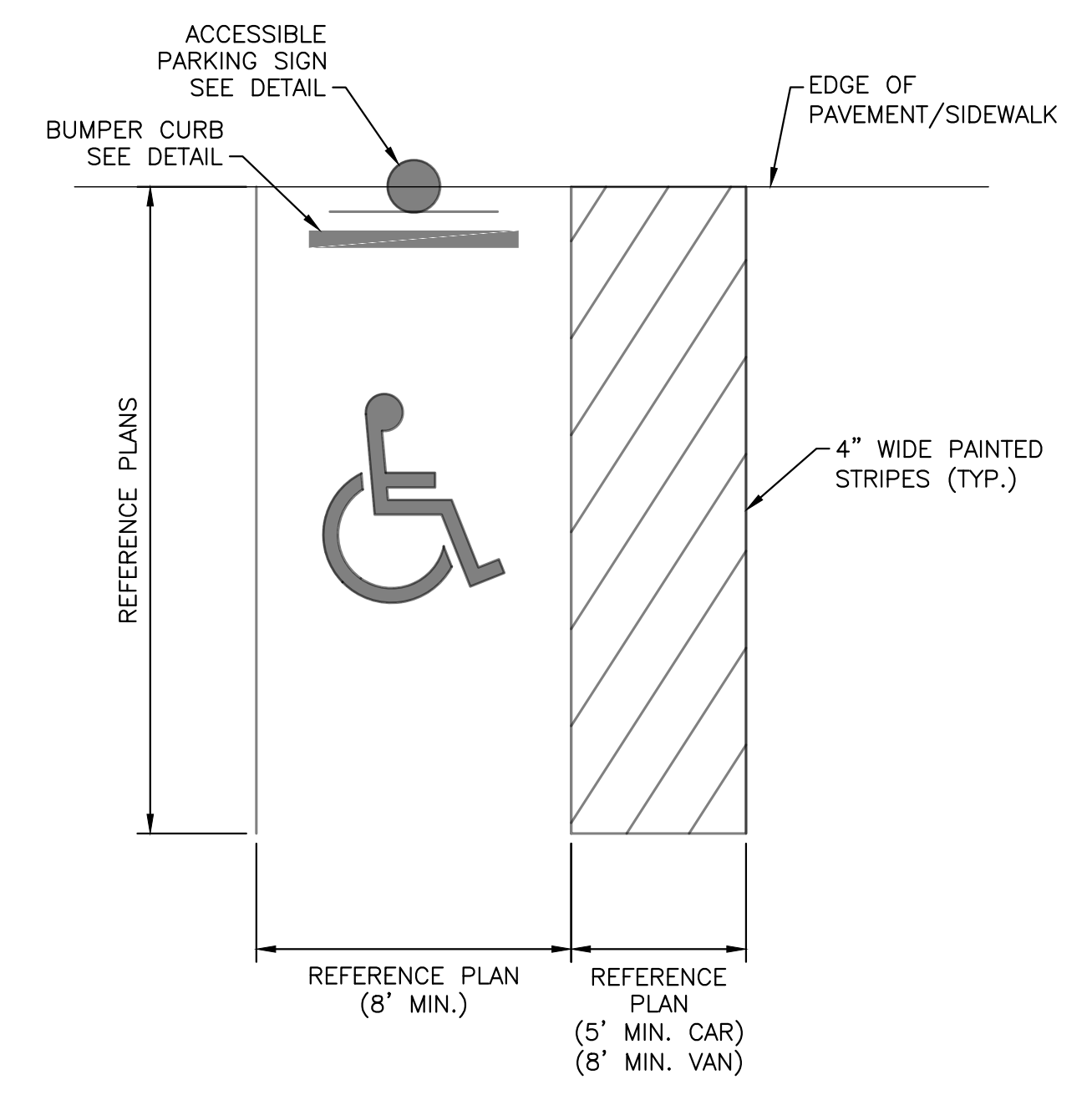
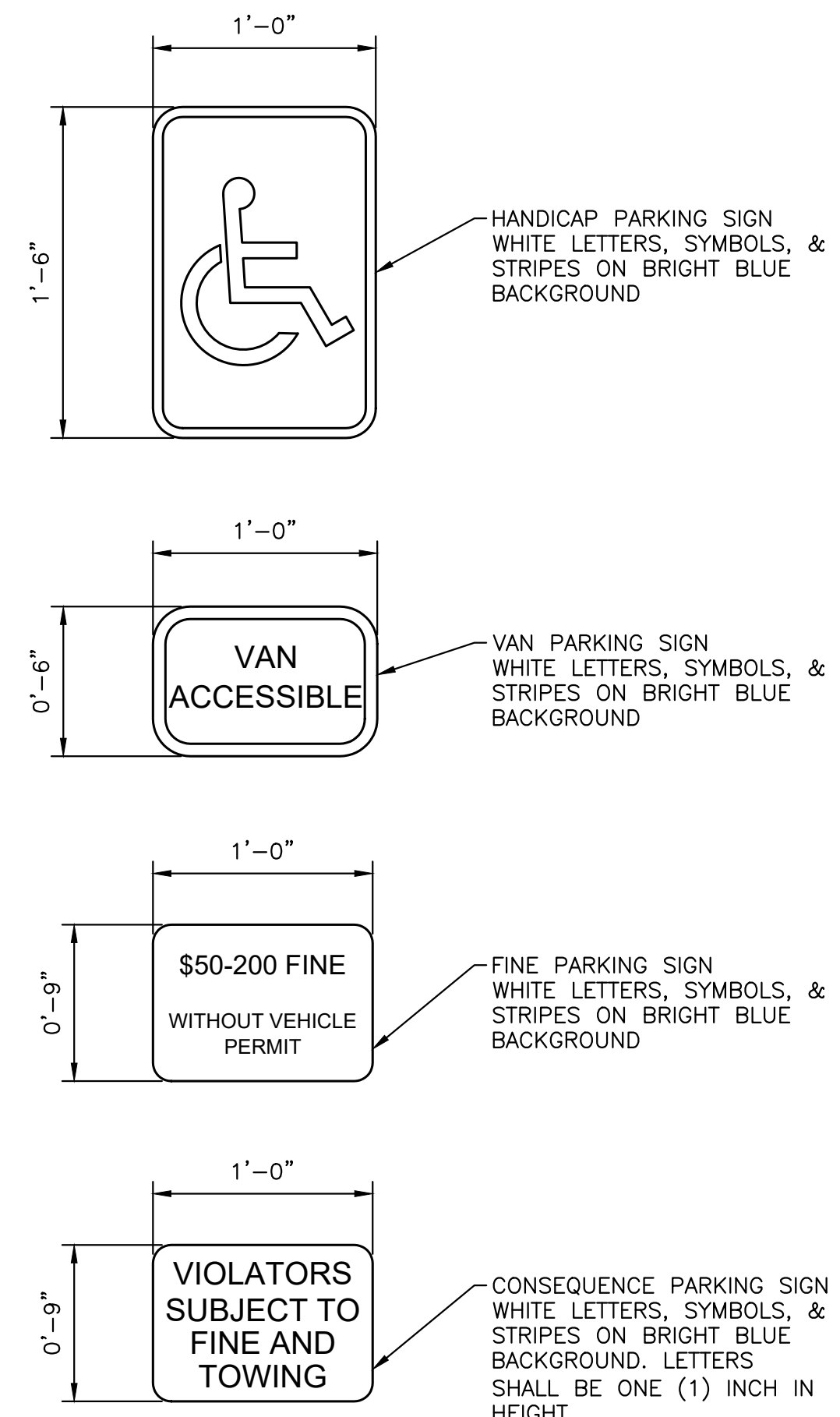
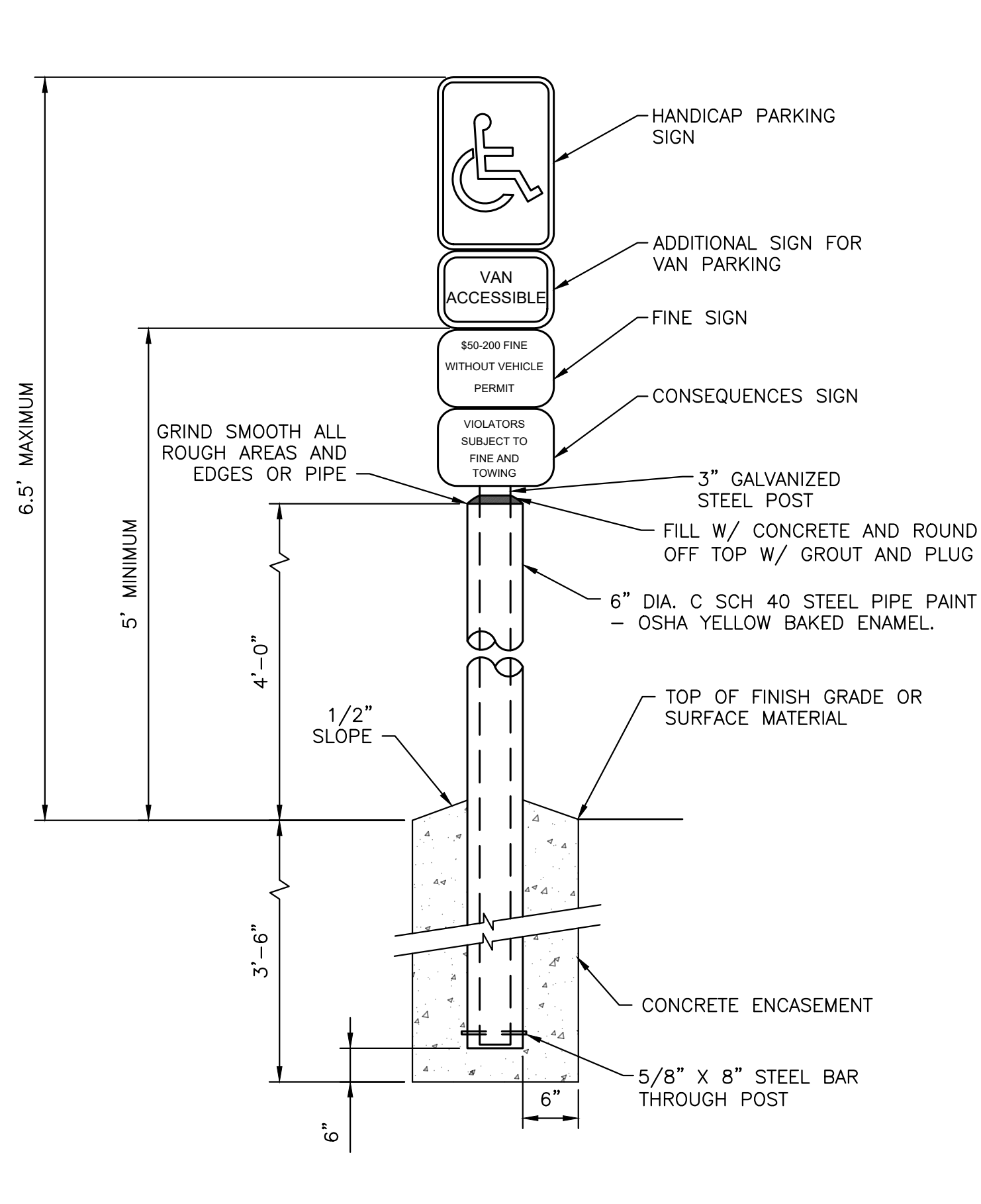

**A** HANDICAP SIGN DETAIL  
N.T.S.

**B** HANDICAP STRIPING DETAIL  
N.T.S.

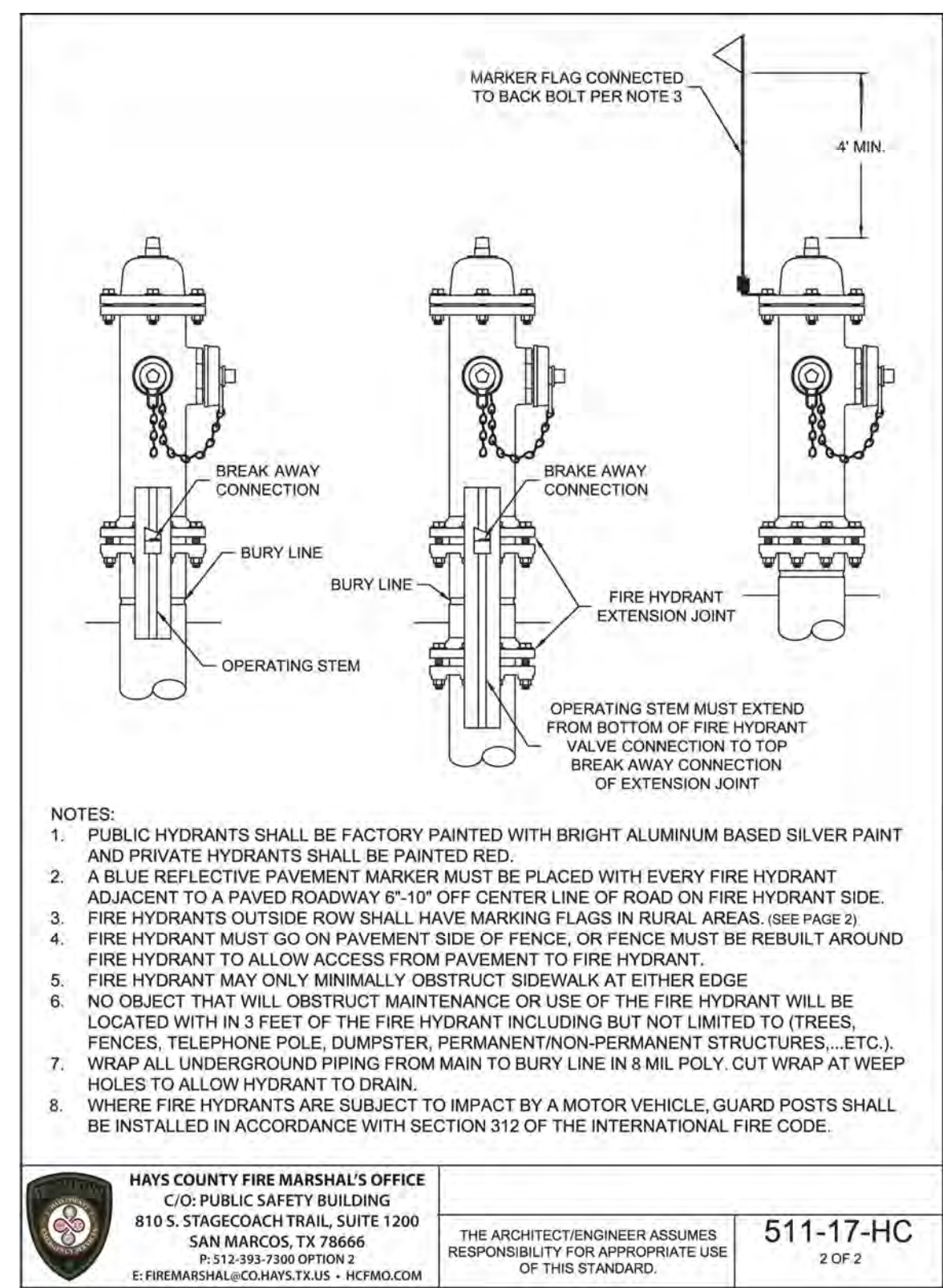
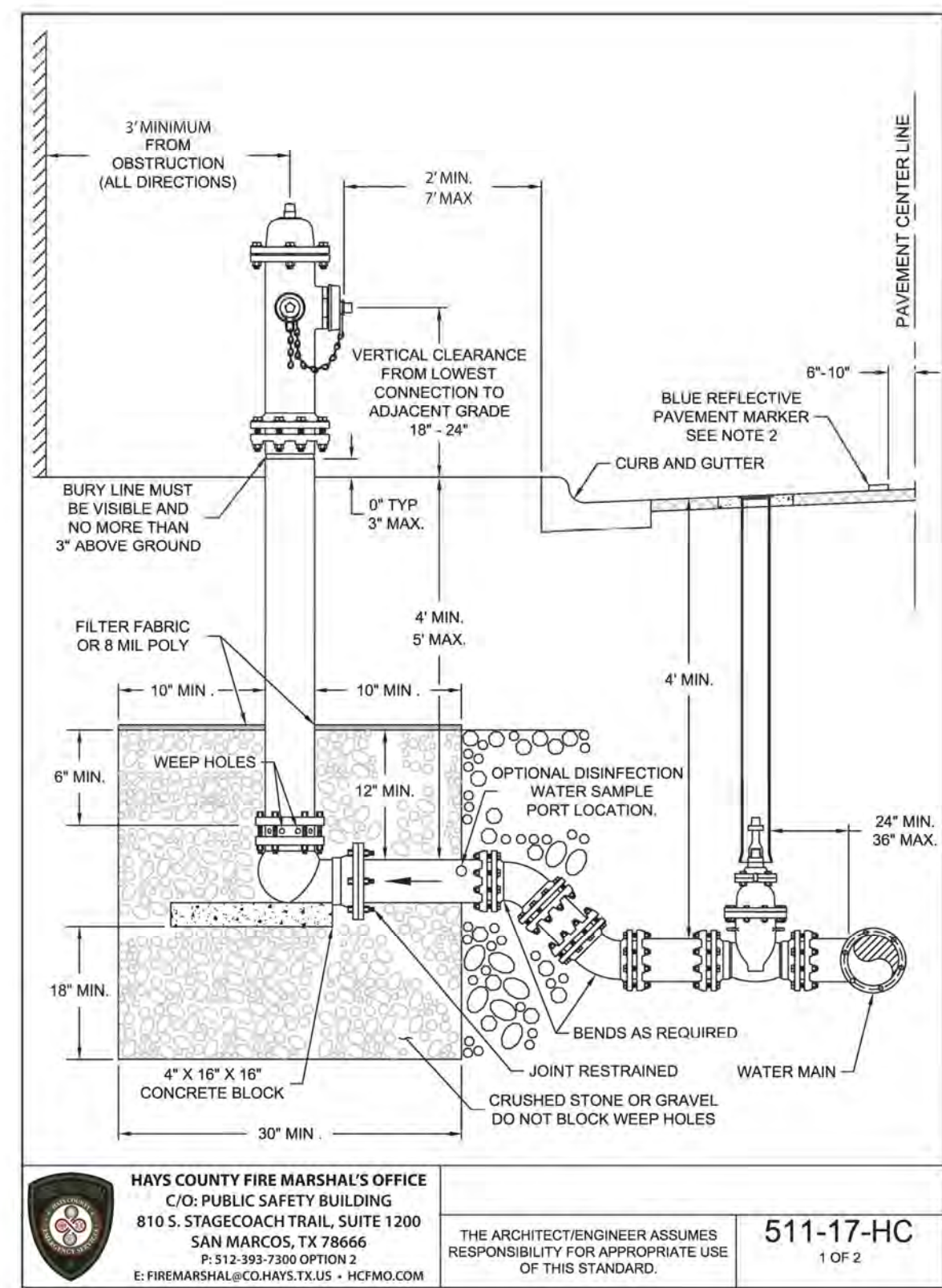
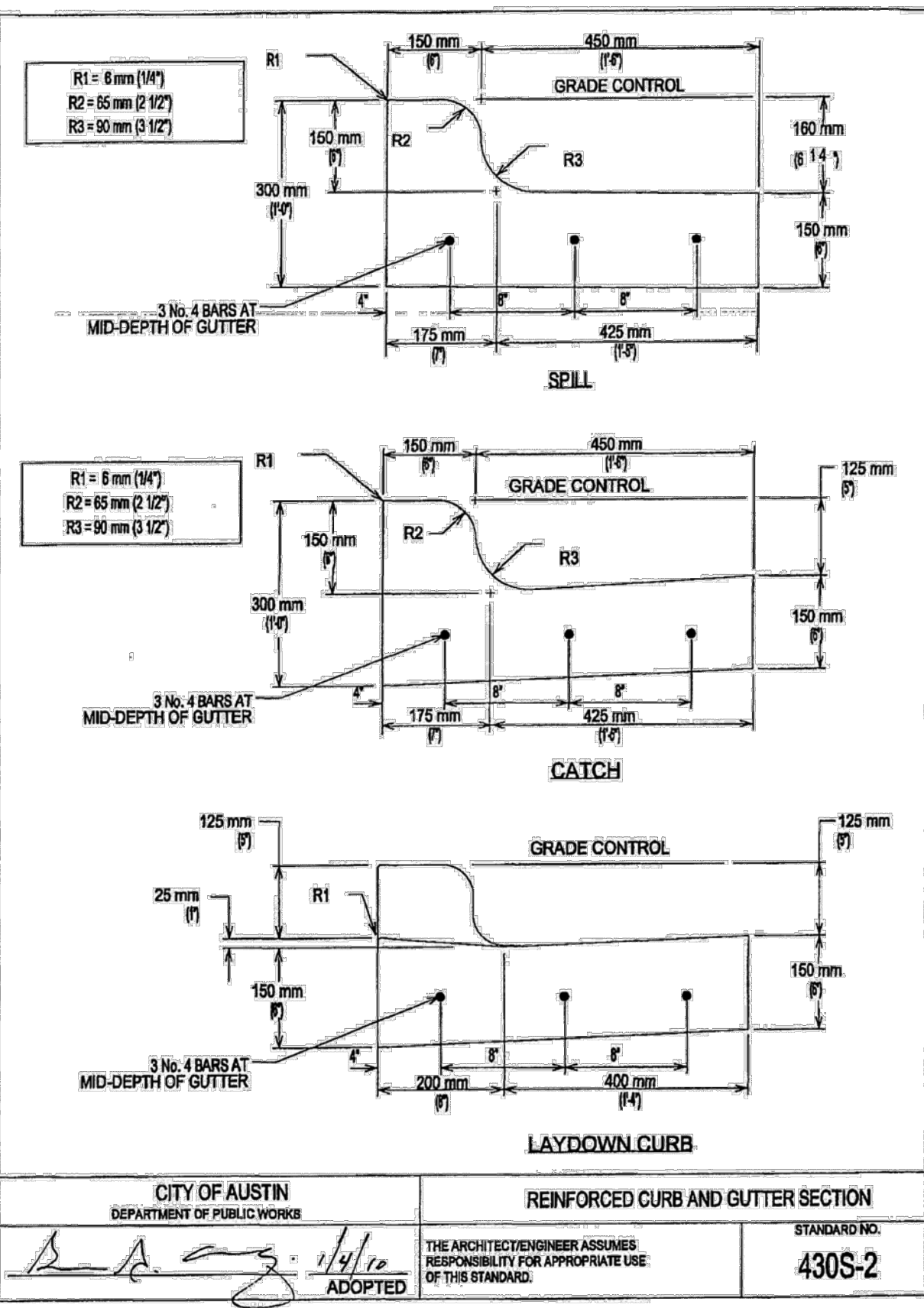

NOTES:  
 1. PUBLIC HYDRANTS SHALL BE FACTORY PAINTED WITH BRIGHT ALUMINUM BASED SILVER PAINT AND PRIVATE HYDRANTS SHALL BE PAINTED RED.  
 2. A BLUE REFLECTIVE PAVEMENT MARKER MUST BE PLACED WITH EVERY FIRE HYDRANT ADJACENT TO A PAVED ROADWAY 6\"/>

NO.	DESCRIPTION	APP	DATE

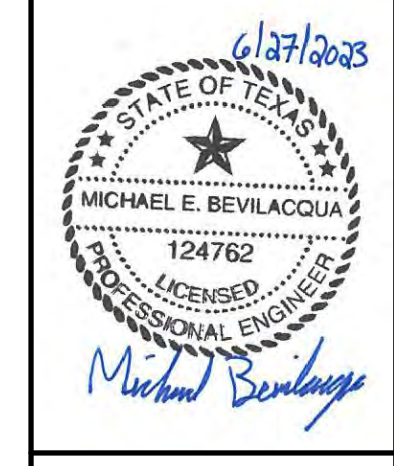

**Green**  
**Civil Design**  
 Engineering & Consulting  
 301 Denali Pass Dr., Suite 3  
 Cedar Park, Texas 78613  
 (512) 640-0390  
 Texas Registered Engineering Firm F-17563

ACTON ACADEMY  
 ACTON ACADEMY - PHASE 1  
 STANDARD DETAILS (2 OF 2)  
 SHEET  
**18**  
 OF 18



## Contributing Zone Plan Application

### Attachment N

#### Inspection, Maintenance, Repair, and Retrofit Plan

The inspection, maintenance, repair, and if necessary, retrofit plans for the permanent BMP's, including the Detention and Water Quality (Batch) detention ponds and vegetative filter strips are provided below. All documents and reports regarding the inspections, maintenance procedures, repair, and, if necessary, retrofitting shall be kept on-site. All records shall be made available to TCEQ upon request.

#### **Batch Detention Pond**

Batch detention ponds have somewhat higher maintenance requirements than an extended detention basin since they are active stormwater controls. The maintenance, inspections, and repair activities are provided below.

- ***Inspections:*** Inspections should take place a minimum of twice a year. One inspection should take place during wet weather to determine if the basin is meeting the target detention time of 12 hours and a drawdown time of no more than 48 hours. The remaining inspections should occur between storm events so that manual operation of the valve and controller can be verified. The level sensor in the basin should be inspected and any debris or sediment in the area should be removed. The outlet structure and the trash screen should be inspected for signs of clogging. Debris and sediment should be removed from the orifice and outlet(s) as described in previous sections. Debris obstructing the valve should be removed. During each inspection, erosion areas inside and downstream of this BMP should be identified and repaired/revegetated immediately.
- ***Mowing:*** The basin, basin side-slopes, and embankment of the basin must be mowed to prevent woody growth and control weeds. A mulching mower should be used, or the grass clippings should be caught and removed. Mowing should take place at least twice a year, or more frequently if vegetation exceeds 18 inches in height. More frequent mowing to maintain aesthetic appeal may be necessary in landscaped areas.
- ***Litter and Debris Removal:*** Litter and debris removal should take place at least twice a year, as part of the periodic mowing operations and inspections. Debris and litter should be removed from the surface of the basin. Particular attention should be paid to floatable debris around the outlet structure. The outlet should be checked for possible clogging or obstructions and any debris removed.
- ***Erosion control:*** The basin side slopes and embankment all may periodically suffer from slumping and erosion. To correct these problems, corrective action, such as regrading and revegetation, may be necessary. Correction of erosion control should take place whenever required based on the periodic inspections.
- ***Nuisance Control:*** Standing water or soggy conditions may occur in the basin. Some standing water may occur after a storm event since the valve may close with 2 to 3 inches of water in the basin. Some flow into the basin may also occur between storms due to spring flow and/or water use that enters the storm sewer system. Twice a year, the facility should be evaluated in terms of nuisance control (insects, weeds, odors, algae, etc.).



- Structural Repairs and Replacement: With each inspection, any damage to structural elements of the basin (pipes, concrete drainage structures, retaining walls, etc.) should be identified and repaired immediately. An example of this type of repair can include patching of cracked concrete, sealing of voids, removal of vegetation from cracks and joints. The various inlet/outlet structures in a basin will eventually deteriorate and must be replaced.
- Sediment Removal: A properly designed batch detention basin will accumulate quantities of sediment over time. The accumulated sediment can detract from the appearance of the facility and reduce the pollutant removal performance of the facility. The sediment also tends to accumulate near the outlet structure and can interfere with the level sensor operation. Sediment shall be removed from the basin at least every 5 years, when sediment depth exceeds 6 inches, when the sediment interferes with the level sensor or when the basin does not drain within 48 hours. Care should be taken not to compromise the basin lining during maintenance.
- Logic Controller: The Logic Controller should be inspected as part of the bi-annual inspections. Verify that the external indicators (active, cycle in progress) are operating properly by turning the controller off and on, and by initiating a cycle by triggering the level sensor in the basin. The valve should be manually opened and closed using the open/close switch to verify valve operation and to assist in inspecting the valve for debris. The solar panel should be inspected and any dust or debris on the panel should be carefully removed. The controller and all other circuitry and wiring should be inspected for signs of corrosion, damage from insects, water leaks, or other damage. At the end of the inspection, the controller should be reset.

Responsible Party: Acton Academy

Address: 1000 Hays Country Acres Road, Dripping Springs, Texas 78620



Signature

10/12/2022

Date

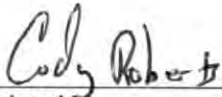

Printed Name

**CONTRIBUTING ZONE PLAN APPLICATION**

**Attachment O**

**Pilot-Scale Field Testing Plan**

A pilot-scale field testing plan is not proposed with this project.

**CONTRIBUTING ZONE PLAN APPLICATION**

**Attachment P**

**Measures for Minimizing Surface Stream Contamination**

Not applicable to project – Discharge directly into a stream is not proposed with this project.

# Temporary Stormwater Section

Texas Commission on Environmental Quality

for Regulated Activities on the Edwards Aquifer Recharge Zone and Relating to 30 TAC §213.5(b)(4)(A), (B), (D)(I) and (G); Effective June 1, 1999

*To ensure that the application is administratively complete, confirm that all fields in the form are complete, verify that all requested information is provided, consistently reference the same site and contact person in all forms in the application, and ensure forms are signed by the appropriate party.*

*Note: Including all the information requested in the form and attachments contributes to more streamlined technical reviews.*

## Signature

To the best of my knowledge, the responses to this form accurately reflect all information requested concerning the proposed regulated activities and methods to protect the Edwards Aquifer. This **Temporary Stormwater Section** is hereby submitted for TCEQ review and executive director approval. The application was prepared by:

Print Name of Customer/Agent: Michael Bevilacqua

Date: 10/12/2022

Signature of Customer/Agent:



Regulated Entity Name: Acton Academy

## Project Information

### Potential Sources of Contamination

*Examples: Fuel storage and use, chemical storage and use, use of asphaltic products, construction vehicles tracking onto public roads, and existing solid waste.*

1. Fuels for construction equipment and hazardous substances which will be used during construction:

The following fuels and/or hazardous substances will be stored on the site: Diesel and Gasoline

These fuels and/or hazardous substances will be stored in:

- Aboveground storage tanks with a cumulative storage capacity of less than 250 gallons will be stored on the site for less than one (1) year.



- Aboveground storage tanks with a cumulative storage capacity between 250 gallons and 499 gallons will be stored on the site for less than one (1) year.
- Aboveground storage tanks with a cumulative storage capacity of 500 gallons or more will be stored on the site. An Aboveground Storage Tank Facility Plan application must be submitted to the appropriate regional office of the TCEQ prior to moving the tanks onto the project.
- Fuels and hazardous substances will not be stored on the site.
- 2.  **Attachment A - Spill Response Actions.** A site specific description of the measures to be taken to contain any spill of hydrocarbons or hazardous substances is attached.
- 3.  Temporary aboveground storage tank systems of 250 gallons or more cumulative storage capacity must be located a minimum horizontal distance of 150 feet from any domestic, industrial, irrigation, or public water supply well, or other sensitive feature.
- 4.  **Attachment B - Potential Sources of Contamination.** A description of any activities or processes which may be a potential source of contamination affecting surface water quality is attached.

### ***Sequence of Construction***

- 5.  **Attachment C - Sequence of Major Activities.** A description of the sequence of major activities which will disturb soils for major portions of the site (grubbing, excavation, grading, utilities, and infrastructure installation) is attached.
  - For each activity described, an estimate (in acres) of the total area of the site to be disturbed by each activity is given.
  - For each activity described, include a description of appropriate temporary control measures and the general timing (or sequence) during the construction process that the measures will be implemented.
- 6.  Name the receiving water(s) at or near the site which will be disturbed or which will receive discharges from disturbed areas of the project: Onion Creek

### ***Temporary Best Management Practices (TBMPs)***

*Erosion control examples: tree protection, interceptor swales, level spreaders, outlet stabilization, blankets or matting, mulch, and sod. Sediment control examples: stabilized construction exit, silt fence, filter dikes, rock berms, buffer strips, sediment traps, and sediment basins. Please refer to the Technical Guidance Manual for guidelines and specifications. All structural BMPs must be shown on the site plan.*

- 7.  **Attachment D – Temporary Best Management Practices and Measures.** TBMPs and measures will prevent pollution of surface water, groundwater, and stormwater. The construction-phase BMPs for erosion and sediment controls have been designed to retain sediment on site to the extent practicable. The following information is attached:

- A description of how BMPs and measures will prevent pollution of surface water, groundwater or stormwater that originates upgradient from the site and flows across the site.
  - A description of how BMPs and measures will prevent pollution of surface water or groundwater that originates on-site or flows off site, including pollution caused by contaminated stormwater runoff from the site.
  - A description of how BMPs and measures will prevent pollutants from entering surface streams, sensitive features, or the aquifer.
  - A description of how, to the maximum extent practicable, BMPs and measures will maintain flow to naturally-occurring sensitive features identified in either the geologic assessment, TCEQ inspections, or during excavation, blasting, or construction.
8.  The temporary sealing of a naturally-occurring sensitive feature which accepts recharge to the Edwards Aquifer as a temporary pollution abatement measure during active construction should be avoided.
- Attachment E - Request to Temporarily Seal a Feature.** A request to temporarily seal a feature is attached. The request includes justification as to why no reasonable and practicable alternative exists for each feature.
  - There will be no temporary sealing of naturally-occurring sensitive features on the site.
9.  **Attachment F - Structural Practices.** A description of the structural practices that will be used to divert flows away from exposed soils, to store flows, or to otherwise limit runoff discharge of pollutants from exposed areas of the site is attached. Placement of structural practices in floodplains has been avoided.
10.  **Attachment G - Drainage Area Map.** A drainage area map supporting the following requirements is attached:
- For areas that will have more than 10 acres within a common drainage area disturbed at one time, a sediment basin will be provided.
  - For areas that will have more than 10 acres within a common drainage area disturbed at one time, a smaller sediment basin and/or sediment trap(s) will be used.
  - For areas that will have more than 10 acres within a common drainage area disturbed at one time, a sediment basin or other equivalent controls are not attainable, but other TBMPs and measures will be used in combination to protect down slope and side slope boundaries of the construction area.
  - There are no areas greater than 10 acres within a common drainage area that will be disturbed at one time. A smaller sediment basin and/or sediment trap(s) will be used in combination with other erosion and sediment controls within each disturbed drainage area.

- There are no areas greater than 10 acres within a common drainage area that will be disturbed at one time. Erosion and sediment controls other than sediment basins or sediment traps within each disturbed drainage area will be used.
11.  **Attachment H - Temporary Sediment Pond(s) Plans and Calculations.** Temporary sediment pond or basin construction plans and design calculations for a proposed temporary BMP or measure have been prepared by or under the direct supervision of a Texas Licensed Professional Engineer. All construction plans and design information must be signed, sealed, and dated by the Texas Licensed Professional Engineer. Construction plans for the proposed temporary BMPs and measures are attached.
- N/A
12.  **Attachment I - Inspection and Maintenance for BMPs.** A plan for the inspection of each temporary BMP(s) and measure(s) and for their timely maintenance, repairs, and, if necessary, retrofit is attached. A description of the documentation procedures, recordkeeping practices, and inspection frequency are included in the plan and are specific to the site and/or BMP.
13.  All control measures must be properly selected, installed, and maintained in accordance with the manufacturer's specifications and good engineering practices. If periodic inspections by the applicant or the executive director, or other information indicate a control has been used inappropriately, or incorrectly, the applicant must replace or modify the control for site situations.
14.  If sediment escapes the construction site, off-site accumulations of sediment must be removed at a frequency sufficient to minimize offsite impacts to water quality (e.g., fugitive sediment in street being washed into surface streams or sensitive features by the next rain).
15.  Sediment must be removed from sediment traps or sedimentation ponds not later than when design capacity has been reduced by 50%. A permanent stake will be provided that can indicate when the sediment occupies 50% of the basin volume.
16.  Litter, construction debris, and construction chemicals exposed to stormwater shall be prevented from becoming a pollutant source for stormwater discharges (e.g., screening outfalls, picked up daily).

### ***Soil Stabilization Practices***

*Examples: establishment of temporary vegetation, establishment of permanent vegetation, mulching, geotextiles, sod stabilization, vegetative buffer strips, protection of trees, or preservation of mature vegetation.*

17.  **Attachment J - Schedule of Interim and Permanent Soil Stabilization Practices.** A schedule of the interim and permanent soil stabilization practices for the site is attached.

18.  Records must be kept at the site of the dates when major grading activities occur, the dates when construction activities temporarily or permanently cease on a portion of the site, and the dates when stabilization measures are initiated.
19.  Stabilization practices must be initiated as soon as practicable where construction activities have temporarily or permanently ceased.

### ***Administrative Information***

20.  All structural controls will be inspected and maintained according to the submitted and approved operation and maintenance plan for the project.
21.  If any geologic or manmade features, such as caves, faults, sinkholes, etc., are discovered, all regulated activities near the feature will be immediately suspended. The appropriate TCEQ Regional Office shall be immediately notified. Regulated activities must cease and not continue until the TCEQ has reviewed and approved the methods proposed to protect the aquifer from any adverse impacts.
22.  Silt fences, diversion berms, and other temporary erosion and sediment controls will be constructed and maintained as appropriate to prevent pollutants from entering sensitive features discovered during construction.



## TEMPORARY STORMWATER SECTION

### Attachment A

#### Spill Response Plan

This purpose of this spill response plan is to provide measures to help prevent or reduce spills as well as provide a response plan in the event of a spill. This plan is based on TCEQ RG348, Section 1.4.16 "Spill Prevention and Control".

#### Education

- Contractor and all sub-contractors shall be aware of what a "significant spill" is for each material they use, and the appropriate response for "significant" and "insignificant" spills. Contractor and all sub-contractors shall also be aware of when spill must be reported to the TCEQ as noted in the 'Reportable Quantity' section on page 3 of this plan. Information available in 30 TAC 327.4 and 40 CFR 302.4.
- Contractor and all sub-contractors shall educate all their employees on potential dangers to humans and the environment from spills and leaks for each material they use. Regular meetings shall be held to discuss and reinforce appropriate disposal procedures.
- Contractor and all its sub-contractors shall establish a continuing education program to indoctrinate new employees.
- Contractor's superintendent and/or site representative shall oversee and enforce proper spill prevention and control measures.

#### General Measures

- To the extent that the work can be accomplished safely, spills of oil, petroleum products, substances listed under 40 CFR parts 110,117, and 302, and sanitary and septic wastes should be contained and cleaned up immediately.
- Store hazardous materials and wastes in covered containers and protect from vandalism.
- Place a stockpile of spill cleanup materials where it will be readily accessible.
- Train and educate employees in spill prevention and cleanup.
- Contractor shall designate responsible individuals to oversee and enforce control measures.
- Spills should be covered and protected from stormwater runoff during rainfall to the extent that it doesn't compromise cleanup activities.
- Do not bury or wash spills with water.
- Store and dispose of used clean up materials, contaminated materials, and recovered spill material that is no longer suitable for the intended purpose in conformance with the provisions in applicable BMPs.
- Do not allow water used for cleaning and decontamination to enter storm drains or watercourses. Collect and dispose of contaminated water in accordance with applicable local, state, and federal regulations.
- Contain water overflow or minor water spillage and do not allow it to discharge into drainage facilities or watercourses.

- Place Material Safety Data Sheets (MSDS), as well as proper storage, cleanup, and spill reporting instructions for hazardous materials stored or used on the project site in an open, conspicuous, and accessible location.
- Keep waste storage areas clean, well-organized, and equipped with ample cleanup supplies as appropriate for the materials being stored. Perimeter controls, containment structures, covers, and liners should be repaired or replaced as needed to maintain proper function.
- Temporary aboveground storage tank systems of 250-gallons or more cumulative storage capacity must be located a minimum horizontal distance of 150-feet from any domestic, industrial, irrigation, or public water supply well, or other sensitive features.

#### Cleanup

- All spills and leaks shall be cleaned up immediately.
- Use a rag for small spills on paved surfaces, a damp mop for general cleanup, and absorbent material for larger spills. If the spilled material is hazardous, then the used cleanup materials are also hazardous and must be disposed of as hazardous waste.
- Never hose down or bury dry material spills. Clean up as much of the material as possible and dispose of properly. See the waste management BMPs in this section for specific information.

#### Minor Spills

- Minor spills typically involve small quantities of oil, gasoline, paint, etc. which can be controlled by the first responder at the discovery of the spill.
- Use absorbent materials on small spills rather than hosing down or burying the spill.
- Absorbent materials should be promptly removed and disposed of properly.
- Follow the practice below for a minor spill:
  1. Contain the spread of the spill.
  2. Recover spilled materials.
  3. Clean the contaminated area and properly dispose of contaminated materials.
- Follow the Reportable Quantities section on page 3 of this plan.

#### Semi-Significant Spills

- Semi-significant spills still can be controlled by the first responder along with the aid of other personnel such as laborers and the foreman, etc. This response may require the cessation of all other activities.
- Spills should be cleaned up immediately:
- Contain spread of the spill.
- Notify the project foreman immediately.
- If the spill occurs on paved or impermeable surfaces, clean up using "dry" methods (absorbent materials, cat litter and/or rags). Contain the spill by encircling with absorbent materials and do not let the spill spread widely.

- If the spill occurs in dirt areas, immediately contain the spill by constructing an earthen dike. Dig up and properly dispose of contaminated soil.
- If the spill occurs during rain, cover spill with tarps or other material to prevent contaminating runoff.
- Follow the Reportable Quantities section on page 3 of this plan.

#### Significant/Hazardous Spills

- For significant or hazardous spills that are in reportable quantities:
  - Notify the TCEQ by telephone as soon as possible and within 24 hours at 512-339-2929 (Austin) or 210-490-3096 (San Antonio) between 8 AM and 5 PM. After hours, contact the Environmental Release Hotline at 1-800-832-8224. It is the contractor's responsibility to have all emergency phone numbers at the construction site.
- For spills of federal reportable quantities, in conformance with the requirements in 40 CFR parts 110,119, and 302, the contractor should notify the National Response Center at (800) 424-8802.
- Notification should first be made by telephone and followed up with a written report.
- The services of a spill's contractor or a Haz-Mat team should be obtained immediately. Construction personnel should not attempt to clean up until the appropriate and qualified staffs have arrived at the job site.
- Other agencies which may need to be consulted include but are not limited to, the City Police Department, County Sheriff Office, Fire Departments, etc.
- More information on spill rules and appropriate responses is available on the TCEQ website at: [http://www.tnrcc.state.tx.us/enforcement/emergency\\_response.html](http://www.tnrcc.state.tx.us/enforcement/emergency_response.html)
- Follow the 'Reportable Quantities' section of this plan as listed below.

#### Reportable Quantities

- Upon determining that a reportable discharge or spill has occurred, the responsible party must notify the state. The threshold quantity that triggers the requirement to report a spill is called the reportable quantity (RQ). The reportable quantity depends on the type of substance released and where released (e.g. into water vs. on land); different kinds of spills are subject to different provisions of state and federal rules. An updated table for RQ is available on the TCEQ website at: [https://www.tceq.texas.gov/response/spills/spill\\_rq.html](https://www.tceq.texas.gov/response/spills/spill_rq.html)

#### Vehicle and Equipment Maintenance

- If maintenance must occur onsite, use a designated area and a secondary containment, located away from drainage courses, to prevent the runoff of stormwater and the runoff of spills.
- Regularly inspect onsite vehicles and equipment for leaks and repair immediately
- Check incoming vehicles and equipment (including delivery trucks, and employee and subcontractor vehicles) for leaking oil and fluids. Do not allow leaking vehicles or equipment onsite.
- Always use secondary containment, such as a drain pan or drop cloth, to catch spills or leaks when removing or changing fluids.

- Place drip pans or absorbent materials under paving equipment when not in use.
- Use absorbent materials on small spills rather than hosing down or burying the spill. Remove the absorbent materials promptly and dispose of properly.
- Promptly transfer used fluids to the proper waste or recycling drums. Don't leave full drip pans or other open containers lying around.
- Oil filters disposed of in trashcans or dumpsters can leak oil and pollute stormwater. Place the oil filter in a funnel over a waste oil-recycling drum to drain excess oil before disposal. Oil filters can also be recycled. Ask the oil supplier or recycler about recycling oil filters.
- Store cracked batteries in a non-leaking secondary container. Do this with all cracked batteries even if you think all the acid has drained out. If you drop a battery, treat it as if it is cracked. Put it into the containment area until you are sure it is not leaking.

#### Vehicle and Equipment Fueling

- If fueling must occur on site, use designated areas, located away from drainage courses, to prevent the runoff of stormwater and the runoff of spills.
- Discourage "topping off" of fuel tanks.
- Always use secondary containment, such as a drain pan, when fueling to catch spills/ leaks.

## **TEMPORARY STORMWATER SECTION**

### **Attachment B**

#### **Potential Sources of Contamination**

Other potential sources of contamination are the use of asphalt and concrete products. After placement of asphalt, concrete, emulsion or coatings, the applicant will be responsible for immediate clean-up should an unexpected rain occur. For the duration of the asphalt product curing time, the applicant should maintain standby personnel and equipment to contain any asphalt wash-off should an unexpected rain occur. The concrete washout area will be properly maintained at all times.



## **TEMPORARY STORMWATER SECTION**

### **Attachment C**

#### **Sequence of Major Activities**

The sequence of major activities which will disturb soils, followed by the approximate area to be disturbed, is noted below. The temporary control measures as listed in Attachment D will be provided for each of the major construction activities, from start to finish of construction.

1. Erect temporary erosion and sedimentation controls and tree protection (0 acres)
2. Clearing and grubbing of proposed site (7.20 acres)
3. Excavation, rough cutting and rough grading of site (7.20 acres)
4. Site utilities including water, wastewater, and drainage (2 acres)
5. Paving – Parking (0.833 acres)
6. Proposed building construction (0.50 acres)
7. Other Paving – Sidewalks, patios, etc. (0.79 acres)
8. Final grading (7.20 acres)
9. Revegetation of disturbed areas (5.19 acres)

## **TEMPORARY STORMWATER SECTION**

### **Attachment D**

#### **Temporary Best Management Practices and Measures**

Silt fence will be erected on the downstream side of the entire site. This will protect surface water and ground water from excavation, rough cutting and grading; site utilities including water, wastewater, and drainage; paving; rough grading; construction of the building; final grading; and revegetation. The silt fence will not be taken down until all disturbed areas have been fully stabilized with vegetation. Pollution of surface water, ground water or stormwater originating up gradient is not anticipated due to existing topography and drainage patterns. The existing drainage patterns will be revised by the proposed grading to allow the stormwater to be conveyed to a batch pond. The silt fence will prevent pollution of surface streams, sensitive features or the aquifer.

## **TEMPORARY STORMWATER SECTION**

### **Attachment E**

#### **Request to Temporarily Seal a Feature**

Not Applicable to Project - There will be no temporary sealing of a naturally-occurring sensitive features on the site.

## **TEMPORARY STORMWATER SECTION**

### **Attachment F**

#### **Structural Practices**

Silt fence, placed downstream of all disturbed areas, will limit run-off discharge of pollutants from exposed areas of the site. No structural practices will be used to divert flows away from exposed soils. No structural practices will be placed in floodplains.

**TEMPORARY STORMWATER SECTION**

**Attachment G**

**Drainage Area Maps**







FILE: p:\Projects\1137 - cody roberts\003 - acton academy phase 1\CAD\Sheets\1137-003 - PROPOSED DRAINAGE PLAN.dwg TAB: 14 PROPOSED DRAINAGE PLAN PLOTTED: 6/30/2023 11:39 AM BY: MIKE BEV

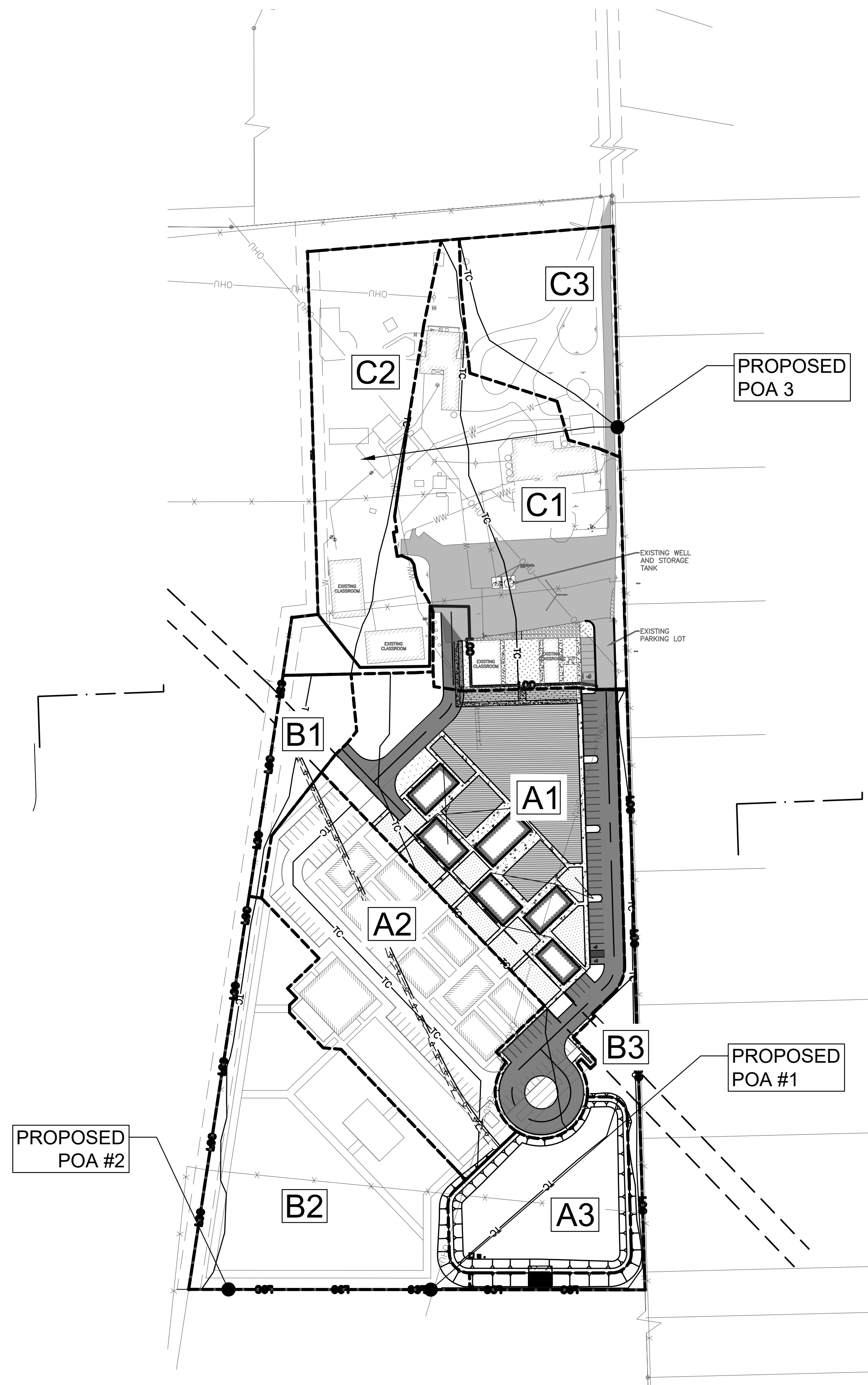

**LEGEND**

	IRON ROD FOUND
	IRON ROD SET
	EXISTING OVERHEAD UTILITY
	EXISTING UTILITY POLE
	EXISTING WIRE FENCE
	PROPERTY LINE
	EXISTING CONTOUR
	PROPOSED FIRE LANE
	FIRE LANE SIGNAGE

**HEC HMS RESULTS SUMMARY  
BATCH POND/POA #1<sup>1</sup>**

	EXISTING FLOW (CFS)	DEVELOPED FLOW (CFS)	DEVELOPED WITH DETENTION (CFS)	POND ELEVATION (FT)
2 YR	18.4	24.9	13.9	1130.4
10 YR	35.1	40.7	29.3	1130.7
25 YR	46.7	51.6	40.2	1130.9
100 YR	66.6	70.4	58.2	1131.1

1. NOAA ATLAS 14 RAINFALL DATA WAS USED IN THE HEC-HMS MODEL PER COA DRAINAGE CRITERIA MANUAL.

**HEC HMS RESULTS SUMMARY - ALL<sup>1</sup>**

	BATCH POND (POA #1) AND POA #2			POA #3	
	EXISTING FLOW (CFS)	DEVELOPED FLOW (CFS)	DEVELOPED WITH DETENTION (CFS)	EXISTING FLOW (CFS)	DEVELOPED FLOW (CFS)
2 YR	28.1	37.5	26.5	2.7	2.7
10 YR	53.9	64.0	52.6	5.0	4.6
25 YR	71.9	82.3	70.9	6.6	5.9
100 YR	102.6	113.7	101.5	9.3	8.2

1. NOAA ATLAS 14 RAINFALL DATA WAS USED IN THE HEC-HMS MODEL PER COA DRAINAGE CRITERIA MANUAL.

**IMPERVIOUS COVER NOTES:**

- THE PRE-1999 IMPERVIOUS COVER EQUALS 14,398-SQFT (0.33-ACRES).
- TOTAL EXISTING IMPERVIOUS COVER EQUALS 87,886-SQFT (2.018-ACRES).
  - THE ADDITIONAL 73,488-SQFT (1.688-ACRES) OF EXISTING IMPERVIOUS COVER IS FROM 1999 TO PRESENT AND WAS DEVELOPED ON LAND LESS THAN 5-ACRES. THE I.C. FROM 1999 TO PRESENT WILL BE CONSIDERED 'PROPOSED' ON THE WATER QUALITY CALCULATIONS SHOWN ON SHEET 15.
- AREA A2 AND B2 ARE AREAS OF FUTURE IMPROVEMENTS WITH AN ASSUMED IMPERVIOUS COVER OF 95,338-SQFT (2.19-ACRES), AND 20,407-SQFT (0.47-ACRES), RESPECTIVELY.

Drainage Area	Area (acres)	Area (sq m)	Impervious Cover (%)	Composite "C"				SCS CN	Sheet Flow Grass			Tc (min)	Sheet Flow Pavement			Tc (min)	Shallow Conc. Flow Grass Lawn			Tc (min)	Shallow Conc. Flow Pavement			Tc (min)	Tc Total (min)	Tc Design (min)	T lag (min)
				2	10	25	100		L (ft)	n	S (%)		L (ft)	n	S (%)		L (ft)	n	S (%)		L (ft)	n	S (%)				
<b>PROPOSED</b>																											
A1*	3.05	0.004770	52%impervious,48%grass fl cond, av slope	0.53	0.60	0.65	0.73	80.00	100	0.30	4.48%	11.02	0	0.02	0.00%	0.00	345	0.30	2.23%	2.39	241	0.02	3.59%	1.04	15.35	15.35	9.208
A2*	2.19	0.003420	100%impervious,0%grass fl cond, av slope	0.75	0.83	0.88	0.97	80.00	0	0.30	0.00%	0.00	100	0.02	2.57%	1.43	0	0.30	0.00%	0.00	508	0.02	2.31%	2.74	4.17	5.00	3.000
A3*	0.97	0.001509	0%impervious,100%grass fl cond, av slope	0.29	0.35	0.39	0.46	80.00	100	0.30	3.00%	13.99	0	0.02	0.00%	0.00	193	0.30	1.12%	1.88	0	0.02	0.00%	0.00	15.87	15.87	9.524
B1**	0.39	0.000609	0%impervious,100%grass fl cond, av slope	0.29	0.35	0.39	0.46	80.00	100	0.30	2.19%	15.87	0	0.02	0.00%	0.00	202	0.30	2.88%	1.23	0	0.02	0.00%	0.00	17.10	17.10	10.258
B2**	2.43	0.003798	19%impervious,81%grass fl cond, av slope	0.38	0.44	0.48	0.56	80.00	100	0.30	4.38%	12.05	0	0.02	0.00%	0.00	446	0.30	3.38%	2.51	0	0.02	0.00%	0.00	14.55	14.55	8.732
B3**	0.54	0.000844	0%impervious,100%grass fl cond, av slope	0.29	0.35	0.39	0.46	80.00	100	0.30	4.07%	12.38	0	0.02	0.00%	0.00	695	0.30	2.95%	4.18	0	0.02	0.00%	0.00	16.66	16.66	9.938
C1**	2.57	0.004009	54%impervious,46%grass fl cond, av slope	0.54	0.61	0.65	0.73	80.00	100	0.30	1.54%	17.81	0	0.02	0.00%	0.00	304	0.30	4.19%	1.53	201	0.02	4.19%	0.81	20.15	20.15	12.991
C2**	1.81	0.002827	15%impervious,85%grass fl cond, av slope	0.36	0.42	0.47	0.54	80.00	100	0.30	4.61%	11.78	0	0.02	0.00%	0.00	289	0.30	5.02%	1.33	0	0.02	0.00%	0.00	13.11	13.11	7.868
C3	1.06	0.001652	34%impervious,66%grass fl cond, av slope	0.45	0.51	0.56	0.63	80.00	100	0.30	1.65%	17.77	0	0.02	0.00%	0.00	242	0.30	5.06%	1.11	0	0.02	0.00%	0.00	18.88	18.88	11.328

\*Drains to Pond (POA #1)  
\*\*A2, B2, C2 Drain to POA #2  
\*\*\*Drains to POA #1  
\*\*\*\*Drains to POA #2  
C3 Drains offsite (POA #3)

NO.	DESCRIPTION	APP	DATE



**Green Civil Design**  
Engineering & Consulting  
Texas Registered Engineering Firm F-17563  
301 Denali Pass Dr., Suite 3  
Cedar Park, Texas 78613  
(512) 640-0390

ACTON ACADEMY  
ACTON ACADEMY - PHASE 1  
PROPOSED DRAINAGE PLAN



**TEMPORARY STORMWATER SECTION**

**Attachment H**

**Temporary Sediment Pond(s) Plans and Calculations**

Not Applicable to Project - There will be no temporary sediment pond or basins with this project.

## **TEMPORARY STORMWATER SECTION**

### **Attachment I**

#### **Inspections and Maintenance for BMPs**

- All control measures will be properly selected, installed, and maintained in accordance with the manufacturer's specifications and good engineering practice. A control measure will be replaced or modified if it is determined by the applicant, executive director, and/or other information indicates that a control measure has been used inappropriately or incorrectly.
- All control measures will be inspected at least once each week and following any storm event of 0.5 inches or greater.
- All measures will be maintained in good working order; if a repair is necessary, it will be initiated within 24 hours of report. A corrective action log will be kept on-site and updated after each repair.
- Built-up sediment will be removed from silt fences and rock berms when they have reached 50% design capacity. A permanent stake will be provided that can indicate when the sediment occupies 50% of the capacity.
- Silt fences will be inspected for depth of sediment, tears, to see if the fabric is securely attached to the fence posts, and to see that the fence posts are firmly in the ground.
- If sediment escapes the construction site, off-site accumulations of sediment will be removed at a frequency sufficient to minimize offsite impacts to water quality.
- Sediment basins, if present, will be inspected for depth of sediment, and build-up sediment will be removed when it reaches 10% of the design capacity or at the end of the job.
- Diversion dikes, if present, will be inspected and any breaches promptly repaired.
- The Stabilized Construction Entrance shall be inspected and maintained in a condition which will prevent tracking or flowing from the site. Any sediment spilled, dropped, washed, or tracked from the site shall be removed immediately by the Contractor. When necessary, wheels shall be cleaned to remove sediment prior to exiting the site. All washing shall be done on an area stabilized with crushed stone that drains into an approved sediment trap or basin. All sediment shall be prevented from entering any storm drain, ditch, or water course by using approved methods.
- The Stabilized Construction Entrance shall periodically be top dressed with additional stone as conditions demand. Repair and/or cleanout any measures used to trap sediment.
- The Concrete Washout shall be inspected for tears, holes, or other defects that compromise the impermeability of the lining before every use. Repairs, if necessary, shall be made prior to the use of the washout area. All excess concrete shall only be dumped in the designated areas.

- The Concrete Washout shall be inspected and maintained in a condition to avoid mixing excess amount of fresh concrete and to prevent wash out of concrete trucks into storm drains, open ditches, streets, or streams.
- Temporary and permanent seeding and planting will be inspected for bare spots, washouts, and healthy growth.
- Litter, construction debris, and construction chemicals exposed to stormwater will be prevented from becoming a pollutant source for stormwater discharges by daily inspections and clean-up.
- A maintenance inspection report will be made after each inspection. A copy of the report forms shall be kept on site and made available to TCEQ upon request.
- The site job superintendent will select the individuals who will be responsible for inspections, maintenance and repair activities, and filling out the inspection and maintenance reports.
- Personnel selected for inspection and maintenance responsibilities will receive training from the site job superintendent. They will be trained in all the inspection and maintenance practices necessary for keeping the erosion and sediment controls used onsite in good working order.

## **TEMPORARY STORMWATER SECTION**

### **Attachment J**

#### **Schedule of Interim and Permanent Soil Stabilization Practices**

During and after grading has been completed no slope will exceed 3:1. Permanent soil stabilization will be accomplished by revegetation. Stabilization measures shall be initiated as soon as practicable in portions of the site where construction activities have temporarily or permanently ceased, but in no case more than 14 days after the construction activity in that portion of the site has temporarily or permanently ceased. Where the initiation of stabilization measures by the 14th day after construction activity temporary or permanently cease is precluded by weather conditions, stabilization measures shall be initiated as soon as practicable. Where construction activity on a portion of the site is temporarily ceased, and earth disturbing activities will be resumed within 21 days, temporary stabilization measures do not have to be initiated on that portion of site. In areas experiencing droughts where the initiation of stabilization measures by the 14th day after construction activity has temporarily or permanently ceased is precluded by seasonal arid conditions, stabilization measures shall be initiated as soon as practicable.

Only after permanent vegetation is established will the silt fence be removed. Records will be kept at the site which include dates when major grading activities occur, the dates when construction activities temporarily or permanently cease on a portion of the site, and the dates when stabilization measures are initiated.