

15917 Great Oaks Drive

WPAP AND SCS
Water Pollution Abatement Plan and
Organized Sewage Collection System Plan
City of Round Rock

February 2024



Contents

1. TCEQ-20705 Edwards Aquifer Application Cover	4
2. TCEQ-0587 General Information Form	9
Attachment A – Road Map	14
Attachment B - USGS / Edwards Recharge Zone Map.....	16
Attachment C - Project Description	19
3. TCEQ-0585 Geologic Assessment	20
Attachment A – Geologic Assessment Table.....	28
Attachment B – Stratigraphic Column	30
Attachment C – Site Geology.....	32
Attachment D – Site Geology Maps.....	36
Attachment E – Historical Aerial Photos.....	41
4. TCEQ-0584 Water Pollution Abatement Plan Application.....	55
Attachment A – Factors Affecting Surface Water Quality.....	61
Attachment B – Volume and Character of Stormwater.....	62
Attachment C – Suitability Letter from Authorized Agent.....	63
Attachment D – Exception to the Required Geologic Assessment.....	64
Site Plan.....	65
5. TCEQ-0582 Organized Sewage Collection System Plan	66
Attachment A – SCS Engineering Design Report	78
Attachment B - Justification and Calculations for Deviation in Straight Alignment Without Manholes	86
Attachment C - Justification for Variance from Maximum Manhole Spacing	87
Attachment D – Calculations for Slopes for Flows Greater Than 10.0 Feet Per Second.....	88
Site Plan	89
Final Plan and Profile Sheets	91
Water Pollution Abatement Plan (WPAP) Application Approved.....	84
Previously Approved WPAP Application.....	93
Previously Approved SCS Application.....	101
6. TCEQ-0602 Temporary Stormwater Section.....	106
Attachment A - Spill Response Actions.....	112
Attachment B: Potential Sources of Contamination.....	116
Attachment C - Sequence of Major Activities.....	118

Attachment D - Temporary Best Management Practices and Measures	119
Attachment E – Request to Temporary Seal a Feature	120
Attachment F - Structural Practices	121
Attachment G - Drainage Area Map	122
Attachment H – Temporary Sediment Pond Plans and Calculations.....	124
Attachment I - Inspection and Maintenance for BMPs	125
Attachment J - Schedule of Interim and Permanent Soil Stabilization Practices.....	127
7. TCEQ-0600 Permanent Stormwater Section	128
Attachment A – 20% or Less Impervious Cover Waiver	133
Attachment B – BMPs for Upgradient Stormwater	134
Attachment C – BMPs for On-Site Stormwater	135
Attachment D – BMPs for Surface Streams	136
Attachment E – Request to Seal Features	137
Attachment F – Construction Plans	138
Attachment G – Inspection, Maintenance, Repair and Retrofit Plan	139
Attachment H – Pilot-Scale Field Testing Plan	142
Attachment I – Measures for Minimizing Surface Stream	143
8. TCEQ-0599 Agent Authorization Form	144
9. TCEQ-0574 Application Fee Form.....	147
10. TCEQ-10400 Core Data Form.....	150
11. Site Plan Set	153

1. TCEQ-20705 Edwards Aquifer Application Cover

Texas Commission on Environmental Quality

Edwards Aquifer Application Cover Page

Our Review of Your Application

The Edwards Aquifer Program staff conducts an administrative and technical review of all applications. The turnaround time for administrative review can be up to 30 days as outlined in 30 TAC 213.4(e). Generally administrative completeness is determined during the intake meeting or within a few days of receipt. The turnaround time for technical review of an administratively complete Edwards Aquifer application is 90 days as outlined in 30 TAC 213.4(e). Please know that the review and approval time is directly impacted by the quality and completeness of the initial application that is received. In order to conduct a timely review, it is imperative that the information provided in an Edwards Aquifer application include final plans, be accurate, complete, and in compliance with [30 TAC 213](#).

Administrative Review

1. [Edwards Aquifer applications](#) must be deemed administratively complete before a technical review can begin. To be considered administratively complete, the application must contain completed forms and attachments, provide the requested information, and meet all the site plan requirements. The submitted application and plan sheets should be final plans. Please submit one full-size set of plan sheets with the original application, and half-size sets with the additional copies.
To ensure that all applicable documents are included in the application, the program has developed tools to guide you and web pages to provide all forms, checklists, and guidance. Please visit the below website for assistance: <http://www.tceq.texas.gov/field/eapp>.
2. This Edwards Aquifer Application Cover Page form (certified by the applicant or agent) must be included in the application and brought to the administrative review meeting.
3. Administrative reviews are scheduled with program staff who will conduct the review. Applicants or their authorized agent should call the appropriate regional office, according to the county in which the project is located, to schedule a review. The average meeting time is one hour.
4. In the meeting, the application is examined for administrative completeness. Deficiencies will be noted by staff and emailed or faxed to the applicant and authorized agent at the end of the meeting, or shortly after. Administrative deficiencies will cause the application to be deemed incomplete and returned. An appointment should be made to resubmit the application. The application is re-examined to ensure all deficiencies are resolved. The application will only be deemed administratively complete when all administrative deficiencies are addressed.
5. If an application is received by mail, courier service, or otherwise submitted without a review meeting, the administrative review will be conducted within 30 days. The applicant and agent will be contacted with the results of the administrative review. If the application is found to be administratively incomplete, it can be retrieved from the regional office or returned by regular mail. If returned by mail, the regional office may require arrangements for return shipping.
6. If the geologic assessment was completed before October 1, 2004 and the site contains “possibly sensitive” features, the assessment must be updated in accordance with the *Instructions to Geologists* (TCEQ-0585 Instructions).

Technical Review

1. When an application is deemed administratively complete, the technical review period begins. The regional office will distribute copies of the application to the identified affected city, county, and groundwater conservation district whose jurisdiction includes the subject site. These entities and the public have 30 days to provide comments on the application to the regional office. All comments received are reviewed by TCEQ.
2. A site assessment is usually conducted as part of the technical review, to evaluate the geologic assessment and observe existing site conditions. The site must be accessible to our staff. The site boundaries should be clearly marked, features identified in the geologic assessment should be flagged, roadways marked, and the

alignment of the Sewage Collection System and manholes should be staked at the time the application is submitted. If the site is not marked the application may be returned.

3. We evaluate the application for technical completeness and contact the applicant and agent via Notice of Deficiency (NOD) to request additional information and identify technical deficiencies. There are two deficiency response periods available to the applicant. There are 14 days to resolve deficiencies noted in the first NOD. If a second NOD is issued, there is an additional 14 days to resolve deficiencies. If the response to the second notice is not received, is incomplete or inadequate, or provides new information that is incomplete or inadequate, the application must be withdrawn or will be denied. Please note that because the technical review is underway, whether the application is withdrawn or denied **the application fee will be forfeited.**
4. The program has 90 calendar days to complete the technical review of the application. If the application is technically adequate, such that it complies with the Edwards Aquifer rules, and is protective of the Edwards Aquifer during and after construction, an approval letter will be issued. Construction or other regulated activity may not begin until an approval is issued.

Mid-Review Modifications

It is important to have final site plans prior to beginning the permitting process with TCEQ to avoid delays.

Occasionally, circumstances arise where you may have significant design and/or site plan changes after your Edwards Aquifer application has been deemed administratively complete by TCEQ. This is considered a “Mid-Review Modification”. Mid-Review Modifications may require redistribution of an application that includes the proposed modifications for public comment.

If you are proposing a Mid-Review Modification, two options are available:

- If the technical review has begun your application can be denied/withdrawn, your fees will be forfeited, and the plan will have to be resubmitted.
- TCEQ can continue the technical review of the application as it was submitted, and a modification application can be submitted at a later time.

If the application is denied/withdrawn, the resubmitted application will be subject to the administrative and technical review processes and will be treated as a new application. The application will be redistributed to the affected jurisdictions.

Please contact the regional office if you have questions. If your project is located in Williamson, Travis, or Hays County, contact TCEQ’s Austin Regional Office at 512-339-2929. If your project is in Comal, Bexar, Medina, Uvalde, or Kinney County, contact TCEQ’s San Antonio Regional Office at 210-490-3096

Please fill out all required fields below and submit with your application.

1. Regulated Entity Name: 15917 Great Oaks Dr.				2. Regulated Entity No.:					
3. Customer Name: Creek Edge Peppers LLC				4. Customer No.:					
5. Project Type: (Please circle/check one)	New	Modification	Extension	Exception					
6. Plan Type: (Please circle/check one)	WPAP	CZP	SCS	UST	AST	EXP	EXT	Technical Clarification	Optional Enhanced Measures
7. Land Use: (Please circle/check one)	Residential	Non-residential	8. Site (acres):			1.793			
9. Application Fee:	\$650.00	10. Permanent BMP(s):			Sand Filter System				
11. SCS (Linear Ft.):	697.22	12. AST/UST (No. Tanks):			0				
13. County:	Williamson	14. Watershed:			Lake Creek – Brushy Creek				

Application Distribution

Instructions: Use the table below to determine the number of applications required. One original and one copy of the application, plus additional copies (as needed) for each affected incorporated city, county, and groundwater conservation district are required. Linear projects or large projects, which cross into multiple jurisdictions, can require additional copies. Refer to the “Texas Groundwater Conservation Districts within the EAPP Boundaries” map found at:

http://www.tceq.texas.gov/assets/public/compliance/field_ops/eapp/EAPP%20GWCD%20map.pdf

For more detailed boundaries, please contact the conservation district directly.

Austin Region			
County:	Hays	Travis	Williamson
Original (1 req.)	___	___	__1__
Region (1 req.)	___	___	__1__
County(ies)	___	___	__1__
Groundwater Conservation District(s)	__ Edwards Aquifer Authority __ Barton Springs/ Edwards Aquifer __ Hays Trinity __ Plum Creek	__ Barton Springs/ Edwards Aquifer	NA
City(ies) Jurisdiction	__ Austin __ Buda __ Dripping Springs __ Kyle __ Mountain City __ San Marcos __ Wimberley __ Woodcreek	__ Austin __ Bee Cave __ Pflugerville __ Rollingwood __ Round Rock __ Sunset Valley __ West Lake Hills	__ Austin __ Cedar Park __ Florence __ Georgetown __ Jerrell __ Leander __ Liberty Hill __ Pflugerville __1__ Round Rock

San Antonio Region					
County:	Bexar	Comal	Kinney	Medina	Uvalde
Original (1 req.)	___	___	___	___	___
Region (1 req.)	___	___	___	___	___
County(ies)	___	___	___	___	___
Groundwater Conservation District(s)	__ Edwards Aquifer Authority __ Trinity-Glen Rose	__ Edwards Aquifer Authority	__ Kinney	__ EAA __ Medina	__ EAA __ Uvalde
City(ies) Jurisdiction	__ Castle Hills __ Fair Oaks Ranch __ Helotes __ Hill Country Village __ Hollywood Park __ San Antonio (SAWS) __ Shavano Park	__ Bulverde __ Fair Oaks Ranch __ Garden Ridge __ New Braunfels __ Schertz	NA	__ San Antonio ETJ (SAWS)	NA

I certify that to the best of my knowledge, that the application is complete and accurate. This application is hereby submitted to TCEQ for administrative review and technical review.

Sergio Lozano, PE

Print Name of Customer/Authorized Agent

11/29/2023

Signature of Customer/Authorized Agent

Date

****FOR TCEQ INTERNAL USE ONLY****

Date(s) Reviewed:		Date Administratively Complete:	
Received From:		Correct Number of Copies:	
Received By:		Distribution Date:	
EAPP File Number:		Complex:	
Admin. Review(s) (No.):		No. AR Rounds:	
Delinquent Fees (Y/N):		Review Time Spent:	
Lat./Long. Verified:		SOS Customer Verification:	
Agent Authorization Complete/Notarized (Y/N):		Fee Check:	Payable to TCEQ (Y/N):
Core Data Form Complete (Y/N):			Signed (Y/N):
Core Data Form Incomplete Nos.:			Less than 90 days old (Y/N):

2. TCEQ-0587 General Information Form

General Information Form

Texas Commission on Environmental Quality

For Regulated Activities on the Edwards Aquifer Recharge and Transition Zones and Relating to 30 TAC §213.4(b) & §213.5(b)(2)(A), (B) Effective June 1, 1999

To ensure that the application is administratively complete, confirm that all fields in the form are complete, verify that all requested information is provided, consistently reference the same site and contact person in all forms in the application, and ensure forms are signed by the appropriate party.

Note: Including all the information requested in the form and attachments contributes to more streamlined technical reviews.

Signature

To the best of my knowledge, the responses to this form accurately reflect all information requested concerning the proposed regulated activities and methods to protect the Edwards Aquifer. This **General Information Form** is hereby submitted for TCEQ review. The application was prepared by:

Print Name of Customer/Agent: Sergio Lozano, PE

Date: 10/20/2023

Signature of Customer/Agent:



Project Information

1. Regulated Entity Name: 15917 Great Oaks Drive
2. County: Williamson
3. Stream Basin: Lake Creek – Brushy Creek
4. Groundwater Conservation District (If applicable): N/A
5. Edwards Aquifer Zone:
 - Recharge Zone
 - Transition Zone
6. Plan Type:
 - WPAP
 - SCS
 - Modification
 - AST
 - UST
 - Exception Request

7. Customer (Applicant):

Contact Person: Hanumantharao Mekala

Entity: Creek Edge Peppers LLC

Mailing Address: 907 Screech Owl Dr

City, State: Pflugerville, TX

Zip: 78660.

Telephone: (978) 761-6525

FAX: N/A

Email Address: hanuma614@gmail.com

8. Agent/Representative (If any):

Contact Person: Cheryl L. Gudat

Entity: LOC Consultants

Mailing Address: 2211 S I-35 Frontage Rd #107

City, State: Austin, TX

Zip: 78741

Telephone: (512) 524-0677

FAX: N/A

Email Address: cheryloccivil@gmail.com

9. Project Location:

The project site is located inside the city limits of N/A.

The project site is located outside the city limits but inside the ETJ (extra-territorial jurisdiction) of Round Rock.

The project site is not located within any city's limits or ETJ.

10. The location of the project site is described below. The description provides sufficient detail and clarity so that the TCEQ's Regional staff can easily locate the project and site boundaries for a field investigation.

15917 S Great Oaks Dr is vacant land in Round Rock, TX 78681. This vacant land is a 1.793-acre lot near the corner of Great Oaks Drive and FM 620. Property has approximately 100 feet of frontage on Great Oaks Drive and extends behind the Jiffy Lube. The stores at the strip mall on 620 and Great Oaks adjacent to this property, include Bank of America, Primrose School of RR, Goodyear Tires, Subway, UPS, Twin Liquors, Sushi Ocean, and Jiffy Lube.

11. **Attachment A – Road Map.** A road map showing directions to and the location of the project site is attached. The project location and site boundaries are clearly shown on the map.

12. **Attachment B - USGS / Edwards Recharge Zone Map.** A copy of the official 7 ½ minute USGS Quadrangle Map (Scale: 1" = 2000') of the Edwards Recharge Zone is attached. The map(s) clearly show:

Project site boundaries.

USGS Quadrangle Name(s).

Boundaries of the Recharge Zone (and Transition Zone, if applicable).

Drainage path from the project site to the boundary of the Recharge Zone.

13. **The TCEQ must be able to inspect the project site or the application will be returned.**
Sufficient survey staking is provided on the project to allow TCEQ regional staff to locate the boundaries and alignment of the regulated activities and the geologic or manmade features noted in the Geologic Assessment.

Survey staking will be completed by this date: _____

14. **Attachment C – Project Description.** Attached at the end of this form is a detailed narrative description of the proposed project. The project description is consistent throughout the application and contains, at a minimum, the following details:

- Area of the site
- Offsite areas
- Impervious cover
- Permanent BMP(s)
- Proposed site use
- Site history
- Previous development
- Area(s) to be demolished

15. Existing project site conditions are noted below:

- Existing commercial site
- Existing industrial site
- Existing residential site
- Existing paved and/or unpaved roads
- Undeveloped (Cleared)
- Undeveloped (Undisturbed/Uncleared)
- Other: _____

Prohibited Activities

16. I am aware that the following activities are prohibited on the Recharge Zone and are not proposed for this project:

- Waste disposal wells regulated under 30 TAC Chapter 331 of this title (relating to Underground Injection Control);
- New feedlot/concentrated animal feeding operations, as defined in 30 TAC §213.3;
- Land disposal of Class I wastes, as defined in 30 TAC §335.1;
- The use of sewage holding tanks as parts of organized collection systems; and
- New municipal solid waste landfill facilities required to meet and comply with Type I standards which are defined in §330.41(b), (c), and (d) of this title (relating to Types of Municipal Solid Waste Facilities).
- New municipal and industrial wastewater discharges into or adjacent to water in the state that would create additional pollutant loading.

17. I am aware that the following activities are prohibited on the Transition Zone and are not proposed for this project:
- (1) Waste disposal wells regulated under 30 TAC Chapter 331 (relating to Underground Injection Control);
 - (2) Land disposal of Class I wastes, as defined in 30 TAC §335.1; and
 - (3) New municipal solid waste landfill facilities required to meet and comply with Type I standards which are defined in §330.41 (b), (c), and (d) of this title.

Administrative Information

18. The fee for the plan(s) is based on:
- For a Water Pollution Abatement Plan or Modification, the total acreage of the site where regulated activities will occur.
 - For an Organized Sewage Collection System Plan or Modification, the total linear footage of all collection system lines.
 - For a UST Facility Plan or Modification or an AST Facility Plan or Modification, the total number of tanks or piping systems.
 - A request for an exception to any substantive portion of the regulations related to the protection of water quality.
 - A request for an extension to a previously approved plan.
19. Application fees are due and payable at the time the application is filed. If the correct fee is not submitted, the TCEQ is not required to consider the application until the correct fee is submitted. Both the fee and the Edwards Aquifer Fee Form have been sent to the Commission's:
- TCEQ cashier
 - Austin Regional Office (for projects in Hays, Travis, and Williamson Counties)
 - San Antonio Regional Office (for projects in Bexar, Comal, Kinney, Medina, and Uvalde Counties)
20. Submit one (1) original and one (1) copy of the application, plus additional copies as needed for each affected incorporated city, groundwater conservation district, and county in which the project will be located. The TCEQ will distribute the additional copies to these jurisdictions. The copies must be submitted to the appropriate regional office.
21. No person shall commence any regulated activity until the Edwards Aquifer Protection Plan(s) for the activity has been filed with and approved by the Executive Director.

Attachment A – Road Map

WILLIAMSON COUNTY

15917 Great Oaks Drive



1 : 3,884



0.1 0 0.06 0.1 Miles

WGS_1984_Web_Mercator_Auxiliary_Sphere
© Latitude Geographics Group Ltd.; Williamson County, Texas 2015 Layout: 8.5 X 11 Inches

This map and data are for general planning purposes only. The licensee confirms to National Map Accuracy Standards to be maintained with Williamson County makes no warranty, representation or guarantee as to the content, relevance, accuracy, timeliness or completeness of any of the data or information or special features depicted. Furthermore, all warranties on availability and fitness for a particular purpose are hereby disclaimed. In no event shall Williamson County be liable to the recipient or any other party for damages of any type, including but not limited to incidental, consequential or exemplary damages arising out of the use or inability to use these materials.

THIS MAP IS NOT TO BE USED FOR NAVIGATION Created: 06/25/2020



Legend

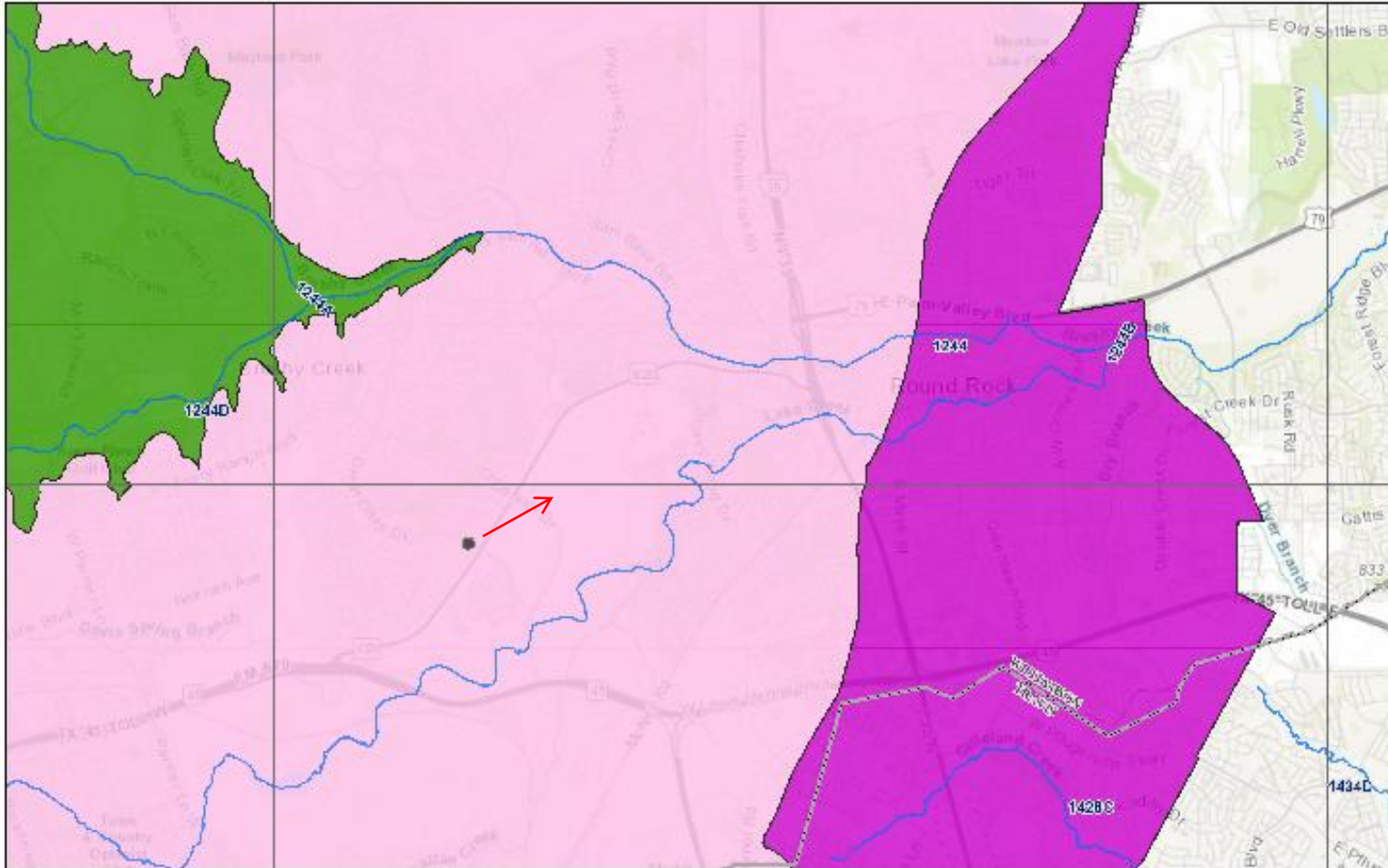
Streets

Notes

Attachment A
Road Map
15917 Great Oaks Drive
City of Round Rock
Williamson County, Texas

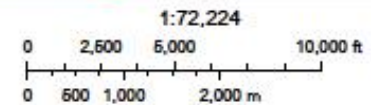
Attachment B - USGS / Edwards Recharge Zone Map

Edwards Aquifer Recharge Zone Map



6/27/2020, 1:21:43 PM

- Segments (Streams)
- TX Counties
- Edwards Aquifer
- Recharge Zone
- Transition Zone
- Contributing Zone
- Contributing Zone within the Transition Zone
- 7.5 Minute Quad Grid

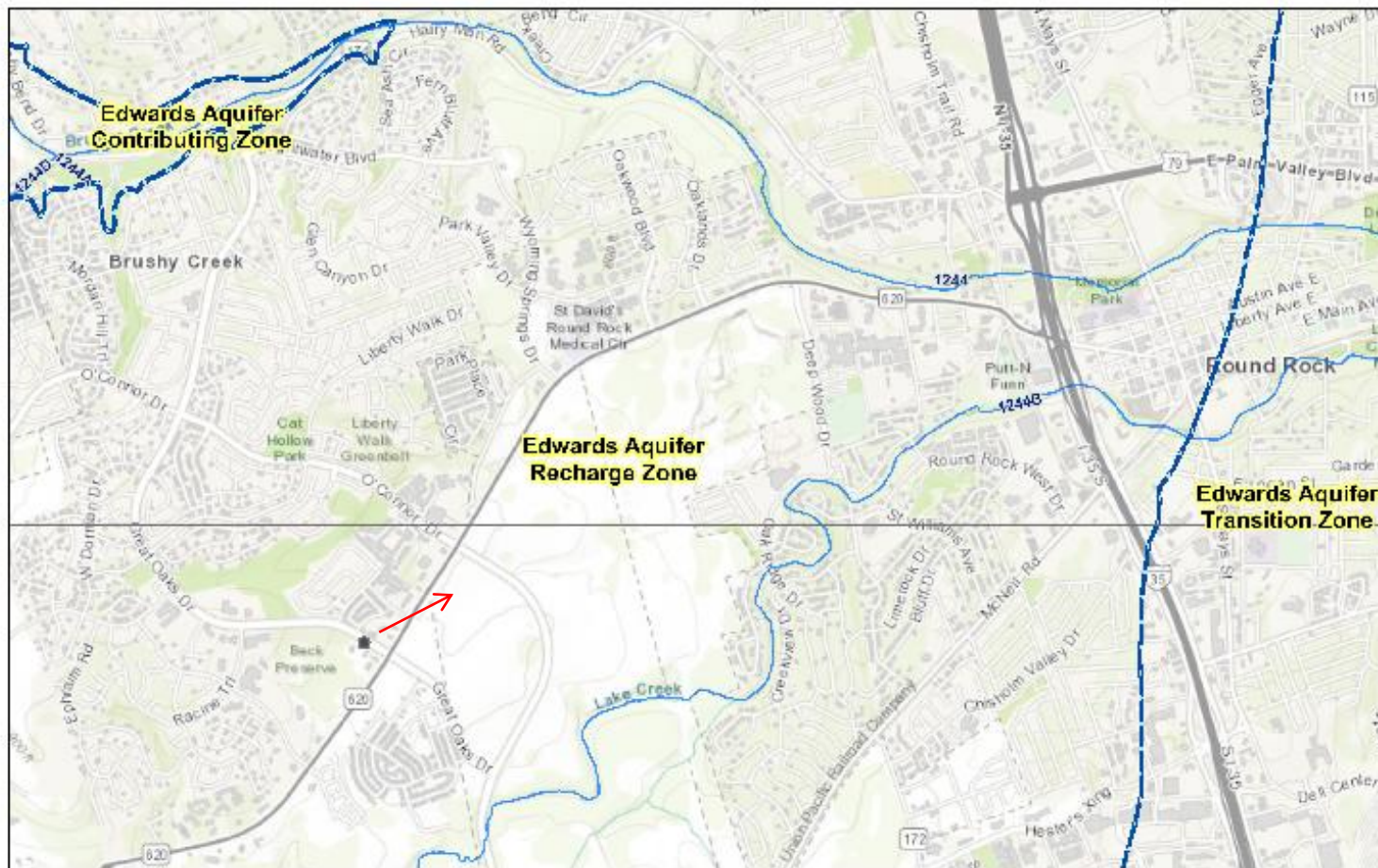


Sources: Earl, HERE, Garmin, Intelmap, Increment P Corp., GEBCO, USGS,

Web AppBuilder for ArcGIS

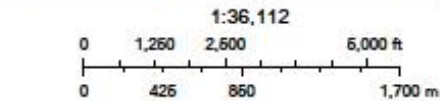
Austin Community College, City of Austin, County of Williamson, Texas Parks & Wildlife, Earl, HERE, Garmin, INCREMENT P, USGS, METINASA, NGA, EPA, USDA | TCEQ |

Edwards Aquifer Recharge Zone Map



6/27/2020, 1:20:36 PM

- Edwards Aquifer Boundary central line
- Segments (Streams)
- TX Counties
- Edwards Aquifer Label
- Edwards Aquifer Boundary
- 7.5 Minute Quad Grid



Sources: Esri, HERE, Garmin, Intermap, Increment P Corp., GEBCO, USGS,

Attachment C - Project Description

The proposed project is in the City of Round Rock ETJ, Williamson County, Texas. The property's address is 15917 S Great Oaks Dr, Round Rock, TX 78681. The property can also be identified as Lot 5 in Block A of Great Oaks/620 Commercial, a subdivision in Williamson County, TX. This vacant land is a 1.793-acre lot near the corner of Great Oaks Drive and FM 620. Property has approximately 100 feet of frontage on Great Oaks Drive and extends behind the Jiffy Lube. The stores at the strip mall on 620 and Great Oaks adjacent to this property, include Bank of America, Primrose School of RR, Goodyear Tires, Subway, UPS, Twin Liquors, Sushi Ocean, and Jiffy Lube.

An existing ± 2.20 -acre offsite drainage area from the west and south is conveyed through the site. The total proposed area for this project is 1.793 acres. The previously described property identified for development is currently undeveloped. The site is undisturbed and uncleared. The calculated existing impervious area is 0.25 acres which is made up of the existing concrete driveway correspondent to a reciprocal access easement. The proposed construction consists of nearly 24,100 square feet of office/warehouse space and a parking lot with 66 parking spaces. The proposed office/warehouse development will have an estimated 6.02 Living Unit Equivalents.

The proposed area to be disturbed is 1.793 acres with 1.41 acres (82%) of proposed impervious cover. The proposed construction will include minor grading for the parking areas and building pad, utility service lines and building infrastructure. The water quality goal is to remove 89% of the increased total suspended solids (TSS) from the proposed project area. As presented in the design calculations (Permanent Stormwater Section), this will be accomplished using sand filter system constructed in conjunction with the storm drainage system. The design calculations demonstrate that the proposed project adds approximately 1.16 acres of impervious cover and requires 1003 lbs. of TSS removal.

According to the Flood Insurance Rate Map No. 48491C0630F, effective on 12/20/2019 no portion of the subject site is located within the 100-year floodplain. Stormwater runoff will be treated with a sand filtration system. The sand filtration pond will ensure the quality of water exiting without adversely affecting the downstream drainage patterns. The treated stormwater is proposed to discharge into an existing underground storm drain system that conveys the runoff off-site.

A geologic assessment of the proposed project area was conducted by aci Group, LLC. pursuant to Texas rules for regulated activities on the Edwards Aquifer Recharge Zone (30 TAC 213). Assessment findings were used to develop recommendations for water pollution abatement measures intended to protect water resources at the site and adjacent areas. The project area is situated within the Edwards Aquifer Recharge Zone as defined by the TCEQ.

Temporary stormwater control measures will be used to mitigate soil loss in a manner that is consistent with best management practices (BMPs). This will include the use of sediment barriers, stabilized construction entrances, rock berms and sediment traps. See Temporary Stormwater Section for additional information.

3. TCEQ-0585 Geologic Assessment

Geologic Assessment

Texas Commission on Environmental Quality

For Regulated Activities on The Edwards Aquifer Recharge/transition Zones and Relating to 30 TAC §213.5(b)(3), Effective June 1, 1999

To ensure that the application is administratively complete, confirm that all fields in the form are complete, verify that all requested information is provided, consistently reference the same site and contact person in all forms in the application, and ensure forms are signed by the appropriate party.

Note: Including all the information requested in the form and attachments contributes to more streamlined technical reviews.

Signature

To the best of my knowledge, the responses to this form accurately reflect all information requested concerning the proposed regulated activities and methods to protect the Edwards Aquifer. My signature certifies that I am qualified as a geologist as defined by 30 TAC Chapter 213.

Print Name of Geologist: Mark T. Adams

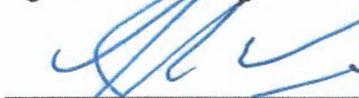
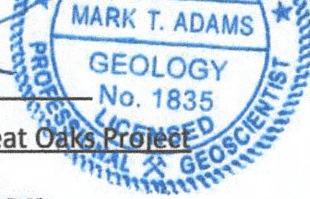
Telephone: 512-347-9000

Date: July 10, 2017

Fax: 512-306-0974

Representing: aci Group LLC TBPG License No. 50260 (Name of Company and TBPG or TBPE registration number)

Signature of Geologist:

Regulated Entity Name: Great Oaks Project

Project Information

1. Date(s) Geologic Assessment was performed: July 5, 2017

2. Type of Project:

WPAP

AST

SCS

UST

3. Location of Project:

Recharge Zone

Transition Zone

Contributing Zone within the Transition Zone

4. **Attachment A - Geologic Assessment Table.** Completed Geologic Assessment Table (Form TCEQ-0585-Table) is attached.
5. Soil cover on the project site is summarized in the table below and uses the SCS Hydrologic Soil Groups* (Urban Hydrology for Small Watersheds, Technical Release No. 55, Appendix A, Soil Conservation Service, 1986). If there is more than one soil type on the project site, show each soil type on the site Geologic Map or a separate soils map.

Table 1 - Soil Units, Infiltration Characteristics and Thickness

Soil Name	Group*	Thickness(feet)
Eckrant extremely stony clay, 0 to 3 percent slopes (EeB)	D	1.3

Soil Name	Group*	Thickness(feet)

** Soil Group Definitions (Abbreviated)*

- A. Soils having a high infiltration rate when thoroughly wetted.
- B. Soils having a moderate infiltration rate when thoroughly wetted.
- C. Soils having a slow infiltration rate when thoroughly wetted.
- D. Soils having a very slow infiltration rate when thoroughly wetted.

6. **Attachment B – Stratigraphic Column.** A stratigraphic column showing formations, members, and thicknesses is attached. The outcropping unit, if present, should be at the top of the stratigraphic column. Otherwise, the uppermost unit should be at the top of the stratigraphic column.
7. **Attachment C – Site Geology.** A narrative description of the site specific geology including any features identified in the Geologic Assessment Table, a discussion of the potential for fluid movement to the Edwards Aquifer, stratigraphy, structure(s), and karst characteristics is attached.
8. **Attachment D – Site Geologic Map(s).** The Site Geologic Map must be the same scale as the applicant's Site Plan. The minimum scale is 1": 400'
 Applicant's Site Plan Scale: 1" = 40'
 Site Geologic Map Scale: 1" = 40'
 Site Soils Map Scale (if more than 1 soil type): 1" = 100'
9. Method of collecting positional data:
 - Global Positioning System (GPS) technology.
 - Other method(s). Please describe method of data collection: _____
10. The project site and boundaries are clearly shown and labeled on the Site Geologic Map.

11. Surface geologic units are shown and labeled on the Site Geologic Map.
12. Geologic or manmade features were discovered on the project site during the field investigation. They are shown and labeled on the Site Geologic Map and are described in the attached Geologic Assessment Table.
- Geologic or manmade features were not discovered on the project site during the field investigation.
13. The Recharge Zone boundary is shown and labeled, if appropriate.
14. All known wells (test holes, water, oil, unplugged, capped and/or abandoned, etc.): If applicable, the information must agree with Item No. 20 of the WPAP Application Section.
- There are 0 (#) wells present on the project site and the locations are shown and labeled. (Check all of the following that apply.)
- The wells are not in use and have been properly abandoned.
- The wells are not in use and will be properly abandoned.
- The wells are in use and comply with 16 TAC Chapter 76.
- There are no wells or test holes of any kind known to exist on the project site.

Administrative Information

15. Submit one (1) original and one (1) copy of the application, plus additional copies as needed for each affected incorporated city, groundwater conservation district, and county in which the project will be located. The TCEQ will distribute the additional copies to these jurisdictions. The copies must be submitted to the appropriate regional office.



TABLE OF CONTENTS

1.0 INTRODUCTION	2
2.0 PROJECT INFORMATION	2
3.0 INVESTIGATION METHODS.....	2
4.0 SUMMARY OF FINDINGS.....	3
5.0 RECOMMENDATIONS	3
6.0 REFERENCES	4

LIST OF ATTACHMENTS

Attachment A –Geologic Assessment Table	5
Attachment B – Stratigraphic Column.....	7
Attachment C – Site Geology	9
Attachment D – Site Maps	13
Attachment E – Historical Aerial Photographs	18

July 10, 2017

Geologic Assessment for the Great Oaks Project located in Williamson County, Texas

1.0 INTRODUCTION

The purpose of this assessment is to identify karst or non-karst features and their recharge potential. This report complies with the requirements of Title 30, Texas Administrative Code (TAC) Chapter 213 relating to the protection of the Edwards aquifer recharge zone.

The Great Oaks Project, hereafter referred to as the subject area or site, is located at the intersection of RR 620 and Great Oaks Dr in the City of Round Rock Extraterritorial Jurisdiction (ETJ), Williamson County, Texas (**Attachment D, Figure 1**).

2.0 PROJECT INFORMATION

Pedestrian investigations of the subject area were performed on Wednesday, July 5, 2017, by Mark Adams, P.G.; Emily Mixon, and Luke Rome with **aci consulting**.

This report is intended to satisfy the requirements for a Geologic Assessment, which shall be included as a component of a Water Pollution Abatement Plan (WPAP) and Sewage Collection System (SCS). The proposed site use is for a surgery center. The scope of the report consists of a site reconnaissance, field survey, and review of existing data and reports. Features identified during the field survey were ranked utilizing the Texas Commission on Environmental Quality (TCEQ) matrix for Edwards aquifer recharge zone features. The ranking of the features will determine their viability as “sensitive” features.

According to Edwards aquifer zone maps, the entire subject area is within the northern segment of the Edwards aquifer Recharge Zone (TCEQ 2005).

3.0 INVESTIGATION METHODS

The following investigation methods and activities were used to develop this report:

- Review of existing files and literature to determine the regional geology and any known caves associated with the project area;

- Review of past geological field reports, cave studies, and correspondence regarding the existing geologic features on the project area, if available;
- Site reconnaissance by a registered professional geologist to identify and examine caves, recharge features, and other significant geological structures;
- Evaluation of collected field data and a ranking of features using the TCEQ Ranking Table 0585 for the Edwards Aquifer Recharge Zone; and
- Review of historic aerial photographs to determine if there are any structural features present, and to determine any past disturbances on the subject property.

4.0 SUMMARY OF FINDINGS

This report documents the findings of a geologic assessment conducted by **aci consulting** personnel on July 5, 2017, previous and subsequent field work. There was one feature identified within the subject property. It was determined that this feature, G01, is a fill-based epikarst feature and therefore is not sensitive, per the TCEQ Ranking Table 0585 for the Edwards Aquifer Recharge Zone.

5.0 RECOMMENDATIONS

No further actions are recommended as no sensitive karst features were found on the subject property.

6.0 REFERENCES

Fischer, W.L., 1992. Geologic Map of the Austin Area, Texas. Bureau of Economic Geology. Austin, Texas.

Garner, L.E., 1992. *Geologic Map of the Austin Area, Texas*. Bureau of Economic Geology. Austin, Texas.

Rodda, P.U. 1970. Geology of the Austin West Quadrangle, Travis County, Texas. University of Texas at Austin, Bureau of Economic Geology

(SCS) Soil Conservation Survey. 1983. Soil Survey of Williamson County, Texas. United States Department of Agriculture. Texas Agriculture Experiment Station.

(TCEQ) Texas Commission on Environmental Quality. 2004. Instructions to Geologists for Geologic Assessments on the Edwards Aquifer Recharge/Transition Zones. October 1, 2004. Austin, Texas.

(TCEQ) Texas Commission on Environmental Quality. 2005. "Edwards Aquifer Protection Program, Chapter 213 Rules - Recharge Zone, Transition Zone, Contributing Zone, and Contributing Zone within the Transition Zone." Map. Digital data. September 1, 2005. Austin, Texas.

(USDA NRCS) U.S. Department of Agriculture Natural Resources Conservation Service. 2017. WebSoilSurvey.com. Soil Survey Area: Williamson County, Texas. Date accessed: July 5, 2017.

ATTACHMENT A
Geologic Assessment Table

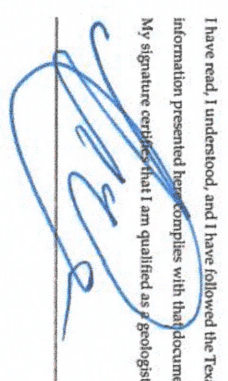
GEOLOGIC ASSESSMENT TABLE PROJECT NAME: **Great Oaks Project**

FEATURE ID	LOCATION			FEATURE CHARACTERISTICS						EVALUATION							
	1A	1B	1C	2A	2B	3	4	5	5A	6	7	8A	8B	9	10	11	12
	LATITUDE	LONGITUDE	FEATURE TYPE	POINTS	FORMATION	EMERSON/FEET	TREND DEGREES	DESIGN (FOOT)	AVERAGE (FEET)	INFILL	RELATIVE INDENTATION RATE	TOTAL	SENSITIVITY	CANTHMENT AREA (ACRES)	TOPOGRAPHY		
G01	30.493016	-97.727403	O	5	Ked	X	3	1	150	0	10	15	X	<1.6	>1.6	Hillside	

* DATUM: NAD 83

<p>2A TYPE</p> <p>C Cave</p> <p>SC Solution cavity</p> <p>SF Solution-enlarged fracture(s)</p> <p>F Fault</p> <p>O Other natural bedrock features</p> <p>MB Manmade feature in bedrock</p> <p>SW Swallow hole</p> <p>SH Sinkhole</p> <p>CD Non-karst closed depression</p> <p>Z Zone clustered or aligned features</p>	<p>TYPE</p>	<p>2B POINTS</p> <p>30</p> <p>20</p> <p>20</p> <p>20</p> <p>5</p> <p>30</p> <p>30</p> <p>20</p> <p>30</p>	<p>8A INFILLING</p> <p>N None, exposed bedrock</p> <p>C Coarse - cobbles, breakdown, sand, gravel</p> <p>O Loose or soft mud or soil, organics, leaves, sticks, dark colors</p> <p>F Fines, compacted clay-rich sediment, soil profile, gray or red colors</p> <p>V Vegetation. Give details in narrative description</p> <p>FS Flowstone, cements, cave deposits</p> <p>X Other materials</p>
--	-------------	---	--

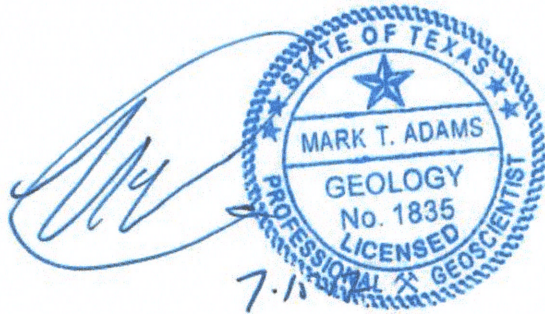
12 TOPOGRAPHY
Cliff, Hilltop, Hillside, Drainage, Floodplain, Streambed

I have read, I understand, and I have followed the Texas Commission on Environmental Quality's Instructions to Geologists. The information presented here complies with this document and is a true representation of the conditions observed in the field.
 My signature certifies that I am qualified as a geologist as defined by 30 TAC Chapter 213.
 Date 7/11/12

 Sheet 1 of 1
 TCEQ-0585-Table (Rev. 10-01-04)

ATTACHMENT B
Stratigraphic Column

Great Oaks Project, Williamson County

Formation	Members	Thickness
Edwards Limestone	Edwards Limestone	0-80 feet (on site)



Handwritten signature: *Mark T. Adams*
Professional seal: STATE OF TEXAS, MARK T. ADAMS, GEOLOGY, No. 1835, LICENSED, PROFESSIONAL GEOSCIENTIST
Handwritten date: 7.11

ATTACHMENT C
Site Geology

Locally, the dominant structural trend of the area is 15°, as evidenced by the mapped fault patterns (**Attachment D, Figure 2**). Thus, all features that have a trend ranging from 0° to 30° are considered on trend and were awarded the additional 10 points in the Geologic Assessment Table.

Based on the site assessment, the subject area is located in the Edwards Limestone (Ked) (**Attachment D, Figure 3**). The stratigraphy, structure, and karstic characteristics of the Edwards Limestone are discussed below.

Karstic Characteristics

In limestone terrains, karst is expressed by erratically developed cavernous porosity and the manifestations of sinkholes, voids, and erratic surface drainage. Karst landscapes are typical of the Edwards Limestone, occurring across a vast region of Central Texas, west of the Balcones Escarpment, and these processes are critical to understanding the Edwards aquifer within its various segments. The features produced by karst processes (voids, holes, and solution layers) eventually provide conduits for surface water runoff and “point recharge” for the Edwards aquifer. The identification and protection of these features in established recharge areas is critical to maintaining groundwater quality and species habitat. The TCEQ require protective strategies within these areas to maintain quantity and quality of recharge prior to, during, and upon completion of construction activities.

Stratigraphy

Ked – Edwards Limestone. Limestone, dolomitic limestone and marl. Massive to thin beds, chert, and fossiliferous; fossils include rudistids. Shallow subtidal to tidal-flat cycles. Honeycomb textures, voids in collapsed breccias, and cavern systems. Accounts for most of the Edwards aquifer strata. Thickness is between 100ft to 300ft regionally; thins northward (Rodda, 1970).

Structure

The subject area is underlain by Edwards Limestone (Ked) formation (Garner 1992). The geologic strata associated with the Edwards aquifer include the Georgetown Formations overlying the Edwards Limestone Group, interfingering with the Comanche Peak Formation. These rocks are underlain by the Walnut Formation, which has members including the Whitestone Member, Keys Valley Marl Member, the Cedar Park Member,

the Bee Cave Member and the Bull Creek Member. The Glen Rose Formation, another marine limestone stratum, is located below the Walnut Formation.

Review of historic aerials suggests that the site was used as undeveloped or agricultural land since before the first aerial dated 1941. Great Oaks Drive first appears in the 1981 aerial photo. Residential development as well as commercial development adjacent to the site first appeared in the 2004 aerial. Construction on a subdivision to the east first appears in the 2008 aerial photo. The subdivisions to the east first appear in the 2008 aerial, and construction is ongoing.

One feature, GO1, was identified during site investigations and is detailed below, and shown on **Figure 3 in Attachment D**.

Soils discussed on the Geologic Assessment Form are delineated in **Attachment D, Figure 4**.

GO1

GPS: N. 30.493016 W. -97.727403

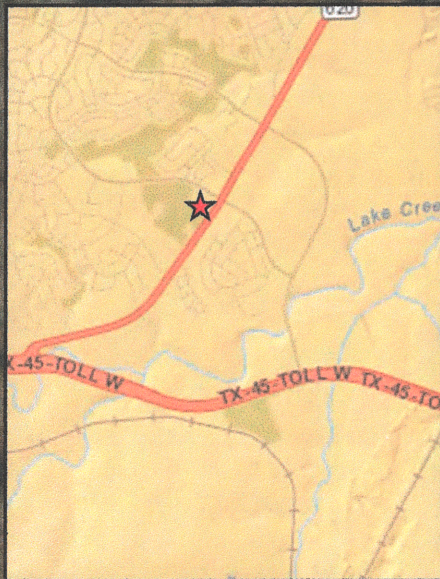
This feature is likely the result of previous disturbance associated with the water control structure adjacent to the property and therefore deemed not sensitive. The length, width and depth of this feature are 3.5 feet, 3 feet, and 1 foot, respectively. The feature is located in the Edwards Limestone and is positioned on a hillside. Infill material consists of cobbles, leaves, sticks and loose soil. The feature has a trend of 150°, and a drainage area of less than 1.6 acres. In using Figure 1 in Instructions to Geologists, it was determined that this feature has an infiltration rate of 10 points due to its lack of subsurface development and likely origin as human induced landscape modification.

Recommendation: No further action is recommended for this feature.

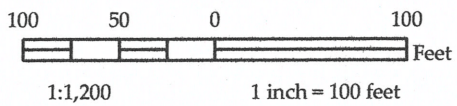


Photo of GO1

ATTACHMENT D
Site Maps



This map is intended for planning purposes only. All map data should be considered preliminary. All boundaries and designations are subject to confirmation.



 Subject Area

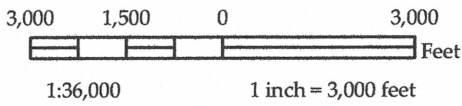


Great Oaks Project
Figure 1: Site Location

P:\Project\Folders\22-17-106_15917_Great Oaks\GIS\maps\CA_maps\F2-regional_trend.mxd



This map is intended for planning purposes only. All map data should be considered preliminary. All boundaries and designations are subject to confirmation.



Regional Trend = 15°

- Subject Area
- Faults 62K



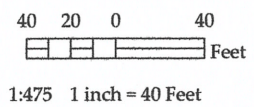
Great Oaks Project
 Figure 2: Regional Trend



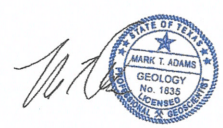
● Feature - GO1
Geologic Rock Unit (62K)
 Ked

■ 1% Annual Chance Flood Hazard
 ■ Regulatory Floodway
 ■ Special Floodway
 ■ Area of Undetermined Flood Hazard
 ■ 0.2% Annual Chance Flood Hazard
 ■ Future Conditions 1% Annual Chance Flood Hazard
 ■ Area with Reduced Risk Due to Levee

Ked




□ Subject Area
 ● Feature - GO1

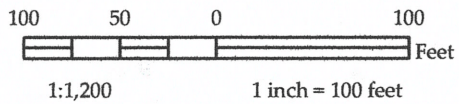




Williamson Co. Soils

 EeB

This map is intended for planning purposes only. All map data should be considered preliminary. All boundaries and designations are subject to confirmation.



 **Subject Area**



ATTACHMENT E
Historical Aerial Photographs

Prepared for:

ACI CONSULTING
1001 North Mopac Circle, #1000
Austin, TX 78746



Historical Aerial Photographs

15917 Great Oaks Dr

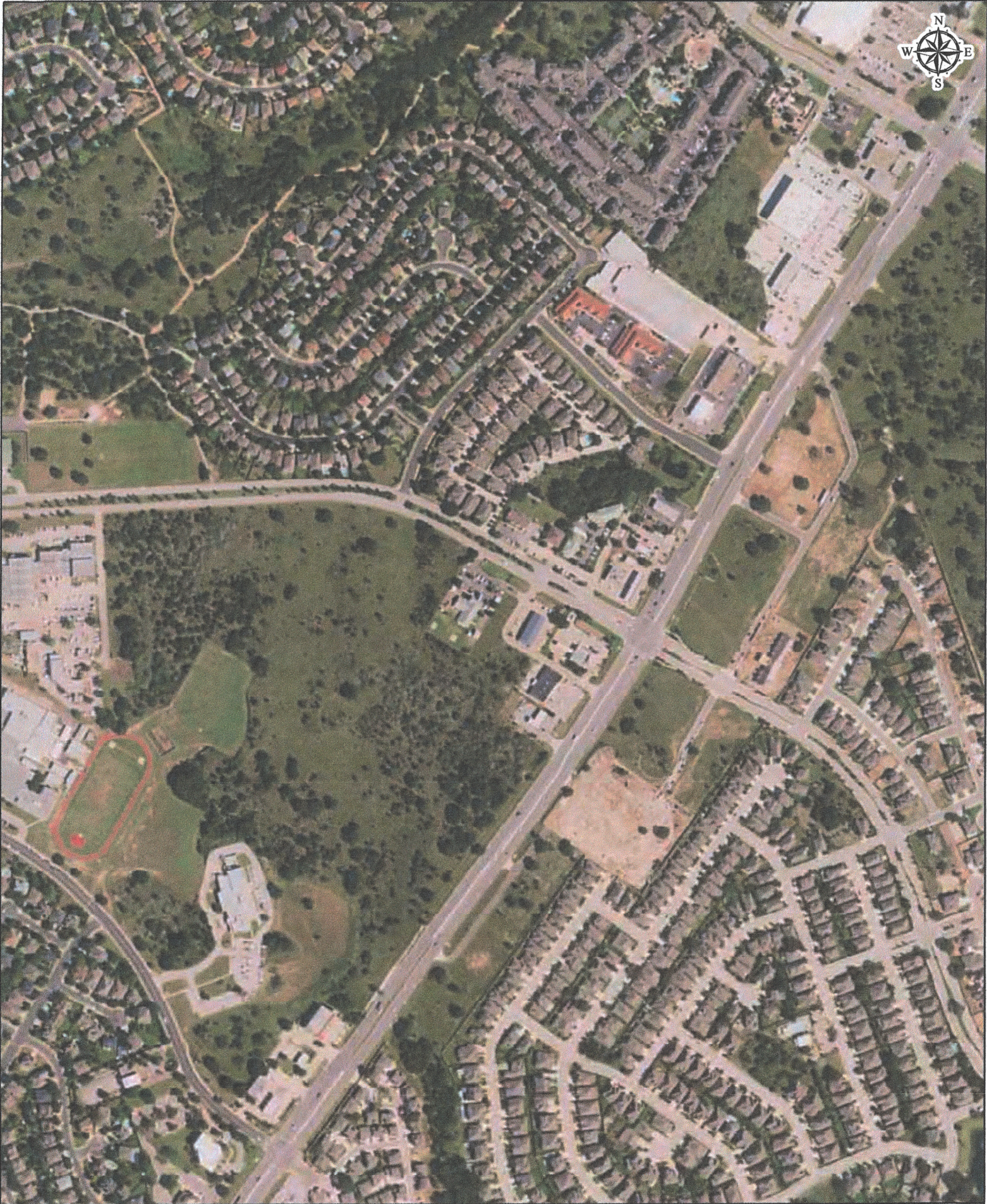
Round Rock, TX

Williamson County

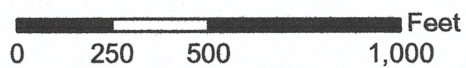
PO #: 22-17-106

ES-124824

Friday, June 30, 2017

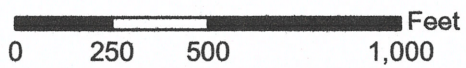


Date: 2016
Source: USDA



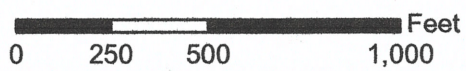


Date: 2012
Source: USDA



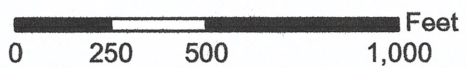


Date: 2008
Source: USDA



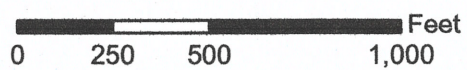


Date: 2004
Source: USDA



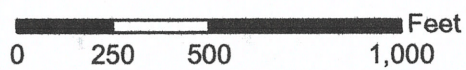


Date: 1995
Source: USGS



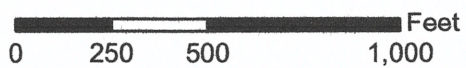


Date: 1988
Source: TXDOT



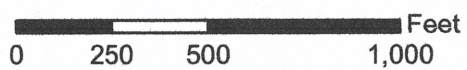


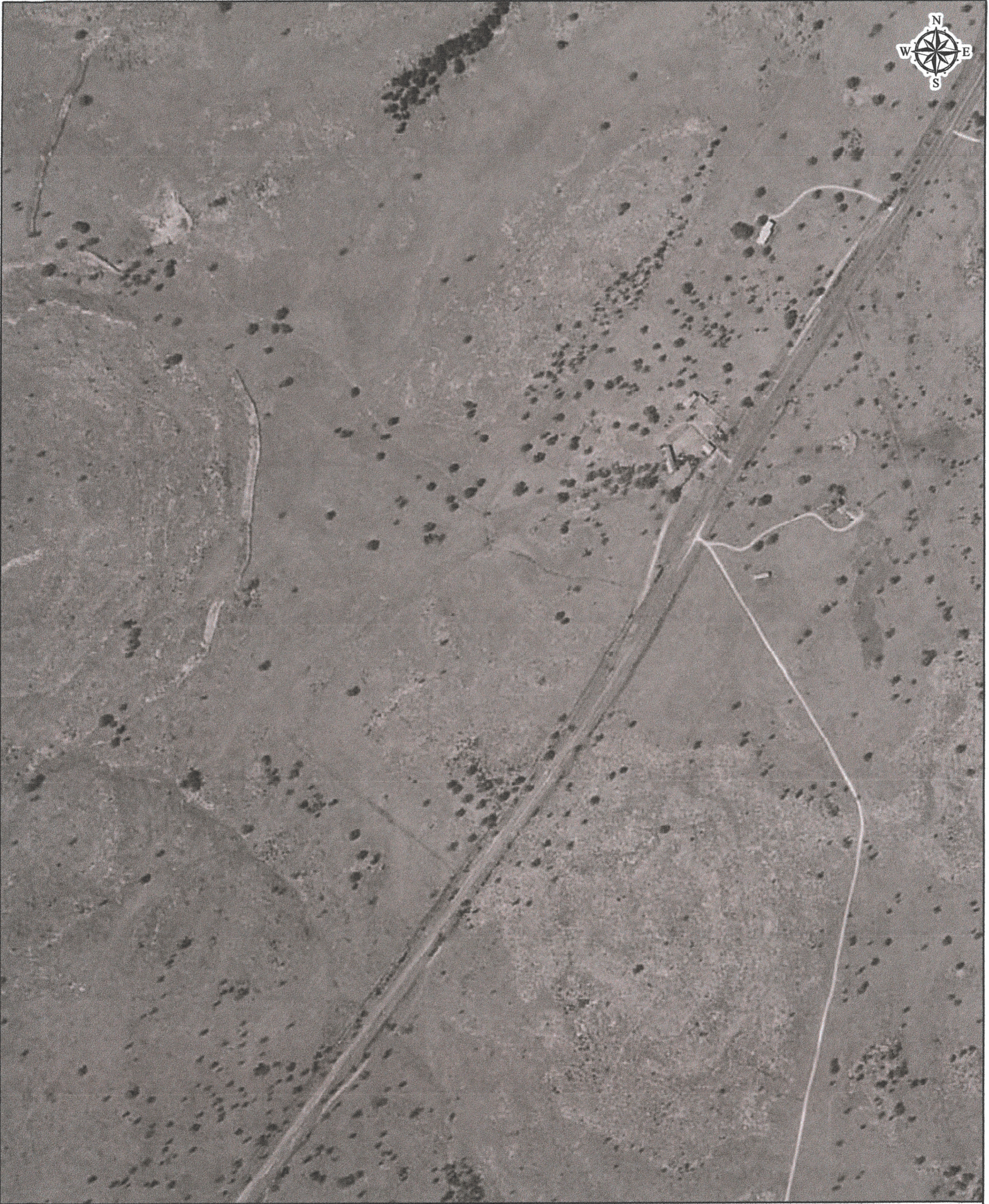
Date: 1981
Source: USGS



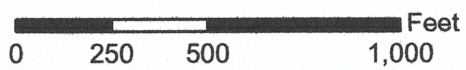


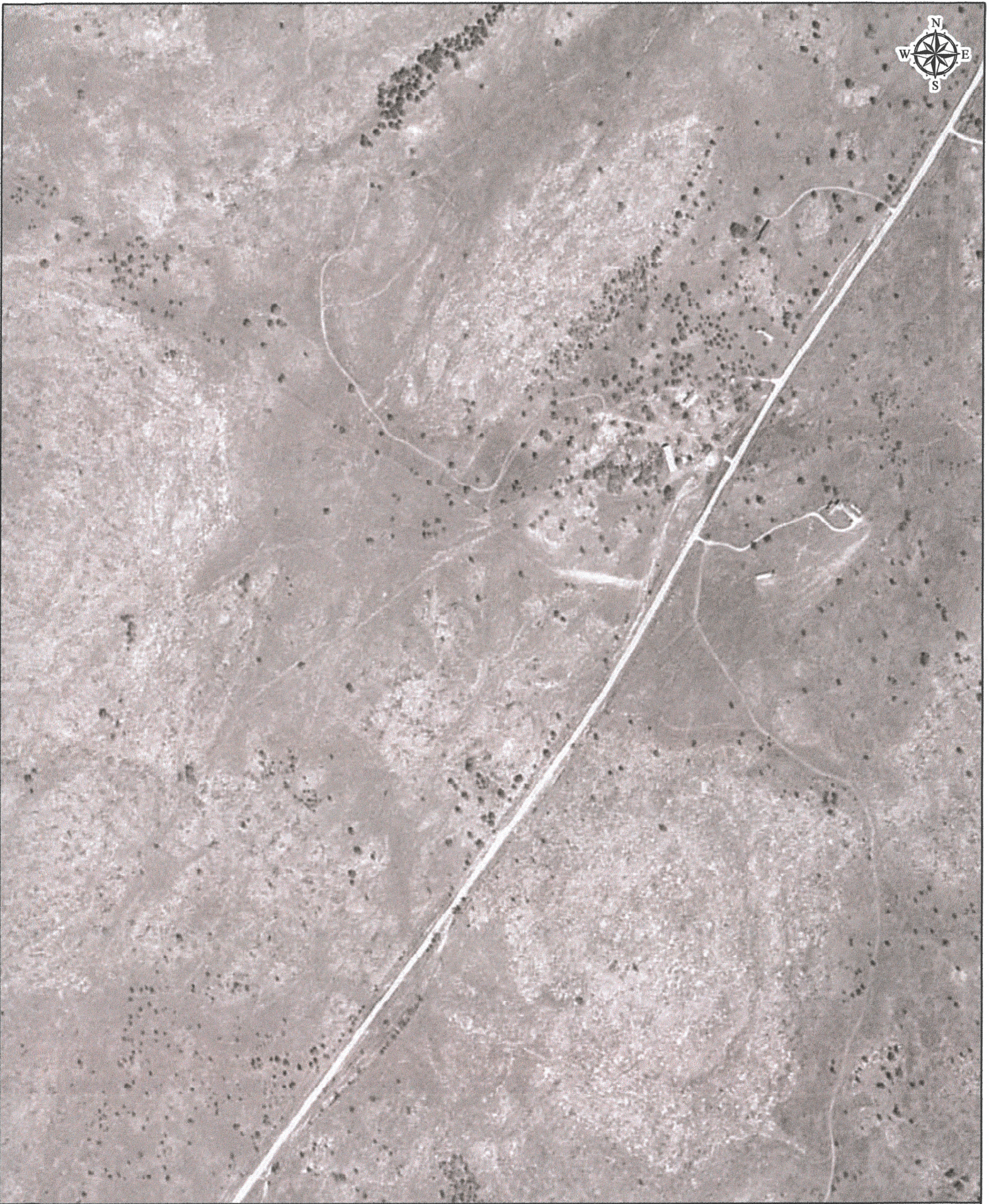
Date: 1973
Source: USGS



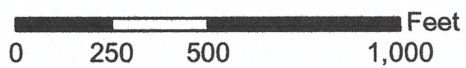


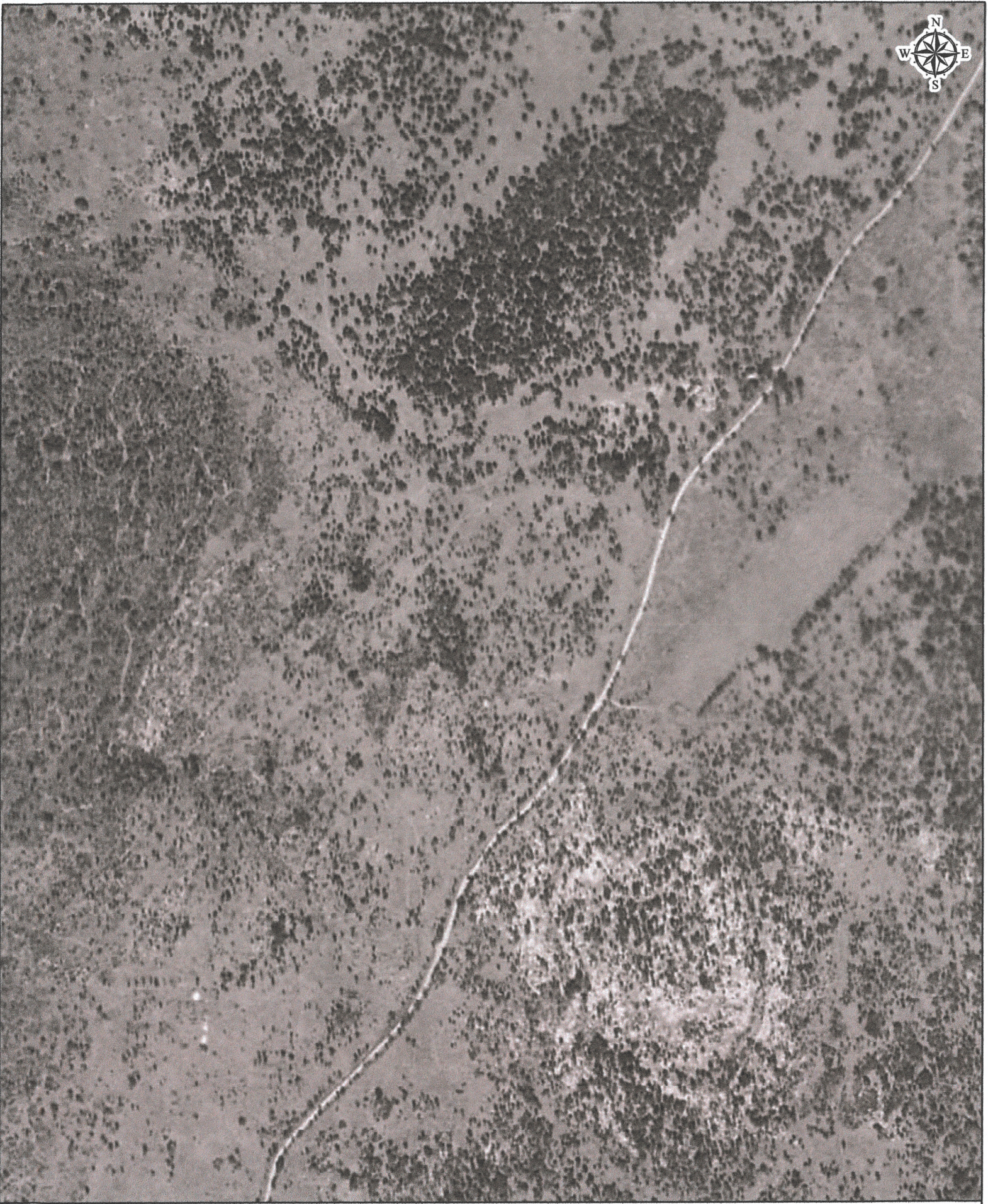
Date: 1967
Source: USGS



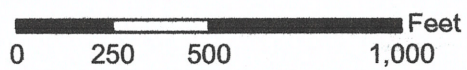


Date: 1954
Source: USGS





Date: 1941
Source: ASCS



HISTORICAL AERIAL PHOTO GRAPHS	
ES-124824	June 30, 2017



COPYRIGHT POLICY & DISCLAIMER

This report is solely for the limited use of the client and its customers. Banks Environmental Data, Inc. makes no warranties as to accuracy, validity, completeness, merchantability, quality, condition, suitability or fitness for a particular use or purpose in respect to this report and any information contained herein. All risk is assumed by the user. Banks Environmental Data, Inc. assumes no liability to any party for loss or damage whether rising out of errors or omissions, negligence, accident, or any other cause. In no event shall Banks Environmental Data, Inc., its affiliates or agents, be liable to anyone for special incidental, consequential or exemplary damages.

4. TCEQ-0584 Water Pollution Abatement Plan Application

Water Pollution Abatement Plan Application

Texas Commission on Environmental Quality

for Regulated Activities on the Edwards Aquifer Recharge Zone and Relating to 30 TAC §213.5(b), Effective June 1, 1999

To ensure that the application is administratively complete, confirm that all fields in the form are complete, verify that all requested information is provided, consistently reference the same site and contact person in all forms in the application, and ensure forms are signed by the appropriate party.

Note: Including all the information requested in the form and attachments contributes to more streamlined technical reviews.


Signature

To the best of my knowledge, the responses to this form accurately reflect all information requested concerning the proposed regulated activities and methods to protect the Edwards Aquifer. This **Water Pollution Abatement Plan Application Form** is hereby submitted for TCEQ review and Executive Director approval. The form was prepared by:

Print Name of Customer/Agent: Sergio N. Lozano-Sanchez, PE

Date: 10/20/2023

Signature of Customer/Agent:



Regulated Entity Name: 15917 Great Oaks Drive

Regulated Entity Information

1. The type of project is:

- Residential: Number of Lots: _____
- Residential: Number of Living Unit Equivalents: _____
- Commercial
- Industrial
- Other: _____

2. Total site acreage (size of property): 1.793

3. Estimated projected population: N/A

4. The amount and type of impervious cover expected after construction are shown below:

Table 1 - Impervious Cover Table

Impervious Cover of Proposed Project	Sq. Ft.	Sq. Ft./Acre	Acres
Structures/Rooftops	24,106.50	÷ 43,560 =	0.553
Parking	36,260.68	÷ 43,560 =	0.832
Other paved surfaces	3,609.42	÷ 43,560 =	0.083
Total Impervious Cover	63,976.60	÷ 43,560 =	1.469

Total Impervious Cover $\frac{1.47}{1.793} \times 100 = 82\%$ **Impervious Cover**

5. **Attachment A - Factors Affecting Surface Water Quality.** A detailed description of all factors that could affect surface water and groundwater quality that addresses ultimate land use is attached.
6. Only inert materials as defined by 30 TAC §330.2 will be used as fill material.

For Road Projects Only

Complete questions 7 - 12 if this application is exclusively for a road project.

7. Type of project:
 - TXDOT road project.
 - County road or roads built to county specifications.
 - City thoroughfare or roads to be dedicated to a municipality.
 - Street or road providing access to private driveways.
8. Type of pavement or road surface to be used:
 - Concrete
 - Asphaltic concrete pavement
 - Other: _____
9. Length of Right of Way (R.O.W.): _____ feet.
 Width of R.O.W.: _____ feet.
 $L \times W = \text{_____ Ft}^2 \div 43,560 \text{ Ft}^2/\text{Acre} = \text{_____ acres.}$
10. Length of pavement area: _____ feet.
 Width of pavement area: _____ feet.
 $L \times W = \text{_____ Ft}^2 \div 43,560 \text{ Ft}^2/\text{Acre} = \text{_____ acres.}$
 Pavement area _____ acres ÷ R.O.W. area _____ acres x 100 = _____% impervious cover.
11. A rest stop will be included in this project.
 A rest stop will not be included in this project.

12. Maintenance and repair of existing roadways that do not require approval from the TCEQ Executive Director. Modifications to existing roadways such as widening roads/adding shoulders totaling more than one-half (1/2) the width of one (1) existing lane require prior approval from the TCEQ.

Stormwater to be generated by the Proposed Project

13. **Attachment B - Volume and Character of Stormwater.** A detailed description of the volume (quantity) and character (quality) of the stormwater runoff which is expected to occur from the proposed project is attached. The estimates of stormwater runoff quality and quantity are based on the area and type of impervious cover. Include the runoff coefficient of the site for both pre-construction and post-construction conditions.

Wastewater to be generated by the Proposed Project

14. The character and volume of wastewater is shown below:

_____ % Domestic	_____ Gallons/day
<u>100</u> % Industrial	<u>1,686</u> Gallons/day
_____ % Commingled	_____ Gallons/day
TOTAL gallons/day <u>1,686</u>	

15. Wastewater will be disposed of by:

On-Site Sewage Facility (OSSF/Septic Tank):

Attachment C - Suitability Letter from Authorized Agent. An on-site sewage facility will be used to treat and dispose of the wastewater from this site. The appropriate licensing authority's (authorized agent) written approval is attached. It states that the land is suitable for the use of private sewage facilities and will meet or exceed the requirements for on-site sewage facilities as specified under 30 TAC Chapter 285 relating to On-site Sewage Facilities.

Each lot in this project/development is at least one (1) acre (43,560 square feet) in size. The system will be designed by a licensed professional engineer or registered sanitarian and installed by a licensed installer in compliance with 30 TAC Chapter 285.

Sewage Collection System (Sewer Lines):

Private service laterals from the wastewater generating facilities will be connected to an existing SCS.

Private service laterals from the wastewater generating facilities will be connected to a proposed SCS.

The SCS was previously submitted on _____.

The SCS was submitted with this application.

The SCS will be submitted at a later date. The owner is aware that the SCS may not be installed prior to Executive Director approval.

The sewage collection system will convey the wastewater to the Brushy Creek MUD WTF1 Treatment Plant. The treatment facility is:

- Existing.
 Proposed.

16. All private service laterals will be inspected as required in 30 TAC §213.5.

Site Plan Requirements

Items 17 – 28 must be included on the Site Plan.

17. The Site Plan must have a minimum scale of 1" = 400'.

Site Plan Scale: 1" = 30'.

18. 100-year floodplain boundaries:

Some part(s) of the project site is located within the 100-year floodplain. The floodplain is shown and labeled.

No part of the project site is located within the 100-year floodplain.

The 100-year floodplain boundaries are based on the following specific (including date of material) sources(s): FEMA, Flood Insurance Rate Map for Williamson County, Texas and Incorporated Areas, Panel Number 0495E, Map Number 48491C0630F, Revised December 20, 2019.

19. The layout of the development is shown with existing and finished contours at appropriate, but not greater than ten-foot contour intervals. Lots, recreation centers, buildings, roads, open space, etc. are shown on the plan.

The layout of the development is shown with existing contours at appropriate, but not greater than ten-foot intervals. Finished topographic contours will not differ from the existing topographic configuration and are not shown. Lots, recreation centers, buildings, roads, open space, etc. are shown on the site plan.

20. All known wells (oil, water, unplugged, capped and/or abandoned, test holes, etc.):

There are 0 (#) wells present on the project site and the locations are shown and labeled. (Check all of the following that apply)

The wells are not in use and have been properly abandoned.

The wells are not in use and will be properly abandoned.

The wells are in use and comply with 16 TAC §76.

There are no wells or test holes of any kind known to exist on the project site.

21. Geologic or manmade features which are on the site:

All sensitive geologic or manmade features identified in the Geologic Assessment are shown and labeled.

No sensitive geologic or manmade features were identified in the Geologic Assessment.

- Attachment D - Exception to the Required Geologic Assessment.** A request and justification for an exception to a portion of the Geologic Assessment is attached.
22. The drainage patterns and approximate slopes anticipated after major grading activities.
23. Areas of soil disturbance and areas which will not be disturbed.
24. Locations of major structural and nonstructural controls. These are the temporary and permanent best management practices.
25. Locations where soil stabilization practices are expected to occur.
26. Surface waters (including wetlands).
 N/A
27. Locations where stormwater discharges to surface water or sensitive features are to occur.
 There will be no discharges to surface water or sensitive features.
28. Legal boundaries of the site are shown.

Administrative Information

29. Submit one (1) original and one (1) copy of the application, plus additional copies as needed for each affected incorporated city, groundwater conservation district, and county in which the project will be located. The TCEQ will distribute the additional copies to these jurisdictions. The copies must be submitted to the appropriate regional office.
30. Any modification of this WPAP will require Executive Director approval, prior to construction, and may require submission of a revised application, with appropriate fees.

Attachment A - Factors Affecting Surface Water Quality

Water quality is affected by activities during and after construction. During construction, temporary controls will be in place to minimize the effects of construction. After construction, permanent controls will function to reduce the impact of the proposed development.

Construction activities that could potentially affect water quality include the disturbance of soil related to the construction of the building and parking lot, concrete truck washout, construction vehicle traffic, handling of construction equipment and materials, fuels, etc. Loose soil carries the risk of sediment pollution to natural water and the Aquifer. Temporary sediment barriers (silt fence) and a rock-lined stabilized construction entrance and exit will be used during construction to prevent sediment pollution. Other activities include the handling and disposal of waste materials, hazardous waste, and sanitary waste which pose a risk of contamination.

Permanent factors that impact water quality include future construction, landscape practices, runoff from on-site impervious cover, etc. The proposed development will have a sewage collection system consisting of private service laterals connecting to an existing SCS. The SCS for these laterals was submitted with this application. A water quality (sand filter) and detention pond constructed in conjunction with the storm drainage system will utilize enhanced gravity separation to promote separation of free oil and suspended solids from the water. The sand filters will capture and remove 89% of the total suspended solids loading anticipated by increases in impervious cover, per the Edwards Aquifer Rules as presented in the design calculations (Permanent Stormwater Section).

Attachment B - Volume and Character of Stormwater

Localized drainage considerations were made for onsite and offsite areas. Runoff will be drained using area inlets and storm drainpipes. Storm drain inlets are proposed to intercept water for this project and ultimately drains through proposed storm drainage infrastructure. The inlets were designed and located to meet the City of Round Rock storm drainage criteria.

The hydrology calculations for existing and proposed conditions are broken out in the tables below. Onsite stormwater will drain to an existing underground storm drain system that conveys runoff to an existing detention pond at the front of the site. Before entering the detention pond, stormwater will be treated via sand filtration.

Attachment C - Suitability Letter from Authorized Agent

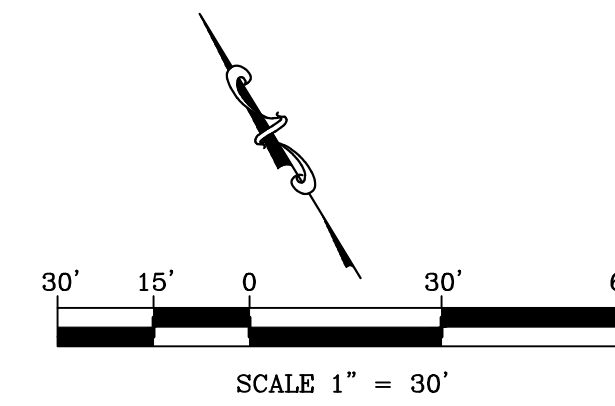
N/A. There is no proposed OSSF.

Attachment D - Exemption to the Required Geological Assessment

N/A. No exception will be requested.

GREAT OAKS DRIVE

100' R.O.W.



LEGEND

- PROPERTY LINE
- ADJACENT PROPERTY LINE
- ▭ PROPOSED BUILDING FOOTPRINT
- 832 EXISTING CONTOUR
- 832 PROPOSED CONTOUR
- WW --- WW --- WW EXISTING WASTEWATER LINE
- W --- W --- W EXISTING WATER LINE
- WW --- WW --- WW PROPOSED WASTEWATER LINE
- W --- W --- W PROPOSED WATER LINE
- --- --- PROPOSED STORMWATER LINE
- ⊙ EXISTING WASTEWATER MANHOLE
- ⊙ PROPOSED WASTEWATER MANHOLE
- ⊙ PROPOSED STORM DRAINAGE MANHOLE
- PROPOSED CLEANOUT
- ⊞ PROPOSED STORM BOX CONNECTION
- ▭ PROPOSED GRATE INLET
- ▭ PROPOSED TRENCH/SLOTTED DRAIN
- ⊕ EXISTING FIRE HYDRANT
- ⊕ PROPOSED FIRE HYDRANT

PARKING TABLE

PROPOSED REGULAR	77
PROPOSED COMPACT	6
PROPOSED ACCESSIBLE	6
TOTAL PROPOSED PARKING	89

PROJECT DESCRIPTION

THE PROJECT CONSIST OF THE CONSTRUCTION OF 2 OFFICE/WAREHOUSE BUILDINGS AND ASSOCIATED PARKING LOT.

SITE DATA TABLE

EXISTING USE:	VACANT
PROPOSED USE:	RETAIL, FLEX SPACE
GROSS SITE AREA:	78,103 Sq.Ft.
NO ZONING:	OUTSIDE CITY LIMITS
MINIMUM SITE AREA REQUIRED:	N/A
TOTAL GROSS FLOOR AREA:	24,106.50 SF
BUILDING COVERAGE:	24,106.50 SF
IMPERVIOUS COVER:	81.91%
FLOOR TO AREA RATIO:	0.31
FINISH FLOOR ELEV.:	831.58, 832.00, 833.08, 834.08
NO. OF STORIES:	ONE STORY
BUILDING HEIGHT:	TBD
EXISTING SQUARE FOOTAGE:	0 Sq.Ft
FOUNDATION TYPE:	SLAB ON GRADE
BUILDING CONSTRUCTION:	METAL BUILDING
MAX BLDG. ELEVATION:	N/A

IMPERVIOUS COVER CALCULATION

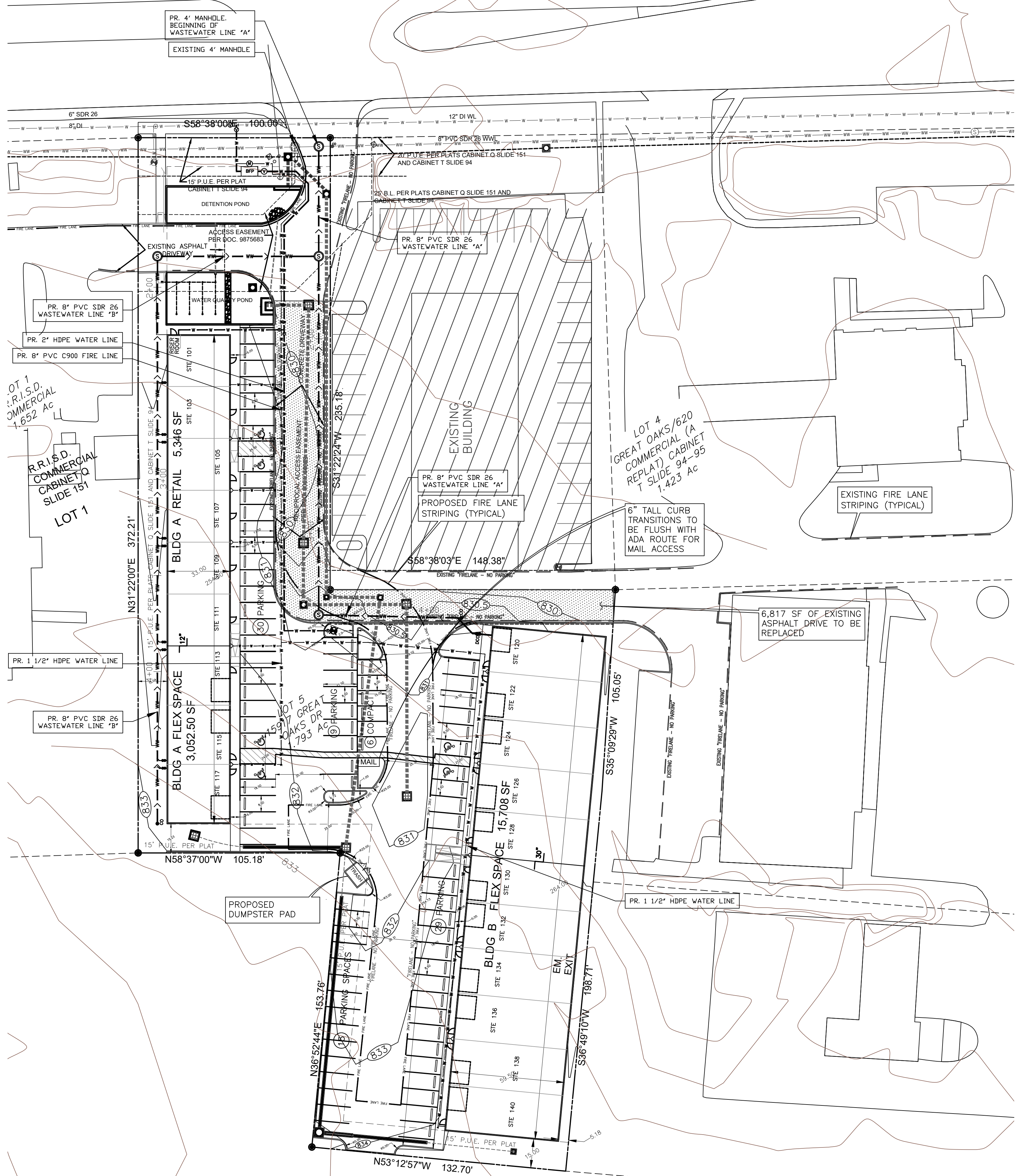
NET SITE AREA :	1,793 AC=	78,103	SF								
ZONED:											
FAR:											
	IMPERVIOUS COVER	EXISTING	%	DEMOLITION	%	PROPOSED	%	TOTAL	%		
	BUILDING/ROOF	SF	0.00	-	SF	0.00	24,106.50 SF	30.87	24,106.50 SF	30.87	
	CONCRETE	10,700.47 SF	13.70	-	SF	0.00	3,609.42 SF	4.62	14,309.89 SF	18.32	
	ASPHALT	-	SF	0.00	-	SF	0.00	25,560.21 SF	32.73	25,560.21 SF	32.73
	TOTAL	10,700.47 SF	13.70	-	SF	0.00	53,276.13 SF	68.21	63,976.60 SF	81.91	
	PERVIOUS COVER										
	GOOD GRASS	67,402.53 SF	86.30							14,126.40 SF	18.09

FIRE PROTECTION NOTE

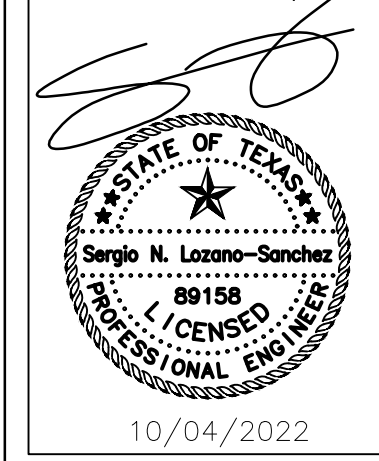
BUILDING #3 SHALL BE BROKEN UP BY FIRE WALLS AND KEEP THE UNDIVIDED AREAS BELOW 12,000 SQ.FT. TO AVOID THE NECESSITY OF INSTALLING A FIRE SPRINKLER SYSTEM.

ENGINEER'S CERTIFICATION

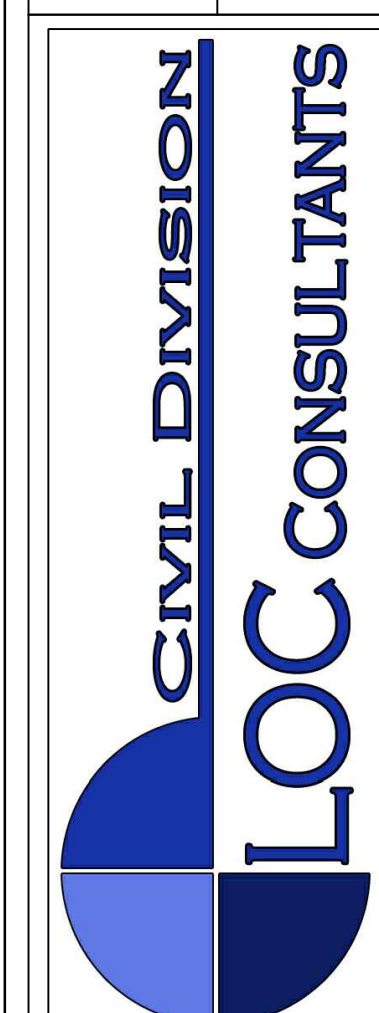
A CIVIL ENGINEER REGISTERED IN TEXAS MUST CERTIFY A PLAN OR PLAT AS COMPLETE, ACCURATE, AND IN COMPLIANCE WITH THE REQUIREMENTS OF THIS SUBCHAPTER THE DIRECTOR OF WATERSHED PROTECTION DEPARTMENT MAY WAIVE THIS REQUIREMENT AFTER MAKING A DETERMINATION THAT THE PLAN OR PLAT INCLUDES ONLY MINOR ALTERATIONS OR IMPROVEMENTS THAT DO NOT REQUIRE THE SERVICES OF AN ENGINEER.



NO.	DESCRIPTION



GREAT OAKS DR.
15917 GREAT OAKS DRIVE
SITE PLAN



SHEET:
04
OF 17

5. TCEQ-0582 Organized Sewage Collection System

Organized Sewage Collection System Application

Texas Commission on Environmental Quality

For Regulated Activities on the Edwards Aquifer Recharge Zone and Relating to 30 TAC §213.5(c), Effective June 1, 1999

To ensure that the application is administratively complete, confirm that all fields in the form are complete, verify that all requested information is provided, consistently reference the same site and contact person in all forms in the application, and ensure forms are signed by the appropriate party.

Note: Including all the information requested in the form and attachments contributes to more streamlined technical reviews.

Regulated Entity Name: 15917 Great Oaks Drive

1. **Attachment A – SCS Engineering Design Report.** This Engineering Design Report is provided to fulfill the requirements of 30 TAC Chapter 217, including 217.10 of Subchapter A, §§217.51 – 217.70 of Subchapter C, and Subchapter D as applicable, and is required to be submitted with this SCS Application Form.

Customer Information

2. The entity and contact person responsible for providing the required engineering certification of testing for this sewage collection system upon completion (including private service connections) and every five years thereafter to the appropriate TCEQ region office pursuant to 30 TAC §213.5(c) is:

Contact Person: Hanumantharao Mekala

Entity: Creek Edge Peppers LLC

Mailing Address: 907 Screech Owl Dr

City, State: Pflugerville, TX

Zip: 78660

Telephone: (978)761-6525

Fax: N/A

Email Address: hanuma614@gmail.com

The appropriate regional office must be informed of any changes in this information within 30 days of the change.

3. The engineer responsible for the design of this sewage collection system is:

Contact Person: Sergio Lozano

Texas Licensed Professional Engineer's Number: 89158

Entity: LOC Consultants

Mailing Address: 2211 S I-35 Frontage Rd #107

City, State: Austin, TX

Zip: 78741

Telephone: (512) 524-0677

Fax: N/A

Email Address: sergio@loccivil.com

Project Information

4. Anticipated type of development to be served (estimated future population to be served, plus adequate allowance for institutional and commercial flows):

- Residential: Number of single-family lots: _____
- Multi-family: Number of residential units: _____
- Commercial
- Industrial
- Off-site system (not associated with any development)
- Other: _____

5. The character and volume of wastewater is shown below:

_____ % Domestic	_____ gallons/day
<u>100</u> % Industrial	<u>1,686</u> gallons/day
_____ % Commingled	_____ gallons/day
Total gallons/day: <u>1,686</u>	

6. Existing and anticipated infiltration/inflow is 1,345 gallons/day. This will be addressed by: Independent off-site and on-site underground stormwater lines for mitigation. Following the recommendations of TCEQ for joints for gravity pipes & manholes (structure, cover, inlets & bases).

7. A Water Pollution Abatement Plan (WPAP) is required for construction of any associated commercial, industrial or residential project located on the Recharge Zone.

- The WPAP application for this development was approved by letter dated _____. A copy of the approval letter is attached.
- The WPAP application for this development was submitted to the TCEQ on _____, but has not been approved.
- A WPAP application is required for an associated project, but it has not been submitted.
- There is no associated project requiring a WPAP application.

8. Pipe description:

Table 1 - Pipe Description

<i>Pipe Diameter(Inches)</i>	<i>Linear Feet (1)</i>	<i>Pipe Material (2)</i>	<i>Specifications (3)</i>
8	318.06	PVC SDR-26	ASTM D3034
8	379.16	PVC SDR-26	ASTM D3034

Total Linear Feet: 697.22

(1) Linear feet - Include stub-outs and double service connections. Do not include private service laterals.

(2) Pipe Material - If PVC, state SDR value.

(3) Specifications - ASTM / ANSI / AWWA specification and class numbers should be included.

9. The sewage collection system will convey the wastewater to the Brushy Creek Regional Wastewater (name) Treatment Plant. The treatment facility is:

- Existing
 Proposed

10. All components of this sewage collection system will comply with:

- The City of Round Rock standard specifications.
 Other. Specifications are attached.

11. No force main(s) and/or lift station(s) are associated with this sewage collection system.
 A force main(s) and/or lift station(s) is associated with this sewage collection system and the **Lift Station/Force Main System Application** form (TCEQ-0624) is included with this application.

Alignment

12. There are no deviations from uniform grade in this sewage collection system without manholes and with open cut construction.

13. There are no deviations from straight alignment in this sewage collection system without manholes.

Attachment B - Justification and Calculations for Deviation in Straight Alignment without Manholes. A justification for deviations from straight alignment in this sewage collection system without manholes with documentation from pipe manufacturer allowing pipe curvature is attached.

For curved sewer lines, all curved sewer line notes (TCEQ-0596) are included on the construction plans for the wastewater collection system.

Manholes and Cleanouts

14. Manholes or clean-outs exist at the end of each sewer line(s). These locations are listed below: (Please attach additional sheet if necessary)

Table 2 - Manholes and Cleanouts

<i>Line</i>	<i>Shown on Sheet</i>	<i>Station</i>	<i>Manhole or Clean-out?</i>
WW Main "A"	13 Of 17	1+00.00	Manhole
WW Main "A"	13 Of 17	1+57.19	Manhole
WW Main "A"	13 Of 17	3+43.78	Manhole
WW Main "A"	13 Of 17	4+18.06	Cleanout
WW Main "B"	13 Of 17	1+83.92	Manhole
WW Main "B"	13 Of 17	4+79.16	Cleanout

<i>Line</i>	<i>Shown on Sheet</i>	<i>Station</i>	<i>Manhole or Clean-out?</i>
NA	Of		
NA	Of		
NA	Of		
NA	Of		

15. Manholes are installed at all Points of Curvature and Points of Termination of a sewer line.
16. The maximum spacing between manholes on this project for each pipe diameter is no greater than:

Pipe Diameter (inches)	Max. Manhole Spacing (feet)
6 - 15	500
16 - 30	800
36 - 48	1000
≥54	2000

- Attachment C – Justification for Variance from Maximum Manhole Spacing.** The maximum spacing between manholes on this project (for each pipe diameter used) is greater than listed in the table above. A justification for any variance from the maximum spacing is attached, and must include a letter from the entity which will operate and maintain the system stating that it has the capability to maintain lines with manhole spacing greater than the allowed spacing.
17. All manholes will be monolithic, cast-in-place concrete.
- The use of pre-cast manholes is requested for this project. The manufacturer's specifications and construction drawings, showing the method of sealing the joints, are attached.

Site Plan Requirements

Items 18 - 25 must be included on the Site Plan.

18. The Site Plan must have a minimum scale of 1" = 400'.
Site Plan Scale: 1" = 30'.
19. The Site Plan must include the sewage collection system general layout, including manholes with station numbers, and sewer pipe stub outs (if any). Site plan must be overlain by topographic contour lines, using a contour interval of not greater than ten feet and showing the area within both the five-year floodplain and the 100-year floodplain of any drainage way.
20. Lateral stub-outs:
 The location of all lateral stub-outs are shown and labeled.

- No lateral stub-outs will be installed during the construction of this sewer collection system.

21. Location of existing and proposed water lines:

- The entire water distribution system for this project is shown and labeled.
- If not shown on the Site Plan, a Utility Plan is provided showing the entire water and sewer systems.
- There will be no water lines associated with this project.

22. 100-year floodplain:

- After construction is complete, no part of this project will be in or cross a 100-year floodplain, either naturally occurring or manmade. (Do not include streets or concrete-lined channels constructed above of sewer lines.)
- After construction is complete, all sections located within the 100-year floodplain will have water-tight manholes. These locations are listed in the table below and are shown and labeled on the Site Plan. (Do not include streets or concrete-lined channels constructed above sewer lines.)

Table 3 - 100-Year Floodplain

<i>Line</i>	<i>Sheet</i>	<i>Station</i>
NA	of	to
NA	of	to
NA	of	to
NA	of	to

23. 5-year floodplain:

- After construction is complete, no part of this project will be in or cross a 5-year floodplain, either naturally occurring or man-made. (Do not include streets or concrete-lined channels constructed above sewer lines.)
- After construction is complete, all sections located within the 5-year floodplain will be encased in concrete or capped with concrete. These locations are listed in the table below and are shown and labeled on the Site Plan. (Do not include streets or concrete-lined channels constructed above sewer lines.)

Table 4 - 5-Year Floodplain

<i>Line</i>	<i>Sheet</i>	<i>Station</i>
NA	of	to
NA	of	to
NA	of	to
NA	of	to

- 24. Legal boundaries of the site are shown.

25. The **final plans and technical specifications** are submitted for the TCEQ's review. Each sheet of the construction plans and specifications are dated, signed, and sealed by the Texas Licensed Professional Engineer responsible for the design on each sheet.

Items 26 - 33 must be included on the Plan and Profile sheets.

26. All existing or proposed water line crossings and any parallel water lines within 9 feet of sewer lines are listed in the table below. These lines must have the type of pressure rated pipe to be installed shown on the plan and profile sheets. Any request for a variance from the required pressure rated piping at crossings must include a variance approval from 30 TAC Chapter 290.

There will be no water line crossings.

There will be no water lines within 9 feet of proposed sewer lines.

Table 5 - Water Line Crossings

<i>Line</i>	<i>Station or Closest Point</i>	<i>Crossing or Parallel</i>	<i>Horizontal Separation Distance</i>	<i>Vertical Separation Distance</i>
WW Main "A"	1+19.80	Parallel	4.57	-
WW Main "A"	1+26.26	Parallel	4.57	-
WW Main "A"	3+43.78	Parallel	5.45	-
WW Main "A"	3+47.07	Parallel	7.43	-
WW Main "B"	1+18.00	Crossing	-	3.82
WW Main "B"	1+19.50	Crossing	-	3.82

27. Vented Manholes:

No part of this sewer line is within the 100-year floodplain and vented manholes are not required by 30 TAC Chapter 217.

A portion of this sewer line is within the 100-year floodplain and vented manholes will be provided at less than 1500 foot intervals. These water-tight manholes are listed in the table below and labeled on the appropriate profile sheets.

A portion of this sewer line is within the 100-year floodplain and an alternative means of venting shall be provided at less than 1500 feet intervals. A description of the alternative means is described on the following page.

A portion of this sewer line is within the 100-year floodplain; however, there is no interval longer than 1500 feet located within. No vented manholes will be used.

Table 6 - Vented Manholes

<i>Line</i>	<i>Manhole</i>	<i>Station</i>	<i>Sheet</i>
NA			
NA			
NA			

<i>Line</i>	<i>Manhole</i>	<i>Station</i>	<i>Sheet</i>
NA			
NA			
NA			

28. Drop manholes:

- There are no drop manholes associated with this project.
- Sewer lines which enter new or existing manholes or "manhole structures" higher than 24 inches above the manhole invert are listed in the table below and labeled on the appropriate profile sheets. These lines meet the requirements of 30 TAC §217.55(l)(2)(H).

Table 7 - Drop Manholes

<i>Line</i>	<i>Manhole</i>	<i>Station</i>	<i>Sheet</i>
WW Main "A"	PR-MH-04	1+83.92	13
NA			
NA			
NA			
NA			
NA			

29. Sewer line stub-outs (For proposed extensions):

- The placement and markings of all sewer line stub-outs are shown and labeled.
- No sewer line stub-outs are to be installed during the construction of this sewage collection system.

30. Lateral stub-outs (For proposed private service connections):

- The placement and markings of all lateral stub-outs are shown and labeled.
- No lateral stub-outs are to be installed during the construction of this sewage collection system.

31. Minimum flow velocity (From Appendix A)

- Assuming pipes are flowing full; all slopes are designed to produce flows equal to or greater than 2.0 feet per second for this system/line.

32. Maximum flow velocity/slopes (From Appendix A)

- Assuming pipes are flowing full, all slopes are designed to produce maximum flows of less than or equal to 10 feet per second for this system/line.
- Attachment D – Calculations for Slopes for Flows Greater Than 10.0 Feet per Second.** Assuming pipes are flowing full, some slopes produce flows which are greater than 10 feet per second. These locations are listed in the table below. Calculations are attached.

Table 8 - Flows Greater Than 10 Feet per Second

<i>Line</i>	<i>Profile Sheet</i>	<i>Station to Station</i>	<i>FPS</i>	<i>% Slope</i>	<i>Erosion/Shock Protection</i>
NA					
NA					
NA					

33. Assuming pipes are flowing full, where flows are ≥ 10 feet per second, the provisions noted below have been made to protect against pipe displacement by erosion and/or shock under 30 TAC §217.53(l)(2)(B).

- Concrete encasement shown on appropriate Plan and Profile sheets for the locations listed in the table above.
- Steel-reinforced, anchored concrete baffles/retards placed every 50 feet shown on appropriate Plan and Profile sheets for the locations listed in the table above.
- N/A

Administrative Information

34. The final plans and technical specifications are submitted for TCEQ review. Each sheet of the construction plans and specifications are dated, signed, and sealed by the Texas Licensed Professional Engineer responsible for the design on each sheet.
35. Standard details are shown on the detail sheets, which are dated, signed, and sealed by the Texas Licensed Professional Engineer, as listed in the table below:

Table 9 - Standard Details

<i>Standard Details</i>	<i>Shown on Sheet</i>
Lateral stub-out marking [Required]	13 of 17
Manhole, showing inverts comply with 30 TAC §217.55(l)(2) [Required]	13 of 17
Alternate method of joining lateral to existing SCS line for potential future connections [Required]	NA of
Typical trench cross-sections [Required]	14 of 17
Bolted manholes [Required]	NA of
Sewer Service lateral standard details [Required]	14 of 17
Clean-out at end of line [Required, if used]	14 of 17

Standard Details	Shown on Sheet
Baffles or concrete encasement for shock/erosion protection [Required, if flow velocity of any section of pipe >10 fps]	NA of
Detail showing Wastewater Line/Water Line Crossing [Required, if crossings are proposed]	14 of 17
Mandrel detail or specifications showing compliance with 30 TAC §217.57(b) and (c) [Required, if Flexible Pipe is used]	14 of 17
Drop manholes [Required, if a pipe entering a manhole is more than 24 inches above manhole invert]	14 of 17

36. All organized sewage collection system general construction notes (TCEQ-0596) are included on the construction plans for this sewage collection system.
37. All proposed sewer lines will be sufficiently surveyed/staked to allow an assessment prior to TCEQ executive director approval. If the alignments of the proposed sewer lines are not walkable on that date, the application will be deemed incomplete and returned.
- Survey staking was completed on this date: _____
38. Submit one (1) original and one (1) copy of the application, plus additional copies as needed for each affected incorporated city, groundwater conservation district, and county in which the project will be located. The TCEQ will distribute the additional copies to these jurisdictions. The copies must be submitted to the appropriate regional office.
39. Any modification of this SCS application will require TCEQ approval, prior to construction, and may require submission of a revised application, with appropriate fees.

Signature

To the best of my knowledge, the responses to this form accurately reflect all information requested concerning the proposed regulated activities and methods to protect the Edwards Aquifer. This **Organized Sewage Collection System Application** is hereby submitted for TCEQ review and executive director approval. The system was designed in accordance with the requirements of 30 TAC §213.5(c) and 30 TAC §217 and prepared by:

Print Name of Licensed Professional Engineer: Sergio Lozano-Sanchez, P.E.

Date: 10/20/2023

Place engineer's seal here:



10/20/2023

Signature of Licensed Professional Engineer:

A handwritten signature in blue ink, consisting of stylized, overlapping loops and lines, positioned above a horizontal line.

Appendix A-Flow Velocity Table

Flow Velocity (Flowing Full) All gravity sewer lines on the Edwards Aquifer Recharge Zone shall be designed and constructed with hydraulic slopes sufficient to give a velocity when flowing full of not less than 2.0 feet per second, and not greater than 10 feet per second. The grades shown in the following table are based on Manning's formula and an n factor of 0.013 and shall be the minimum and maximum acceptable slopes unless provisions are made otherwise.

Table 10 - Slope Velocity

<i>Pipe Diameter(Inches)</i>	<i>% Slope required for minimum flow velocity of 2.0 fps</i>	<i>% Slope which produces flow velocity of 10.0 fps</i>
6	0.50	12.35
8	0.33	8.40
10	0.25	6.23
12	0.20	4.88
15	0.15	3.62
18	0.11	2.83
21	0.09	2.30
24	0.08	1.93
27	0.06	1.65
30	0.055	1.43
33	0.05	1.26

Pipe Diameter(Inches)	% Slope required for minimum flow velocity of 2.0 fps	% Slope which produces flow velocity of 10.0 fps
36	0.045	1.12
39	0.04	1.01
>39	*	*

**For lines larger than 39 inches in diameter, the slope may be determined by Manning's formula (as shown below) to maintain a minimum velocity greater than 2.0 feet per second when flowing full and a maximum velocity less than 10 feet per second when flowing full.*

$$v = \frac{1.49}{n} \times R_h^{0.67} \times \sqrt{S}$$

Figure 1 - Manning's Formula

Where:

v = velocity (ft/sec)

n = Manning's roughness coefficient
(0.013)

R_h = hydraulic radius (ft)

S = slope (ft/ft)

Attachment A – SCS Engineering Design Report

SCS ENGINEERING DESIGN REPORT

15917 Great Oaks Drive.

City of Round Rock, TX 78681

Prepared for

Creek Edge Peppers LLC

907 Screech Owl Dr, Pflugerville, TX 78660

Prepared by:

LOC Consultants Civil Division, Inc

2211 S. IH 35 Frontage Rd, Ste. 107

Austin, Texas 78741



February 2024

02/28/2024



Contents

1. Introduction	1
2. SCS Design Criteria	1
3. Wastewater Main Design	2
4. Conclusion	5

1. Introduction

- The property, 15917 S Great Oaks Dr, is vacant land in Round Rock, TX 78681, near the corner of Great Oaks Drive and FM 620. This vacant land is a 1.793-acre lot all located within the Edwards Aquifer recharge zone. The Sewage Collection System (SCS) will be composed of 318.06 linear feet (LF) of 8-inch PVC SDR-26 gravity main “A” and 379.16 linear feet (LF) of 8-inch PVC SDR-26 gravity main “B”, both located within the property. The line “B” discharges into the line “A”, then into the existing infrastructure owned by Brushy Creek Regional Wastewater
- Wastewater main was designed according to the City of Round Rock Utilities Criteria Manual.
- All construction shall be in accordance with the City of Round Rock Standard Specifications Manual.
- A previous WPAP and SCS for this regulated entity was approved on December 10, 2021, and September 9, 2022; respectively. The property was bought by Creek Edge Peppers LLC, and a new Site Plan has been submitted to the City of Round Rock.
- The tract is in the Lake Creek – Brushy Creek Watershed.
- The SCS will convey the wastewater of 20 warehouses, ± 24,000, all within the property.
- No future extensions are considered

2. SCS Design Criteria

- For the living unit equivalent (LUE) calculation, the LUE conversion factor by Brushy Creek Municipality District was considered. 1 LUE/4,000 sq.ft. of office-warehouse floor space.
- The Utility Criteria Manual considers 750 gallons per acre per day served for inflow and infiltration (I/I). The project comprises separated on-site and off-site stormwater lines to mitigate the I/I; additionally, joint, pipe materials, manhole structure, cover, inlets, and bases; and testing criteria by TCEQ 217(c) should be accomplished to address it.
- For mains of 15 inches in diameter or smaller, use the larger pipe diameter according to this criterion:

- The main shall be designed such that the PDWF shall not exceed sixty-five (65) percent of the capacity of the pipe flowing full.
- The main shall be designed such that the PWWF shall not exceed eighty-five (85) percent of the capacity of the pipe flowing full.
- The city of Round Rock set the minimum size pipe for wastewater mains to 8 inches.

3. Wastewater Main Design

3.1 Flow Calculations

- From LUE conversion factor for office-warehouses., the LUE was calculated as 7.74.
- Peak Dry Weather Flow (PDWF), $Q_{pdwf} = \frac{18+(0.018F)^{0.5}}{4+(0.018F)^{0.5}} F$
- Peak Wet Weather Flow (PWWF), $Q_{pwwf} = Q_{pdwf} + I/I$
- Minimum Flow, $Q_{min} = [0.2(0.0144F)^{0.198}F]$

Where:

$F = 80 \text{ gal/person/day} \times \text{LUEs} \times 3.5 / 1440 = \text{Average Dry-Weather Flow in gpm}$

$I/I = \text{Inflow \& Infiltration, 750 per acre per day.}$

-Results:

$$F = 1.17 \text{ gpm} = 1,686 \text{ gallons/day}$$

$$Q_{pdwf} = 5.12 \text{ gpm} = 7,375 \text{ gallons/day}$$

$$I/I = 1,345 \text{ gallons/day}$$

$$Q_{pwwf} = 8,720 \text{ gallons/day}$$

$$Q_{min} = 150 \text{ gallons/day}$$

3.2 Pipe size and material

As the line is considered as a main, an 8-inch PVC SDR 26 line was selected as the first iteration. With Manning's Formula, it was determined that the proposed 8-inch pipe won't flow full capacity, with flow values not exceeding 65% for PDWF nor 85% for PWWF of the pipe in flow capacity. Both values don't exceed 5% of the full capacity. Slopes selected for the design are within the interval for slopes for minimum and maximum velocity when flowing full; 2.00 fps and 10.00 fps, respectively. The slopes of the design are inside the intervals by TCEQ and the City of Round Rock Utility Manual. The Brushy Creek MUD wastewater treatment plant has the capacity to adequately treat the proposed peak flow.

-The material selected is 8-inch PVC gravity sewer SDR-26 and shall comply with:

- Pipe compliance ASTM D-3034.
- Joints compliance ASTM D-3212.
- Gaskets shall meet ASTM F477.
- Minimum pipe stiffness of 115 psi.
- Maximum SDR of 26.
- Pipe joints shall be tested according to ASTM D3139 or D3212 to at least 150 psi without leakage.

-For brand and model review City of Round Rock list of wastewater pre-approved product list.

-For segments when a 150-psi pressure class pipe is required, use PVC SDR-26 160 psi (Pressure Class)

3.3 Design considerations.

- For separation distances for wastewater and water pipelines running parallel, crossings, and manholes to consider TCEQ Table C.1 in TAC §217.53(d)(3). The proposed sewage line has crossing with water lines within 9ft; however, the type of pipe selected is a 150-psi pressure class pipe.
- The average depth cover in the design is 8-feet. According to the city considerations, an 8-feet from the top of the pavement to the flow lines is a reasonable depth. The lowest cover depth in the design is due to the restriction of the invert elevation of the existing manhole of the city network.
- Manhole's locations were defined as set in TCEQ 217.55(a).
- PVC is a non-conductor of electricity material, therefore immune to electrochemical reactions which cause corrosion.
- No active faults within the boundaries of the collection system, see Geologic Assessment.
- No connection between the proposed wastewater collection system and the proposed stormwater collection system.

3.4 Structural Analysis

No structural calculations were required as the project complies with TCEQ requirements in 217.53(k)(4):

- (A) The pipe is installed using an open trench design. All pipelines were be constructed open trench.
- (B) The pipe is flexible pipe with a pipe stiffness of 46 psi or greater. For PVC SD26 ASTM D-3034, stiffness is 115psi.
- (C) the pipe is buried 17 feet or less from the ground surface. Pipe average cover from the top of the pipe is 8-feet deep (7.6' - 8.6').
- (D) The pipe has a diameter of 12 inches or less: 8-inch PVC SD 26
- (E) the modulus of soil reaction for the in-situ soil is 200 psi or greater. Soil reaction modulus greater than 200 psi
- (F) there are no effects on the pipe due to live loads from vehicles driving over the pipe. See below.
- (G) the unit weight of soil used for backfilling is 120 pounds per cubic foot or less. 120pcf for backfill material
- (H) the pipe trench width is 36 inches or greater. Minimum 3-feet open trenches

Regarding to live load effect on pipe performance, if highway (H-20) live loads are considered, their influence in cover heights higher than 8-feet is negligible, see the below table from Uni-Bell Handbook. Although the project is considered as industrial zoning, no 20-ton truck traffic will be presented, concluding, that there are no effects on the 8-inch PVC SD26 wastewater main nor live loads from the construction stage of the project that affect it.

Live load transferred to pipe, lb/in [†]				Live load transferred to pipe, lb/in [†]			
Height of cover, ft	Highway H-20 [‡]	Railway E-80 [‡]	Airport [‡]	Height of cover, ft	Highway H-20 [‡]	Railway E-80 [‡]	Airport [‡]
1	12.50	—	—	14	§	4.17	3.06
2	5.56	26.39	13.14	16	§	3.47	2.29
3	4.17	23.61	12.28	18	§	2.78	1.91
4	2.78	18.40	11.27	20	§	2.08	1.53
5	1.74	16.67	10.09	22	§	1.91	1.14
6	1.39	15.63	8.79	24	§	1.74	1.05
7	1.22	12.15	7.85	26	§	1.39	§
8	0.69	11.11	6.93	28	§	1.04	§
10	§	7.64	6.09	30	§	0.69	§
12	§	5.56	4.76	35	§	§	§
				40	§	§	§

^{*}Simulates 20-ton truck traffic + impact.

[†]Simulates 80,000 lb/ft railway load + impact.

[‡]180,000-lb dual-tandem gear assembly, with 26-in spacing between tires and 66-in center-to-center spacing between fore and aft tires under a rigid pavement 12 in thick + impact.

[§]Negligible live-load influence.

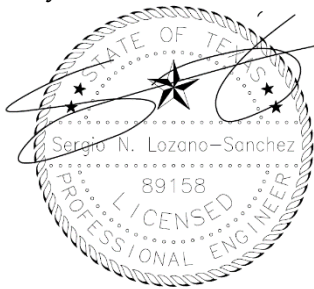
SOURCE: Reprinted, by permission, from *Uni-Bell Handbook*.²⁶

4. Conclusion

As conclusion, the project fulfills with City of Round Rock and TCEQ (30 TAC Chapter 217) design criteria; then, the SCS application can proceed for the development of 15917 Great Oaks Drive.

Please call our office at (512) 524-0677 if you have any questions or require further clarification for any of the above items.

Sincerely,



10/20/2023

Sergio Lozano-Sanchez, P.E.,

Principal

Attachment B - Justification and Calculations for Deviation in Straight Alignment Without Manholes

There will be no deviation in straight alignment without manholes

Attachment C - Justification for Variance from Maximum Manhole Spacing

There will be no variance for separation distance between manholes

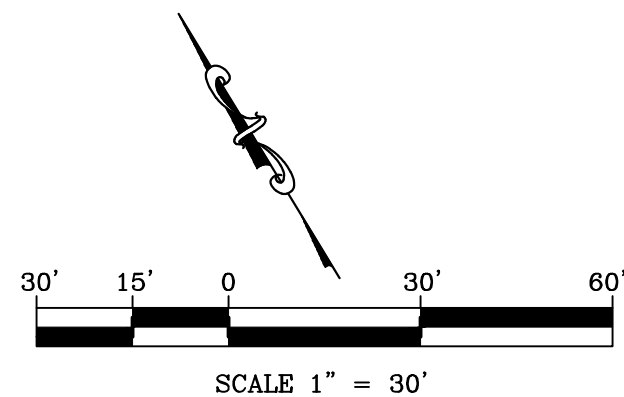
Attachment D – Calculations for Slopes for Flows Greater Than 10.0 Feet Per Second

No flows greater than 10f/s in the sewage system

Site Plan

GREAT OAKS DRIVE

100' R.O.W.



LEGEND

- PROPERTY LINE
- - - ADJACENT PROPERTY LINE
- [Hatched Box] PROPOSED BUILDING FOOTPRINT
- 832 EXISTING CONTOUR
- (832) PROPOSED CONTOUR
- WW --- EXISTING WASTEWATER LINE
- W --- EXISTING WATER LINE
- WW --- PROPOSED WASTEWATER LINE
- W --- PROPOSED WATER LINE
- --- PROPOSED STORMWATER LINE
- (S) EXISTING WASTEWATER MANHOLE
- (S) PROPOSED WASTEWATER MANHOLE
- (D) PROPOSED STORM DRAINAGE MANHOLE
- PROPOSED CLEANOUT
- [Square with X] PROPOSED STORM BOX CONNECTION
- [Square with Grid] PROPOSED GRATE INLET
- [Rectangular with Grid] PROPOSED TRENCH/SLOTTED DRAIN
- ⊕ EXISTING FIRE HYDRANT
- ⊕ PROPOSED FIRE HYDRANT

PARKING TABLE	
PROPOSED REGULAR	77
PROPOSED COMPACT	6
PROPOSED ACCESSIBLE	6
TOTAL PROPOSED PARKING	89

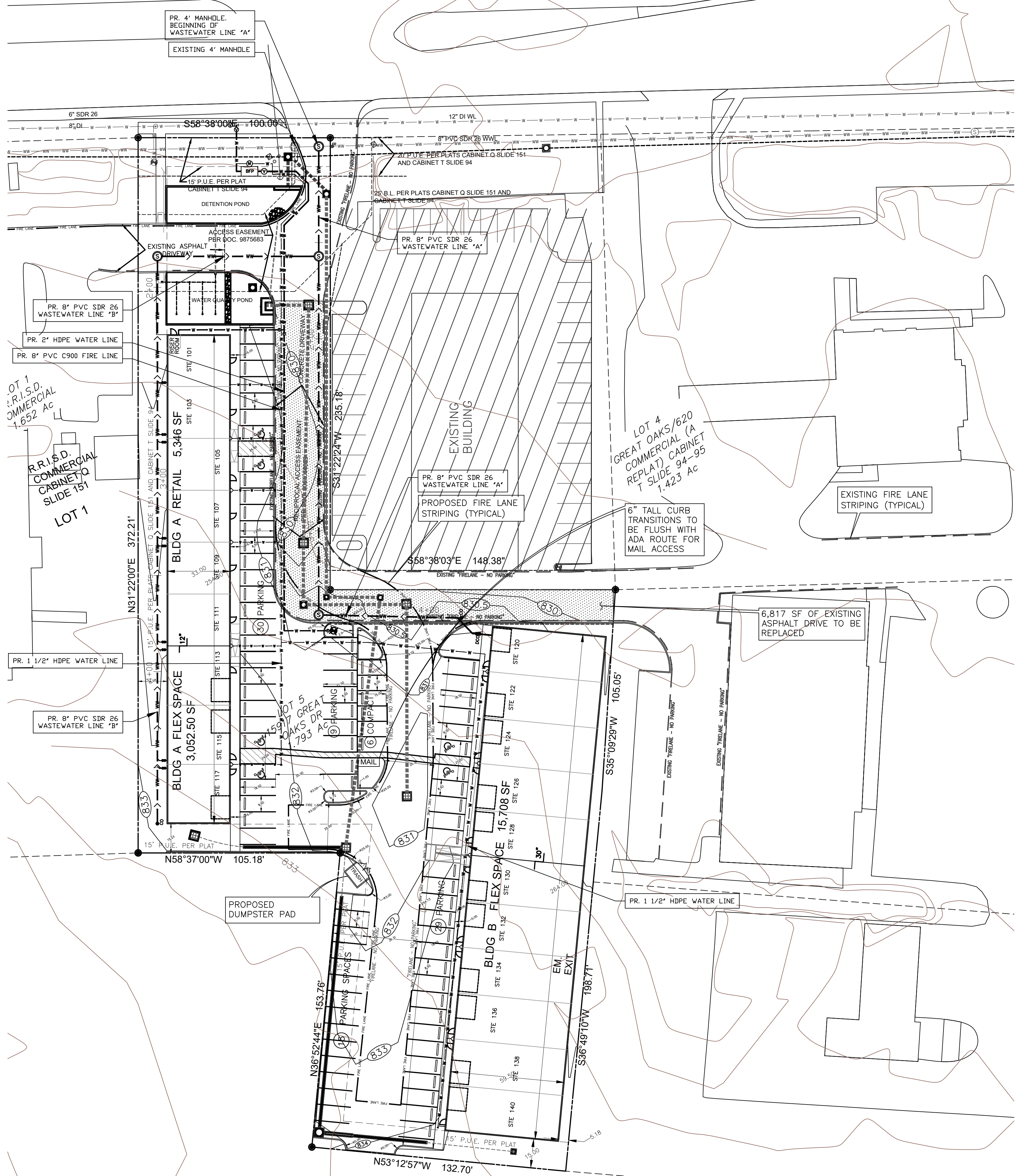
PROJECT DESCRIPTION
 THE PROJECT CONSIST OF THE CONSTRUCTION OF 2 OFFICE/WAREHOUSE BUILDINGS AND ASSOCIATED PARKING LOT.

SITE DATA TABLE	
EXISTING USE:	VACANT
PROPOSED USE:	RETAIL, FLEX SPACE
GROSS SITE AREA:	78,103 Sq.Ft.
NO ZONING:	OUTSIDE CITY LIMITS
MINIMUM SITE AREA REQUIRED:	N/A
TOTAL GROSS FLOOR AREA:	24,106.50 SF
BUILDING COVERAGE:	24,106.50 SF
IMPERVIOUS COVER:	81.91%
FLOOR TO AREA RATIO:	0.31
FINISH FLOOR ELEV.:	831.58, 832.00, 833.08, 834.08
NO. OF STORIES:	ONE STORY
BUILDING HEIGHT:	TBD
EXISTING SQUARE FOOTAGE:	0 Sq.Ft
FOUNDATION TYPE:	SLAB ON GRADE
BUILDING CONSTRUCTION:	METAL BUILDING
MAX BLDG. ELEVATION:	N/A

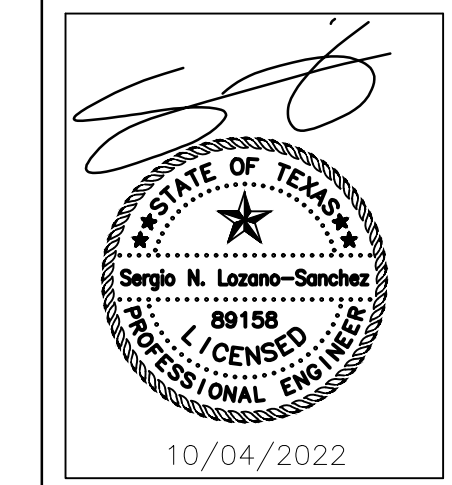
IMPERVIOUS COVER CALCULATION									
NET SITE AREA:	1,793 AC= 78,103 SF								
ZONED FAR:									
	IMPERVIOUS COVER	EXISTING	%	DEMOLITION	%	PROPOSED	%	TOTAL	%
BUILDING/ROOF		SF	0.00	-	SF	0.00	24,106.50	SF	30.87
CONCRETE		SF	13.70	-	SF	0.00	3,609.42	SF	4.62
ASPHALT		SF	0.00	-	SF	0.00	25,560.21	SF	32.73
TOTAL		SF	13.70	-	SF	0.00	53,276.13	SF	68.21
PERVIOUS COVER		SF	86.30					SF	18.09
GOOD GRASS									

FIRE PROTECTION NOTE
 BUILDING #3 SHALL BE BROKEN UP BY FIRE WALLS AND KEEP THE UNDIVIDED AREAS BELOW 12,000 SQ.FT. TO AVOID THE NECESSITY OF INSTALLING A FIRE SPRINKLER SYSTEM.

ENGINEER'S CERTIFICATION
 A CIVIL ENGINEER REGISTERED IN TEXAS MUST CERTIFY A PLAN OR PLAT AS COMPLETE, ACCURATE, AND IN COMPLIANCE WITH THE REQUIREMENTS OF THIS SUBCHAPTER THE DIRECTOR OF WATERSHED PROTECTION DEPARTMENT MAY WAIVE THIS REQUIREMENT AFTER MAKING A DETERMINATION THAT THE PLAN OR PLAT INCLUDES ONLY MINOR ALTERATIONS OR IMPROVEMENTS THAT DO NOT REQUIRE THE SERVICES OF AN ENGINEER.



REVISIONS/CORRECTIONS	
NO.	DESCRIPTION

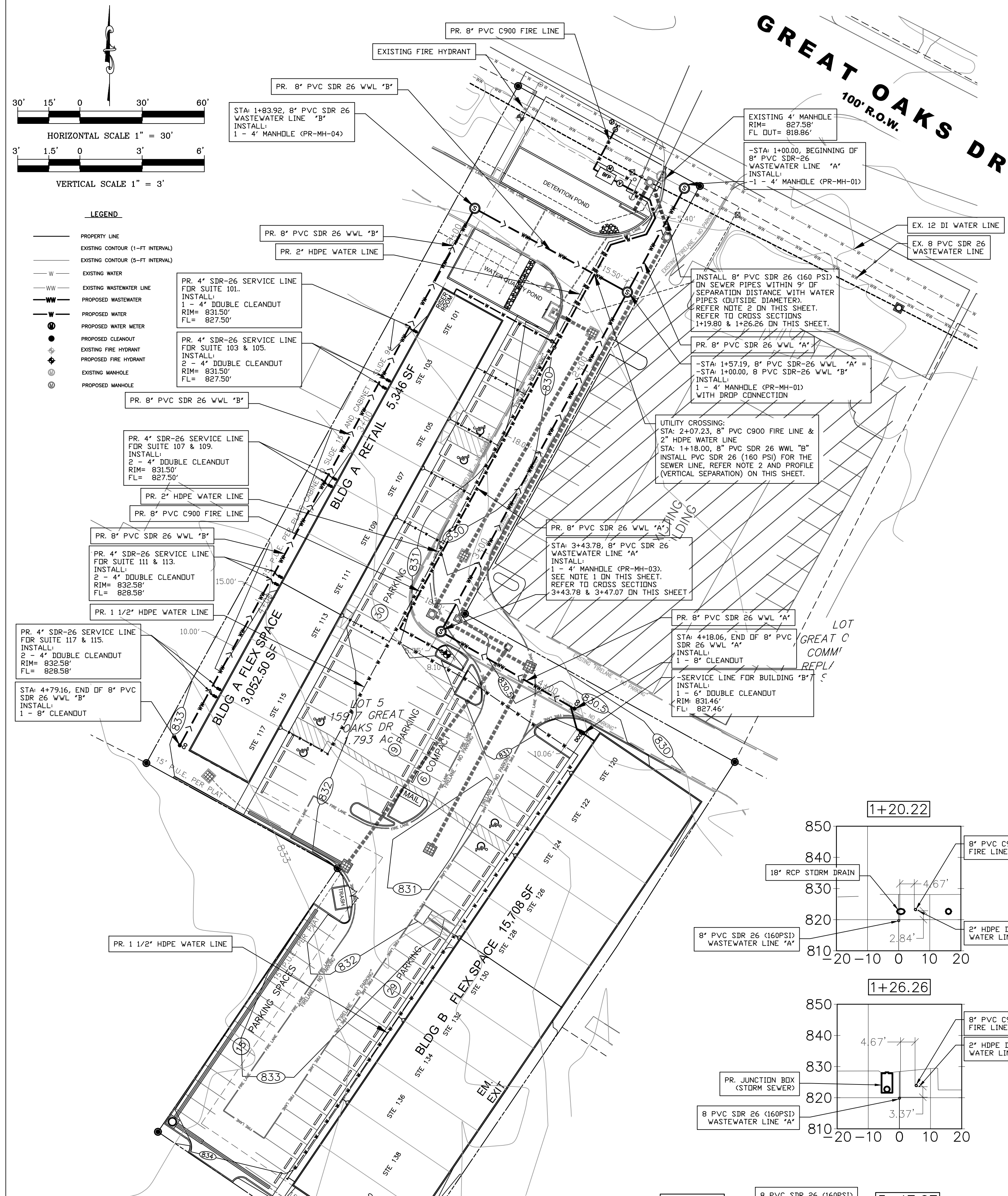


GREAT OAKS DR.
 15917 GREAT OAKS DRIVE
 SITE PLAN

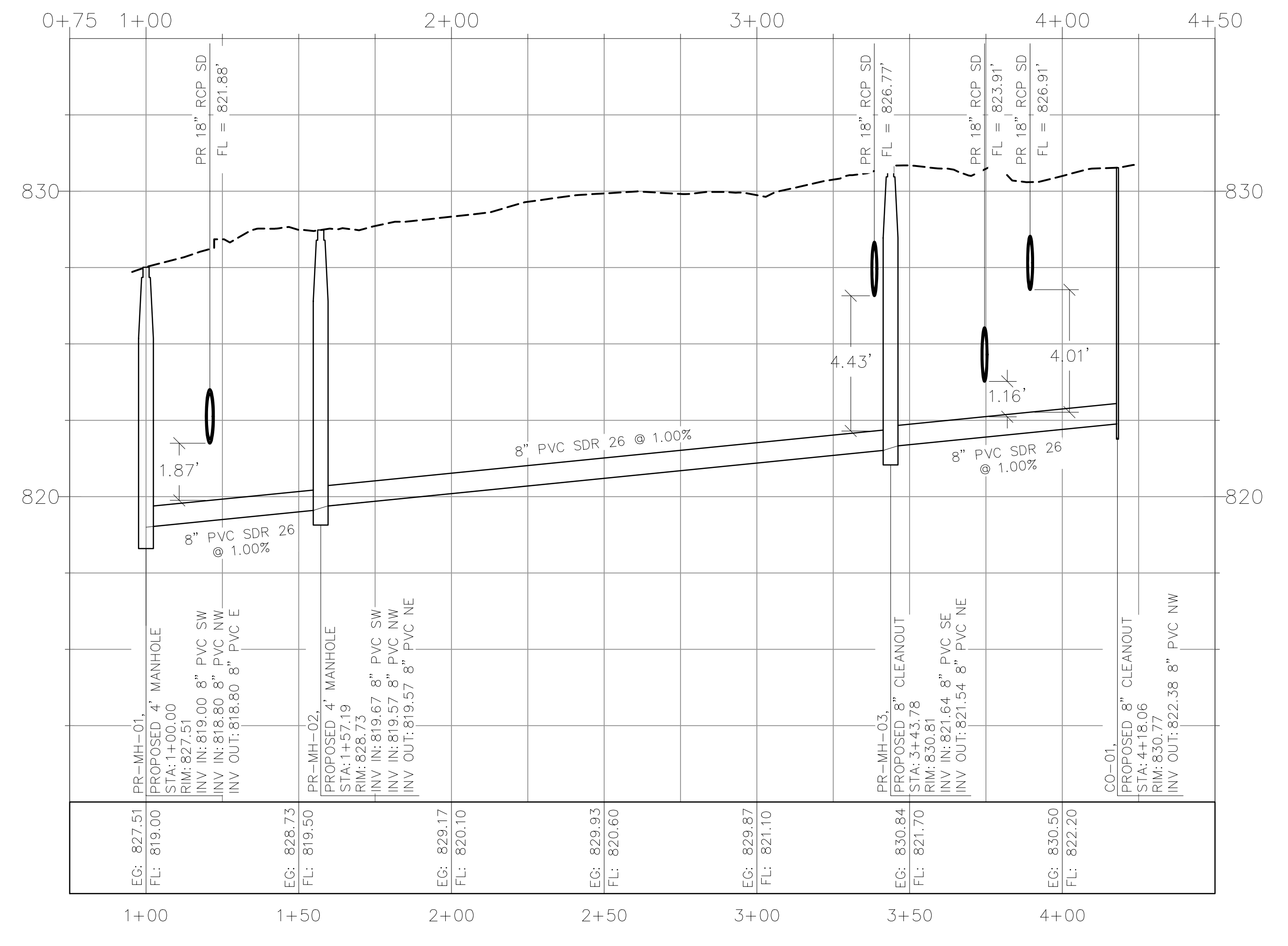


SHEET:
04
 OF 17

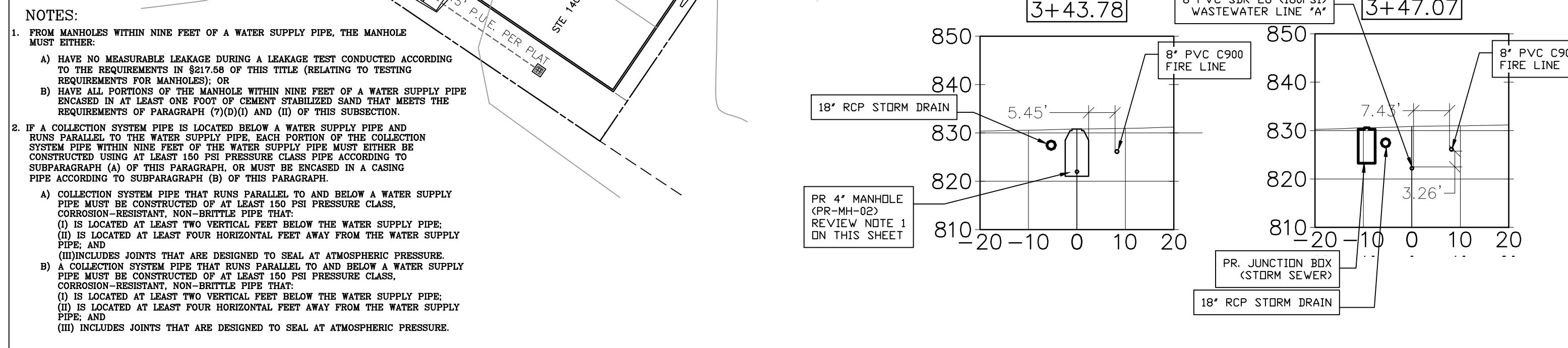
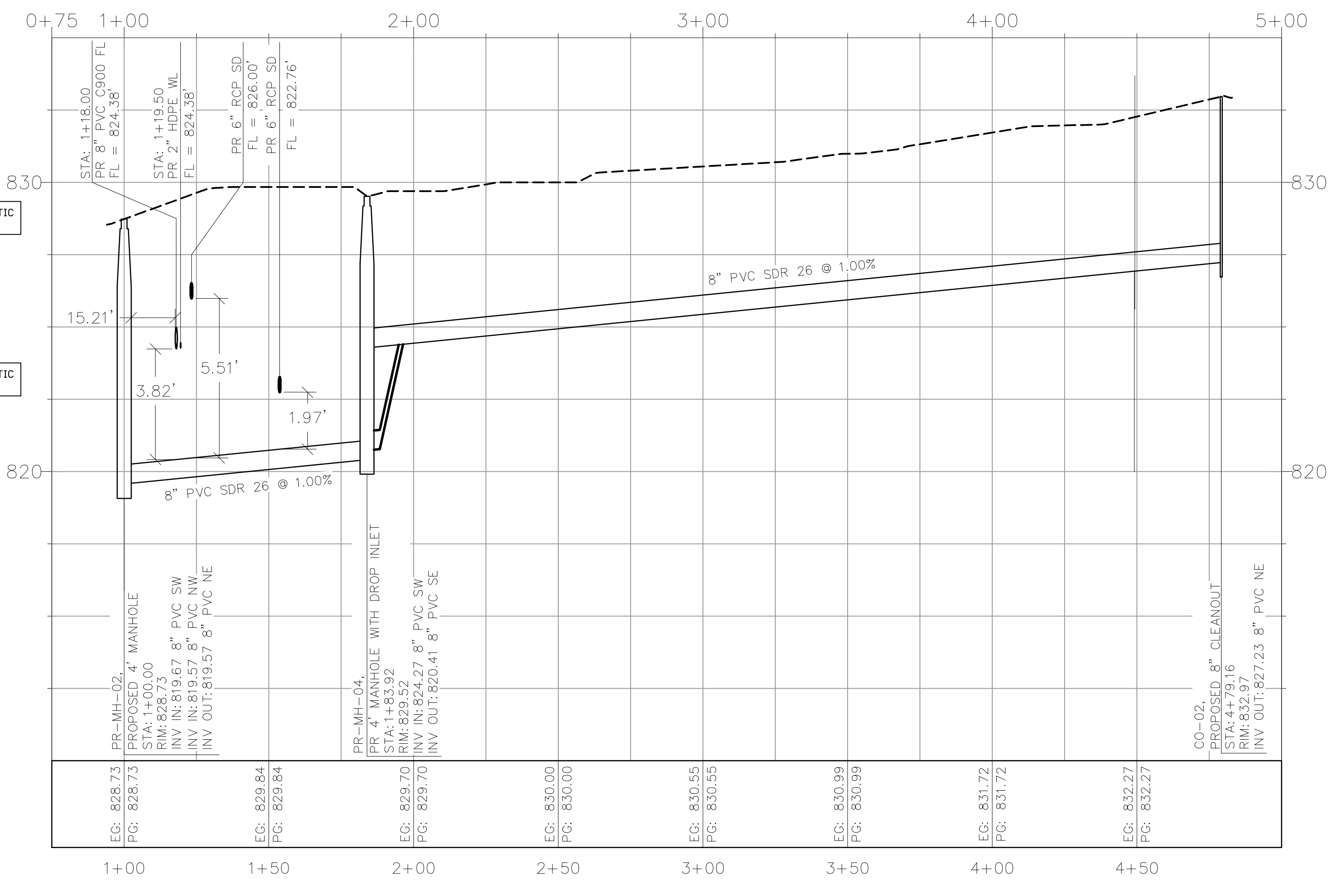
Final Plan and Profile Sheets



WASTEWATER LINE "A" PROFILE

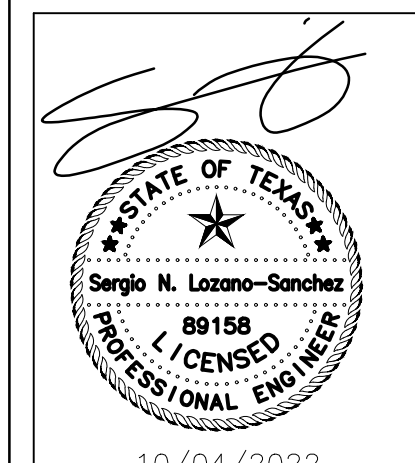


WASTEWATER LINE "B" PROFILE

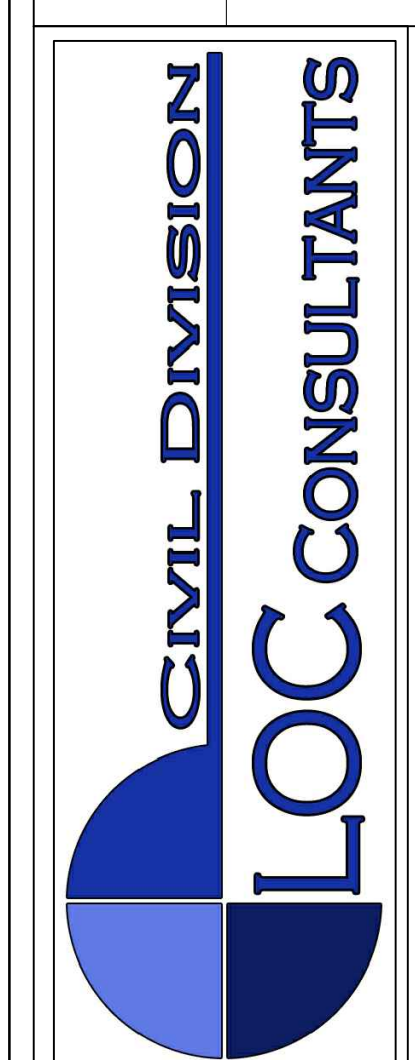


REVISIONS/CORRECTIONS

NO.	DESCRIPTION



GREAT OAKS DR.
15917 GREAT OAKS DRIVE
WATER PLAN



Previous Water Pollution Abatement Plan (WPAP) Application Approved.

Jon Niermann, *Chairman*
Emily Lindley, *Commissioner*
Bobby Janecka, *Commissioner*
Toby Baker, *Executive Director*



TEXAS COMMISSION ON ENVIRONMENTAL QUALITY

Protecting Texas by Reducing and Preventing Pollution

December 10, 2020

Mr. Michael Craig
KJ Investment Partners LLC
2101 Far Gallant Drive
Austin, TX 78746

Re: Edwards Aquifer, Williamson County

NAME OF PROJECT: 15917 Great Oaks Dr, Located at 15917 S Great Oaks Dr, Round Rock, Texas

TYPE OF PLAN: Request for Approval of a Water Pollution Abatement Plan (WPAP); 30 Texas Administrative Code (TAC) Chapter 213 Subchapter A Edwards Aquifer

Edwards Aquifer Protection Program ID No. 11002157; Regulated Entity No. RN111086294

Dear Mr. Craig:

The Texas Commission on Environmental Quality (TCEQ) has completed its review of the WPAP Application for the above-referenced project submitted to the Austin Regional Office by LOC Consultants on behalf of KJ Investment Partners LLC on August 13, 2020. Final review of the WPAP was completed after additional material was received on November 06, 2020, November 23, 2020, and December 2, 2020. As presented to the TCEQ, the Temporary and Permanent Best Management Practices (BMPs) were selected and construction plans were prepared by a Texas Licensed Professional Engineer to be in general compliance with the requirements of 30 TAC Chapter 213. These planning materials were sealed, signed and dated by a Texas Licensed Professional Engineer. Therefore, based on the engineer's concurrence of compliance, the planning materials for construction of the proposed project and pollution abatement measures are hereby approved subject to applicable state rules and the conditions in this letter. The applicant or a person affected may file with the chief clerk a motion for reconsideration of the executive director's final action on this Edwards Aquifer Protection Plan. A motion for reconsideration must be filed no later than 23 days after the date of this approval letter. *This approval expires two (2) years from the date of this letter unless, prior to the expiration date, more than 10 percent of the construction has commenced on the project or an extension of time has been requested.*

PROJECT DESCRIPTION

The proposed commercial development project will have an area of approximately 1.79 acres. It will include the construction of three commercial buildings, an associated parking lot, and a sedimentation/filtration pond. The impervious cover will be 1.41 acres (79 percent).

PERMANENT POLLUTION ABATEMENT MEASURES

To prevent the pollution of stormwater runoff originating on-site or upgradient of the site and potentially flowing across and off the site after construction, a partial sedimentation/filtration basin, designed using the TCEQ technical guidance document, Complying with the Edwards Aquifer Rules: Technical Guidance on Best Management Practices (2005), will be constructed to treat stormwater runoff. The required total suspended solids (TSS) treatment for this project is 1010 pounds of TSS generated from the 1.41 acres of impervious cover. The approved measures meet the required 80 percent removal of the increased load in TSS caused by the project.

GEOLOGY

According to the Geologic Assessment (GA) included with the application, the surficial geologic unit present at the site has been identified as the Edwards Limestone. There were no sensitive recharge features identified within the GA. The Austin Regional Office site assessment conducted on November 5, 2020 revealed the site to be generally as described in the GA.

SPECIAL CONDITIONS

- I. All permanent pollution abatement measures shall be operational prior to occupancy of the facility.
- II. All sediment and/or media removed from the water quality basin during maintenance activities shall be properly disposed of according to 30 TAC 330 or 30 TAC 335, as applicable.
- III. No person may commence rehabilitation or construction related to an existing or new organized sewage collection system on the recharge zone, until final design plans, specifications, and an engineering report, as specified in Chapter 317 of this title relating to Design Criteria for Sewerage Systems) and appropriate special requirements of this section, have been filed with and approved by the executive director.

STANDARD CONDITIONS

1. Pursuant to Chapter 7 Subchapter C of the Texas Water Code, any violations of the requirements in 30 TAC Chapter 213 may result in administrative penalties.
2. The holder of the approved Edwards Aquifer protection plan must comply with all provisions of 30 TAC Chapter 213 and all best management practices and measures contained in the approved plan. Additional and separate approvals, permits, registrations and/or authorizations from other TCEQ Programs (i.e., Stormwater, Water Rights, UIC) can be required depending on the specifics of the plan.
3. In addition to the rules of the Commission, the applicant may also be required to comply with state and local ordinances and regulations providing for the protection of water quality.

Prior to Commencement of Construction:

4. Within 60 days of receiving written approval of an Edwards Aquifer Protection Plan, the applicant must submit to the Austin Regional Office, proof of recordation of notice in the county deed records, with the volume and page number(s) of the county deed records of the county in which the property is located. A description of the property boundaries shall be included in the deed recordation in the county deed records. A suggested form (Deed Recordation Affidavit, TCEQ-0625) that you may use to deed record the approved WPAP is enclosed.
5. All contractors conducting regulated activities at the referenced project location shall be provided a copy of this notice of approval. At least one complete copy of the approved

WPAP and this notice of approval shall be maintained at the project location until all regulated activities are completed.

6. Modification to the activities described in the referenced WPAP application following the date of approval may require the submittal of a plan to modify this approval, including the payment of appropriate fees and all information necessary for its review and approval prior to initiating construction of the modifications.
7. The applicant must provide written notification of intent to commence construction, replacement, or rehabilitation of the referenced project. Notification must be submitted to the Austin Regional Office no later than 48 hours prior to commencement of the regulated activity. Written notification must include the date on which the regulated activity will commence, the name of the approved plan and program ID number for the regulated activity, and the name of the prime contractor with the name and telephone number of the contact person. The executive director will use the notification to determine if the approved plan is eligible for an extension.
8. Temporary erosion and sedimentation (E&S) controls, i.e., silt fences, rock berms, stabilized construction entrances, or other controls described in the approved WPAP, must be installed prior to construction and maintained during construction. Temporary E&S controls may be removed when vegetation is established and the construction area is stabilized. If a water quality pond is proposed, it shall be used as a sedimentation basin during construction. The TCEQ may monitor stormwater discharges from the site to evaluate the adequacy of temporary E&S control measures. Additional controls may be necessary if excessive solids are being discharged from the site.
9. All borings with depths greater than or equal to 20 feet must be plugged with non-shrink grout from the bottom of the hole to within three (3) feet of the surface. The remainder of the hole must be backfilled with cuttings from the boring. All borings less than 20 feet must be backfilled with cuttings from the boring. All borings must be backfilled or plugged within four (4) days of completion of the drilling operation. Voids may be filled with gravel.

During Construction:

10. During the course of regulated activities related to this project, the applicant or agent shall comply with all applicable provisions of 30 TAC Chapter 213, Edwards Aquifer. The applicant shall remain responsible for the provisions and conditions of this approval until such responsibility is legally transferred to another person or entity.
11. This approval does not authorize the installation of temporary aboveground storage tanks on this project. If the contractor desires to install a temporary aboveground storage tank for use during construction, an application to modify this approval must be submitted and approved prior to installation. The application must include information related to tank location and spill containment. Refer to Standard Condition No. 6, above.
12. If any sensitive feature (caves, solution cavities, sink holes, etc.) is discovered during construction, all regulated activities near the feature must be suspended immediately. The applicant or his agent must immediately notify the Austin Regional Office of the discovery of the feature. Regulated activities near the feature may not proceed until the executive director has reviewed and approved the methods proposed to protect the feature and the aquifer from potentially adverse impacts to water quality. The plan must be sealed, signed, and dated by a Texas Licensed Professional Engineer.
13. No wells exist on site. All water wells, including injection, dewatering, and monitoring wells must be in compliance with the requirements of the Texas Department of Licensing and Regulation under Title 16 TAC Chapter 76 (relating to Water Well Drillers and Pump Installers) and all other locally applicable rules, as appropriate.
14. If sediment escapes the construction site, the sediment must be removed at a frequency sufficient to minimize offsite impacts to water quality (e.g., fugitive sediment in street being washed into surface streams or sensitive features by the next rain). Sediment must be removed from sediment traps or sedimentation ponds not later than when design capacity

has been reduced by 50 percent. Litter, construction debris, and construction chemicals shall be prevented from becoming stormwater discharge pollutants.

15. Intentional discharges of sediment laden water are not allowed. If dewatering becomes necessary, the discharge will be filtered through appropriately selected best management practices. These may include vegetated filter strips, sediment traps, rock berms, silt fence rings, etc.
16. The following records shall be maintained and made available to the executive director upon request: the dates when major grading activities occur, the dates when construction activities temporarily or permanently cease on a portion of the site, and the dates when stabilization measures are initiated.
17. Stabilization measures shall be initiated as soon as practicable in portions of the site where construction activities have temporarily or permanently ceased, and construction activities will not resume within 21 days. When the initiation of stabilization measures by the 14th day is precluded by weather conditions, stabilization measures shall be initiated as soon as practicable.

After Completion of Construction:

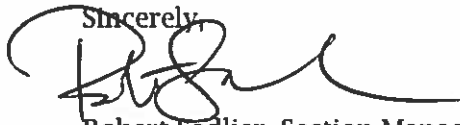
18. A Texas Licensed Professional Engineer must certify in writing that the permanent BMPs or measures were constructed as designed. The certification letter must be submitted to the Austin Regional Office within 30 days of site completion.
19. The applicant shall be responsible for maintaining the permanent BMPs after construction until such time as the maintenance obligation is either assumed in writing by another entity having ownership or control of the property (such as without limitation, an owner's association, a new property owner or lessee, a district, or municipality) or the ownership of the property is transferred to the entity. The regulated entity shall then be responsible for maintenance until another entity assumes such obligations in writing or ownership is transferred. A copy of the transfer of responsibility must be filed with the executive director through Austin Regional Office within 30 days of the transfer. A copy of the transfer form (TCEQ-10263) is enclosed.
20. Upon legal transfer of this property, the new owner(s) is required to comply with all terms of the approved Edwards Aquifer protection plan. If the new owner intends to commence any new regulated activity on the site, a new Edwards Aquifer protection plan that specifically addresses the new activity must be submitted to the executive director. Approval of the plan for the new regulated activity by the executive director is required prior to commencement of the new regulated activity.
21. An Edwards Aquifer protection plan approval or extension will expire and no extension will be granted if more than 50 percent of the total construction has not been completed within ten years from the initial approval of a plan. A new Edwards Aquifer protection plan must be submitted to the Austin Regional Office with the appropriate fees for review and approval by the executive director prior to commencing any additional regulated activities.

Mr. Michael Craig
Page 5
December 10, 2020

22. At project locations where construction is initiated and abandoned, or not completed, the site shall be returned to a condition such that the aquifer is protected from potential contamination.

This action is taken under authority delegated by the Executive Director of the Texas Commission on Environmental Quality. If you have any questions or require additional information, please contact Ryan Soutter of the Edwards Aquifer Protection Program of the Austin Regional Office at (512) 339-2929.

Sincerely,



Robert Sadlier, Section Manager
Edwards Aquifer Protection Program
Texas Commission on Environmental Quality

RCS/rts

Enclosure: Deed Recordation Affidavit, Form TCEQ-0625
Change in Responsibility for Maintenance of Permanent BMPs, Form TCEQ-10263

cc: Sergio Lozano
LOC Consultants
1715 E 7th Street
Austin, TX 78702

**Deed Recordation Affidavit
Edwards Aquifer Protection Plan**

THE STATE OF TEXAS §

County of _____ §

BEFORE ME, the undersigned authority, on this day personally appeared _____ who, being duly sworn by me, deposes and says:

- (1) That my name is _____ and that I own the real property described below.
- (2) That said real property is subject to an EDWARDS AQUIFER PROTECTION PLAN which was required under the 30 Texas Administrative Code (TAC) Chapter 213.
- (3) That the EDWARDS AQUIFER PROTECTION PLAN for said real property was approved by the Texas Commission on Environmental Quality (TCEQ) on _____.

A copy of the letter of approval from the TCEQ is attached to this affidavit as Exhibit A and is incorporated herein by reference.

- (4) The said real property is located in _____ County, Texas, and the legal description of the property is as follows:

LANDOWNER-AFFIANT

SWORN AND SUBSCRIBED TO before me, on this __ day of _____, _____.

NOTARY PUBLIC

THE STATE OF _____ §

County of _____ §

BEFORE ME, the undersigned authority, on this day personally appeared _____ known to me to be the person whose name is subscribed to the foregoing instrument, and acknowledged to me that (s)he executed same for the purpose and consideration therein expressed.

GIVEN under my hand and seal of office on this __ day of _____, _____.

NOTARY PUBLIC

Typed or Printed Name of Notary

MY COMMISSION EXPIRES: _____

**Change in Responsibility for Maintenance
on Permanent Best Management Practices and Measures**

The applicant is no longer responsible for maintaining the permanent best management practice (BMP) and other measures. The project information and the new entity responsible for maintenance is listed below.

Customer: _____

Regulated Entity Name: _____

Site Address: _____

City, Texas, Zip: _____

County: _____

Approval Letter Date: _____

BMPs for the project: _____

New Responsible Party: _____

Name of contact: _____

Mailing Address: _____

City, State: _____ Zip: _____

Telephone: _____ FAX: _____

Signature of New Responsible Party Date

I acknowledge and understand that I am assuming full responsibility for maintaining all permanent best management practices and measures approved by the TCEQ for the site, until another entity assumes such obligations in writing or ownership is transferred.

If you have questions on how to fill out this form or about the Edwards Aquifer protection program, please contact us at 210/490-3096 for projects located in the San Antonio Region or 512/339-2929 for projects located in the Austin Region.

Individuals are entitled to request and review their personal information that the agency gathers on its forms. They may also have any errors in their information corrected. To review such information, contact us at 512/239-3282.

Previous Organized Sewage Collection System Plan (SCS) Application Approved.

Jon Niermann, *Chairman*
Emily Lindley, *Commissioner*
Bobby Janecka, *Commissioner*
Toby Baker, *Executive Director*



TEXAS COMMISSION ON ENVIRONMENTAL QUALITY

Protecting Texas by Reducing and Preventing Pollution

September 9, 2022

Mr. Michael Craig
KJ Investments Partners LLC
2101 Far Gallant Drive
Austin, Texas 78746

Re: Edwards Aquifer, Williamson County

NAME OF PROJECT: 15917 Great Oaks Drive; Located 15917 S Great Oaks Drive; ETJ of Round Rock, Texas

TYPE OF PLAN: Request for Approval of an Organized Sewage Collection System (SCS) Plan; 30 Texas Administrative Code (TAC) Chapter 213 Edwards Aquifer

Regulated Entity No. RN111086294; Additional ID No. 11003169

Dear Mr. Craig:

The Texas Commission on Environmental Quality (TCEQ) has completed its review of the organized sewage collection system plans and specifications for the referenced project submitted to the Austin Regional Office on behalf of KJ Investments Partners LLC by LOC Consultants on July 18, 2022. Final review was completed after additional material was received on August 24, 2022. As presented to the TCEQ, the construction documents were prepared by a Texas Licensed Professional Engineer to be in general compliance with the requirements of 30 TAC Chapter 213 and Chapter 217. Therefore, based on the Texas Licensed Professional Engineer's concurrence of compliance, the planning materials for construction of the proposed sewage collection system and pollution abatement measures are hereby approved subject to applicable state rules and the conditions in this letter. The applicant or a person affected may file with the chief clerk a motion for reconsideration of the executive director's final action on this Edwards Aquifer protection plan. A motion for reconsideration must be filed no later than 23 days after the date of this approval letter. *This approval expires (2) two years from the date of this letter unless, prior to the expiration date, more than 10 percent of construction has commenced, or an extension of time has been requested.*

PROJECT DESCRIPTION

The proposed sewage collection system will consist of a total of 598.80 linear feet of 8-inch diameter PVC SDR 26 gravity sewer main (ASTM D-3034); manholes, and appropriate appurtenances for a commercial development.

The system will be connected to an existing City of Round Rock wastewater line for conveyance to the Brushy Creek Recycling Center for treatment and disposal. The project is located within the City of Round Rock ETJ and will conform to all applicable codes, ordinances, and requirements of the City of Round Rock.

GEOLOGY

According to the geologic assessment included with the application, the site is underlain by the Edwards Limestone Formation. No sensitive features were identified. The site assessment conducted on August 30, 2022, revealed the site was generally as described in the geologic assessment.

SPECIAL CONDITIONS

- I. By the responsible engineer's dated signature and seal on the Engineering Design Report attached to the submitted application, all information therein accurately reflects the information requested concerning the proposed regulated activities and methods to protect the Edwards Aquifer in accordance with the requirements of 30 TAC 213.5 (c) and Chapter 217.

STANDARD CONDITIONS

1. Pursuant to Chapter 7 Subchapter C of the Texas Water Code, any violations of the requirements in 30 TAC Chapter 213 may result in administrative penalties.
2. The holder of the approved Edwards Aquifer protection plan must comply with all provisions of 30 TAC Chapter 213 and all best management practices and measures contained in the approved plan. Additional and separate approvals, permits, registrations and/or authorizations from other TCEQ Programs (i.e., Stormwater, Water Rights, UIC) can be required depending on the specifics of the plan.
3. In addition to the rules of the Commission, the applicant may also be required to comply with state and local ordinances and regulations providing for the protection of water quality.

Prior to Commencement of Construction:

4. All contractors conducting regulated activities at the project location shall be provided a copy of this notice of approval. At least one complete copy of the approved SCS plan and this notice of approval shall be maintained at the project location until all regulated activities are completed.
5. Modification to the activities described in the referenced SCS application following the date of approval may require the submittal of a plan to modify this approval, including the payment of appropriate fees and all information necessary for its review and approval prior to initiating construction of the modifications.
6. The applicant must provide written notification of intent to commence construction, replacement, or rehabilitation of the referenced project. Notification must be submitted to the Austin Regional Office no later than 48 hours prior to commencement of the regulated activity. Written notification must include the date on which the regulated activity will commence, the name of the approved plan and program ID number for the regulated activity, and the name of the prime contractor with the name and telephone number of the contact person. The executive director will use the notification to determine if the approved plan is eligible for an extension.
7. Temporary erosion and sedimentation (E&S) controls, i.e., silt fences, rock berms, stabilized construction entrances, or other controls described in the approved application, must be installed prior to construction, and maintained during construction. Temporary E&S controls may be removed when vegetation is established, and the construction area is stabilized. The TCEQ may monitor stormwater discharges from the site to evaluate the adequacy of temporary E&S control measures. Additional controls may be necessary if excessive solids are being discharged from the site.

During Construction:

8. During the course of regulated activities related to this project, the applicant or his agent shall comply with all applicable provisions of 30 TAC Chapter 213 and Chapter 217. The applicant shall remain responsible for the provisions and conditions of this approval until such responsibility is legally transferred to another person or entity, upon which that person or entity shall assume responsibility for all provisions and conditions of this approval.
9. If sediment escapes the construction site, the sediment must be removed at a frequency sufficient to minimize offsite impacts to water quality (e.g., fugitive sediment in street being washed into surface streams or sensitive features by the next rain). Sediment must be removed from sediment traps or sedimentation ponds not later than when design capacity has been reduced by 50 percent. Litter, construction debris, and construction chemicals shall be prevented from becoming stormwater discharge pollutants.
10. If any sensitive feature (caves, solution cavities, sink holes, etc.) is discovered during construction, all regulated activities near the feature must be suspended immediately. The applicant or his agent must immediately notify the Austin Regional Office of the discovery of the feature. Regulated activities near the feature may not proceed until the executive director has reviewed and approved the methods proposed to protect the feature and the aquifer from potentially adverse impacts to water quality. The plan must be sealed, signed, and dated by a Texas Licensed Professional Engineer.
11. The following records shall be maintained by the applicant and made available to the executive director upon request: the dates trenching activities occur, the dates when construction activities temporarily or permanently cease on a portion of the site, and the dates when stabilization measures are initiated and completed.
12. Stabilization measures shall be initiated as soon as practicable in portions of the site where construction activities have temporarily or permanently ceased, and construction activities will not resume within 21 days. When the initiation of stabilization measures by the 14th day is precluded by weather conditions, stabilization measures shall be initiated as soon as practicable.
13. Intentional discharges of sediment laden stormwater during construction are not allowed. If dewatering of excavated areas becomes necessary, the discharge will be filtered through appropriately selected temporary best management practices. These may include vegetative filter strips, sediment traps, rock berms, silt fence rings, etc.
14. No part of the system shall be used as a holding tank for a pump-and-haul operation.

After Completion of Construction:

15. Certification by a Texas Licensed Professional Engineer of the testing of sewage collection systems required by 30 TAC Chapter 213 and Chapter 217 shall be submitted to the San Antonio Regional Office within 30 days of test completion and prior to the new sewage collection system being put into service. The certification should include the project name as it appeared on the approved application, the program ID number, and two copies of a site plan sheet(s) indicating the wastewater lines and manholes that were tested and are being certified as complying with the appropriate regulations. The engineer must certify in writing that all wastewater lines have passed all required testing to the appropriate regional office within 30 days of test completion and prior to use of the new collection system. Should any test result fail to meet passing test criteria and then subsequently pass testing, the result(s) and an explanation of what repair, adjustment, or other means were taken to facilitate a subsequent passing result shall be provided.

16. Every five years after the initial certification, the sewage collection system shall be retested. Any lines that fail the test must be repaired and retested. Certification that the system continues to meet the requirements of 30 TAC Chapter 213 and Chapter 217 shall be submitted to the Austin Regional Office. The certification should include the project name as it appeared on the approved application, the program ID number and two copies of a site plan sheet(s) indicating the wastewater lines and manholes that were tested and are being certified as complying with the appropriate regulations. Should any test result fail to meet passing test criteria, and then subsequently pass testing, the result(s) and an explanation of what repair, adjustment, or other means were taken to facilitate a subsequent passing result shall be provided.
17. If ownership of this organized sewage collection system is legally transferred (e.g., developer to city or Municipal Utility District), the new owner(s) is required to comply with all terms of the approved Edwards Aquifer protection plan. If the new owner intends to commence any new regulated activity on the site, a new Edwards Aquifer protection plan that specifically addresses the new activity must be submitted to the executive director. Approval of the plan for the new regulated activity by the executive director is required prior to commencement of the new regulated activity.
18. An Edwards Aquifer protection plan approval or extension will expire, and no extension will be granted if more than 50 percent of the total construction has not been completed within ten years from the initial approval of a plan. A new Edwards Aquifer protection plan must be submitted to the Austin Regional Office with the appropriate fees for review and approval by the executive director prior to commencing any additional regulated activities.

This action is taken under authority delegated by the Executive Director of the Texas Commission on Environmental Quality. If you have any questions or require additional information, please contact Don Vandertulip, PE, BCEE of the Edwards Aquifer Protection Program of the San Antonio Regional Office at (210) 403-4057.

Sincerely,



Lillian Butler, Section Manager
Edwards Aquifer Protection Program
Texas Commission on Environmental Quality
LIB/dv

cc: Mr. Sergio Lozano, PE, LOC Consultants

6. TCEQ-0602 Temporary Stormwater Section

Temporary Stormwater Section

Texas Commission on Environmental Quality

for Regulated Activities on the Edwards Aquifer Recharge Zone and Relating to 30 TAC §213.5(b)(4)(A), (B), (D)(I) and (G); Effective June 1, 1999

To ensure that the application is administratively complete, confirm that all fields in the form are complete, verify that all requested information is provided, consistently reference the same site and contact person in all forms in the application, and ensure forms are signed by the appropriate party.

Note: Including all the information requested in the form and attachments contributes to more streamlined technical reviews.

Signature

To the best of my knowledge, the responses to this form accurately reflect all information requested concerning the proposed regulated activities and methods to protect the Edwards Aquifer. This **Temporary Stormwater Section** is hereby submitted for TCEQ review and executive director approval. The application was prepared by:

Print Name of Customer/Agent: Sergio N. Lozano-Sanchez, PE

Date: 10/20/2023

Signature of Customer/Agent:



Regulated Entity Name: 15917 Great Oaks Drive

Project Information

Potential Sources of Contamination

Examples: Fuel storage and use, chemical storage and use, use of asphaltic products, construction vehicles tracking onto public roads, and existing solid waste.

1. Fuels for construction equipment and hazardous substances which will be used during construction:

The following fuels and/or hazardous substances will be stored on the site: _____

These fuels and/or hazardous substances will be stored in:

Aboveground storage tanks with a cumulative storage capacity of less than 250 gallons will be stored on the site for less than one (1) year.

- Aboveground storage tanks with a cumulative storage capacity between 250 gallons and 499 gallons will be stored on the site for less than one (1) year.
- Aboveground storage tanks with a cumulative storage capacity of 500 gallons or more will be stored on the site. An Aboveground Storage Tank Facility Plan application must be submitted to the appropriate regional office of the TCEQ prior to moving the tanks onto the project.
- Fuels and hazardous substances will not be stored on the site.
- 2. **Attachment A - Spill Response Actions.** A site-specific description of the measures to be taken to contain any spill of hydrocarbons or hazardous substances is attached.
- 3. Temporary aboveground storage tank systems of 250 gallons or more cumulative storage capacity must be located a minimum horizontal distance of 150 feet from any domestic, industrial, irrigation, or public water supply well, or other sensitive feature.
- 4. **Attachment B - Potential Sources of Contamination.** A description of any activities or processes which may be a potential source of contamination affecting surface water quality is attached.

Sequence of Construction

- 5. **Attachment C - Sequence of Major Activities.** A description of the sequence of major activities which will disturb soils for major portions of the site (grubbing, excavation, grading, utilities, and infrastructure installation) is attached.
 - For each activity described, an estimate (in acres) of the total area of the site to be disturbed by each activity is given.
 - For each activity described, include a description of appropriate temporary control measures and the general timing (or sequence) during the construction process that the measures will be implemented.
- 6. Name the receiving water(s) at or near the site which will be disturbed or which will receive discharges from disturbed areas of the project: Lake Creek (Tributary of Brushy Creek)

Temporary Best Management Practices (TBMPs)

Erosion control examples: tree protection, interceptor swales, level spreaders, outlet stabilization, blankets or matting, mulch, and sod. Sediment control examples: stabilized construction exit, silt fence, filter dikes, rock berms, buffer strips, sediment traps, and sediment basins. Please refer to the Technical Guidance Manual for guidelines and specifications. All structural BMPs must be shown on the site plan.

- 7. **Attachment D – Temporary Best Management Practices and Measures.** TBMPs and measures will prevent pollution of surface water, groundwater, and stormwater. The construction-phase BMPs for erosion and sediment controls have been designed to retain sediment on site to the extent practicable. The following information is attached:

- A description of how BMPs and measures will prevent pollution of surface water, groundwater or stormwater that originates upgradient from the site and flows across the site.
 - A description of how BMPs and measures will prevent pollution of surface water or groundwater that originates on-site or flows off site, including pollution caused by contaminated stormwater runoff from the site.
 - A description of how BMPs and measures will prevent pollutants from entering surface streams, sensitive features, or the aquifer.
 - A description of how, to the maximum extent practicable, BMPs and measures will maintain flow to naturally occurring sensitive features identified in either the geologic assessment, TCEQ inspections, or during excavation, blasting, or construction.
8. The temporary sealing of a naturally occurring sensitive feature which accepts recharge to the Edwards Aquifer as a temporary pollution abatement measure during active construction should be avoided.
- Attachment E - Request to Temporarily Seal a Feature.** A request to temporarily seal a feature is attached. The request includes justification as to why no reasonable and practicable alternative exists for each feature.
- There will be no temporary sealing of naturally occurring sensitive features on the site.
9. **Attachment F - Structural Practices.** A description of the structural practices that will be used to divert flows away from exposed soils, to store flows, or to otherwise limit runoff discharge of pollutants from exposed areas of the site is attached. Placement of structural practices in floodplains has been avoided.
10. **Attachment G - Drainage Area Map.** A drainage area map supporting the following requirements is attached:
- For areas that will have more than 10 acres within a common drainage area disturbed at one time, a sediment basin will be provided.
 - For areas that will have more than 10 acres within a common drainage area disturbed at one time, a smaller sediment basin and/or sediment trap(s) will be used.
 - For areas that will have more than 10 acres within a common drainage area disturbed at one time, a sediment basin or other equivalent controls are not attainable, but other TBMPs and measures will be used in combination to protect down slope and side slope boundaries of the construction area.
 - There are no areas greater than 10 acres within a common drainage area that will be disturbed at one time. A smaller sediment basin and/or sediment trap(s) will be used in combination with other erosion and sediment controls within each disturbed drainage area.

- There are no areas greater than 10 acres within a common drainage area that will be disturbed at one time. Erosion and sediment controls other than sediment basins or sediment traps within each disturbed drainage area will be used.
11. **Attachment H - Temporary Sediment Pond(s) Plans and Calculations.** Temporary sediment pond or basin construction plans and design calculations for a proposed temporary BMP or measure have been prepared by or under the direct supervision of a Texas Licensed Professional Engineer. All construction plans and design information must be signed, sealed, and dated by the Texas Licensed Professional Engineer. Construction plans for the proposed temporary BMPs and measures are attached.
- N/A
12. **Attachment I - Inspection and Maintenance for BMPs.** A plan for the inspection of each temporary BMP(s) and measure(s) and for their timely maintenance, repairs, and, if necessary, retrofit is attached. A description of the documentation procedures, recordkeeping practices, and inspection frequency are included in the plan and are specific to the site and/or BMP.
13. All control measures must be properly selected, installed, and maintained in accordance with the manufacturer's specifications and good engineering practices. If periodic inspections by the applicant or the executive director, or other information indicate a control has been used inappropriately, or incorrectly, the applicant must replace or modify the control for site situations.
14. If sediment escapes the construction site, off-site accumulations of sediment must be removed at a frequency sufficient to minimize offsite impacts to water quality (e.g., fugitive sediment in street being washed into surface streams or sensitive features by the next rain).
15. Sediment must be removed from sediment traps or sedimentation ponds not later than when design capacity has been reduced by 50%. A permanent stake will be provided that can indicate when the sediment occupies 50% of the basin volume.
16. Litter, construction debris, and construction chemicals exposed to stormwater shall be prevented from becoming a pollutant source for stormwater discharges (e.g., screening outfalls, picked up daily).

Soil Stabilization Practices

Examples: establishment of temporary vegetation, establishment of permanent vegetation, mulching, geotextiles, sod stabilization, vegetative buffer strips, protection of trees, or preservation of mature vegetation.

17. **Attachment J - Schedule of Interim and Permanent Soil Stabilization Practices.** A schedule of the interim and permanent soil stabilization practices for the site is attached.

18. Records must be kept at the site of the dates when major grading activities occur, the dates when construction activities temporarily or permanently cease on a portion of the site, and the dates when stabilization measures are initiated.
19. Stabilization practices must be initiated as soon as practicable where construction activities have temporarily or permanently ceased.

Administrative Information

20. All structural controls will be inspected and maintained according to the submitted and approved operation and maintenance plan for the project.
21. If any geologic or manmade features, such as caves, faults, sinkholes, etc., are discovered, all regulated activities near the feature will be immediately suspended. The appropriate TCEQ Regional Office shall be immediately notified. Regulated activities must cease and not continue until the TCEQ has reviewed and approved the methods proposed to protect the aquifer from any adverse impacts.
22. Silt fences, diversion berms, and other temporary erosion and sediment controls will be constructed and maintained as appropriate to prevent pollutants from entering sensitive features discovered during construction.

Attachment A - Spill Response Actions

The construction contractor will be capable of responding at any time to a spill. The contractor will have the tools available to dike, boom, or block off inlets to contain and prevent a spill that may occur on the site.

"Reportable spills" will be reported to the TCEQ at the Austin Region Call Number 512-339-2929 or Spill Reporting [24 Hour] at 800-832-8224 within 24 hours of the spill event. A reportable spill is one that meets any of the following criteria:

- 25 gallons of oil, fuel, and other hydrocarbon onto the ground
- Any amount of hydrocarbon that causes a visible sheen on waters of the United States including, but not limited to, stormwater runoff.

Guidance is also available in the Stormwater Pollution Prevention Plan developed for the site construction.

Spill Response Actions

Spill Prevention and Control

The objective of this section is to describe measures to prevent or reduce the discharge of pollutants to drainage systems or watercourses from leaks and spills by reducing the chance for spills, stopping the source of spills, containing and cleaning up spills, properly disposing of spill materials, and training employees.

The following steps will help reduce the stormwater impacts of leaks and spills:

Education

- (1) Be aware that different materials pollute in different amounts. Make sure that each employee knows what a "significant spill" is for each material they use, and what is the appropriate response for "significant" and "insignificant" spills. Employees should also be aware of when spill must be reported to the TCEQ. Information available in 30 TAC 327.4 and 40 CFR 302.4.
- (2) Educate employees and subcontractors on potential dangers to humans and the environment from spills and leaks.
- (3) Hold regular meetings to discuss and reinforce appropriate disposal procedures (incorporate into regular safety meetings).

- (4) Establish a continuing education program to indoctrinate new employees.
- (5) Have contractor's superintendent or representative oversee and enforce proper spill prevention and control measures.

General Measures

- (1) To the extent that the work can be accomplished safely, spills of oil, petroleum products, and substances listed under 40 CFR parts 110,117, and 302, and sanitary and septic wastes should be contained and cleaned up immediately.
- (2) Store hazardous materials and wastes in covered containers and protect from vandalism.
- (3) Place a stockpile of spill cleanup materials where it will be readily accessible.
- (4) Train employees in spill prevention and cleanup.
- (5) Designate responsible individuals to oversee and enforce control measures.
- (6) Spills should be covered and protected from storm water runoff during rainfall to the extent that it does not compromise cleanup activities.
- (7) Do not bury or wash spills with water.
- (8) Store and dispose of used clean up materials, contaminated materials, and recovered spill Material that is no longer suitable for the intended purpose in conformance with the provisions in applicable BMP's.
- (9) Do not allow water used for cleaning and decontamination to enter storm drains or watercourses. Collect and dispose of contaminated water in accordance with applicable regulations.
- (10) Contain water overflow or minor water spillage and do not allow it to discharge into drainage facilities or watercourses.
- (11) Place Material Safety Data Sheets (MSDS), as well as proper storage cleanup, and spill reporting instructions for hazardous materials stored or used on the project site in an open, conspicuous, and accessible location.
- (12) Keep waste storage areas clean, well-organized, and equipped with ample cleanup supplies as appropriate for the materials being stored. Perimeter controls, containment structures, covers, and liners should be repaired or replaced as needed to maintain proper function.

Cleanup

- (1) Clean up leaks and spills immediately.
- (2) Use a rag for small spills on paved surfaces, a damp mop for general cleanup, and absorbent material for larger spills. If the spilled material is hazardous, then the used cleanup materials are also hazardous and must be disposed of as hazardous waste.
- (3) Never hose down or bury dry material spills. Clean up as much of the material as possible and dispose of properly. See the waste management BMP's in this section specific information.

Minor Spills

- (1) Minor spills typically involve small quantities of oil, gasoline, paint, etc. which can be controlled by the first responder at the discovery of the spill.
on than hosing down or spill.
- (3) Absorbent materials should be promptly removed and disposed of properly.
- (4) Follow the practice below for a minor spill:
- (5) Contain the spread of the spill.
- (6) Recover spilled materials.
- (7) Clean the contaminated area and properly dispose of contaminated materials.

Semi-Significant Spills

Semi-significant spills still can be controlled by the first responder along with the aid of other personnel such as laborers and the foreman, etc. This response may require the cessation of all other activities.

Spills should be cleaned up immediately:

- (1) Contain spread of the spill.
- (2) Notify the project foreman immediately.
- (3) If the spill occurs on paved or impermeable surfaces, clean up using "dry" methods (absorbent materials, cat litter and/or rags). Contain the spill by encircling with absorbent materials and do not let the spill spread widely.
- (4) If the spill occurs in dirt areas, immediately contain the spill by constructing an earthen dike. Dig up and properly dispose of contaminated soil.
- (5) If the spill occurs during rain, cover spill with tarps or other material to prevent contaminating runoff.

Significant/Hazardous Spills

For significant or hazardous spills that are in reportable quantities:

- (1) Notify the TCEQ by telephone as soon as possible and within 24 hours at 512-339-2929 (Austin) or 210-490-3096 (San Antonio) between 8 AM and 5 PM. After hours, contact the Environmental Release Hotline at 1-800-832-8224. It is the contractor's responsibility to have all emergency phone numbers at the construction site.
- (2) For spills of federal reportable quantities, in conformance with the requirements in 40 CFR parts 110,119, and 302, the contractor should notify the National Response Center at (800) 424-8802.
- (3) Notification should first be made by telephone and followed up with a written report.
- (4) The services of a spills contractor or a Haz-Mat team should be obtained immediately.

Construction personnel should not attempt to clean up until the appropriate and qualified staffs have arrived at the job site.

(5) Other agencies which may need to be consulted include, but are not limited to, the City Police Department, County Sheriff Office, Fire departments, etc.

More information on spill rules and appropriate responses is available on the TCEQ website at: [http://www.truce.state.tx.us/enforcement! emergency Jesponse.html](http://www.truce.state.tx.us/enforcement!emergency%20response.html)

Vehicle and Equipment Maintenance

(1) If maintenance must occur onsite, use a designated area and a secondary containment, located away from drainage courses, to prevent the runoff of stormwater and the runoff of spills.

(2) Regularly inspect onsite vehicles and equipment for leaks and repair immediately

(3) Check incoming vehicles and equipment (including delivery trucks, and employee and subcontractor vehicles) for leaking oil and fluids. Do not allow leaking vehicles or equipment onsite.

(4) Always use secondary containment such as a drain pan or drop cloth, to catch spills or leaks when removing or changing fluids.

(5) Place drip pans or absorbent materials under paving equipment when not in use.

(6) Use absorbent materials on small spills rather than hosing down or burying the spill.

Remove the absorbent materials promptly and dispose of properly.

(7) Promptly transfer used fluids to the proper waste or recycling drums. Do not leave full drip pans or other open containers lying around.

(8) Oil filters disposed of in trashcans or dumpsters can leak oil and pollute storm water. Place the oil filter in a funnel over a waste oil-recycling drum to drain excess oil before disposal. Oil filters can also be recycled. Ask the oil supplier or recycler about recycling oil filters.

(9) Store cracked batteries in a non-leaking secondary container. Do this with all cracked batteries even if you think all the acid has drained out. If you drop a battery, treat it as if it is cracked. Put it into the containment area until you are sure it is not leaking.

Vehicle and Equipment Fueling

(1) If fueling must occur on site, use designated areas, located away from drainage courses, to prevent the runoff of storm water and the runoff of spills.

(2) Discourage "topping off" of fuel tanks.

(3) Always use secondary containment, such as a drain pan, when fueling to catch spills/leaks.

Attachment B: Potential Sources of Contamination

The only potential sources contamination are construction equipment leaks, re-fueling spills, and the total suspended solids (TSS) due to the construction activities on-site. The anticipated primary potential pollutants are sediment and concrete products. Apart from potential pollutants such as vehicle fluids, trash, and bacteria there are no other anticipated potential sources.

Potential sources of sediment to stormwater runoff:

Soil disturbing activities will include clearing, preparation of the ROW, grading, culvert replacement, and excavation for inlets, storm sewers, and utilities.

Potential pollutant and sources, other than sediment, to stormwater runoff:

Material	Storm Water Pollutants	Location
Concrete washout	Sediment, calcium carbonate	Concrete washout area/concrete installation areas
Lime slurry	Calcium carbonate	Roadway ROW
Lubricant	Hydrocarbons	Equipment parking area
Fuel	Hydrocarbons	Equipment parking area
Coolant	Organic compounds	Equipment parking area
Trash	Floatables	Roadway ROW
Portable toilet fluids	Bacteria	Break station
Cleaning supplies/solvents	Detergents, organic compounds	Equipment washing areas
Paint	Organic compounds, metals	Storage areas/application areas
Fertilizers	Nutrients	Storage areas/seeding locations
Wood	Floatables	Roadway ROW
Steel	Metals	Laydown areas
Sealants	Organic compounds	Storage areas

Remedies for potential sources of contamination:

1. Oil, grease, fuel and hydraulic contamination from construction equipment and vehicle leakage.

Remedy: Lubrication and fueling will be performed in a designated area. This area will be monitored daily for contamination.

2. Miscellaneous trash and litter from construction workers.

Remedy: Designated receptacles will be strategically located, and workers will be directed to deposit trash there.

3. Construction debris.

Remedy: Debris will be collected weekly and deposited in bins for offsite disposal. Situations requiring immediate attention will be handled on a case by case basis.

4. Asphalt products.

Remedy: After placement of asphalt, emulsion or coatings, the contractor will be responsible for immediate cleanup should an unexpected rain occur. For the duration of the asphalt product curing time, the contractor will maintain standby personnel and equipment to maintain and asphalt wash-off should and unexpected rain occurs. The contractor will be instructed not to place asphalt products on the ground within 48 hours of a forecasted rain.

5. Tar, fertilizers, cleaning solvents, detergents, and petroleum-based products.

Remedy: The contractor will be responsible for immediate cleanup should an unexpected rain occurs. Debris will be collected weekly and deposited in bins for offsite disposal. Situations requiring immediate attention will be handled on a case by case basis.

Environmental Site Assessment

Based on an environmental site assessment, no hazardous materials issues are present at the site. The Phase I Environmental Site Assessment was performed by aci Group, LLC. See attached ESA for further information.

Attachment C - Sequence of Major Activities

1. Send Notice of Intent to TCEQ at least 48 hours prior to commencement of construction (no site acreage disturbed).
2. Installation of temporary BMP's. Post site notice at the project site and install all erosion control BMPs as indicated on the erosion control plans including fiber rolls/silt fence, rock berms, construction exits, and storm inlet sediment traps (no site acreage disturbed).
3. Install all applicable barricades, work zone pavement markings, warning signs, detour signs and channelizing devices (less than .5 acre disturbed). Maintain fiber rolls/silt fence, rock berms, construction exits, and storm inlet sediment traps.
4. Minor site grading: This includes the removal of organic material and other debris within the proposed parking and building site. (approximately 1.2 acres disturbed).
5. Install all drainage, water & sanitary sewer structures per the plans & details including outlet structures (approximately 1 acre disturbed). Maintain fiber rolls/silt fence, rock berms, construction exits, and storm inlet sediment traps.
6. Sand Filter Pond Installation. Structure will be installed at the northern portion of the site (approximately 1 acre disturbed). See Permanent Storm Water Section.
7. Utility Installation: All primary utility mains have been installed and are available at the Sewer, water, and electrical services will be installed at this time.
8. Cutting and filling of the proposed site to prepare the site for parking and foundation construction. Perform all grading and paving operations to finished grade (approximately 1.8 acres disturbed). Maintain fiber rolls/silt fence, rock berms, construction exits, and storm inlet sediment traps.
9. Construct substructure (foundations) and superstructures for building. Maintain fiber rolls/silt fence, rock berms, construction exits, storm inlet sediment traps, storm outlet structures, and Stormtrooper stormwater treatment system.
10. Finished Final landscaping, asphalt parking and building infrastructure are installed. Approximate total area 1.8 acres
11. Clean up ROW (no additional acreage disturbed). Maintain fiber rolls/silt fence, rock berms, construction exits, and storm inlet sediment traps.
12. Install all permanent signs and pavement markings in accordance with the applicable details (no additional acreage disturbed). Maintain fiber rolls/silt fence, rock berms, construction exits, and storm inlet sediment traps.
13. Restore disturbed areas (via seeding and planting stabilization practices) and remove temporary erosion controls including fiber rolls/silt fence, rock berms, construction exits, and storm inlet sediment traps when the site is stabilized (no additional acreage disturbed).

Construction entrances for site will be accessed from Great Oaks Dr.

Attachment D - Temporary Best Management Practices and Measures

The following temporary BMPs and measures will prevent pollution of surface water or groundwater that originates on-site or flows off site, including pollution caused by contaminated stormwater runoff from the site:

- Preservation of natural resources/buffers
- Construction sequencing to reduce disturbance
- Temporary reinforced filter fabric fences/fiber logs/triangular silt dikes
- Temporary rock berms
- Temporary storm inlet sediment traps
- Stabilized construction entrance and exit
- Stabilized vehicle/equipment wash area

Details pertaining to quantities, placement, maintenance, and inspection of the temporary BMPs and practices are outlined in the Construction Plan Set.

The temporary BMPs described above will prevent pollutants from entering surface streams or the aquifer. There are no sensitive features identified in the geologic assessment (see General Information Form) that require protection or mitigation pursuant to TCEQ rules (30 TAC 213). If any subsurface voids are encountered during site development, work will halt immediately so that a geologist may assess the potential for the void(s) to provide meaningful contribution to the Edwards Aquifer.

Attachment E – Request to Temporary Seal a Feature

There will be no request to temporarily seal a feature.

Attachment F - Structural Practices

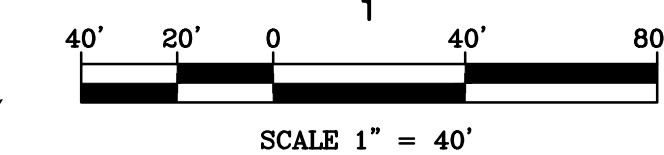
Reinforced filter fabric barriers will be used to remove sediments from runoff from overland flows prior to reaching a stormwater conveyance.

Inlet protection barriers will be used to remove sediments from runoff from overland flows prior to reaching a stormwater conveyance.

A vehicle/equipment wash area stabilized with coarse aggregate or approved substitute will be established near the staging/parking area for trucks and equipment leaving the site. Wash water will be directed to a trap.

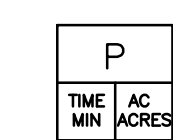
The project site will consist of various inlets along a linear ROW corridor. Structural controls will be provided for each inlet to prevent sediment from entering the storm sewer system. For this reason, a sediment basin for stormwater treatment during construction is not needed.

Attachment G - Drainage Area Map



LEGEND

- CONTOUR
- - - SOIL TYPE LINE
- - - TIME OF CONCENTRATION
- DRAINAGE AREA

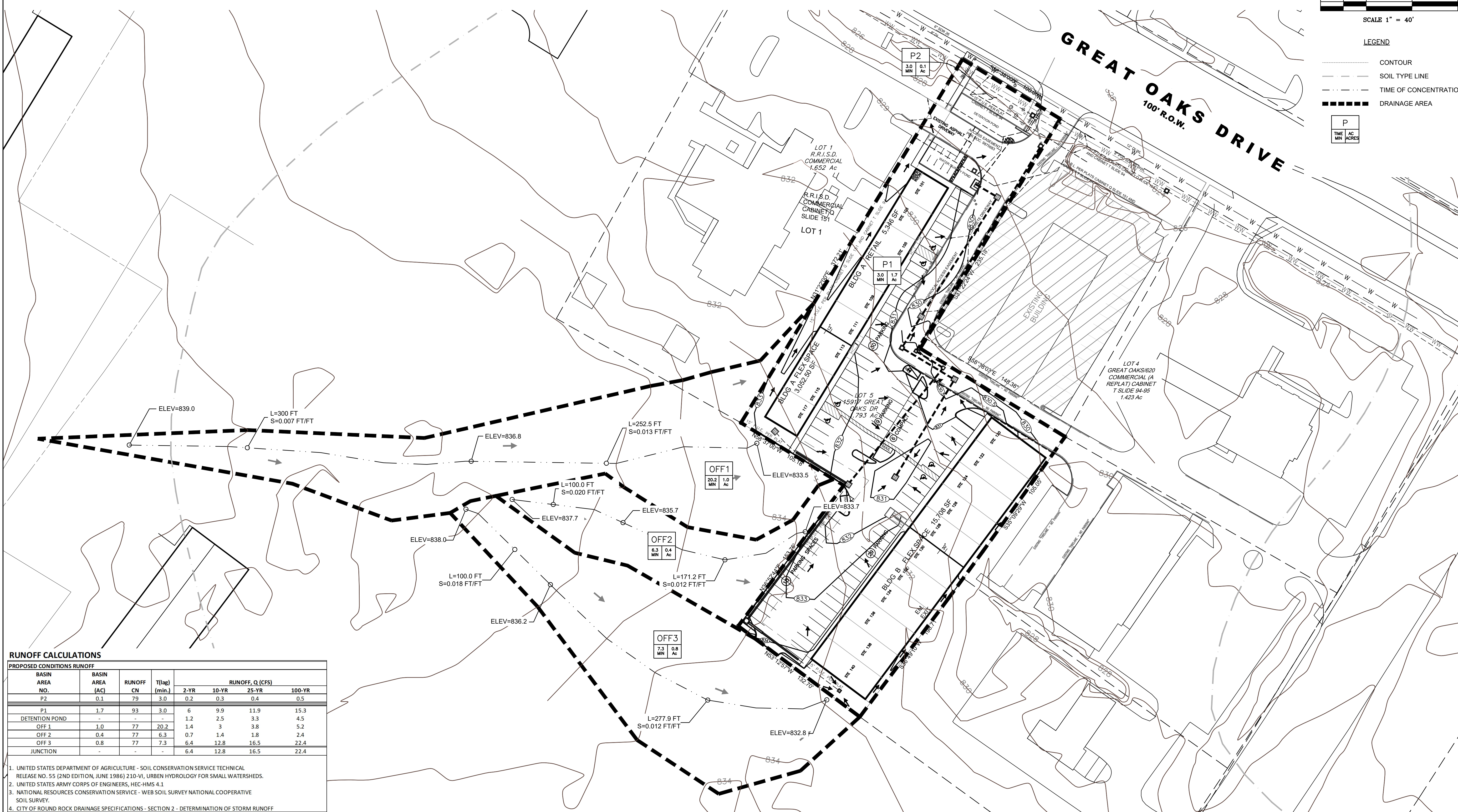
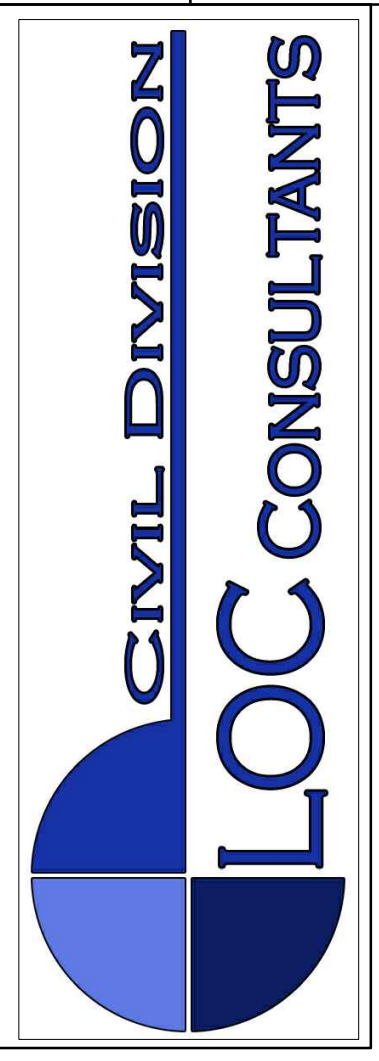


REVISIONS/ CORRECTIONS

NO.	DESCRIPTION



GREAT OAKS DR.
15917 GREAT OAKS DRIVE
PROPOSED DRAINAGE AREA MAP



RUNOFF CALCULATIONS

PROPOSED CONDITIONS RUNOFF

BASIN NO.	BASIN AREA (AC)	RUNOFF CN	T(lag) (min)	RUNOFF, Q (CFS)			
				2-YR	10-YR	25-YR	100-YR
P2	0.1	79	3.0	0.2	0.3	0.4	0.5
P1	1.7	93	3.0	6	9.9	11.9	15.3
DETENTION POND	-	-	-	1.2	2.5	3.3	4.5
OFF 1	1.0	77	20.2	1.4	3	3.8	5.2
OFF 2	0.4	77	6.3	0.7	1.4	1.8	2.4
OFF 3	0.8	77	7.3	6.4	12.8	16.5	22.4
JUNCTION	-	-	-	6.4	12.8	16.5	22.4

1. UNITED STATES DEPARTMENT OF AGRICULTURE - SOIL CONSERVATION SERVICE TECHNICAL RELEASE NO. 55 (2ND EDITION, JUNE 1986) 210-VI, URBEN HYDROLOGY FOR SMALL WATERSHEDS.
2. UNITED STATES ARMY CORPS OF ENGINEERS, HEC-HMS 4.1
3. NATIONAL RESOURCES CONSERVATION SERVICE - WEB SOIL SURVEY NATIONAL COOPERATIVE SOIL SURVEY.
4. CITY OF ROUND ROCK DRAINAGE SPECIFICATIONS - SECTION 2 - DETERMINATION OF STORM RUNOFF

Attachment H – Temporary Sediment Pond Plans and Calculations

There will not be more than 10 acres of disturbed soil in one common drainage area that will occur at one time. Silt fence will be used for small drainage areas. No sediment ponds will be constructed due to the minimal amount of soil disturbance.

Attachment I - Inspection and Maintenance for BMPs

Inspection and Maintenance Plan

The contractor is required to inspect the control and fences at weekly intervals and after any rainfall events to ensure that they are functioning properly. The person(s) responsible for maintenance controls and fences shall immediately make any necessary repairs to damaged areas. For areas of the construction site that have not been finally stabilized, areas used for storage of materials, structural control measures, and locations where vehicles enter or exit the site, personnel provided by the permittee and familiar with the WPAP will inspect disturbed areas at least once every 14 calendar days and within 24 hours of the end of a storm of 0.5 inch or greater. As an alternative to the above-described inspection schedule, and as previously mentioned, these inspections will occur at least once every 7 calendar days.

Each contractor will designate a qualified person or persons to perform the following inspections:

- Disturbed areas and areas used for storage of materials that are exposed to precipitation will be inspected for evidence of, or the potential for, pollutants entering the drainage system.
- Erosion and sediment control measures identified in the plan will be observed to ensure that they are operating correctly.
- Where discharge locations or points are accessible, they will be inspected to ascertain whether erosion control measures are effective in preventing significant impacts to receiving waters.
- Locations where vehicles enter or exit the site will be inspected for evidence of off-site sediment tracking.
- The vehicle/equipment wash area will be inspected for loss of aggregate, proper drainage, and proper maintenance of equipment.
- Inlets downstream of construction activities protected with filter fabric will be inspected and maintained to ensure they function properly.

After a portion of the site is finally stabilized, inspection will be conducted at least once every month.

Temporary Construction Entrance/Exit: The entrance should be maintained in a condition, which will prevent tracking or flowing of sediment onto public rights-of-way. This may require periodic top dressing with additional stone as conditions demand and repair and/or cleanout of any measures used to trap sediment. All sediment spilled, dropped, washed or tracked onto public rights-of-way should be removed immediately by contractor.

When necessary, wheels should be cleaned to remove sediment prior to entrance onto public right-of-way. When washing is required, it should be done on an area stabilized with crushed stone that drains into an approved sediment trap or sediment basin. All sediment should be prevented from entering any storm drain, ditch or water course by using approved methods.

Silt Fence: Remove sediment when buildup reaches 6 inches. Replace any torn fabric or install a second line of fencing parallel to the torn section. Replace or repair any sections crushed or collapsed during construction activity. If a section of fence is obstructing vehicular access, consider relocating it to a spot where it will provide equal protection, but will not obstruct vehicles. A triangular filter dike may be preferable to a silt fence at common vehicle access points. When construction is complete, the sediment should be disposed of in a manner that will not cause additional siltation and the prior location of the silt fence should be revegetated. The fence itself should be disposed of in an approved landfill.

Documentation: All scheduled inspection and maintenance measures made to the temporary BMPs must be documented clearly on the WPAP Site Plan showing inspection/maintenance measures performed, date, and person responsible for inspection and maintenance. Any changes made to the location or type of controls shown on the accepted plans, due to onsite conditions, shall be documented on the site plan that is part of this Water Pollution Abatement Plan. No other changes shall be made unless approved by TCEQ and the Design Engineer. Documentation shall clearly show changes made, date, and person responsible and reason change was made.

Inlets downstream of construction activities will be protected with filter fabric during construction activities. Sediment buildup will be removed daily. Torn fabric will be replaced within 24 hours. Silt and/or debris from construction activities will not be allowed to enter inlets.

Attachment J - Schedule of Interim and Permanent Soil Stabilization Practices

Once construction of the project has commenced, the construction activity is planned to continue until the project is complete. The water and wastewater trenches will be excavated. The trenches will then be re-excavated, and the water and wastewater lines will be installed. This work is intended to continue until all the lines are installed. The utility lines are located within the existing concrete driveway as shown on the site plan. As soon as the underground utilities are installed, the road base will be installed and compacted providing the interim soil stabilization for the paved area and the permanent soil stabilization for the parking areas. Once the warehouse buildings are built and landscaped this will provide permanent soil stabilization for the building areas.

Stabilization measures shall be initiated as soon as practicable in portions of the site where construction activities have temporarily or permanently ceased, but in no case more than 14 days after the construction activity in that portion of the site has temporary or permanently ceased. Where the initiation of stabilization measures by the 14th day after construction activity temporary or permanently cease is precluded by weather conditions, stabilization measures shall be initiated as soon as practicable. Where construction activity on a portion of the site is temporarily ceased, and earth disturbing activities will be resumed within 21 days, temporary stabilization measures do not have to be initiated on that portion of site. In areas experiencing droughts where the initiation of stabilization measures by the 14th day after construction activity has temporarily or permanently ceased is precluded by seasonal arid conditions, stabilization measures shall be initiated as soon as practicable.

The following schedule is as included in the Storm Water Prevention Plan.

1. Install sediment barriers and stabilized construction entrance. Stabilized construction exits will be provided at major access points using coarse aggregate or approved substitute.
2. The on-site staging and parking area will be stabilized using coarse aggregate or approved substitute.
3. In completed pavement sections, all disturbed land within the ROW will be stabilized to minimize erosion and sediment as soon as possible.
4. At the end of paving work, all disturbed areas that are not paved around the building areas will be planted with sod.
5. Remove temporary erosion controls when the site is stabilized.

7. TCEQ-0600 Permanent Stormwater Section

Permanent Stormwater Section

Texas Commission on Environmental Quality

for Regulated Activities on the Edwards Aquifer Recharge Zone and Relating to 30 TAC §213.5(b)(4)(C), (D)(Ii), (E), and (5), Effective June 1, 1999

To ensure that the application is administratively complete, confirm that all fields in the form are complete, verify that all requested information is provided, consistently reference the same site and contact person in all forms in the application, and ensure forms are signed by the appropriate party.

Note: Including all the information requested in the form and attachments contributes to more streamlined technical reviews.

Signature

To the best of my knowledge, the responses to this form accurately reflect all information requested concerning the proposed regulated activities and methods to protect the Edwards Aquifer. This **Permanent Stormwater Section** is hereby submitted for TCEQ review and executive director approval. The application was prepared by:

Print Name of Customer/Agent: Sergio N. Lozano-Sanchez, PE

Date: 10/20/2023

Signature of Customer/Agent



Regulated Entity Name: 15917 Great Oaks Drive

Permanent Best Management Practices (BMPs)

Permanent best management practices and measures that will be used during and after construction is completed.

- Permanent BMPs and measures must be implemented to control the discharge of pollution from regulated activities after the completion of construction.
 N/A
- These practices and measures have been designed, and will be constructed, operated, and maintained to insure that 80% of the incremental increase in the annual mass loading of total suspended solids (TSS) from the site caused by the regulated activity is removed. These quantities have been calculated in accordance with technical guidance prepared or accepted by the executive director.
 The TCEQ Technical Guidance Manual (TGM) was used to design permanent BMPs and measures for this site.

A technical guidance other than the TCEQ TGM was used to design permanent BMPs and measures for this site. The complete citation for the technical guidance that was used is: _____

N/A

3. Owners must ensure that permanent BMPs and measures are constructed and function as designed. A Texas Licensed Professional Engineer must certify in writing that the permanent BMPs or measures were constructed as designed. The certification letter must be submitted to the appropriate regional office within 30 days of site completion.

N/A

4. Where a site is used for low density single-family residential development and has 20 % or less impervious cover, other permanent BMPs are not required. This exemption from permanent BMPs must be recorded in the county deed records, with a notice that if the percent impervious cover increases above 20% or land use changes, the exemption for the whole site as described in the property boundaries required by 30 TAC §213.4(g) (relating to Application Processing and Approval), may no longer apply and the property owner must notify the appropriate regional office of these changes.

The site will be used for low density single-family residential development and has 20% or less impervious cover.

The site will be used for low density single-family residential development but has more than 20% impervious cover.

The site will not be used for low density single-family residential development.

5. The executive director may waive the requirement for other permanent BMPs for multi-family residential developments, schools, or small business sites where 20% or less impervious cover is used at the site. This exemption from permanent BMPs must be recorded in the county deed records, with a notice that if the percent impervious cover increases above 20% or land use changes, the exemption for the whole site as described in the property boundaries required by 30 TAC §213.4(g) (relating to Application Processing and Approval), may no longer apply and the property owner must notify the appropriate regional office of these changes.

Attachment A - 20% or Less Impervious Cover Waiver. The site will be used for multi-family residential developments, schools, or small business sites and has 20% or less impervious cover. A request to waive the requirements for other permanent BMPs and measures is attached.

The site will be used for multi-family residential developments, schools, or small business sites but has more than 20% impervious cover.

The site will not be used for multi-family residential developments, schools, or small business sites.

6. **Attachment B - BMPs for Upgradient Stormwater.**

- A description of the BMPs and measures that will be used to prevent pollution of surface water, groundwater, or stormwater that originates upgradient from the site and flows across the site is attached.
 - No surface water, groundwater or stormwater originates upgradient from the site and flows across the site, and an explanation is attached.
 - Permanent BMPs or measures are not required to prevent pollution of surface water, groundwater, or stormwater that originates upgradient from the site and flows across the site, and an explanation is attached.
7. **Attachment C - BMPs for On-site Stormwater.**
- A description of the BMPs and measures that will be used to prevent pollution of surface water or groundwater that originates on-site or flows off the site, including pollution caused by contaminated stormwater runoff from the site is attached.
 - Permanent BMPs or measures are not required to prevent pollution of surface water or groundwater that originates on-site or flows off the site, including pollution caused by contaminated stormwater runoff, and an explanation is attached.
8. **Attachment D - BMPs for Surface Streams.** A description of the BMPs and measures that prevent pollutants from entering surface streams, sensitive features, or the aquifer is attached. Each feature identified in the Geologic Assessment as sensitive has been addressed.
- N/A
9. The applicant understands that to the extent practicable, BMPs and measures must maintain flow to naturally occurring sensitive features identified in either the geologic assessment, executive director review, or during excavation, blasting, or construction.
- The permanent sealing of or diversion of flow from a naturally-occurring sensitive feature that accepts recharge to the Edwards Aquifer as a permanent pollution abatement measure has not been proposed.
 - Attachment E - Request to Seal Features.** A request to seal a naturally-occurring sensitive feature, that includes, for each feature, a justification as to why no reasonable and practicable alternative exists, is attached.
10. **Attachment F - Construction Plans.** All construction plans and design calculations for the proposed permanent BMP(s) and measures have been prepared by or under the direct supervision of a Texas Licensed Professional Engineer, and are signed, sealed, and dated. The plans are attached and, if applicable include:
- Design calculations (TSS removal calculations)
 - TCEQ construction notes
 - All geologic features
 - All proposed structural BMP(s) plans and specifications
- N/A

11. **Attachment G - Inspection, Maintenance, Repair and Retrofit Plan.** A plan for the inspection, maintenance, repairs, and, if necessary, retrofit of the permanent BMPs and measures is attached. The plan includes all of the following:
- Prepared and certified by the engineer designing the permanent BMPs and measures
 - Signed by the owner or responsible party
 - Procedures for documenting inspections, maintenance, repairs, and, if necessary retrofit
 - A discussion of record keeping procedures
- N/A
12. **Attachment H - Pilot-Scale Field Testing Plan.** Pilot studies for BMPs that are not recognized by the Executive Director require prior approval from the TCEQ. A plan for pilot-scale field testing is attached.
- N/A
13. **Attachment I - Measures for Minimizing Surface Stream Contamination.** A description of the measures that will be used to avoid or minimize surface stream contamination and changes in the way in which water enters a stream as a result of the construction and development is attached. The measures address increased stream flashing, the creation of stronger flows and in-stream velocities, and other in-stream effects caused by the regulated activity, which increase erosion that results in water quality degradation.
- N/A

Responsibility for Maintenance of Permanent BMP(s)

Responsibility for maintenance of best management practices and measures after construction is complete.

14. The applicant is responsible for maintaining the permanent BMPs after construction until such time as the maintenance obligation is either assumed in writing by another entity having ownership or control of the property (such as without limitation, an owner's association, a new property owner or lessee, a district, or municipality) or the ownership of the property is transferred to the entity. Such entity shall then be responsible for maintenance until another entity assumes such obligations in writing or ownership is transferred.
- N/A
15. A copy of the transfer of responsibility must be filed with the executive director at the appropriate regional office within 30 days of the transfer if the site is for use as a multiple single-family residential development, a multi-family residential development, or a non-residential development such as commercial, industrial, institutional, schools, and other sites where regulated activities occur.
- N/A

Attachment A – 20% or Less Impervious Cover Waiver

N/A. Not requested. Permanent BMP's will be designed in accordance with TCEQ requirements for the removal of TSS generated by the proposed development.

Attachment B - BMPs for Upgradient Stormwater

The upgradient stormwater would continue to be accepted onto the project site. The stormwater runoff from the areas that are immediately upgradient (Beck Preserve) are currently undeveloped and will remain undeveloped.

Attachment C - BMPs for On-Site Stormwater

The permanent BMP's used to treat on-site storm water runoff will be a Sand Filter System. Please refer to the Drainage Area Map in the Temporary Stormwater Section for areas of treatment and BMP structures used.

The proposed area to be disturbed is 1.71 acres with 1.469 acres/81.91% of proposed impervious cover. The proposed construction will include minor grading for the parking areas and building pad, utility service lines and building infrastructure. The water quality goal is to remove 89% of the increased total suspended solids (TSS) from the proposed project area. As presented in the design calculations (Permanent Stormwater Section), this will be accomplished using sand filter system constructed in conjunction with the storm drainage system. The design calculations demonstrate that the proposed project adds approximately 1.22 acres of impervious cover and requires 1003 lbs. of TSS removal.

Attachment D - BMPs for Surface Streams

The Sand Filter System will be installed to prevent pollutants from entering surface streams and ultimately the aquifer. There were no sensitive features identified by the Geologic Assessment.

The natural vegetation located down gradient of proposed improvements will provide additional filtration to help prevent pollution from entering streams, sensitive features and the aquifer.

Attachment E – Request to Seal Features

N/A. There were no sensitive features identified by the Geologic Assessment. The permanent sealing of or diversion of flow from a naturally-occurring sensitive feature that accepts recharge to the Edwards Aquifer as a permanent pollution abatement measure has not been proposed.

Attachment F – Construction Plans

Refer to 15917 Great Oaks Drive Site Plan Set.

Attachment G - Inspection, Maintenance, Repair and Retrofit Plan

Sand Filter Systems Maintenance and Monitoring Procedures

Inspections: BMP facilities must be inspected at least twice a year (once during or immediately following wet weather) to evaluate facility operation. During each inspection, erosion areas inside and downstream of the BMP must be identified and repaired or revegetated immediately. With each inspection, any damage to the structural elements of the system (pipes, concrete drainage structures, retaining walls, etc.) must be identified and repaired immediately. Cracks, voids and undermining should be patched/filled to prevent additional structural damage.

Sediment Removal: Remove sediment from the inlet structure and sedimentation chamber when sediment buildup reaches a depth of 6 inches or when the proper functioning of inlet and outlet structures is impaired. Sediment should be cleared from the inlet structure at least every year and from the sedimentation basin at least every 5 years.

Media Replacement: Maintenance of the filter media is necessary when the drawdown time exceeds 48 hours. When this occurs, the upper layer of sand should be removed and replaced with new material meeting the original specifications. Any discolored sand should also be removed and replaced. In filters that have been regularly maintained, this should be limited to the top 2 to 3 inches.

Debris and Litter Removal: Debris and litter will accumulate near the sedimentation basin outlet device and should be removed during regular mowing operations and inspections. Particular attention should be paid to floating debris that can eventually clog the control device or riser.

Filter Underdrain: Clean underdrain piping network to remove any sediment buildup as needed to maintain design drawdown time.

Mowing: Grass areas in and around sand filters must be mowed at least twice annually to limit vegetation height to 18 inches. More frequent mowing to maintain aesthetic appeal may be necessary in landscaped areas. Vegetation on the pond embankments should be mowed as appropriate to prevent the establishment of woody vegetation.

Attachment G

Inspection, Maintenance, Repair and Retrofit Plan

Sand Filtration Pond Location:

The Sand Filtration Pond will be along the northern property line of the site.

Owner:

Hanumantharao Mekala
Creek Edge Peppers LLC
907 Screech Owl Dr
Austin, TX 78660
Telephone: (978)761-6525
Email: hanuma614@gmail.com

I agree that the attached Sand Filtration Pond Maintenance and Monitoring Procedures will be implemented to ensure that the proposed system functions as designed.

Hanumantharao Mekala

Hanumantharao Mekala
Creek Edge Peppers LLC

10/25/2022

Date

Attachment G

Inspection, Maintenance, Repair and Retrofit Plan

I have reviewed the attached maintenance and monitoring procedures and to the best of my knowledge certify that, if they are followed as outlined, the Sand Filtration Pond will function as designed.



Sergio N. Lozano-Sanchez, P.E.

LOC Consultants Civil Division Inc.

10/25/23

Date

Attachment H – Pilot Scale Field Testing Plan

N/A.

Attachment I – Measures for Minimizing Surface Stream Contamination

N/A. The storm water runoff for the property will be concentrated into the Sand Filter system where the pollutants will be removed.

8. TCEQ-0599 Agent Authorization Form

Agent Authorization Form

For Required Signature

Edwards Aquifer Protection Program

Relating to 30 TAC Chapter 213

Effective June 1, 1999

I Hanumantharao Mekala _____,

Print Name

Manager _____,

Title - Owner/President/Other

of Creek Edge Peppers LLC _____,

Corporation/Partnership/Entity Name

have authorized Sergio N. Lozano-Sanchez, PE _____

Print Name of Agent/Engineer

of LOC Consultants Civil Division Inc. _____

Print Name of Firm

to represent and act on the behalf of the above named Corporation, Partnership, or Entity for the purpose of preparing and submitting this plan application to the Texas Commission on Environmental Quality (TCEQ) for the review and approval consideration of regulated activities.

I also understand that:

1. The applicant is responsible for compliance with 30 Texas Administrative Code Chapter 213 and any condition of the TCEQ's approval letter. The TCEQ is authorized to assess administrative penalties of up to \$10,000 per day per violation.
2. For those submitting an application who are not the property owner, but who have the right to control and possess the property, additional authorization is required from the owner.
3. Application fees are due and payable at the time the application is submitted. The application fee must be sent to the TCEQ cashier or to the appropriate regional office. The application will not be considered until the correct fee is received by the commission.
4. A notarized copy of the Agent Authorization Form must be provided for the person preparing the application, and this form must accompany the completed application.
5. No person shall commence any regulated activity on the Edwards Aquifer Recharge Zone, Contributing Zone or Transition Zone until the appropriate application for the activity has been filed with and approved by the Executive Director.

SIGNATURE PAGE:

Hanumantha Rao M

Applicant's Signature

10/21/2022

Date

THE STATE OF TEXAS §

County of TRAVIS §

BEFORE ME, the undersigned authority, on this day personally appeared ^{Hanumantha}Mekala known to me to be the person whose name is subscribed to the foregoing instrument, and acknowledged to me that (s)he executed same for the purpose and consideration therein expressed.

GIVEN under my hand and seal of office on this 21 day of October, 2023

Noah Flippo

NOTARY PUBLIC



NOAH FLIPPO

Typed or Printed Name of Notary

MY COMMISSION EXPIRES: MAY 18, 2027

9. TCEQ-0574 Application Fee Form

Application Fee Form

Texas Commission on Environmental Quality

Name of Proposed Regulated Entity: 15917 Great Oaks Dr.

Regulated Entity Location: 15917 Great Oaks Dr, Round Rock, TX 78681

Name of Customer: Creek Edge Peppers LLC

Contact Person: Sergio Lozano-Sanchez, PE

Phone: 512-524-0677

Customer Reference Number (if issued): CN _____

Regulated Entity Reference Number (if issued): RN S111086294

Austin Regional Office (3373)

Hays

Travis

Williamson

San Antonio Regional Office (3362)

Bexar

Medina

Uvalde

Comal

Kinney

Application fees must be paid by check, certified check, or money order, payable to the **Texas Commission on Environmental Quality**. Your canceled check will serve as your receipt. **This form must be submitted with your fee payment.** This payment is being submitted to:

Austin Regional Office

San Antonio Regional Office

Mailed to: TCEQ - Cashier

Overnight Delivery to: TCEQ - Cashier

Revenues Section

Mail Code 214

P.O. Box 13088

Austin, TX 78711-3088

12100 Park 35 Circle

Building A, 3rd Floor

Austin, TX 78753

(512)239-0357

Site Location (Check All That Apply):

Recharge Zone

Contributing Zone

Transition Zone

<i>Type of Plan</i>	<i>Size</i>	<i>Fee Due</i>
Water Pollution Abatement Plan, Contributing Zone Plan: One Single Family Residential Dwelling	Acres	\$
Water Pollution Abatement Plan, Contributing Zone Plan: Multiple Single Family Residential and Parks	Acres	\$
Water Pollution Abatement Plan, Contributing Zone Plan: Non-residential	1.793 Acres	\$ 4,000
Sewage Collection System	L.F.	\$
Lift Stations without sewer lines	Acres	\$
Underground or Aboveground Storage Tank Facility	Tanks	\$
Piping System(s)(only)	Each	\$
Exception	Each	\$
Extension of Time	Each	\$

Signature: 

Date: 10/25/23

Application Fee Schedule

Texas Commission on Environmental Quality

Edwards Aquifer Protection Program 30 TAC Chapter 213 (effective 05/01/2008)

Water Pollution Abatement Plans and Modifications

Contributing Zone Plans and Modifications

<i>Project</i>	<i>Project Area in Acres</i>	<i>Fee</i>
One Single Family Residential Dwelling	< 5	\$650
Multiple Single Family Residential and Parks	< 5	\$1,500
	5 < 10	\$3,000
	10 < 40	\$4,000
	40 < 100	\$6,500
	100 < 500	\$8,000
	≥ 500	\$10,000
Non-residential (Commercial, industrial, institutional, multi-family residential, schools, and other sites where regulated activities will occur)	< 1	\$3,000
	1 < 5	\$4,000
	5 < 10	\$5,000
	10 < 40	\$6,500
	40 < 100	\$8,000
	≥ 100	\$10,000

Organized Sewage Collection Systems and Modifications

<i>Project</i>	<i>Cost per Linear Foot</i>	<i>Minimum Fee- Maximum Fee</i>
Sewage Collection Systems	\$0.50	\$650 - \$6,500

Underground and Aboveground Storage Tank System Facility Plans and Modifications

<i>Project</i>	<i>Cost per Tank or Piping System</i>	<i>Minimum Fee- Maximum Fee</i>
Underground and Aboveground Storage Tank Facility	\$650	\$650 - \$6,500

Exception Requests

<i>Project</i>	<i>Fee</i>
Exception Request	\$500

Extension of Time Requests

<i>Project</i>	<i>Fee</i>
Extension of Time Request	\$150

10. TCEQ-10400 Core Data Form



TCEQ Use Only

TCEQ Core Data Form

For detailed instructions regarding completion of this form, please read the Core Data Form Instructions or call 512-239-5175.

SECTION I: General Information

1. Reason for Submission (If other is checked please describe in space provided.)		
<input checked="" type="checkbox"/> New Permit, Registration or Authorization (Core Data Form should be submitted with the program application.)		
<input type="checkbox"/> Renewal (Core Data Form should be submitted with the renewal form)	<input type="checkbox"/> Other	
2. Customer Reference Number (if issued)	Follow this link to search for CN or RN numbers in Central Registry**	3. Regulated Entity Reference Number (if issued)
CN		RN 111086294

SECTION II: Customer Information

4. General Customer Information		5. Effective Date for Customer Information Updates (mm/dd/yyyy)	
<input checked="" type="checkbox"/> New Customer		<input type="checkbox"/> Update to Customer Information	
<input type="checkbox"/> Change in Legal Name (Verifiable with the Texas Secretary of State or Texas Comptroller of Public Accounts)		<input type="checkbox"/> Change in Regulated Entity Ownership	
The Customer Name submitted here may be updated automatically based on what is current and active with the Texas Secretary of State (SOS) or Texas Comptroller of Public Accounts (CPA).			
6. Customer Legal Name (If an individual, print last name first: eg: Doe, John)		If new Customer, enter previous Customer below:	
Creek Edge Peppers LLC		KJ Investment Partners LLC	
7. TX SOS/CPA Filing Number	8. TX State Tax ID (11 digits)	9. Federal Tax ID (9 digits)	10. DUNS Number (if applicable)
0804732860	32086370858		
11. Type of Customer:	<input checked="" type="checkbox"/> Corporation	<input type="checkbox"/> Individual	Partnership: <input type="checkbox"/> General <input type="checkbox"/> Limited
Government: <input type="checkbox"/> City <input type="checkbox"/> County <input type="checkbox"/> Federal <input type="checkbox"/> State <input type="checkbox"/> Other	<input type="checkbox"/> Sole Proprietorship	<input type="checkbox"/> Other:	
12. Number of Employees		13. Independently Owned and Operated?	
<input checked="" type="checkbox"/> 0-20 <input type="checkbox"/> 21-100 <input type="checkbox"/> 101-250 <input type="checkbox"/> 251-500 <input type="checkbox"/> 501 and higher		<input checked="" type="checkbox"/> Yes <input type="checkbox"/> No	
14. Customer Role (Proposed or Actual) – as it relates to the Regulated Entity listed on this form. Please check one of the following			
<input checked="" type="checkbox"/> Owner <input type="checkbox"/> Operator <input type="checkbox"/> Owner & Operator			
<input type="checkbox"/> Occupational Licensee <input type="checkbox"/> Responsible Party <input type="checkbox"/> Voluntary Cleanup Applicant <input type="checkbox"/> Other:			
15. Mailing Address:	907 Screech Owl Dr		
	City	Pflugerville	State TX ZIP 78660 ZIP + 4
16. Country Mailing Information (if outside USA)		17. E-Mail Address (if applicable)	
		hanuma614@gmail.com	
18. Telephone Number	19. Extension or Code	20. Fax Number (if applicable)	
(978) 761-6525		() -	

SECTION III: Regulated Entity Information

21. General Regulated Entity Information (If 'New Regulated Entity' is selected below this form should be accompanied by a permit application)
<input type="checkbox"/> New Regulated Entity <input type="checkbox"/> Update to Regulated Entity Name <input checked="" type="checkbox"/> Update to Regulated Entity Information
The Regulated Entity Name submitted may be updated in order to meet TCEQ Agency Data Standards (removal of organizational endings such as Inc, LP, or LLC).
22. Regulated Entity Name (Enter name of the site where the regulated action is taking place.)
15917 GREAT OAKS DR

23. Street Address of the Regulated Entity: <i>(No PO Boxes)</i>	15917 S GREAT OAKS DR						
	City	RoundRock	State	TX	ZIP	78681	ZIP + 4
24. County	WILLIAMSON						

Enter Physical Location Description if no street address is provided.

25. Description to Physical Location:							
26. Nearest City					State	Nearest ZIP Code	
27. Latitude (N) In Decimal:	30.4933			28. Longitude (W) In Decimal:	-97.7276		
Degrees	Minutes	Seconds	Degrees	Minutes	Seconds		
30	29	35.88	-97	43	39.3594		
29. Primary SIC Code (4 digits)	30. Secondary SIC Code (4 digits)		31. Primary NAICS Code (5 or 6 digits)		32. Secondary NAICS Code (5 or 6 digits)		
4225			493110				
33. What is the Primary Business of this entity? <i>(Do not repeat the SIC or NAICS description.)</i>							
Office-Warehouse							
34. Mailing Address:	907 Screech Owl Dr,						
	City	Pflugerville	State	TX	ZIP	78660	ZIP + 4
35. E-Mail Address:	hanuma614@gmail.com						
36. Telephone Number		37. Extension or Code			38. Fax Number <i>(if applicable)</i>		
(978) 761-6525					() -		

39. TCEQ Programs and ID Numbers Check all Programs and write in the permits/registration numbers that will be affected by the updates submitted on this form. See the Core Data Form instructions for additional guidance.


<input type="checkbox"/> Dam Safety	<input type="checkbox"/> Districts	<input checked="" type="checkbox"/> Edwards Aquifer	<input type="checkbox"/> Emissions Inventory Air	<input type="checkbox"/> Industrial Hazardous Waste
<input type="checkbox"/> Municipal Solid Waste	<input type="checkbox"/> New Source Review Air	<input type="checkbox"/> OSSF	<input type="checkbox"/> Petroleum Storage Tank	<input type="checkbox"/> PWS
<input type="checkbox"/> Sludge	<input type="checkbox"/> Storm Water	<input type="checkbox"/> Title V Air	<input type="checkbox"/> Tires	<input type="checkbox"/> Used Oil
<input type="checkbox"/> Voluntary Cleanup	<input type="checkbox"/> Waste Water	<input type="checkbox"/> Wastewater Agriculture	<input type="checkbox"/> Water Rights	<input type="checkbox"/> Other:

SECTION IV: Preparer Information

40. Name:	SERGIO LOZANO - SANCHEZ		41. Title:	PRINCIPAL
42. Telephone Number	43. Ext./Code	44. Fax Number	45. E-Mail Address	
(512) 587-7236		() -	SERGIO@LOCCIVIL.COM	

SECTION V: Authorized Signature

46. By my signature below, I certify, to the best of my knowledge, that the information provided in this form is true and complete, and that I have signature authority to submit this form on behalf of the entity specified in Section II, Field 6 and/or as required for the updates to the ID numbers identified in field 39.

Company:	LOC CONSULTANTS, CIVIL DIVISION INC	Job Title:	PRINCIPAL
Name <i>(In Print)</i> :	SERGIO LOZANO-SANCHEZ, P.E.	Phone:	(512) 587- 7236
Signature:		Date:	10/20/2023

11. SITE PLAN SET

15917 GREAT OAK DRIVE SITE PLAN

15917 GREAT OAKS DRIVE

ROUND ROCK, TEXAS 78681

OWNER:

CREEK EDGE PEPPERS LLC
HANUMANTHARAO MEKALA
907 SCREECH OWL DR
PFLUGERVILLE, TEXAS 78660
hanuma614@gmail.com

ENGINEER

LOC CONSULTANTS CIVIL DIVISION
SERGIO LOZANO-SANCHEZ P.E.
2211 S IH35, SUITE 107
AUSTIN, TX 78702
PHONE: (512)524-0677 FIRM NO. 23579



FIRE DEPARTMENT

DESIGN STANDARDS	2015 IFC WITH SAM BASS FIRE DEPT. LOCAL AMENDMENT
FIRE FLOW DEMAND @ 20 PSI	3250 GPM/2 HRS
INTENDED USE	GYMNASIUM
CONSTRUCTION CLASSIFICATION	TYPE II B
BUILDING FIRE AREA	22,580 SF
AUTOMATIC FIRE SPRINKLER	50%
FIRE FLOW DEMAND REDUCTION (50%)	NFPA 13
REDUCE FIRE FLOW DEMAND	812 GPM
MINIMUM FLOW REQUIRED AT ANY SITE PER COA	1,500 GPM
AVAILABLE FIRE FLOW @ 20 PSI	(1,625 GPM MINIMUM)

SINCE THE CERTIFICATE OF COMPLAIANCE PARMIT CC-2019-16151 WAS ISSUED, THE SITE WAS SOLD AND THE FOLLOWING CHANGES MADE TO THE SITE LAYOUT: REDUCED BUILDING SIZES, CHANGED USES, ADDED ADA FEATURES, MAIL BOXES AND DUMPSTER PAD. THE OFFSITE AND ONSITE DRAINAGE FACILITIES HAVE NOT CHANGED. WATER AND WASTEWATER FACILITIES ARE SLIGHTLY REVISED.

INDEX OF DRAWINGS

- COVERSHEET
- APPROVED SUBDIVISION PLAT
- EXISTING CONDITIONS AND DEMOLITION
- SITE PLAN
- EXISTING DRAINAGE AREA MAP
- PROPOSED DRAINAGE AREA MAP
- GRADING PLAN
- DETENTION AND WATER QUALITY PONDS PLAN
- DETENTION AND WATER QUALITY PONDS DETAILS
- DETENTION AND WATER QUALITY PONDS CALCULATIONS
- EROSION & SEDIMENTATION CONTROLS PLAN
- WATER PLAN
- WASTEWATER PLAN & PROFILE
- UTILITY DETAILS I
- UTILITY DETAILS II
- GENERAL NOTES
- GENERAL DETAILS

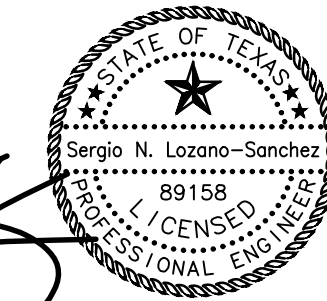


LEGAL DESCRIPTION:
LOT 5, BLOCK A, GREAT OAKS/620 COMMERCIAL (A REPLAT), 1.793 ACRES, A SUBDIVISION IN WILLIAMSON COUNTY, TEXAS, ACCORDING TO THE MAP OR PLAT THEREOF RECORDED IN CABINET T SLIDES 94-95 OF THE PLAT RECORDS OF WILLIAMSON COUNTY, TEXAS.

I CERTIFY THAT THESE ENGINEERING DOCUMENTS ARE COMPLETE, ACCURATE AND ADEQUATE FOR THE INTENDED PURPOSES, INCLUDING CONSTRUCTION, BUT ARE NOT AUTHORIZED FOR CONSTRUCTION PRIOR TO FORMAL CITY APPROVAL. I DO HEREBY CERTIFY THAT THE ENGINEERING WORK BEING SUBMITTED HEREIN COMPLIES WITH ALL PROVISIONS OF THE TEXAS ENGINEERING PRACTICE ACT. I HEREBY ACKNOWLEDGE THAT ANY MISREPRESENTATION REGARDING THIS CERTIFICATION CONSTITUTES A VIOLATION OF THE ACT, AND MAY RESULT IN CRIMINAL, CIVIL AND/OR ADMINISTRATIVE PENALTIES AGAINST ME, AS AUTHORIZED BY THE ACT.

SUBMITTED BY:

SERGIO LOZANO, TEXAS P.E.



02/29/2024
DATE

REVIEWED FOR COMPLIANCE WITH COUNTY REQUIREMENTS:

WILLIAMSON COUNTY ENGINEERS OFFICE

DATE

BRUSHY CREEK M.U.D.

DATE

SAMBASS EMERGENCY SERVICES DISTRICT

DATE

CITY OF ROUND ROCK ETJ

DATE

GENERAL CONSTRUCTION NOTES

- ALL RESPONSIBILITY FOR THE ADEQUACY OF THESE PLANS REMAINS WITH THE ENGINEER WHO PREPARED THEM. IN APPROVING THESE PLANS, THE WILLIAMSON COUNTY MUST RELY ON THE ADEQUACY OF THE WORK OF THE DESIGN ENGINEER.
- CONTRACTOR SHALL CALL THE "ONE CALL SYSTEM" (1-800-344-8377) FOR UTILITY LOCATIONS PRIOR TO ANY WORK IN THE CITY EASEMENTS OR STREET R.O.W.
- CONTRACTOR SHALL NOTIFY THE WILLIAMSON COUNTY ENGINEERS OFFICE AT 974-7161 AT LEAST 24 HOURS PRIOR TO THE INSTALLATION OF ANY DRAINAGE FACILITY WITHIN A DRAINAGE EASEMENT OR STREET R.O.W. THE METHOD OF PLACEMENT AND COMPACTION OF BACKFILL IN THE CITY'S R.O.W. MUST BE APPROVED PRIOR TO THE START OF BACKFILL OPERATIONS.
- FOR SLOPES OR TRENCHES GREATER THAN FIVE FEET IN DEPTH, "ALL CONSTRUCTION OPERATIONS SHALL BE IN ACCORDANCE WITH APPLICABLE REGULATIONS OF THE U.S. OCCUPATIONAL SAFETY AND HEALTH ADMINISTRATION (OSHA)." (OSHA STANDARDS MAY BE PURCHASED FROM THE GOVERNMENT PRINTING OFFICE; INFORMATION AND RELATED REFERENCE MATERIALS MAY BE PURCHASED FROM OSHA, 611 EAST 6TH STREET, AUSTIN, TEXAS.)
- ALL SITE WORK MUST COMPLY WITH ENVIRONMENTAL REQUIREMENTS.
- UPON COMPLETION OF THE PROPOSED SITE IMPROVEMENTS
 - * RELEASE OF THE CERTIFICATE OF OCCUPANCY BY THE DEPARTMENT OF DEVELOPMENT REVIEW AND INSPECTIONS; OR,
 - * INSTALLATION OF AN ELECTRICAL OR WATER METER (IN THE FIVE-MILE ETJ), THE ENGINEER SHALL CERTIFY IN WRITING THAT THE PROPOSED DRAINAGE, PARKING, ISLANDS, AND DRIVEWAYS WERE CONSTRUCTED IN CONFORMANCE WITH THE APPROVED

WATERSHED STATUS - THIS PROJECT IS LOCATED IN THE LAKE CREEK WATERSHED.

NO PORTION OF THE SITE LIES WITHIN THE 100 YEAR FLOOD PLAIN, ACCORDING TO THE FLOOD INSURANCE RATE MAP, PANEL NO.48491C0630E, DATED SEPTEMBER 26, 2008 FOR WILLIAMSON COUNTY, TEXAS.

THIS SITE IS OVER THE EDWARD'S AQUIFER RECHARGE ZONE ACCORDING TO TCEQ MAPS. THERE ARE NO CRITICAL ENVIRONMENTAL FEATURES WITHIN 150 FEET OF THE SITE. THERE ARE NO SLOPES OVER 15% ON THIS SITE.

THE PROPOSED SITE LIES INSIDE THE 2-MILE ETJ OF THE CITY OF ROUND ROCK AND IS NOT SUBJECT TO TRANSPORTATION OR LANDSCAPE REQUIREMENTS REGARDING PARKING, DRIVEWAYS, AND INTERNAL CIRCULATION.

"RELEASE OF THIS APPLICATION DOES NOT CONSTITUTE A VERIFICATION OF ALL DATA, INFORMATION AND CALCULATIONS SUPPLIED BY THE APPLICANT. THE ENGINEER OF RECORD IS SOLELY RESPONSIBLE FOR THE COMPLETENESS, ACCURACY AND ADEQUACY OF HIS/HER SUBMITTAL, WHETHER OR APPLICATION IS REVIEWED FOR CODE COMPLIANCE BY COUNTY ENGINEERS."

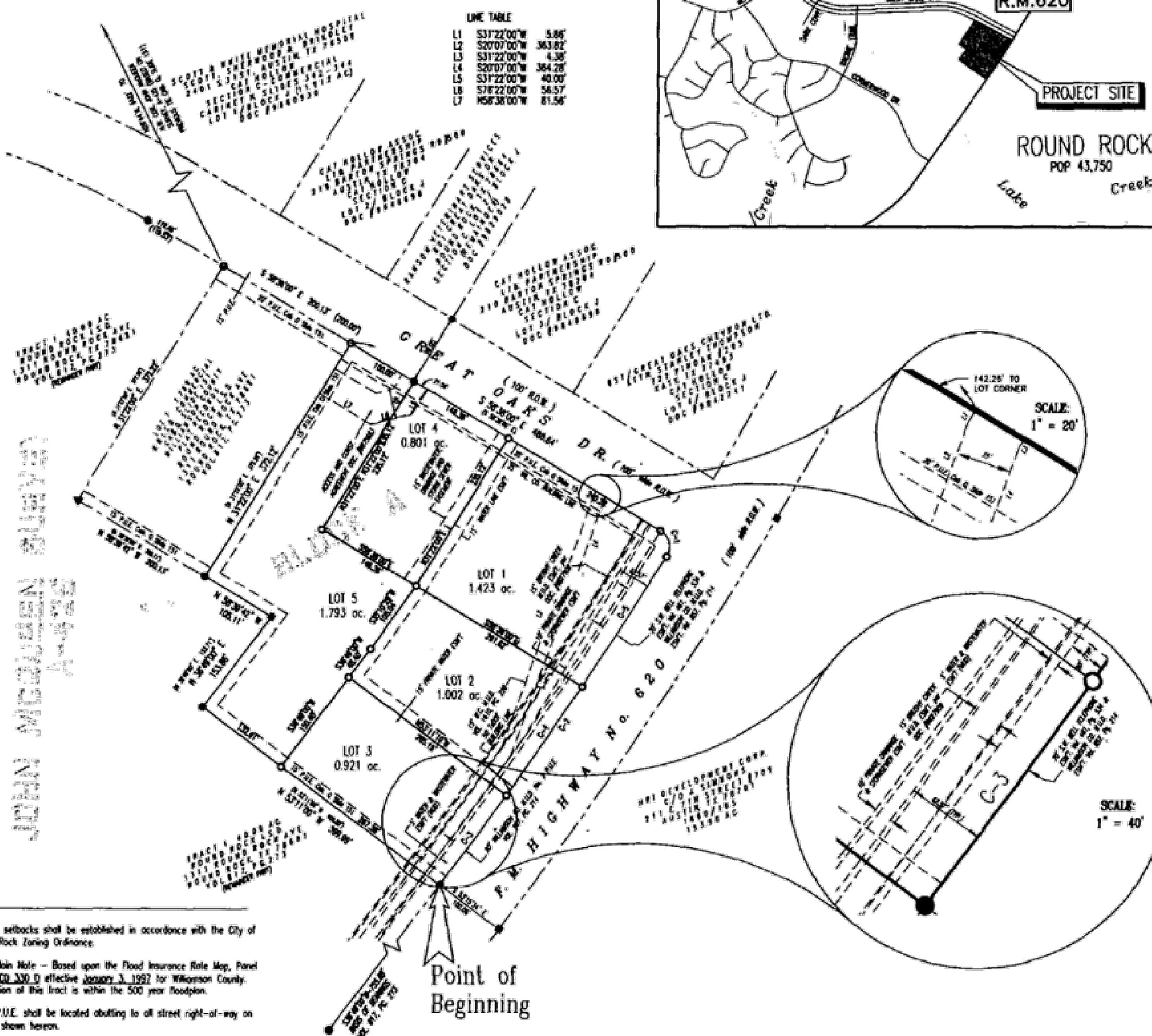
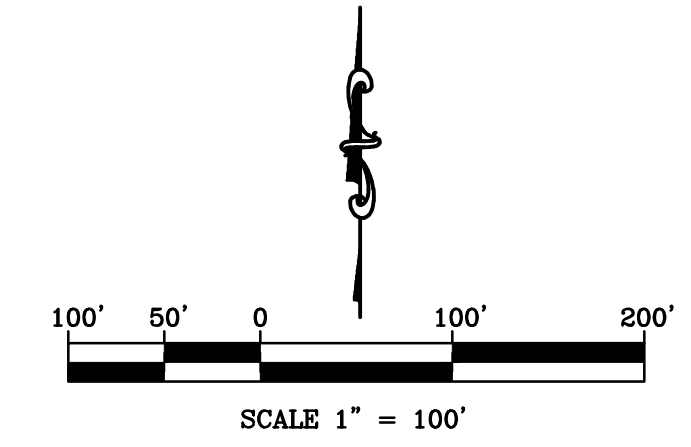
BOUNDARY CURVE REPORT

CURVE	RADIUS	DELTA	TANGENT	LENGTH	CHORD	BEARING
C-1	25.00'	89°56'09"	24.97'	39.24'	35.34'	S17°30'55"E
C-2	5679.56'	0°28'16"	269.72'	539.03'	538.85'	N4°01'17"E
C-3	5679.56'	0°13'03"	73.22'	150.43'	150.43'	N35°50'54"E
C-4	5679.56'	0°14'58"	88.21'	178.41'	178.40'	N34°19'22"E
C-5	5679.56'	0°20'14"	105.11'	216.19'	216.18'	N32°21'46"E

LINE TABLE

L1	S31°22'00"W	5.96'
L2	S20°07'00"W	363.82'
L3	S31°22'00"W	4.38'
L4	S20°07'00"W	384.28'
L5	S31°22'00"W	40.00'
L6	S18°22'00"W	56.57'
L7	N58°38'00"W	81.56'

SITE LOCATION MAP



NOTES:

- 1) Building setbacks shall be established in accordance with the City of Round Rock Zoning Ordinance.
- 2) Flood plain Note - Based upon the Flood Insurance Rate Map, Panel 52491-00-330-D effective January 3, 1997 for Williamson County. No portion of this tract is within the 500 year floodplain.
- 3) A 15' P.U.E. shall be located abutting to all street right-of-way on all lots shown herein.
- 4) No fences or other obstructions shall be placed or isolated in any Drainage Easements shown herein.
- 5) Water and Wastewater service for this subdivision will be provided by Brushy Creek Municipal Utility District. The construction and operation of all water and wastewater facilities within the subdivision must comply with all rules and policies of Brushy Creek Municipal Utility District. No building on any lot in this subdivision shall be occupied until water and wastewater connections have been made to the Brushy Creek Municipal Utility District water and wastewater system and all plumbing approved in accordance with the rules and regulations of the district.
- 6) Sidewalks shall be constructed in accordance with the City of Round Rock Subdivision Ordinance.
- 7) Each lot shall provide on-site detention for the 100 yr. storm.

ACCESS NOTES:

- 1) Driveway access to R.M. 620 is not permitted within 200' of Great Oaks Drive.
- 2) Driveway access to Great Oaks Drive is not permitted within 200' of R.M. 620.
- 3) Minimum centerline spacing of driveways onto Great Oaks Drive and R.M. 620 shall be 200'.
- 4) Median breaks in Great Oaks Drive within 400' from R.M. 620 are prohibited.
- 5) Access to R.M. 620 shall be restricted to two driveways (max).
- 6) A permit from TxDOT and Williamson County will be required for driveway installations.
- 7) Private access easements for each lot shall be dedicated by separate instrument prior to issuance of a Certificate of Occupancy (by Brushy Creek M.U.D.) for each lot.

OWNER: Sullon & Kahn Partnership, Ltd.
16505 Denise Dr.
Austin, Texas 78717
(512) 799-6255
(512) 218-4542 (FAX)

ACREAGE: 5.940

SURVEY: John McKee Survey, A-425

NUMBER OF BLOCKS: 1

NUMBER OF LOTS: 5

LINEAR FEET OF STREETS: N/A

DATE: March 22, 2000

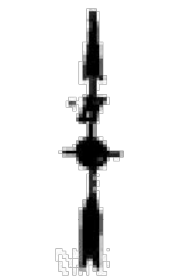
SURVEYOR: Lenz & Associates, Inc.
1714 Forthview Rd., No. 101
Austin, Texas 78704
Timothy A. Lenz, R.P.L.S.

ENGINEER: Fisher Hagood, Inc.
One Chisholm Trail, Suite 520
Round Rock, Texas 78681
Terry R. Hagood, P.E.
(512) 244-1546
(512) 388-3698 (FAX)

BENCHMARK: Cotton spindle found in power pole, 5' west of west R.O.W. line R.M. 620, approx. 677 feet south of south cor. Lot 5, elev. = 823.96

LEGEND

- STEEL PIN FOUND (SPF)
1/2" DIA. UNLESS NOTED
- STEEL PIN SET w/CAP (SPS)
- PIPE FOUND
- ▲ NAIL FOUND
- ✱ SPINDLE SET
- CONCRETE MONUMENT
- RIGHT OF WAY
- - - PUBLIC UTILITY EASEMENT



SCALE: 1" = 100'

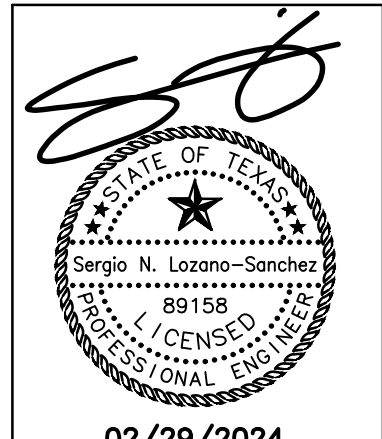
FINAL PLAT OF GREAT OAKS/620 COMMERCIAL (A REPLAT)



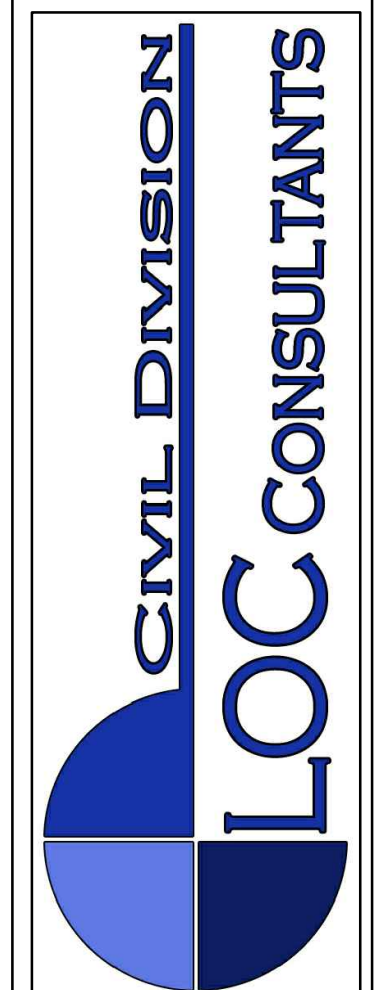
Sheet 1 of 2

REVISIONS / CORRECTIONS

NO.	DESCRIPTION

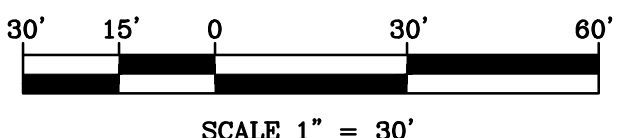
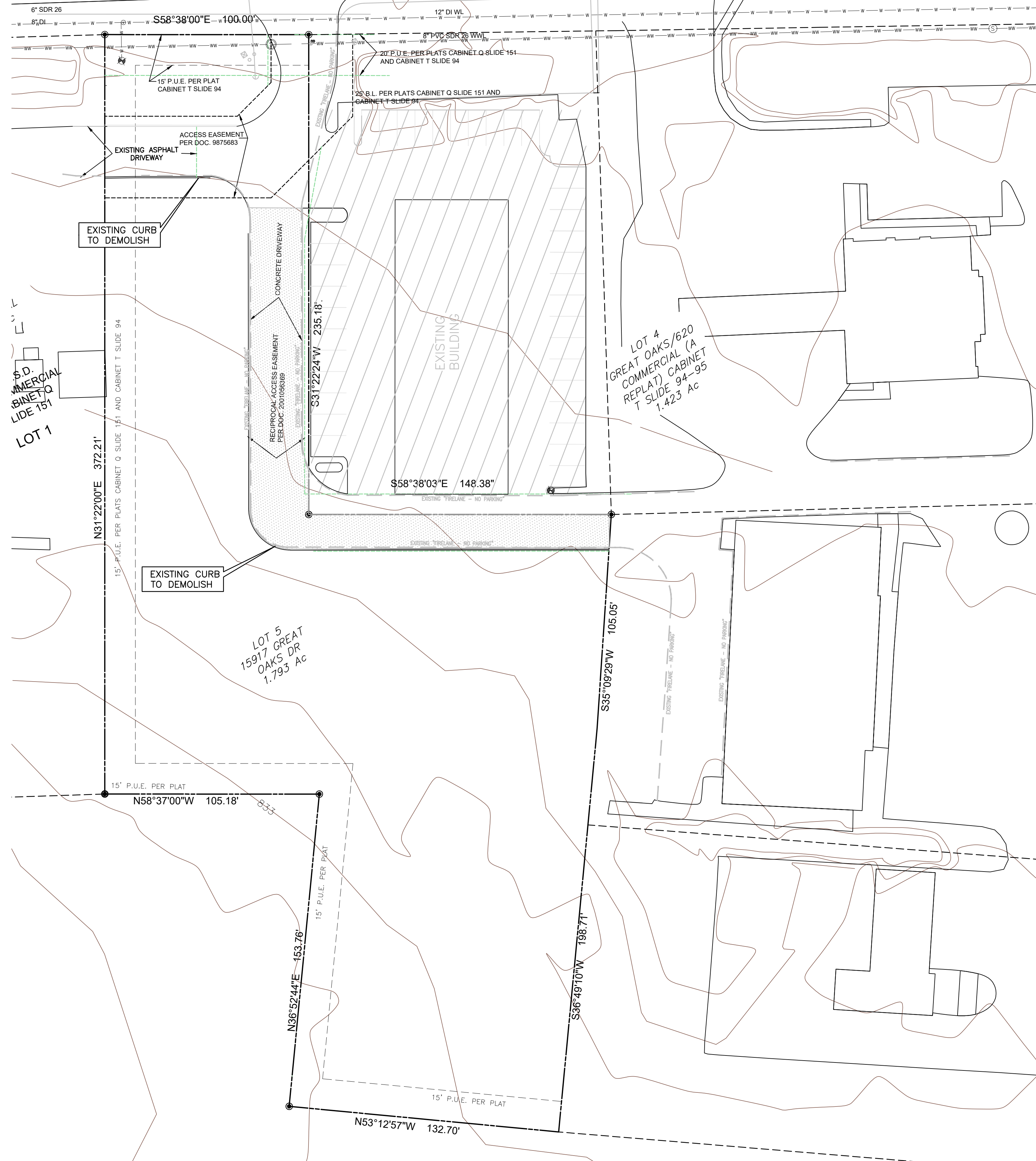


GREAT OAKS DR.
15917 GREAT OAKS DRIVE
SUBDIVISION PLAT



SHEET: 02 OF 17

GREAT OAKS DRIVE
100' R.O.W.

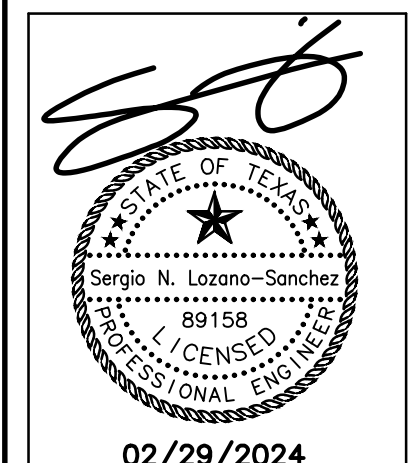


LEGEND

	PROPERTY LINE
	EXISTING CONTOUR (1-FT INTERVAL)
	EXISTING CONTOUR (5-FT INTERVAL)
	EXISTING TREE
	EXISTING TREE TO BE REMOVED
	EXISTING FENCE
	EXISTING WATER LINE
	EXISTING WASTEWATER LINE
	EXISTING FIRE HYDRANT
	DEMOLITION

REVISIONS / CORRECTIONS

NO.	DESCRIPTION



02/29/2024

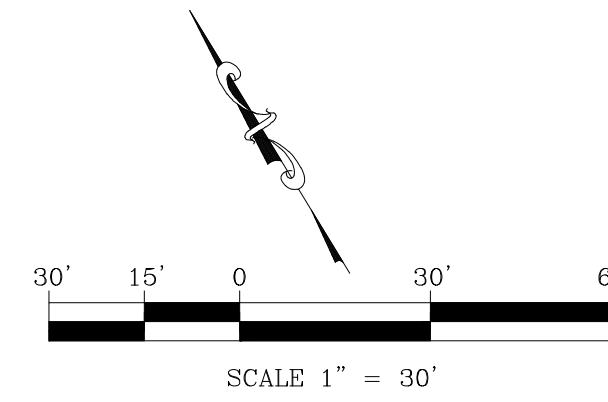
GREAT OAKS DR.
15917 GREAT OAKS DRIVE
EXISTING CONDITIONS



SHEET:
03
OF 17

GREAT OAKS DRIVE

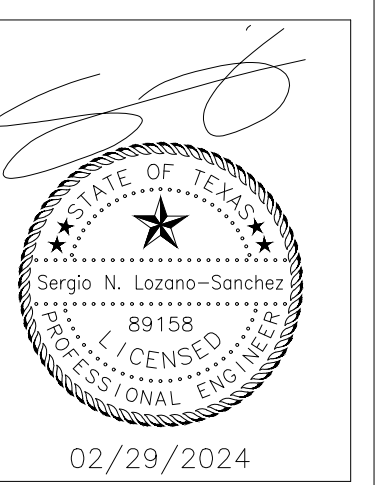
100' R.O.W.



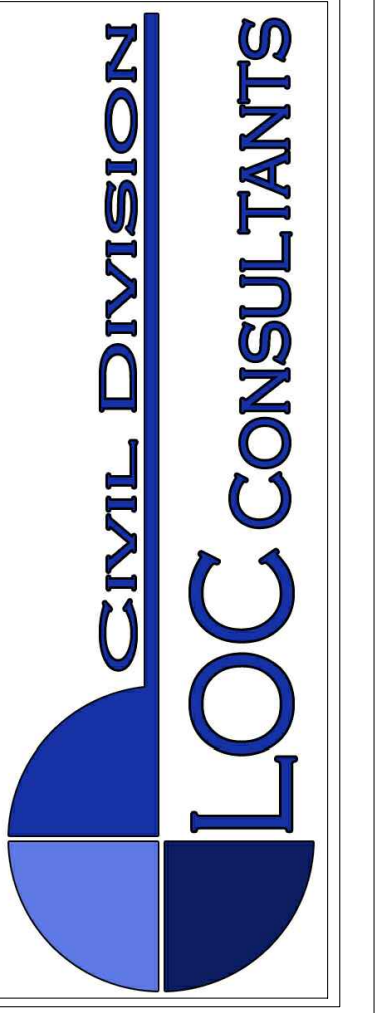
LEGEND

- PROPERTY LINE
- ADJACENT PROPERTY LINE
- PROPOSED BUILDING FOOTPRINT
- 832 EXISTING CONTOUR
- PROPOSED CONTOUR
- WW—WW—WW— EXISTING WASTEWATER LINE
- W—W—W— EXISTING WATER LINE
- PROPOSED WASTEWATER LINE
- PROPOSED WATER LINE
- PROPOSED STORMWATER LINE
- EXISTING WASTEWATER MANHOLE
- PROPOSED WASTEWATER MANHOLE
- PROPOSED STORM DRAINAGE MANHOLE
- PROPOSED CLEANOUT
- PROPOSED STORM BOX CONNECTION
- PROPOSED GRATE INLET
- PROPOSED TRENCH/SLOTTED DRAIN
- EXISTING FIRE HYDRANT
- PROPOSED FIRE HYDRANT

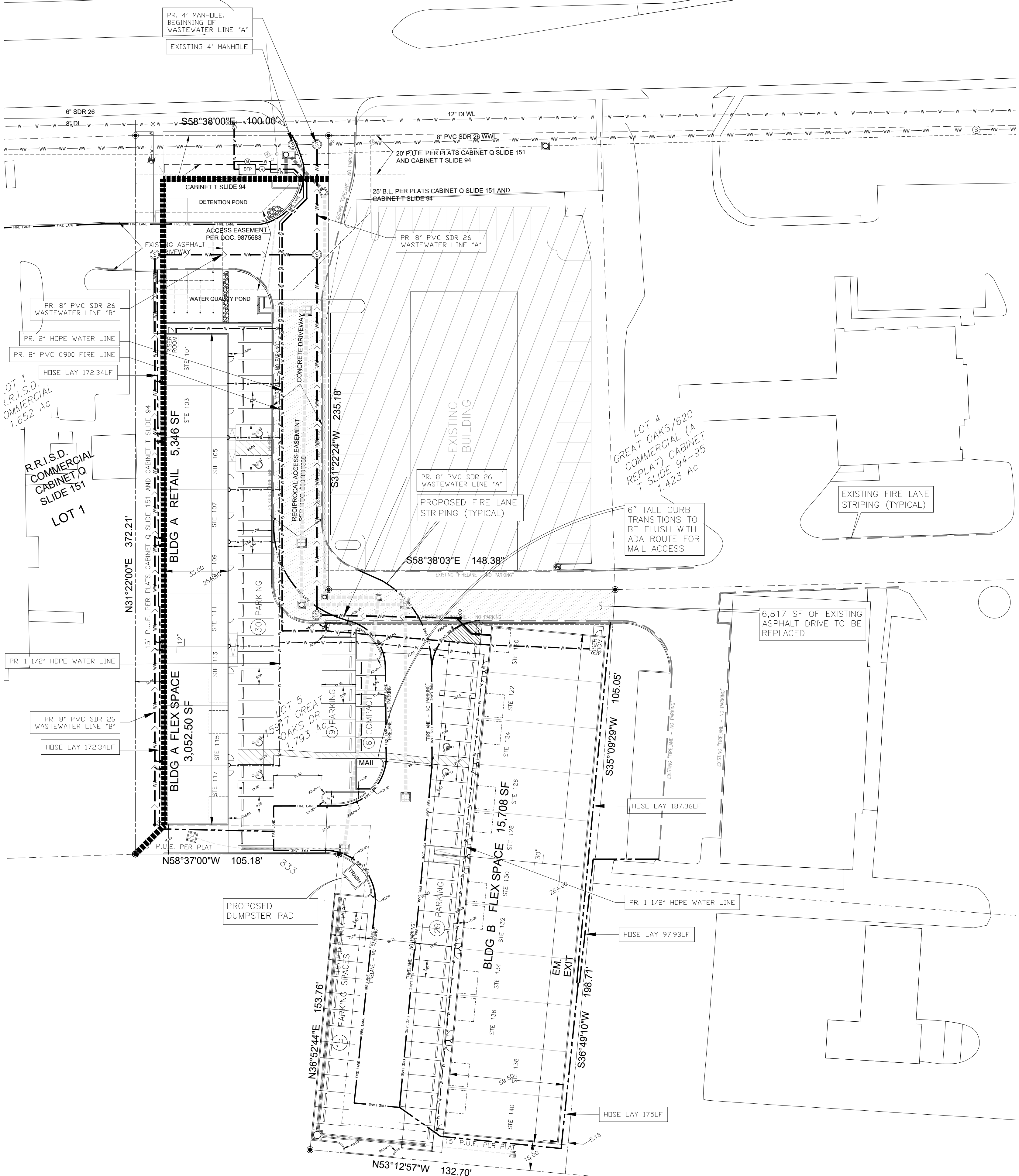
REVISIONS / CORRECTIONS



GREAT OAKS DR.
15917 GREAT OAKS DRIVE
SITE PLAN



SHEET:
04
OF 17



PARKING TABLE

PROPOSED REGULAR	77
PROPOSED COMPACT	6
PROPOSED ACCESSIBLE	6
TOTAL PROPOSED PARKING	89

PROJECT DESCRIPTION

THE PROJECT CONSIST OF THE CONSTRUCTION OF 2 OFFICE/WAREHOUSE BUILDINGS AND ASSOCIATED PARKING LOT.

SITE DATA TABLE

EXISTING USE:	VACANT
PROPOSED USE:	RETAIL, FLEX SPACE
GROSS SITE AREA:	78,103 Sq.Ft.
NO ZONING:	OUTSIDE CITY LIMITS
MINIMUM SITE AREA REQUIRED:	N/A
TOTAL GROSS FLOOR AREA:	24,106.50 SF
BUILDING COVERAGE:	24,106.50 SF
IMPERVIOUS COVER:	81.91%
FLOOR TO AREA RATIO:	0.31
FINISH FLOOR ELEV.:	831.58, 832.00, 833.08, 834.08
NO. OF STORIES:	ONE STORY
BUILDING HEIGHT:	TBD
EXISTING SQUARE FOOTAGE:	0 Sq.Ft
FOUNDATION TYPE:	SLAB ON GRADE
BUILDING CONSTRUCTION:	METAL BUILDING
MAX BLDG. ELEVATION:	N/A

IMPERVIOUS COVER CALCULATION

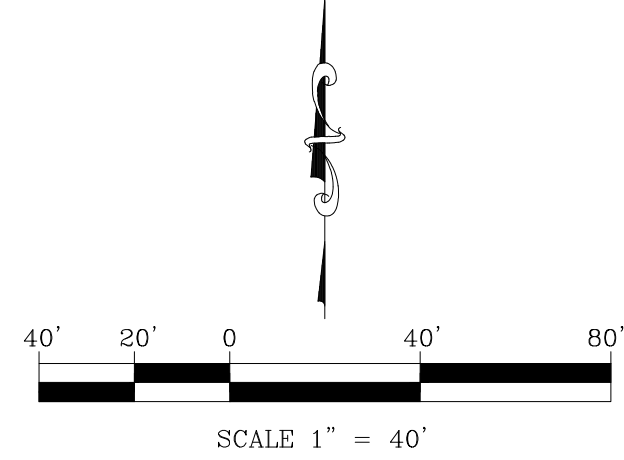
NET SITE AREA :	1.793 AC=	78,103	SF					
ZONED:								
FAR:								
IMPERVIOUS COVER	EXISTING	%	DEMOLITION	%	PROPOSED	%	TOTAL	%
BUILDING/ROOF	-	SF 0.00	-	SF 0.00	24,106.50 SF	30.87	24,106.50 SF	30.87
CONCRETE	-	SF 0.00	-	SF 0.00	3,609.42 SF	4.62	3,609.42 SF	4.62
ASPHALT	-	SF 0.00	-	SF 0.00	25,560.21 SF	32.73	25,560.21 SF	32.73
TOTAL	-	SF 0.00	-	SF 0.00	53,276.13 SF	68.21	53,276.13 SF	68.21
PERVIOUS COVER	78,103.00 SF	100.00					24,826.87 SF	31.79
GOOD GRASS								

FIRE PROTECTION NOTE

BUILDING #3 SHALL BE BROKEN UP BY FIRE WALLS AND KEEP THE UNDIVIDED AREAS BELOW 12,000 SQ.FT. TO AVOID THE NECESSITY OF INSTALLING A FIRE SPRINKLER SYSTEM.

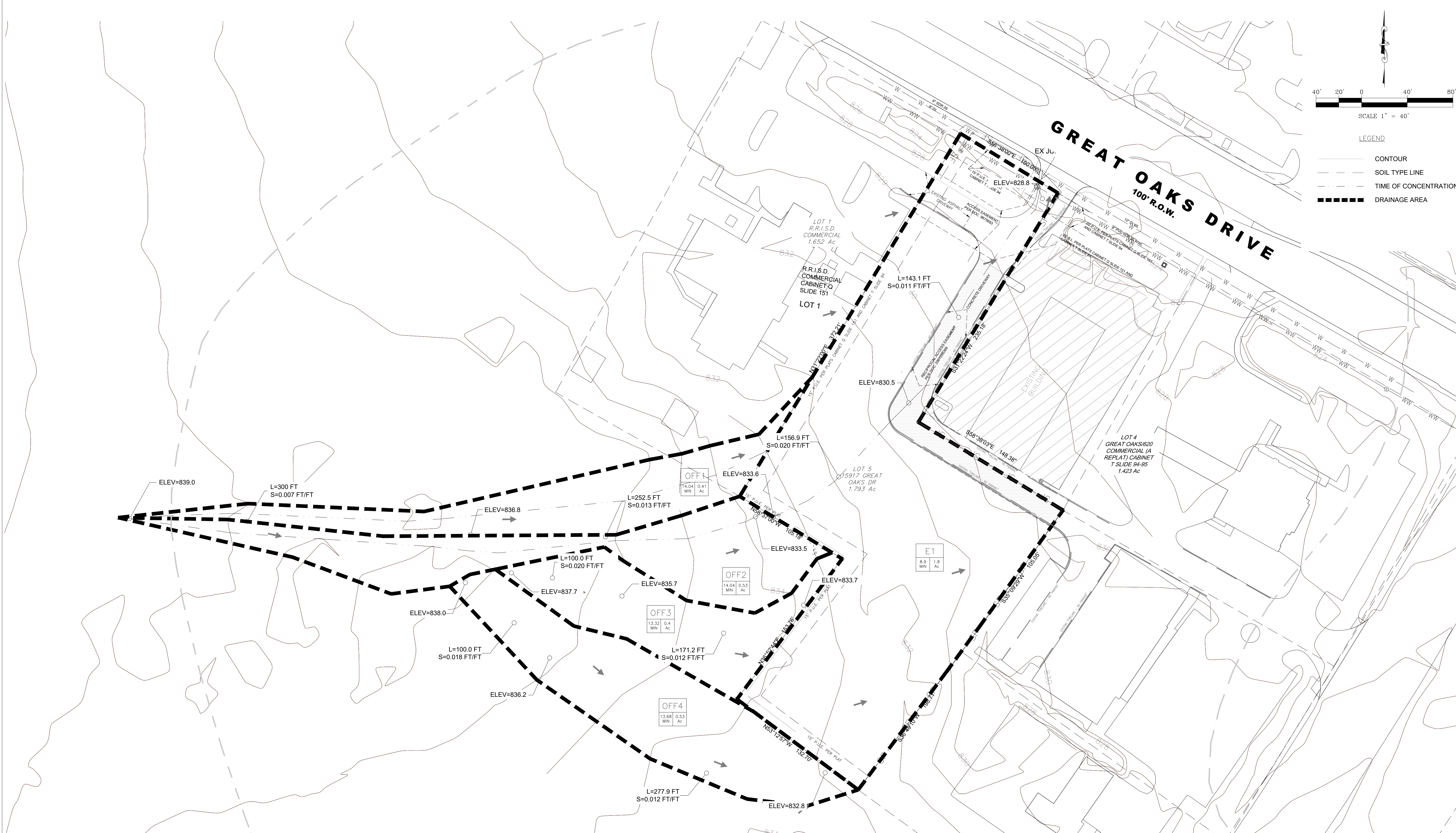
ENGINEER'S CERTIFICATION

A CIVIL ENGINEER REGISTERED IN TEXAS MUST CERTIFY A PLAN OR PLAT AS COMPLETE, ACCURATE, AND IN COMPLIANCE WITH THE REQUIREMENTS OF THIS SUBCHAPTER. THE DIRECTOR OF WATERSHED PROTECTION DEPARTMENT MAY WAIVE THIS REQUIREMENT AFTER MAKING A DETERMINATION THAT THE PLAN OR PLAT INCLUDES ONLY MINOR ALTERATIONS OR IMPROVEMENTS THAT DO NOT REQUIRE THE SERVICES OF AN ENGINEER.



LEGEND

---	CONTOUR
---	SOIL TYPE LINE
---	TIME OF CONCENTRATION
---	DRAINAGE AREA

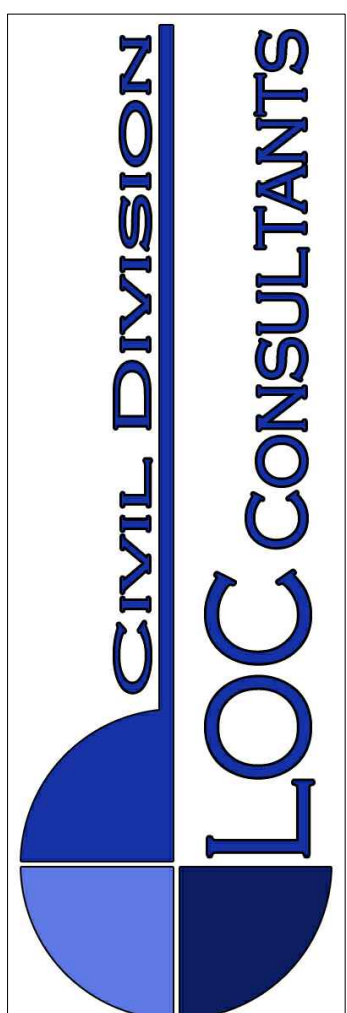


REVISIONS / CORRECTIONS

NO.	DESCRIPTION



GREAT OAKS DR.
15917 GREAT OAKS DRIVE
EXISTING DRAINAGE AREA MAP



Project Name: **GREAT OAKS**
HEC-HMS INPUTS

Drainage Area	Area (s.f.)	Area (sq. mi.)	Tc (hr)	Tag (hr)	Tag (min)	Imp. Cov. (s.f.)	Imp. Cov. (%)	Soil Type	Pervious Cover Type	Hydro. Cond.	Hydro. Group	Imp. Cov. CN	Pervious CN	Weighted CN	Q2 (CFS)	Q10 (CFS)	Q25 (CFS)	Q100 (CFS)				
EXISTING CONDITIONS																						
E1	78,103		0.00280	0.10	0.06	3.64	-	0.00%	UID, UsC	Grassland	Good	D	98	61	61.00	4.27	8.01	10.57	15.08			
OFF 1	17,941		0.00064	0.39	0.23	14.04	-	0.00%	UID, UsC	Grassland	Good	D	98	61	61.00	0.24	0.77	1.19	2.02			
OFF 2	23,148		0.00083	0.39	0.23	14.04	-	0.00%	UID, UsC	Grassland	Good	D	98	61	61.00	0.31	1.00	1.55	2.62			
OFF 3	17,424		0.00063	0.37	0.22	13.32	-	0.00%	UID, UsC	Grassland	Good	D	98	61	61.00	0.24	0.78	1.21	2.05			
OFF 4	23,253		0.00083	0.38	0.23	13.68	-	0.00%	UID, UsC	Grassland	Good	D	98	61	61.00	0.31	1.01	1.57	2.66			
E-JUNCTION															5.11	11.07	15.44	23.49				
PROPOSED CONDITIONS																						
P1	70,786		0.00254	0.19	0.11	6.84	(1.41 ac)	61,420	86.77%	UID, UsC	Grassland	Good	D	98	61	93.10	6.47	9.86	12.18	16.36		
P2	7,267		0.00026	0.21	0.13	7.56	-	0.00%	UID, UsC	Grassland	Good	D	98	61	61.00	0.14	0.43	0.66	1.11			
OFF 1	17,941		0.00064	0.39	0.23	14.04	-	0.00%	UID, UsC	Grassland	Good	D	98	61	61.00	0.24	0.77	1.19	2.02			
OFF 2	23,148		0.00083	0.39	0.23	14.04	-	0.00%	UID, UsC	Grassland	Good	D	98	61	61.00	0.31	1.00	1.55	2.62			
OFF 3	17,424		0.00063	0.37	0.22	13.32	-	0.00%	UID, UsC	Grassland	Good	D	98	61	61.00	0.24	0.78	1.21	2.05			
OFF 4	23,253		0.00083	0.38	0.23	13.68	-	0.00%	UID, UsC	Grassland	Good	D	98	61	61.00	0.31	1.01	1.57	2.66			
DET															4.88	8.76	11.01	18.35				
P-JUNCTION															5.22	9.84	12.66	21.21				

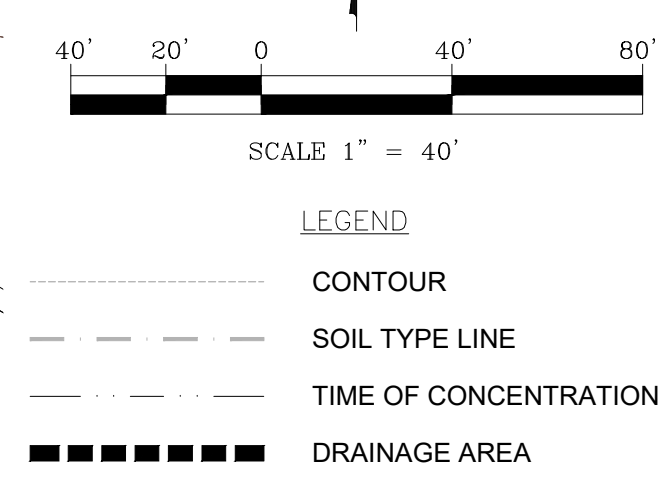
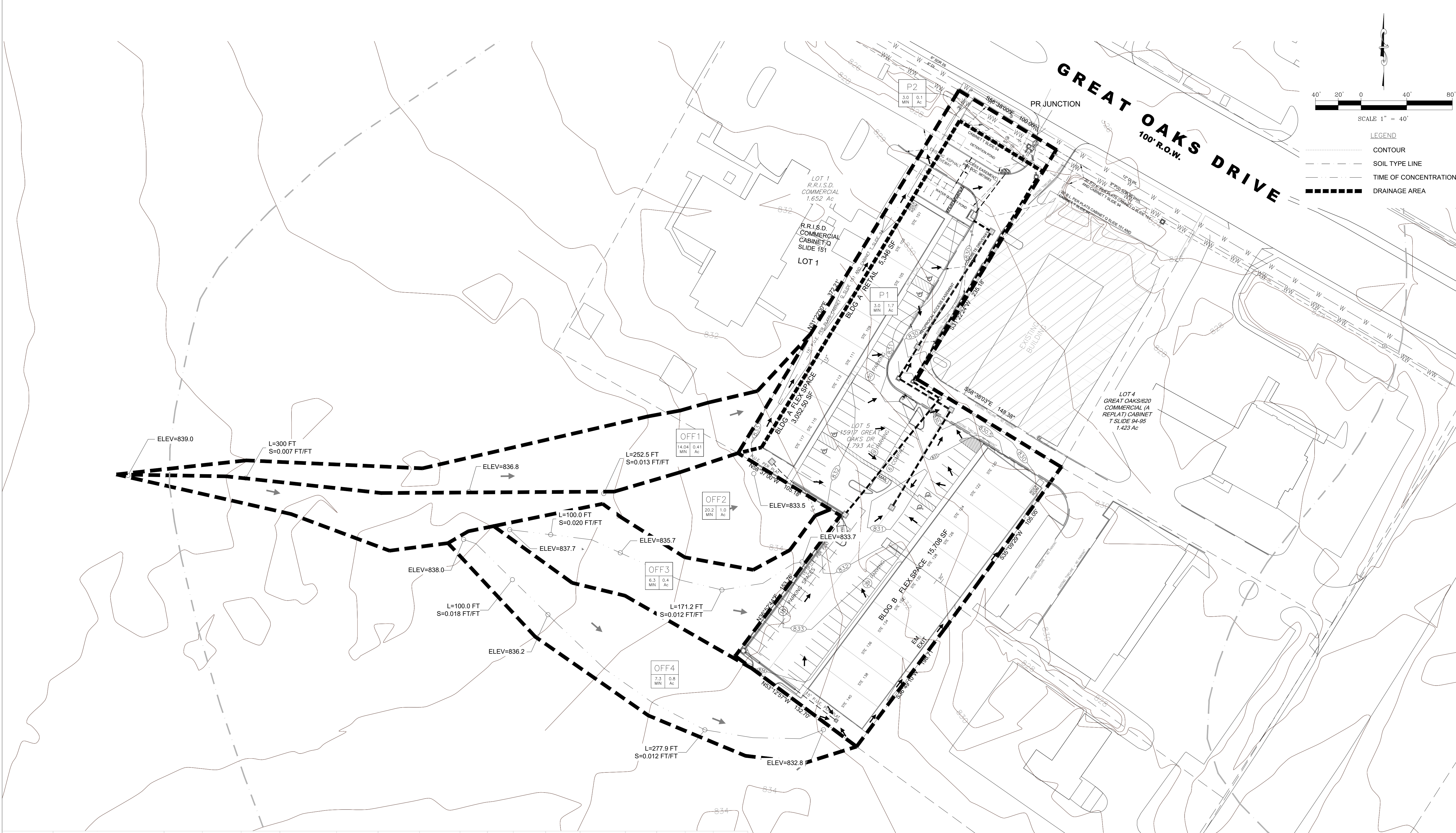
TIME OF CONCENTRATION CALCULATIONS (SCS METHOD)

Project: GREAT OAKS
Sheetflow: $T_t = (0.007 * (L^n) * 0.8) / ((P2 * 0.5) * (s * 0.4))$
Shallow Concentrated: $T_t = L / V_{vel}$
Concentrated: $T_c = T_{t1} + T_{t2} + T_{t3} + T_{t4} + T_{t5}$
 $T_c = (1.49/n) * A * (R^{1/2/3}) * S^{0.5}$

Sheetflow: P2 = 3.44 inches, n = Manning's roughness coefficient, L = flow length (ft), V = average Velocity (ft/sec)
Shallow Concentrated: P2 = 2-year, 24 Hr rainfall, n = Manning's roughness coefficient, slope of hydraulic grade line (land slope, ft/ft)
Concentrated: Vel Paved surface = 20.3282 s*0.5 (1), Vel unpaved surface = 16.1345 s*0.5 (2)

Area	Sheetflow			Shallow Concentrated				Concentrated					Total Tc (hr)																
	L (ft)	n	s (%)	Tt1 (hr)	L (ft)	n	s (%)	Tt2 (hr)	L (ft)	Surface (1 OR 2)	s (%)	Tt3 (hr)		L (ft)	Surface (1 OR 2)	s (%)	Tt4 (hr)	Bottom (ft)	Depth (ft)	Width (ft)	s (%)	n	A (sq.ft)	R (ft)	P (ft)	Q (cfs)	Vel (ft/sec)	L (ft)	Tt5 (hr)
E1	100	0.20	14.50%	0.09				66.4	2	1.00%	0.0114																		0.10
O1	100	0.30	1.36%	0.32				441.3	2	1.36%	0.0652																		0.39
O2	100	0.30	1.36%	0.32				463.5	2	1.36%	0.0684																		0.39
O3	100	0.30	1.00%	0.36				171.2	2	6.58%	0.0115																		0.37
O4	100	0.30	1.00%	0.36				277.9	2	4.58%	0.0224																		0.38
P1	100	0.17	2.00%	0.18				82.6	1	1.00%	0.0113																		0.19
P2	100	0.17	2.00%	0.18				171	2	1.00%	0.0294																		0.21

SHEET: **05**
OF 17

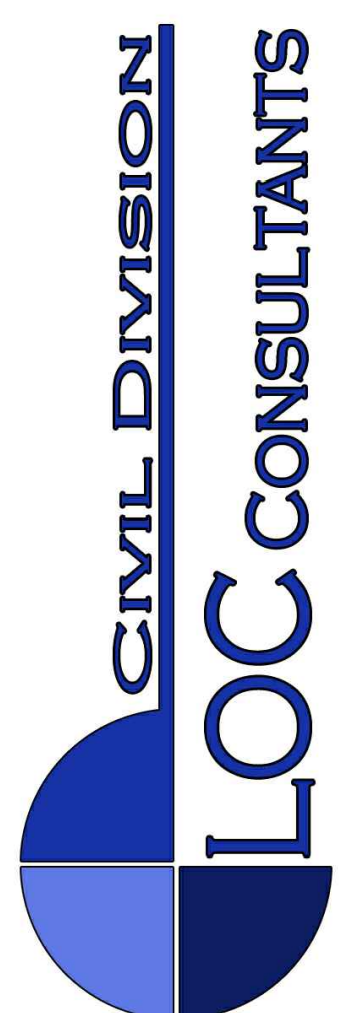


REVISIONS / CORRECTIONS

NO.	DESCRIPTION



GREAT OAKS DR.
15917 GREAT OAKS DRIVE
PROPOSED DRAINAGE AREA MAP



Project Name: **GREAT OAKS**
HEC-HMS INPUTS

Drainage Area	Area (s.f.)	Area (sq. mi.)	Tc (hr)	Tlag (hr)	Tlag (min)	Imp. Cov. (s.f.)	Imp. Cov. (%)	Soil Type	Pervious Cover Type	Hydro. Cond.	Hydro. Group	Imp. Cov. CN	Pervious CN	Weighted CN	Q2 (CFS)	Q10 (CFS)	Q25 (CFS)	Q100 (CFS)	
EXISTING CONDITIONS																			
E1	78,103	0.00280	0.10	0.06	3.64	-	0.00%	UTD, Usc	Grassland	Good	D	98	61	61.00	4.27	8.01	10.57	15.08	
OFF 1	17,941	0.00064	0.39	0.23	14.04	-	0.00%	UTD, Usc	Grassland	Good	D	98	61	61.00	0.24	0.77	1.19	2.02	
OFF 2	23,148	0.00083	0.39	0.23	14.04	-	0.00%	UTD, Usc	Grassland	Good	D	98	61	61.00	0.31	1.00	1.55	2.62	
OFF 3	17,424	0.00063	0.37	0.22	13.32	-	0.00%	UTD, Usc	Grassland	Good	D	98	61	61.00	0.24	0.78	1.21	2.05	
OFF 4	23,253	0.00083	0.38	0.23	13.68	-	0.00%	UTD, Usc	Grassland	Good	D	98	61	61.00	0.31	1.01	1.57	2.66	
E-JUNCTION															5.11	11.07	15.44	23.49	
PROPOSED CONDITIONS																			
P1	70,786	0.00254	0.19	0.11	6.84	(1.41 ac)	61,420	86.77%	UTD, Usc	Grassland	Good	D	98	61	93.10	6.47	9.86	12.18	16.36
P2	7,267	0.00026	0.21	0.13	7.56	-	0.00%	UTD, Usc	Grassland	Good	D	98	61	61.00	0.14	0.43	0.66	1.11	
OFF 1	17,941	0.00064	0.39	0.23	14.04	-	0.00%	UTD, Usc	Grassland	Good	D	98	61	61.00	0.24	0.77	1.19	2.02	
OFF 2	23,148	0.00083	0.39	0.23	14.04	-	0.00%	UTD, Usc	Grassland	Good	D	98	61	61.00	0.31	1.00	1.55	2.62	
OFF 3	17,424	0.00063	0.37	0.22	13.32	-	0.00%	UTD, Usc	Grassland	Good	D	98	61	61.00	0.24	0.78	1.21	2.05	
OFF 4	23,253	0.00083	0.38	0.23	13.68	-	0.00%	UTD, Usc	Grassland	Good	D	98	61	61.00	0.31	1.01	1.57	2.66	
DET															4.88	8.76	11.01	18.35	
P-JUNCTION															5.22	9.84	12.66	21.21	

TIME OF CONCENTRATION CALCULATIONS (SCS METHOD)

Project: GREAT OAKS

Sheetflow $T_t = (0.007 (L^n)^{0.8}) / ((P^2)^{0.5}) * (s^{*0.4})$ Shallow Concentrated $T_t = L / V_{vel}$

$P_2 = 3.44$ inches 2-year, 24 Hr rainfall $T_t = L / V_{vel}$

$n =$ Manning's roughness coefficient $T_t = L / V_{vel}$

$L =$ flow length (ft) $s =$ slope of hydraulic grade line (land slope, ft/ft) $T_t = L / V_{vel}$

$V =$ average Velocity (ft/sec) $T_t = L / V_{vel}$

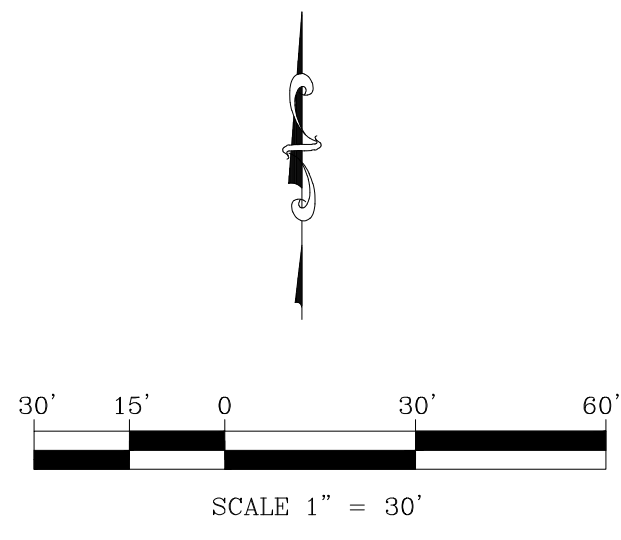
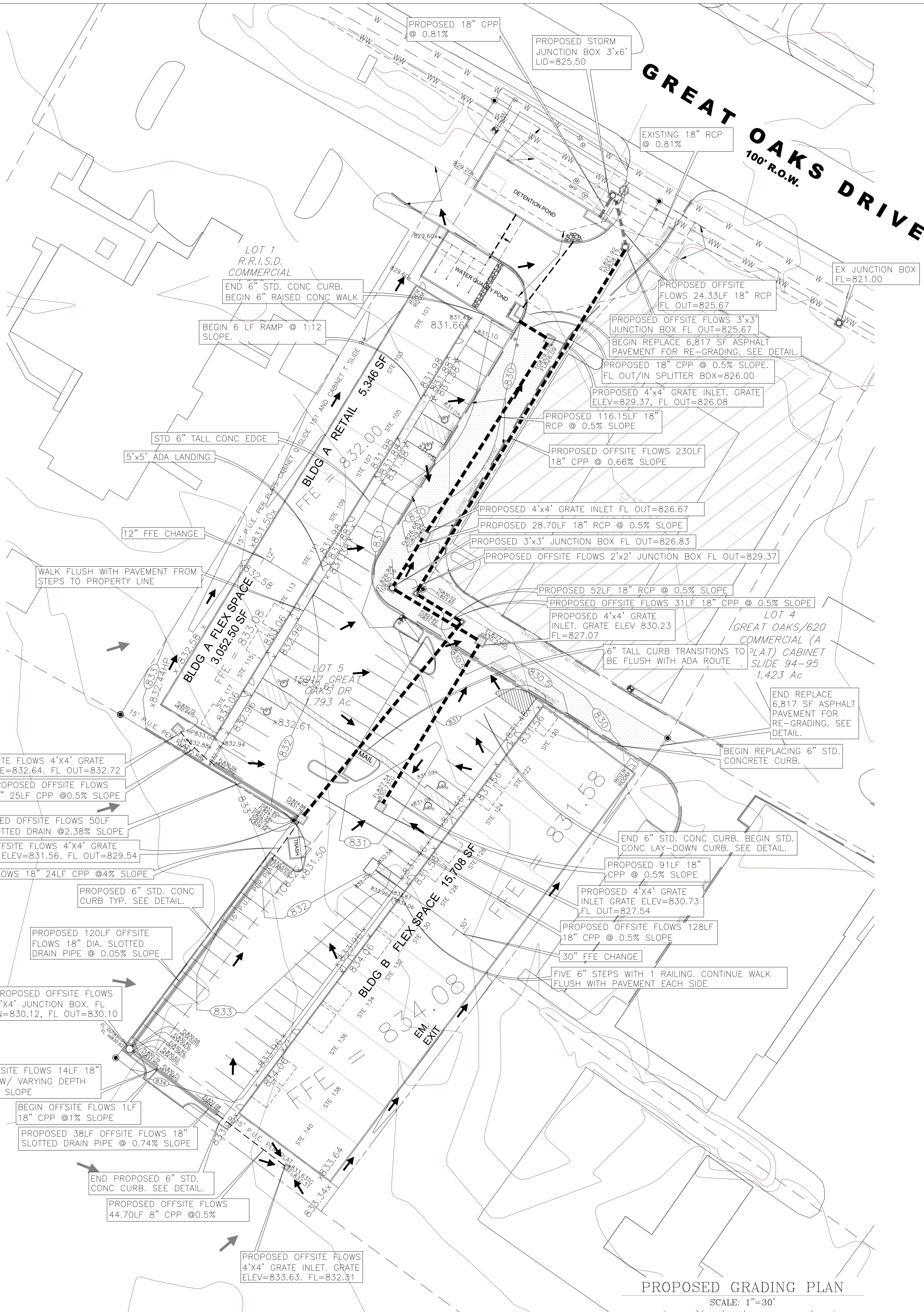
$T_c = T_1 + T_2 + T_3 + T_4 + T_5$

$Q = (1.49/n) * A * (R^{2/3}) * S^{0.5}$

Vel Paved surface = 20.3282 s*0.5 (1)

Vel unpaved surface = 16.1345 s*0.5 (2)

Area	Sheetflow					Shallow Concentrated					Concentrated					Total Tc (hr)												
	L (ft)	n	s (%)	Tt1 (hr)	L (ft)	n	s (%)	Tt2 (hr)	L (ft)	Surface (1 OR 2)	s (%)	Tt3 (hr)	L (ft)	Surface (1 OR 2)	s (%)		Tt4 (hr)	Bottom Depth (ft)	Width (ft)	s (%)	n	A (sq.ft)	R (ft)	P (ft)	Q (cfs)	Vel (ft/sec)	L (ft)	Tt5 (hr)
E1	100	0.20	14.50%	0.09						66.4	2	1.00%	0.0114															0.10
O1	100	0.30	1.36%	0.32						441.3	2	1.36%	0.0652															0.39
O2	100	0.30	1.36%	0.32						463.5	2	1.36%	0.0684															0.39
O3	100	0.30	1.00%	0.36						171.2	2	6.58%	0.0115															0.37
O4	100	0.30	1.00%	0.36						277.9	2	4.58%	0.0224															0.38
P1	100	0.17	2.00%	0.18						82.6	1	1.00%	0.0113															0.19
P2	100	0.17	2.00%	0.18						171	2	1.00%	0.0294															0.21



LEGEND

---	PROPERTY LINE
---	ADJACENT PROPERTY LINE
▨	PROPOSED BUILDING FOOTPRINT
---	EXISTING CONTOUR
---	PROPOSED CONTOUR
→	EXISTING RUNOFF DIRECTION
→	PROPOSED RUNOFF DIRECTION
---	PROPOSED STORMWATER LINE
▨	PROPOSED SLOTTED DRAIN PIPE
⊙	EXISTING WASTEWATER MANHOLE
⊙	PROPOSED STORM GRATE INLET
⊙	PROPOSED STORM BOX CONNECTION

GRADING NOTES

CONTRACTOR TO VERIFY GRADE ELEVATIONS PRIOR TO CONSTRUCTION AND NOTIFY ENGINEER IF THERE IS ANY CONFLICT.

ALL FLOWS FROM ROOFS MUST BE DIRECTED TO THE DOWNSPOUTS ON THE FRONT SIDE OF THE BUILDING AS SHOWN BY THE FLOW ARROWS.

ACCESSIBLE ROUTE NOTES

ACCESSIBLE ROUTE MUST HAVE A CROSS-SLOPE NO GREATER THAN 2% OR 1:50 (ANSI 403.3).

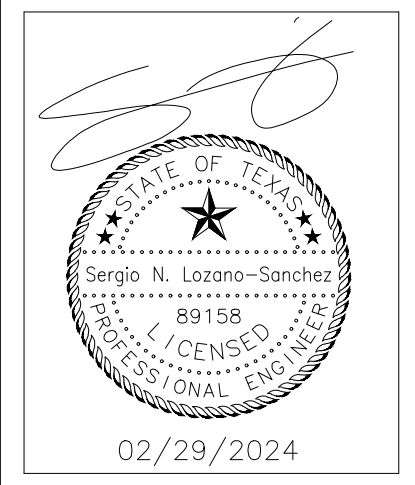
SLOPES ON ACCESSIBLE ROUTES MAY NOT EXCEED 1:20 UNLESS DESIGNED AS A RAMP (ANSI 403.3).

ALL ADA SURFACES MUST HAVE A 2% CROSS SLOPE AWAY FROM THE BUILDING TO AVOID FLOODING THE INTERIOR.

ALL ADA SURFACES HIGHER THAN ADJACENT FINISH FLOOR MUST BE CURBED ALONG BUILDING EDGE TO PREVENT FLOODING THE INTERIOR DURING SEVERE STORMS.

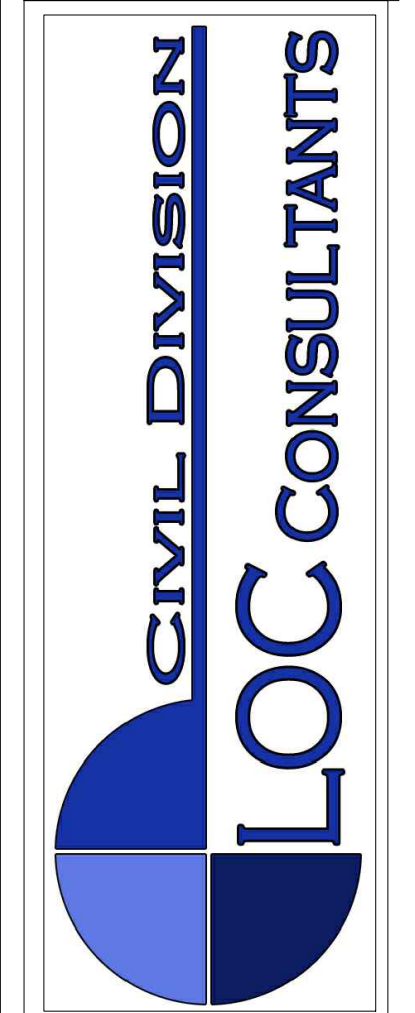
REVISIONS / CORRECTIONS

NO.	DESCRIPTION



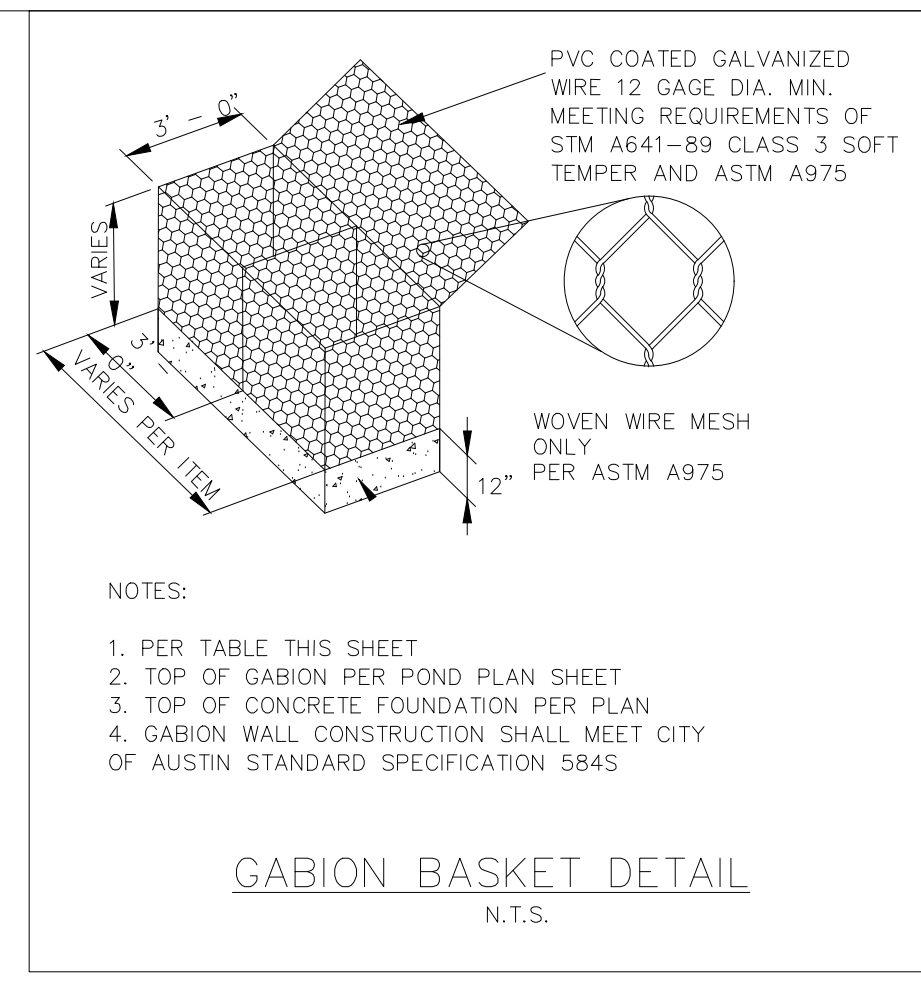
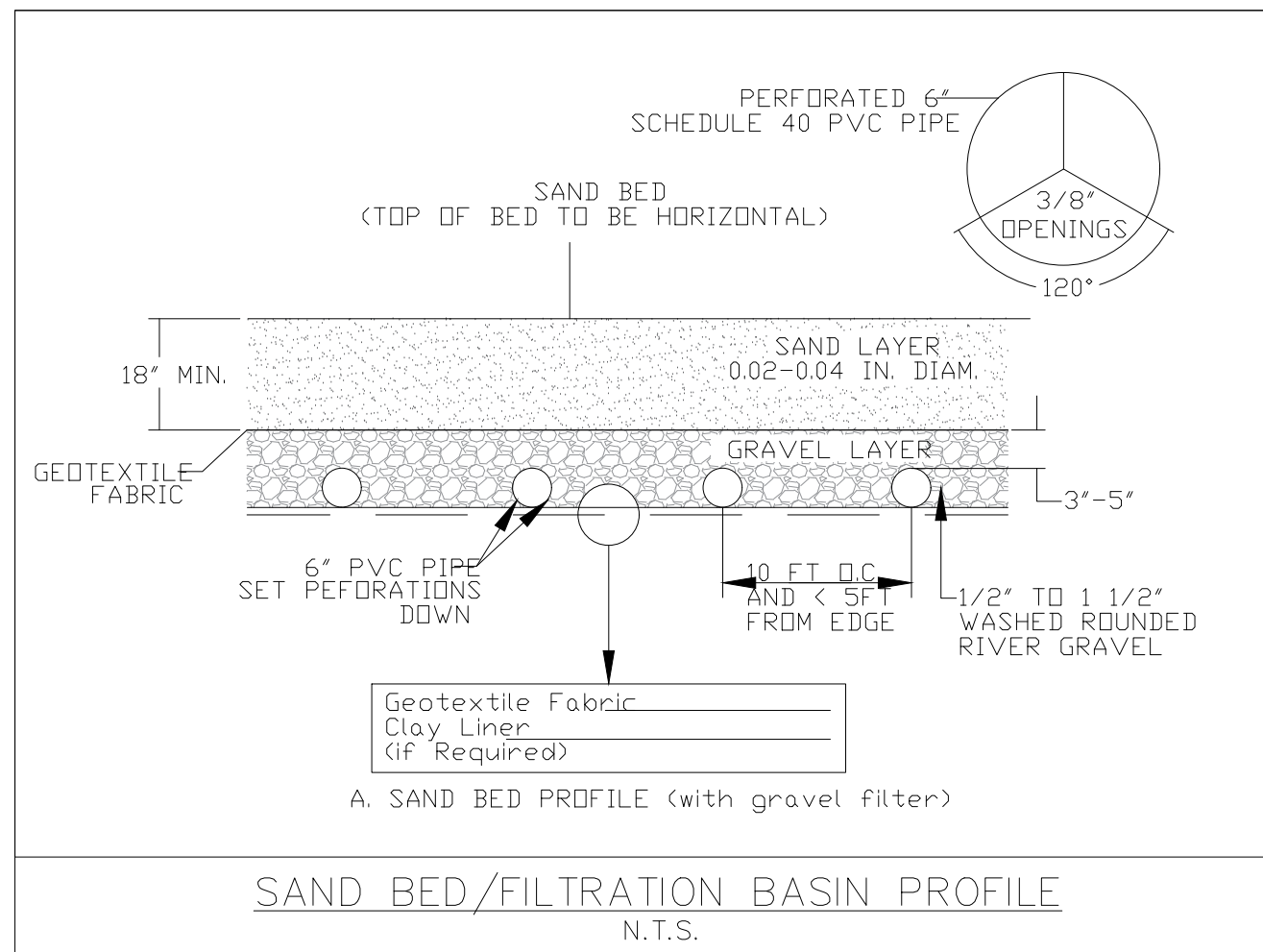
GREAT OAKS DR.
15917 GREAT OAKS DRIVE

GRADING PLAN



SHEET:
07
OF 17

PROPOSED GRADING PLAN
SCALE: 1"=30'



GABION WALL BASKET STONE SPECIFICATIONS

SLEEVE SIZE	PERCENT BY WEIGHT (MASS) % PASSING EACH INDIVIDUAL SIEVE
8 INCH	100
4 INCH	0-5
3 INCH	0

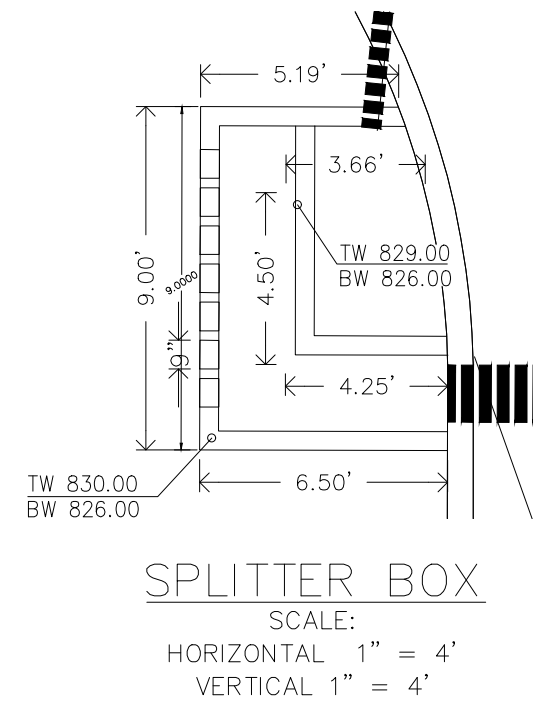
THE STONE USED TO FILL THE MATTRESS SHALL BE AS SPECIFIED FOR THE GABION WALL EXCEPT THAT IT SHALL HAVE A MAXIMUM DIMENSION OF 5 INCHES AND A MINIMUM DIMENSION OF 3 INCHES. THE MAJORITY OF THE STONE SHALL BE IN THE 3-4 INCH RANGE; CUBICAL OR ROUNDED IN SHAPE.

NONWOVEN GEOTEXTILE FABRIC SPECIFICATIONS

UNIT WEIGHT	MINIMUM FILTRATION RATE	MINIMUM PUNCTURE STRENGTH	MINIMUM MULLEN BURST STRENGTH	TENSILE STRENGTH
8 OZ/SY	0.08 IN./SEC	125 LBS	400 PSI	200 LBS

30 MILS THICK AND ULTRAVIOLET RESISTANT.

NOTE: RETAINING WALLS, OVER FOUR FEET IN HEIGHT, MEASURED FROM THE BOTTOM OF THE FOOTING TO THE TOP OF THE WALL, SHALL BE DESIGNED BY A PROFESSIONAL ENGINEER AND WILL REQUIRE A SEPARATE PERMIT (INTERNATIONAL BUILDING CODE 106.2.5).

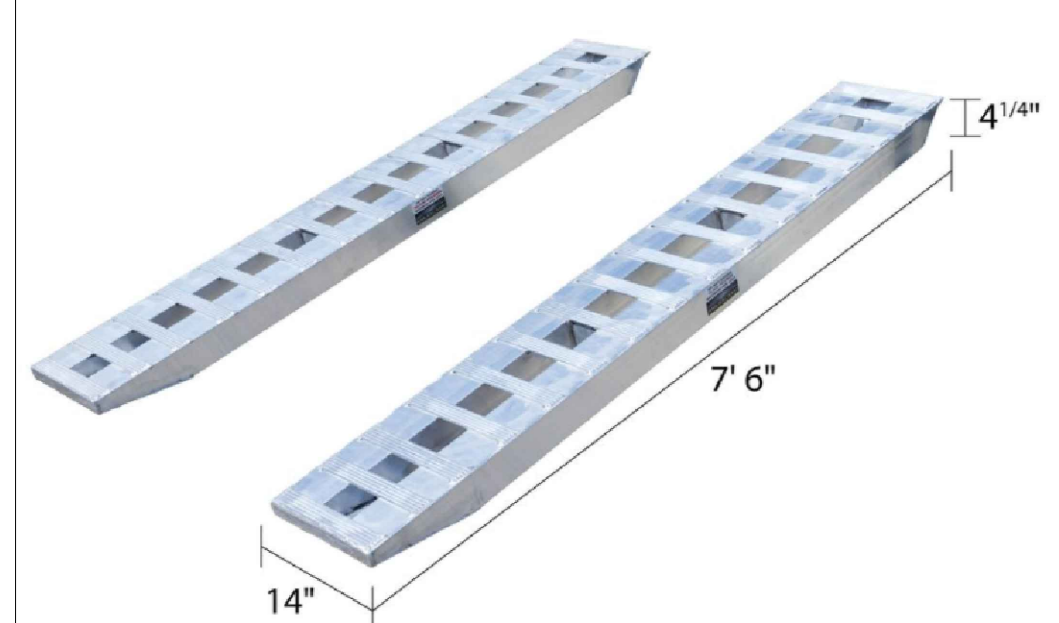


RESULTS OF PIPE CONNECTING WATER QUALITY POND TO DETENTION

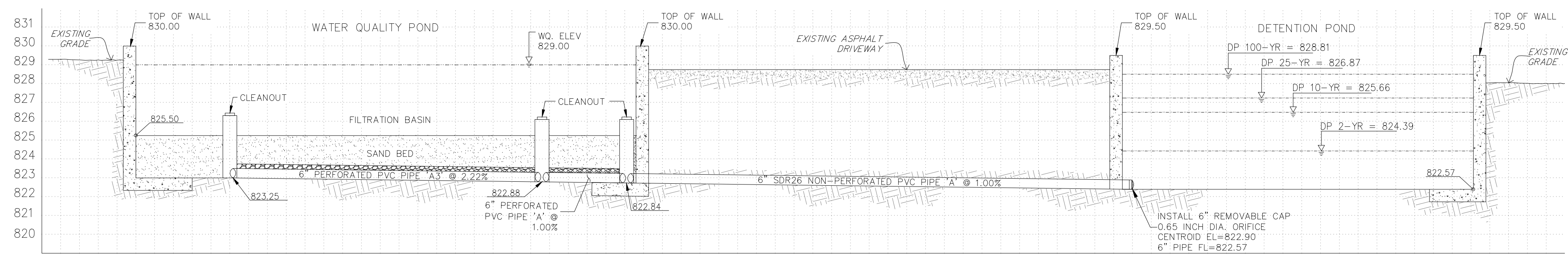
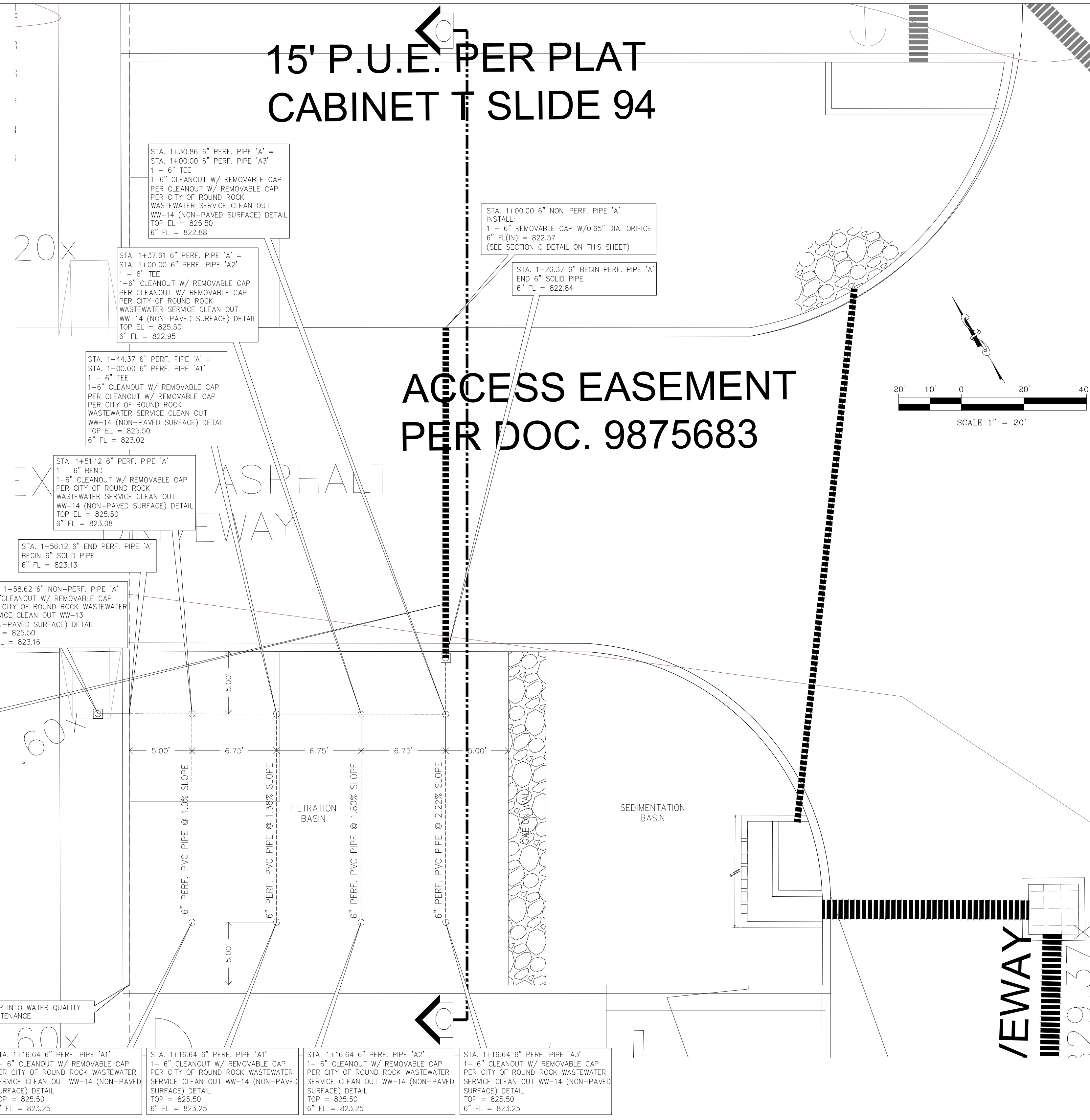
Inputs		Results	
Pipe diameter, d_0	6 in	Flow depth, y	0.4500 ft
Manning roughness, n	0.009	Flow area, a	0.1861 ft ²
Pressure slope (possibly ? equal to pipe slope), S_0	1 % rise/run	Pipe area, a_0	0.1964 ft ²
Relative flow depth, y/d_0	0.9	Relative area, a/a_0	0.9480
		Wetted perimeter, P_w	1.2490 ft
		Hydraulic radius, R_h	0.1490 ft
		Top width, T	0.3000 ft
		Velocity, v	4.6406 ft/sec
		Velocity head, h_v	0.3347 ft H ₂ O
		Froude number, F	1.04
		Average shear stress (tractive force), τ_{av}	0.0930 psf
		Flow, Q (See notes)	0.8637 cfs
		Full flow, Q_0	0.8104 cfs
		Ratio to full flow, Q/Q_0	1.0658

NOTE: PEAK DISCHARGE FROM WATER QUALITY POND TO DETENTION POND IS 0.29 CFS. SEE HEC-HMS MODEL ATTACHED IN SUBMITTAL.

ALUMINUM RAMPS INTO PONDS



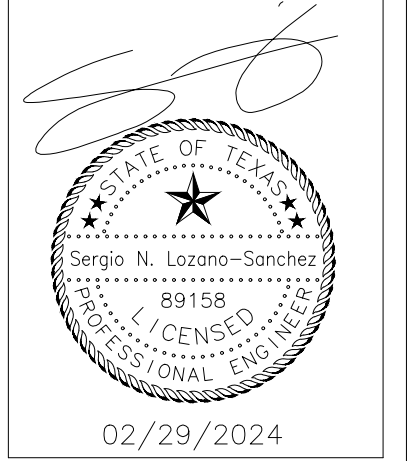
MANUFACTURED FROM HIGH-STRENGTH, LIGHTWEIGHT ALUMINUM MEASURES 7' 6\"/>



WATER QUALITY - DETENTION POND SECTION C NOT TO SCALE

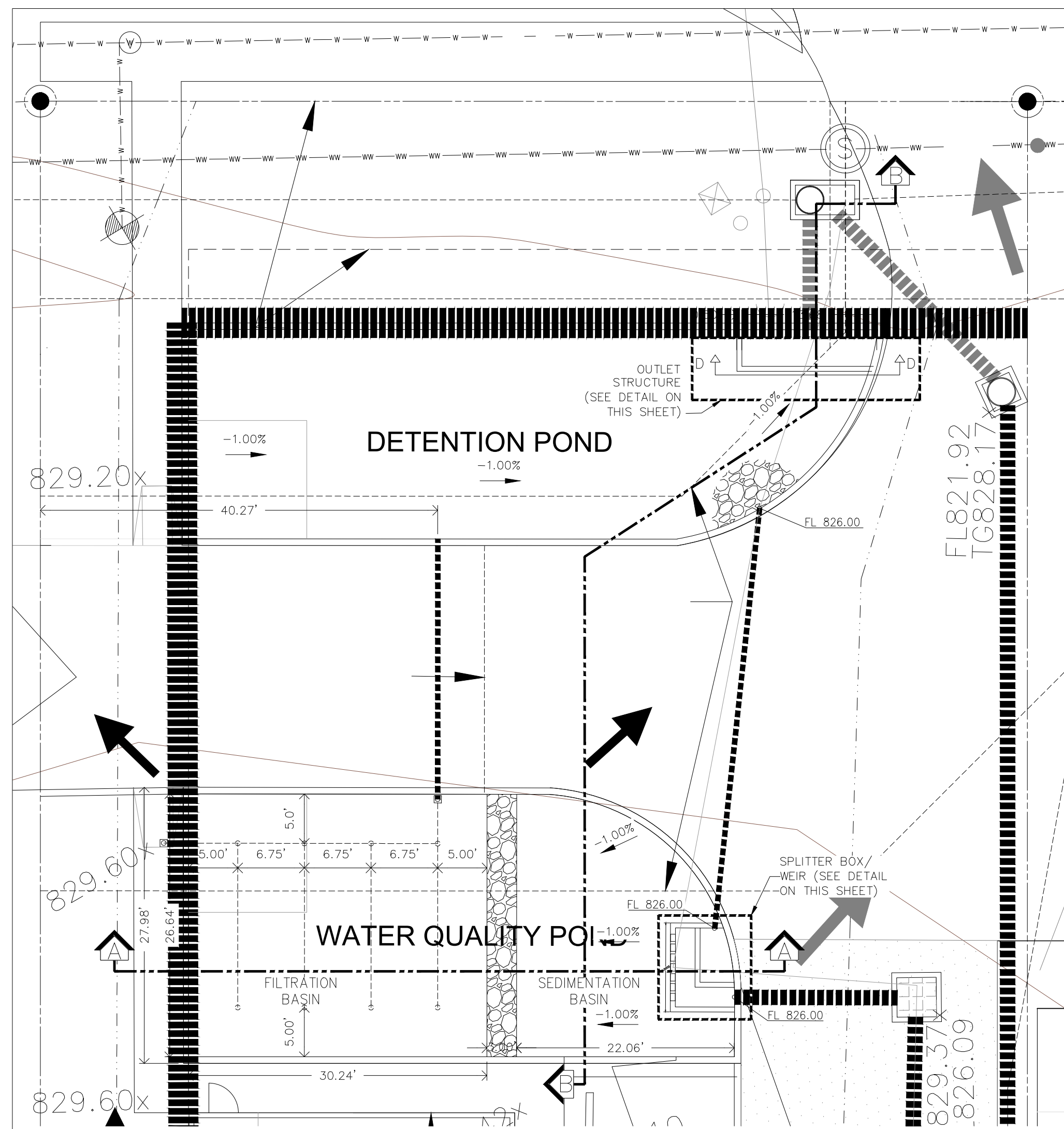
REVISIONS / CORRECTIONS

NO.	DESCRIPTION



GREAT OAKS DR.
15917 GREAT OAKS DRIVE
DETENTION AND WATER QUALITY POND PLAN



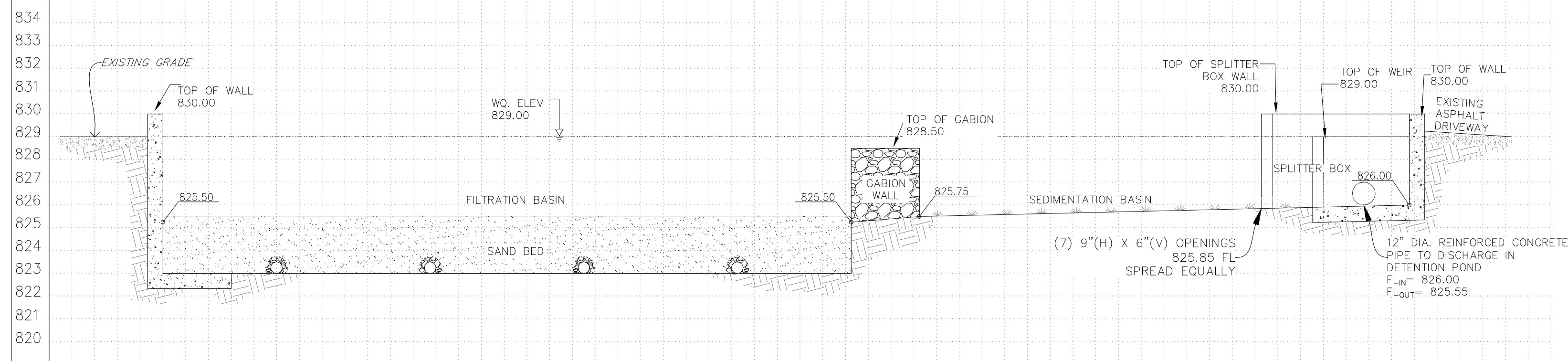


NOTE:
SAND GRAIN SIZE SHOULD BE COMPARABLE TO THAT OF "WASHED CONCRETE SAND" (i.e. ASTM C-33 FINE AGGREGATES).

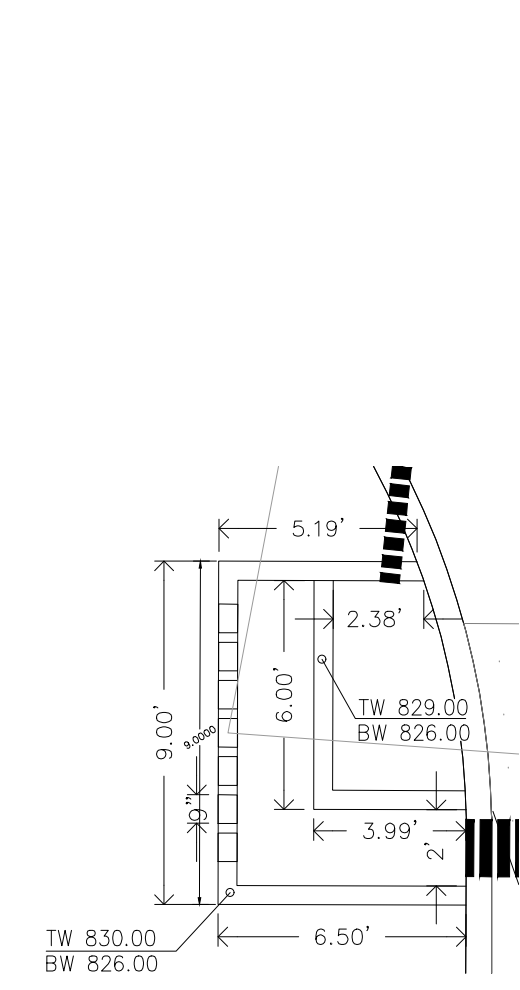
NOTE:
THE SEDIMENTATION BASIN OF THE POND SHOULD BE STABILIZED WITH VEGETATION. THE TOPSOIL THICKNESS SHOULD BE 4" ALONG THE BOTTOM OF THE POND.

WATER QUALITY AND DETENTION POND DIMENSIONS

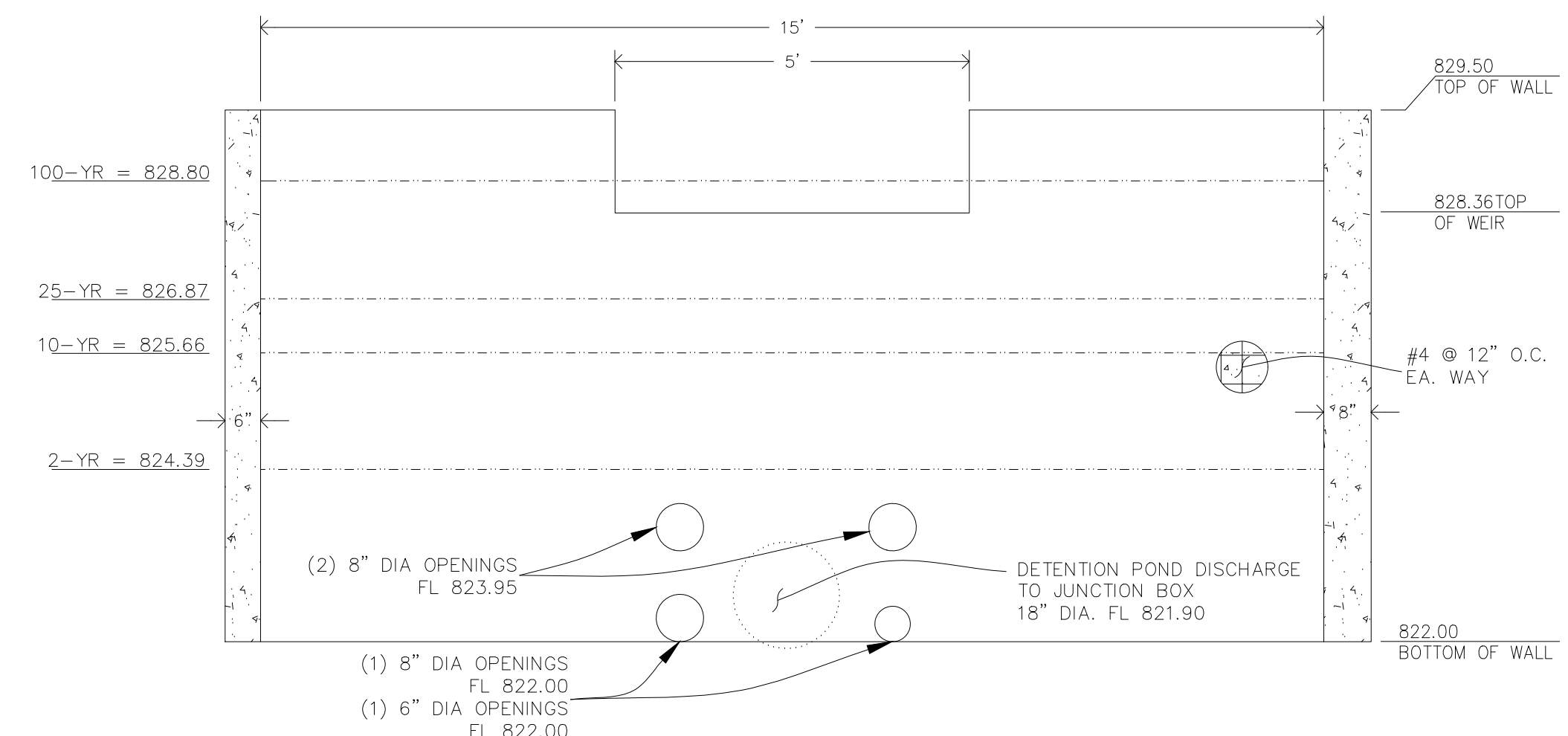
SCALE:
HORIZONTAL 1" = 10'
VERTICAL 1" = 10'



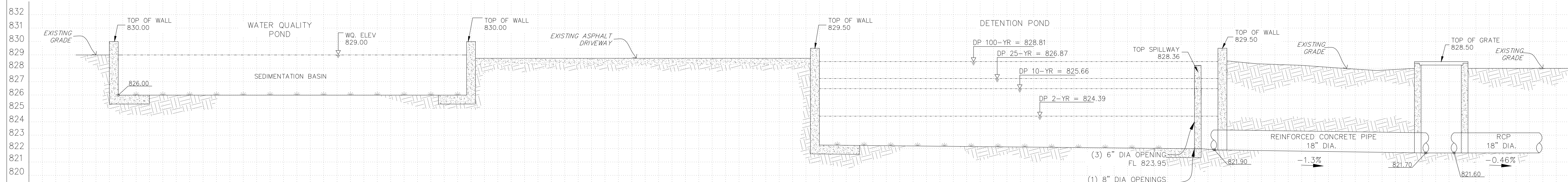
WATER QUALITY - SECTION A
NOT TO SCALE



SPLITTER BOX
NOT TO SCALE



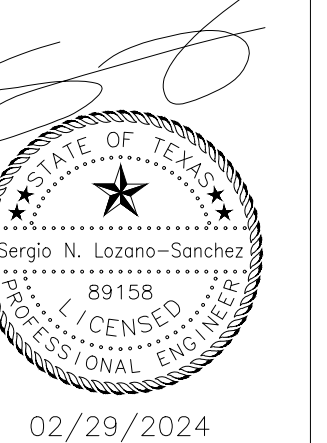
DETENTION POND OUTLET STRUCTURE SECTION D
NOT TO SCALE



WATER QUALITY - DETENTION POND SECTION B
NOT TO SCALE

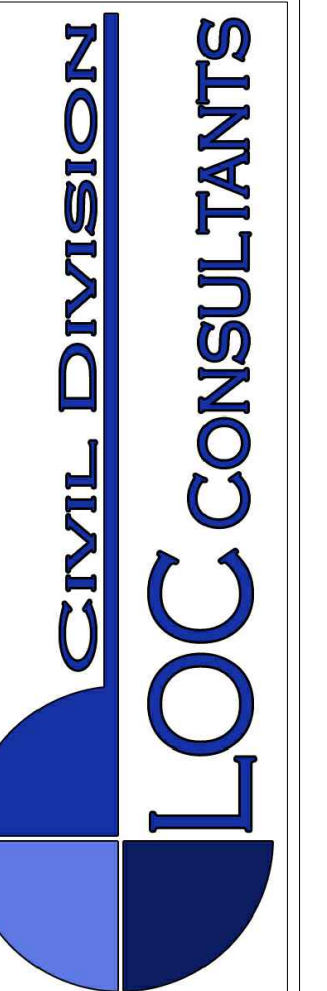
REVISIONS/CORRECTIONS

NO.	DESCRIPTION



02/29/2024

GREAT OAKS DR.
15917 GREAT OAKS DRIVE
DETENTION AND WATER QUALITY
POND DETAILS



SHEET:

9

OF 17

1. The Required Load Reduction for the total project:

Calculations from RG-348

Page 3-29 Equation 3.3: $L_M = 27.2(A_N \times P)$
 Site Data: Determine Required Load Removal Based on the Entire Project
 County = **Williamson**
 Total project area included in plan = **1.79** acres
 Predevelopment impervious area within the limits of the plan = **0.24** acres
 Total post-development impervious area within the limits of the plan = **1.41** acres
 Total post-development impervious cover fraction = **0.79**
 P = **32** inches
 L_M TOTAL PROJECT = **1018** lbs.
 Number of drainage basins / outfalls areas leaving the plan area = **1**

2. Drainage Basin Parameters (This information should be provided for each basin):

Drainage Basin/Outfall Area No. = **1**
 Total drainage basin/outfall area = **1.79** acres
 Predevelopment impervious area within drainage basin/outfall area = **0.24** acres
 Post-development impervious area within drainage basin/outfall area = **1.41** acres
 Post-development impervious fraction within drainage basin/outfall area = **0.79**
 L_M THIS BASIN = **1018** lbs.

3. Indicate the proposed BMP Code for this basin.

Proposed BMP = **Sand Filter**
 Removal efficiency = **89** percent

4. Calculate Maximum TSS Load Removed (L_R) for this Drainage Basin by the selected BMP Type.

RG-348 Page 3-33 Equation 3.7: $L_R = (BMP \text{ efficiency}) \times P \times (A_i \times 34.6 + A_p \times 0.54)$

where:
 A_C = Total On-Site drainage area in the BMP catchment area
 A_i = Impervious area proposed in the BMP catchment area
 A_p = Pervious area remaining in the BMP catchment area
 L_R = TSS Load removed from this catchment area by the proposed BMP
 A_C = **1.790** acres
 A_i = **1.41** acres
 A_p = **0.38** acres
 L_R = **1395** lbs.

5. Calculate Fraction of Annual Runoff to Treat the drainage basin / outfall area

Desired L_M THIS BASIN = **1018** lbs.
 F = **0.73**

6. Calculate Capture Volume required by the BMP Type for this drainage basin / outfall area.

Calculations from RG-348 Pages 3-34 to 3-36

Rainfall Depth = **0.86** inches
 Post Development Runoff Coefficient = **0.61**
 On-site Water Quality Volume = **3393** cubic feet
 Off-site area draining to BMP = **0.00** acres
 Off-site Impervious cover draining to BMP = **0.00** acres
 Impervious fraction of off-site area = **0.00**
 Off-site Runoff Coefficient = **0.00**
 Off-site Water Quality Volume = **0** cubic feet
 Storage for Sediment = **679**
 Total Capture Volume (required water quality volume(s) x 1.20) = **4072** cubic feet

9. Filter area for Sand Filters

Designed as Required in RG-348 Pages 3-58 to 3-63

9B. Partial Sedimentation and Filtration System

Water Quality Volume for combined basins = **4072** cubic feet
 Minimum filter basin area = **339** square feet
 Maximum sedimentation basin area = **1357** square feet For minimum water depth of 2 feet
 Minimum sedimentation basin area = **85** square feet For maximum water depth of 8 feet

SEDIMENTATION POND:			
STAGE (FT. MSL)*	AREA (SF)	STORAGE (CF)	CUM. STORAGE (CF)
825.75	0	0	0
826.00	580	73	73
826.50	580	290	363
827.00	580	290	653
827.50	580	290	943
828.00	580	290	1,233
828.50	580	290	1,523
829.00	580	290	1,813
829.50	580	290	2,103

* INPUT AT ONE FOOT OR LESS INCREMENTS

FILTRATION POND:			
STAGE (FT. MSL)*	AREA (SF)	STORAGE (CF)	CUM. STORAGE (CF)
825.50	805	0	0
826.00	805	403	403
826.50	805	403	805
827.00	805	403	1,208
827.50	805	403	1,610
828.00	805	403	2,013
828.50	805	403	2,416
829.00	805	403	2,818
829.50	805	403	3,221
TOTAL			4,631

* INPUT AT ONE FOOT OR LESS INCREMENTS

DETENTION POND CALCULATIONS						
STORM/STORAGE/OUTFLOW TABLE (HEC-HMS 4.4.1)						
Storm Frequency (yr)	Peak Outflow Allowed at Discharge Point (Exist. Flow.) Drainage Area (cfs)	Peak Flow Generated From Proposed Improvements at Discharge Point W/O Detention (cfs)	Peak Flow Generated From Proposed Improvements at Discharge Point W/ Detention (Prop. Flow) (cfs)	Pond Peak Outflow (cfs)	Maximum VISE (ft)	
2	6.37	8.55	6.70	3.83	824.43	
10	12.85	15.29	12.69	6.71	826.48	
25	16.48	19.00	16.40	8.65	827.24	
100	22.38	25.01	22.30	11.66	828.50	

ELEVATION/ STAGE/ STORAGE TABLE						
ELEVATION (ft)	AREA (sf)	AREA (ac)	AVG AREA (ac)	VOLUME (ac-ft)	TOTAL VOLUME PROVIDED (ac-ft)	TOTAL STORAGE PROVIDED (cu-ft)
822.00	0	0.000000	0	0	0	0
822.50	1,234	0.0283223	0.028	0.005	0.005	206
823.00	1,234	0.0283223	0.085	0.014	0.019	822
823.50	1,234	0.0283223	0.085	0.014	0.033	1,439
824.00	1,234	0.0283223	0.085	0.014	0.047	2,056
824.50	1,234	0.0283223	0.085	0.014	0.061	2,673
825.00	1,234	0.0283223	0.085	0.014	0.076	3,290
825.50	1,234	0.0283223	0.085	0.014	0.090	3,907
826.00	1,234	0.0283223	0.085	0.014	0.104	4,524
826.50	1,234	0.0283223	0.085	0.014	0.118	5,140
827.00	1,234	0.0283223	0.085	0.014	0.132	5,757
827.50	1,234	0.0283223	0.085	0.014	0.146	6,374
828.00	1,234	0.0283223	0.085	0.014	0.160	6,991
828.50	1,234	0.0283223	0.085	0.014	0.175	7,608
829.00	1,234	0.0283223	0.085	0.014	0.189	8,225
829.50	1,234	0.0283223	0.085	0.014	0.203	8,842

NOTES:
 1. AVERAGE AREA = A1+A2 + SQRT(A1*A2)
 2. INCREMENTAL VOLUME BY CONIC METHOD
 Volume = (1/3)*(EL2-EL1)*[(A1+A2)+SQRT(A1*A2)]
 3. AREAS OBTAINED IN AUTOCAD
 4. ORIFICE COEFFICIENT 0.6
 5. WEIR COEFFICIENT 3.0

SOURCES:
 1. UNITED STATES DEPARTMENT OF AGRICULTURE - SOIL CONSERVATION SERVICE TECHNICAL RELEASE NO. 55 (2ND EDITION, JUNE 1986) 210-VI. URBAN HYDROLOGY FOR SMALL WATERSHEDS.
 2. UNITED STATES ARMY CORPS OF ENGINEERS, HEC-HMS 4.1.
 3. USDA NATURAL RESOURCES CONSERVATION SERVICE WEB SOILS SURVEY 2.1, NATIONAL COOPERATIVE SOIL SURVEY FOR WILLIAMSON COUNTY, TEXAS.

WATER QUALITY POND 48-HOUR DRAW-DOWN CALCULATIONS	
$Q = C_o * A * (2gh)^{0.5}$	
ORIFICE	
WATER QUALITY VOLUME (WQV)	4,631 CF
WATER QUALITY ELEVATION	829.00 FT
FILTRATION MEDIA ELEVATION	825.50 FT
CENTROID AT OUTFALL	823.25 FT
h1	5.75 FT
h2	2.25 FT
h = (h1+h2)/2	4.00 FT
WQV PER SECOND (WQV/S)	0.02680 CFS
AREA (A) = (WQV/S)/(C _o *2gh) ^{0.5}	0.00278 SQ-FT
AREA (A)	0.40 SQ-IN
RADIUS (r) = (A/P) ^{0.5}	0.38 IN
DIAMETER (d) = 2*r	0.71 IN

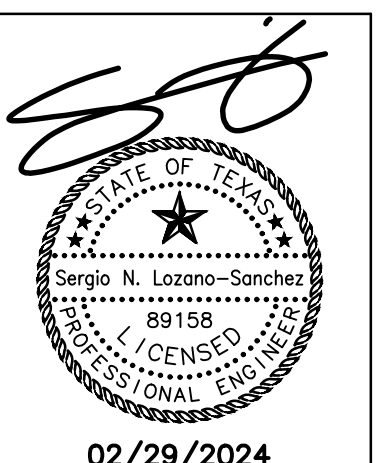
DETENTION SPLITTER WEIR CALCULATIONS		
BROAD CRESTED TYPE $Q = 3.0 \times L \times h^{3/2}$		
SPLITTER BOX		
WEIR LENGTH	12.4 FT	
WEIR ELEVATION	829.00 FT	
WEIR STEP	0.10 FT	
MAXIMUM HEAD	15.90 FT	
BYPASS FLOW (Q100)	829.57 FT	
CALCULATED HEAD TO BYPASS FLOW (Q100)	0.57 FT	
HEAD REQUIRED TO BYPASS CALCULATED FLOW (Q100)	0.43 FT	
FREEBOARD PROVIDED (Q100)	0.43 FT	
BYPASS FLOW (Q25)	12.43 CFS	
CALCULATED HEAD TO BYPASS FLOW (Q25)	829.48 FT	
HEAD REQUIRED TO BYPASS CALCULATED FLOW (Q25)	0.48 FT	
FREEBOARD PROVIDED (Q25)	0.52 FT	

ELEVATION (FT)	h (FT)	Q (cfs)
829.00	0.0	0.00
829.10	0.10	1.18
829.20	0.20	3.33
829.30	0.30	6.12
829.40	0.40	9.42
829.50	0.50	13.16
829.60	0.60	17.30
829.70	0.70	21.80
829.80	0.80	26.64
829.90	0.90	31.79
830.00	1.00	37.23

SLOTTED DRAIN PIPE & 18" CPP PIPE STORAGE	
Elevation (FT)	VOLUME (AC-FT)
0	0
0.25	0.004210233
0.5	0.011430139
0.75	0.020061636
1	0.029325241
1.25	0.035596172
1.5	0.042051289
1.75	0.048506405
2	0.054777337
2.25	0.060662605

REVISIONS / CORRECTIONS

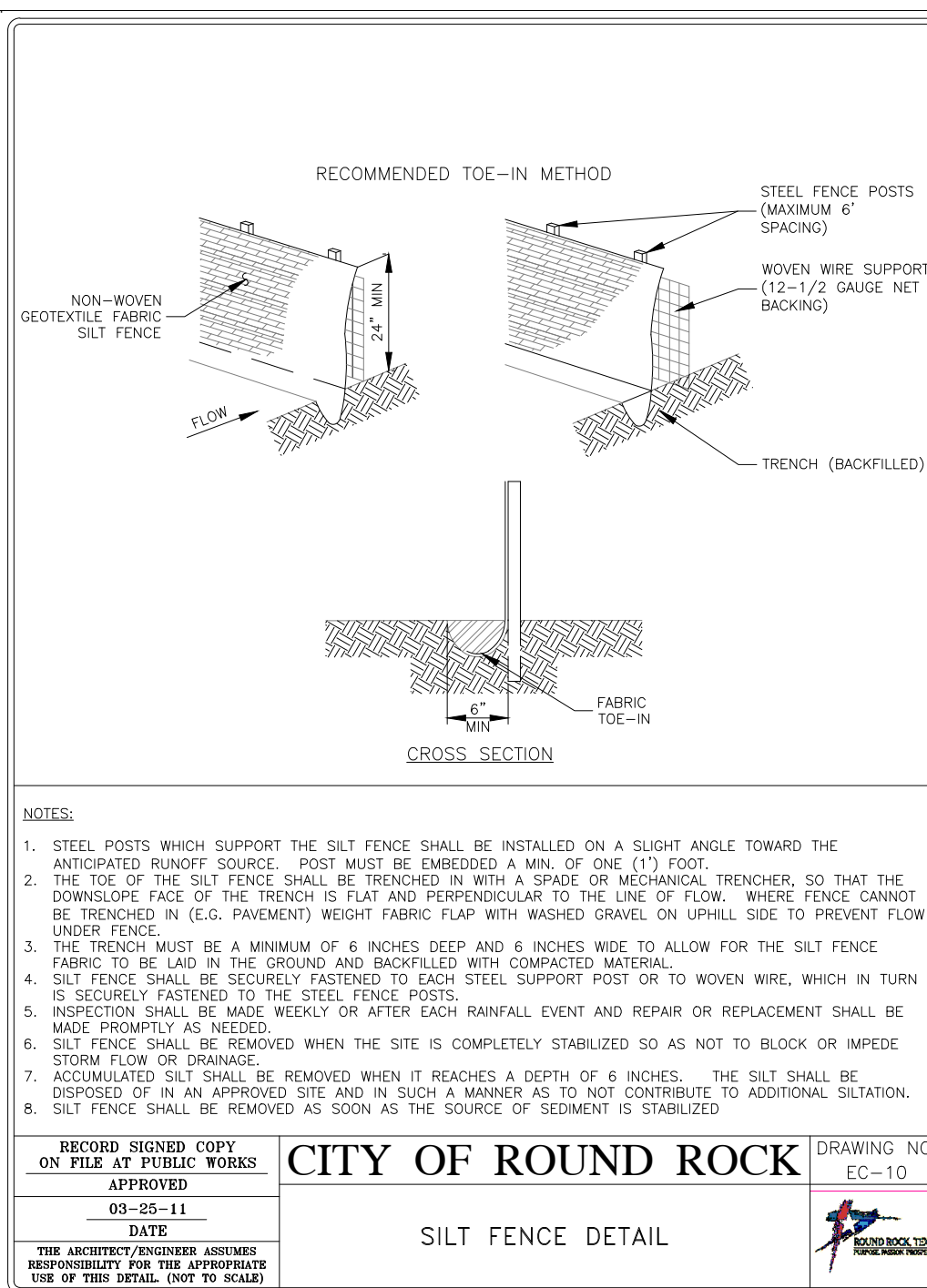
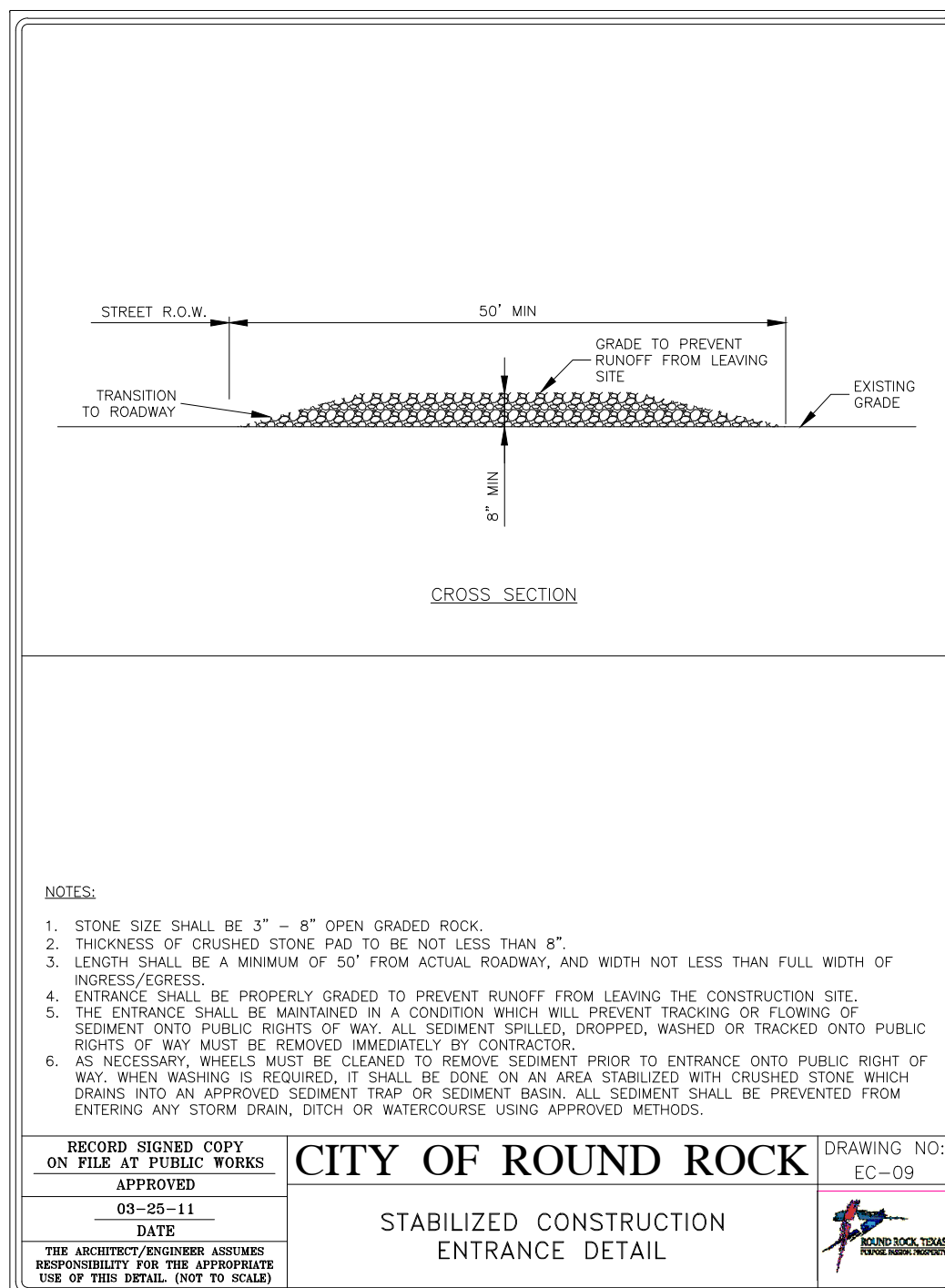
NO.	DESCRIPTION



GREAT OAKS DR.
 15917 GREAT OAKS DRIVE
 DETENTION AND WATER QUALITY POND CALCULATIONS



SHEET:



NOTES:

- STONE SIZE SHALL BE 3" - 8" OPEN GRADED ROCK.
- THICKNESS OF CRUSHED STONE PAD TO BE NOT LESS THAN 8".
- LENGTH SHALL BE A MINIMUM OF 50' FROM ACTUAL ROADWAY AND WIDTH NOT LESS THAN FULL WIDTH OF INGRESS/EGRESS.
- ENTRANCE SHALL BE PROPERLY GRADED TO PREVENT RUNOFF FROM LEAVING THE CONSTRUCTION SITE.
- THE ENTRANCE SHALL BE MAINTAINED IN A CONDITION WHICH WILL PREVENT TRACKING OR FLOWING OF SEDIMENT ONTO PUBLIC RIGHTS OF WAY. ALL SEDIMENT SPILLED, DROPPED, WASHED OR TRACKED ONTO PUBLIC RIGHTS OF WAY MUST BE REMOVED IMMEDIATELY BY CONTRACTOR.
- IF NECESSARY, WHEELS MUST BE CLEANED TO REMOVE SEDIMENT PRIOR TO ENTRANCE ONTO PUBLIC RIGHT OF WAY. WHEN WASHING IS REQUIRED, IT SHALL BE DONE ON AN AREA STABILIZED WITH CRUSHED STONE WHICH GRABS INTO AN APPROVED SEDIMENT TRAP OR SEDIMENT BASIN. ALL SEDIMENT SHALL BE PREVENTED FROM ENTERING ANY STORM DRAIN, DITCH OR WATERCOURSE USING APPROVED METHODS.

RECORD SIGNED COPY ON FILE AT PUBLIC WORKS APPROVED DATE 03-25-11

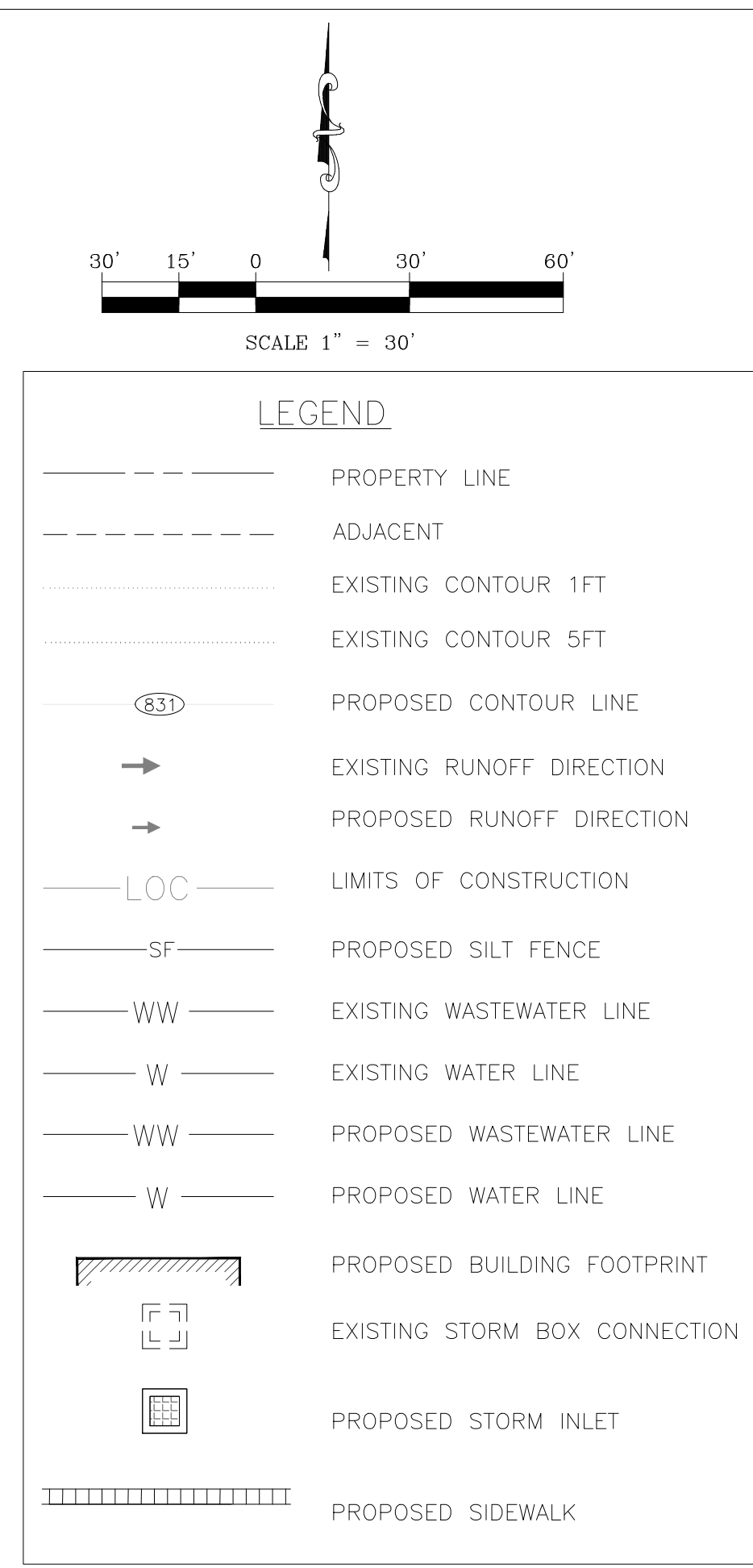
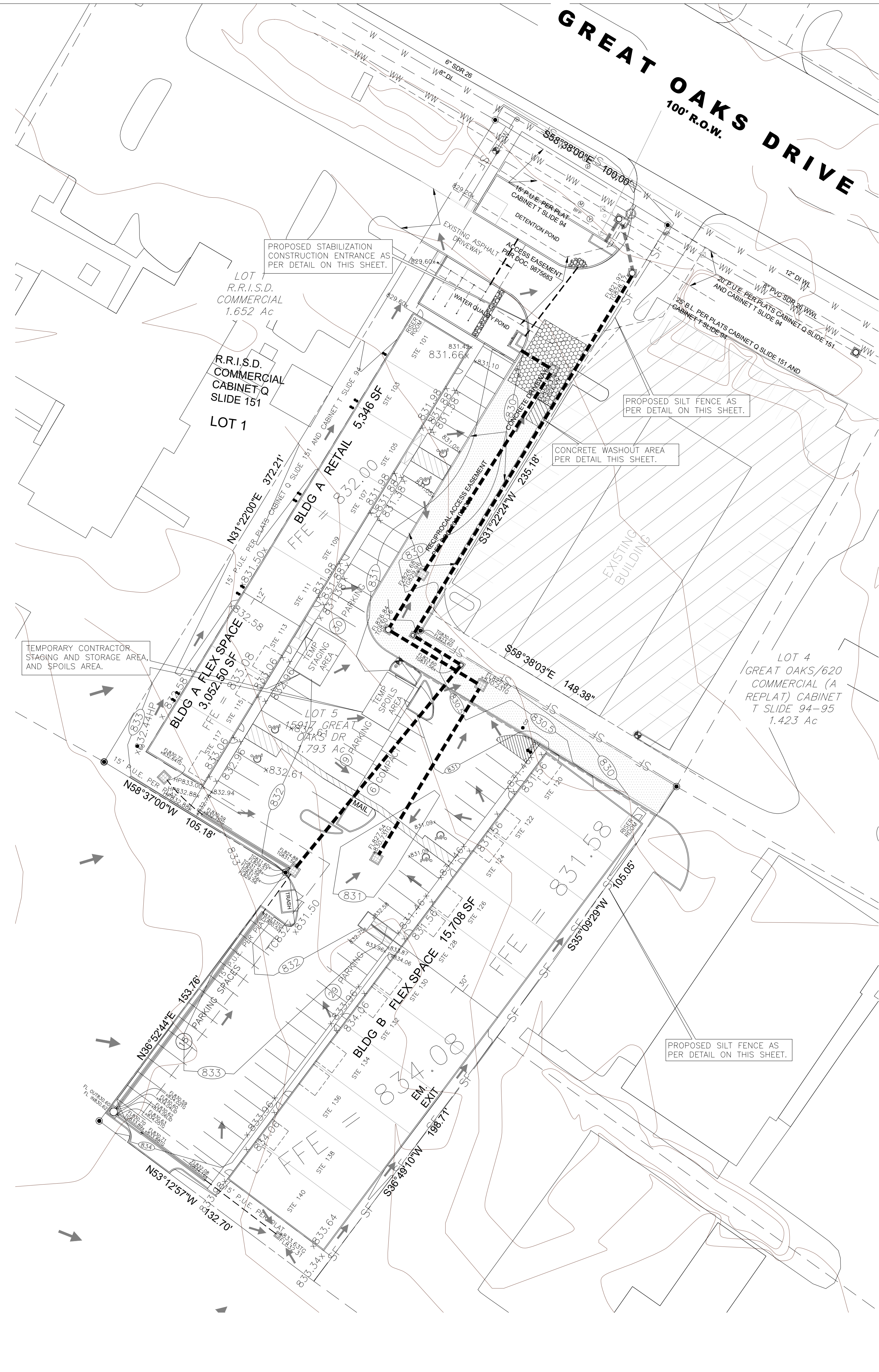
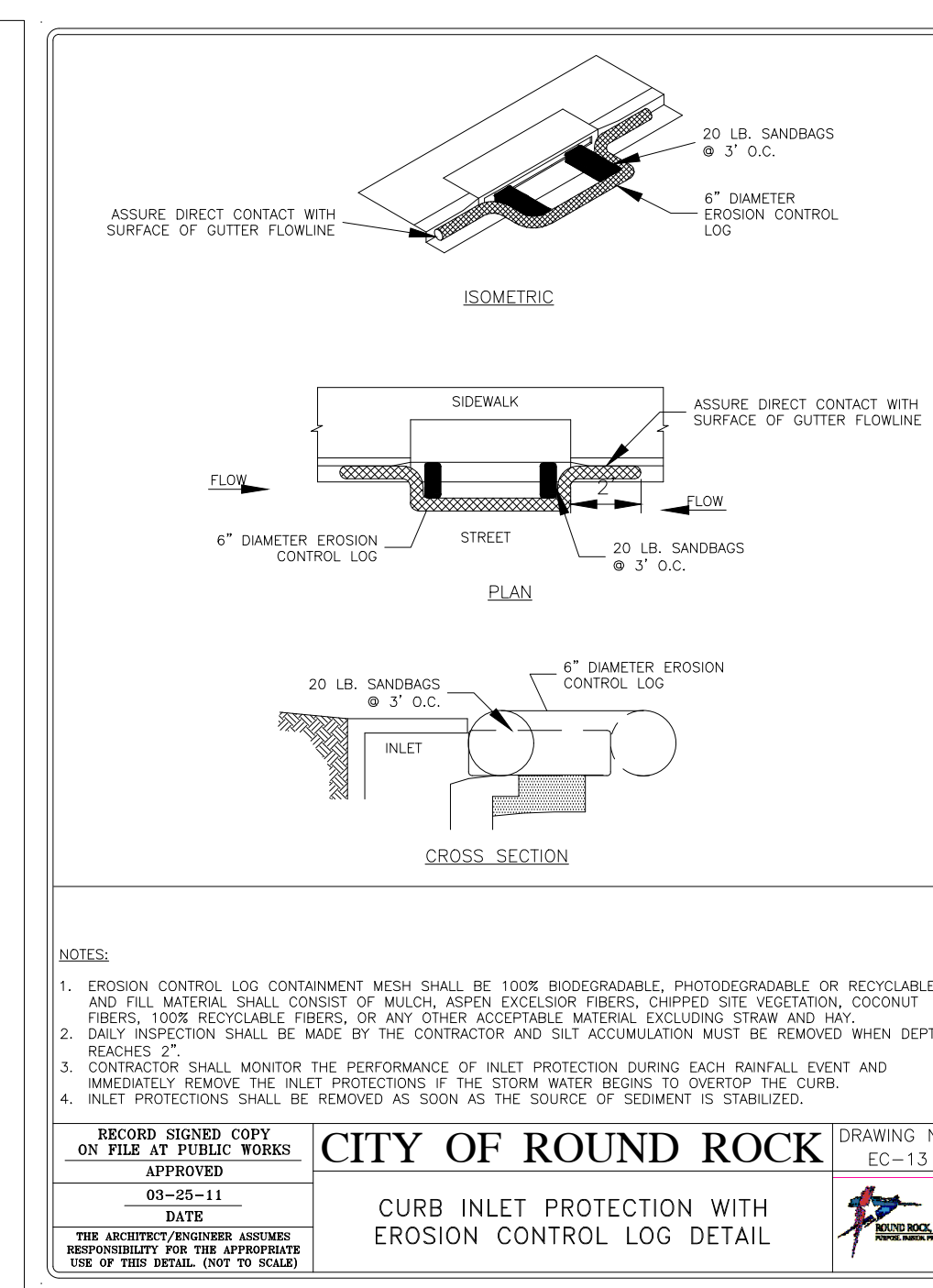
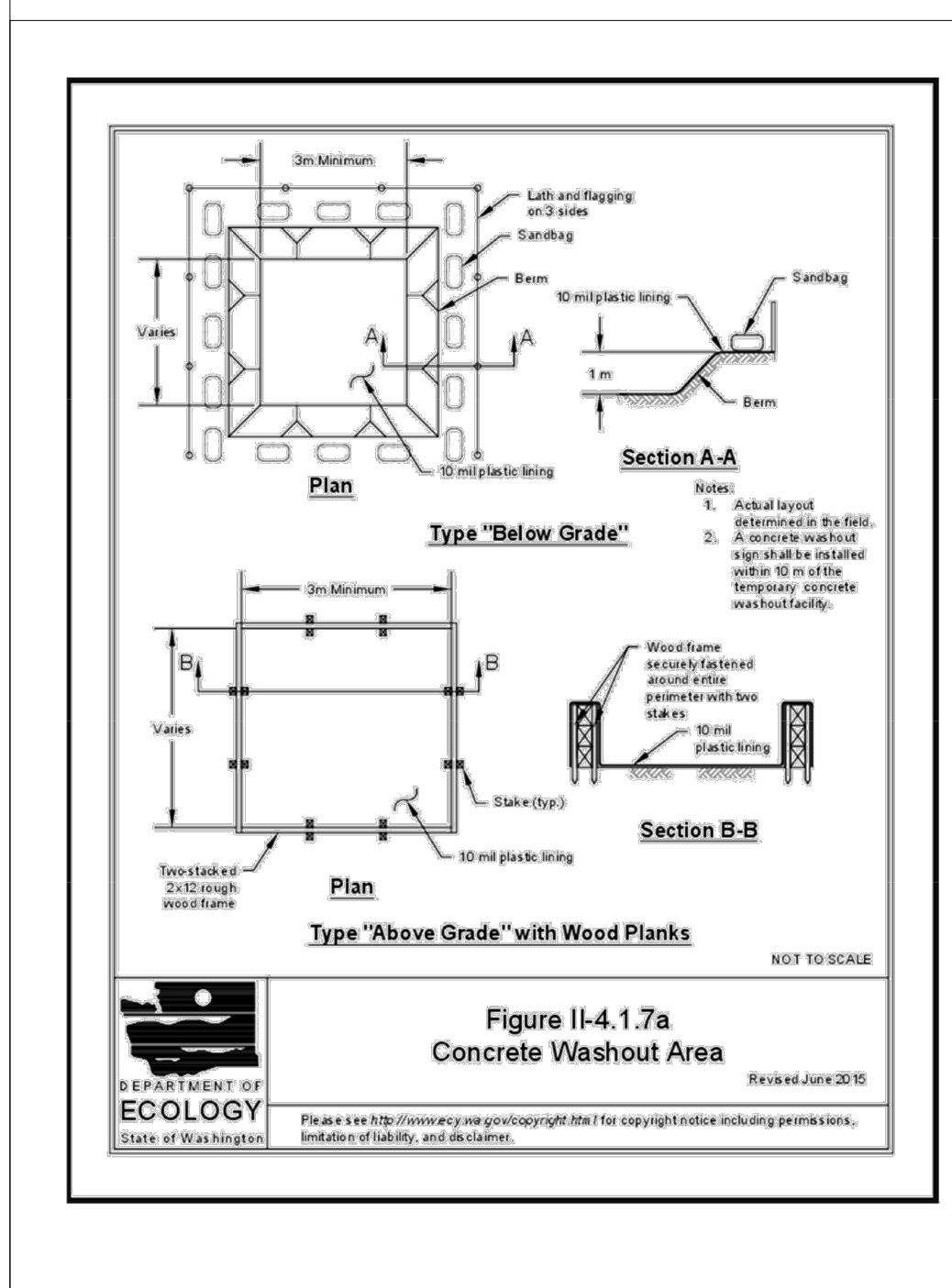
CITY OF ROUND ROCK DRAWING NO: EC-09

STABILIZED CONSTRUCTION ENTRANCE DETAIL

RECORD SIGNED COPY ON FILE AT PUBLIC WORKS APPROVED DATE 03-25-11

CITY OF ROUND ROCK DRAWING NO: EC-10

SILT FENCE DETAIL



- STANDARD NOTES
- THE ENVIRONMENTAL INSPECTOR HAS THE AUTHORITY TO ADD AND OR MODIFY EROSION/SEDIMENTATION CONTROL ON SITE TO KEEP PROJECT IN COMPLIANCE WITH THE CITY OF ROUND ROCK'S RULES AND REGULATIONS.
 - CONTRACTOR SHALL UTILIZE DUST CONTROL MEASURES DURING SITE CONSTRUCTION SUCH AS IRRIGATION TRUCKS AND MULCHING AS PER ECM 1.4.5(A), OR AS DIRECTED BY THE ENVIRONMENTAL INSPECTOR.
 - CONTRACTOR MUST CLEAN UP SPOILS THAT MIGRATE ONTO THE ROADS AT LEAST ONCE DAILY.
 - SILT FENCE TYPE AND INSTALLATION SHALL COMPLY WITH CITY OF ROUND ROCK SPECIFICATIONS.
 - CITY OF ROUND ROCK SPECIFICATIONS FOR SILT FENCE (642S) REQUIRES "NON-WOVEN" GEOTEXTILE SILT FENCE, WITH A MINIMUM WEIGHT OF 4.5 OZ/SQFT.
 - A PRE-CONSTRUCTION MEETING WITH THE ENVIRONMENTAL INSPECTOR IS REQUIRED PRIOR TO ANY SITE DISTURBANCE.
 - IF DISTURBED AREA IS NOT TO BE WORKED ON FOR MORE THAN 15 DAYS, DISTURBED AREA NEEDS TO BE STABILIZED BY RE-VEGETATION, MULCH, TARP OR RE-VEGETATION MATTING.
 - TO PREVENT MIGRATION OF DUST FROM THE SITE DURING WINDY CONDITIONS, CONTRACTOR SHALL SPRINKLE EXPOSED SOIL WITH WATER UNTIL THE SURFACE IS MOIST. REPEAT AS NEEDED.

THERE ARE NO TREES ON THE SITE.

EROSION CONTROLS

SILT FENCE:	670 L.F.
LIMITS OF CONSTRUCTION:	74,434 S.F. (1.71AC)
REVEGETATION:	22,475.7 SF

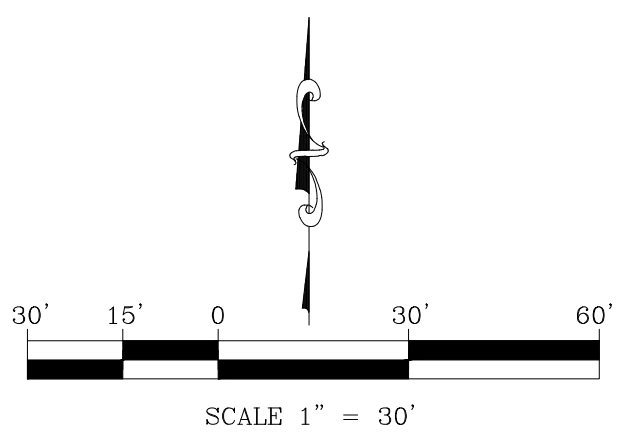
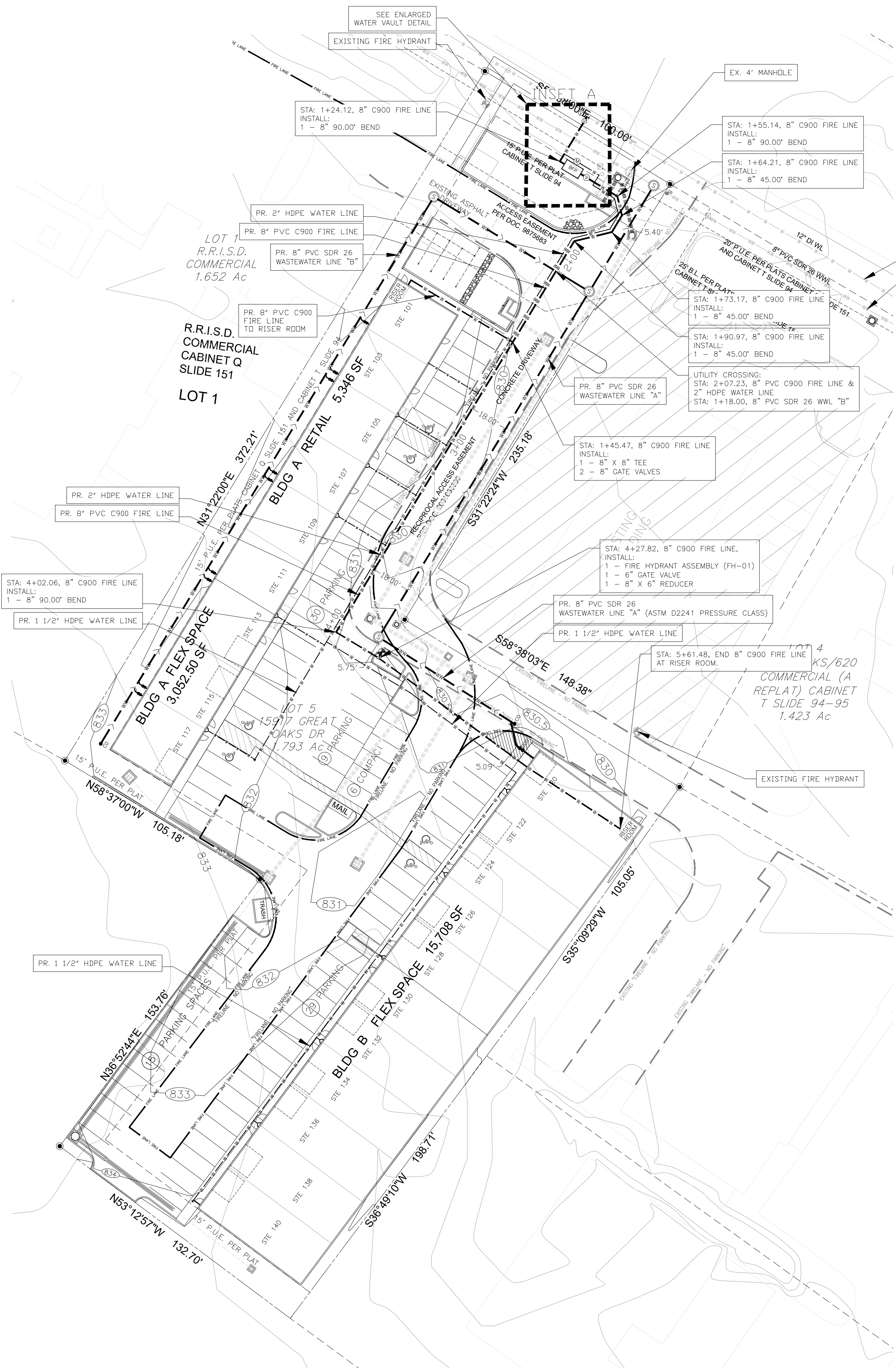
REVISIONS / CORRECTIONS

NO.	DESCRIPTION

GREAT OAKS DR.
15917 GREAT OAKS DRIVE
EROSION & SEDIMENTATION CONTROL PLAN

CIVIL DIVISION
LOC CONSULTANTS

SHEET:
11
OF 17



LEGEND

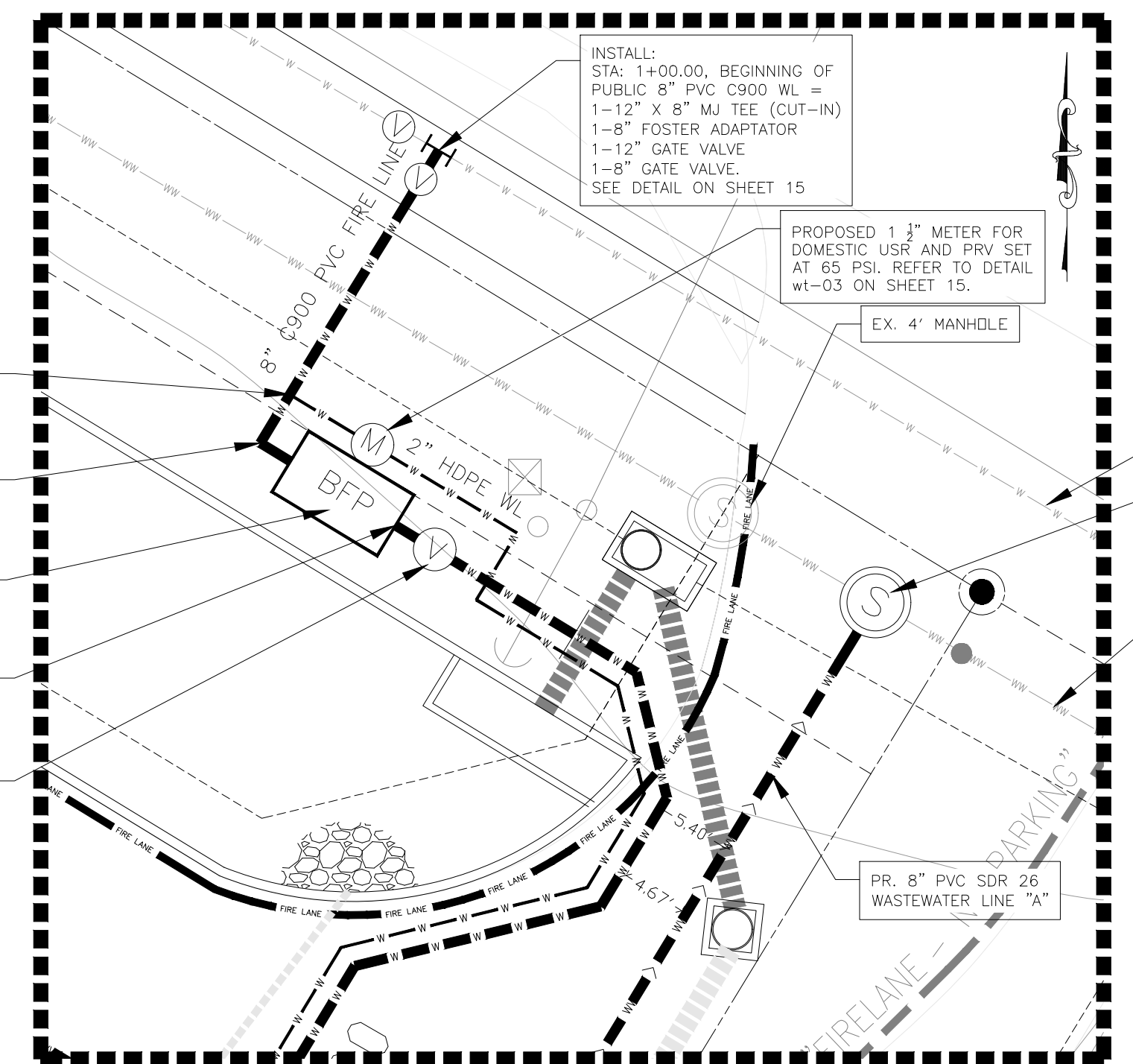
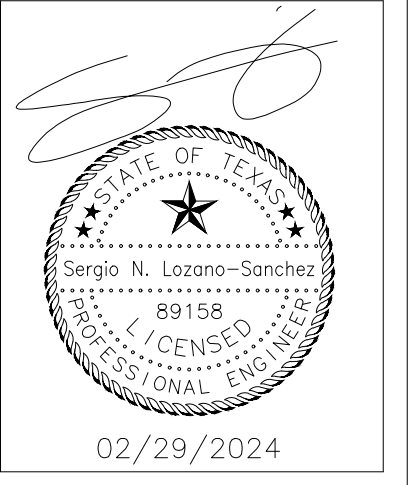
---	PROPERTY LINE
---	EXISTING CONTOUR (1-FT INTERVAL)
---	EXISTING CONTOUR (5-FT INTERVAL)
—W—W—W—	EXISTING WATER
—WW—WW—	EXISTING WASTEWATER LINE
—ww—ww—	PROPOSED WASTEWATER
—w—w—w—	PROPOSED WATER
(M)	PROPOSED WATER METER
●	PROPOSED CLEANOUT
⊕	EXISTING FIRE HYDRANT
⊕	PROPOSED FIRE HYDRANT
⊕	EXISTING MANHOLE
⊕	PROPOSED MANHOLE

FIRE NOTES

- ALL WATER MAINS AND HYDRANTS SHALL BE INSTALLED AND OPERATE AS SOON AS COMBUSTIBLE MATERIALS ARRIVE ON A CONSTRUCTION SITE.
- REQUIRED FIRE DEPARTMENT ACCESS ROADS ARE AN ALL-WEATHER DRIVING SURFACE SUCH AS ASPHALT, CONCRETE OR AS OTHERWISE APPROVED BY AHJ.
- THE GRADE FOR REQUIRED FIRE DEPARTMENT ACCESS ROAD DOES NOT EXCEED 7% PERCENT UNLESS APPROVED BY THE CHIEF.
- THE REQUIRED FIRE DEPARTMENT ACCESS ROADS ARE A MINIMUM UNOBSTRUCTED 20FT IN WIDTH AND 13FT IN 6IN CLEAR HEIGHT OR AS APPROVED IN SITE PLAN.

REVISIONS / CORRECTIONS

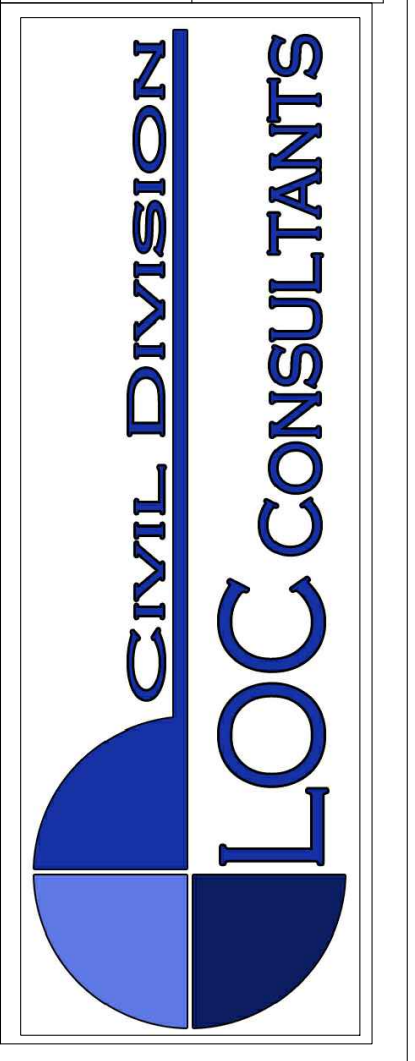
NO.	DESCRIPTION

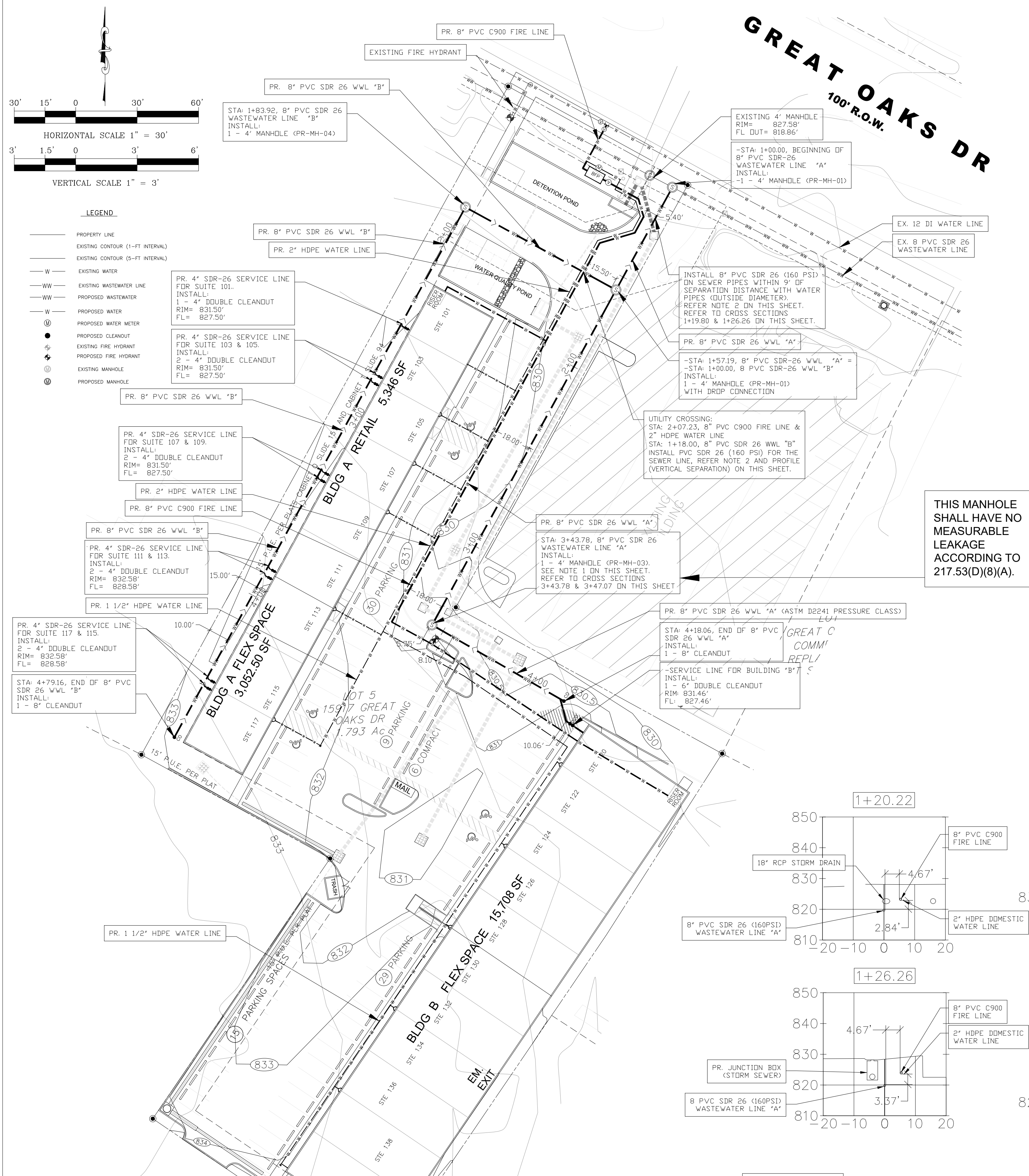


- STA 1+20.13, 8" PVC C900 FL. INSTALL: 1 - 8"x2" SADDLE SERVICE CONNECTION
- STA 1+26.61, 8" PVC C900 FL. INSTALL: BEGINNING OF CONCRETE BFP VAULT (8' 8" X 5' 0")
- DETECTOR-TYPE BACKFLOW PREVENTER TYPE I, 8" AMES SERIES C300 DOUBLE CHECK DETECTOR ASSEMBLY
- STA 1+35.27, 8" PVC C900 FL. INSTALL: END OF CONCRETE BFP VAULT (8' 8" X 5' 0")
- STA 1+26.61, 8" PVC C900 FL. INSTALL: 1 - 8" GATE VALVE

INSET A
SCALE 1" = 10'

GREAT OAKS DR.
15917 GREAT OAKS DRIVE
WATER PLAN





SECTION 217.58:

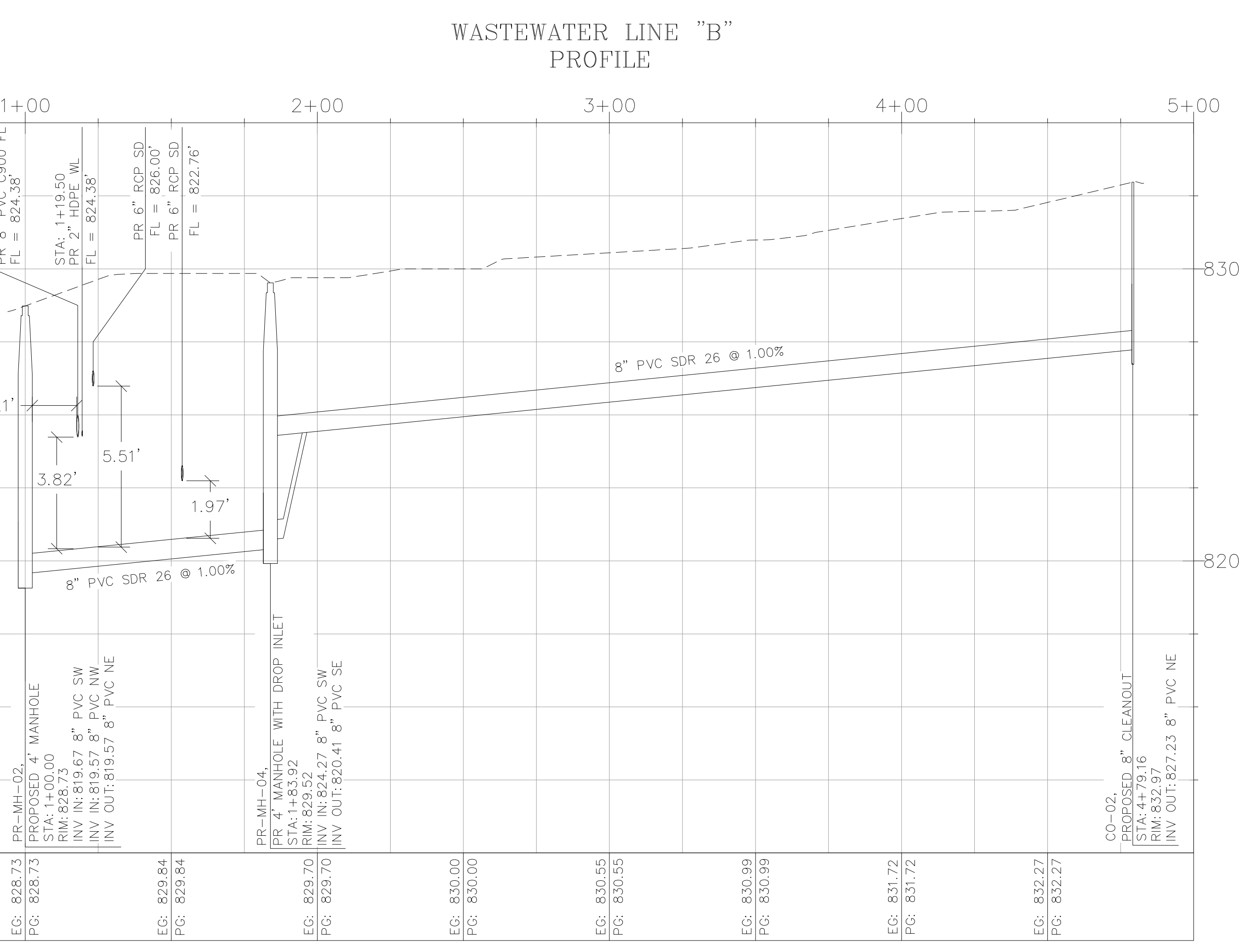
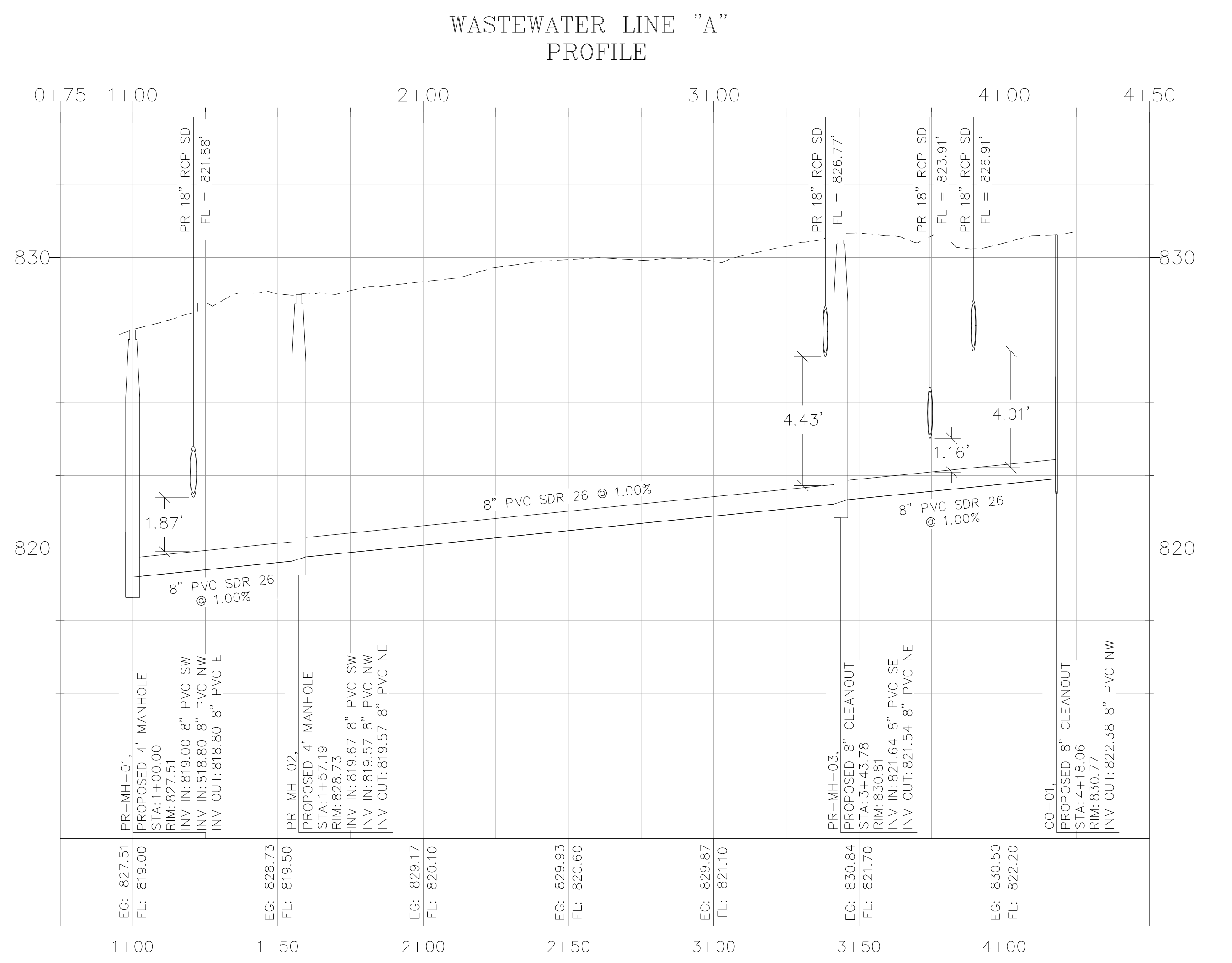
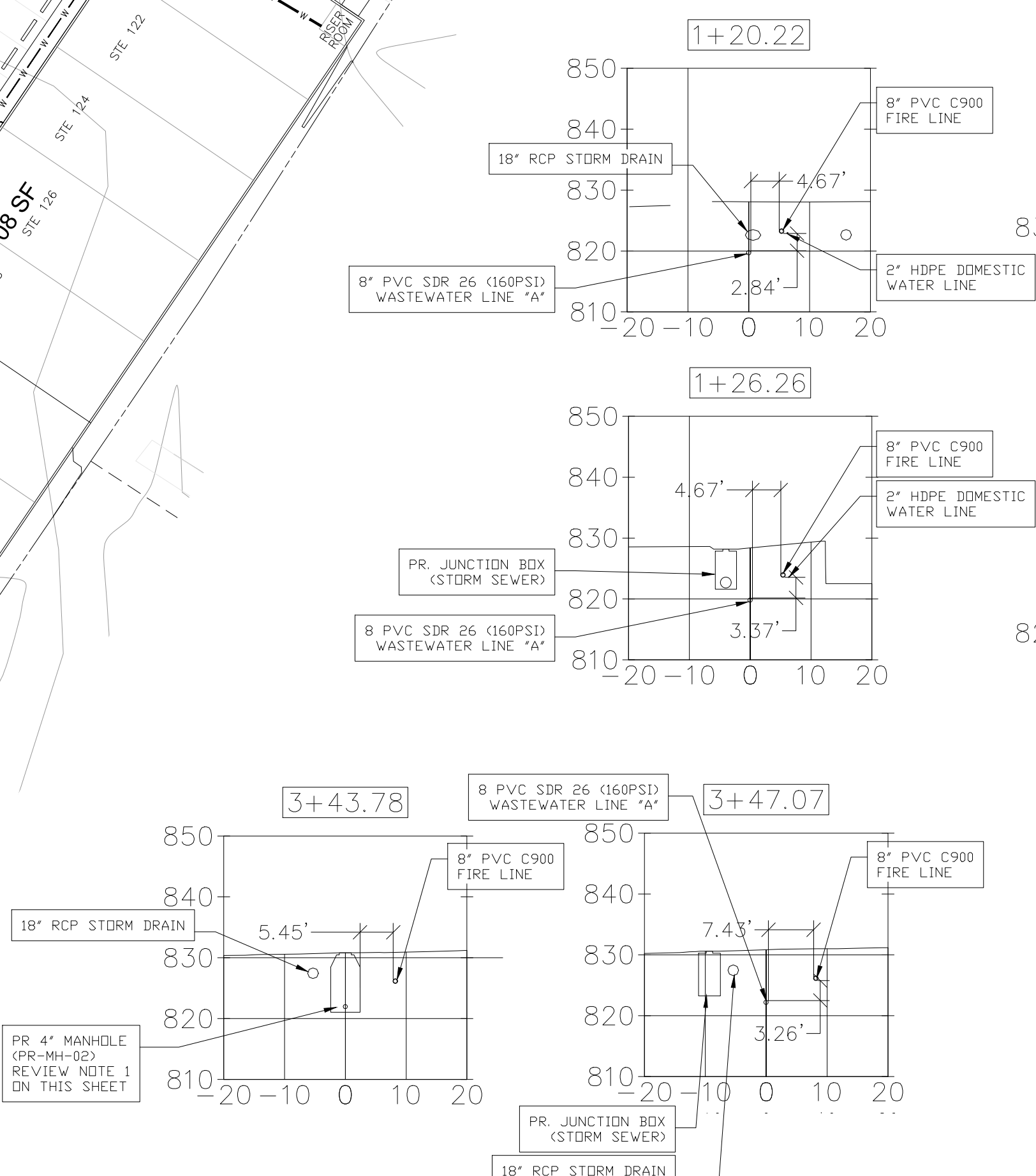
1. FOR MANHOLES WITHIN NINE FEET OF A WATER SUPPLY PIPE, THE MANHOLE MUST EITHER:

- HAVE NO MEASURABLE LEAKAGE DURING A LEAKAGE TEST CONDUCTED ACCORDING TO THE REQUIREMENTS IN 8217.58 OF THIS TITLE (RELATING TO TESTING REQUIREMENTS FOR MANHOLES); OR
- HAVE ALL PORTIONS OF THE MANHOLE WITHIN NINE FEET OF A WATER SUPPLY PIPE ENCASED IN AT LEAST ONE FOOT OF CEMENT STABILIZED SAND THAT MEETS THE REQUIREMENTS OF PARAGRAPHS (V)(1) AND (U) OF THIS SUBSECTION.

2. IF A COLLECTION SYSTEM PIPE IS LOCATED BELOW A WATER SUPPLY PIPE AND RUNS PARALLEL TO THE WATER SUPPLY PIPE, EACH PORTION OF THE COLLECTION SYSTEM PIPE WITHIN NINE FEET OF THE WATER SUPPLY PIPE MUST EITHER BE CONSTRUCTED USING AT LEAST 150 PSI PRESSURE CLASS PIPE ACCORDING TO SUBPARAGRAPH (A) OF THIS PARAGRAPH, OR MUST BE ENCASED IN A CASING PIPE ACCORDING TO SUBPARAGRAPH (B) OF THIS PARAGRAPH.

- A COLLECTION SYSTEM PIPE THAT RUNS PARALLEL TO AND BELOW A WATER SUPPLY PIPE MUST BE CONSTRUCTED OF AT LEAST 150 PSI PRESSURE CLASS, CORROSION-RESISTANT, NON-BRITTLE PIPE THAT:
 - IS LOCATED AT LEAST TWO VERTICAL FEET BELOW THE WATER SUPPLY PIPE;
 - IS LOCATED AT LEAST FOUR HORIZONTAL FEET AWAY FROM THE WATER SUPPLY PIPE; AND
 - INCLUDES JOINTS THAT ARE DESIGNED TO SEAL AT ATMOSPHERIC PRESSURE.
- A COLLECTION SYSTEM PIPE THAT RUNS PARALLEL TO AND BELOW A WATER SUPPLY PIPE MUST BE CONSTRUCTED OF AT LEAST 150 PSI PRESSURE CLASS, CORROSION-RESISTANT, NON-BRITTLE PIPE THAT:
 - IS LOCATED AT LEAST TWO VERTICAL FEET BELOW THE WATER SUPPLY PIPE;
 - IS LOCATED AT LEAST FOUR HORIZONTAL FEET AWAY FROM THE WATER SUPPLY PIPE; AND
 - INCLUDES JOINTS THAT ARE DESIGNED TO SEAL AT ATMOSPHERIC PRESSURE.

3. SEE TEXAS COMMISSION ON ENVIRONMENTAL QUALITY ORGANIZED SEWAGE COLLECTION SYSTEM GENERAL CONSTRUCTION NOTES ON SHEET 17.



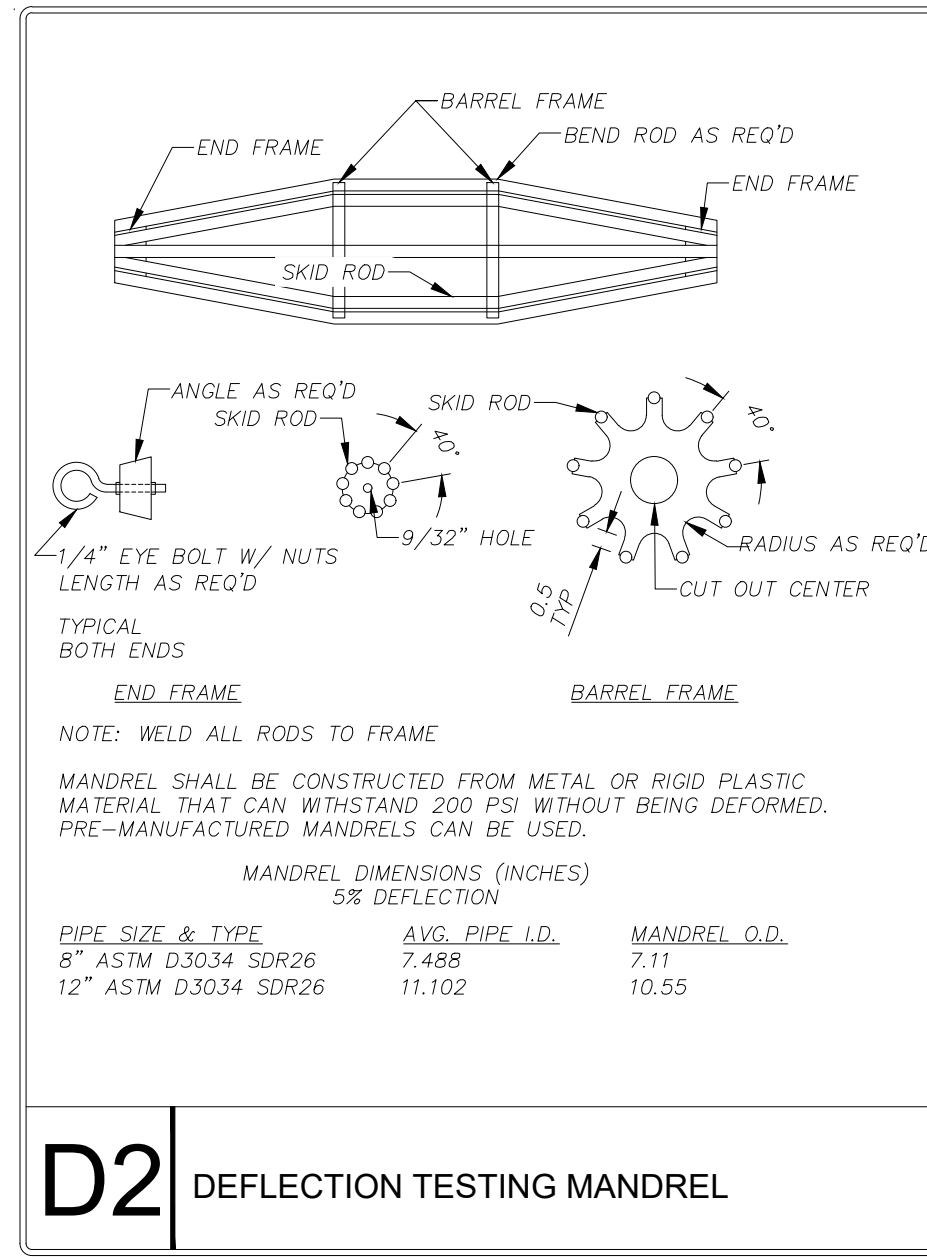
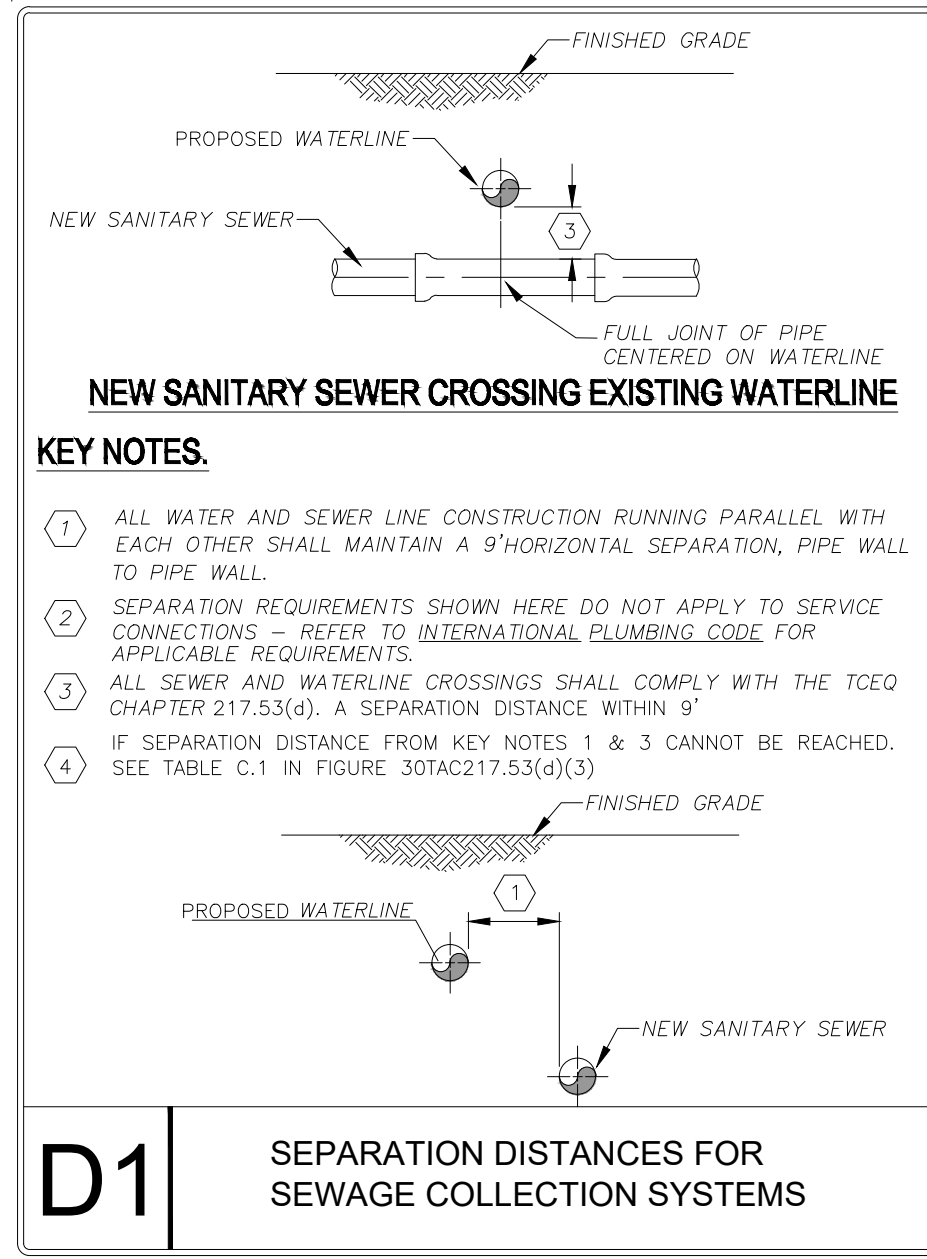
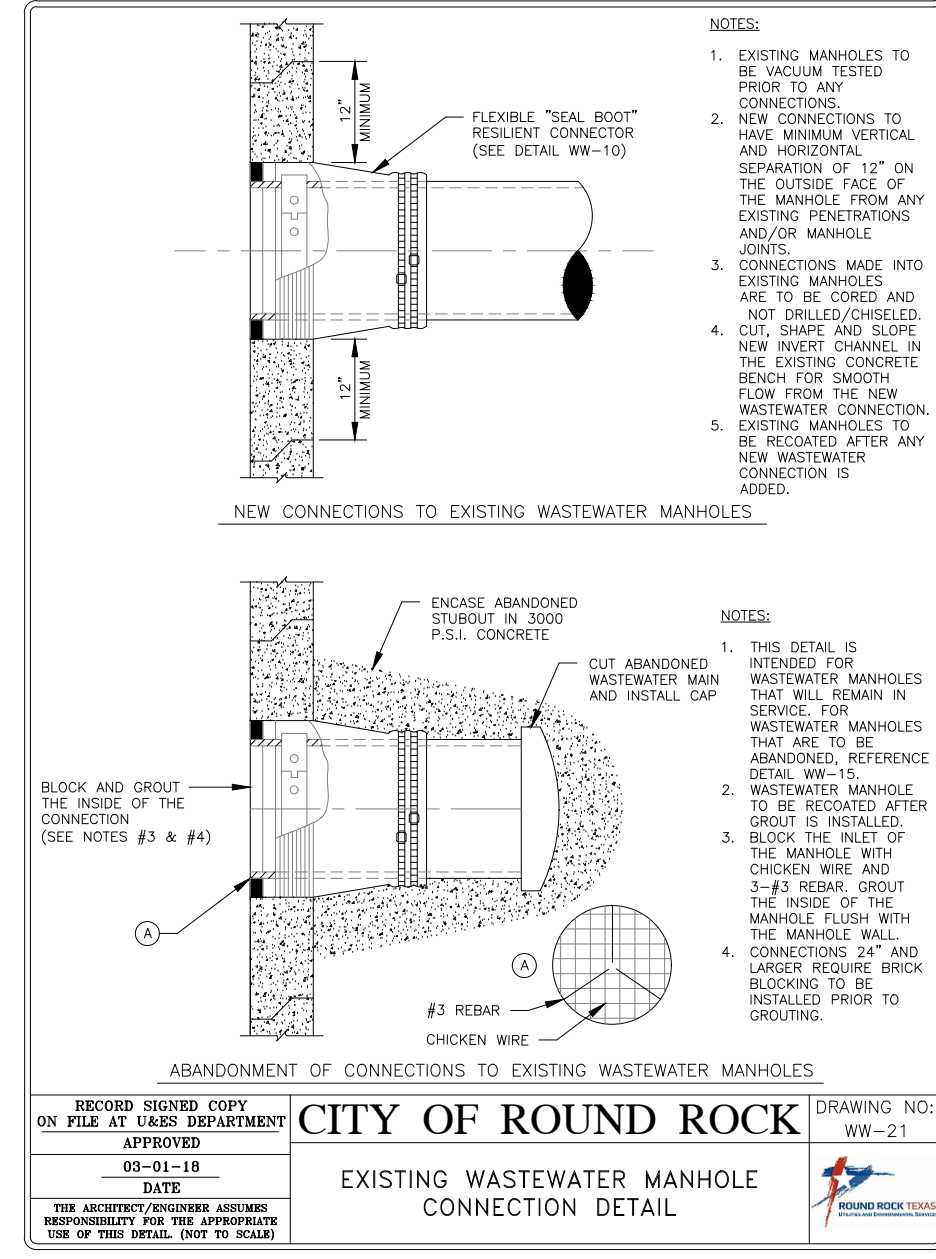
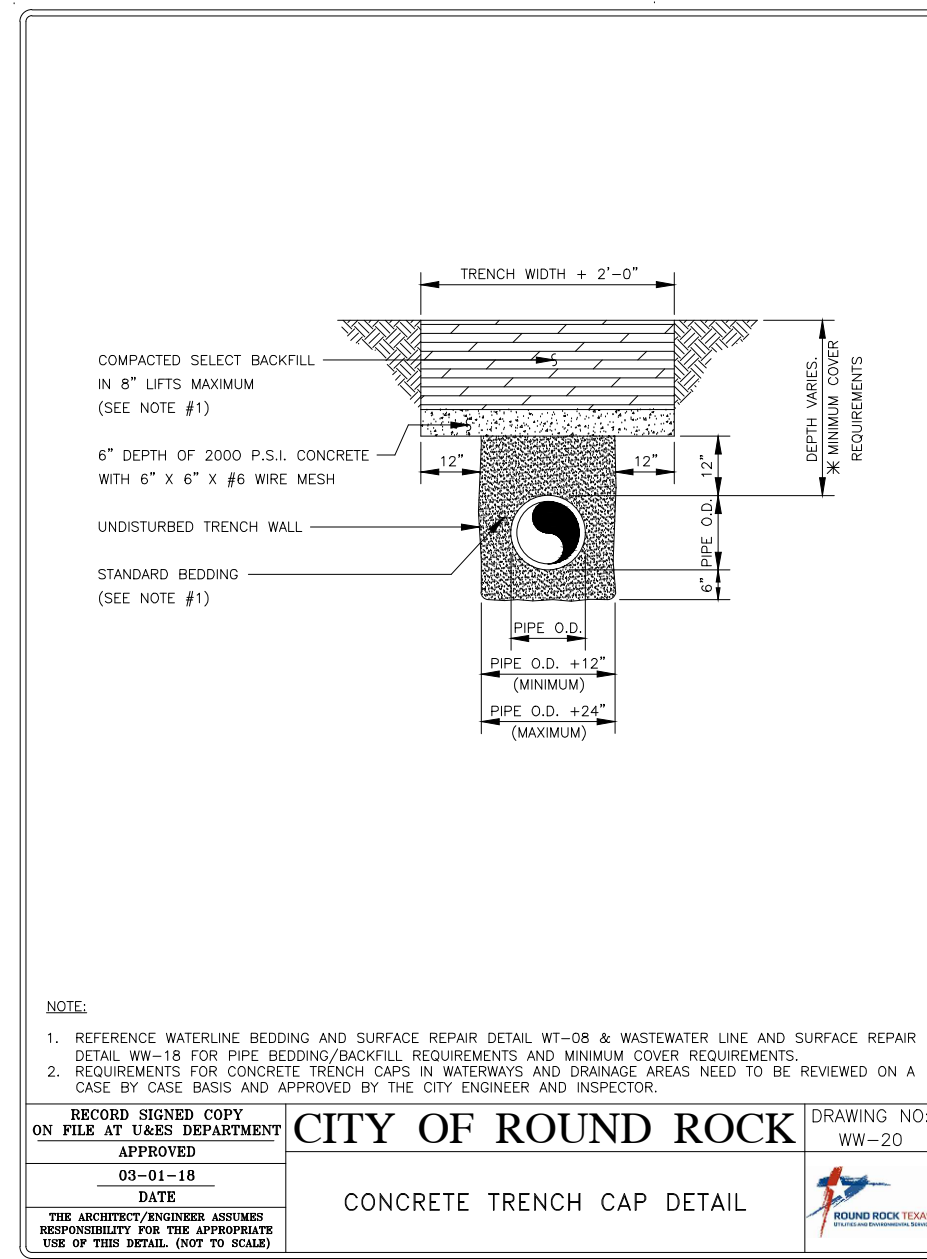
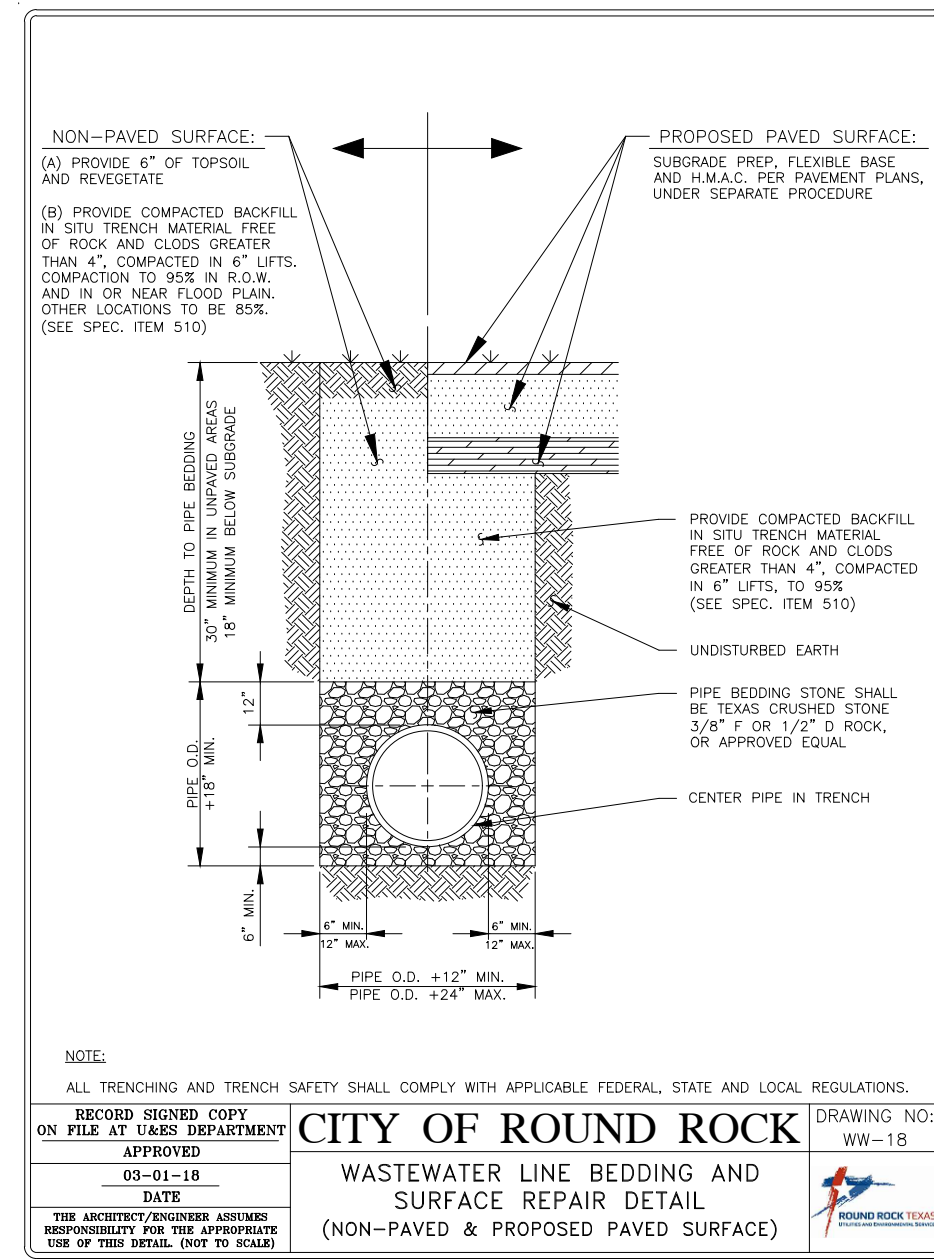
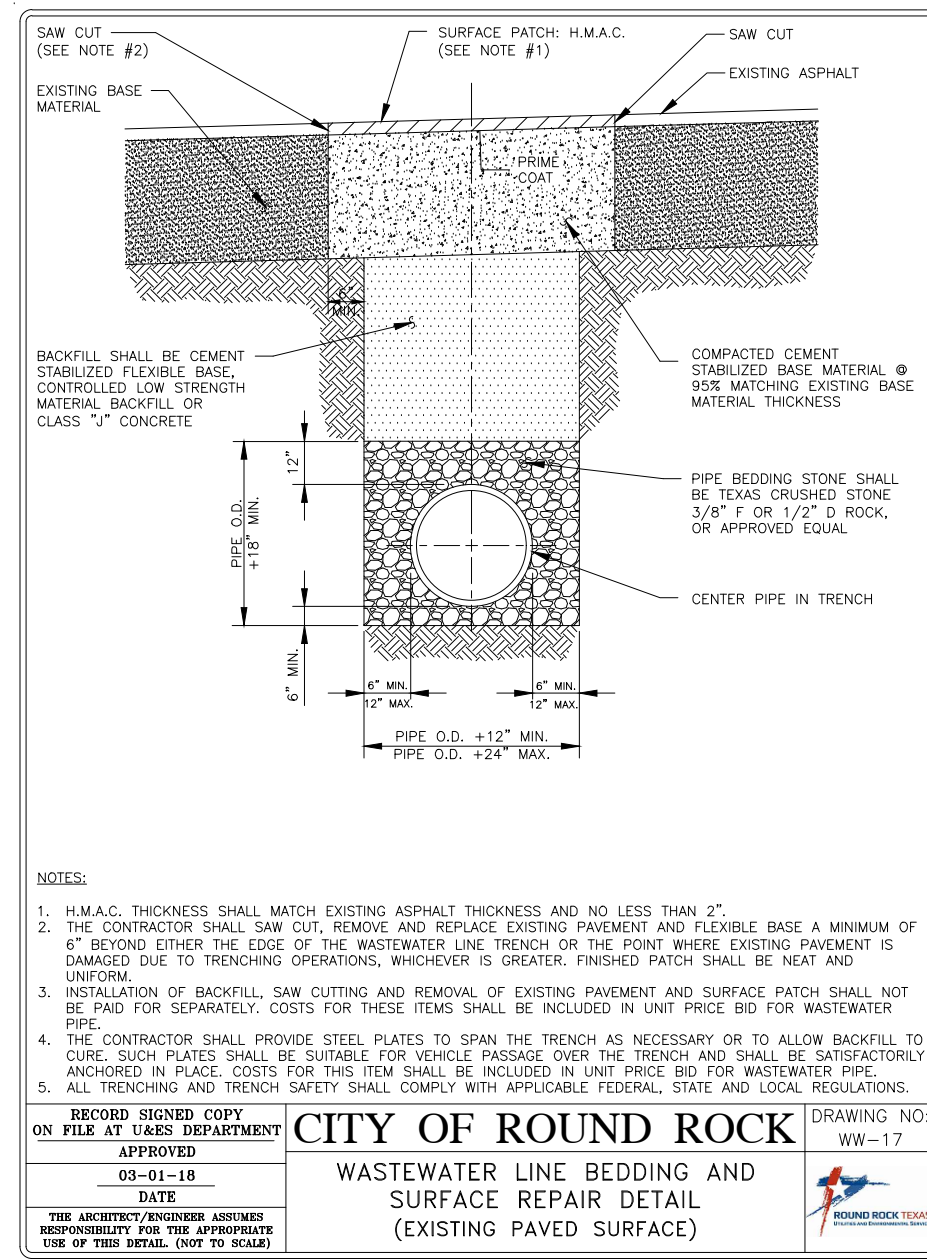
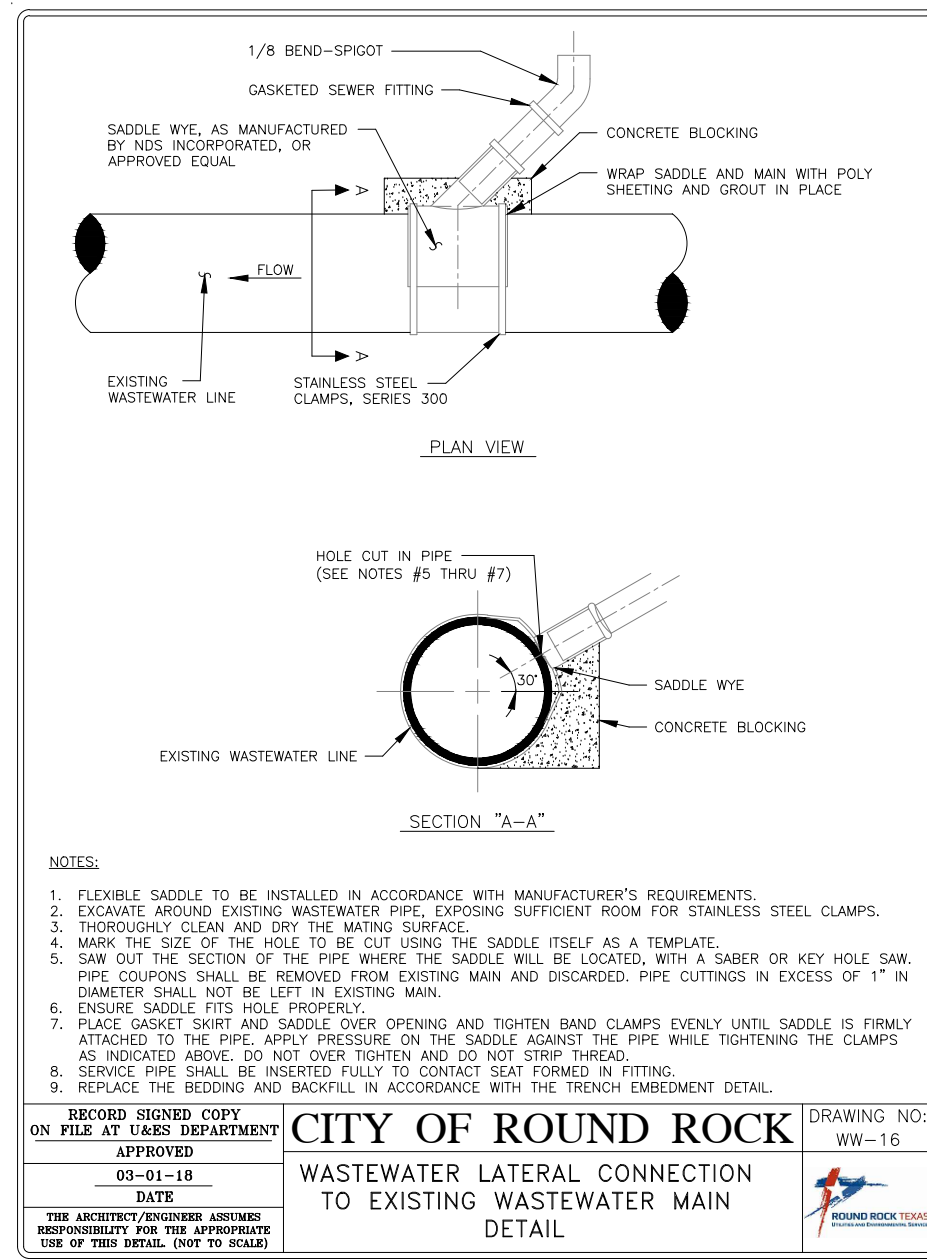
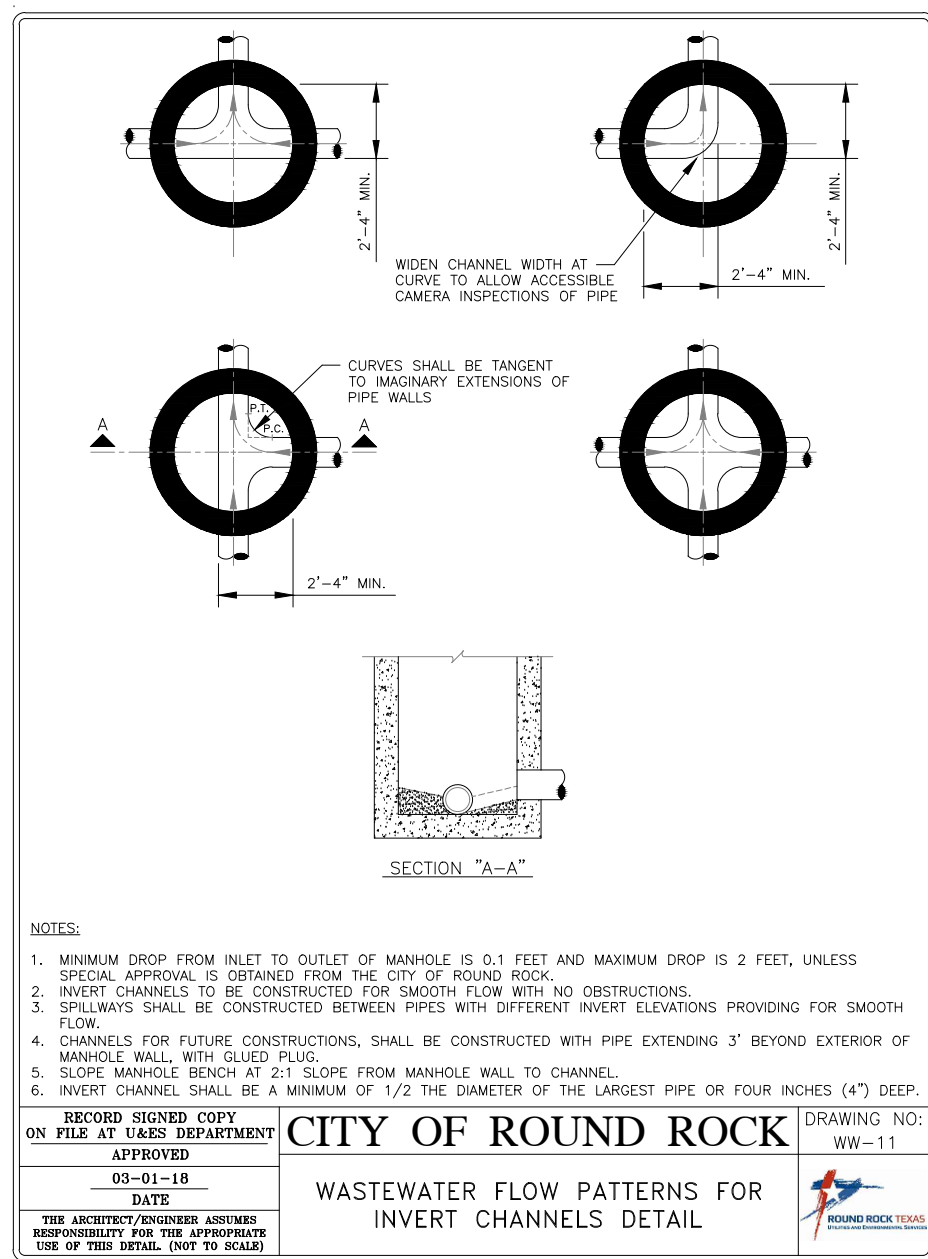
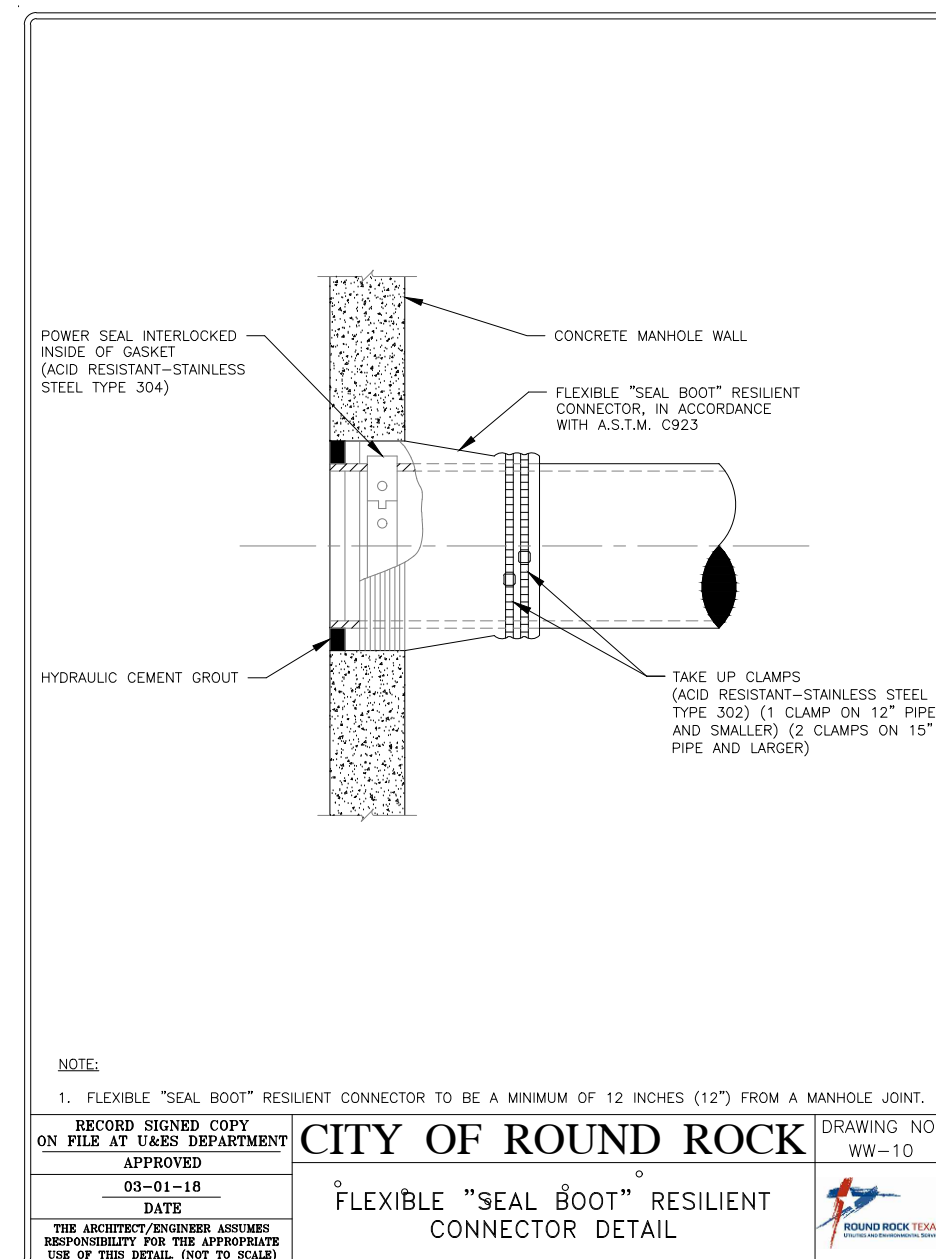
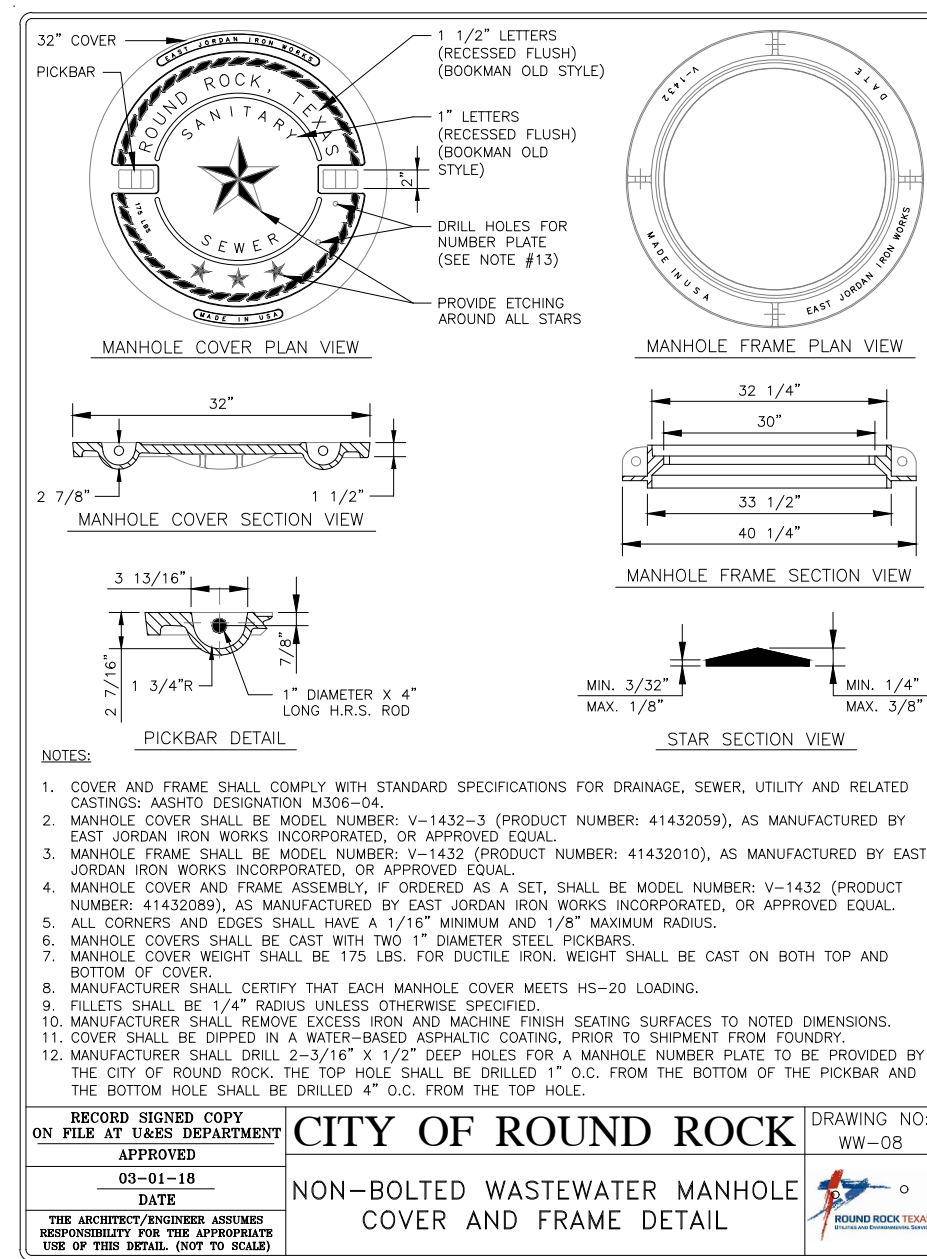
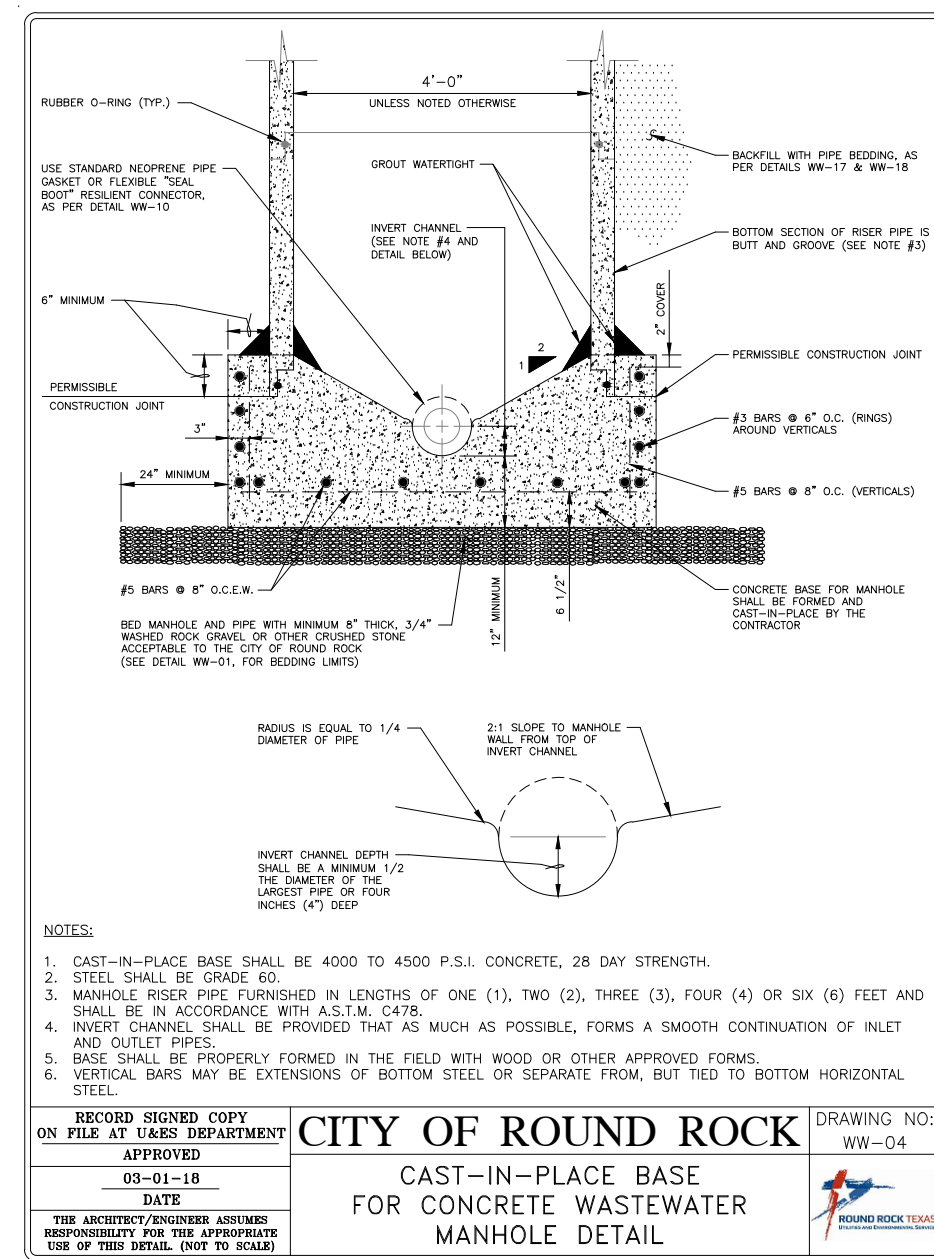
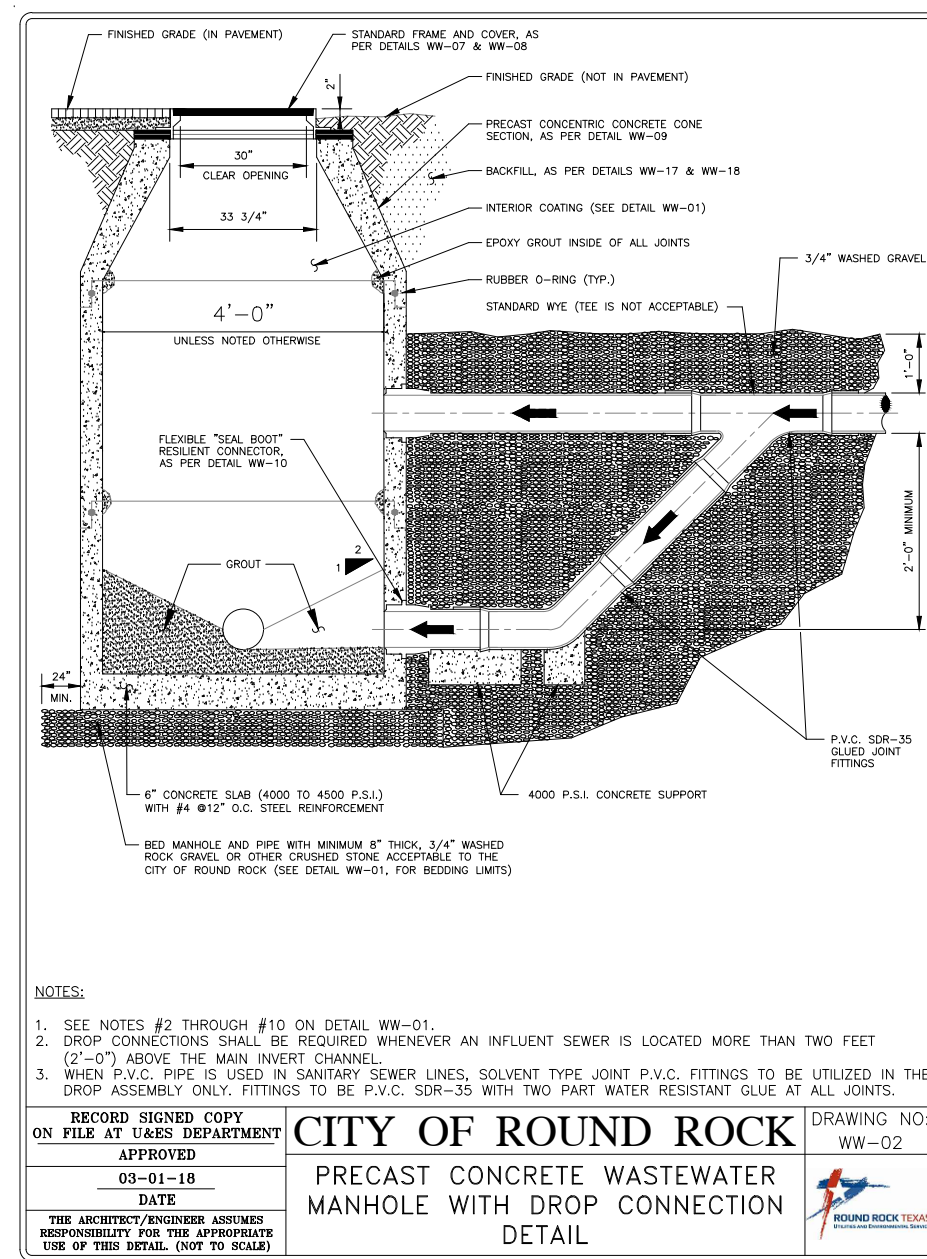
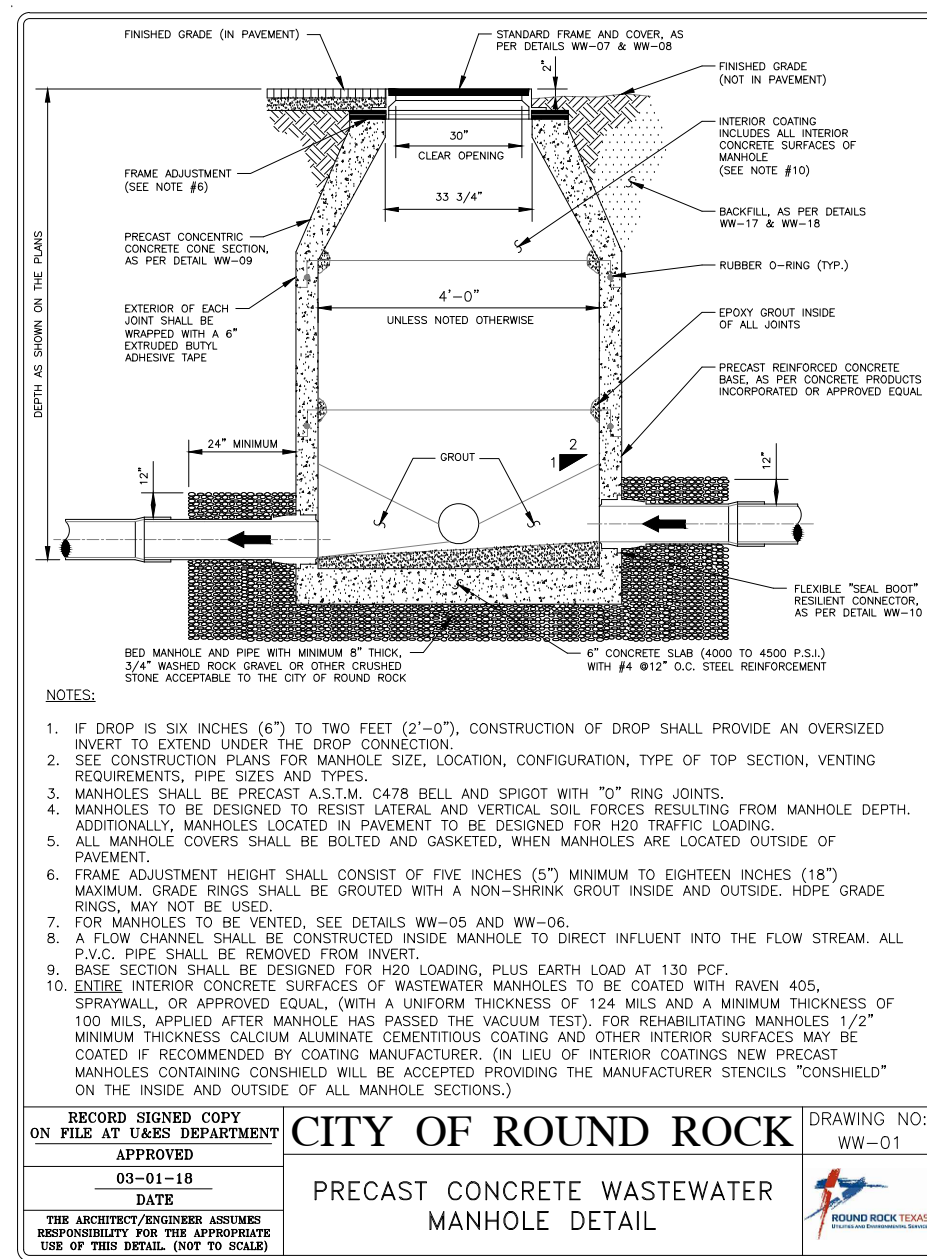
REVISIONS / CORRECTIONS

NO.	DESCRIPTION

02/29/2024

GREAT OAKS DR.
15917 GREAT OAKS DRIVE
WATER PLAN

SHEET:
13
OF 17



REVISIONS / CORRECTIONS

NO. DESCRIPTION

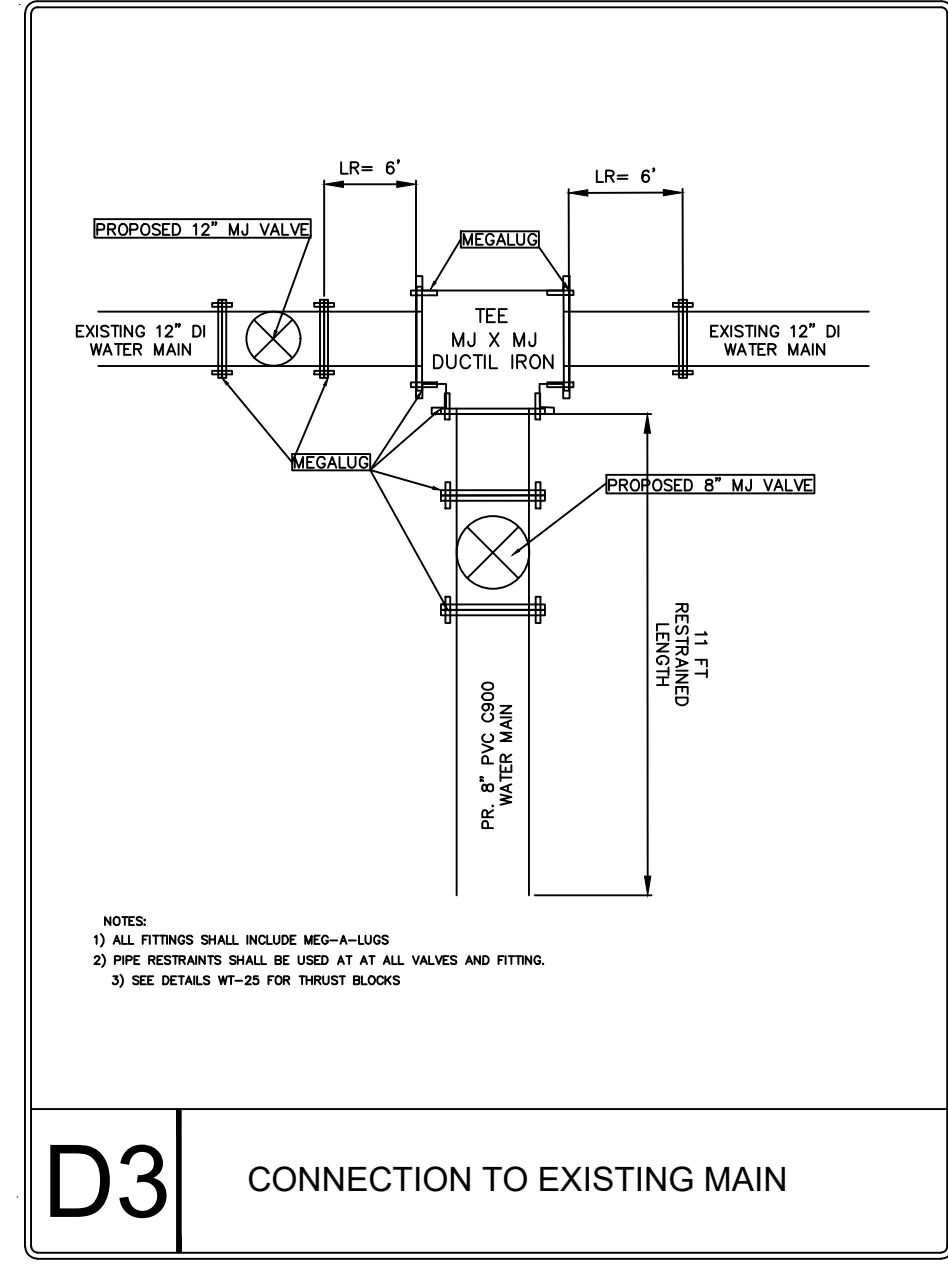
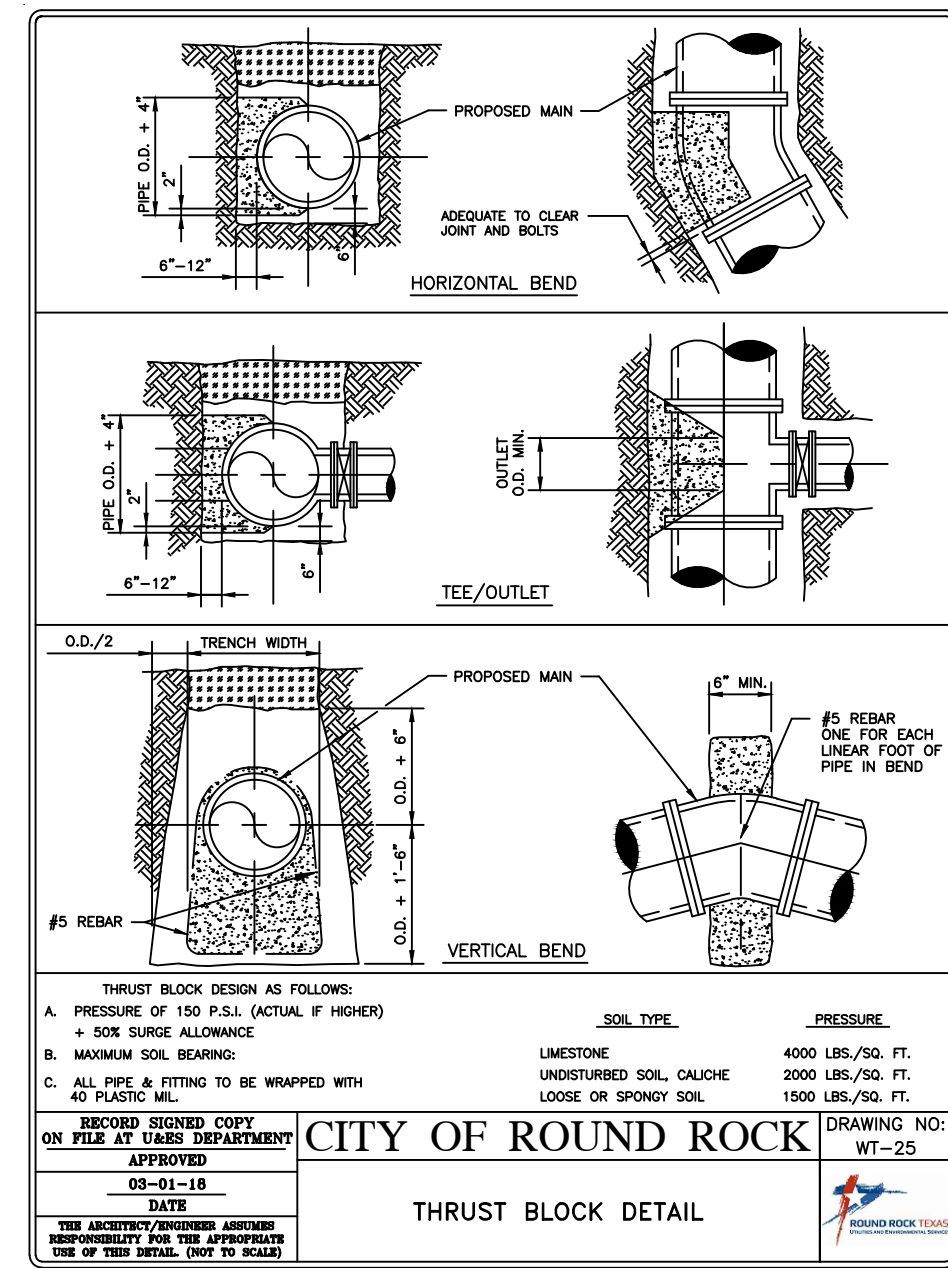
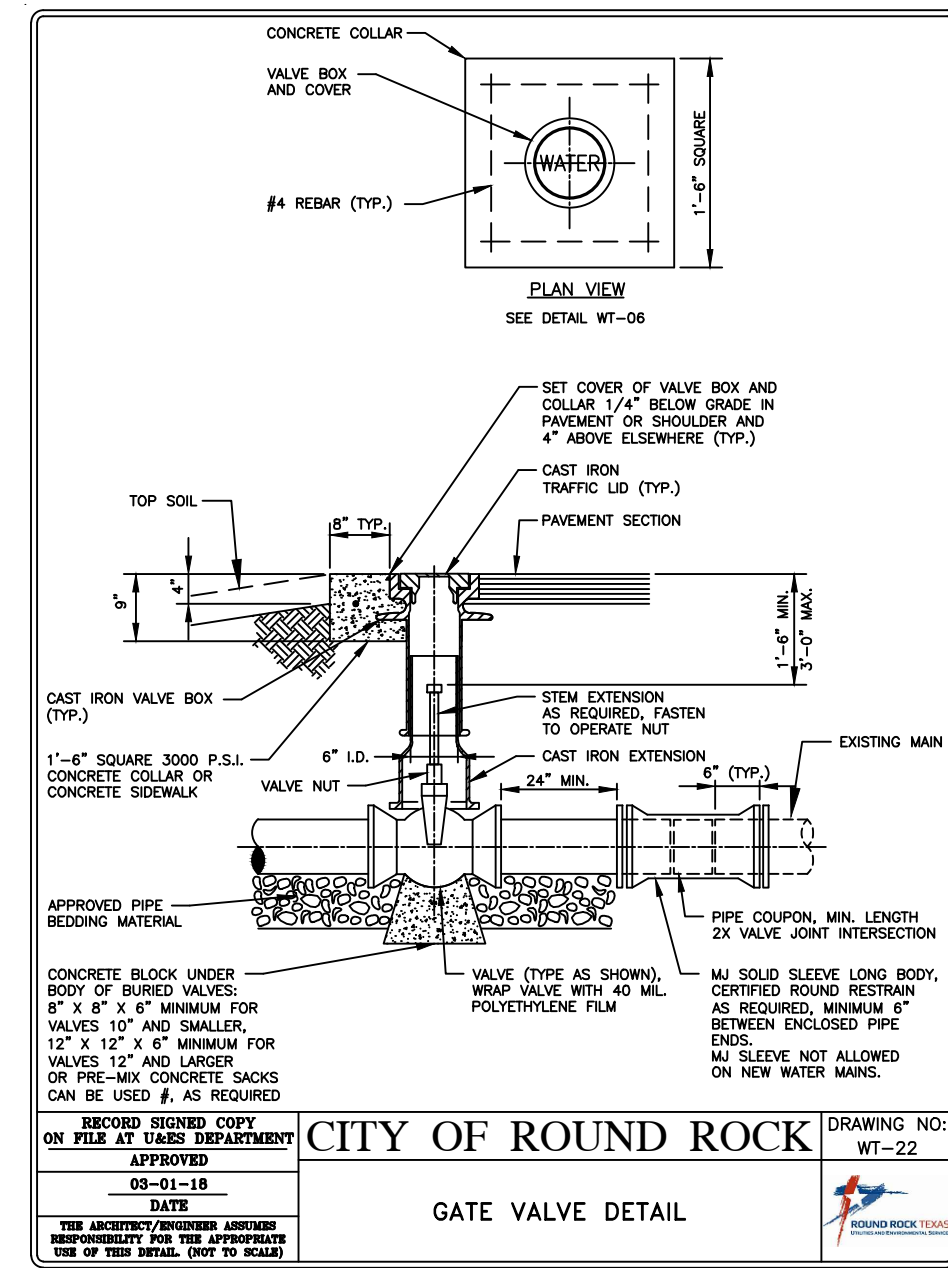
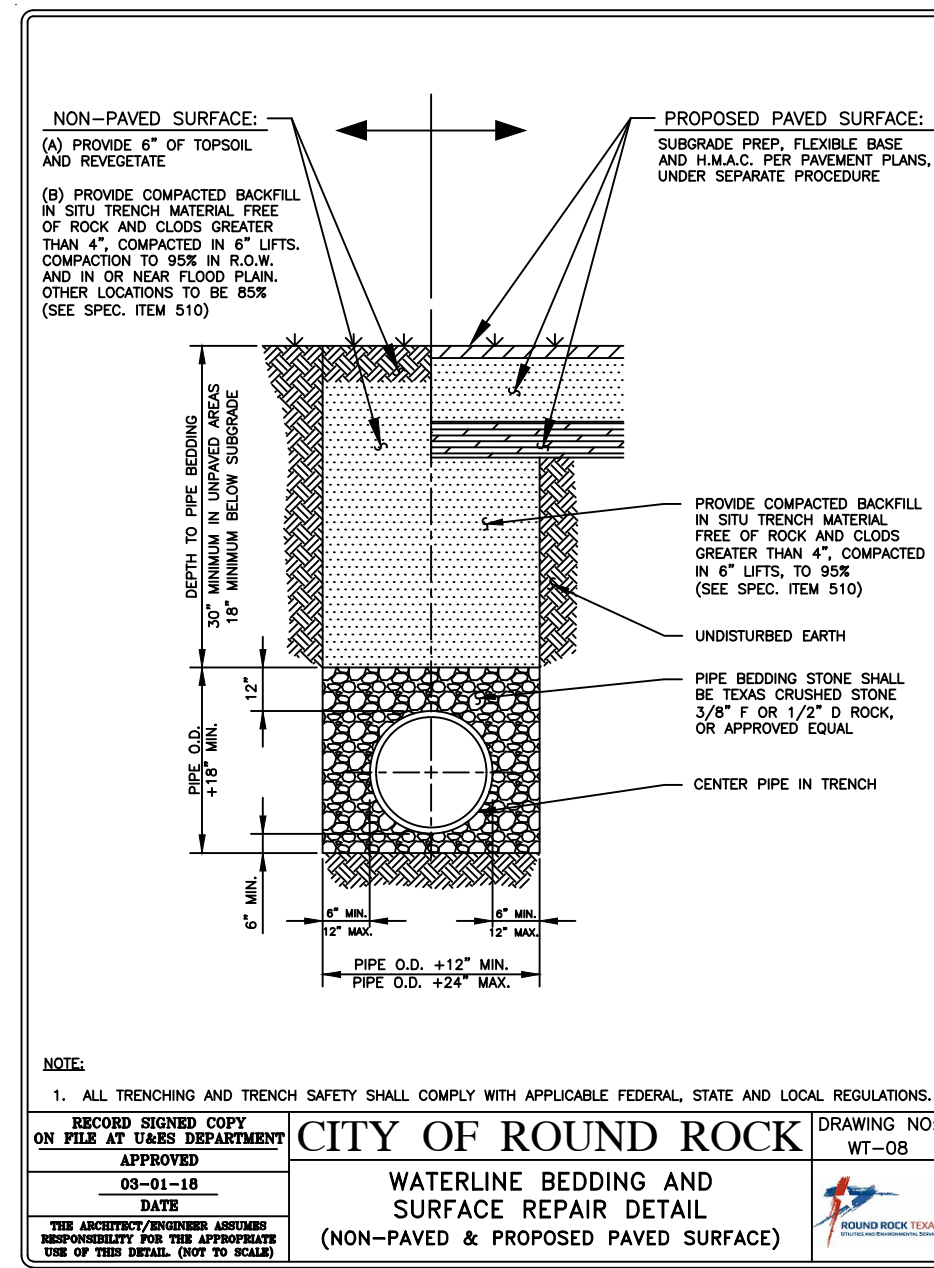
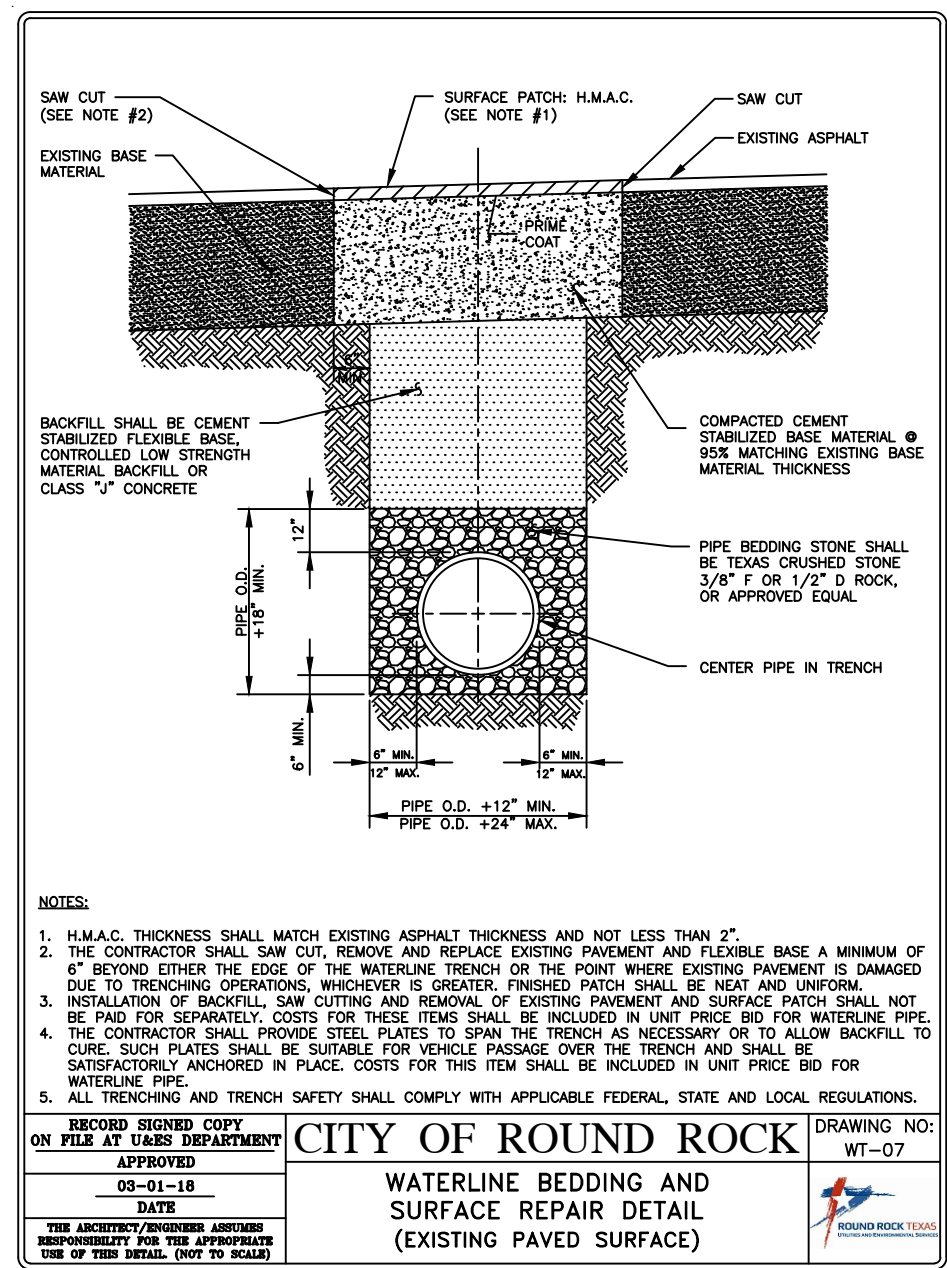
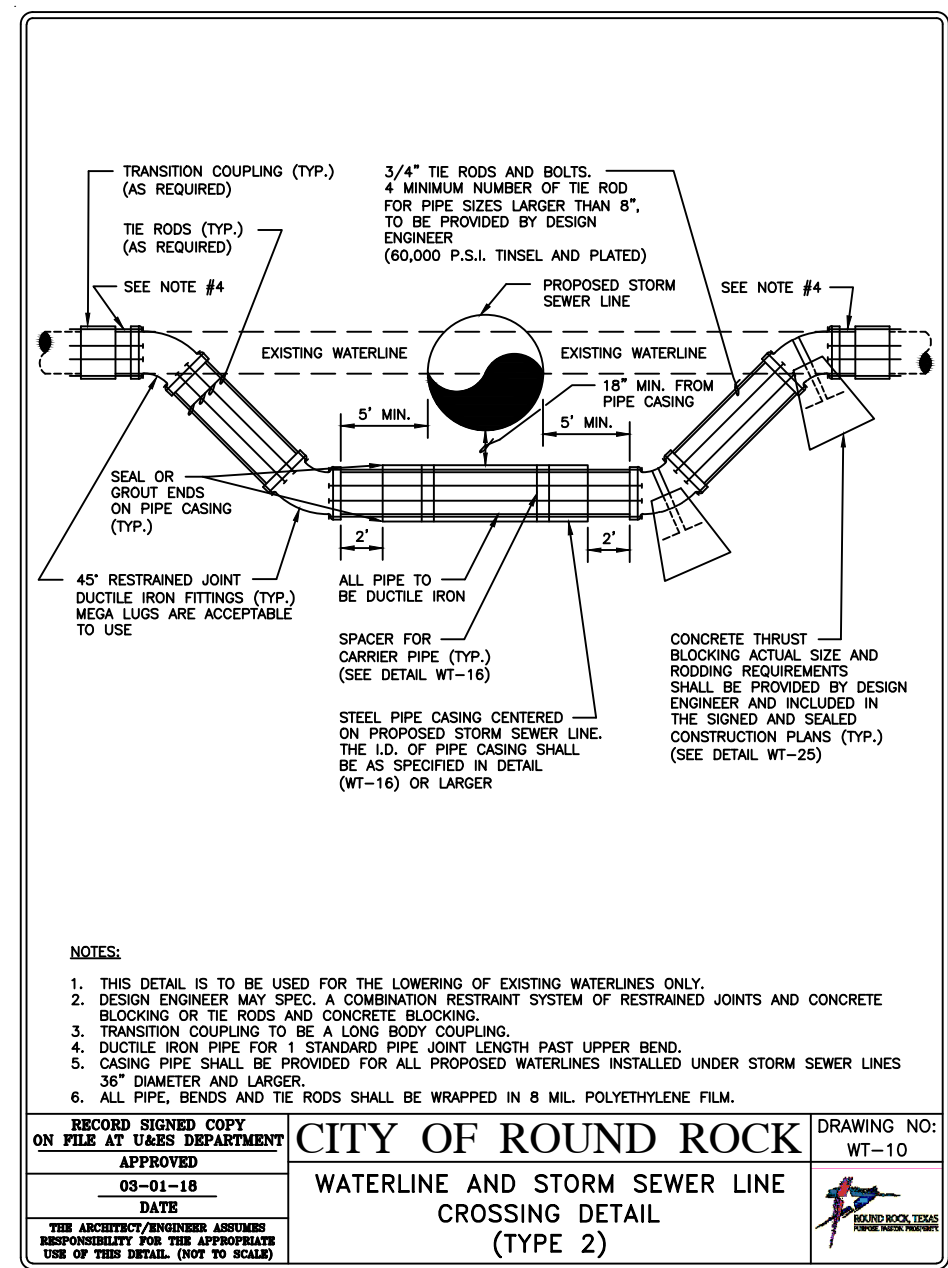
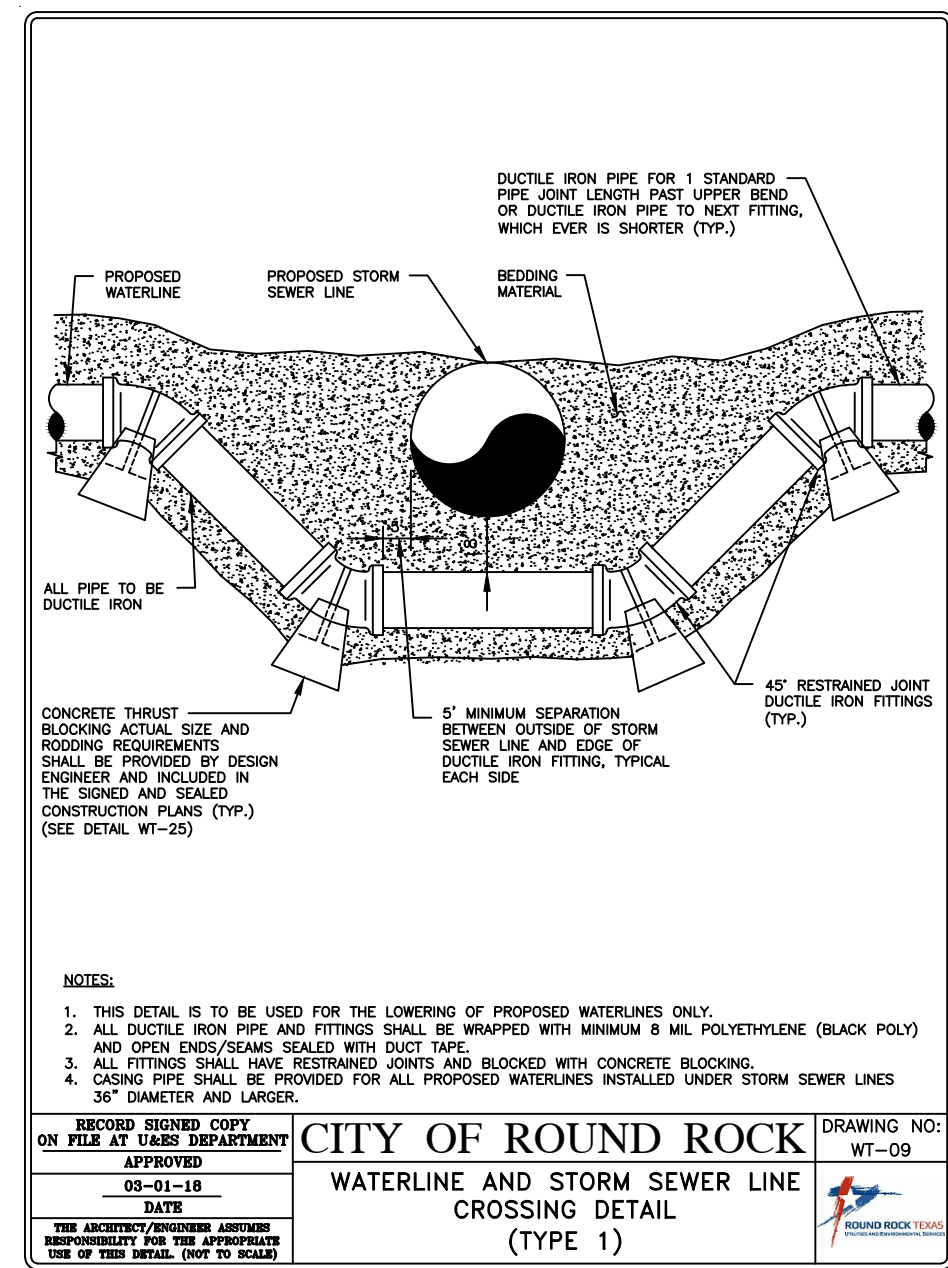
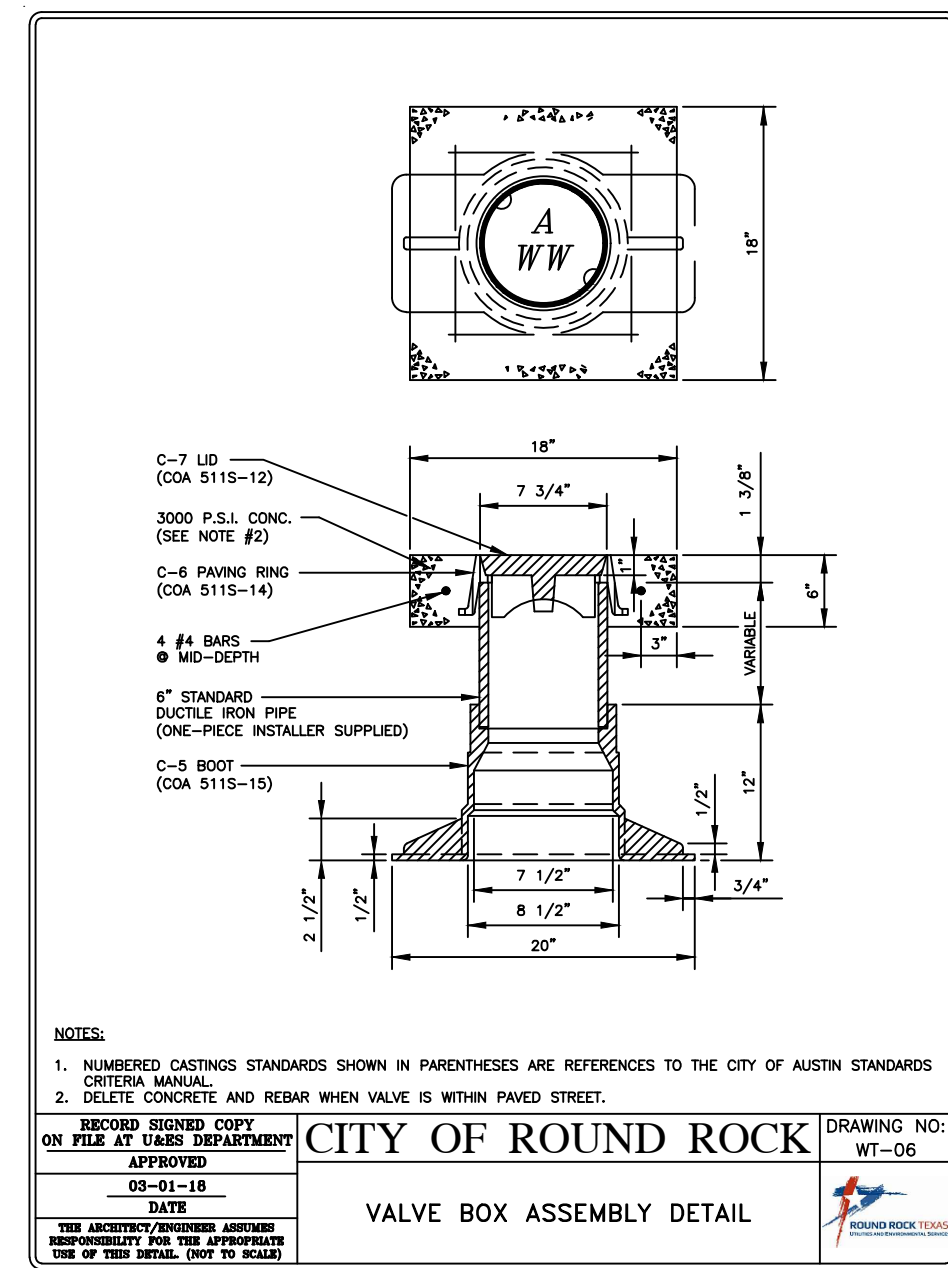
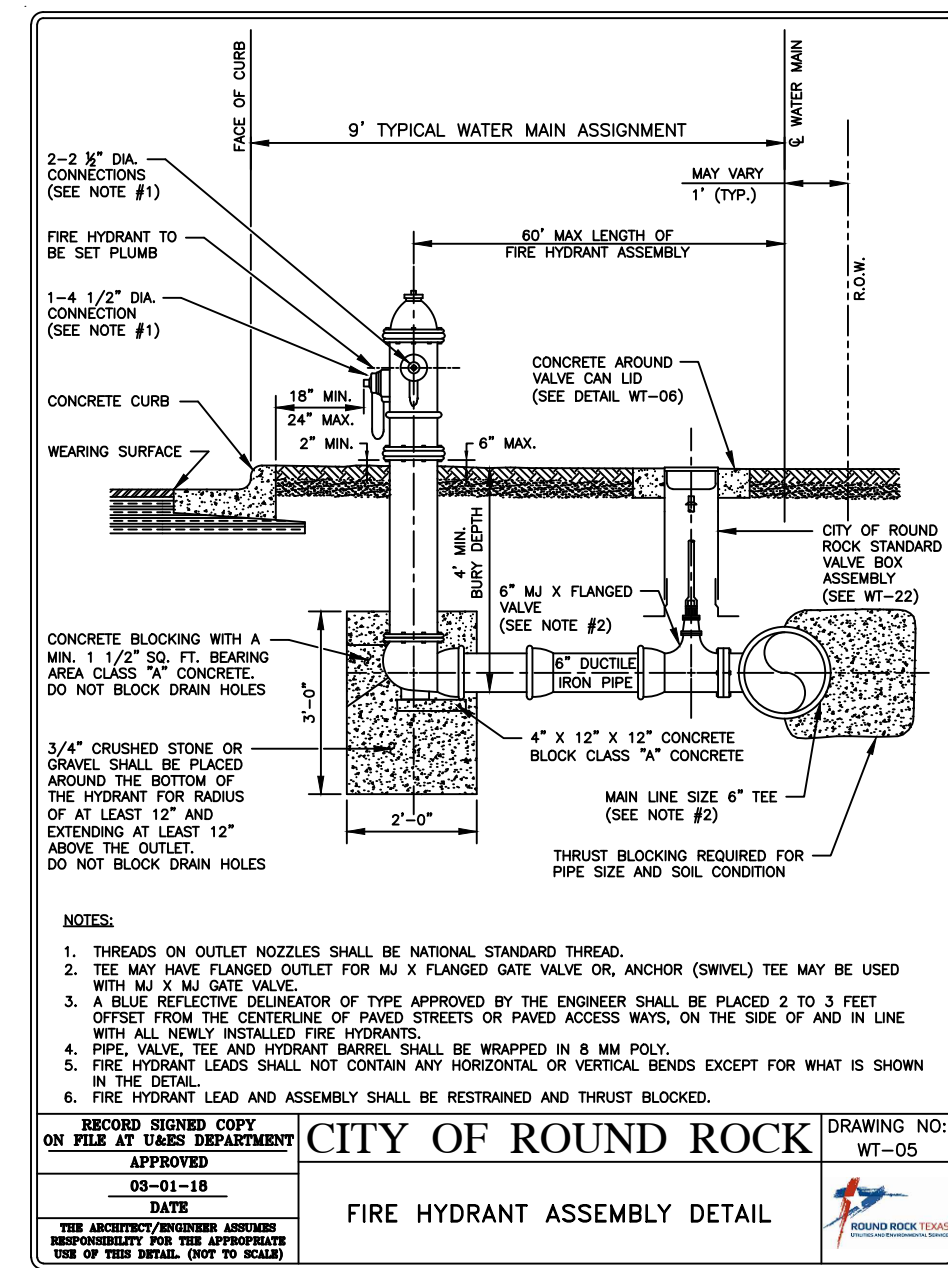
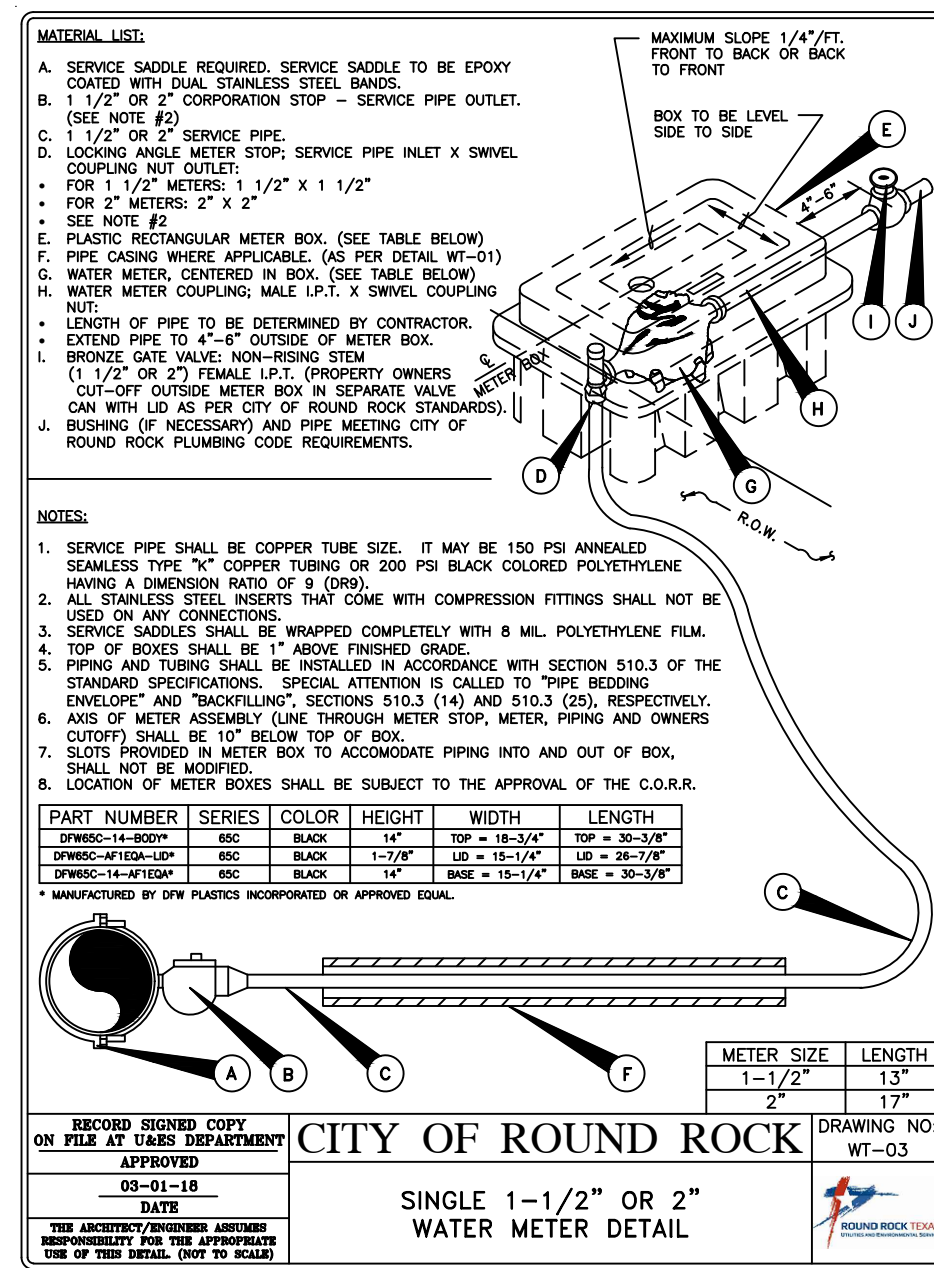
NO. DESCRIPTION



GREAT OAKS DR.
 15917 GREAT OAKS DRIVE
 UTILITY DETAILS I



SHEET: 14 OF 17



Project Name: Great Oaks

Project Notes:

EBA&I IRON

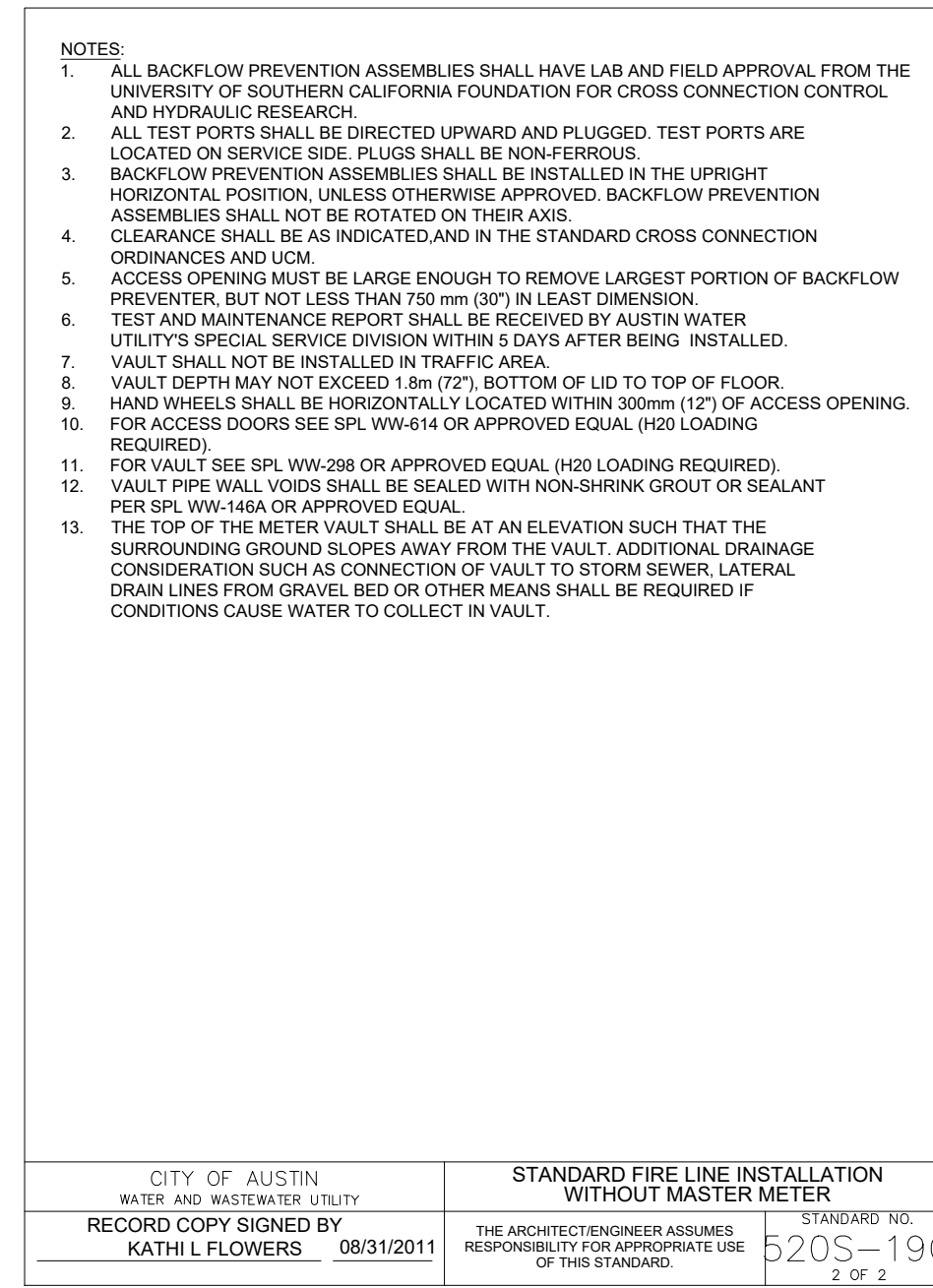
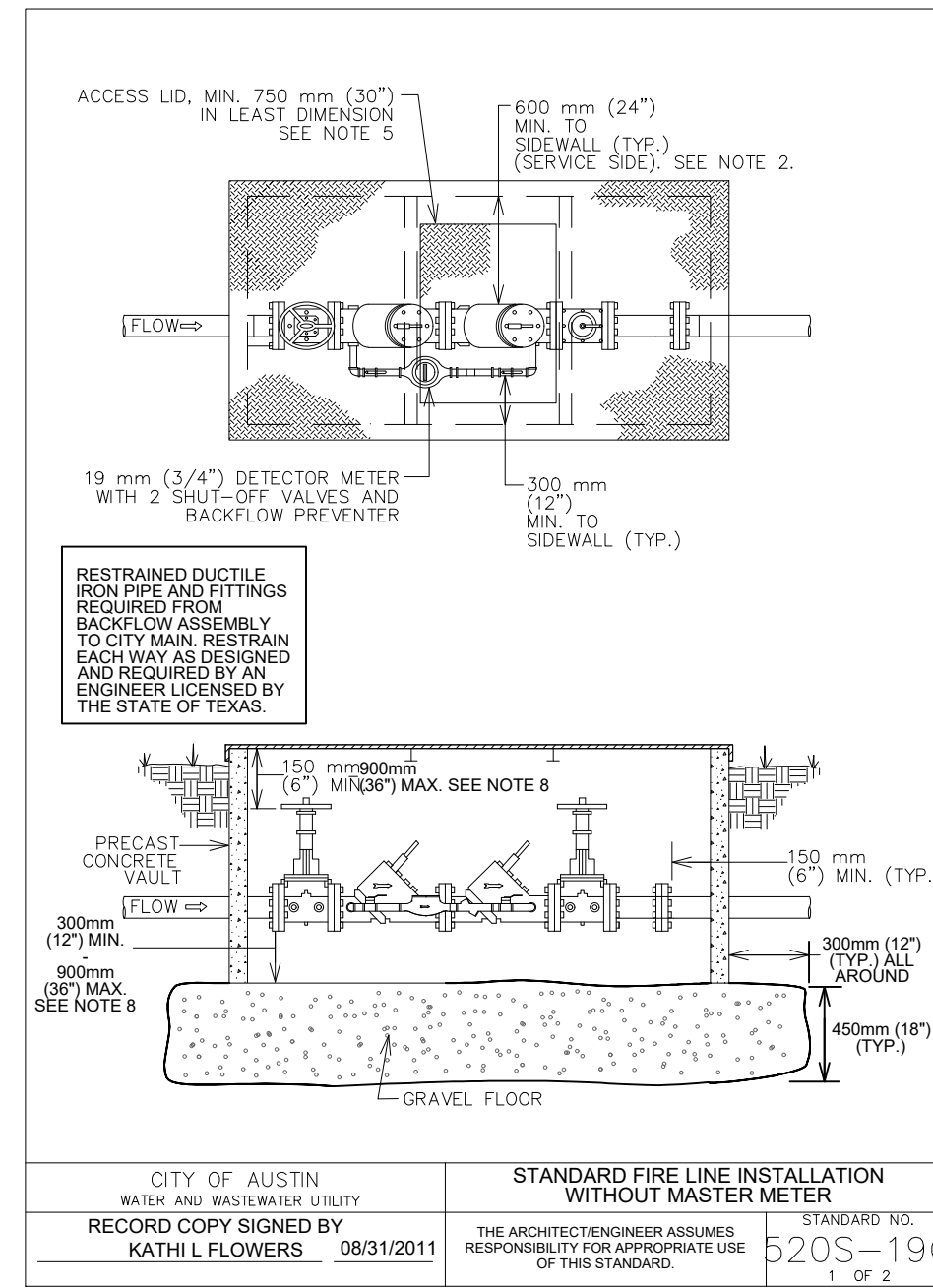
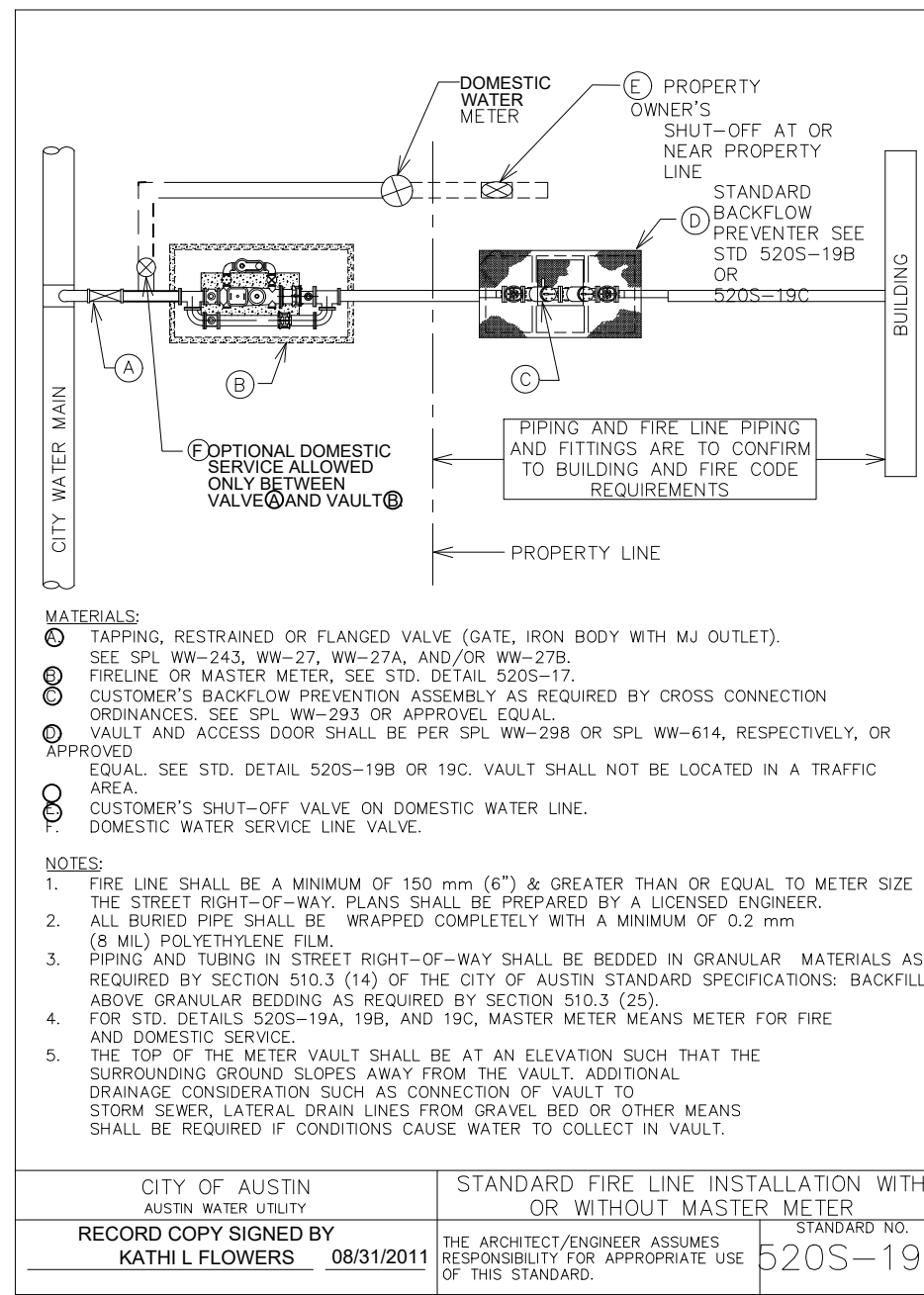
RESTRAINT LENGTH VALUES

Fitting Type	Pipe Material	Soil Type	Safety Factor	Trench Type	Depth of Bury	Test Pressure	Nominal Size	Bend Angle	Branch Size	Length Along Run	Reduced Size	Lowside Depth	Restraint Length 1	Restraint Length 2
Tee	PVC	CL	1.5	5	4 FT	200 PSI	12 in.		8 in.	6 FT			11 FT	

Site Name:

Site Notes:

MEGALUG



WATER FLOW TEST REPORT

HYDRANT #

LOCATION: 15917 Great Oaks

DATE: 08/31/2011

TEST BY: Sam Bane P.E.

FLOW HYDRANT(S)	COEFFICIENT	PVTY READING	TOTAL FLOW DURING TEST	STATIC READING	RESULTS
Hydrant #1	0.8	2415	2415 GPM	35	AT 0 PSI
Hydrant #2					
Hydrant #3					

REMARKS:

Pressure vs. Flow Graph:

Pressure (psi) vs. Flow (gpm)

REVISIONS / CORRECTIONS

NO.	DESCRIPTION



GREAT OAKS DR.

15917 GREAT OAKS DRIVE

UTILITY DETAILS II

CIVIL DIVISION

LOC CONSULTANTS

SHEET:

15

OF 17

GENERAL NOTES
DESIGN AND CONSTRUCTION STANDARDS (GENERAL GUIDELINES
CITY OF ROUND ROCK)

- ALL CONSTRUCTION SHALL BE IN ACCORDANCE WITH THE CITY OF ROUND ROCK STANDARD SPECIFICATIONS MANUAL.
- ANY EXISTING UTILITIES, PAVEMENT, CURBS, SIDEWALKS, STRUCTURES, TREES, ETC., NOT PLANNED FOR DESTRUCTION OR REMOVAL THAT ARE DAMAGED OR REMOVED SHALL BE REPAIRED OR REPLACED AT HIS EXPENSE.
- THE CONTRACTOR SHALL VERIFY THE DEPTHS AND LOCATIONS OF EXISTING UTILITIES PRIOR TO ANY CONSTRUCTION. ANY DISCREPANCIES WITH THE CONSTRUCTION PLANS FOUND IN THE FIELD SHALL BE BROUGHT IMMEDIATELY TO THE ATTENTION OF THE ENGINEER WHO SHALL BE RESPONSIBLE FOR REVISING THE PLANS ARE APPROPRIATE.
- MANHOLE FRAMES, COVERS, VALVES, CLEANOUTS, ETC. SHALL BE RAISED TO FINISHED GRADE PRIOR TO FINAL PAVING CONSTRUCTION.
- THE CONTRACTOR SHALL GIVE THE CITY OF ROUND ROCK 48 HOURS NOTICE BEFORE BEGINNING EACH PHASE OF CONSTRUCTION, TELEPHONE 218-5555 (ENGINEERING AND DEVELOPMENT SERVICES DEPARTMENT).
- ALL AREAS DISTURBED OR EXPOSED DURING CONSTRUCTION SHALL BE REVEGETATED IN ACCORDANCE WITH THE PLANS AND SPECIFICATIONS. RESTORATION OF ALL DISTURBED OR EXPOSED AREAS SHALL CONSIST OF SOODING OR SEEDING, AT THE CONTRACTOR'S OPTION, HOWEVER, THE TYPE OF REVEGETATION MUST EQUAL OR EXCEED THE TYPE OF VEGETATION PRESENT BEFORE CONSTRUCTION.
- PRIOR TO ANY CONSTRUCTION, THE ENGINEER SHALL CONVENE A PRECONSTRUCTION CONFERENCE BETWEEN THE CITY OF ROUND ROCK, HIMSELF, THE CONTRACTOR, OTHER UTILITY COMPANIES, ANY AFFECTED PARTIES AND ANY OTHER ENTITY THE CITY OR ENGINEER MAY REQUIRE.
- THE CONTRACTOR AND THE ENGINEER SHALL KEEP ACCURATE RECORDS OF ALL CONSTRUCTION THAT DEVIATES FROM THE PLANS. THE ENGINEER SHALL FURNISH THE CITY OF ROUND ROCK ACCURATE "AS-BUILT" DRAWINGS FOLLOWING COMPLETION OF ALL CONSTRUCTION. THESE "AS-BUILT" DRAWINGS SHALL MEET WITH THE SATISFACTION OF THE ENGINEERING AND DEVELOPMENT SERVICES DEPARTMENT PRIOR TO FINAL ACCEPTANCE.
- THE ROUND ROCK CITY COUNCIL SHALL NOT BE PETITIONED FOR ACCEPTANCE UNTIL ALL NECESSARY EASEMENT DOCUMENTS HAVE BEEN SIGNED AND RECORDED.
- WHEN CONSTRUCTION IS BEING CARRIED OUT WITHIN EASEMENTS, THE CONTRACTOR SHALL CONFINE HIS WORK TO WITHIN THE PERMANENT AND TEMPORARY BOUNDARIES. PRIOR TO FINAL ACCEPTANCE, THE CONTRACTOR SHALL BE RESPONSIBLE FOR REMOVING ALL TRASH AND DEBRIS WITHIN THE PERMANENT AND TEMPORARY EASEMENTS. CLEAN-UP SHALL BE TO THE SATISFACTION OF THE CITY ENGINEER.
- PRIOR TO ANY CONSTRUCTION, THE CONTRACTOR SHALL APPLY FOR AND SECURE ALL PROPER PERMITS FROM THE APPROPRIATE AUTHORITIES.
- AVAILABLE BENCHMARKS (CITY OF ROUND ROCK DATUM) THAT MAY BE UTILIZED FOR THE CONSTRUCTION OF THIS PROJECT ARE DESCRIBED AS FOLLOWS:

TRENCH SAFETY NOTES:
DESIGN AND CONSTRUCTION STANDARDS (GENERAL GUIDELINES
CITY OF ROUND ROCK)

- IN ACCORDANCE WITH THE LAWS OF THE STATE OF TEXAS AND THE U. S. OCCUPATIONAL SAFETY AND HEALTH ADMINISTRATION REGULATIONS, ALL TRENCHES OVER 5 FEET IN DEPTH IN EITHER HARD AND COMPACT OR SOFT AND UNSTABLE SOIL SHALL BE SLOPED, SHORED, SHEETED, BRACED OR OTHERWISE SUPPORTED. FURTHERMORE, ALL TRENCHES LESS THAN 5 FEET IN DEPTH SHALL ALSO BE EFFECTIVELY PROTECTED WHEN HAZARDOUS GROUND MOVEMENT MAY BE EXPECTED. TRENCH SAFETY SYSTEMS TO BE UTILIZED FOR THIS PROJECT (WHICH WILL BE PROVIDED BY THE CONTRACTOR, ARE ON SHEET 1/A, ETC.).
- IN ACCORDANCE WITH THE OCCUPATIONAL SAFETY AND HEALTH ADMINISTRATION REGULATIONS, WHEN PERSONS ARE IN TRENCHES 4-FEET DEEP OR MORE, ADEQUATE MEANS OF EXIT, SUCH AS A LADDER OR STEPS, MUST BE PROVIDED AND LOCATED 50 FT AS TO REMOVE NO MORE THAN 25 FEET OF LATERAL TRAVEL.
- IF TRENCH SAFETY SYSTEM DETAILS WERE NOT PROVIDED IN THE PLANS BECAUSE TRENCHES WERE ANTICIPATED TO BE LESS THAN 5 FEET IN DEPTH AND DURING CONSTRUCTION IT IS FOUND THAT TRENCHES ARE IN FACT 5 FEET OR MORE IN DEPTH OR TRENCHES LESS THAN 5 FEET DEEP ARE BEING DEEPENED IN AN AREA WHERE HAZARDOUS GROUND MOVEMENT IS EXPECTED, ALL CONSTRUCTION SHALL CEASE, THE TRENCHED AREA SHALL BE BARRICADED AND THE ENGINEER NOTIFIED IMMEDIATELY. CONSTRUCTION SHALL NOT RESUME UNTIL APPROPRIATE TRENCH SAFETY SYSTEM DETAILS, AS DESIGNED BY A PROFESSIONAL ENGINEER, ARE RETAINED AND COPIES SUBMITTED TO THE CITY OF ROUND ROCK.

STREET AND DRAINAGE NOTES:
DESIGN AND CONSTRUCTION STANDARDS (GENERAL GUIDELINES
CITY OF ROUND ROCK)

- ALL TESTING SHALL BE DONE BY AN INDEPENDENT LABORATORY AT THE OWNER'S EXPENSE. ANY RETESTING SHALL BE PAID FOR BY THE CONTRACTOR. A CITY INSPECTOR SHALL BE PRESENT DURING ALL TESTS. TESTING SHALL BE COORDINATED WITH THE CITY INSPECTOR AND HE SHALL BE GIVEN A MINIMUM OF 24 HOURS NOTICE PRIOR TO ANY TESTING. TELEPHONE 218-5555 (INSPECTIONS).
- IF TRENCH SAFETY SYSTEM DETAILS WERE NOT PROVIDED IN THE PLANS BECAUSE TRENCHES WERE ANTICIPATED TO BE LESS THAN 5 FEET IN DEPTH AND DURING CONSTRUCTION IT IS FOUND THAT TRENCHES ARE IN FACT 5 FEET OR MORE IN DEPTH OR TRENCHES LESS THAN 5 FEET DEEP ARE BEING DEEPENED IN AN AREA WHERE HAZARDOUS GROUND MOVEMENT IS EXPECTED, ALL CONSTRUCTION SHALL CEASE, THE TRENCHED AREA SHALL BE BARRICADED AND THE ENGINEER NOTIFIED IMMEDIATELY. CONSTRUCTION SHALL NOT RESUME UNTIL APPROPRIATE TRENCH SAFETY SYSTEM DETAILS, AS DESIGNED BY A PROFESSIONAL ENGINEER, ARE RETAINED AND COPIES SUBMITTED TO THE CITY OF ROUND ROCK.
- DEPTH OF COVERS FOR ALL CROSSINGS UNDER PAVEMENT INCLUDING GAS, ELECTRIC, TELEPHONE, CABLE TV, WATER SERVICES, ETC., SHALL BE A MINIMUM OF 30" BELOW SUBGRADE.
- STREET RIGHTS-OF-WAY SHALL BE GRADED AT A SLOPE OF 1/4" PER FOOT TOWARD THE CURB UNLESS OTHERWISE INDICATED. HOWEVER, SLOPE BE LESS THAN 1/4" PER FOOT SHALL BE ACCEPTED. A SPECIFIC REQUEST FOR AN ALTERNATE GRADING SCHEME IS MADE TO AND ACCEPTED BY THE CITY OF ROUND ROCK ENGINEERING AND DEVELOPMENT SERVICES DEPARTMENT.
- BARRICADES BUILT TO CITY OF ROUND ROCK STANDARDS SHALL BE CONSTRUCTED ON ALL DEAD-END STREETS AND AS NECESSARY DURING CONSTRUCTION TO MAINTAIN JOB AND PUBLIC SAFETY.
- ALL R.C.P. SHALL BE MINIMUM CLASS III.
- THE SUBGRADE MATERIAL FOR THE STREETS SHOWN HEREIN WAS TESTED BY THE GEOTECHNICAL ENGINEER WITH THE CURRENT CITY OF ROUND ROCK DESIGN CRITERIA. THE PAVING SECTIONS ARE TO BE CONSTRUCTED AS FOLLOWS:

STREET	STATION	FLEX. BASE THICKNESS	HMAC THICKNESS	LIME ST. THICKNESS

THE GEOTECHNICAL ENGINEER SHALL INSPECT THE SUBGRADE FOR COMPLIANCE WITH THE DESIGN ASSUMPTIONS. MADE DURING PREPARATION OF THE SOILS REPORT. ANY ADJUSTMENTS THAT ARE REQUIRED SHALL BE MADE THROUGH REVISION OF THE CONSTRUCTION PLANS.

WHERE P'S ARE OVER 20, SUBGRADES MUST BE STABILIZED UTILIZING A METHOD ACCEPTABLE TO THE CITY ENGINEER. THE GEOTECHNICAL ENGINEER SHALL RECOMMEND AN APPROPRIATE SUBGRADE STABILIZATION IF SULFATES ARE DETERMINED TO BE PRESENT.

WATER AND WASTEWATER NOTES:
DESIGN AND CONSTRUCTION STANDARDS (GENERAL GUIDELINES
CITY OF ROUND ROCK)

- PIPE MATERIAL FOR WATER MAINS SHALL BE PVC (AWWA C-900, MIN. CLASS 200), OR DUCTILE IRON (AWWA C-100, MIN. CLASS 200). WATER SERVICES (2" OR LESS) SHALL BE POLYETHYLENE TUBING (BLACK, 200 PSI, DR 9).
- PIPE MATERIAL FOR PRESSURE WASTEWATER MAINS SHALL BE PVC (AWWA C-900, MIN. CLASS 150), OR DUCTILE IRON (AWWA C-100, MIN. CLASS 200). PIPE MATERIAL FOR GRAVITY WASTEWATER MAINS SHALL BE PVC (ASTM D2241 OR D3034, MAX. DR -28), DUCTILE IRON (AWWA C-100, MIN. CLASS 200).
- UNLESS OTHERWISE ACCEPTED BY THE CITY ENGINEER, DEPTH OF COVER FOR ALL LINES OUT OF THE PAVEMENT SHALL BE 42" MIN., AND DEPTH OF COVER FOR ALL LINES UNDER PAVEMENT SHALL BE A MIN. OF 30" BELOW SUBGRADE.
- ALL FIRE HYDRANT LEADS SHALL BE DUCTILE IRON PIPE (AWWA C-100, MIN. CLASS 200).
- ALL IRON PIPE AND FITTINGS SHALL BE WRAPPED WITH MINIMUM 8-MIL POLYETHYLENE AND SEALED WITH DUCT TAPE OR EQUAL, ACCEPTED BY THE CITY ENGINEER.
- THE CONTRACTOR SHALL CONTACT THE CITY INSPECTOR AT 218-5555 TO NOTIFIE HIS AND NOTIFY HIM AT LEAST 48 HOURS PRIOR TO CONNECTING TO EXISTING LINES.
- ALL MANHOLES SHALL BE CONCRETE WITH CAST IRON RING AND COVER. ALL MANHOLES LOCATED OUTSIDE OF THE PAVEMENT SHALL HAVE BOLTED COVERS. TAPPING OF FIBERGLASS MANHOLES SHALL NOT BE ALLOWED.
- THE CONTRACTOR MUST OBTAIN A BULK WATER PERMIT OR PURCHASE AND INSTALL A WATER METER FOR ALL WATER USED DURING CONSTRUCTION. A COPY OF THIS PERMIT MUST BE CARRIED AT ALL TIMES BY ALL WHO USE WATER.
- LINE FLUSHING OR ANY ACTIVITY USING A LARGE QUANTITY OF WATER MUST BE SCHEDULED WITH THE WATER & WASTEWATER SUPERINTENDENT, TELEPHONE 218-5555.
- THE CONTRACTOR, AT HIS EXPENSE, SHALL PERFORM STERILIZATION OF ALL POTABLE WATER LINES CONSTRUCTED AND SHALL PROVIDE ALL EQUIPMENT (INCLUDING TEST GAUGES), SUPPLIES (INCLUDING CONCENTRATED CHLORINE DISINFECTING MATERIAL), AND NECESSARY LABOR REQUIRED FOR THE STERILIZATION PROCEDURE. THE STERILIZATION PROCEDURE SHALL BE MONITORED BY CITY OF ROUND ROCK PERSONNEL. WATER SAMPLES WILL BE COLLECTED BY THE CITY OF ROUND ROCK TO VERIFY EACH TREATED LINE HAS ATTAINED AN INITIAL CHLORINE CONCENTRATION OF 50 PPM FOR 30 MINUTES.
- THE CONTRACTOR, AT HIS EXPENSE, SHALL PROVIDE FLUSHING DEVICES AND REMOVE S/D DEVICES PRIOR TO FINAL ACCEPTANCE BY THE CITY OF ROUND ROCK.
- SAMPLING TAPS SHALL BE BROUGHT UP TO 1.5 FEET ABOVE GRADE AND SHALL BE EASILY ACCESSIBLE FOR CITY PERSONNEL. AT THE CONTRACTOR'S REQUEST, AND IN HIS PRESENCE, SAMPLES FOR BACTERIOLOGICAL TESTING WILL BE COLLECTED BY THE CITY OF ROUND ROCK NOT LESS THAN 24 HOURS AFTER THE TREATED LINE HAS BEEN TREATED WITH THE CONCENTRATED CHLORINE SOLUTION AND CHARGED WITH WATER APPROVED BY THE CITY. THE CONTRACTOR SHALL SUPPLY A CHECK OR MONEY ORDER, PAYABLE TO THE CITY OF ROUND ROCK, TO COVER THE FEE CHARGED FOR TESTING EACH WATER SAMPLE. CITY OF ROUND ROCK FEE AMOUNTS MAY BE OBTAINED BY CALLING THE ENGINEERING AND DEVELOPMENT SERVICES DEPARTMENT AT 218-5555.
- THE CONTRACTOR, AT HIS EXPENSE, SHALL PERFORM QUALITY TESTING FOR ALL WASTEWATER PIPE INSTALLED AND PRESSURE PIPE HYDROSTATIC TESTING OF ALL WATER LINES CONSTRUCTED AND SHALL PROVIDE ALL EQUIPMENT (INCLUDING PUMPS AND GAUGES), SUPPLIES AND LABOR NECESSARY TO PERFORM THE TESTS. QUALITY AND PRESSURE TESTING SHALL BE MONITORED BY THE CITY OF ROUND ROCK.
- THE CONTRACTOR SHALL COORDINATE TESTING WITH THE CITY INSPECTOR AND PROVIDE NO LESS THAN 24 HOURS NOTICE PRIOR TO PERFORMING STERILIZATION, QUALITY TESTING OR PRESSURE TESTING.
- THE CONTRACTOR SHALL NOT OPERATE OR CLOSE ANY VALVES UNLESS AUTHORIZED BY THE CITY OF ROUND ROCK.
- ALL VALVE BOXES AND COVERS SHALL BE CAST IRON.
- ALL WATER SERVICE, WASTEWATER SERVICE AND VALVE LOCATIONS SHALL BE APPROPRIATELY MARKED AS FOLLOWS:

WATER SERVICE	"W" ON TOP OF CURB
WASTEWATER SERVICE	"CY" ON TOP OF CURB
VALVE	"V" ON FACE OF CURB

TOOLS FOR MARKING THE CURB SHALL BE PROVIDED BY THE CONTRACTOR. OTHER APPROPRIATE MEANS OF MARKING SERVICE AND VALVE LOCATIONS SHALL BE PROVIDED IN AREAS WITHOUT CURBS. SUCH MEANS SHALL BE AS SPECIFIED BY THE ENGINEER AND ACCEPTED BY THE CITY OF ROUND ROCK.

WATER AND WASTEWATER NOTES:
DESIGN AND CONSTRUCTION STANDARDS (GENERAL GUIDELINES
CITY OF ROUND ROCK)

- ~~0. CONTRACTOR SHALL BE RESPONSIBLE FOR OBTAINING ALL NECESSARY EASEMENT DOCUMENTS FROM THE CITY OF ROUND ROCK ENGINEERING AND DEVELOPMENT SERVICES DEPARTMENT AT 218-5555 FOR ASSISTANCE IN OBTAINING EXISTING WATER AND WASTEWATER LOCATIONS.~~
- THE CITY OF ROUND ROCK FIRE DEPARTMENT SHALL BE NOTIFIED 48 HOURS PRIOR TO TESTING OF ANY BUILDING SPRINKLER PIPING IN ORDER THAT THE FIRE DEPARTMENT MAY MONITOR SUCH TESTING.
- SAND, AS DESCRIBED IN SPECIFICATION ITEM 510 PIPE, SHALL NOT BE USED AS BEDDING FOR WATER AND WASTEWATER LINES. ACCEPTABLE BEDDING MATERIALS ARE PIPE BEDDING STONE, PEA GRAVEL AND IN LIEU OF SAND, A NATURALLY OCCURRING OR MANUFACTURED STONE MATERIAL CONFORMING TO ASTM C33 FOR STONE QUALITY AND MEETING THE FOLLOWING GRADATION SPECIFICATION:

SEIVE SIZE	PERCENT RETAINED BY WEIGHT
1/2"	0
3/8"	0-2
#4	40-85
#10	95-100

- THE CONTRACTOR IS HEREBY NOTIFIED THAT CONNECTING TO, SHUTTING DOWN, OR TERMINATING EXISTING UTILITY LINES MAY HAVE TO OCCUR AT OFF-PEAK HOURS. SUCH HOURS ARE USUALLY OUTSIDE NORMAL WORKING HOURS AND POSSIBLY BETWEEN 12 A.M. AND 5 A.M.
- ALL WASTEWATER CONSTRUCTION SHALL BE IN ACCORDANCE WITH THE TEXAS COMMISSION ON ENVIRONMENTAL QUALITY (TCEQ) REGULATIONS, 30 TAC CHAPTER 213 AND 317, AS APPLICABLE. WHENEVER TCEQ AND CITY OF ROUND ROCK SPECIFICATIONS CONFLICT, THE MORE STRINGENT SHALL APPLY.

TRAFFIC MARKING NOTES:
DESIGN AND CONSTRUCTION STANDARDS (GENERAL GUIDELINES
CITY OF ROUND ROCK)

- ANY METHODS, STREET MARKINGS AND SIGNAGE NECESSARY FOR WARNING MOTORISTS, WARNING PEDESTRIANS OR DIVERTING TRAFFIC DURING CONSTRUCTION SHALL CONFORM TO THE TEXAS MANUAL OF UNIFORM TRAFFIC CONTROL DEVICES FOR STREETS AND HIGHWAYS, LATEST EDITION.
- ALL TEMPORARY MARKINGS, MARKERS, PAINT, BUFFER TRAFFICS, TRAFFIC CONTROLS AND SIGNS SHALL BE INSTALLED IN ACCORDANCE WITH THE TEXAS DEPARTMENT OF TRANSPORTATION STANDARD SPECIFICATIONS FOR CONSTRUCTION OF HIGHWAYS, STREETS AND BRIDGES AND, THE TEXAS MANUAL OF UNIFORM TRAFFIC CONTROL DEVICES FOR STREETS AND HIGHWAYS, LATEST EDITIONS.

EROSION AND SEDIMENTATION CONTROL NOTES:
DESIGN AND CONSTRUCTION STANDARDS (GENERAL GUIDELINES
CITY OF ROUND ROCK)

- EROSION CONTROL MEASURES, SITE WORK AND RESTORATION WORK SHALL BE IN ACCORDANCE WITH THE CITY OF ROUND ROCK EROSION AND SEDIMENTATION CONTROL ORDINANCE.
- ALL SLOPES SHALL BE SOODED OR SEEDDED WITH APPROVED GRASS, GRASS MIXTURES OR GROUND COVER SUITABLE TO THE AREA AND SEASON IN WHICH THEY ARE APPLIED.
- SILT FENCES, ROCK BERMS, SEDIMENTATION BASINS AND SIMILARLY RECOGNIZED TECHNIQUES AND MATERIALS SHALL BE EMPLOYED DURING CONSTRUCTION TO PREVENT POINT SOURCE SEDIMENTATION LOADING OF DOWNSIDE FACILITIES. SUCH INSTALLATION SHALL BE REGULARLY INSPECTED BY THE CITY OF ROUND ROCK FOR EFFECTIVENESS. ADDITIONAL MEASURES MAY BE REQUIRED IF, IN THE OPINION OF THE CITY ENGINEER, THEY ARE WARRANTED.
- ALL TEMPORARY EROSION CONTROL MEASURES SHALL NOT BE REMOVED UNTIL FINAL INSPECTION AND APPROVAL OF THE PROJECT BY THE ENGINEER. IT SHALL BE THE RESPONSIBILITY OF THE CONTRACTOR TO MAINTAIN ALL TEMPORARY EROSION CONTROL STRUCTURES AND TO REMOVE EACH STRUCTURE AS APPROVED BY THE ENGINEER.
- ALL MUD, DIRT, ROCKS, DEBRIS, ETC., SPILLED, TRACKED OR OTHERWISE DEPOSITED ON EXISTING PAVED STREETS, DRIVES AND AREAS USED BY THE PUBLIC SHALL BE CLEANED UP IMMEDIATELY.
- DEVELOPER INFORMATION:

OWNER _____
ADDRESS _____
OWNER'S REPRESENTATIVE FOR PLAN ALTERATIONS:
AGENT: **SERGIO LOZANO SANCHEZ**
PHONE: **(512) 587-7236**
ADDRESS: **1718 E. 7TH ST. AUSTIN TEXAS, 78741**
PERSON OR FIRM RESPONSIBLE FOR EROSION/SEDIMENTATION CONTROL MAINTENANCE:
MR. SERGIO LOZANO PHONE: **(512)-587-7236**

Texas Commission on Environmental Quality
Water Pollution Abatement Plan
General Construction Notes

The following "construction notes" are intended to be advisory in nature only and do not constitute an approval or conditional approval by the Executive Director (ED), nor do they constitute a comprehensive listing of rules or conditions to be followed during construction. Further actions may be required to achieve compliance with TCEQ regulations found in Title 30, Texas Administrative Code (TAC), Chapters 213 and 317, as well as local ordinances and regulations providing for the protection of water quality. Additionally, nothing contained in the following "construction notes" restricts the power of the ED, the commission or any other governmental entity to prevent, correct, or penalize activities that result or may result in violation of the Edwards Aquifer or hydrologically connected surface waters. The holder of any Edwards Aquifer Protection Plan containing "construction notes" is still responsible for compliance with Title 30, TAC, Chapter 213 or any other applicable TCEQ regulation, as well as all conditions of an Edwards Aquifer Protection Plan through all phases of plan implementation. Failure to comply with any condition of the ED's approval or any violation in construction "construction notes" is a violation of TCEQ regulations and any violation is subject to administrative rules, orders, and penalties as provided under Title 30, TAC 213.10 relating to Enforcement. Such violations may also be subject to criminal penalties and penalties. The following "construction notes" do in no way represent an approved exception by the ED to any part of Title 30 TAC, Chapters 213 and 317, or any other TCEQ applicable regulation.

- A written notice of construction must be submitted to the TCEQ regional office at least 48 hours prior to the start of any regulated activities. This notice must include:
 - the name of the approved project;
 - the activity start date; and
 - the contact information of the prime contractor.
- All contractors conducting regulated activities associated with this project must be provided with complete copies of the approved Water Pollution Abatement Plan (WPAP) and the TCEQ letter indicating the specific conditions of its approval. During the course of these regulated activities, the contractors are required to keep on-site copies of the approved plan and approval letter.
- If any sensitive features (i.e., caves, solution cavity, sink hole, etc.) is discovered during construction, all regulated activities near the sensitive feature must be suspended immediately. The appropriate TCEQ regional office must be immediately notified of any sensitive features encountered during construction. Construction activities may not be resumed until the TCEQ has reviewed and approved the appropriate protective measures in order to protect any sensitive feature and the Edwards Aquifer from potentially adverse impacts to water quality.
- No temporary or permanent hazardous substance storage tank shall be installed within 150 feet of a water supply source, distribution system, well, or sensitive feature.
- Prior to beginning any construction activity, all temporary erosion and sedimentation (E&S) control measures must be properly installed and maintained in accordance with the approved plans and manufacturers specifications. If inspections indicate a control has been used inappropriately, or incorrectly, the applicant must replace or modify the control for site situations. These controls must remain in place until the disturbed areas have been permanently stabilized.
- Any sediment that escapes the construction site must be collected and properly disposed of before the next rain event to ensure it is not washed into surface streams, sensitive features, etc.
- Sediment must be removed from the sediment traps or sedimentation basins not later than

TCEQ-0592 (Rev. July 15, 2015) Page 1 of 2

Texas Commission on Environmental Quality
Organized Sewage Collection System
General Construction Notes

The following "construction notes" are intended to be advisory in nature only and do not constitute an approval or conditional approval by the Executive Director, nor do they constitute a comprehensive listing of rules or conditions to be followed during construction. Further actions may be required to achieve compliance with TCEQ regulations found in Title 30, Texas Administrative Code (TAC), Chapters 213 and 317, as well as local ordinances and regulations providing for the protection of water quality. Additionally, nothing contained in the following "construction notes" restricts the power of the Executive Director, the commission or any other governmental entity to prevent, correct, or penalize activities that result or may result in violation of the Edwards Aquifer or hydrologically connected surface waters. The holder of any Edwards Aquifer Protection Plan containing "construction notes" is still responsible for compliance with Title 30, Texas Administrative Code, Chapter 213 or any other applicable TCEQ regulation, as well as all conditions of an Edwards Aquifer Protection Plan through all phases of plan implementation. Failure to comply with any condition of the ED's approval, whether or not contained in any "construction notes" is a violation of TCEQ regulations and any violation is subject to administrative rules, orders, and penalties as provided under Title 30, Texas Administrative Code 213.10 relating to Enforcement. Such violations may also be subject to criminal penalties and penalties. The following "construction notes" do in no way represent an approved exception by the Executive Director to any part of Title 30 Texas Administrative Code, Chapters 213 and 317, or any other TCEQ applicable regulation.

- This Organized Sewage Collection System (SCS) must be constructed in accordance with 30 Texas Administrative Code (TAC) §213.5(i), the Texas Commission on Environmental Quality's (TCEQ) Edwards Aquifer Rules and any local government standard specifications.
- All contractors conducting regulated activities associated with this proposed regulated project must be provided with copies of the SCS plan and the TCEQ letter indicating the specific conditions of its approval. During the course of these regulated activities, the contractors must be required to keep on-site copies of the plan and the approval letter.
- A written notice of construction must be submitted to the presiding TCEQ regional office at least 48 hours prior to the start of any regulated activities. This notice must include:
 - the name of the approved project;
 - the activity start date; and
 - the contact information of the prime contractor.
- Any modification to the activities described in the referenced SCS application following the date of approval may require the submission of an SCS application to modify this approval, including the payment of appropriate fees and all information necessary for its review and approval.
- Prior to beginning any construction activity, all temporary erosion and sedimentation (E&S) control measures must be properly installed and maintained in accordance with the manufacturers specifications. These controls must remain in place until the disturbed areas have been permanently stabilized.
- If any sensitive features are discovered during the wastewater line trenching activities, all regulated activities near the sensitive feature must be suspended immediately. The applicant must immediately notify the appropriate regional office of the TCEQ of the feature discovered. A geologist's assessment of the location and extent of the feature must be reported to that regional office in writing and the applicant must submit a plan for ensuring the structural integrity of the sewer line or for modifying the proposed collection system alignment around the feature. The regulated activities near the sensitive feature may not proceed until the

TCEQ-0596 (Rev. July 15, 2015) Page 1 of 6

L = length of line of same size being tested, in feet
Q = rate of loss, 0.0015 cubic feet per minute per square foot internal surface

(C) Since a K value of less than 1.0 may not be used, the minimum testing time for each pipe diameter is shown in the following Table C.3:

Pipe Diameter (inches)	Minimum Time (seconds)	Maximum Length for Longer Length (feet)	Time for Longer Length (seconds/feet)
6	340	398	0.855
8	454	298	1.520
10	567	239	2.374
12	680	199	3.419
15	850	159	5.342
18	1020	133	7.693
21	1190	114	10.471
24	1360	100	13.676
27	1530	88	17.309
30	1700	80	21.369
33	1870	72	25.856

- An owner may stop a test if no pressure loss has occurred during the first 25% of the calculated testing time.
- If any pressure loss or leakage has occurred during the first 25% of a testing period, then the test must continue for the entire test duration as required. The following procedures must be followed:
 - Wastewater collection system pipes with a 27 inch or larger average inside diameter may be air tested at each joint instead of following the procedure outlined in this section.
 - A testing procedure for pipe with an inside diameter greater than 33 inches shall be approved by the executive director.
- Infiltration/Exfiltration Test.**
 - The total exfiltration, as determined by a hydrostatic head test, must not exceed 50 gallons per inch of diameter per mile of pipe per 24 hours at a minimum test head of 2.0 feet above the crown of a pipe at an upstream manhole. An owner shall use an infiltration test in lieu of an exfiltration test when pipes are installed below the groundwater level.
 - The total exfiltration, as determined by a hydrostatic head test, must not exceed 50 gallons per inch diameter per mile of pipe per 24 hours at a minimum test head of two feet above the crown of a pipe at an upstream manhole, or at least two feet above existing groundwater level, whichever is greater.
 - For construction within a 25-year flood plain, the infiltration or exfiltration must not exceed 10 gallons per inch diameter per mile of pipe per 24 hours at the same minimum test head as in subparagraph (C) of this paragraph.
 - If the quantity of infiltration or exfiltration exceeds the maximum quantity specified, an owner shall undertake remedial action in order to reduce

TCEQ-0596 (Rev. July 15, 2015) Page 4 of 6

- when it occupies 50% of the basin's design capacity.
- Litter, construction debris, and construction chemicals exposed to stormwater shall be prevented from being discharged offsite.
- All spoils (excavated material) generated from the project site must be stored on-site with proper E&S controls. For storage or disposal of spoils at another site on the Edwards Aquifer Recharge Zone, the owner of the site must receive approval of a water pollution abatement plan for the placement of fill material or mass grading prior to the placement of spoils at the other site.
- If portions of the site will have a temporary or permanent cease in construction activity lasting longer than 14 days, soil stabilization in those areas shall be initiated as soon as possible prior to the 14th day of inactivity. If activity will resume prior to the 21st day, stabilization measures are not required. If drought conditions or inclement weather prevent action by the 14th day, stabilization measures shall be initiated as soon as possible.
- The following records shall be maintained and made available to the TCEQ upon request:
 - the dates when major grading activities occur;
 - the dates when construction activities temporarily or permanently cease on a portion of the site; and
 - the dates when stabilization measures are initiated.
- The holder of any approved Edwards Aquifer protection plan must notify the appropriate regional office in writing and obtain approval from the executive director prior to initiating any of the following:
 - any physical or operational modification of any water pollution abatement structure(s), including but not limited to ponds, dams, berms, sewage treatment plants, and diversionary structures;
 - any change in the nature or character of the regulated activity from that which was approved or a change which significantly impacts the ability of the plan to prevent pollution of the Edwards Aquifer;
 - any development of land previously identified as undeveloped in the original water pollution abatement plan.

Austin Regional Office 12100 Park 35 Circle, Building A Austin, Texas 78733-1808 Phone (512) 339-2929 Fax (512) 339-3795	San Antonio Regional Office 14250 Judson Road San Antonio, Texas 78233-4480 Phone (210) 490-3096 Fax (210) 545-4329
--	---

THESE GENERAL CONSTRUCTION NOTES MUST BE INCLUDED ON THE CONSTRUCTION PLANS PROVIDED TO THE CONTRACTOR AND ALL SUBCONTRACTORS.

TCEQ-0592 (Rev. July 15, 2015) Page 2 of 2

Texas Commission on Environmental Quality
Organized Sewage Collection System
General Construction Notes

The following "construction notes" are intended to be advisory in nature only and do not constitute an approval or conditional approval by the Executive Director, nor do they constitute a comprehensive listing of rules or conditions to be followed during construction. Further actions may be required to achieve compliance with TCEQ regulations found in Title 30, Texas Administrative Code (TAC), Chapters 213 and 317, as well as local ordinances and regulations providing for the protection of water quality. Additionally, nothing contained in the following "construction notes" restricts the power of the Executive Director, the commission or any other governmental entity to prevent, correct, or penalize activities that result or may result in violation of the Edwards Aquifer or hydrologically connected surface waters. The holder of any Edwards Aquifer Protection Plan containing "construction notes" is still responsible for compliance with Title 30, Texas Administrative Code, Chapter 213 or any other applicable TCEQ regulation, as well as all conditions of an Edwards Aquifer Protection Plan through all phases of plan implementation. Failure to comply with any condition of the ED's approval, whether or not contained in any "construction notes" is a violation of TCEQ regulations and any violation is subject to administrative rules, orders, and penalties as provided under Title 30, Texas Administrative Code 213.10 relating to Enforcement. Such violations may also be subject to criminal penalties and penalties. The following "construction notes" do in no way represent an approved exception by the Executive Director to any part of Title 30 Texas Administrative Code, Chapters 213 and 317, or any other TCEQ applicable regulation.

- Where sewer lines located within or crossing the 5-year floodplain of a drainage way will be protected from inundation and storm vehicles which could cause erosion and scouring of backfill. The trench must be capped with concrete to prevent scouring of backfill, or the sewer lines must be encased in concrete. All concrete shall have a minimum thickness of 6 inches.
- Blinding procedures for protection of existing sewer lines and other utilities will be in accordance with the National Fire Protection Association criteria. Sand is not allowed as bedding or backfill in trenches that have been blasted. If any existing sewer lines are damaged, the lines must be repaired and retested.
- All manholes constructed or rehabilitated on this project must have watertight seal on size resistant connectors allowing for differential settlement. If manholes are constructed within the 100-year floodplain, the cover must have a gasket and be bolted to the ring. Where gasketed manhole covers are required for more than three manholes in sequence or for more than 1500 feet, alternate means of venting will be provided. Bricks are not an acceptable construction material for any portion of the manhole.
- The diameter of the manholes must be a minimum of four feet and the manhole for entry must have a minimum clear opening diameter of 30 inches. These dimensions and other details showing compliance with the commission's rules concerning manholes and sewer line/manhole inverts described in 30 TAC §217.56 are included on Plan Sheet ___ of ____.
- It is suggested that entrance into manholes in excess of four feet deep be accomplished by means of a portable ladder. The manhole is prohibited.
- Where water lines and new sewer lines are installed with a separation distance less than nine feet (i.e., water lines crossing wastewater lines, water lines paralleling wastewater lines, or water lines next to manholes) the installation must meet the requirements of 30 TAC §217.53(d) (Pipes Design) and 30 TAC §290.4(e) (Water Distribution).
- Where sewers lines deviate from straight alignment and uniform grade all curvature of sewer pipe must be achieved by the following procedure which is recommended by the pipe manufacturer:
 - If pipe flexure is proposed, the following method of preventing deflection of the joint must be used:

Specific care must be taken to ensure that the joint is placed in the center of the trench and properly bedded in accordance with 30 TAC §217.54.
 - New sewage collection system lines must be constructed with stub outs for the connection of anticipated extensions. The location of such stub outs must be marked on the ground such that their location can be easily determined at the time of connection of the extensions. Such stub outs must be manufactured wyes or tees that are compatible in size and material with both the sewer line and the extension. At the time of original construction, new stub-outs must be constructed sufficiently to extend beyond the end of the street pavement. All stub-outs must be sealed with a manufactured cap to prevent leakage. Extensions that were not anticipated at the time of original construction and which are to be connected to an existing sewer line not furnished with stub outs must be connected using a manufactured saddle and in accordance with accepted plumbing techniques.

TCEQ-0596 (Rev. July 15, 2015) Page 2 of 6

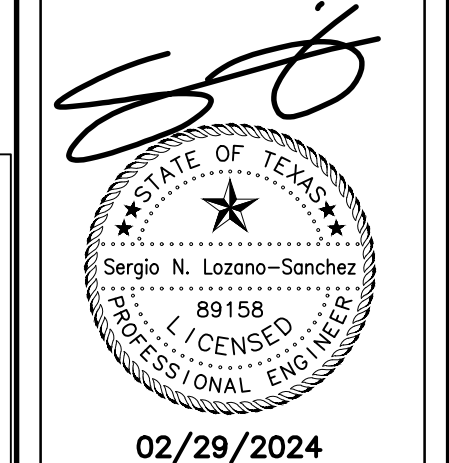
- The maximum leakage for hydrostatic testing or any alternative test methods is 0.025 gallons per foot diameter per foot of manhole depth per hour.
- To perform a hydrostatic exfiltration test, an owner shall seal all wastewater pipes coming into a manhole with an internal pipe plug, fill the manhole with water, and maintain the test for at least one hour.
- A test for concrete manholes may use a 24-hour wetting period before testing to allow saturation of the concrete.
- Vacuum Testing.**
 - To perform a vacuum test, an owner shall plug all lift holes and exterior joints with non-shrink grout and plug all pipes entering a manhole.
 - No grout must be placed in horizontal joints before testing.
 - Stub-outs, manhole boots, and pipe plugs must be secured to prevent movement while a vacuum is drawn.
 - An owner shall use a minimum 60 inch/lb torque wrench to tighten the external clamps that secure a test cover to the top of a manhole.
 - A test head must be placed at the inside of the top of a cone section, and the seal inflated in accordance with the manufacturer's recommendations.
 - There must be a vacuum of 10 inches of mercury inside a manhole to perform a valid test.
 - A test does not begin until after the vacuum pump is off.
 - A manhole passes the test if after 2.0 minutes and with all valves closed, the vacuum is at least 9.0 inches of mercury.
- All private service laterals must be inspected and certified in accordance with 30 TAC §243.5(c)(3)(ii). After installation of end, prior to covering and connecting a private service lateral to an existing organized sewage collection system, a Texas Licensed Professional Engineer, Texas Registered Sanitarian, or appropriate city inspector, shall visually inspect the private service lateral and the connection to the sewage collection system, and certify that it is constructed in conformity with the applicable provisions of this section. The owner of the collection system must maintain such certifications for five years and forward copies to the appropriate regional office upon request. Connections may only be made to an approved sewage collection system.

Austin Regional Office 12100 Park 35 Circle, Building A Austin, Texas 78733-1808 Phone (512) 339-2929 Fax (512) 339-3795	San Antonio Regional Office 14250 Judson Road San Antonio, Texas 78233-4480 Phone (210) 490-3096 Fax (210) 545-4329
--	---

THESE GENERAL CONSTRUCTION NOTES MUST BE INCLUDED ON THE CONSTRUCTION PLANS PROVIDED TO THE CONTRACTOR AND ALL SUBCONTRACTORS.

TCEQ-0596 (Rev. July 15, 2015) Page 5 of 6

NO.	DESCRIPTION	REVISIONS / CORRECTIONS		
		DATE	BY	DESCRIPTION



02/29/2024

GREAT OAKS DR.
 15917 GREAT OAKS DRIVE
GENERAL NOTES

UTILITY PLACEMENT WITHIN CORR CONTROLLED AREA

GENERAL NOTES SHEET

- UTILITY LINE IS A PUBLIC OR PRIVATE POWER, COMMUNICATION, TELEVISION, GAS, FIBER OPTIC AND IRRIGATION (DRY OR PRESSURED) LINE. INCLUDE CONDUIT PIPE OR TUBING.
- UTILITY CLUSTER IS ANY NUMBER AND MIX OF DIRECT BURIED "DRY" UTILITY LINES IN A VERTICAL, HORIZONTAL OR BUNDLE CONFIGURATION. ENCASUREMENT IN ANY NUMBER OF CONCRETE, CURB, CORRUGATED PIPE, CONDUIT BUNDLE, WELDED STEEL, ETC., AND/OR PROTECTIVE FLOOR BEDDING (CONCRETE, FLOWABLE FILL, ETC.).
- ALL TRENCH SAFETY SHALL COMPLY WITH APPLICABLE FEDERAL, STATE AND LOCAL REGULATIONS.
- UTILITY WORK SITE IS THE LOCATION WHERE A UTILITY IS MAINTAINED, REPAIRED AND/OR REINSTALLED.
- A COPY OF THE PERMIT IS REQUIRED ON THE UTILITY WORK SITE. THIS PERMIT SHALL BE SCHEDULED 40 FEET FROM THE POINT OF IMPACTING VEHICLE/PEDESTRIAN TRAFFIC. SAFETY OR CAUTION LABELS (TEMPORARY/LONG TERM), THIS EXCLUDES UNACCEPTED SUBSTANCES, CO₂ STATE OF CHARGES, PRIVATELY CONTROLLED EXISTING & PRIVATELY OWNED PROPERTY.
- VARIANCE FROM THESE STANDARDS IS ONLY ALLOWED IF DETAILED PLANS HAVE WRITTEN APPROVAL BY THE CORP BEFORE CONSTRUCTION.
- UTILITY AREA EXCAVATION MUST BE BARRICADED WITH APPROVED VEHICLES AND PEDESTRIAN TRAFFIC CONTROL DEVICES BEFORE CONSTRUCTION STARTS.
- UTILITY AREA EXCAVATION MUST BE BARRICADED WITH APPROVED VEHICLES AND PEDESTRIAN TRAFFIC CONTROL DEVICES BEFORE CONSTRUCTION STARTS.
- CONSTRUCTION SHALL NOT REMAIN OPEN OVER A WEEKEND OR HOLIDAY WITHOUT PRIOR WRITTEN APPROVAL FROM THE CORP AND SAFETY GUARDIAN.
- TRENCH WIDTH SHALL BE THE SUM OF THE OUTSIDE DIMENSION (OOD) OF THE UTILITY CLUSTER OR ENCASUREMENT PLUS A MINIMUM OF 2" IF THE OOD IS LESS THAN 6 1/2", PLUS 6" IF THE OOD IS BETWEEN 6 1/2" & 18", PLUS 12" IF THE OOD IS MORE THAN 18" WITH A MAXIMUM OF 24".
- FOR A UTILITY WORK SITE IN AN AREA THAT IS SCHEDULED FOR FUTURE PAVEMENT, SEE ASPHALT PAVED AREA TRENCH (APAT) (DU-03).
- UTILITY WORK SHALL BE IN AN AREA THAT HAS EXISTING PAVEMENT. SEE PROPOSED PAVEMENT AREA TRENCH (PPAT) (DU-04) DETAIL.
- FOR A CROSSING OF A CORR OWNED UTILITY, SEE UTILITY CROSSING INSTALLATION (UCI) (DU-04) DETAIL.
- STANDARD TYPES OF ENCASUREMENT REQUIRE CORN WRITTEN APPROVAL. (SEE NOTES #16 AND #19 ON DETAIL DU-01)
- ALL ELECTRICAL CONDUIT LINES OVER 40 FEET MUST BE ENCASED.
- ALL UTILITY LINES MUST BE ENCASED UNDER EXISTING AND PROPOSED PAVEMENT, CROSSING ABOVE CORR LINES AND UNDER PROTECTED TREES.
- WASHED SAND BEDDING MUST BE USED IN THE INSTALLATION WHEN WITHIN 10' OF A CORR OWNED UTILITY LINE, EXCEPT IN EXISTING PAVEMENT.
- REQUIRED WASHED SAND BEDDING IN A TRENCH WITH SIDE WALL CLEARANCE LESS THAN 3" IS SMALL GRAIN (MAXIMUM 1/4") AND IN A TRENCH WITH SIDE WALL CLEARANCE MORE THAN 3" IS LARGE GRAIN (MAXIMUM 3/16"). BEDDING MUST BE CONSOLIDATED TO MINIMIZE SETTLE/SHIFTS.
- ALL OF THE AREAS DISTURBED DIRECTLY BY, INDIRECTLY BY OR BECAUSE OF THE UTILITY WORK, WILL BE INCLUDED IN THE CLEAN UP. CLEAN UP INCLUDES DRESSING, GROSS CONTROL, MAINTENANCE/REPAIR, RESTORATION, DEBRIS REMOVAL/DISPOSAL & PAVEMENT REPAIRING/WASHING.
- RESTORATION AS A MINIMUM SHALL INCLUDE: FERTILIZER.
- ANY LAWN LIKE AREAS - SOIL SOOENING WITH GRASS LIKE EXISTING OR APPROVED BETTER.
- GRASSES OR LESS - HYDRO-SEEDING.
- GRASSES ABOVE 10" UP TO 100" - MATTED AND HYDRO-SEEDING.
- GRASSES ABOVE 100" UP TO 1000" - SOIL SOOENING WITH GRASS LIKE EXISTING OR APPROVED BETTER.
- GRASSES ABOVE 1000" - DETAIL PLANS AND CORR WRITTEN APPROVAL REQUIRED.

LEGEND FOR DU SHEETS

PVC	POLYVINYL CHLORIDE PIPE OR CONDUIT
OD	OUTSIDE DIAMETER
GALS	UNITED STATES GALLONS - UNIT OF VOLUME
LBS	UNITED STATES POUNDS - UNIT OF WEIGHT
CORR	CITY OF ROUND ROCK
PUE	PUBLIC UTILITY ENCASUREMENT
SY	UNITED STATES SQUARE YARDS - UNIT OF AREA
"	UNITED STATES INCH OR INCHES - UNIT OF LENGTH
'	UNITED STATES FOOT OR FEET - UNIT OF LENGTH
ETC	ABBREVIATION FOR ET CETERA, IN HENCE TO BE "AND SO FORTH"
ROW	RIGHT OF WAY OR RIGHTS OF WAY
LAB	ABBREVIATION FOR LABORATORY
"	UNITED STATES DEGREE - UNIT OF ANGLE
TV	TELEVISION

CITY OF ROUND ROCK DU-01

CITY OF ROUND ROCK

DRY UTILITY DETAILS GENERAL NOTES SHEET

APPROVED 04-01-10 DATE

THE ARCHITECT/ENGINEER ASSUMES RESPONSIBILITY FOR THE APPROPRIATE USE OF THIS DETAIL, NOT TO SCALE.

CITY OF ROUND ROCK DU-01

SPILL CURB

CATCH CURB

CURB EXPANSION JOINT DOWEL DETAIL

CITY OF ROUND ROCK DU-02

CITY OF ROUND ROCK

CONCRETE DRIVEWAY DETAIL (COMMERCIAL OR MULTI-FAMILY)

APPROVED 04-01-10 DATE

THE ARCHITECT/ENGINEER ASSUMES RESPONSIBILITY FOR THE APPROPRIATE USE OF THIS DETAIL, NOT TO SCALE.

CITY OF ROUND ROCK ST-03

FIRE LANE MARKING DETAIL

CITY OF ROUND ROCK ST-13

UNPAVED AREA TRENCH (UAT) DETAIL

CITY OF ROUND ROCK DU-02

CITY OF ROUND ROCK

UNPAVED AREA TRENCH (UAT) DETAIL

APPROVED 04-01-10 DATE

THE ARCHITECT/ENGINEER ASSUMES RESPONSIBILITY FOR THE APPROPRIATE USE OF THIS DETAIL, NOT TO SCALE.

CITY OF ROUND ROCK DU-02

SPILL CURB

CATCH CURB

CURB EXPANSION JOINT DOWEL DETAIL

CITY OF ROUND ROCK ST-05

CITY OF ROUND ROCK

SPILL AND CATCH CURB DETAIL (WITH CURB EXPANSION JOINT DOWEL DETAIL)

APPROVED 04-01-10 DATE

THE ARCHITECT/ENGINEER ASSUMES RESPONSIBILITY FOR THE APPROPRIATE USE OF THIS DETAIL, NOT TO SCALE.

CITY OF ROUND ROCK ST-05

ASPHALT PAVED AREA TRENCH (APAT) DETAIL

CITY OF ROUND ROCK DU-03

CITY OF ROUND ROCK

ASPHALT PAVED AREA TRENCH (APAT) DETAIL

APPROVED 04-01-10 DATE

THE ARCHITECT/ENGINEER ASSUMES RESPONSIBILITY FOR THE APPROPRIATE USE OF THIS DETAIL, NOT TO SCALE.

CITY OF ROUND ROCK DU-03

CONCRETE VALLEY GUTTER DETAIL

CITY OF ROUND ROCK ST-06

CITY OF ROUND ROCK

CONCRETE VALLEY GUTTER DETAIL

APPROVED 04-01-10 DATE

THE ARCHITECT/ENGINEER ASSUMES RESPONSIBILITY FOR THE APPROPRIATE USE OF THIS DETAIL, NOT TO SCALE.

CITY OF ROUND ROCK ST-06

PROPOSED PAVEMENT AREA TRENCH (PPAT) DETAIL

CITY OF ROUND ROCK DU-04

CITY OF ROUND ROCK

PROPOSED PAVEMENT AREA TRENCH (PPAT) DETAIL

APPROVED 04-01-10 DATE

THE ARCHITECT/ENGINEER ASSUMES RESPONSIBILITY FOR THE APPROPRIATE USE OF THIS DETAIL, NOT TO SCALE.

CITY OF ROUND ROCK DU-04

CONCRETE VALLEY GUTTER DETAIL

CITY OF AUSTIN ST-07

CITY OF AUSTIN

CONCRETE VALLEY GUTTER DETAIL

RECORD COPY SIGNED BY LINDA RIVERA 9/29/99 ADOPTED

THE ARCHITECT/ENGINEER ASSUMES RESPONSIBILITY FOR THE APPROPRIATE USE OF THIS STANDARD.

STANDARD NO. 430S-1

SIDEWALK DETAIL

CITY OF ROUND ROCK ST-01

CITY OF ROUND ROCK

SIDEWALK DETAIL

APPROVED 04-01-10 DATE

THE ARCHITECT/ENGINEER ASSUMES RESPONSIBILITY FOR THE APPROPRIATE USE OF THIS DETAIL, NOT TO SCALE.

CITY OF ROUND ROCK ST-01

ACCESSIBLE PARKING & SIGN DETAIL

CITY OF ROUND ROCK ST-01

CITY OF ROUND ROCK

ACCESSIBLE PARKING & SIGN DETAIL

APPROVED 04-01-10 DATE

THE ARCHITECT/ENGINEER ASSUMES RESPONSIBILITY FOR THE APPROPRIATE USE OF THIS DETAIL, NOT TO SCALE.

CITY OF ROUND ROCK ST-01

NO.	DESCRIPTION

Sergio N. Lozano-Sanchez
89158
LICENSED PROFESSIONAL ENGINEER
STATE OF TEXAS
02/29/2024

GREAT OAKS DR.

15917 GREAT OAKS DRIVE

GENERAL CONSTRUCTION DETAILS

CIVIL DIVISION

LOC CONSULTANTS