

**CONTRIBUTING ZONE PLAN
FOR
NORSELAND COMAL UNIT 1**

PREPARED FOR
Texas Commission on Environmental Quality
Region 13 – San Antonio
14250 Judson Road
San Antonio, Texas 78233
210-490-3096 (office)
210-545-4329 (fax)

PREPARED BY



F-13351

James Ingalls, P.E.
2021 SH 46W, Ste. 105
New Braunfels, TX 78132

Prepared
July 27, 2023



Texas Commission on Environmental Quality

Edwards Aquifer Application Cover Page

Our Review of Your Application

The Edwards Aquifer Program staff conducts an administrative and technical review of all applications. The turnaround time for administrative review can be up to 30 days as outlined in 30 TAC 213.4(e). Generally administrative completeness is determined during the intake meeting or within a few days of receipt. The turnaround time for technical review of an administratively complete Edwards Aquifer application is 90 days as outlined in 30 TAC 213.4(e). Please know that the review and approval time is directly impacted by the quality and completeness of the initial application that is received. In order to conduct a timely review, it is imperative that the information provided in an Edwards Aquifer application include final plans, be accurate, complete, and in compliance with [30 TAC 213](#).

Administrative Review

1. [Edwards Aquifer applications](#) must be deemed administratively complete before a technical review can begin. To be considered administratively complete, the application must contain completed forms and attachments, provide the requested information, and meet all the site plan requirements. The submitted application and plan sheets should be final plans. Please submit one full-size set of plan sheets with the original application, and half-size sets with the additional copies.

To ensure that all applicable documents are included in the application, the program has developed tools to guide you and web pages to provide all forms, checklists, and guidance. Please visit the below website for assistance: <http://www.tceq.texas.gov/field/eapp>.

2. This Edwards Aquifer Application Cover Page form (certified by the applicant or agent) must be included in the application and brought to the administrative review meeting.
3. Administrative reviews are scheduled with program staff who will conduct the review. Applicants or their authorized agent should call the appropriate regional office, according to the county in which the project is located, to schedule a review. The average meeting time is one hour.
4. In the meeting, the application is examined for administrative completeness. Deficiencies will be noted by staff and emailed or faxed to the applicant and authorized agent at the end of the meeting, or shortly after. Administrative deficiencies will cause the application to be deemed incomplete and returned.

An appointment should be made to resubmit the application. The application is re-examined to ensure all deficiencies are resolved. The application will only be deemed administratively complete when all administrative deficiencies are addressed.

5. If an application is received by mail, courier service, or otherwise submitted without a review meeting, the administrative review will be conducted within 30 days. The applicant and agent will be contacted with the results of the administrative review. If the application is found to be administratively incomplete, it can be retrieved from the regional office or returned by regular mail. If returned by mail, the regional office may require arrangements for return shipping.
6. If the geologic assessment was completed before October 1, 2004 and the site contains “possibly sensitive” features, the assessment must be updated in accordance with the *Instructions to Geologists* (TCEQ-0585 Instructions).

Technical Review

1. When an application is deemed administratively complete, the technical review period begins. The regional office will distribute copies of the application to the identified affected city, county, and groundwater conservation district whose jurisdiction includes the subject site. These entities and the public have 30 days to provide comments on the application to the regional office. All comments received are reviewed by TCEQ.
2. A site assessment is usually conducted as part of the technical review, to evaluate the geologic assessment and observe existing site conditions. The site must be accessible to our staff. The site boundaries should be

clearly marked, features identified in the geologic assessment should be flagged, roadways marked and the alignment of the Sewage Collection System and manholes should be staked at the time the application is submitted. If the site is not marked the application may be returned.

3. We evaluate the application for technical completeness and contact the applicant and agent via Notice of Deficiency (NOD) to request additional information and identify technical deficiencies. There are two deficiency response periods available to the applicant. There are 14 days to resolve deficiencies noted in the first NOD. If a second NOD is issued, there is an additional 14 days to resolve deficiencies. If the response to the second notice is not received, is incomplete or inadequate, or provides new information that is incomplete or inadequate, the application must be withdrawn or will be denied. Please note that because the technical review is underway, whether the application is withdrawn or denied **the application fee will be forfeited**.
4. The program has 90 calendar days to complete the technical review of the application. If the application is technically adequate, such that it complies with the Edwards Aquifer rules, and is protective of the Edwards Aquifer during and after construction, an approval letter will be issued. Construction or other regulated activity may not begin until an approval is issued.

Mid-Review Modifications

It is important to have final site plans prior to beginning the permitting process with TCEQ to avoid delays.

Occasionally, circumstances arise where you may have significant design and/or site plan changes after your Edwards Aquifer application has been deemed administratively complete by TCEQ. This is considered a “Mid-Review Modification”. Mid-Review Modifications may require redistribution of an application that includes the proposed modifications for public comment.

If you are proposing a Mid-Review Modification, two options are available:

- If the technical review has begun your application can be denied/withdrawn, your fees will be forfeited, and the plan will have to be resubmitted.
- TCEQ can continue the technical review of the application as it was submitted, and a modification application can be submitted at a later time.

If the application is denied/withdrawn, the resubmitted application will be subject to the administrative and technical review processes and will be treated as a new application. The application will be redistributed to the affected jurisdictions.

Please contact the regional office if you have questions. If your project is located in Williamson, Travis, or Hays County, contact TCEQ’s Austin Regional Office at 512-339-2929. If your project is in Comal, Bexar, Medina, Uvalde, or Kinney County, contact TCEQ’s San Antonio Regional Office at 210-490-3096

Please fill out all required fields below and submit with your application.

1. Regulated Entity Name: Norseland Comal Unit 1					2. Regulated Entity No.:				
3. Customer Name: Norseland Comal, LLC					4. Customer No.:				
5. Project Type: (Please circle/check one)	<input checked="" type="radio"/> New	Modification			Extension		Exception		
6. Plan Type: (Please circle/check one)	<input type="radio"/> WPAP	<input checked="" type="radio"/> CZP	<input type="radio"/> SCS	<input type="radio"/> UST	<input type="radio"/> AST	<input type="radio"/> EXP	<input type="radio"/> EXT	Technical Clarification	Optional Enhanced Measures
7. Land Use: (Please circle/check one)	<input checked="" type="radio"/> Residential		Non-residential			8. Site (acres):		284.47	
9. Application Fee:	\$8,000		10. Permanent BMP(s):			N/A			
11. SCS (Linear Ft.):	N/A		12. AST/UST (No. Tanks):						
13. County:	Comal		14. Watershed:			Bear Creek			

Application Distribution

Instructions: Use the table below to determine the number of applications required. One original and one copy of the application, plus additional copies (as needed) for each affected incorporated city, county, and groundwater conservation district are required. Linear projects or large projects, which cross into multiple jurisdictions, can require additional copies. Refer to the “Texas Groundwater Conservation Districts within the EAPP Boundaries” map found at:

http://www.tceq.texas.gov/assets/public/compliance/field_ops/eapp/EAPP%20GWCD%20map.pdf

For more detailed boundaries, please contact the conservation district directly.

Austin Region			
County:	Hays	Travis	Williamson
Original (1 req.)	—	—	—
Region (1 req.)	—	—	—
County(ies)	—	—	—
Groundwater Conservation District(s)	<input type="checkbox"/> Edwards Aquifer Authority <input type="checkbox"/> Barton Springs/ Edwards Aquifer <input type="checkbox"/> Hays Trinity <input type="checkbox"/> Plum Creek	<input type="checkbox"/> Barton Springs/ Edwards Aquifer	NA
City(ies) Jurisdiction	<input type="checkbox"/> Austin <input type="checkbox"/> Buda <input type="checkbox"/> Dripping Springs <input type="checkbox"/> Kyle <input type="checkbox"/> Mountain City <input type="checkbox"/> San Marcos <input type="checkbox"/> Wimberley <input type="checkbox"/> Woodcreek	<input type="checkbox"/> Austin <input type="checkbox"/> Bee Cave <input type="checkbox"/> Pflugerville <input type="checkbox"/> Rollingwood <input type="checkbox"/> Round Rock <input type="checkbox"/> Sunset Valley <input type="checkbox"/> West Lake Hills	<input type="checkbox"/> Austin <input type="checkbox"/> Cedar Park <input type="checkbox"/> Florence <input type="checkbox"/> Georgetown <input type="checkbox"/> Jerrell <input type="checkbox"/> Leander <input type="checkbox"/> Liberty Hill <input type="checkbox"/> Pflugerville <input type="checkbox"/> Round Rock

San Antonio Region					
County:	Bexar	Comal	Kinney	Medina	Uvalde
Original (1 req.)	—	✓	—	—	—
Region (1 req.)	—	✓	—	—	—
County(ies)	—	✓	—	—	—
Groundwater Conservation District(s)	<input type="checkbox"/> Edwards Aquifer Authority <input type="checkbox"/> Trinity-Glen Rose	<input checked="" type="checkbox"/> Edwards Aquifer Authority	<input type="checkbox"/> Kinney	<input type="checkbox"/> EAA <input type="checkbox"/> Medina	<input type="checkbox"/> EAA <input type="checkbox"/> Uvalde
City(ies) Jurisdiction	<input type="checkbox"/> Castle Hills <input type="checkbox"/> Fair Oaks Ranch <input type="checkbox"/> Helotes <input type="checkbox"/> Hill Country Village <input type="checkbox"/> Hollywood Park <input type="checkbox"/> San Antonio (SAWS) <input type="checkbox"/> Shavano Park	<input type="checkbox"/> Bulverde <input type="checkbox"/> Fair Oaks Ranch <input type="checkbox"/> Garden Ridge <input checked="" type="checkbox"/> New Braunfels <input type="checkbox"/> Schertz	NA	<input type="checkbox"/> San Antonio ETJ (SAWS)	NA

I certify that to the best of my knowledge, that the application is complete and accurate. This application is hereby submitted to TCEQ for administrative review and technical review.

James Ingalls, P.E.

Print Name of Customer/Authorized Agent

James Ingalls
Signature of Customer/Authorized Agent

7-27-23
Date

FOR TCEQ INTERNAL USE ONLY			
Date(s) Reviewed:		Date Administratively Complete:	
Received From:		Correct Number of Copies:	
Received By:		Distribution Date:	
EAPP File Number:		Complex:	
Admin. Review(s) (No.):		No. AR Rounds:	
Delinquent Fees (Y/N):		Review Time Spent:	
Lat./Long. Verified:		SOS Customer Verification:	
Agent Authorization Complete/Notarized (Y/N):		Fee Check:	Payable to TCEQ (Y/N):
Core Data Form Complete (Y/N):			Signed (Y/N):
Core Data Form Incomplete Nos.:			Less than 90 days old (Y/N):

Contributing Zone Plan Application

Texas Commission on Environmental Quality

for Regulated Activities on the Contributing Zone to the Edwards Aquifer and Relating to 30 TAC §213.24(1), Effective June 1, 1999

To ensure that the application is administratively complete, confirm that all fields in the form are complete, verify that all requested information is provided, consistently reference the same site and contact person in all forms in the application, and ensure forms are signed by the appropriate party.

Note: Including all the information requested in the form and attachments contributes to more streamlined technical reviews.

Signature

To the best of my knowledge, the responses to this form accurately reflect all information requested concerning the proposed regulated activities and methods to protect the Edwards Aquifer. This **Contributing Zone Plan Application** is hereby submitted for TCEQ review and Executive Director approval. The application was prepared by:

Print Name of Customer/Agent James Ingalls, P.E.

Date: 7-27-23

Signature of Customer/Agent:

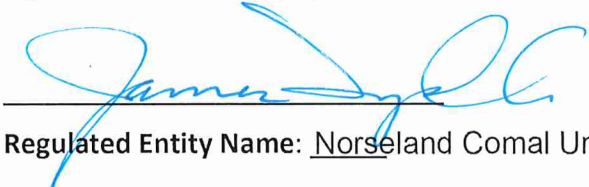

Regulated Entity Name: Norseland Comal Unit 1

Project Information

1. County: Comal
2. Stream Basin: Bear Creek
3. Groundwater Conservation District (if applicable): _____
4. Customer (Applicant):

Contact Person: Paul Mosvold

Entity: Norseland Comal, LLC

Mailing Address: 11777 Katy Freeway 300S

City, State: Houston, TX

Telephone: 281-433-9863

Email Address: pmosvold@scandrill.com

Zip: 77079

Fax: _____

5. Agent/Representative (If any):

Contact Person: James Ingalls, P.E.

Entity: INK Civil

Mailing Address: 2021 SH46 W, Suite 105

City, State: New Braunfels, TX

Zip: 78132

Telephone: 830-358-7127

Fax: _____

Email Address: jamesingalls@ink-civil.com

6. Project Location:

- The project site is located inside the city limits of _____.
- The project site is located outside the city limits but inside the ETJ (extra-territorial jurisdiction) of _____.
- The project site is not located within any city's limits or ETJ.

7. The location of the project site is described below. Sufficient detail and clarity has been provided so that the TCEQ's Regional staff can easily locate the project and site boundaries for a field investigation.

7200 FM 2722 New Braunfels, TX 78132

8. **Attachment A - Road Map.** A road map showing directions to and the location of the project site is attached. The map clearly shows the boundary of the project site.

9. **Attachment B - USGS Quadrangle Map.** A copy of the official 7 ½ minute USGS Quadrangle Map (Scale: 1" = 2000") is attached. The map(s) clearly show:

- Project site boundaries.
- USGS Quadrangle Name(s).

10. **Attachment C - Project Narrative.** A detailed narrative description of the proposed project is attached. The project description is consistent throughout the application and contains, at a minimum, the following details:

- Area of the site
- Offsite areas
- Impervious cover
- Permanent BMP(s)
- Proposed site use
- Site history
- Previous development
- Area(s) to be demolished

11. Existing project site conditions are noted below:

- Existing commercial site
- Existing industrial site
- Existing residential site

- Existing paved and/or unpaved roads
- Undeveloped (Cleared)
- Undeveloped (Undisturbed/Not cleared)
- Other: _____

12. The type of project is:

- Residential: # of Lots: 60
- Residential: # of Living Unit Equivalents: _____
- Commercial
- Industrial
- Other: _____

13. Total project area (size of site): 284.47 Acres

Total disturbed area: 60.4 Acres

14. Estimated projected population: 180

15. The amount and type of impervious cover expected after construction is complete is shown below:

Table 1 - Impervious Cover

<i>Impervious Cover of Proposed Project</i>	<i>Sq. Ft.</i>	<i>Sq. Ft./Acre</i>	<i>Acres</i>
Structures/Rooftops	10000 x 60 lots = 600,000	÷ 43,560 =	13.77
Parking	0	÷ 43,560 =	0
Other paved surfaces	339,416	÷ 43,560 =	7.79
Total Impervious Cover	939,416	÷ 43,560 =	21.56

Total Impervious Cover 21.56 ÷ Total Acreage 284.48 X 100 = 7.58 % Impervious Cover

16. **Attachment D - Factors Affecting Surface Water Quality.** A detailed description of all factors that could affect surface water quality is attached. If applicable, this includes the location and description of any discharge associated with industrial activity other than construction.

17. Only inert materials as defined by 30 TAC 330.2 will be used as fill material.

For Road Projects Only

Complete questions 18 - 23 if this application is exclusively for a road project.

N/A

18. Type of project:

- TXDOT road project.
- County road or roads built to county specifications.
- City thoroughfare or roads to be dedicated to a municipality.
- Street or road providing access to private driveways.

19. Type of pavement or road surface to be used:

- Concrete
- Asphaltic concrete pavement
- Other: _____

20. Right of Way (R.O.W.):

Length of R.O.W.: _____ feet.

Width of R.O.W.: _____ feet.

$L \times W = \text{_____ Ft}^2 \div 43,560 \text{ Ft}^2/\text{Acre} = \text{_____ acres.}$

21. Pavement Area:

Length of pavement area: _____ feet.

Width of pavement area: _____ feet.

$L \times W = \text{_____ Ft}^2 \div 43,560 \text{ Ft}^2/\text{Acre} = \text{_____ acres.}$

Pavement area _____ acres \div R.O.W. area _____ acres $\times 100 = \text{_____ \%}$ impervious cover.

22. A rest stop will be included in this project.

A rest stop will not be included in this project.

23. Maintenance and repair of existing roadways that do not require approval from the TCEQ Executive Director. Modifications to existing roadways such as widening roads/adding shoulders totaling more than one-half (1/2) the width of one (1) existing lane require prior approval from the TCEQ.

Stormwater to be generated by the Proposed Project

24. **Attachment E - Volume and Character of Stormwater.** A detailed description of the volume (quantity) and character (quality) of the stormwater runoff which is expected to occur from the proposed project is attached. The estimates of stormwater runoff quality and quantity are based on area and type of impervious cover. Include the runoff coefficient of the site for both pre-construction and post-construction conditions.

Wastewater to be generated by the Proposed Project

25. Wastewater is to be discharged in the contributing zone. Requirements under 30 TAC §213.6(c) relating to Wastewater Treatment and Disposal Systems have been satisfied.

N/A

26. Wastewater will be disposed of by:

On-Site Sewage Facility (OSSF/Septic Tank):

Attachment F - Suitability Letter from Authorized Agent. An on-site sewage facility will be used to treat and dispose of the wastewater from this site. The appropriate licensing authority's (authorized agent) written approval is attached. It states that the land is suitable for the use of private sewage facilities and will meet or exceed the requirements for on-site sewage facilities as specified under 30 TAC Chapter 285 relating to On-site Sewage Facilities.

Each lot in this project/development is at least one (1) acre (43,560 square feet) in size. The system will be designed by a licensed professional engineer or registered sanitarian and installed by a licensed installer in compliance with 30 TAC Chapter 285.

Sewage Collection System (Sewer Lines):

The sewage collection system will convey the wastewater to the _____ (name) Treatment Plant. The treatment facility is:

- Existing.
- Proposed.

N/A

Permanent Aboveground Storage Tanks(ASTs) ≥ 500 Gallons

Complete questions 27 - 33 if this project includes the installation of AST(s) with volume(s) greater than or equal to 500 gallons.

N/A

27. Tanks and substance stored:

Table 2 - Tanks and Substance Storage

<i>AST Number</i>	<i>Size (Gallons)</i>	<i>Substance to be Stored</i>	<i>Tank Material</i>
1			
2			
3			
4			
5			

Total x 1.5 = _____ Gallons

28. The AST will be placed within a containment structure that is sized to capture one and one-half (1 1/2) times the storage capacity of the system. For facilities with more than

one tank system, the containment structure is sized to capture one and one-half (1 1/2) times the cumulative storage capacity of all systems.

- Attachment G - Alternative Secondary Containment Methods.** Alternative methods for providing secondary containment are proposed. Specifications showing equivalent protection for the Edwards Aquifer are attached.

29. Inside dimensions and capacity of containment structure(s):

Table 3 - Secondary Containment

<i>Length (L)(Ft.)</i>	<i>Width(W)(Ft.)</i>	<i>Height (H)(Ft.)</i>	<i>L x W x H = (Ft3)</i>	<i>Gallons</i>

Total: _____ Gallons

30. Piping:

- All piping, hoses, and dispensers will be located inside the containment structure.
- Some of the piping to dispensers or equipment will extend outside the containment structure.
- The piping will be aboveground
- The piping will be underground

31. The containment area must be constructed of and in a material impervious to the substance(s) being stored. The proposed containment structure will be constructed of: _____.

32. **Attachment H - AST Containment Structure Drawings.** A scaled drawing of the containment structure is attached that shows the following:

- Interior dimensions (length, width, depth and wall and floor thickness).
- Internal drainage to a point convenient for the collection of any spillage.
- Tanks clearly labeled
- Piping clearly labeled
- Dispenser clearly labeled

33. Any spills must be directed to a point convenient for collection and recovery. Spills from storage tank facilities must be removed from the controlled drainage area for disposal within 24 hours of the spill.

- In the event of a spill, any spillage will be removed from the containment structure within 24 hours of the spill and disposed of properly.

- In the event of a spill, any spillage will be drained from the containment structure through a drain and valve within 24 hours of the spill and disposed of properly. The drain and valve system are shown in detail on the scaled drawing.

Site Plan Requirements

Items 34 - 46 must be included on the Site Plan.

34. The Site Plan must have a minimum scale of 1" = 400'.
Site Plan Scale: 1" = 300'.
35. 100-year floodplain boundaries:
- Some part(s) of the project site is located within the 100-year floodplain. The floodplain is shown and labeled.
- No part of the project site is located within the 100-year floodplain.
The 100-year floodplain boundaries are based on the following specific (including date of material) sources(s): FEMA.FIRMETTE: 48091C0255F, effective date Sept. 2, 2009
36. The layout of the development is shown with existing and finished contours at appropriate, but not greater than ten-foot contour intervals. Lots, recreation centers, buildings, roads, etc. are shown on the site plan.
- The layout of the development is shown with existing contours at appropriate, but not greater than ten-foot contour intervals. Finished topographic contours will not differ from the existing topographic configuration and are not shown. Lots, recreation centers, buildings, roads, etc. are shown on the site plan.
37. A drainage plan showing all paths of drainage from the site to surface streams.
38. The drainage patterns and approximate slopes anticipated after major grading activities.
39. Areas of soil disturbance and areas which will not be disturbed.
40. Locations of major structural and nonstructural controls. These are the temporary and permanent best management practices.
41. Locations where soil stabilization practices are expected to occur.
42. Surface waters (including wetlands).
 N/A
43. Locations where stormwater discharges to surface water.
 There will be no discharges to surface water.
44. Temporary aboveground storage tank facilities.
 Temporary aboveground storage tank facilities will not be located on this site.

45. Permanent aboveground storage tank facilities.
 Permanent aboveground storage tank facilities will not be located on this site.
46. Legal boundaries of the site are shown.

Permanent Best Management Practices (BMPs)

Practices and measures that will be used during and after construction is completed.

47. Permanent BMPs and measures must be implemented to control the discharge of pollution from regulated activities after the completion of construction.
 N/A
48. These practices and measures have been designed, and will be constructed, operated, and maintained to insure that 80% of the incremental increase in the annual mass loading of total suspended solids (TSS) from the site caused by the regulated activity is removed. These quantities have been calculated in accordance with technical guidance prepared or accepted by the executive director.
 The TCEQ Technical Guidance Manual (TGM) was used to design permanent BMPs and measures for this site.
 A technical guidance other than the TCEQ TGM was used to design permanent BMPs and measures for this site. The complete citation for the technical guidance that was used is: _____.
 N/A
49. Owners must insure that permanent BMPs and measures are constructed and function as designed. A Texas Licensed Professional Engineer must certify in writing that the permanent BMPs or measures were constructed as designed. The certification letter must be submitted to the appropriate regional office within 30 days of site completion.
 N/A
50. Where a site is used for low density single-family residential development and has 20 % or less impervious cover, other permanent BMPs are not required. This exemption from permanent BMPs must be recorded in the county deed records, with a notice that if the percent impervious cover increases above 20% or land use changes, the exemption for the whole site as described in the property boundaries required by 30 TAC §213.4(g) (relating to Application Processing and Approval), may no longer apply and the property owner must notify the appropriate regional office of these changes.
 The site will be used for low density single-family residential development and has 20% or less impervious cover.
 The site will be used for low density single-family residential development but has more than 20% impervious cover.
 The site will not be used for low density single-family residential development.

51. The executive director may waive the requirement for other permanent BMPs for multi-family residential developments, schools, or small business sites where 20% or less impervious cover is used at the site. This exemption from permanent BMPs must be recorded in the county deed records, with a notice that if the percent impervious cover increases above 20% or land use changes, the exemption for the whole site as described in the property boundaries required by 30 TAC §213.4(g) (relating to Application Processing and Approval), may no longer apply and the property owner must notify the appropriate regional office of these changes.

- Attachment I - 20% or Less Impervious Cover Waiver.** The site will be used for multi-family residential developments, schools, or small business sites and has 20% or less impervious cover. A request to waive the requirements for other permanent BMPs and measures is attached.
- The site will be used for multi-family residential developments, schools, or small business sites but has more than 20% impervious cover.
- The site will not be used for multi-family residential developments, schools, or small business sites.

52. **Attachment J - BMPs for Upgradient Stormwater.**

- A description of the BMPs and measures that will be used to prevent pollution of surface water, groundwater, or stormwater that originates upgradient from the site and flows across the site is attached.
- No surface water, groundwater or stormwater originates upgradient from the site and flows across the site, and an explanation is attached.
- Permanent BMPs or measures are not required to prevent pollution of surface water, groundwater, or stormwater that originates upgradient from the site and flows across the site, and an explanation is attached.

53. **Attachment K - BMPs for On-site Stormwater.**

- A description of the BMPs and measures that will be used to prevent pollution of surface water or groundwater that originates on-site or flows off the site, including pollution caused by contaminated stormwater runoff from the site is attached.
- Permanent BMPs or measures are not required to prevent pollution of surface water or groundwater that originates on-site or flows off the site, including pollution caused by contaminated stormwater runoff, and an explanation is attached.

54. **Attachment L - BMPs for Surface Streams.** A description of the BMPs and measures that prevent pollutants from entering surface streams is attached.

N/A

55. **Attachment M - Construction Plans.** Construction plans and design calculations for the proposed permanent BMPs and measures have been prepared by or under the direct supervision of a Texas Licensed Professional Engineer, and are signed, sealed, and dated. Construction plans for the proposed permanent BMPs and measures are

attached and include: Design calculations, TCEQ Construction Notes, all proposed structural plans and specifications, and appropriate details.

N/A

56. **Attachment N - Inspection, Maintenance, Repair and Retrofit Plan.** A site and BMP specific plan for the inspection, maintenance, repair, and, if necessary, retrofit of the permanent BMPs and measures is attached. The plan fulfills all of the following:

- Prepared and certified by the engineer designing the permanent BMPs and measures
- Signed by the owner or responsible party
- Outlines specific procedures for documenting inspections, maintenance, repairs, and, if necessary, retrofit.
- Contains a discussion of record keeping procedures

N/A

57. **Attachment O - Pilot-Scale Field Testing Plan.** Pilot studies for BMPs that are not recognized by the Executive Director require prior approval from the TCEQ. A plan for pilot-scale field testing is attached.

N/A

58. **Attachment P - Measures for Minimizing Surface Stream Contamination.** A description of the measures that will be used to avoid or minimize surface stream contamination and changes in the way in which water enters a stream as a result of the construction and development is attached. The measures address increased stream flashing, the creation of stronger flows and in-stream velocities, and other in-stream effects caused by the regulated activity, which increase erosion that result in water quality degradation.

N/A

Responsibility for Maintenance of Permanent BMPs and Measures after Construction is Complete.

59. The applicant is responsible for maintaining the permanent BMPs after construction until such time as the maintenance obligation is either assumed in writing by another entity having ownership or control of the property (such as without limitation, an owner's association, a new property owner or lessee, a district, or municipality) or the ownership of the property is transferred to the entity. Such entity shall then be responsible for maintenance until another entity assumes such obligations in writing or ownership is transferred.
60. A copy of the transfer of responsibility must be filed with the executive director at the appropriate regional office within 30 days of the transfer if the site is for use as a multiple single-family residential development, a multi-family residential development,

or a non-residential development such as commercial, industrial, institutional, schools, and other sites where regulated activities occur.

Administrative Information

- 61. Submit one (1) original and one (1) copy of the application, plus additional copies as needed for each affected incorporated city, groundwater conservation district, and county in which the project will be located. The TCEQ will distribute the additional copies to these jurisdictions.
- 62. Any modification of this Contributing Zone Plan may require TCEQ review and Executive Director approval prior to construction, and may require submission of a revised application, with appropriate fees.
- 63. The site description, controls, maintenance, and inspection requirements for the storm water pollution prevention plan (SWPPP) developed under the EPA NPDES general permits for stormwater discharges have been submitted to fulfill paragraphs 30 TAC §213.24(1-5) of the technical report. All requirements of 30 TAC §213.24(1-5) have been met by the SWPPP document.
 - The Temporary Stormwater Section (TCEQ-0602) is included with the application.

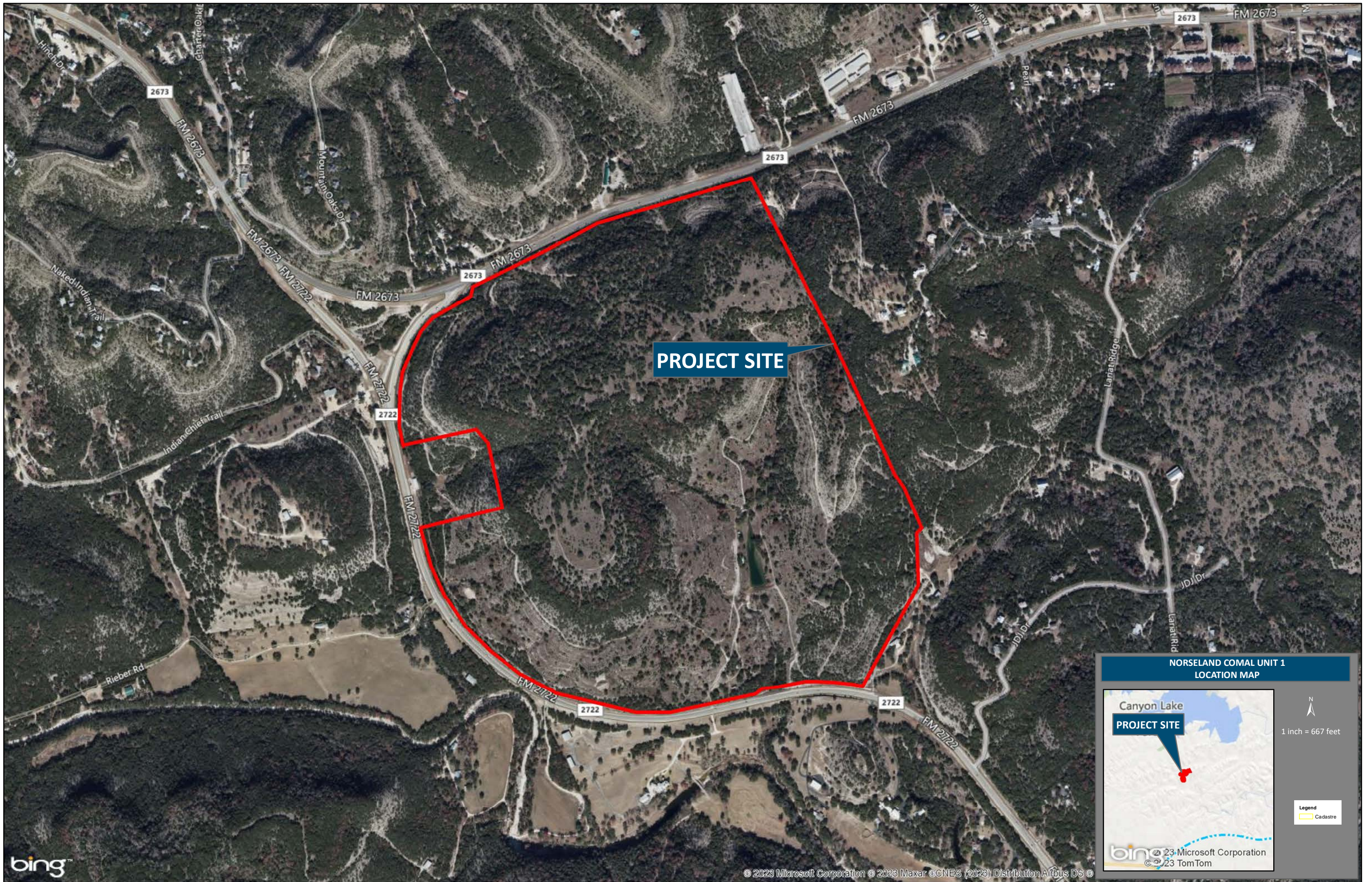

PROJECT SITE

**NORSELAND COMAL UNIT 1
LOCATION MAP**

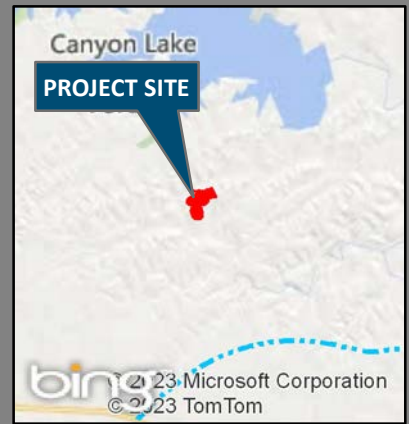

1 inch = 667 feet

Legend
Cadastral



U.S. DEPARTMENT OF THE INTERIOR
U.S. GEOLOGICAL SURVEY



SATTLER QUADRANGLE
TEXAS - COMAL COUNTY
7.5-MINUTE SERIES

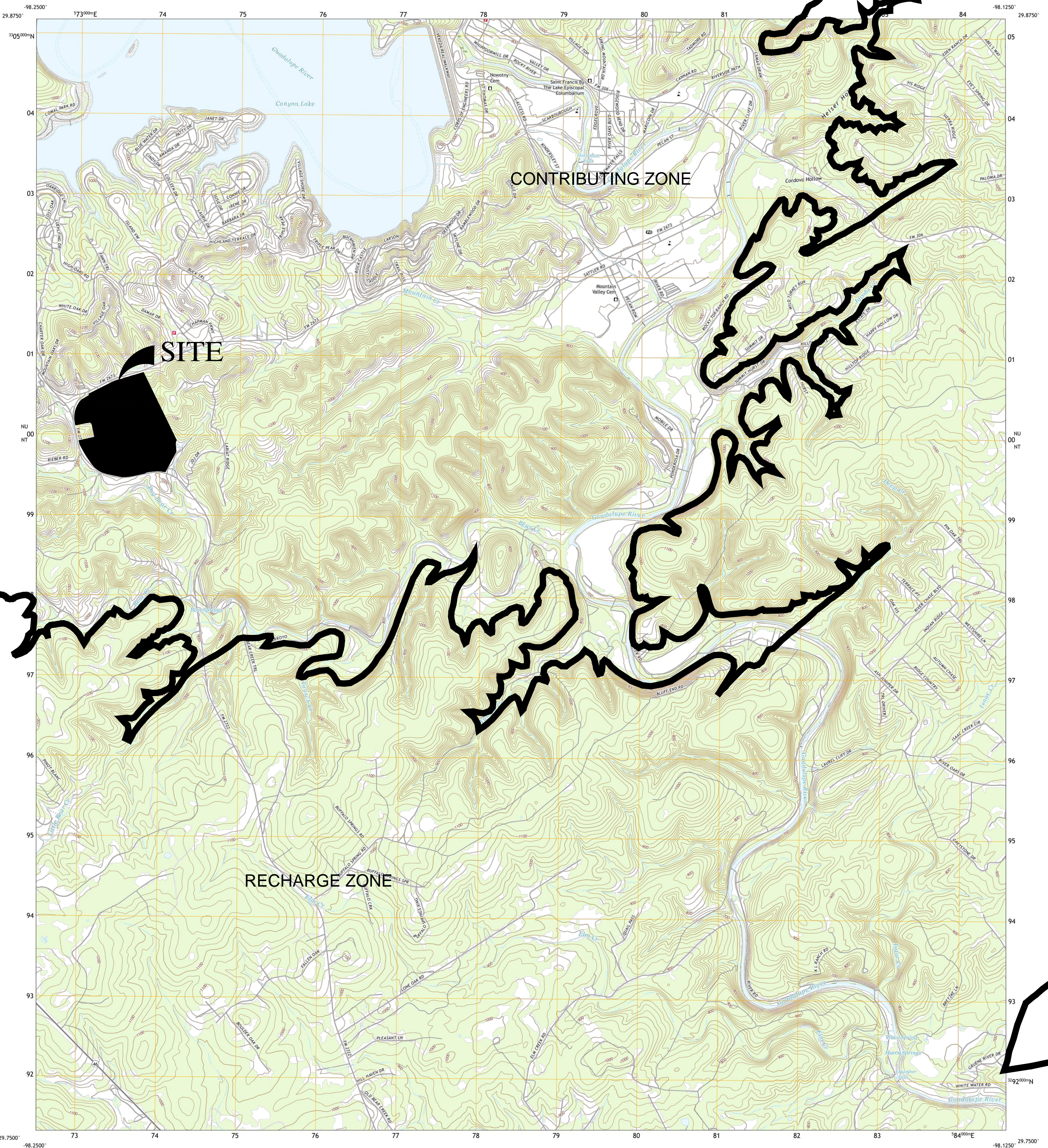

Produced by the United States Geological Survey
North American Datum of 1983 (NAD83)
World Geodetic System of 1984 (WGS84). Projection and
1 000-meter grid/Universal Transverse Mercator, Zone 14R
This map is not a legal document. Boundaries may be
generalized for this map scale. Private lands within government
reservations may not be shown. Obtain permission before
entering private lands.

Imagery.....NAIP, September 2016 - November 2016
Roads.....U.S. Census Bureau, 2015 - 2019
Names.....GNIS, 1979 - 2016
Hydrography.....National Hydrography Dataset, 2002 - 2018
Contours.....National Elevation Dataset, 2021
Boundaries.....Multiple sources; see metadata file 2019 - 2021
Wetlands.....FWS National Wetlands Inventory Not Available

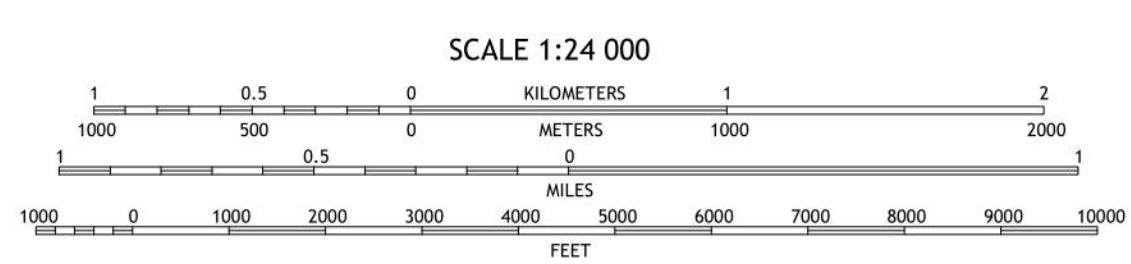
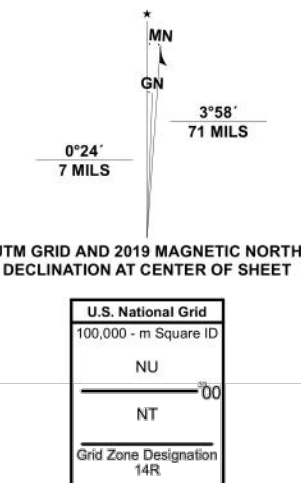

QUADRANGLE LOCATION

1	2	3
4	5	6
7	8	

ADJOINING QUADRANGLES

ROAD CLASSIFICATION

- Expressway
- Secondary Hwy
- Ramp
- Local Connector
- Local Road
- 4WD
- US Route
- State Route

1 Fischer
2 Devils Backbone
3 Wimberley
4 Smithson Valley
5 Hunter
6 Bat Cave
7 New Braunfels West
8 New Braunfels East

SATTLER, TX
2022



ATTACHMENT “C”
Project Description

The proposed Norseland Comal Unit 1 is located at 7200 FM 2722, New Braunfels, Texas 78132 in Comal County. The site consists of a 284.47-acre tract, mostly undeveloped land with a single residential homestead. This property is not located within any surrounding City or ETJ. According to the Flood Insurance Rate Map No. 48091C0435F, there is no existing floodplain located within the property. The stream basin for stormwater runoff is the Dry Bear Creek.

The development will consist of 60 single family residential lots. Subdivision infrastructure will include water distribution lines, electricity, telephone, cable television and approximately 12,122 linear feet of roadway. Each resident will be responsible for their own private sanitary sewer collection system. Several detention ponds are proposed to minimize the increase in stormwater runoff generated by this development. The projected total area of impervious cover for the site will be 21.56 acres (7.58 %). Total impervious cover was calculated using an estimated area of 10,000 square feet per lot. This estimation is greater than the value referenced in Table 3-2 of the TCEQ Technical Guidance manual for 1-acre lots, and therefore the estimation is more conservative. The impervious cover from the roadways was then added to this figure. The area of disturbance for the construction of the site will be 30.5-acres for roads and 7.64-acres for detention ponds. Lots will be sold to individuals only, and homes built at random times. No permanent BMPs are proposed for this development. Temporary BMPs will be implemented for the construction of roads and homes.

ATTACHMENT “D”
Factors Affecting Surface Water Quality

Some pollution may occur due to automobile waste, cleaning chemicals, and improperly disposed of waste or litter from the residents, which may have an effect on surface water by sediments leaving the site after a rainfall event.

ATTACHMENT “E”
Volume and Character of Stormwater

The development of the site will not result in an increase of stormwater run-off. Stormwater from the development will be captured in various detention ponds within the site. A summary table is included below showing the 100-yr storm event and curve numbers used for existing and proposed conditions for the various drainage basins on the site.

Flow & CN Summary		
Point	CN	Q₁₀₀ (cfs)
EX-A	77	40.92
PRO-A	82	38.82
EX-B	77	114.53
PRO-B	83	106.35
EX-C	77	108.89
PRO-C	83	83.77
EX-D	77	59.67
PRO-D	83	57.57
EX-E	77	107.22
PRO-E	84	105.28
EX-F	77	100.82
PRO-F	81	99.05
EX-G	77	922.45
PRO-G	80	853.66

ATTACHMENT “F”
Suitability Letter from Authorized Agent

Please see attached from Comal County Engineers Office



COMAL COUNTY

ENGINEER'S OFFICE

April 27, 2023

Mr. Chad Friesenhahn, E.I.T.
INK Civil
2021 SH 45W, Suite 105
New Braunfels, TX 78132

Re: Watercolours Unit 1 Suitability Letter within Comal County Texas

Dear Mr. Friesenhahn:

In accordance with TAC §213.24(8)(B), Comal County has found that the entire referenced site is suitable for the use of private sewage facilities and will meet the requirements for on-site sewage facilities.

If you have any questions or need additional information, please contact our office.

Sincerely,

Robert Boyd, P.E.
Comal County Assistant Engineer

cc: Donna Eccleston, Comal County Commissioner, Precinct No. 1



COMAL COUNTY
ENGINEER'S OFFICE

April 18, 2023

Greg Johnson, P.E.
via e-mail: gregjohnsonpe@yahoo.com

Re: Watercolors Unit 1 Subdivision, within Comal County Texas
Permit 2023-100005

Dear Mr. Johnson:

We are in receipt of your April 18, 2023 application for the referenced proposed subdivision. We approved your application (see attached).

If you have any questions or need additional information, please contact our office.

Sincerely,

A handwritten signature in blue ink, appearing to read 'Robert Boyd', is written over a light blue circular stamp.

Robert Boyd, P.E.
Comal County Assistant Engineer

cc: Donna Eccleston, Comal County Commissioner, Precinct No. 1

**Application for Licensing Authority Recommendation
for Private Sewerage Facilities for a Proposed Subdivision**

Date: MARCH 31, 2023

Fee Schedule:

5 or less tracts: \$20/tract

6 or more tracts: \$100 base fee + \$5/tract

Subdivision Name: WATERCOLOURS, UNIT 1

Total Fee: \$ 400

Owner's Name: WATERCOLOURS TEXAS, LLC

Received by: Kg

Address: c/o 2021 SH48W, SUITE 105, NEW BRAUNFELS, TX 78132

Phone #: 830-358-7127

Make Check Payable to Comal County

According to TAC §285.4(c), persons proposing residential subdivisions, manufactured housing communities, multi-unit residential developments, business parks, or other similar structures that use OSSFs for sewage disposal shall submit planning materials, prepared by a professional engineer or professional sanitarian, for these developments to the permitting authority and receive approval prior to submitting an OSSF application:

- An overall site plan
- Topographic map
- 100-year floodplain map
- Soil survey
- Location of water wells
- Locations of easements as identified in TAC §285.91(10) (relating to Tables)
- A complete report detailing the types of OSSFs to be considered and their compatibility with area-wide drainage and groundwater
- A comprehensive drainage plan
- Edwards Aquifer requirements that are pertinent to the proposed OSSF
- If the proposed development includes restaurants or buildings with food service establishments, the planning materials must show adequate land area for doubling the land needed for the treatment units

Comal County also asks for an existing improvements sketch and gate combination(s) in order to adequately inspect the site for use of OSSFs for sewage disposal.



Applicant/Agent Signature

Date of Review (must be within 45 days of receipt): 4/18/23

Approved

Denied

Reason(s) for Denial: _____

Reviewer:  . D.R.

*** Note: This sheet shall be first with all planning materials listed above following behind.**

Greg W. Johnson, P.E.

170 Hollow Oak
New Braunfels, Texas 78132
830/905-2778

March 27, 2023

Melanie Norris
INK CIVIL
2021 SH 46W, SUITE 105
New Braunfels, Texas 78132

RE: Soil Survey & OSSF compatibility
Watercolours, Unit 1, being 60 residential lots
being 97.2 acres out of Rusk Trans Co. S#805, A-510, & H. Luehlfing S#804, A939, &
J.P Preusser S-538, Aa-479, Jos. Preusser S- 671, A-468 A Arnold S#806, A-931,
&The J. Rohde, S806, A847
Comal County, Texas

TYPE SOILS AND DRAINAGE

This location was surveyed for soil types and their compatibility with development and installation of septic systems. Tested soils have a moderate clay content and are a part of the Comfort-Rock outcrop complex 1-8% slopes (CrD) moderately well drained with this soil profile consists of a stoney, brown to to light brown clay loam with medium blocky structure to 4"-12" over massive limestone. A small portion contains soils of the Brackett Rock outcrop - Real Complex 8-30% slopes moderate well drained with a soil profile consisting of stoney brown clay loam soils with blocky structure to 6"-14" over limestone.

OSSF TYPES

Since the site has shallow to moderate depth soils with a moderate clay content with fair to poor soil absorption characteristics, a variety of septic systems are suitable depending on each lot. Recommended On Site Sewage Facilities (OSSF) for this site are aerobic treatment plants with spray or drip irrigation, or mounded low pressure dosing fields. Adequate space is available for any of the referenced OSSF's and their respective replacement areas.

Property will be served with public water and service to each lot must be routed in such a way to provide a minimum of 10' separation from any part of each OSSF.

Respectfully yours,

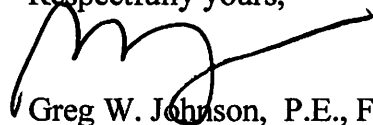
Greg W. Johnson, P.E., F#2585



OSSF Sizing

Water usage and field requirements:

3 Bedroom Residence $Q = 240$ GPD

4 Bedroom Residence $Q = 300$ GPD

5 Bedroom Residence $Q = 360$ GPD

Aerobic Treatment Plant (Spray Irrigation)

$$A = Q / R_i \quad R_i = 0.064 \text{ g/sf}$$

$$3 \text{ BR} \quad A = 240/0.064 = 3750 \text{ sf.}$$

$$4 \text{ BR} \quad A = 300/0.064 = 4688 \text{ sf.}$$

$$5 \text{ BR} \quad A = 360/0.064 = 5625 \text{ sf.}$$

Drip Irrigation and Low Pressure Dosing

$$A = Q/R_a \quad R_a = 0.2 \text{ g/sf (Type III Soil)}$$

$$3 \text{ BR} \quad A = 240/0.2 = 1200 \text{ sf.}$$

$$4 \text{ BR} \quad A = 300/0.2 = 1500 \text{ sf.}$$

$$5 \text{ BR} \quad A = 360/0.2 = 1800 \text{ sf.}$$

ON-SITE SEWERAGE FACILITY SOIL EVALUATION REPORT INFORMATION

Date Soil Survey Performed: March 26, 2023

Site Location: WATERCOLOURS UNIT 1, FM 2673 & FM 2722

Proposed Excavation Depth: N/A

Requirements:

At least two soil excavations must be performed on the site, at opposite ends of the proposed disposal area. Locations of soil boring or dug pits must be shown on the site drawing. For subsurface disposal, soil evaluations must be performed to a depth of at least two feet below the proposed excavation depth. For surface disposal, the surface horizon must be evaluated. Describe each soil horizon and identify any restrictive features on the form. Indicate depths where features appear.

SOIL BORING NUMBER <u>1-5</u>						
Depth (Feet)	Texture Class	Soil Texture	Gravel Analysis	Drainage (Mottles/ Water Table)	Restrictive Horizon	Observations
0	III	CLAY LOAM	N/A	NONE OBSERVED	LIMESTONE 4"-14	BROWN STONEY
1						
2						
3						
4						
5						

SOIL BORING NUMBER <u>6-10</u>						
Depth (Feet)	Texture Class	Soil Texture	Gravel Analysis	Drainage (Mottles/ Water Table)	Restrictive Horizon	Observations
0	SAME	AS	ABOVE			
1						
2						
3						
4						
5						

I certify that the findings of this report are based on my field observations and are accurate to the best of my ability.

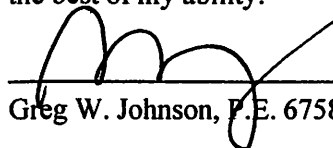

 Greg W. Johnson, P.E. 67587-F2585, S.E. 11561

03/26/2023

 Date

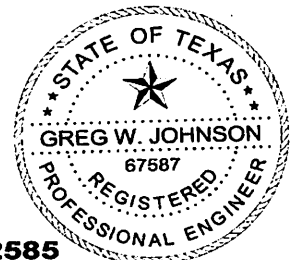

FIRM #2585

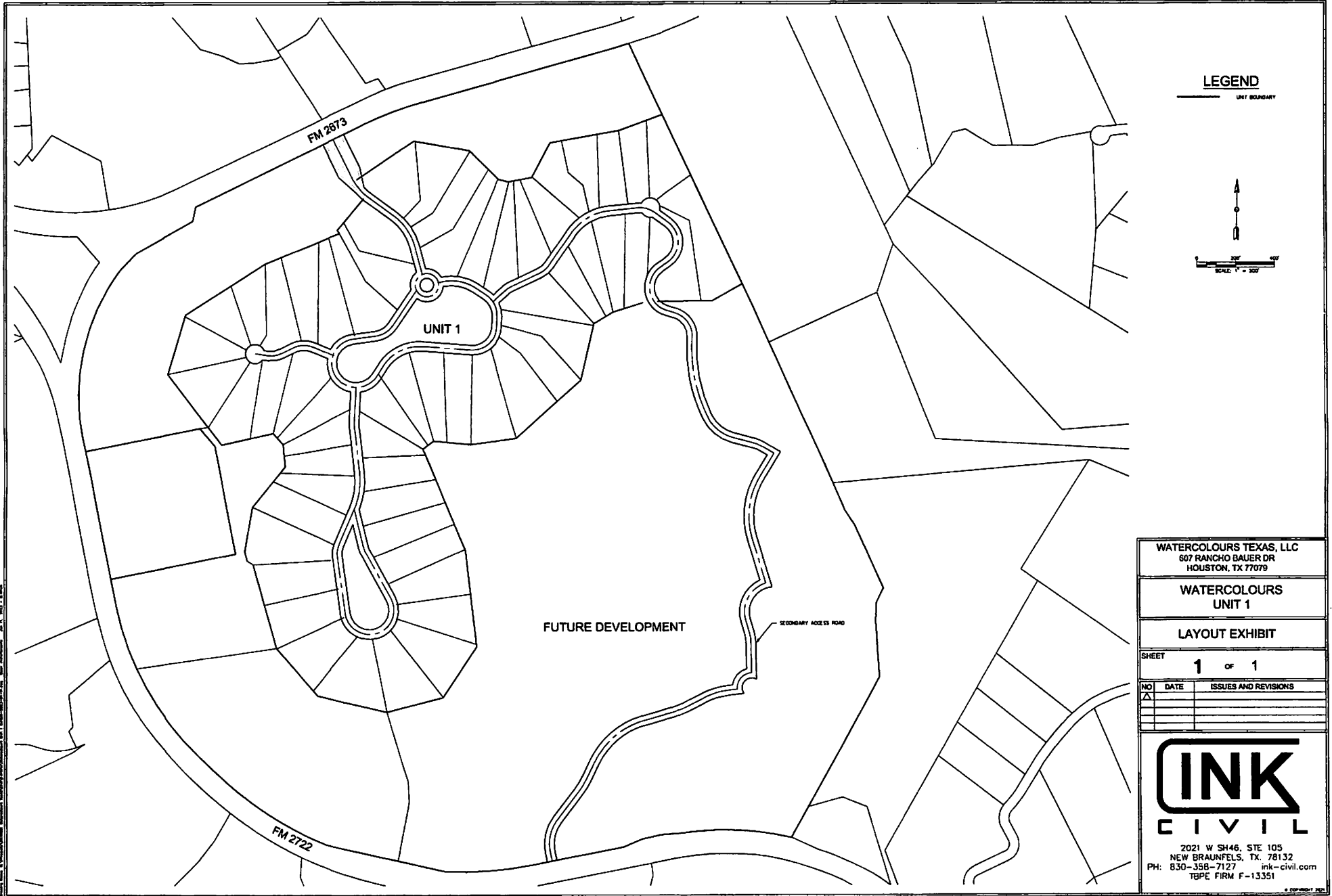

LEGEND

UNIT BOUNDARY

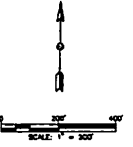

WATERCOLOURS TEXAS, LLC
607 RANCHO BAUER DR
HOUSTON, TX 77079

WATERCOLOURS
UNIT 1

LAYOUT EXHIBIT

SHEET
1 of 1

NO	DATE	ISSUES AND REVISIONS
1		



2021 W SH46, STE 105
NEW BRAUNFELS, TX, 78132
PH: 830-358-7127 ink-civil.com
TBPE FIRM F-13351

ATTACHMENT “G”
Alternative Secondary Containment Methods

Not Applicable

ATTACHMENT “H”
AST Containment Structure Drawings

Not Applicable

ATTACHMENT “I”
20% or Less Impervious Cover Waiver

Not Applicable

ATTACHMENT “J”
BMPs for Upgradient Stormwater

No upgradient stormwater is introduced to the site. The site is located at the top of a hill. No permanent BMPs are required for the site.

ATTACHMENT “K”
BMPs for Onsite Stormwater

No BMPs are required for onsite stormwater. The site will be minimally disturbed.

ATTACHMENT “L”
BMPs for Surface Streams

No surface streams are located near the site.

SEQUENCE OF CONSTRUCTION:

- OBTAIN CITY APPROVED SITE PREPARATION PLANS, AND TPDES PERMIT (NOT A COPY OF THE TPDES APPLICATION TO TCEQ), IF APPLICABLE.
- INSTALL TEMPORARY EROSION AND SEDIMENTATION CONTROLS.
- BEGIN DEMOLITION ACTIVITIES, IF APPLICABLE.
- BEGIN SITE CLEARING AND GRADING.
- RESTORE AND REVEGETATE ALL DISTURBED AREAS NOT UNDER IMPERMEABLE IMPROVEMENTS.
- COMPLETE ANY REMAINING "PUNCH LIST" ITEMS.
- CONTRACTOR SHALL REMOVE TEMPORARY EROSION CONTROLS AFTER PERMANENT STABILIZATION IS AT LEAST 70% EVENLY ESTABLISHED. RYE IS NOT ACCEPTED. THE SITE WILL BE PERMANENTLY STABILIZED WHEN ALL IMPROVEMENTS ARE CONSTRUCTED PER THE DESIGN PLANS WHICH INCLUDES PAVEMENT, BUILDING, AND OTHER LANDSCAPE IMPROVEMENTS PER LANDSCAPE PLANS. ALL PVIOUS SURFACES TO BE SOE OR OTHER PERVIOUS IMPROVEMENTS PER LANDSCAPE PLAN.

SOIL STABILIZATION NOTE

PER TPDES REQUIREMENTS, DISTURBED AREAS ON WHICH CONSTRUCTION ACTIVITIES HAVE CEASED (TEMPORARILY OR PERMANENTLY) SHALL BE STABILIZED WITHIN 14 DAYS UNLESS ACTIVITY RESUMES WITHIN 21 DAYS. SEEDING DOES NOT CONSTITUTE AS STABILIZATION.

SUBSTANTIAL GRADING IS PROPOSED WITH THIS UNIT. PER THE NEW BRAUNFELS DRAINAGE AND EROSION CONTROL DESIGN MANUAL SEC. 13.2(N), STRIPPING OF VEGETATION FROM PROJECT SITES SHALL BE PHASED SO AS TO EXPOSE THE MINIMUM AMOUNT OF AREA TO SOIL EROSION FOR THE SHORTEST POSSIBLE TIME.

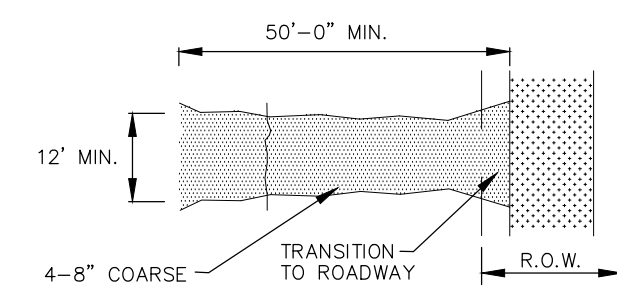

PLAN VIEW

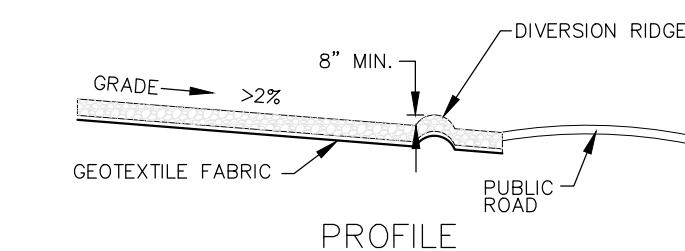

PROFILE

STABILIZED CONSTRUCTION ENTRANCE / EXIT

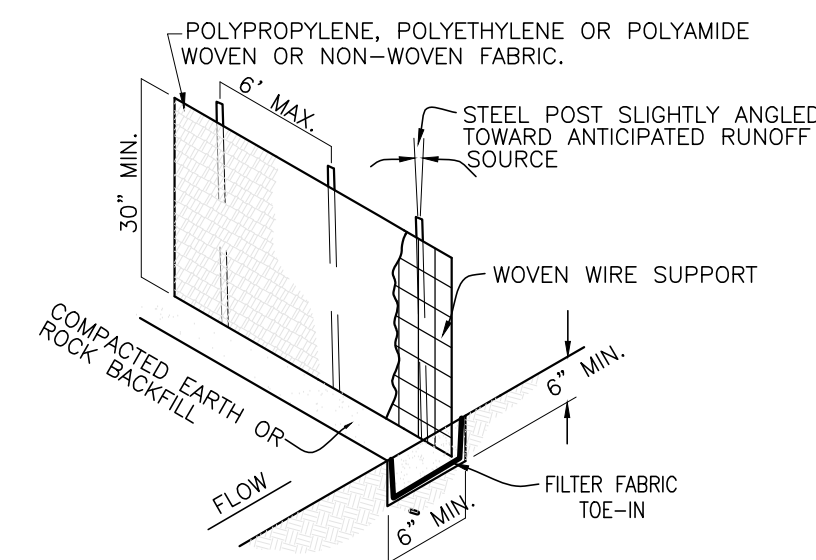

SILT FENCE

Materials:

- Silt fence material should be polypropylene, polyethylene or polyamide woven or nonwoven fabric. The fabric width should be 36 inches, with a minimum unit weight of 4.5 oz/yd, mullen burst strength exceeding 190 lb/in², ultraviolet stability exceeding 70%, and minimum apparent opening size of U.S. Sieve No. 30.
- Fence posts should be made of hot rolled steel, at least 4 feet long with Tee or Ybar cross section, surface painted or galvanized, minimum nominal weight 1.25 lb/ft², and Brindell hardness exceeding 140.
- Woven wire backing to support the fabric should be galvanized 2" x 4" welded wire, 12 gauge minimum.

Installation:

- Steel posts, which support the silt fence, should be installed on a slight angle toward the anticipated runoff source. Post must be embedded a minimum of 1-foot deep and spaced not more than 8 feet on center. Where water concentrates, the maximum spacing should be 6 feet.
- Lay out fencing down-slope of disturbed area, following the contour as closely as possible. The fence should be sited so that the maximum drainage area is 1/4 acre/100 feet of fence.
- The toe of the silt fence should be trenched in with a spade or mechanical trencher, so that the down-slope face of the trench is flat and perpendicular to the line of flow. Where fence cannot be trenched in (e.g., pavement or rock outcrop), weight fabric flap with 3 inches of pea gravel on uphill side to prevent flow from seeping under fence.
- The trench must be a minimum of 6 inches deep and 6 inches wide to allow for the silt fence fabric to be laid in the ground and backfilled with compacted material.
- Silt fence should be securely fastened to each steel support post or to woven wire, which is in turn attached to the steel fence post. There should be a 3-foot overlap, securely fastened where ends of fabric meet.
- Silt fence should be removed when the site is completely stabilized so as not to block or impede storm flow or drainage.

Inspection and Maintenance Guidelines:

- Inspect all fencing weekly, and after any rainfall.
- Remove sediment when buildup reaches 6 inches.
- Replace any torn fabric or install a second line of fencing parallel to the torn section.
- Replace or repair any sections crushed or collapsed in the course of construction activity. If a section of fence is obstructing vehicular access, consider relocating it to a spot where it will provide equal protection, but will not obstruct vehicles. A triangular filter dike may be preferable to a silt fence at common vehicle access points.
- When construction is complete, the sediment should be disposed of in a manner that will not cause additional siltation and the prior location of the silt fence should be revegetated. The fence itself should be disposed of in an approved landfill.

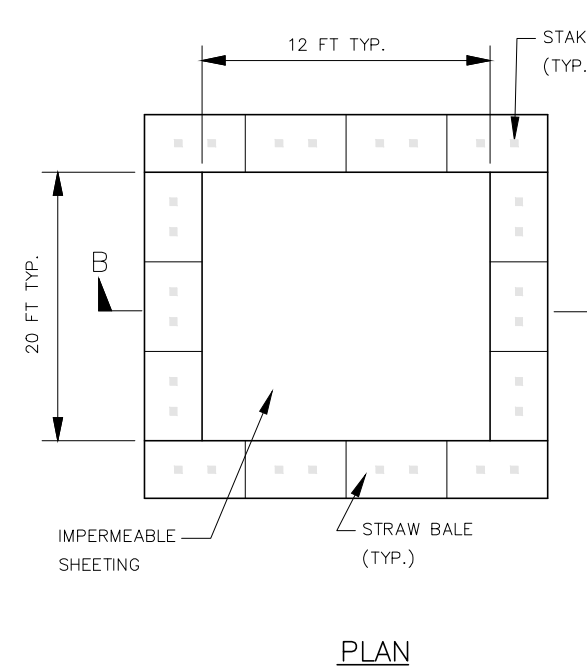

PLAN

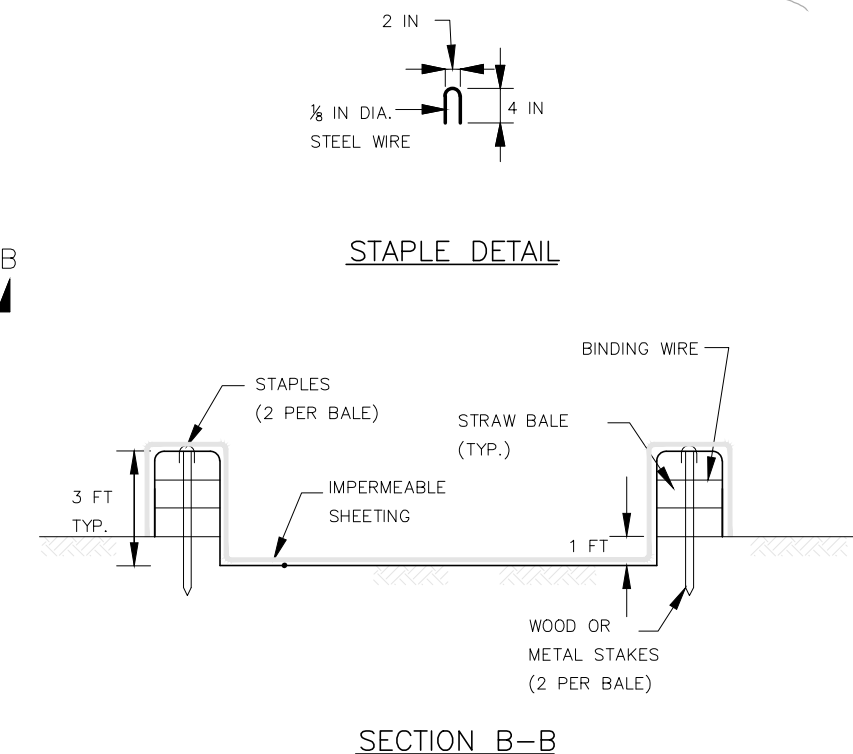

SECTION B-B

TYPICAL CONCRETE TRUCK WASHOUT PIT

PROPOSED CONDITIONS

SCALE: 1"=200'

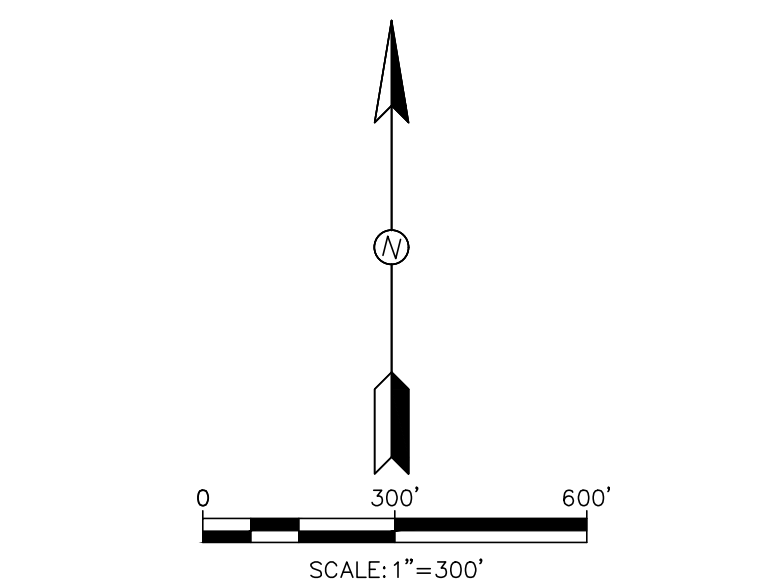

LEGEND

- LIMITS OF DRAINAGE AREA
- EXISTING CONTOURS
- PROPOSED CONTOURS
- FLOW ARROWS
- DRAINAGE BASIN LABEL
- BASIN AREA (AC)
- DISTURBED SOIL
- STABILIZED CONSTRUCTION ENTRANCE/EXIT
- TRUCK WASH OUT PIT
- CONSTRUCTION STAGING AREA
- ROCK BERM



NORSELAND COMAL LLC
11777 KATY FREEWAY 300S
HOUSTON, TX 77079

NORSELAND COMAL
UNIT 1

SITE PLAN

SHEET **1** OF **1**

NO	DATE	ISSUES AND REVISIONS



2021 W SH46, STE 105
NEW BRAUNFELS, TX. 78132
PH: 830-358-7127 ink-civil.com
TBPE FIRM F-13351

Temporary Stormwater Section

Texas Commission on Environmental Quality

for Regulated Activities on the Edwards Aquifer Recharge Zone and Relating to 30 TAC §213.5(b)(4)(A), (B), (D)(I) and (G); Effective June 1, 1999

To ensure that the application is administratively complete, confirm that all fields in the form are complete, verify that all requested information is provided, consistently reference the same site and contact person in all forms in the application, and ensure forms are signed by the appropriate party.

Note: Including all the information requested in the form and attachments contributes to more streamlined technical reviews.

Signature

To the best of my knowledge, the responses to this form accurately reflect all information requested concerning the proposed regulated activities and methods to protect the Edwards Aquifer. This **Temporary Stormwater Section** is hereby submitted for TCEQ review and executive director approval. The application was prepared by:

Print Name of Customer Agent James Ingalls, P.E.

Date: 7-27-23

Signature of Customer/Agent:

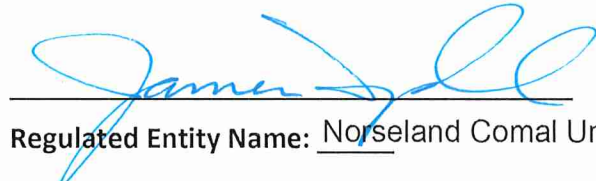

Regulated Entity Name: Norseland Comal Unit 1

Project Information

Potential Sources of Contamination

Examples: Fuel storage and use, chemical storage and use, use of asphaltic products, construction vehicles tracking onto public roads, and existing solid waste.

1. Fuels for construction equipment and hazardous substances which will be used during construction:

The following fuels and/or hazardous substances will be stored on the site: _____

These fuels and/or hazardous substances will be stored in:

- Aboveground storage tanks with a cumulative storage capacity of less than 250 gallons will be stored on the site for less than one (1) year.

- Aboveground storage tanks with a cumulative storage capacity between 250 gallons and 499 gallons will be stored on the site for less than one (1) year.
- Aboveground storage tanks with a cumulative storage capacity of 500 gallons or more will be stored on the site. An Aboveground Storage Tank Facility Plan application must be submitted to the appropriate regional office of the TCEQ prior to moving the tanks onto the project.
- Fuels and hazardous substances will not be stored on the site.
- 2. **Attachment A - Spill Response Actions.** A site specific description of the measures to be taken to contain any spill of hydrocarbons or hazardous substances is attached.
- 3. Temporary aboveground storage tank systems of 250 gallons or more cumulative storage capacity must be located a minimum horizontal distance of 150 feet from any domestic, industrial, irrigation, or public water supply well, or other sensitive feature.
- 4. **Attachment B - Potential Sources of Contamination.** A description of any activities or processes which may be a potential source of contamination affecting surface water quality is attached.

Sequence of Construction

- 5. **Attachment C - Sequence of Major Activities.** A description of the sequence of major activities which will disturb soils for major portions of the site (grubbing, excavation, grading, utilities, and infrastructure installation) is attached.
 - For each activity described, an estimate (in acres) of the total area of the site to be disturbed by each activity is given.
 - For each activity described, include a description of appropriate temporary control measures and the general timing (or sequence) during the construction process that the measures will be implemented.
- 6. Name the receiving water(s) at or near the site which will be disturbed or which will receive discharges from disturbed areas of the project: Comal/Guadalupe River

Temporary Best Management Practices (TBMPs)

Erosion control examples: tree protection, interceptor swales, level spreaders, outlet stabilization, blankets or matting, mulch, and sod. Sediment control examples: stabilized construction exit, silt fence, filter dikes, rock berms, buffer strips, sediment traps, and sediment basins. Please refer to the Technical Guidance Manual for guidelines and specifications. All structural BMPs must be shown on the site plan.

- 7. **Attachment D – Temporary Best Management Practices and Measures.** TBMPs and measures will prevent pollution of surface water, groundwater, and stormwater. The construction-phase BMPs for erosion and sediment controls have been designed to retain sediment on site to the extent practicable. The following information is attached:

- A description of how BMPs and measures will prevent pollution of surface water, groundwater or stormwater that originates upgradient from the site and flows across the site.
 - A description of how BMPs and measures will prevent pollution of surface water or groundwater that originates on-site or flows off site, including pollution caused by contaminated stormwater runoff from the site.
 - A description of how BMPs and measures will prevent pollutants from entering surface streams, sensitive features, or the aquifer.
 - A description of how, to the maximum extent practicable, BMPs and measures will maintain flow to naturally-occurring sensitive features identified in either the geologic assessment, TCEQ inspections, or during excavation, blasting, or construction.
8. The temporary sealing of a naturally-occurring sensitive feature which accepts recharge to the Edwards Aquifer as a temporary pollution abatement measure during active construction should be avoided.
- Attachment E - Request to Temporarily Seal a Feature.** A request to temporarily seal a feature is attached. The request includes justification as to why no reasonable and practicable alternative exists for each feature.
 - There will be no temporary sealing of naturally-occurring sensitive features on the site.
9. **Attachment F - Structural Practices.** A description of the structural practices that will be used to divert flows away from exposed soils, to store flows, or to otherwise limit runoff discharge of pollutants from exposed areas of the site is attached. Placement of structural practices in floodplains has been avoided.
10. **Attachment G - Drainage Area Map.** A drainage area map supporting the following requirements is attached:
- For areas that will have more than 10 acres within a common drainage area disturbed at one time, a sediment basin will be provided.
 - For areas that will have more than 10 acres within a common drainage area disturbed at one time, a smaller sediment basin and/or sediment trap(s) will be used.
 - For areas that will have more than 10 acres within a common drainage area disturbed at one time, a sediment basin or other equivalent controls are not attainable, but other TBMPs and measures will be used in combination to protect down slope and side slope boundaries of the construction area.
 - There are no areas greater than 10 acres within a common drainage area that will be disturbed at one time. A smaller sediment basin and/or sediment trap(s) will be used in combination with other erosion and sediment controls within each disturbed drainage area.

- There are no areas greater than 10 acres within a common drainage area that will be disturbed at one time. Erosion and sediment controls other than sediment basins or sediment traps within each disturbed drainage area will be used.
11. **Attachment H - Temporary Sediment Pond(s) Plans and Calculations.** Temporary sediment pond or basin construction plans and design calculations for a proposed temporary BMP or measure have been prepared by or under the direct supervision of a Texas Licensed Professional Engineer. All construction plans and design information must be signed, sealed, and dated by the Texas Licensed Professional Engineer. Construction plans for the proposed temporary BMPs and measures are attached.
- N/A
12. **Attachment I - Inspection and Maintenance for BMPs.** A plan for the inspection of each temporary BMP(s) and measure(s) and for their timely maintenance, repairs, and, if necessary, retrofit is attached. A description of the documentation procedures, recordkeeping practices, and inspection frequency are included in the plan and are specific to the site and/or BMP.
13. All control measures must be properly selected, installed, and maintained in accordance with the manufacturer's specifications and good engineering practices. If periodic inspections by the applicant or the executive director, or other information indicate a control has been used inappropriately, or incorrectly, the applicant must replace or modify the control for site situations.
14. If sediment escapes the construction site, off-site accumulations of sediment must be removed at a frequency sufficient to minimize offsite impacts to water quality (e.g., fugitive sediment in street being washed into surface streams or sensitive features by the next rain).
15. Sediment must be removed from sediment traps or sedimentation ponds not later than when design capacity has been reduced by 50%. A permanent stake will be provided that can indicate when the sediment occupies 50% of the basin volume.
16. Litter, construction debris, and construction chemicals exposed to stormwater shall be prevented from becoming a pollutant source for stormwater discharges (e.g., screening outfalls, picked up daily).

Soil Stabilization Practices

Examples: establishment of temporary vegetation, establishment of permanent vegetation, mulching, geotextiles, sod stabilization, vegetative buffer strips, protection of trees, or preservation of mature vegetation.

17. **Attachment J - Schedule of Interim and Permanent Soil Stabilization Practices.** A schedule of the interim and permanent soil stabilization practices for the site is attached.

18. Records must be kept at the site of the dates when major grading activities occur, the dates when construction activities temporarily or permanently cease on a portion of the site, and the dates when stabilization measures are initiated.
19. Stabilization practices must be initiated as soon as practicable where construction activities have temporarily or permanently ceased.

Administrative Information

20. All structural controls will be inspected and maintained according to the submitted and approved operation and maintenance plan for the project.
21. If any geologic or manmade features, such as caves, faults, sinkholes, etc., are discovered, all regulated activities near the feature will be immediately suspended. The appropriate TCEQ Regional Office shall be immediately notified. Regulated activities must cease and not continue until the TCEQ has reviewed and approved the methods proposed to protect the aquifer from any adverse impacts.
22. Silt fences, diversion berms, and other temporary erosion and sediment controls will be constructed and maintained as appropriate to prevent pollutants from entering sensitive features discovered during construction.

ATTACHMENT “A”
Spill Response Actions

Spill Prevention and Control

The objective of this section is to describe measures to prevent or reduce the discharge of pollutants to drainage systems or watercourses from leaks and spills by reducing the chance for spills, stopping the source of spills, containing and cleaning up spills, properly disposing of spill materials, and training employees.

The following steps will help reduce the stormwater impacts of leaks and spills:

Education

- (1) Be aware that different materials pollute in different amounts. Make sure that each employee knows what a “significant spill” is for each material they use, and what is the appropriate response for “significant” and “insignificant” spills. Employees should also be aware of when spills must be reported to the TCEQ. Information available in 30 TAC 327.4 and 40 CFR 302.4.
- (2) Educate employees and subcontractors on potential dangers to humans and the environment from spills and leaks.
- (3) Hold regular meetings to discuss and reinforce appropriate disposal procedures (incorporate into regular safety meetings).
- (4) Establish a continuing education program to indoctrinate new employees.
- (5) Have contractor’s superintendent or representative oversee and enforce proper spill prevention and control measures.

General Measures

- (1) To the extent that the work can be accomplished safely, spills of oil, petroleum products, and substances listed under 40 CFR parts 110,117, and 302, and sanitary and septic wastes should be contained and cleaned up immediately.
- (2) Store hazardous materials and wastes in covered containers and protect from vandalism.
- (3) Place a stockpile of spill cleanup materials where it will be readily accessible.
- (4) Train employees in spill prevention and cleanup.
- (5) Designate responsible individuals to oversee and enforce control measures.

(6) Spills should be covered and protected from stormwater runoff during rainfall to the extent that it doesn't compromise clean up activities.

(7) Do not bury or wash spills with water.

(8) Store and dispose of used clean up materials, contaminated materials, and recovered spill material that is no longer suitable for the intended purpose in conformance with the provisions in applicable BMP's.

(9) Do not allow water used for cleaning and decontamination to enter storm drains or watercourses. Collect and dispose of contaminated water in accordance with applicable regulations.

(10) Contain water overflow or minor water spillage, and do not allow it to discharge into drainage facilities or watercourses.

(11) Place Material Safety Data Sheets (MSDS), as well as proper storage, cleanup, and spill reporting instructions for hazardous materials stored or used on the project site in an open, conspicuous, and accessible location.

(12) Keep waste storage areas clean, well organized, and equipped with ample cleanup supplies as appropriate for the materials being stored. Perimeter controls, containment structures, covers, and liners should be repaired or replaced as needed to maintain proper function.

Cleanup

(1) Clean up leaks and spills immediately.

(2) Use a rag for small spills on paved surfaces, a damp mop for general cleanup, and absorbent material for larger spills. If the spilled material is hazardous, then the used cleanup materials are also hazardous and must be disposed of as hazardous waste.

(3) Never hose down or bury dry material spills. Clean up as much of the material as possible and dispose of properly. See the waste management BMP's in this section for specific information.

Minor Spills

(1) Minor spills typically involve small quantities of oil, gasoline, paint, etc. which can be controlled by the first responder at the discovery of the spill.

(2) Use absorbent materials on small spills rather than hosing down or burying the spill.

(3) Absorbent materials should be promptly removed and disposed of properly.

- (4) Follow the practice below for a minor spill:
- (5) Contain the spread of the spill.
- (6) Recover spilled materials.
- (7) Clean the contaminated area and properly dispose of contaminated materials.

Semi-Significant Spills

Semi-significant spills still can be controlled by the first responder along with the aid of other personnel such as laborers and the foreman, etc. This response may require the cessation of all other activities.

Spills should be cleaned up immediately:

- (1) Contain spread of the spill.
- (2) Notify the project foreman immediately.
- (3) If the spill occurs on paved or impermeable surfaces, clean up using "dry" methods (absorbent materials, cat litter and/or rags). Contain the spill by encircling with absorbent materials and do not let the spill spread widely.
- (4) If the spill occurs in dirt areas, immediately contain the spill by constructing an earthen dike. Dig up and properly dispose of contaminated soil.
- (5) If the spill occurs during rain, cover spill with tarps or other material to prevent contaminating runoff.

Significant/Hazardous Spills

For significant or hazardous spills that are in reportable quantities:

- (1) Notify the TCEQ by telephone as soon as possible and within 24 hours at 512-339-2929 (Austin) or 210-490-3096 (San Antonio) between 8 AM and 5 PM. After hours, contact the Environmental Release Hotline at 1-800-832-8224. It is the contractor's responsibility to have all emergency phone numbers at the construction site.
- (2) For spills of federal reportable quantities, in conformance with the requirements in 40 CFR parts 110,119, and 302, the contractor should notify the National Response Center at (800) 424-8802.
- (3) Notification should first be made by telephone and followed up with a written report.

(4) The services of a spills contractor or a Haz-Mat team should be obtained immediately. Construction personnel should not attempt to clean up until the appropriate and qualified staffs have arrived at the job site.

(5) Other agencies which may need to be consulted include, but are not limited to, the City Police Department, County Sheriff Office, Fire Departments, etc.

More information on spill rules and appropriate responses is available on the TCEQ website at: http://www.tnrcc.state.tx.us/enforcement/emergency_response.html

Vehicle and Equipment Maintenance

(1) If maintenance must occur onsite, use a designated area and a secondary containment, located away from drainage courses, to prevent the runoff of stormwater and the runoff of spills.

(2) Regularly inspect onsite vehicles and equipment for leaks and repair immediately

(3) Check incoming vehicles and equipment (including delivery trucks, and employee and subcontractor vehicles) for leaking oil and fluids. Do not allow leaking vehicles or equipment onsite.

(4) Always use secondary containment, such as a drain pan or drop cloth, to catch spills or leaks when removing or changing fluids.

(5) Place drip pans or absorbent materials under paving equipment when not in use.

(6) Use absorbent materials on small spills rather than hosing down or burying the spill. Remove the absorbent materials promptly and dispose of properly.

(7) Promptly transfer used fluids to the proper waste or recycling drums. Don't leave full drip pans or other open containers lying around.

(8) Oil filters disposed of in trashcans or dumpsters can leak oil and pollute stormwater. Place the oil filter in a funnel over a waste oil-recycling drum to drain excess oil before disposal. Oil filters can also be recycled. Ask the oil supplier or recycler about recycling oil filters.

(9) Store cracked batteries in a non-leaking secondary container. Do this with all cracked batteries even if you think all the acid has drained out. If you drop a battery, treat it as if it is cracked. Put it into the containment area until you are sure it is not leaking.

Vehicle and Equipment Fueling

(1) If fueling must occur on site, use designated areas, located away from drainage courses, to prevent the runoff of stormwater and the runoff of spills.

(2) Discourage "topping off" of fuel tanks.

(3) Always use secondary containment, such as a drain pan, when fueling to catch spills/ leaks.

ATTACHMENT “B”
Potential Sources of Contamination

The only potential sources of contamination are construction equipment leaks, re-fueling spills, port-o-lets, and the total suspended solids (TSS) due to the construction activities on-site. There are no other anticipated potential sources of contamination.

ATTACHMENT “C”
Sequence of Major Activities

Stages of Construction:

1. Installation of temporary BMP's.
2. Minor site grading: This includes the removal of organic material and other debris within the road right-of-way and building site. Approximate total disturbed area = 30.5 acres.
3. Grading: Cutting and filling of the proposed site to prepare the site for detention ponds roadways, and foundation construction. Approximate total disturbed area = 30 acres.
4. Utility installation: All primary utility mains have already been installed and are available at the site. Sewer, water, gas, and electrical services will be installed at this time.
5. Finished grading: Final landscaping and building infrastructure are installed. Approximate total disturbed area = 21.56 acres.

ATTACHMENT “D”
Temporary BMP's and Measures

The following sequence will be followed for installing temporary BMP's:

1. Silt fence will be constructed on the downgradient side of proposed site.
2. A stabilized construction exit will be installed prior to any site work.

A. Silt Fence will be installed on the most downgradient side of the site and will reduce potential pollution from any stormwater that originates onsite or offsite. A stabilized construction exit will be constructed at the entrance of the site; this will reduce the amount of contaminants leaving the site.

B. Silt fence will be placed on the downgradient side of each proposed improvement to contain pollutants generated from onsite runoff. Disturbed areas will be seeded to replace destroyed vegetation. The existing vegetation located downgradient of each proposed improvement will work in conjunction with the silt fence and stabilized construction entrance to prevent pollution of water originating onsite and/or flowing offsite.

C. The proposed silt fences, and stabilized construction entrance constructed upgradient of the existing streams will prevent pollutants from entering them, as well as the aquifer. According to

the Geologic Assessment, there is one sensitive feature that will be requested to be permanently sealed prior to site work.

ATTACHMENT “E”
Request to Temporarily Seal a Feature

There will be no request to temporarily seal a feature.

ATTACHMENT “F”
Structural Practices

Stabilized Construction Entrance/Exit, rock gabions, and silt fence will be used to protect disturbed soils and to prevent contamination from leaving the project site.

ATTACHMENT “G”
Drainage Area Map

See Drainage Area Map at the end of this section.

ATTACHMENT “H”
Temporary Sediment Pond Plans and Calculations

There will not be more than 10 acres of disturbed soil in one common drainage area that will occur at one time. Silt fence will be used for small drainage areas. No sediment ponds will be constructed due to the minimal amount of soil disturbance in each drainage area.

ATTACHMENT “I”
Inspection and Maintenance for BMP’s

Inspection and Maintenance Plan

The contractor is required to inspect the control and fences at weekly intervals and after any rainfall events to ensure that they are functioning properly. The contractor is required to document any changes on the Site Plan, documentation must include person performing task, task performed, and date. The contractor must also document if proper inspection measures have been taken while making changes. The person(s) responsible for maintenance controls and fences shall immediately make any necessary repairs to damaged areas.

Temporary Construction Entrance/Exit: The entrance should be maintained in a condition, which will prevent tracking or flowing of sediment onto public rights-of-way. This may require periodic top dressing with additional stone as conditions demand and repair and/or cleanout of any measures used to trap sediment. All sediment spilled, dropped, washed or tracked onto public rights-of-way should be removed immediately by contractor. When necessary, wheels should be cleaned to remove sediment prior to entrance onto public right-of-way. When washing is required, it should be done on an area stabilized with crushed stone that drains into an

approved sediment trap or sediment basin. All sediment should be prevented from entering any storm drain, ditch or water course by using approved methods.

Silt Fence: Remove sediment when buildup reaches 6 inches. Replace any torn fabric or install a second line of fencing parallel to the torn section. Replace or repair any sections crushed or collapsed in the course of construction activity. If a section of fence is obstructing vehicular access, consider relocating it to a spot where it will provide equal protection, but will not obstruct vehicles. A triangular filter dike may be preferable to a silt fence at common vehicle access points. When construction is complete, the sediment should be disposed of in a manner that will not cause additional siltation and the prior location of the silt fence should be revegetated. The fence itself should be disposed of in an approved landfill.

TCEQ staff will be allowed full access to the property during construction of the project for inspecting controls and fences and to verify that the accepted plan is being utilized in the field. TCEQ staff has the right to speak with the contractor to verify plan changes and modifications.

Documentation: All scheduled inspection and maintenance measures made to the temporary BMPs must be documented clearly on the WPAP Site Plan showing inspection/maintenance measures performed, date, and person responsible for inspection and maintenance. Any changes made to the location or type of controls shown on the accepted plans, due to onsite conditions, shall be documented on the site plan that is part of this Water Pollution Abatement Plan. No other changes shall be made unless approved by TCEQ and the Design Engineer. Documentation shall clearly show changes made, date, person responsible for the change, and the reason for the change.

Owner's Information:

Owner: NORSELAND COMAL, LLC
Contact: Paul Mosvold
Address: 11777 Katy Freeway 300S
Houston, Texas 77079

Design Engineer:

Company: INK Civil
Contact: James Ingalls, P.E.
Phone: (830) 358-7127
Address: 2021 SH 46W, Ste. 105
New Braunfels, Texas 78132

Person or Firm Responsible for Erosion/Sedimentation Control Maintenance:

Company: _____

Contact: _____

Phone: _____

Address: _____

Signature of Responsible Party: _____

This portion of the form shall be filled out and signed by the responsible party prior to construction.

ATTACHMENT “J”
Schedule of Interim and Permanent Soil Stabilization Practices

Areas which are disturbed by construction staging and storage areas will be hydro mulched with the appropriate seed mixture. Areas between the edge of pavement and property line will also be hydro mulched. There will be no fill slopes exceeding a 3:1 slope, and all fill slopes will be hydro mulched. Installation and acceptable mixtures of hydro mulch are as follows:

Materials:

Hydraulic Mulches: Wood fiber mulch can be applied alone or as a component of hydraulic matrices. Wood fiber applied alone is typically applied at the rate of 2,000 to 4,000 lb/acre. Wood fiber mulch is manufactured from wood or wood waste from lumber mills or from urban sources.

Hydraulic Matrices: Hydraulic matrices include a mixture of wood fiber and acrylic polymer or other tackifier as binder. Apply as a liquid slurry using a hydraulic application machine (i.e., hydro seeder) at the following minimum rates, or as specified by the manufacturer to achieve complete coverage of the target area: 2,000 to 4,000 lb/acre wood fiber mulch, and 5 to 10% (by weight) of tackifier (acrylic copolymer, guar, psyllium, etc.)

Bonded Fiber Matrix: Bonded fiber matrix (BFM) is a hydraulically applied system of fibers and adhesives that upon drying forms an erosion resistant blanket that promotes vegetation, and prevents soil erosion. BFMs are typically applied at rates from 3,000 lb/acre to 4,000 lb/acre based on the manufacturer’s recommendation. A biodegradable BFM is composed of materials that are 100% biodegradable. The binder in the BFM should also be biodegradable and should not dissolve or disperse upon re-wetting. Typically, biodegradable BFMs should not be applied immediately before, during or immediately after rainfall if the soil is saturated. Depending on the product, BFMs typically require 12 to 24 hours to dry and become effective.

Seed Mixtures:

Dates	Climate	Species	(lb/ac.)
Sept. 1 to Nov. 30	Temporary Cool Season	Tall Fescue	4.0
		Oats	21.0
		Wheats	30.0
		Total	55.0
Sept. 1 to Nov. 30	Cool Season Legume	Hairy Vetch	8.0
May 1 to Aug. 31	Temporary Warm Season	Foxtail Millet	30.0

Fertilizer: Fertilizer should be applied at the rate of 40 pounds of nitrogen and 40 pounds of phosphorus per acre, which is equivalent to about 1.0 pounds of nitrogen and phosphorus per 1000 square feet.

Installation:

- (1) Prior to application, roughen embankment and fill areas by rolling with a crimping or punching type roller or by track walking. Track walking shall only be used where other methods are impractical.
- (2) To be effective, hydraulic matrices require 24 hours to dry before rainfall occurs.
- (3) Avoid mulch over spray onto roads, sidewalks, drainage channels, existing vegetation, etc.

Drawing Name: R:\Projects\WAB001\Waterobors_Tests\Engineers_Reports\CIP\EXISTING_SCS_DRAINAGE_AREA_MAP.dwg User: chaffersmahm Jul 31, 2023 - 9:18am

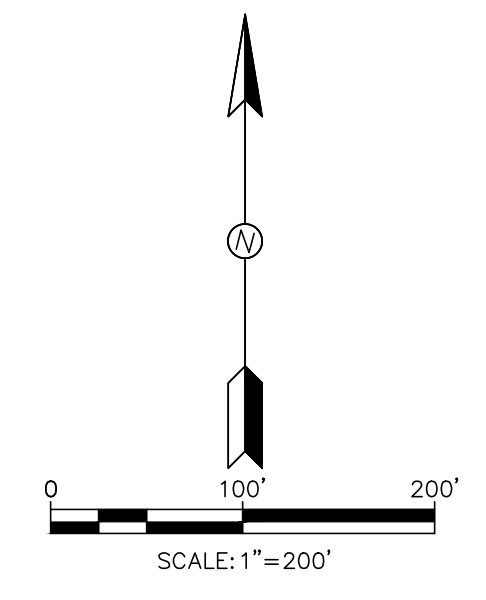
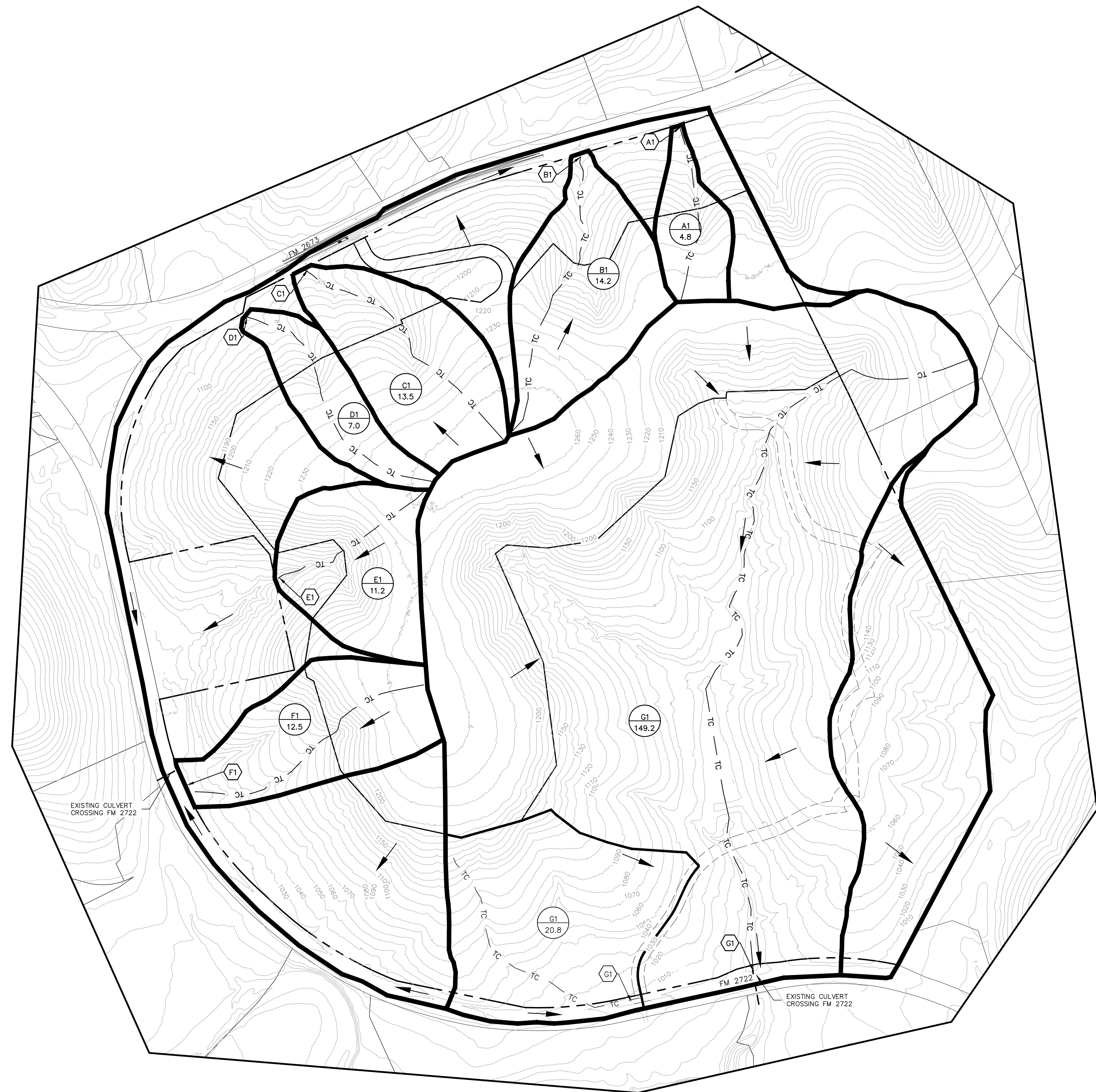

LEGEND

- LIMITS OF DRAINAGE AREA
- LIMITS OF SUB-DRAINAGE AREA
- TIME OF CONCENTRATION
- EXISTING CONTOURS
- FLOW ARROWS
- DRAINAGE BASIN LABEL
BASIN AREA (AC)
- SUB-DRAINAGE AREA LABEL
SUB-DRAINAGE AREA (AC)
- INLET LABEL
- ANALYSIS POINT LABEL



NORSELAND COMAL LLC
11777 KATY FREEWAY 300S
HOUSTON, TX 77079

**NORSELAND COMAL
UNIT 1**

**EXISTING DRAINAGE
AREA MAP**

SHEET **1** OF **2**

NO	DATE	ISSUES AND REVISIONS



2021 W SH46, STE 105
NEW BRAUNFELS, TX. 78132
PH: 830-358-7127 ink-civil.com
TBPE FIRM F-13351

EXISTING CONDITIONS
SCALE: 1"=300'

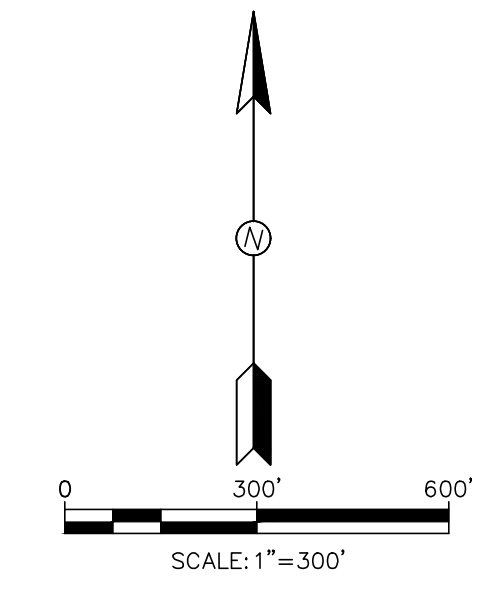

LEGEND

- LIMITS OF DRAINAGE AREA
- LIMITS OF SUB-DRAINAGE AREA
- TIME OF CONCENTRATION
- EXISTING CONTOURS
- FLOW ARROWS
- DRAINAGE BASIN LABEL
BASIN AREA (AC)
- SUB-DRAINAGE AREA LABEL
SUB-DRAINAGE AREA (AC)
- INLET LABEL
- ANALYSIS POINT LABEL



NORSELAND COMAL LLC
11777 KATY FREEWAY 300S
HOUSTON, TX 77079

**NORSELAND COMAL
UNIT 1**

**PROPOSED DRAINAGE
AREA MAP**

SHEET **2** OF **2**

NO	DATE	ISSUES AND REVISIONS



2021 W SH46, STE 105
NEW BRAUNFELS, TX. 78132
PH: 830-358-7127 ink-civil.com
TBPE FIRM F-13351

PROPOSED CONDITIONS
SCALE: 1"=300'

Drawing Name: R:\Projects\WAB001\Waterobors\Tasks\Engineering\Reports\CIP\PROPOSED SEC DRAINAGE AREA MAP.dwg User: chadfranklin Jul 31, 2023 9:23am

Agent Authorization Form
For Required Signature
Edwards Aquifer Protection Program
Relating to 30 TAC Chapter 213
Effective June 1, 1999

I _____ Paul Mosvold _____
Print Name

President _____
Title - Owner/President/Other
of _____ Norseland Comal, LLC _____
Corporation/Partnership/Entity Name
have authorized _____ James Ingalls, P.E. _____
Print Name of Agent/Engineer
of _____ INK Civil _____
Print Name of Firm

to represent and act on the behalf of the above named Corporation, Partnership, or Entity for the purpose of preparing and submitting this plan application to the Texas Commission on Environmental Quality (TCEQ) for the review and approval consideration of regulated activities.

I also understand that:

1. The applicant is responsible for compliance with 30 Texas Administrative Code Chapter 213 and any condition of the TCEQ's approval letter. The TCEQ is authorized to assess administrative penalties of up to \$10,000 per day per violation.
2. For those submitting an application who are not the property owner, but who have the right to control and possess the property, additional authorization is required from the owner.
3. Application fees are due and payable at the time the application is submitted. The application fee must be sent to the TCEQ cashier or to the appropriate regional office. The application will not be considered until the correct fee is received by the commission.
4. A notarized copy of the Agent Authorization Form must be provided for the person preparing the application, and this form must accompany the completed application.
5. No person shall commence any regulated activity on the Edwards Aquifer Recharge Zone, Contributing Zone or Transition Zone until the appropriate application for the activity has been filed with and approved by the Executive Director.

SIGNATURE PAGE:

[Handwritten Signature]
Applicant's Signature

6/21/23
Date

THE STATE OF Texas §

County of Harris §

BEFORE ME, the undersigned authority, on this day personally appeared _____ known to me to be the person whose name is subscribed to the foregoing instrument, and acknowledged to me that (s)he executed same for the purpose and consideration therein expressed.

GIVEN under my hand and seal of office on this 21 day of June, 2023.



[Handwritten Signature]
NOTARY PUBLIC

Gillian Knobelsdorf
Typed or Printed Name of Notary

MY COMMISSION EXPIRES: 10-07-2024

Application Fee Form

Texas Commission on Environmental Quality

Name of Proposed Regulated Entity: Norseland Comal Unit 1

Regulated Entity Location: 7200 FM 2722, New Braunfels, TX 78132

Name of Customer: Norseland Comal, LLC

Contact Person: Paul Mosvold

Phone: 281-433-9863

Customer Reference Number (if issued):CN _____

Regulated Entity Reference Number (if issued):RN _____

Austin Regional Office (3373)

Hays

Travis

Williamson

San Antonio Regional Office (3362)

Bexar

Medina

Uvalde

Comal

Kinney

Application fees must be paid by check, certified check, or money order, payable to the **Texas Commission on Environmental Quality**. Your canceled check will serve as your receipt. **This form must be submitted with your fee payment.** This payment is being submitted to:

Austin Regional Office

San Antonio Regional Office Online ePay

Mailed to: TCEQ - Cashier

Overnight Delivery to: TCEQ - Cashier

Revenues Section

12100 Park 35 Circle

Mail Code 214

Building A, 3rd Floor

P.O. Box 13088

Austin, TX 78753

Austin, TX 78711-3088

(512)239-0357

Site Location (Check All That Apply):

Recharge Zone

Contributing Zone

Transition Zone

Type of Plan	Size	Fee Due
Water Pollution Abatement Plan, Contributing Zone Plan: One Single Family Residential Dwelling	Acres	\$
Water Pollution Abatement Plan, Contributing Zone Plan: Multiple Single Family Residential and Parks	284.47 Acres	\$ 8,000
Water Pollution Abatement Plan, Contributing Zone Plan: Non-residential	Acres	\$
Sewage Collection System	L.F.	\$
Lift Stations without sewer lines	Acres	\$
Underground or Aboveground Storage Tank Facility	Tanks	\$
Piping System(s)(only)	Each	\$
Exception	Each	\$
Extension of Time	Each	\$

Signature: _____

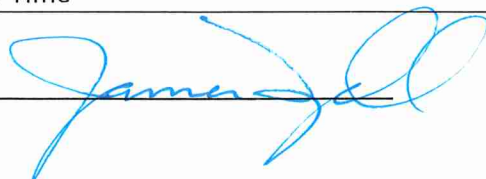

Date: 7-27-23

Application Fee Schedule

Texas Commission on Environmental Quality

Edwards Aquifer Protection Program 30 TAC Chapter 213 (effective 05/01/2008)

Water Pollution Abatement Plans and Modifications

Contributing Zone Plans and Modifications

<i>Project</i>	<i>Project Area in Acres</i>	<i>Fee</i>
One Single Family Residential Dwelling	< 5	\$650
Multiple Single Family Residential and Parks	< 5	\$1,500
	5 < 10	\$3,000
	10 < 40	\$4,000
	40 < 100	\$6,500
	100 < 500	\$8,000
	≥ 500	\$10,000
Non-residential (Commercial, industrial, institutional, multi-family residential, schools, and other sites where regulated activities will occur)	< 1	\$3,000
	1 < 5	\$4,000
	5 < 10	\$5,000
	10 < 40	\$6,500
	40 < 100	\$8,000
	≥ 100	\$10,000

Organized Sewage Collection Systems and Modifications

<i>Project</i>	<i>Cost per Linear Foot</i>	<i>Minimum Fee- Maximum Fee</i>
Sewage Collection Systems	\$0.50	\$650 - \$6,500

Underground and Aboveground Storage Tank System Facility Plans and Modifications

<i>Project</i>	<i>Cost per Tank or Piping System</i>	<i>Minimum Fee- Maximum Fee</i>
Underground and Aboveground Storage Tank Facility	\$650	\$650 - \$6,500

Exception Requests

<i>Project</i>	<i>Fee</i>
Exception Request	\$500

Extension of Time Requests

<i>Project</i>	<i>Fee</i>
Extension of Time Request	\$150



TCEQ Core Data Form

For detailed instructions on completing this form, please read the Core Data Form Instructions or call 512-239-5175.

SECTION I: General Information

1. Reason for Submission (If other is checked please describe in space provided.)		
<input checked="" type="checkbox"/> New Permit, Registration or Authorization (Core Data Form should be submitted with the program application.)		
<input type="checkbox"/> Renewal (Core Data Form should be submitted with the renewal form)	<input type="checkbox"/> Other	
2. Customer Reference Number (if issued)	Follow this link to search for CN or RN numbers in Central Registry**	3. Regulated Entity Reference Number (if issued)
CN		RN 111731675

SECTION II: Customer Information

4. General Customer Information		5. Effective Date for Customer Information Updates (mm/dd/yyyy)	
<input checked="" type="checkbox"/> New Customer <input type="checkbox"/> Update to Customer Information <input type="checkbox"/> Change in Regulated Entity Ownership <input type="checkbox"/> Change in Legal Name (Verifiable with the Texas Secretary of State or Texas Comptroller of Public Accounts)			
<i>The Customer Name submitted here may be updated automatically based on what is current and active with the Texas Secretary of State (SOS) or Texas Comptroller of Public Accounts (CPA).</i>			
6. Customer Legal Name (If an individual, print last name first: eg: Doe, John)		<i>If new Customer, enter previous Customer below:</i>	
NORSELAND COMAL, LLC			
7. TX SOS/CPA Filing Number	8. TX State Tax ID (11 digits)	9. Federal Tax ID (9 digits)	10. DUNS Number (if applicable)
0805082531	32090033187		
11. Type of Customer:	<input type="checkbox"/> Corporation	<input type="checkbox"/> Individual	Partnership: <input type="checkbox"/> General <input type="checkbox"/> Limited
Government: <input type="checkbox"/> City <input type="checkbox"/> County <input type="checkbox"/> Federal <input type="checkbox"/> Local <input type="checkbox"/> State <input type="checkbox"/> Other	<input type="checkbox"/> Sole Proprietorship	<input checked="" type="checkbox"/> Other: Limited Liability Company	
12. Number of Employees		13. Independently Owned and Operated?	
<input checked="" type="checkbox"/> 0-20 <input type="checkbox"/> 21-100 <input type="checkbox"/> 101-250 <input type="checkbox"/> 251-500 <input type="checkbox"/> 501 and higher		<input checked="" type="checkbox"/> Yes <input type="checkbox"/> No	
14. Customer Role (Proposed or Actual) – as it relates to the Regulated Entity listed on this form. Please check one of the following			
<input type="checkbox"/> Owner <input type="checkbox"/> Operator <input checked="" type="checkbox"/> Owner & Operator <input type="checkbox"/> Other: <input type="checkbox"/> Occupational Licensee <input type="checkbox"/> Responsible Party <input type="checkbox"/> VCP/BSA Applicant			
15. Mailing Address:	11777 Katy Freeway Ste. 300 S		
	City	HOUSTON	State TX
	ZIP	77079	ZIP + 4
16. Country Mailing Information (if outside USA)		17. E-Mail Address (if applicable)	
		pmosvold@scandrill.com	
18. Telephone Number	19. Extension or Code	20. Fax Number (if applicable)	

SECTION III: Regulated Entity Information

21. General Regulated Entity Information (If 'New Regulated Entity' is selected, a new permit application is also required.)									
<input checked="" type="checkbox"/> New Regulated Entity <input type="checkbox"/> Update to Regulated Entity Name <input type="checkbox"/> Update to Regulated Entity Information									
<i>The Regulated Entity Name submitted may be updated, in order to meet TCEQ Core Data Standards (removal of organizational endings such as Inc, LP, or LLC).</i>									
22. Regulated Entity Name (Enter name of the site where the regulated action is taking place.)									
NORSELAND COMAL UNIT 1									
23. Street Address of the Regulated Entity: <i>(No PO Boxes)</i>		7200 FM 2722							
		City	NEW BRAUNFELS	State	TX	ZIP	78132	ZIP + 4	
24. County		COMAL							

If no Street Address is provided, fields 25-28 are required.

25. Description to Physical Location:		APPROX. 0.91 MILES SE OF FM 2673 & FM 2722 INTERSECTION							
26. Nearest City			State			Nearest ZIP Code			
<i>Latitude/Longitude are required and may be added/updated to meet TCEQ Core Data Standards. (Geocoding of the Physical Address may be used to supply coordinates where none have been provided or to gain accuracy).</i>									
27. Latitude (N) In Decimal:		29.82916			28. Longitude (W) In Decimal:		-98.23833		
Degrees	Minutes	Seconds		Degrees	Minutes	Seconds			
29	49	45		98	14	18			
29. Primary SIC Code (4 digits)		30. Secondary SIC Code (4 digits)		31. Primary NAICS Code (5 or 6 digits)		32. Secondary NAICS Code (5 or 6 digits)			
6552		6514		531110		237210			
33. What is the Primary Business of this entity? (Do not repeat the SIC or NAICS description.)									
REAL ESTATE									
34. Mailing Address:		11777 KATY FREEWAY SUITE 300S							
		City	HOUSTON	State	TX	ZIP	77079	ZIP + 4	1190
35. E-Mail Address:		pmosvold@scandrift.com							
36. Telephone Number			37. Extension or Code			38. Fax Number (if applicable)			
(281) 433-9863						() -			

39. TCEQ Programs and ID Numbers Check all Programs and write in the permits/registration numbers that will be affected by the updates submitted on this form. See the Core Data Form instructions for additional guidance.

<input type="checkbox"/> Dam Safety	<input type="checkbox"/> Districts	<input checked="" type="checkbox"/> Edwards Aquifer	<input type="checkbox"/> Emissions Inventory Air	<input type="checkbox"/> Industrial Hazardous Waste
<input type="checkbox"/> Municipal Solid Waste	<input type="checkbox"/> New Source Review Air	<input type="checkbox"/> OSSF	<input type="checkbox"/> Petroleum Storage Tank	<input type="checkbox"/> PWS
<input type="checkbox"/> Sludge	<input type="checkbox"/> Storm Water	<input type="checkbox"/> Title V Air	<input type="checkbox"/> Tires	<input type="checkbox"/> Used Oil
<input type="checkbox"/> Voluntary Cleanup	<input type="checkbox"/> Wastewater	<input type="checkbox"/> Wastewater Agriculture	<input type="checkbox"/> Water Rights	<input type="checkbox"/> Other:

SECTION IV: Preparer Information

40. Name:	Chad Friesenhahn	41. Title:	EIT
42. Telephone Number	43. Ext./Code	44. Fax Number	45. E-Mail Address
(830) 358-7127		() -	chadfriesenhahn@ink-civil.com

SECTION V: Authorized Signature

46. By my signature below, I certify, to the best of my knowledge, that the information provided in this form is true and complete, and that I have signature authority to submit this form on behalf of the entity specified in Section II, Field 6 and/or as required for the updates to the ID numbers identified in field 39.

Company:	INK Civil	Job Title:	Professional Engineer
Name (In Print):	James Ingalls	Phone:	(830) 358- 7127
Signature:		Date:	7.27-23