

Sonterra Road Extension Project

WPAP Application

June 2023

Prepared for:

City of San Antonio

Public Works Department

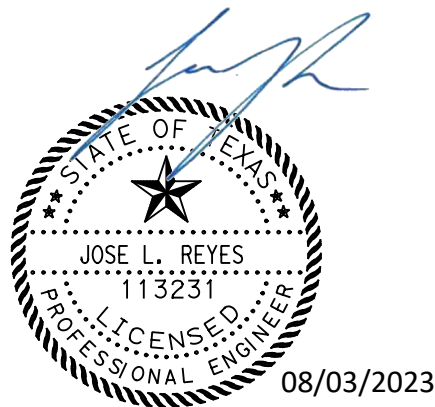

This sealed plan set is for permitting purposes only.

Prepared by:

MAESTAS

Texas Commission on Environmental Quality

Edwards Aquifer Application Cover Page

Our Review of Your Application

The Edwards Aquifer Program staff conducts an administrative and technical review of all applications. The turnaround time for administrative review can be up to 30 days as outlined in 30 TAC 213.4(e). Generally administrative completeness is determined during the intake meeting or within a few days of receipt. The turnaround time for technical review of an administratively complete Edwards Aquifer application is 90 days as outlined in 30 TAC 213.4(e). Please know that the review and approval time is directly impacted by the quality and completeness of the initial application that is received. In order to conduct a timely review, it is imperative that the information provided in an Edwards Aquifer application include final plans, be accurate, complete, and in compliance with [30 TAC 213](#).

Administrative Review

1. [Edwards Aquifer applications](#) must be deemed administratively complete before a technical review can begin. To be considered administratively complete, the application must contain completed forms and attachments, provide the requested information, and meet all the site plan requirements. The submitted application and plan sheets should be final plans. Please submit one full-size set of plan sheets with the original application, and half-size sets with the additional copies.

To ensure that all applicable documents are included in the application, the program has developed tools to guide you and web pages to provide all forms, checklists, and guidance. Please visit the below website for assistance: <http://www.tceq.texas.gov/field/eapp>.

2. This Edwards Aquifer Application Cover Page form (certified by the applicant or agent) must be included in the application and brought to the administrative review meeting.
3. Administrative reviews are scheduled with program staff who will conduct the review. Applicants or their authorized agent should call the appropriate regional office, according to the county in which the project is located, to schedule a review. The average meeting time is one hour.
4. In the meeting, the application is examined for administrative completeness. Deficiencies will be noted by staff and emailed or faxed to the applicant and authorized agent at the end of the meeting, or shortly after. Administrative deficiencies will cause the application to be deemed incomplete and returned.

An appointment should be made to resubmit the application. The application is re-examined to ensure all deficiencies are resolved. The application will only be deemed administratively complete when all administrative deficiencies are addressed.

5. If an application is received by mail, courier service, or otherwise submitted without a review meeting, the administrative review will be conducted within 30 days. The applicant and agent will be contacted with the results of the administrative review. If the application is found to be administratively incomplete, it can be retrieved from the regional office or returned by regular mail. If returned by mail, the regional office may require arrangements for return shipping.
6. If the geologic assessment was completed before October 1, 2004 and the site contains “possibly sensitive” features, the assessment must be updated in accordance with the *Instructions to Geologists* (TCEQ-0585 Instructions).

Technical Review

1. When an application is deemed administratively complete, the technical review period begins. The regional office will distribute copies of the application to the identified affected city, county, and groundwater conservation district whose jurisdiction includes the subject site. These entities and the public have 30 days to provide comments on the application to the regional office. All comments received are reviewed by TCEQ.
2. A site assessment is usually conducted as part of the technical review, to evaluate the geologic assessment and observe existing site conditions. The site must be accessible to our staff. The site boundaries should be

clearly marked, features identified in the geologic assessment should be flagged, roadways marked and the alignment of the Sewage Collection System and manholes should be staked at the time the application is submitted. If the site is not marked the application may be returned.

3. We evaluate the application for technical completeness and contact the applicant and agent via Notice of Deficiency (NOD) to request additional information and identify technical deficiencies. There are two deficiency response periods available to the applicant. There are 14 days to resolve deficiencies noted in the first NOD. If a second NOD is issued, there is an additional 14 days to resolve deficiencies. If the response to the second notice is not received, is incomplete or inadequate, or provides new information that is incomplete or inadequate, the application must be withdrawn or will be denied. Please note that because the technical review is underway, whether the application is withdrawn or denied **the application fee will be forfeited.**
4. The program has 90 calendar days to complete the technical review of the application. If the application is technically adequate, such that it complies with the Edwards Aquifer rules, and is protective of the Edwards Aquifer during and after construction, an approval letter will be issued. Construction or other regulated activity may not begin until an approval is issued.

Mid-Review Modifications

It is important to have final site plans prior to beginning the permitting process with TCEQ to avoid delays.

Occasionally, circumstances arise where you may have significant design and/or site plan changes after your Edwards Aquifer application has been deemed administratively complete by TCEQ. This is considered a “Mid-Review Modification”. Mid-Review Modifications may require redistribution of an application that includes the proposed modifications for public comment.

If you are proposing a Mid-Review Modification, two options are available:

- If the technical review has begun your application can be denied/withdrawn, your fees will be forfeited, and the plan will have to be resubmitted.
- TCEQ can continue the technical review of the application as it was submitted, and a modification application can be submitted at a later time.

If the application is denied/withdrawn, the resubmitted application will be subject to the administrative and technical review processes and will be treated as a new application. The application will be redistributed to the affected jurisdictions.

Please contact the regional office if you have questions. If your project is located in Williamson, Travis, or Hays County, contact TCEQ’s Austin Regional Office at 512-339-2929. If your project is in Comal, Bexar, Medina, Uvalde, or Kinney County, contact TCEQ’s San Antonio Regional Office at 210-490-3096

Please fill out all required fields below and submit with your application.

1. Regulated Entity Name: Sonterra Road Extension Project					2. Regulated Entity No.:				
3. Customer Name: City of San Antonio					4. Customer No.: 600130652				
5. Project Type: (Please circle/check one)	<input checked="" type="radio"/> New	Modification			Extension		Exception		
6. Plan Type: (Please circle/check one)	<input checked="" type="radio"/> WPAP	<input type="radio"/> CZP	<input type="radio"/> SCS	<input type="radio"/> UST	<input type="radio"/> AST	<input type="radio"/> EXP	<input type="radio"/> EXT	Technical Clarification	Optional Enhanced Measures
7. Land Use: (Please circle/check one)	<input type="radio"/> Residential	<input checked="" type="radio"/> Non-residential			8. Site (acres):		4.439		
9. Application Fee:	\$4,000		10. Permanent BMP(s):			Batch Detention			
11. SCS (Linear Ft.):	-		12. AST/UST (No. Tanks):						
13. County:	Bexar		14. Watershed:			Salado Creek			

Application Distribution

Instructions: Use the table below to determine the number of applications required. One original and one copy of the application, plus additional copies (as needed) for each affected incorporated city, county, and groundwater conservation district are required. Linear projects or large projects, which cross into multiple jurisdictions, can require additional copies. Refer to the “Texas Groundwater Conservation Districts within the EAPP Boundaries” map found at:

http://www.tceq.texas.gov/assets/public/compliance/field_ops/eapp/EAPP%20GWCD%20map.pdf

For more detailed boundaries, please contact the conservation district directly.

Austin Region			
County:	Hays	Travis	Williamson
Original (1 req.)	—	—	—
Region (1 req.)	—	—	—
County(ies)	—	—	—
Groundwater Conservation District(s)	<input type="checkbox"/> Edwards Aquifer Authority <input type="checkbox"/> Barton Springs/Edwards Aquifer <input type="checkbox"/> Hays Trinity <input type="checkbox"/> Plum Creek	<input type="checkbox"/> Barton Springs/Edwards Aquifer	NA
City(ies) Jurisdiction	<input type="checkbox"/> Austin <input type="checkbox"/> Buda <input type="checkbox"/> Dripping Springs <input type="checkbox"/> Kyle <input type="checkbox"/> Mountain City <input type="checkbox"/> San Marcos <input type="checkbox"/> Wimberley <input type="checkbox"/> Woodcreek	<input type="checkbox"/> Austin <input type="checkbox"/> Bee Cave <input type="checkbox"/> Pflugerville <input type="checkbox"/> Rollingwood <input type="checkbox"/> Round Rock <input type="checkbox"/> Sunset Valley <input type="checkbox"/> West Lake Hills	<input type="checkbox"/> Austin <input type="checkbox"/> Cedar Park <input type="checkbox"/> Florence <input type="checkbox"/> Georgetown <input type="checkbox"/> Jerrell <input type="checkbox"/> Leander <input type="checkbox"/> Liberty Hill <input type="checkbox"/> Pflugerville <input type="checkbox"/> Round Rock

San Antonio Region					
County:	Bexar	Comal	Kinney	Medina	Uvalde
Original (1 req.)	<input checked="" type="checkbox"/>	—	—	—	—
Region (1 req.)	<input checked="" type="checkbox"/>	—	—	—	—
County(ies)	<input checked="" type="checkbox"/>	—	—	—	—
Groundwater Conservation District(s)	<input checked="" type="checkbox"/> Edwards Aquifer Authority <input type="checkbox"/> Trinity-Glen Rose	<input type="checkbox"/> Edwards Aquifer Authority	<input type="checkbox"/> Kinney	<input type="checkbox"/> EAA <input type="checkbox"/> Medina	<input type="checkbox"/> EAA <input type="checkbox"/> Uvalde
City(ies) Jurisdiction	<input type="checkbox"/> Castle Hills <input type="checkbox"/> Fair Oaks Ranch <input type="checkbox"/> Helotes <input type="checkbox"/> Hill Country Village <input type="checkbox"/> Hollywood Park <input checked="" type="checkbox"/> San Antonio (SAWS) <input type="checkbox"/> Shavano Park	<input type="checkbox"/> Bulverde <input type="checkbox"/> Fair Oaks Ranch <input type="checkbox"/> Garden Ridge <input type="checkbox"/> New Braunfels <input type="checkbox"/> Schertz	NA	<input type="checkbox"/> San Antonio ETJ (SAWS)	NA

I certify that to the best of my knowledge, that the application is complete and accurate. This application is hereby submitted to TCEQ for administrative review and technical review.

Jose L. Reyes, PE

Print Name of Customer/Authorized Agent

06/13/2023

Signature of Customer/Authorized Agent

Date

****FOR TCEQ INTERNAL USE ONLY****

Date(s) Reviewed:		Date Administratively Complete:	
Received From:		Correct Number of Copies:	
Received By:		Distribution Date:	
EAPP File Number:		Complex:	
Admin. Review(s) (No.):		No. AR Rounds:	
Delinquent Fees (Y/N):		Review Time Spent:	
Lat./Long. Verified:		SOS Customer Verification:	
Agent Authorization Complete/Notarized (Y/N):		Fee Check:	Payable to TCEQ (Y/N):
Core Data Form Complete (Y/N):			Signed (Y/N):
Core Data Form Incomplete Nos.:			Less than 90 days old (Y/N):

General Information Form

Texas Commission on Environmental Quality

For Regulated Activities on the Edwards Aquifer Recharge and Transition Zones and Relating to 30 TAC §213.4(b) & §213.5(b)(2)(A), (B) Effective June 1, 1999

To ensure that the application is administratively complete, confirm that all fields in the form are complete, verify that all requested information is provided, consistently reference the same site and contact person in all forms in the application, and ensure forms are signed by the appropriate party.

Note: Including all the information requested in the form and attachments contributes to more streamlined technical reviews.

Signature

To the best of my knowledge, the responses to this form accurately reflect all information requested concerning the proposed regulated activities and methods to protect the Edwards Aquifer. This **General Information Form** is hereby submitted for TCEQ review. The application was prepared by:

Print Name of Customer/Agent: Jose L. Reyes, PE

Date: 06/13/2023

Signature of Customer/Agent:



Project Information

1. Regulated Entity Name: Sonterra Road Extension Project

2. County: Bexar

3. Stream Basin: Salado Creek Basin

4. Groundwater Conservation District (If applicable): N/A

5. Edwards Aquifer Zone:

Recharge Zone

Transition Zone

6. Plan Type:

WPAP

SCS

Modification

AST

UST

Exception Request

7. Customer (Applicant):

Contact Person: Sean D. Strong, PE

Entity: City of San Antonio

Mailing Address: 100 W. Houston St., 15th Floor

City, State: San Antonio, Texas

Zip: 78205

Telephone: 210-207-8037

FAX: 210-207-4406

Email Address: sean.strong@sanantonio.gov

8. Agent/Representative (If any):

Contact Person: Jose L. Reyes, PE

Entity: Maestas & Associates, LLC.

Mailing Address: 8122 Datapoint Drive, Suite 840

City, State: San Antonio, Texas

Zip: 78229

Telephone: 210-366-1988

FAX: 210-366-1980

Email Address: jreyes@maesce.com

9. Project Location:

- The project site is located inside the city limits of City of San Antonio.
- The project site is located outside the city limits but inside the ETJ (extra-territorial jurisdiction) of _____.
- The project site is not located within any city's limits or ETJ.

10. The location of the project site is described below. The description provides sufficient detail and clarity so that the TCEQ's Regional staff can easily locate the project and site boundaries for a field investigation.

The project is located in between E Sonterra Blvd & Gold Canyon Rd at the N loop 1604 E Access Rd and Gold Canyon Rd intersection.

11. **Attachment A – Road Map.** A road map showing directions to and the location of the project site is attached. The project location and site boundaries are clearly shown on the map.

12. **Attachment B - USGS / Edwards Recharge Zone Map.** A copy of the official 7 ½ minute USGS Quadrangle Map (Scale: 1" = 2000') of the Edwards Recharge Zone is attached. The map(s) clearly show:

- Project site boundaries.
- USGS Quadrangle Name(s).
- Boundaries of the Recharge Zone (and Transition Zone, if applicable).
- Drainage path from the project site to the boundary of the Recharge Zone.

13. **The TCEQ must be able to inspect the project site or the application will be returned.** Sufficient survey staking is provided on the project to allow TCEQ regional staff to locate the boundaries and alignment of the regulated activities and the geologic or manmade features noted in the Geologic Assessment.

Survey staking will be completed by this date: 1/1/2024

14. **Attachment C – Project Description.** Attached at the end of this form is a detailed narrative description of the proposed project. The project description is consistent throughout the application and contains, at a minimum, the following details:

- Area of the site
- Offsite areas
- Impervious cover
- Permanent BMP(s)
- Proposed site use
- Site history
- Previous development
- Area(s) to be demolished

15. Existing project site conditions are noted below:

- Existing commercial site
- Existing industrial site
- Existing residential site
- Existing paved and/or unpaved roads
- Undeveloped (Cleared)
- Undeveloped (Undisturbed/Uncleared)
- Other: _____

Prohibited Activities

16. I am aware that the following activities are prohibited on the Recharge Zone and are not proposed for this project:

- (1) Waste disposal wells regulated under 30 TAC Chapter 331 of this title (relating to Underground Injection Control);
- (2) New feedlot/concentrated animal feeding operations, as defined in 30 TAC §213.3;
- (3) Land disposal of Class I wastes, as defined in 30 TAC §335.1;
- (4) The use of sewage holding tanks as parts of organized collection systems; and
- (5) New municipal solid waste landfill facilities required to meet and comply with Type I standards which are defined in §330.41(b), (c), and (d) of this title (relating to Types of Municipal Solid Waste Facilities).
- (6) New municipal and industrial wastewater discharges into or adjacent to water in the state that would create additional pollutant loading.

17. I am aware that the following activities are prohibited on the Transition Zone and are not proposed for this project:

- (1) Waste disposal wells regulated under 30 TAC Chapter 331 (relating to Underground Injection Control);

- (2) Land disposal of Class I wastes, as defined in 30 TAC §335.1; and
- (3) New municipal solid waste landfill facilities required to meet and comply with Type I standards which are defined in §330.41 (b), (c), and (d) of this title.

Administrative Information

18. The fee for the plan(s) is based on:

- For a Water Pollution Abatement Plan or Modification, the total acreage of the site where regulated activities will occur.
- For an Organized Sewage Collection System Plan or Modification, the total linear footage of all collection system lines.
- For a UST Facility Plan or Modification or an AST Facility Plan or Modification, the total number of tanks or piping systems.
- A request for an exception to any substantive portion of the regulations related to the protection of water quality.
- A request for an extension to a previously approved plan.

19. Application fees are due and payable at the time the application is filed. If the correct fee is not submitted, the TCEQ is not required to consider the application until the correct fee is submitted. Both the fee and the Edwards Aquifer Fee Form have been sent to the Commission's:

- TCEQ cashier
- Austin Regional Office (for projects in Hays, Travis, and Williamson Counties)
- San Antonio Regional Office (for projects in Bexar, Comal, Kinney, Medina, and Uvalde Counties)

20. Submit one (1) original and one (1) copy of the application, plus additional copies as needed for each affected incorporated city, groundwater conservation district, and county in which the project will be located. The TCEQ will distribute the additional copies to these jurisdictions. The copies must be submitted to the appropriate regional office.

21. No person shall commence any regulated activity until the Edwards Aquifer Protection Plan(s) for the activity has been filed with and approved by the Executive Director.

GENERAL INFORMATION FORM ATTACHMENTS

ATTACHMENT A – ROAD MAP

Attached.

ATTACHMENT B – USGS/EDWARDS AQUIFER RECHARGE ZONE MAP

Attached.

ATTACHMENT C - PROJECT DESCRIPTION

The City of San Antonio is proposing to extend Sonterra Blvd. approximately 450 LF northeast and Gold Canyon approximately 950 LF north to intersect each other with a roundabout. In addition to extending these roadways are variable width sidewalks on both sides of the roadway and driveway extensions to tie-in to the proposed roadway. The purpose of the project is to provide access to Sonterra Blvd. by way of Gold Canyon Rd, and to place the intersection for future development.

The entire project area is within the Recharge Zone. The project consists of 147,227 square feet of roadway reconstruction including proposed curbs, sidewalk, and batch detention. All elements of the proposed improvements drain to Mud Creek.

The proposed BMP is a batch detention pond and is located northeast of the roundabout.

The existing pavement was treated by an existing sand filtration pond which prevents off-site runoff from affecting the new impervious cover and proposed batch detention. The portion of Sonterra Blvd. that is being re-constructed drains to an existing sand filtration basin that corresponds to Legacy Shopping Center Phase 2 WPAP (RN102747409).

The total project area is 4.439 acres, of which 1.54 acres is existing impervious cover (34.7% impervious cover) in predevelopment conditions. Approximately 83,200 square feet of new impervious cover will be added, resulting in 3.45 acres of total impervious cover and a post development impervious cover of 77.7%.

The roadway will be constructed in the City of San Antonio right of way limits. The property adjacent to the project was platted on September 25th, 2000, recorded in Volume 9548 Page 169 of the Bexar County Records.

The project will include sewer improvements and the SCS permit will be submitted at a later date.

Sonterra Road Extension Project

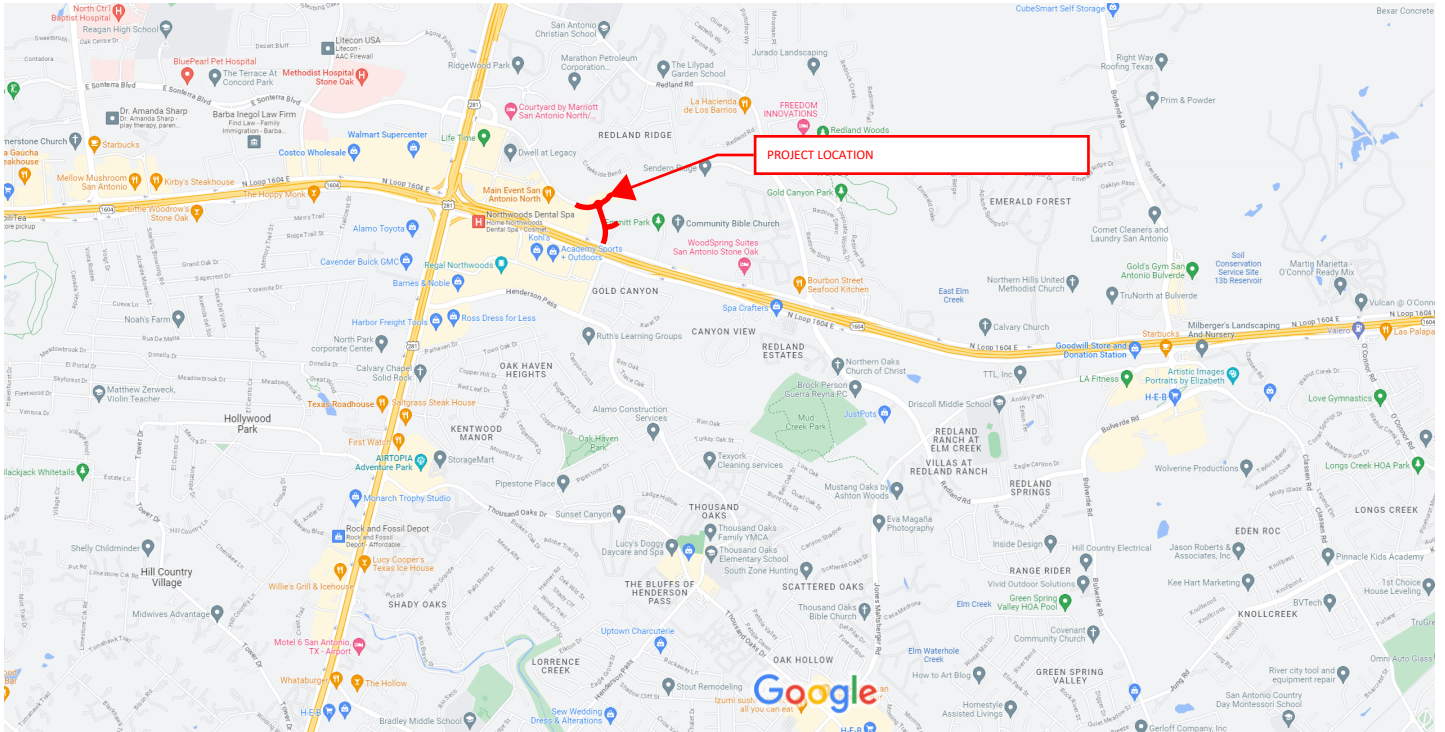

LEGEND

 WPAP PROJECT SITE

ATTACHMENT A
PROJECT LOCATION
SONTERRA ROAD EXTENSION
PROJECT



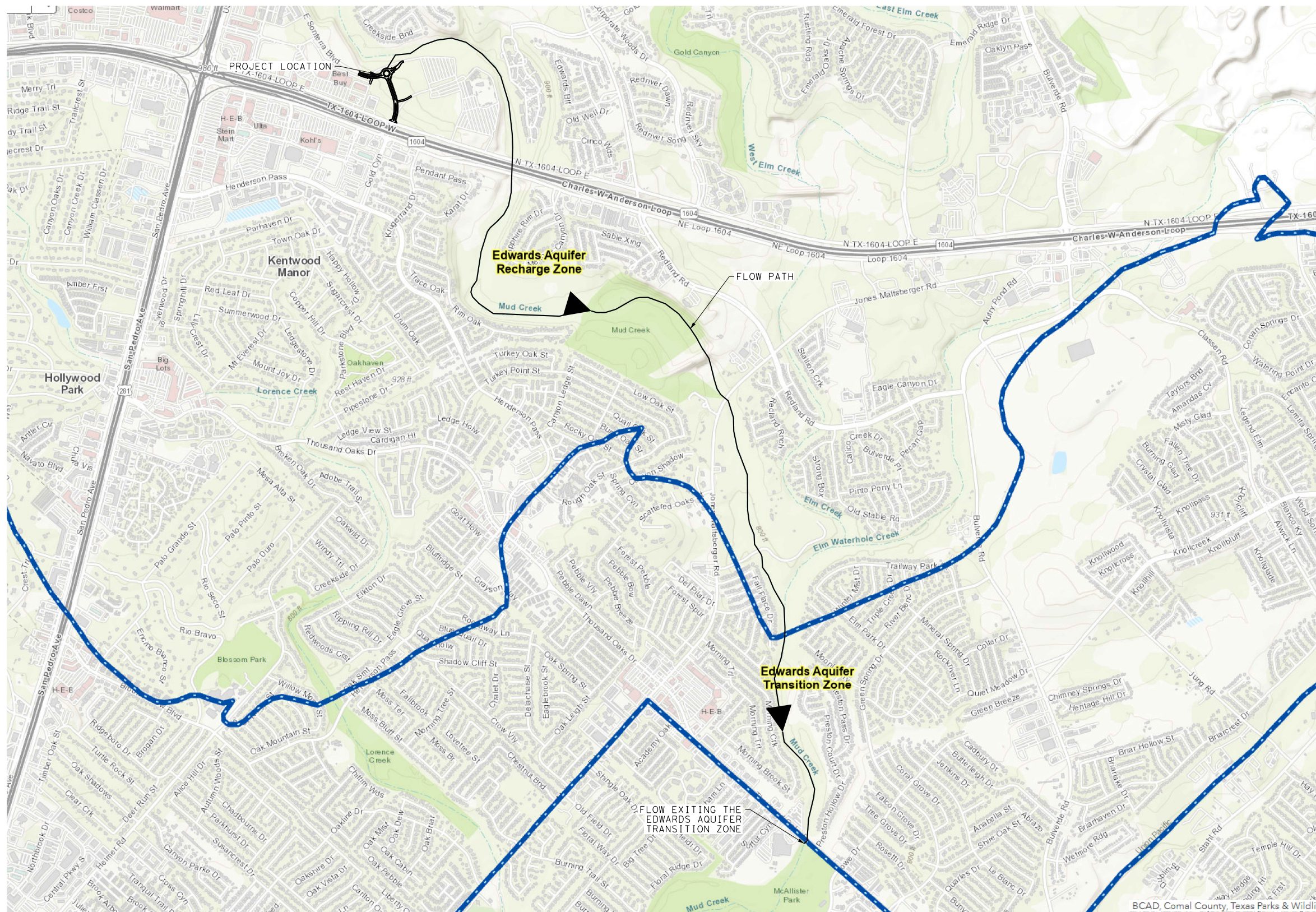

SCALE
1" = 2000'

LEGEND

← FLOW PATH FROM PROJECT TO BOUNDARY OF TRANSITION ZONE

MAESTAS 8122 DATAPOINT DR., STE. 840
SAN ANTONIO, TX 78229
(210) 366-1988
TBPE No.: F-333
TBPLS No.: 10194506



NO:	DATE	REVISION	APPROVED BY

Freese and Nichols, Inc.
Texas Registered Engineering Firm F-2144
FREES AND NICHOLS 9601 McAllister Freeway, Suite 1008
San Antonio, Texas 78216
Phone - (210) 298-3800
web - www.freese.com

CITY OF SAN ANTONIO
PUBLIC WORKS DEPARTMENT

SONTERRA ROAD EXTENSION
ATTACHMENT B
USGS QUADRANGLE: LONGHORN
SHEET 1 OF 1

PRELIMINARY	PROJECT NO.:	23-01849	DATE: 8/3/2023
DRWN. BY:	DSGN. BY:	CHKD. BY:	SHEET 1 OF 1

Date: 8/3/2023

Geologic Assessment

Texas Commission on Environmental Quality

For Regulated Activities on The Edwards Aquifer Recharge/transition Zones and Relating to 30 TAC §213.5(b)(3), Effective June 1, 1999

To ensure that the application is administratively complete, confirm that all fields in the form are complete, verify that all requested information is provided, consistently reference the same site and contact person in all forms in the application, and ensure forms are signed by the appropriate party.

Note: Including all the information requested in the form and attachments contributes to more streamlined technical reviews.

Signature

To the best of my knowledge, the responses to this form accurately reflect all information requested concerning the proposed regulated activities and methods to protect the Edwards Aquifer. My signature certifies that I am qualified as a geologist as defined by 30 TAC Chapter 213.

Print Name of Geologist: Stephen Norair II,
P.G.

Telephone: 817-735-7278

Fax: N/A

Date: 6/3/2022

Representing: Freese and Nichols, Inc. P.G. No. 12162 (Name of Company and TBPG or TBPE registration number)

Signature of Geologist:

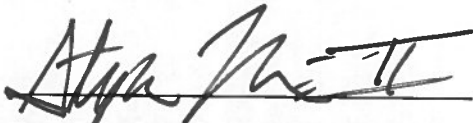

Regulated Entity Name: Sonterra and Gold Canyon Extension

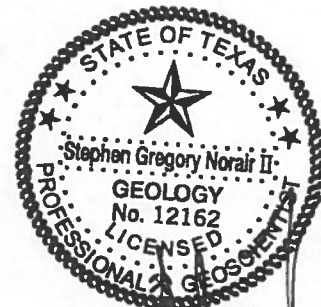

Project Information

1. Date(s) Geologic Assessment was performed: 1/27/2022

2. Type of Project:

WPAP

SCS

AST

UST

3. Location of Project:

Recharge Zone

Transition Zone

Contributing Zone within the Transition Zone

4. **Attachment A - Geologic Assessment Table.** Completed Geologic Assessment Table (Form TCEQ-0585-Table) is attached.
5. Soil cover on the project site is summarized in the table below and uses the SCS Hydrologic Soil Groups* (Urban Hydrology for Small Watersheds, Technical Release No. 55, Appendix A, Soil Conservation Service, 1986). If there is more than one soil type on the project site, show each soil type on the site Geologic Map or a separate soils map.

Table 1 - Soil Units, Infiltration Characteristics and Thickness

Soil Name	Group*	Thickness(feet)
Anhalt clay (Ca)	D	2.3-5
Eckrant very cobbly clay (TaC)	D	1 - 2.5
Tinn and Frio soils (Tf)	D	>6.7

* Soil Group Definitions (Abbreviated)

- A. Soils having a high infiltration rate when thoroughly wetted.
- B. Soils having a moderate infiltration rate when thoroughly wetted.
- C. Soils having a slow infiltration rate when thoroughly wetted.
- D. Soils having a very slow infiltration rate when thoroughly wetted.

6. **Attachment B – Stratigraphic Column.** A stratigraphic column showing formations, members, and thicknesses is attached. The outcropping unit, if present, should be at the top of the stratigraphic column. Otherwise, the uppermost unit should be at the top of the stratigraphic column.
7. **Attachment C – Site Geology.** A narrative description of the site specific geology including any features identified in the Geologic Assessment Table, a discussion of the potential for fluid movement to the Edwards Aquifer, stratigraphy, structure(s), and karst characteristics is attached.
8. **Attachment D – Site Geologic Map(s).** The Site Geologic Map must be the same scale as the applicant's Site Plan. The minimum scale is 1": 400'
 Applicant's Site Plan Scale: 1" = 400'
 Site Geologic Map Scale: 1" = 400'
 Site Soils Map Scale (if more than 1 soil type): 1" = 400'
9. Method of collecting positional data:
 - Global Positioning System (GPS) technology.
 - Other method(s). Please describe method of data collection: _____

10. The project site and boundaries are clearly shown and labeled on the Site Geologic Map.
11. Surface geologic units are shown and labeled on the Site Geologic Map.
12. Geologic or manmade features were discovered on the project site during the field investigation. They are shown and labeled on the Site Geologic Map and are described in the attached Geologic Assessment Table.
- Geologic or manmade features were not discovered on the project site during the field investigation.
13. The Recharge Zone boundary is shown and labeled, if appropriate.
14. All known wells (test holes, water, oil, unplugged, capped and/or abandoned, etc.): If applicable, the information must agree with Item No. 20 of the WPAP Application Section.
- There are _____ (#) wells present on the project site and the locations are shown and labeled. (Check all of the following that apply.)
- The wells are not in use and have been properly abandoned.
- The wells are not in use and will be properly abandoned.
- The wells are in use and comply with 16 TAC Chapter 76.
- There are no wells or test holes of any kind known to exist on the project site.

Administrative Information

15. Submit one (1) original and one (1) copy of the application, plus additional copies as needed for each affected incorporated city, groundwater conservation district, and county in which the project will be located. The TCEQ will distribute the additional copies to these jurisdictions. The copies must be submitted to the appropriate regional office.

Attachment B

Stratigraphic Column^{1, 2, 3}

System	Series	Group	Formation	Member	Thickness (ft)
Lower Cretaceous	Commanchian	Edwards Group/Edwards Limestone Undivided (Ke)	Person Formation	Leached and collapsed member	70 – 100
				Regional dense member	16 – 24
			Kainer Formation	Grainstone member	50 – 60
				Kirscheberg evaporite member	50 – 60
				Dolomitic member	110 – 140
				Basal nodular member	20 – 70
		Trinity	Glen Rose Formation	Upper (Kgru)	400 – 900
				Lower (Kgrl)	

¹Blome, C.D., Faith, J.R., Pedraza, D.E., Ozuna, G.B., Cole, J.C., Clark, A.K., Small, T.A., and Morris, R.R. 2005. Geologic Map of the Edwards Aquifer Recharge Zone, South-Central Texas. U.S. Geological Survey, U.S. Department of the Interior. Scientific Investigations Map 2873. Version 1.1. Scale 1:200,00

²Texas Water Science Center (USGS TWSC). Geologic Database of Texas, 2014-02-01. Web. 2022-01-05.

³University of Texas at Austin. Bureau of Economic Geology (1974). Geologic Atlas of Texas, San Antonio Sheet. The Bureau, 1974. Robert Hamilton Cuyler Memorial ed.a

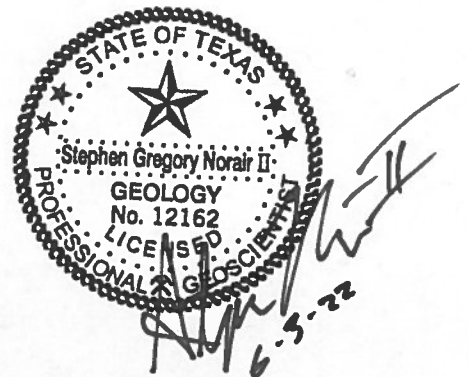

Attachment C

Narrative Description of Site Specific Geology

Project Description

FNI has been contracted to develop plans, specifications, and estimates for a roadway extension between the current limits of Sonterra Blvd and Loop 1604, with the goal being to extend and connect Gold Canyon Road to the aforementioned roadways per San Antonio's Major Thoroughfare Plan. This plan includes curbs, sidewalks, driveway approaches, intersection improvements, and drainage improvements.

The history of this project location begins in the 1960's when Loop 1604 was constructed south of the project area. Between 1995 and 2002, the Community Bible Church complex (commercial land use) was constructed to the immediate east of the project location. By 2008, adjacent strip malls (commercial land use) and Sonterra Blvd were completed, and the current site conditions were achieved. The remainder of the site remains undeveloped and has not been cleared in its history.

Geologic Stratigraphy and Structural Characteristics

The stratigraphy within the project area for Sonterra-Gold Canyon Extension consists solely of the Cretaceous-aged Edwards Limestone with thicknesses between 170 and 300 feet. The Edwards limestone at the project site can be divided into two lithostratigraphic subunits, the Person Formation and the Kainer Formation. These members can be further subdivided into three members, the leached and collapsed member, the regional dense member, and the grainstone member. The leached and collapsed member is a crystalline limestone and mudstone to grainstone with chert that has been identified with bioturbated beds separated by massive limestone beds. Underlying this is the regionally dense member that is a vertical boundary to flow through the Edwards Group. The lowest potential hydrostratigraphic unit within the project area is the grainstone member, which is a white, chert-bearing grainstone and mudstone. The lower members have a greater likelihood of being present at the site closer to Mud Creek. Lastly, according to geologic maps, a normal fault may be present between 0.4 to 1.4 miles southeast of the project location.

Soil Profiles

There are three soils within the project site: the Eckrant very cobbly clay, the Anhalt Clay, and the Tinn and Frio soils. The Eckrant very cobbly clay (TaC; with 5 to 15 percent slopes) is located at the highest elevations of the project site. This soil unit has a depth of 12 to 30 inches before reaching bedrock, is in hydrologic soil group D, and is well drained. It is derived from the residuum of weathered limestone and is associated with ridge backslopes and side slopes. The Anhalt Clay (Ca; with 0 to 2 percent slopes) unit has a depth of 28 to 60 inches before reaching bedrock. It is in hydrologic soil group D, is well drained, and is also associated with the toe and base of hillslopes. It is formed from the clayey residuum of weathered limestone. The Tinn and Frio soils (Tf; with slopes of 0 to 1%) follow the alignment of Mud Creek. This soil unit has a depth greater than 80 inches due to its association with floodplains and is derived from calcareous clayey alluvium.

Site Assessment

FNI conducted a geologic site assessment on January 27th, 2022. This site assessment was focused on identifying geologic and karstic features within the project area. The topography of the site consists of a hill that gently slopes down from its highest elevation at the southern end of the project area to a terrace followed by another slope that continues down to the floodplain of Mud Creek. All fluid movement at the site appears to flow southwest to northeast into Mud Creek via surface flow.

The area south of the existing Gold Canyon road is undeveloped and is a mix of cedar and oak forest and grassland. Talus and bedrock are intermittently present at the surface in forested areas, while grassland areas are predominantly soil. No karst or geologic features were identified.

Along the southern alignment of Gold Canyon Road, a drainage swale is present that flows west to east then north through a culvert and into Mud Creek. This bottom of the swale is composed of exposed bedrock in some locations. The bedrock looks well consolidated and does not appear to have hydrologic interactions with the subsurface.

On the north side of Gold Canyon Road, a rock outcrop that trends east-west is present. This outcrop makes up the 20-foot elevation loss between the terrace and the floodplain of Mud Creek. The outcrop is composed of massive grey limestone. Although local cracking and weathering was observed. No evidence indicated a karstic or structural geologic connection to the subsurface.

The northern most portion of the project location is within the Mud Creek floodplain. One geologic feature was observed consisting of a sewer manhole (surficial evidence of a sewer line that runs east-west following Mud Creek). This feature was typed as “Manmade feature in bedrock” and is a low sensitivity feature due to its encasement in concrete and absence of expedited infiltration rates.



Photo 1. Representative view of undeveloped areas south of Gold Canyon Road within project location covered with grasses.



Photo 2. Representative view of undeveloped forested areas south of Gold Canyon Road within project location.



Photo 3. View looking west along Gold Canyon Road from culvert at bedrock lined drainage swale.



Photo 4. Representative view of bedrock outcrop that trends east-west north of Gold Canyon Road (facing south). This is what the slope down to Mud Creek looks like through much of the area.



Photo 5. View of the geologic feature F-1, sewer manhole, adjacent to Mud Creek.

- Site Photos
- ➔ Surface Drainage Pathway
- Potential Road Alignment
- ▭ Project Extents

Site Soils

- ▭ Anhalt Clay (Ca)
- ▭ Eckrant very cobbly clay (TaC)
- ▭ Tinn and frio (Tf)

Site Geology

- ▭ Edwards Limestone (Ked)

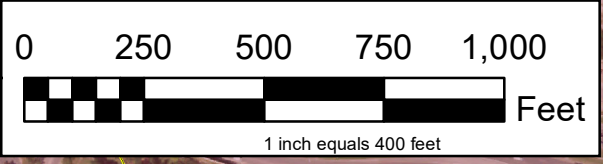
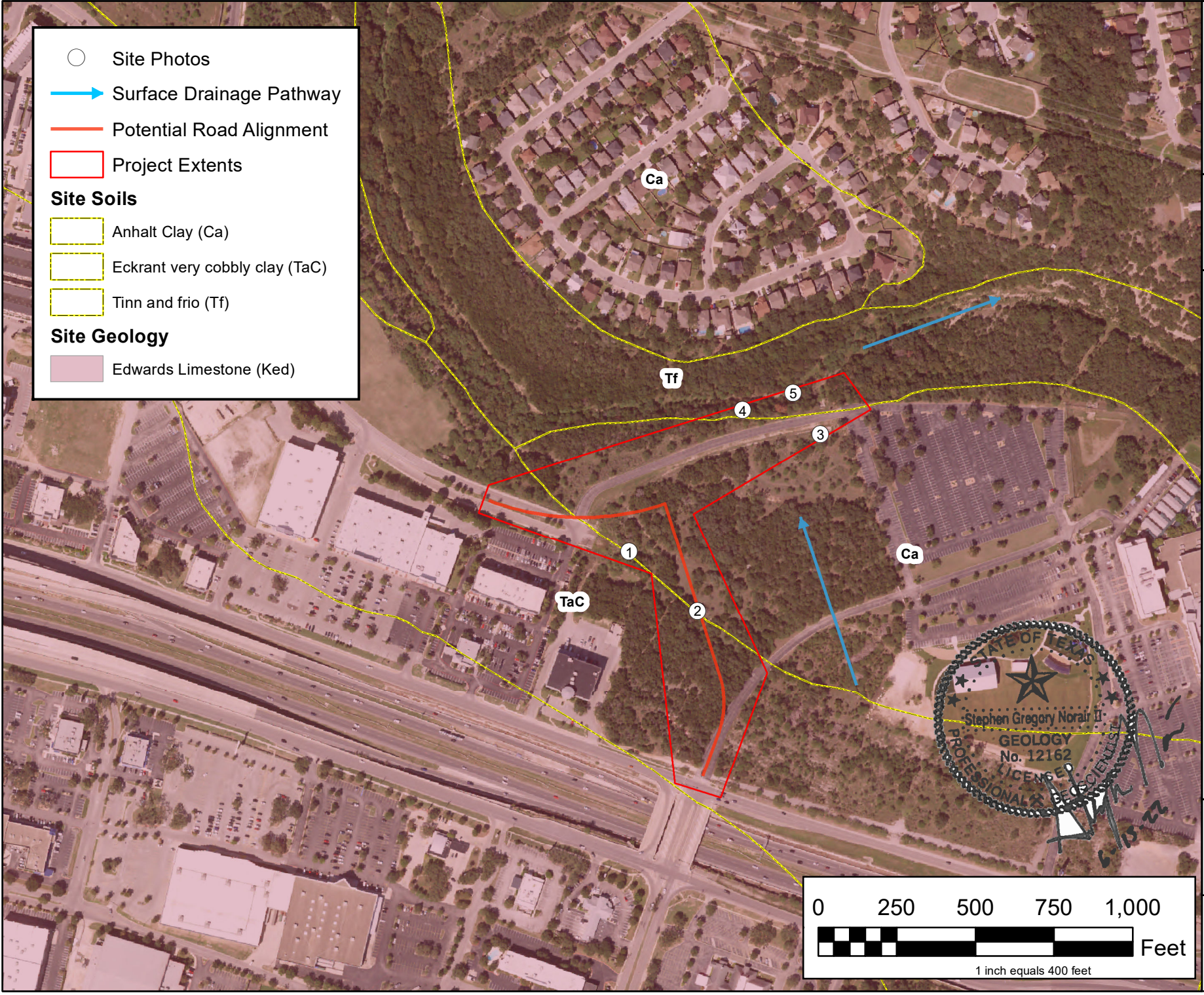

PROJECT NO.	SAT21877
DATE CREATED	Date: 03/20/22
DATUM & COORDINATE SYSTEM	NAD83 State Plane North Texas Central
FILE NAME	New_Altairm12162_Geology
PREPARED BY	SGN



CITY OF SAN ANTONIO

Gold Canyon and Sonterra Extension

Site Soils and Geology Map

FRESE NICHOLS
 FRESE AND NICHOLS, INC.
 9501 MCALLISTER HWY
 SUITE 1008
 SAN ANTONIO, TEXAS 78216
 PHONE: 210-298-3800
 FAX: 210-298-3801

Water Pollution Abatement Plan Application

Texas Commission on Environmental Quality

for Regulated Activities on the Edwards Aquifer Recharge Zone and Relating to 30 TAC §213.5(b), Effective June 1, 1999

To ensure that the application is administratively complete, confirm that all fields in the form are complete, verify that all requested information is provided, consistently reference the same site and contact person in all forms in the application, and ensure forms are signed by the appropriate party.

Note: Including all the information requested in the form and attachments contributes to more streamlined technical reviews.

Signature

To the best of my knowledge, the responses to this form accurately reflect all information requested concerning the proposed regulated activities and methods to protect the Edwards Aquifer. This **Water Pollution Abatement Plan Application Form** is hereby submitted for TCEQ review and Executive Director approval. The form was prepared by:

Print Name of Customer/Agent: Jose L. Reyes, PE

Date: 06/13/2023

Signature of Customer/Agent:



Regulated Entity Name: City of San Antonio

Regulated Entity Information

1. The type of project is:

- Residential: Number of Lots: _____
- Residential: Number of Living Unit Equivalents: _____
- Commercial
- Industrial
- Other: _____

2. Total site acreage (size of property): 4.44 ac

3. Estimated projected population: N/A

4. The amount and type of impervious cover expected after construction are shown below:

Table 1 - Impervious Cover Table

Impervious Cover of Proposed Project	Sq. Ft.	Sq. Ft./Acre	Acres
Structures/Rooftops	0	÷ 43,560 =	
Parking	0	÷ 43,560 =	
Other paved surfaces	450,282	÷ 43,560 =	3.45
Total Impervious Cover	450,282	÷ 43,560 =	3.45

Total Impervious Cover 3.45 ÷ Total Acreage 4.44 X 100 = 78% Impervious Cover

5. **Attachment A - Factors Affecting Surface Water Quality.** A detailed description of all factors that could affect surface water and groundwater quality that addresses ultimate land use is attached.
6. Only inert materials as defined by 30 TAC §330.2 will be used as fill material.

For Road Projects Only

Complete questions 7 - 12 if this application is exclusively for a road project.

7. Type of project:

- TXDOT road project.
- County road or roads built to county specifications.
- City thoroughfare or roads to be dedicated to a municipality.
- Street or road providing access to private driveways.

8. Type of pavement or road surface to be used:

- Concrete
- Asphaltic concrete pavement
- Other: _____

9. Length of Right of Way (R.O.W.): 1765 feet.

Width of R.O.W.: 86 feet.

L x W = 151,790 Ft² ÷ 43,560 Ft²/Acre = 3.48 acres.

10. Length of pavement area: 1765 feet.

Width of pavement area: 48 feet.

L x W = 127,080 Ft² ÷ 43,560 Ft²/Acre = 2.92 acres.

Pavement area 2.92 acres ÷ R.O.W. area 3.48 acres x 100 = 84% impervious cover.

11. A rest stop will be included in this project.
- A rest stop will not be included in this project.

12. Maintenance and repair of existing roadways that do not require approval from the TCEQ Executive Director. Modifications to existing roadways such as widening roads/adding shoulders totaling more than one-half (1/2) the width of one (1) existing lane require prior approval from the TCEQ.

Stormwater to be generated by the Proposed Project

13. **Attachment B - Volume and Character of Stormwater.** A detailed description of the volume (quantity) and character (quality) of the stormwater runoff which is expected to occur from the proposed project is attached. The estimates of stormwater runoff quality and quantity are based on the area and type of impervious cover. Include the runoff coefficient of the site for both pre-construction and post-construction conditions.

Wastewater to be generated by the Proposed Project

14. The character and volume of wastewater is shown below:

_____ % Domestic	_____ Gallons/day
_____ % Industrial	_____ Gallons/day
_____ % Commingled	_____ Gallons/day
TOTAL gallons/day <u>N/A</u>	

15. Wastewater will be disposed of by:

On-Site Sewage Facility (OSSF/Septic Tank):

Attachment C - Suitability Letter from Authorized Agent. An on-site sewage facility will be used to treat and dispose of the wastewater from this site. The appropriate licensing authority's (authorized agent) written approval is attached. It states that the land is suitable for the use of private sewage facilities and will meet or exceed the requirements for on-site sewage facilities as specified under 30 TAC Chapter 285 relating to On-site Sewage Facilities.

Each lot in this project/development is at least one (1) acre (43,560 square feet) in size. The system will be designed by a licensed professional engineer or registered sanitarian and installed by a licensed installer in compliance with 30 TAC Chapter 285.

Sewage Collection System (Sewer Lines):

Private service laterals from the wastewater generating facilities will be connected to an existing SCS.

Private service laterals from the wastewater generating facilities will be connected to a proposed SCS.

The SCS was previously submitted on _____.

The SCS was submitted with this application.

The SCS will be submitted at a later date. The owner is aware that the SCS may not be installed prior to Executive Director approval.

The sewage collection system will convey the wastewater to the _____ (name) Treatment Plant. The treatment facility is:

Existing.

Proposed.

16. All private service laterals will be inspected as required in 30 TAC §213.5.

Site Plan Requirements

Items 17 – 28 must be included on the Site Plan.

17. The Site Plan must have a minimum scale of 1" = 400'.

Site Plan Scale: 1" = 400'.

18. 100-year floodplain boundaries:

Some part(s) of the project site is located within the 100-year floodplain. The floodplain is shown and labeled.

No part of the project site is located within the 100-year floodplain.

The 100-year floodplain boundaries are based on the following specific (including date of material) sources(s): FIRM Map Panel 48029C0255G

19. The layout of the development is shown with existing and finished contours at appropriate, but not greater than ten-foot contour intervals. Lots, recreation centers, buildings, roads, open space, etc. are shown on the plan.

The layout of the development is shown with existing contours at appropriate, but not greater than ten-foot intervals. Finished topographic contours will not differ from the existing topographic configuration and are not shown. Lots, recreation centers, buildings, roads, open space, etc. are shown on the site plan.

20. All known wells (oil, water, unplugged, capped and/or abandoned, test holes, etc.):

There are _____ (#) wells present on the project site and the locations are shown and labeled. (Check all of the following that apply)

The wells are not in use and have been properly abandoned.

The wells are not in use and will be properly abandoned.

The wells are in use and comply with 16 TAC §76.

There are no wells or test holes of any kind known to exist on the project site.

21. Geologic or manmade features which are on the site:

All sensitive geologic or manmade features identified in the Geologic Assessment are shown and labeled.

No sensitive geologic or manmade features were identified in the Geologic Assessment.

Attachment D - Exception to the Required Geologic Assessment. A request and justification for an exception to a portion of the Geologic Assessment is attached.

- 22. The drainage patterns and approximate slopes anticipated after major grading activities.
- 23. Areas of soil disturbance and areas which will not be disturbed.
- 24. Locations of major structural and nonstructural controls. These are the temporary and permanent best management practices.
- 25. Locations where soil stabilization practices are expected to occur.
- 26. Surface waters (including wetlands).
 - N/A
- 27. Locations where stormwater discharges to surface water or sensitive features are to occur.
 - There will be no discharges to surface water or sensitive features.
- 28. Legal boundaries of the site are shown.

Administrative Information

- 29. Submit one (1) original and one (1) copy of the application, plus additional copies as needed for each affected incorporated city, groundwater conservation district, and county in which the project will be located. The TCEQ will distribute the additional copies to these jurisdictions. The copies must be submitted to the appropriate regional office.
- 30. Any modification of this WPAP will require Executive Director approval, prior to construction, and may require submission of a revised application, with appropriate fees.

Attachment A

Factors Affecting Surface Water Quality

Sources of potential pollution during construction consists of:

- Soil erosion due to clearing of site
- Contamination from construction equipment and vehicles, fuel, oil, and grease.
- Hydrocarbons from asphalt paving.
- Trash and litter from material wrapping and construction workers.
- Concrete truck washout
- potential spills from portable waste facilities

Water Pollution Abatement Plan Application

Attachment B

Volume and Character of Stormwater

Stormwater runoff from the site will increase as a result of development. For the 25-yr storm event, the site will generate approximately 105 cfs post development. Pre development runoff for this site is 96 cfs. The runoff coefficient for the site changes from approximately 0.93 before development to 0.97 after development. All values are based on the Rational Method using runoff coefficients from the San Antonio Unified Development Code.

Temporary Stormwater Section

Texas Commission on Environmental Quality

for Regulated Activities on the Edwards Aquifer Recharge Zone and Relating to 30 TAC §213.5(b)(4)(A), (B), (D)(I) and (G); Effective June 1, 1999

To ensure that the application is administratively complete, confirm that all fields in the form are complete, verify that all requested information is provided, consistently reference the same site and contact person in all forms in the application, and ensure forms are signed by the appropriate party.

Note: Including all the information requested in the form and attachments contributes to more streamlined technical reviews.

Signature

To the best of my knowledge, the responses to this form accurately reflect all information requested concerning the proposed regulated activities and methods to protect the Edwards Aquifer. This **Temporary Stormwater Section** is hereby submitted for TCEQ review and executive director approval. The application was prepared by:

Print Name of Customer/Agent: Jose L. Reyes, PE

Date: 06/13/2023

Signature of Customer/Agent:



Regulated Entity Name: Sonterra Road Extension Project

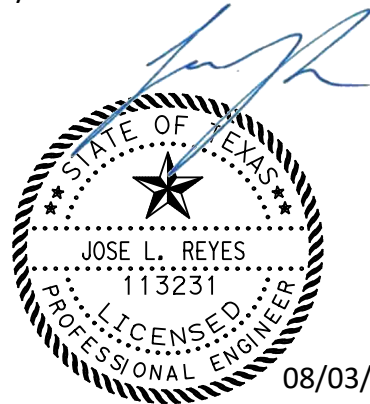

Project Information

Potential Sources of Contamination

Examples: Fuel storage and use, chemical storage and use, use of asphaltic products, construction vehicles tracking onto public roads, and existing solid waste.

1. Fuels for construction equipment and hazardous substances which will be used during construction:

The following fuels and/or hazardous substances will be stored on the site: _____

These fuels and/or hazardous substances will be stored in:

- Aboveground storage tanks with a cumulative storage capacity of less than 250 gallons will be stored on the site for less than one (1) year.

- Aboveground storage tanks with a cumulative storage capacity between 250 gallons and 499 gallons will be stored on the site for less than one (1) year.
- Aboveground storage tanks with a cumulative storage capacity of 500 gallons or more will be stored on the site. An Aboveground Storage Tank Facility Plan application must be submitted to the appropriate regional office of the TCEQ prior to moving the tanks onto the project.
- Fuels and hazardous substances will not be stored on the site.
- 2. **Attachment A - Spill Response Actions.** A site specific description of the measures to be taken to contain any spill of hydrocarbons or hazardous substances is attached.
- 3. Temporary aboveground storage tank systems of 250 gallons or more cumulative storage capacity must be located a minimum horizontal distance of 150 feet from any domestic, industrial, irrigation, or public water supply well, or other sensitive feature.
- 4. **Attachment B - Potential Sources of Contamination.** A description of any activities or processes which may be a potential source of contamination affecting surface water quality is attached.

Sequence of Construction

- 5. **Attachment C - Sequence of Major Activities.** A description of the sequence of major activities which will disturb soils for major portions of the site (grubbing, excavation, grading, utilities, and infrastructure installation) is attached.
 - For each activity described, an estimate (in acres) of the total area of the site to be disturbed by each activity is given.
 - For each activity described, include a description of appropriate temporary control measures and the general timing (or sequence) during the construction process that the measures will be implemented.
- 6. Name the receiving water(s) at or near the site which will be disturbed or which will receive discharges from disturbed areas of the project: Mud Creek

Temporary Best Management Practices (TBMPs)

Erosion control examples: tree protection, interceptor swales, level spreaders, outlet stabilization, blankets or matting, mulch, and sod. Sediment control examples: stabilized construction exit, silt fence, filter dikes, rock berms, buffer strips, sediment traps, and sediment basins. Please refer to the Technical Guidance Manual for guidelines and specifications. All structural BMPs must be shown on the site plan.

- 7. **Attachment D – Temporary Best Management Practices and Measures.** TBMPs and measures will prevent pollution of surface water, groundwater, and stormwater. The construction-phase BMPs for erosion and sediment controls have been designed to retain sediment on site to the extent practicable. The following information is attached:

- A description of how BMPs and measures will prevent pollution of surface water, groundwater or stormwater that originates upgradient from the site and flows across the site.
 - A description of how BMPs and measures will prevent pollution of surface water or groundwater that originates on-site or flows off site, including pollution caused by contaminated stormwater runoff from the site.
 - A description of how BMPs and measures will prevent pollutants from entering surface streams, sensitive features, or the aquifer.
 - A description of how, to the maximum extent practicable, BMPs and measures will maintain flow to naturally-occurring sensitive features identified in either the geologic assessment, TCEQ inspections, or during excavation, blasting, or construction.
8. The temporary sealing of a naturally-occurring sensitive feature which accepts recharge to the Edwards Aquifer as a temporary pollution abatement measure during active construction should be avoided.
- Attachment E - Request to Temporarily Seal a Feature.** A request to temporarily seal a feature is attached. The request includes justification as to why no reasonable and practicable alternative exists for each feature.
 - There will be no temporary sealing of naturally-occurring sensitive features on the site.
9. **Attachment F - Structural Practices.** A description of the structural practices that will be used to divert flows away from exposed soils, to store flows, or to otherwise limit runoff discharge of pollutants from exposed areas of the site is attached. Placement of structural practices in floodplains has been avoided.
10. **Attachment G - Drainage Area Map.** A drainage area map supporting the following requirements is attached:
- For areas that will have more than 10 acres within a common drainage area disturbed at one time, a sediment basin will be provided.
 - For areas that will have more than 10 acres within a common drainage area disturbed at one time, a smaller sediment basin and/or sediment trap(s) will be used.
 - For areas that will have more than 10 acres within a common drainage area disturbed at one time, a sediment basin or other equivalent controls are not attainable, but other TBMPs and measures will be used in combination to protect down slope and side slope boundaries of the construction area.
 - There are no areas greater than 10 acres within a common drainage area that will be disturbed at one time. A smaller sediment basin and/or sediment trap(s) will be used in combination with other erosion and sediment controls within each disturbed drainage area.

- There are no areas greater than 10 acres within a common drainage area that will be disturbed at one time. Erosion and sediment controls other than sediment basins or sediment traps within each disturbed drainage area will be used.
11. **Attachment H - Temporary Sediment Pond(s) Plans and Calculations.** Temporary sediment pond or basin construction plans and design calculations for a proposed temporary BMP or measure have been prepared by or under the direct supervision of a Texas Licensed Professional Engineer. All construction plans and design information must be signed, sealed, and dated by the Texas Licensed Professional Engineer. Construction plans for the proposed temporary BMPs and measures are attached.
- N/A
12. **Attachment I - Inspection and Maintenance for BMPs.** A plan for the inspection of each temporary BMP(s) and measure(s) and for their timely maintenance, repairs, and, if necessary, retrofit is attached. A description of the documentation procedures, recordkeeping practices, and inspection frequency are included in the plan and are specific to the site and/or BMP.
13. All control measures must be properly selected, installed, and maintained in accordance with the manufacturer's specifications and good engineering practices. If periodic inspections by the applicant or the executive director, or other information indicate a control has been used inappropriately, or incorrectly, the applicant must replace or modify the control for site situations.
14. If sediment escapes the construction site, off-site accumulations of sediment must be removed at a frequency sufficient to minimize offsite impacts to water quality (e.g., fugitive sediment in street being washed into surface streams or sensitive features by the next rain).
15. Sediment must be removed from sediment traps or sedimentation ponds not later than when design capacity has been reduced by 50%. A permanent stake will be provided that can indicate when the sediment occupies 50% of the basin volume.
16. Litter, construction debris, and construction chemicals exposed to stormwater shall be prevented from becoming a pollutant source for stormwater discharges (e.g., screening outfalls, picked up daily).

Soil Stabilization Practices

Examples: establishment of temporary vegetation, establishment of permanent vegetation, mulching, geotextiles, sod stabilization, vegetative buffer strips, protection of trees, or preservation of mature vegetation.

17. **Attachment J - Schedule of Interim and Permanent Soil Stabilization Practices.** A schedule of the interim and permanent soil stabilization practices for the site is attached.

18. Records must be kept at the site of the dates when major grading activities occur, the dates when construction activities temporarily or permanently cease on a portion of the site, and the dates when stabilization measures are initiated.
19. Stabilization practices must be initiated as soon as practicable where construction activities have temporarily or permanently ceased.

Administrative Information

20. All structural controls will be inspected and maintained according to the submitted and approved operation and maintenance plan for the project.
21. If any geologic or manmade features, such as caves, faults, sinkholes, etc., are discovered, all regulated activities near the feature will be immediately suspended. The appropriate TCEQ Regional Office shall be immediately notified. Regulated activities must cease and not continue until the TCEQ has reviewed and approved the methods proposed to protect the aquifer from any adverse impacts.
22. Silt fences, diversion berms, and other temporary erosion and sediment controls will be constructed and maintained as appropriate to prevent pollutants from entering sensitive features discovered during construction.

TEMPORARY STORMWATER SECTION ATTACHMENTS

ATTACHMENT A — Spill Response Actions

The Contractor is required to remediate any spills, and to immediately report spills (including sanitary sewer discharge) of reportable quantities to the following:

- *To the National Response Center at (800) 424-8802,
- *To the Edwards Aquifer Authority at (210) 222-2204,
- *To the San Antonio Water Systems (SAWS) at (210) 704-7297 and one of the following:

To the State Emergency Response Center (800) 832-8224 (if after hours), or to the TCEQ San Antonio Regional Office (210) 490-3096 (if during business hours).

This section describes measures to prevent or reduce the discharge of pollutants to drainage systems or watercourses from leaks and spills by reducing the chance for spills, stopping the source of spills, containing, and cleaning up spills, properly disposing of spill materials, and training employees.

The following steps will help reduce the storm water impacts of leaks and spills:
Education

- (1) Be aware that different materials pollute in different amounts. Make sure that each employee knows what a “significant spill” is for each material they use, and what is the appropriate response for “significant” and “insignificant” spills. Employees should also be aware of when spill must be reported to the TCEQ. Information available in 30 TAC 327.4 and 40 CFR 302.4.
- (2) Educate employees and subcontractors on potential dangers to humans and the environment from spills and leaks.
- (3) Hold regular meetings to discuss and reinforce appropriate disposal procedures (incorporate into regular safety meetings).
- (4) Establish a continuing education program to indoctrinate new employees.
- (5) Have contractor’s superintendent or representative oversee and enforce proper spill prevention and control measures.

General Measures

- (1) To the extent that the work can be accomplished safely, spills of oil, petroleum products, and substances listed under 40 CFR parts 110,117, and 302, and sanitary and septic wastes should be contained and cleaned up immediately.
- (2) Store hazardous materials and wastes in covered containers and protect from vandalism.
- (3) Place a stockpile of spill cleanup materials where it will be readily accessible.
- (4) Train employees in spill prevention and cleanup.

- (5) Designate responsible individuals to oversee and enforce control measures.
- (6) Spills should be covered and protected from storm water runoff during rainfall to the extent that it does not compromise clean-up activities.
- (7) Do not bury or wash spills with water.
- (8) Store and dispose of used clean up materials, contaminated materials, and recovered spill material that is no longer suitable for the intended purpose in conformance with the provisions in applicable BMPs.
- (9) Do not allow water used for cleaning and decontamination to enter storm drains or watercourses. Collect and dispose of contaminated water in accordance with applicable regulations.
- (10) Contain water overflow or minor water spillage and do not allow it to discharge into drainage facilities or watercourses.
- (11) Place Material Safety Data Sheets (MSDS), as well as proper storage, cleanup, and spill reporting instructions for hazardous materials stored or used on the project site in an open, conspicuous, and accessible location.
- (12) Keep waste storage areas clean, well-organized, and equipped with ample cleanup supplies as appropriate for the materials being stored. Perimeter controls, containment structures, covers, and liners should be repaired or replaced as needed to maintain proper function.

Cleanup

- (1) Clean up leaks and spills immediately.
- (2) Use a rag for small spills on paved surfaces, a damp mop for general cleanup, and absorbent material for larger spills. If the spilled material is hazardous, then the used cleanup materials are also hazardous and must be disposed of as hazardous waste.
- (3) Never hose down or bury dry material spills. Clean up as much of the material as possible and dispose of properly. See the waste management BMPs in this section for specific information.

Minor Spills

- (1) Minor spills typically involve small quantities of oil, gasoline, paint, etc. which can be controlled by the first responder at the discovery of the spill.
- (2) Use absorbent materials on small spills rather than hosing down or burying the spill.
- (3) Absorbent materials should be promptly removed and disposed of properly.
- (4) Follow the practice below for a minor spill:
- (5) Contain the spread of the spill.
- (6) Recover spilled materials.
- (7) Clean the contaminated area and properly dispose of contaminated materials.

Semi-Significant Spills

Semi-significant spills still can be controlled by the first responder along with the aid of other personnel such as laborers and the foreman, etc. This response may require the cessation of all other activities.

Spills should be cleaned up immediately:

- (1) Contain spread of the spill.
- (2) Notify the project foreman immediately.
- (3) If the spill occurs on paved or impermeable surfaces, clean up using "dry" methods (absorbent materials, cat litter and/or rags). Contain the spill by encircling with absorbent materials and do not let the spill spread widely.
- (4) If the spill occurs in dirt areas, immediately contain the spill by constructing an earthen dike. Dig up and properly dispose of contaminated soil.
- (5) If the spill occurs during rain, cover spill with tarps or other material to prevent contaminating runoff.

Significant/Hazardous Spills

For significant or hazardous spills that are in reportable quantities:

- (1) Notify the TCEQ by telephone as soon as possible and within 24 hours at 210-490-3096 (San Antonio) between 8 AM and 5 PM. After hours, contact the Environmental Release Hotline at 1-800-832-8224. It is the contractor's responsibility to have all emergency phone numbers at the construction site.
- (2) For spills of federal reportable quantities, in conformance with the requirements in 40 CFR parts 110, 119, and 302, the contractor should notify the National Response Center at (800) 424-8802.
- (3) Notification should first be made by telephone and followed up with a written report.
- (4) The services of a spill's contractor or a Haz-Mat team should be obtained immediately. Construction personnel should not attempt to clean up until the appropriate and qualified staffs have arrived at the job site.
- (5) Other agencies which may need to be consulted include, but are not limited to, the City Police Department, County Sheriff Office, Fire Departments, etc.

More information on spill rules and appropriate responses is available on the TCEQ website at: http://www.tnrcc.state.tx.us/enforcement/emergency_response.html

Vehicle and Equipment Maintenance

- (1) If maintenance must occur onsite, use a designated area and a secondary containment, located away from drainage courses, to prevent the run-on of storm water and the runoff of spills.
- (2) Regularly inspect onsite vehicles and equipment for leaks and repair immediately.
- (3) Check incoming vehicles and equipment (including delivery trucks, and employee and subcontractor vehicles) for leaking oil and fluids. Do not allow leaking vehicles or equipment onsite.
- (4) Always use secondary containment, such as a drain pan or drop cloth, to catch spills or leaks when removing or changing fluids.
- (5) Place drip pans or absorbent materials under paving equipment when not in use.
- (6) Use absorbent materials on small spills rather than hosing down or burying the spill. Remove the absorbent materials promptly and dispose of properly.

- (7) Promptly transfer used fluids to the proper waste or recycling drums. Do not leave full drip pans or other open containers lying around.
- (8) Oil filters disposed of in trashcans or dumpsters can leak oil and pollute storm water. Place the oil filter in a funnel over a waste oil-recycling drum to drain excess oil before disposal. Oil filters can also be recycled. Ask the oil supplier or recycler about recycling oil filters.
- (9) Store cracked batteries in a non-leaking secondary container. Do this with all cracked batteries even if you think all the acid has drained out. If you drop a battery, treat it as if it is cracked. Put it into the containment area until you are sure it is not leaking.

Vehicle and Equipment Fueling

- (1) If fueling must occur on site, use designated areas, located away from drainage courses, to prevent the run-on of storm water and the runoff of spills.
- (2) Discourage "topping off" of fuel tanks.
- (3) Always use secondary containment, such as a drain pan, when fueling to catch spills/ leaks.

ATTACHMENT B — Potential Sources of Contamination

Potential sources of contamination include the hydrocarbons, hydraulic fluid and fuels required to service and operate the construction equipment, the materials and liquids used to conduct paving operations, various paints and solvents, and soil disturbed and mobilized during excavation. Additional sources of contamination include spills associated with vehicle accidents that might occur within the boundaries of the project.

ATTACHMENT C — Sequence of Major Events

1. Install erosion and sedimentation controls down-slope of work area and initiate SWPPP inspection and maintenance activities. Post the required SWPPP site notification.
2. Provide written notification to the TCEQ 48 hours prior to commencement of construction. Schedule an on-site pre-construction coordination meeting, if applicable.
3. Begin phased construction including the following:
 - **Phase 1:** Erect barricades closing Sonterra Blvd at the project limits. Driveway 2-1 is closed during construction and traffic will be redirected to other driveways from within the property. Driveway 3-1 is open to allow traffic through community bible church property and Gold Canyon. Driveway 4-1 will be closed and community bible church will redirect traffic within their property to other driveways on the property. Construct roadway and storm drain along Sonterra Blvd., the roundabout, the drainage outfall, and driveways 3-1 and 4-1. Gold Canyon to remain open during this phase. Sonterra will be reopened at the completion of phase 1 existing traffic signal operations at loop 1604 WB Frontage Road to remain. Contractor to construct water lines and sewer lines as shown in saws joint bid plans.
 - **Phase 2:** Construct full width of the proposed Gold Canyon extension roadway and storm drain from loop 1604 WB Frontage Rd to through the north of driveway 2-1 connection to the roundabout connection. Traffic control devices are placed through Sonterra to allow access along Sonterra but access through Gold Canyon is closed.
 - **Phase 3 Step 1:** Erect warning signs at Lp 1604 WB Frontage Rd and Gold Canyon bridge. Erect traffic control devices that close the outside lane of the Lp 1604 WB Frontage Rd. Install operational temporary traffic signal assembly at northwest corner of the intersection between Gold Canyon and the Lp 1604 WB Frontage Road to control new northbound traffic conditions from the Gold Canyon/Lp 1604 bridge. Place temporary striping through the intersection of Gold Canyon and Lp 1604 WB Frontage Rd. Maintain northbound traffic on existing driveway 2-1. Place traffic control devices southbound driveway 2-1 directing traffic within community bible church. Construct west half of proposed Gold Canyon roadway to station 13+82.16, just south of proposed driveway 2-1. Construct proposed pedestrian signal poles at the north-east corner of the intersection between Gold Canyon and the Lp 1604 WB Frontage Rd.
 - **Phase 3 Step 2:** Switch traffic onto recently constructed west half of Gold Canyon. Reconfigure temporary traffic signal assembly at the intersection between Gold Canyon and WB Lp 1604 Frontage Road to the edge of work zone. Place temporary striping through the intersection of Gold Canyon and WB Lp 1604 Frontage Rd. Access will be closed to existing driveway with placement of traffic control devices at community bible church

fence/boundary. Demolish remaining pavement of existing driveway 2-1 south of proposed tie in location. Proposed driveway 2-1 to be constructed, signing and barricades will be implemented. Contractor to place advance signing of closure along Gold Canyon that will be constructed. Construct east half of the Gold Canyon from the WB Lp 1604 Frontage Rd to station 13+82.16 including roadway, sidewalk, and center median. Construct traffic signal pole and pedestrian signal pole at the north-east corner of the intersection between Gold Canyon and the Wb Lp 1604 Frontage Road.

- **Phase 4:** Open full access of the Gold Canyon extension. Place proposed traffic signal infrastructure into operation. Place final course of asphalt paving, final landscaping, and final signing and pavement markings. Remove traffic control devices and temporary traffic signal from Lp 1604 Frontage Rd.
4. Remove temporary erosion/sedimentation controls once disturbed areas are re-vegetated. Restore all areas disturbed by the removal of E&S controls.
 5. Provide final notification of completion of construction in compliance with TCEQ and SWPPP requirements.

The receiving waters are Mud Creek.

ATTACHMENT D – Temporary Best Management Practices

During the construction phase, the BMPs selected for the water quality protection include the following:

- Silt fences on the upstream side of disturbed areas to route flow around work area limiting the flow over the work area.
- Curb Inlet Gravel Filter installed along the gutter line of E. Sonterra Blvd and Gold Canyon Rd to limit pollutants leaving the site along the curb and gutter.
- Rock Filter Dams installed around the 4-way inlets located along the Gold Canyon Rd to limit pollutants leaving the site.
- Erosion Control Matting installed along the proposed ROW on the west side of the Gold Canyon Rd to mitigate high velocities and reduce erosion.
- Construction exits will be used to minimize offsite tracking of sediment. The locations of all temporary BMPs are shown on the Temporary Erosion and Sedimentation Control Plan sheets. Standard details show information relevant to BMP installation and maintenance. The locations of staging areas will be determined by the contractor. Appropriate erosion controls will be utilized to prevent sediment discharges from the staging areas.

The locations of all temporary BMPs are shown on the WPAP SW3P plan sheets. Standard details show information relevant to BMP installation and maintenance. The locations of staging areas will be determined by the contractor. Appropriate erosion control will be utilized to prevent sediment discharges from staging areas.

Texas Commission on Environmental Quality
 Water Pollution Abatement Plan
 General Construction Notes

1. A written notice of construction must be submitted to the TCEQ regional office at least 48 hours prior to the start of any regulated activities. This notice must include:
 - the name of the approved project;
 - the activity start date; and
 - the contact information of the prime contractor.
2. All contractors conducting regulated activities associated with this project must be provided with complete copies of the approved Water Pollution Abatement Plan (WPAP) and the TCEQ letter indicating the specific conditions of its approval. During the course of these regulated activities, the contractors are required to keep on-site copies of the approved plan and approval letter.
3. If any sensitive feature(s) (caves, solution cavity, sink hole, etc.) is discovered during construction, all regulated activities near the sensitive feature must be suspended immediately. The appropriate TCEQ regional office must be immediately notified of any sensitive features encountered during construction. Construction activities may not be resumed until the TCEQ has reviewed and approved the appropriate protective measures in order to protect any sensitive feature and the Edwards Aquifer from potentially adverse impacts to water quality.
4. No temporary or permanent hazardous substance storage tank shall be installed within 150 feet of a water supply source, distribution system, well, or sensitive feature.
5. Prior to beginning any construction activity, all temporary erosion and sedimentation (E&S) control measures must be properly installed and maintained in accordance with the manufacturers specifications. If inspections indicate a control has been used inappropriately, or incorrectly, the applicant must replace or modify the control for site situations. These controls must remain in place until the disturbed areas have been permanently stabilized.
6. Any sediment that escapes the construction site must be collected and properly disposed of before the next rain event to ensure it is not washed into surface streams, sensitive features, etc.
7. Sediment must be removed from the sediment traps or sedimentation basins no later than when it occupies 50% of the basin's design capacity.
8. Litter, construction debris, and construction chemicals exposed to stormwater shall be prevented from being discharged offsite.
9. All excavated material that will be stored on-site must have proper E&S controls. For storage or disposal of spoils at another site on the Edwards Aquifer Recharge Zone, the owner of the site must receive approval of a water pollution abatement plan for the placement of fill material or mass grading prior to the placement of spoils at the other site.
10. If portions of the site will have a cease in construction activity lasting longer than 14 days, soil stabilization in those areas shall be initiated as soon as possible prior to the 14th day of inactivity. If activity will resume prior to the 21st day, stabilization measures are not required. If drought conditions or inclement weather prevent action by the 14th day, stabilization measures shall be initiated as soon as possible.
11. The following records should be maintained and made available to the TCEQ upon request:
 - the dates when major grading activities occur;
 - the dates when construction activities temporarily or permanently cease on a portion of the site; and
 - the dates when stabilization measures are initiated.
12. The holder of any approved Edward's Aquifer protection plan must notify the appropriate regional office in writing and obtain approval from the executive director prior to initiating any of the following:
 - A. any physical or operational modification of any best management practices (BMPs) or structure(s), including but not limited to temporary or permanent ponds, dams, berms, silt fences, and diversionary structures;
 - B. any change in the nature or character of the regulated activity from that which was originally approved;
 - C. any change that would significantly impact the ability to prevent pollution of the Edwards Aquifer; or
 - D. any development of land previously identified as undeveloped in the approved contributing zone plan.

Austin Regional Office
 12100 Park 35 Circle, Bldg A
 Austin, Texas 78753-1808
 Phone (512) 339-2929
 Fax (512) 339-3795

San Antonio Regional Office
 14250 Judson Road
 San Antonio, Texas 78233-4480
 Phone (210) 490-3096
 Fax (210) 545-4329

MAESTAS 8122 DATAPOINT DR., STE. 840
 SAN ANTONIO, TX 78229
 (210) 366-1988
 TBPE No.: F-333
 TBPLS No.: 10194506



NO:	DATE	REVISION	APPROVED BY







Freese and Nichols, Inc.
 Texas Registered Engineering Firm F-2144
FREESE AND NICHOLS 9601 McAllister Freeway, Suite 1008
 San Antonio, Texas 78216
 Phone - (210) 298-3800
 web - www.freese.com

CITY OF SAN ANTONIO
 PUBLIC WORKS DEPARTMENT

SONTERRA ROAD EXTENSION
 TEMPORARY STORMWATER POLLUTION
 PREVENTION PLAN NOTES

PRELIMINARY	PROJECT NO.:	23-01849	DATE:	8/3/2023	
DRWN. BY:	GC	DSGN. BY:	GC	CHKD. BY:	JR
SHEET 1 OF 1			SHEET 1 OF 1		

LEGEND

-  INLET PROTECTION
-  SEDIMENT CONTROL FENCE
-  FLOW ARROW
-  ROCK FILTER DAM
-  BUFFALO SODDING
-  -930- EXISTING CONTOURS
-  -930- PROPOSED CONTOURS

SW3P QUANTITIES			
ITEM NO	DESCRIPTION	UNIT	QUANTITY
516.3	BUFFALO SODDING	SY	1015
540.6	CONSTRUCTION EXITS (INSTALL/REMOVE)	SY	156
540.9	TEMPORARY SEDIMENT CONTROL FENCE	LF	293

NOTE: CONSTRUCTION EXITS WILL BE PAID FOR BY COSA ITEM 540.6 "CONSTRUCTION EXITS (INSTALL/REMOVE)". THE LOCATIONS OF THE CONSTRUCTION EXITS WILL BE DETERMINED IN THE FIELD AND APPROVED BY COSA INSPECTION.

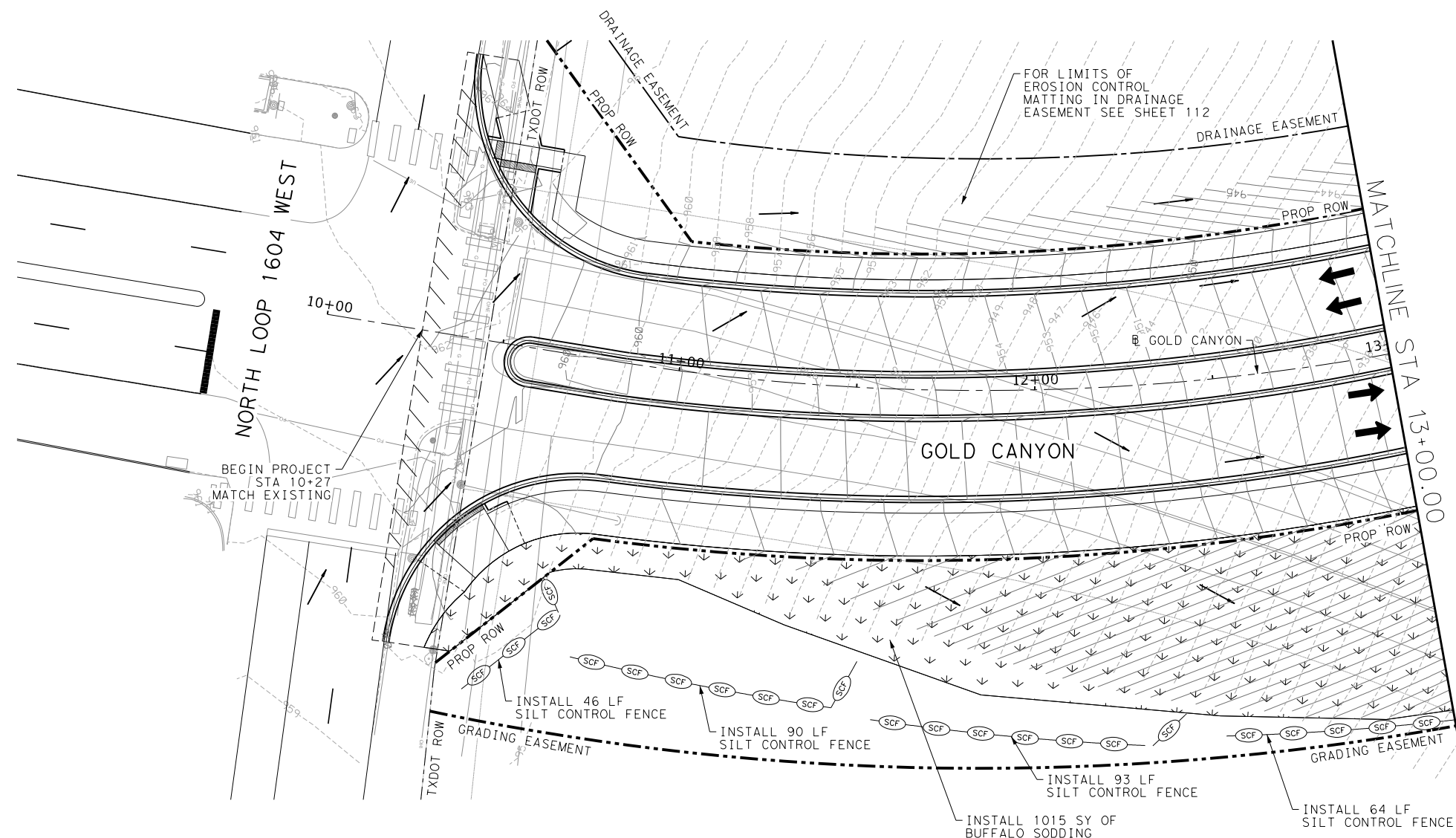

FREESE AND NICHOLS, INC.
TEXAS REGISTERED ENGINEERING FIRM F-2144



BREGGER A. GARRISON
122018
LICENSED PROFESSIONAL ENGINEER
08/04/2023

NO.	DATE	REVISION	APPROVED BY

FREESE AND NICHOLS
 9601 McAllister Freeway, Suite 1008
 San Antonio, Texas 78216
 Phone - (210) 298-3800
 web - www.freese.com

CITY OF SAN ANTONIO
 PUBLIC WORKS DEPARTMENT

SONTERRA ROAD EXTENSION
STORM WATER POLLUTION PREVENTION PLAN (SW3P)
 BEGIN TO STA 13+00

95% SUBMITTAL	PROJECT NO.: 23-01849	DATE: 08/03/2023
DRWN. BY: JL	DSGN. BY: NS	CHKD. BY: BAG
SHEET 134 OF 197		

MicroStation V8 User: 02911 Office: pw\freese-pw-bentley.com\freese-pw-01\Documents\FNI - Texas\SA121921 (Transportation)\2 Drawings\2.04 Infrastructure\2.04.02 Sheets\2.04.02.09 Environmental\CV-TRT-PL-SW3P01.dgn
 Plotter: c:\program files\plotters\epson\epson5100.ppt
 Plot Scale: 40,000
 Date: Aug 04, 2023 4:05:18 PM Project: Freese and Nichols, Inc.

MicroStation V8 User: 02911 Office: C:\Users\jgarrison\Documents\FN - Texas\SA121921 (Transportation)\2 Drawings\2.04 Infrastructure\2.04.02 Sheets\2.04.02.09 Environmental\CV-TRT-PL-SW3P02.dgn
 Plotter: c:\users\jgarrison\Documents\FN - Texas\SA121921 (Transportation)\2 Drawings\2.04 Infrastructure\2.04.02 Sheets\2.04.02.09 Environmental\CV-TRT-PL-SW3P02.dgn
 Plot Scale: 40,000
 Date: Aug 04, 2023 05:06:38 PM Project: Freese and Nichols, Inc.

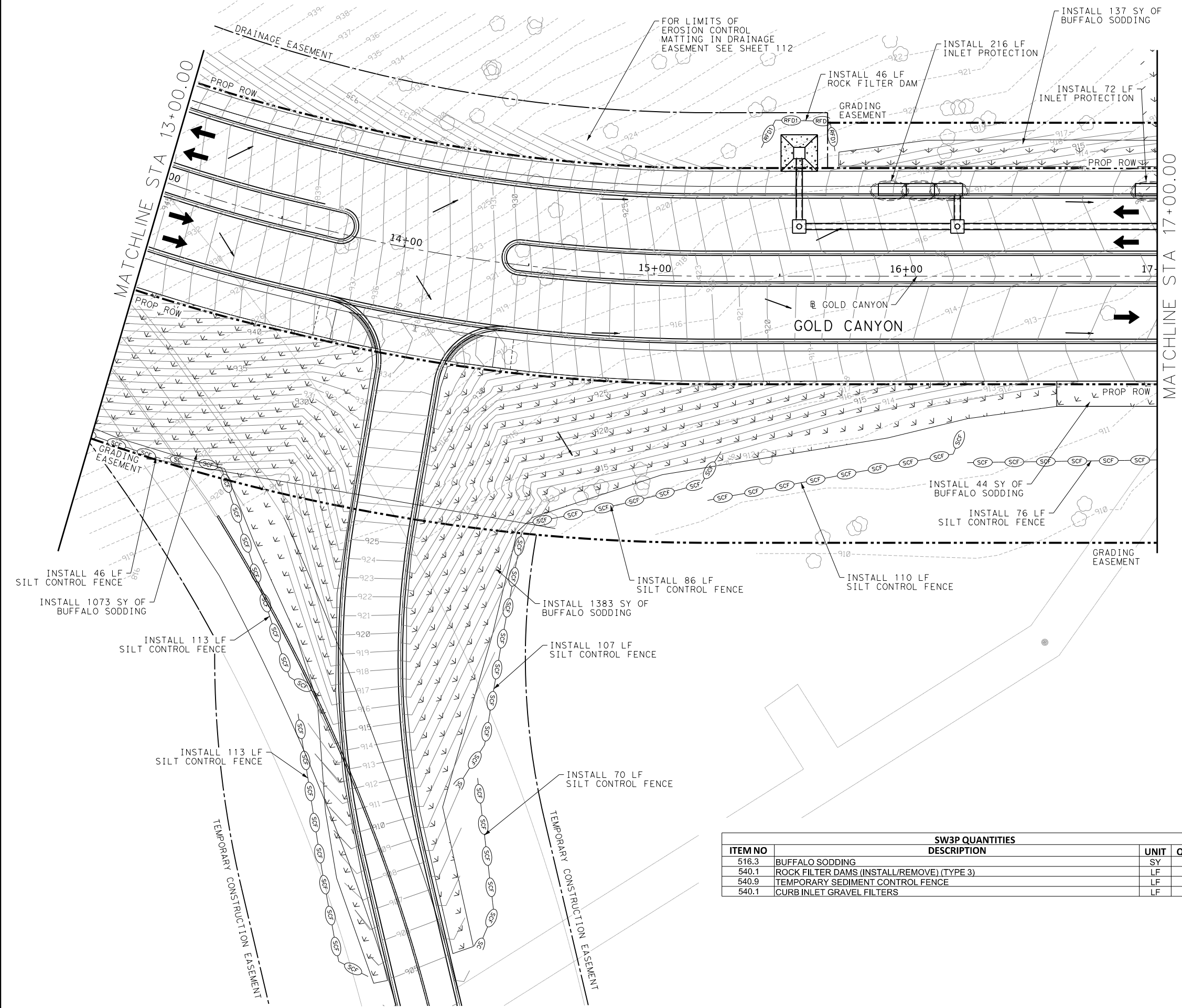

LEGEND

	INLET PROTECTION
	SEDIMENT CONTROL FENCE
	FLOW ARROW
	ROCK FILTER DAM
	BUFFALO SODDING
	EXISTING CONTOURS
	PROPOSED CONTOURS

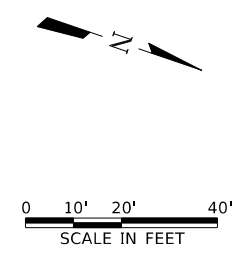

ITEM NO	SW3P QUANTITIES DESCRIPTION	UNIT	QUANTITY
516.3	BUFFALO SODDING	SY	2637
540.1	ROCK FILTER DAMS (INSTALL/REMOVE) (TYPE 3)	LF	46
540.9	TEMPORARY SEDIMENT CONTROL FENCE	LF	721
540.1	CURB INLET GRAVEL FILTERS	LF	288

FREESE AND NICHOLS, INC.
TEXAS REGISTERED ENGINEERING FIRM F-2144

NO.	DATE	REVISION	APPROVED BY

Freese and Nichols, Inc.
 Texas Registered Engineering Firm F-2144
 9601 McAllister Freeway, Suite 1008
 San Antonio, Texas 78216
 Phone - (210) 298-3800
 web - www.freese.com

CITY OF SAN ANTONIO
 PUBLIC WORKS DEPARTMENT

SONTERRA ROAD EXTENSION
STORM WATER POLLUTION PREVENTION PLAN (SW3P)
 STA 13+00 TO STA 17+00

95% SUBMITTAL	PROJECT NO.: 23-01849	DATE: 08/03/2023
DRWN. BY: JL	DSGN. BY: NS	CHKD. BY: BAG
SHEET 135 OF 197		

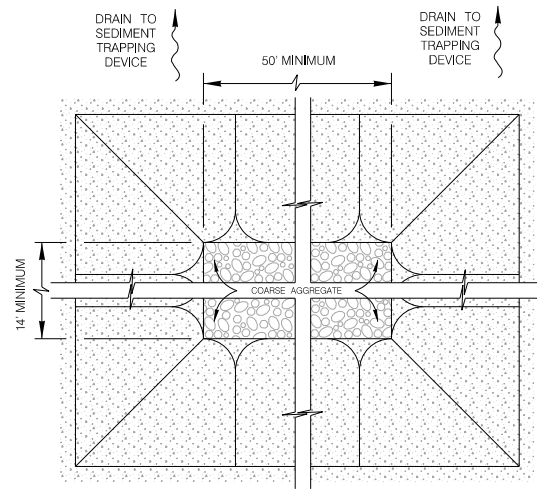

PLAN
SCALE : 1" = 6'

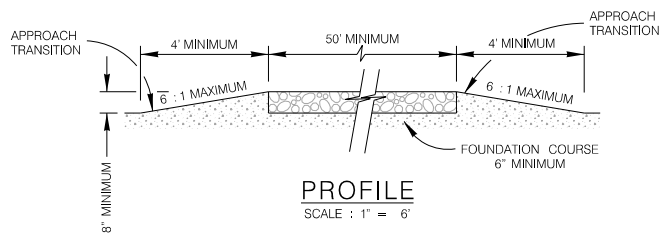

PROFILE
SCALE : 1" = 6'

GENERAL NOTES

1. THE LENGTH OF THE TYPE 1 CONSTRUCTION EXIT SHALL BE AS INDICATED ON THE PLANS, BUT NOT LESS THAN 50'.
2. THE COARSE AGGREGATE SHOULD BE OPEN GRADED WITH A SIZE OF 4" TO 8".
3. THE APPROACH TRANSITIONS SHOULD BE NO STEEPER THAN 6:1 AND CONSTRUCTED AS DIRECTED BY THE ENGINEER.
4. THE CONSTRUCTION EXIT FOUNDATION COURSE SHALL BE FLEXIBLE BASE, BITUMINOUS CONCRETE, PORTLAND CEMENT CONCRETE OR OTHER MATERIAL AS APPROVED BY THE ENGINEER.
5. THE CONSTRUCTION EXIT SHALL BE GRADED TO ALLOW DRAINAGE TO A SEDIMENT TRAPPING DEVICE.
6. THE GUIDELINES SHOWN HEREON ARE SUGGESTIONS ONLY AND MAY BE MODIFIED BY THE ENGINEER.

CONSTRUCTION EXIT - TYPE 1

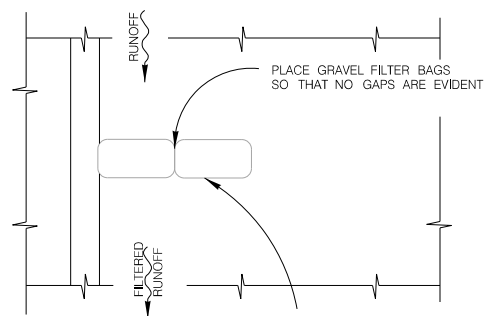

PLAN
SCALE : 1" = 5'

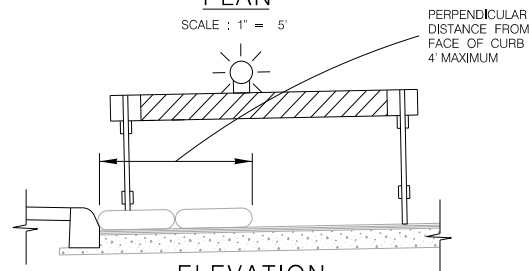

ELEVATION
SCALE : 1" = 5'

NOTE: STRADDLE GRAVEL FILTER BAGS WITH TYPE 1 BARRICADES MOUNTED WITH TYPE "A" FLASHING WARNING LIGHT. SEE BARRICADE CONSTRUCTION SIGN DETAILS. PLACE FLASHING LIGHTS AWAY FROM GUTTER, FLUSH WITH OUTSIDE EDGE OF BAG CONFIGURATION.

GRAVEL FILTER BAGS

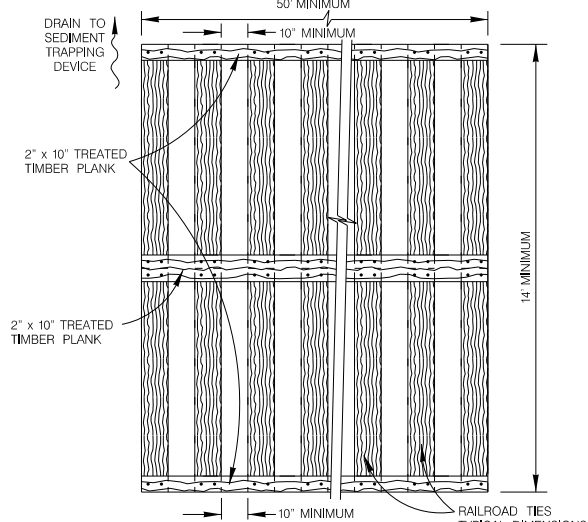

PLAN
SCALE : 1" = 6'

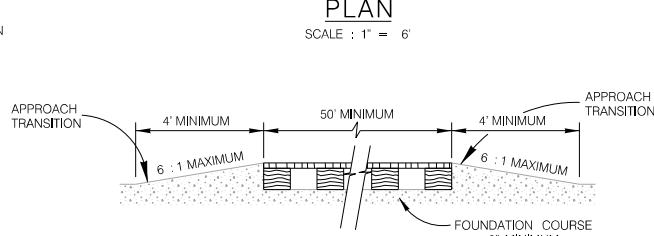

PROFILE
SCALE : 1" = 6'

GENERAL NOTES

1. THE LENGTH OF THE TYPE 2 CONSTRUCTION EXIT SHALL BE AS INDICATED ON THE PLANS, BUT NOT LESS THAN 50'.
2. THE TREATED TIMBER PLANKS SHALL BE ATTACHED TO THE RAILROAD TIES WITH 1/2" x 6" MIN. LAG BOLTS. OTHER FASTENERS MAY BE USED AS APPROVED BY THE ENGINEER.
3. THE TREATED TIMBER PLANKS SHALL BE #2 GRADE MIN. AND SHOULD BE FREE FROM LARGE AND LOOSE KNOTS.
4. THE APPROACH TRANSITIONS SHOULD BE NO STEEPER THAN 6:1 AND CONSTRUCTED AS DIRECTED BY THE ENGINEER.
5. THE CONSTRUCTION EXIT FOUNDATION COURSE SHALL BE FLEXIBLE BASE, BITUMINOUS CONCRETE, PORTLAND CEMENT CONCRETE OR OTHER MATERIAL AS APPROVED BY THE ENGINEER.
6. THE CONSTRUCTION EXIT SHOULD BE GRADED TO ALLOW DRAINAGE TO A SEDIMENT TRAPPING DEVICE.
7. THE GUIDELINES SHOWN HEREON ARE SUGGESTIONS ONLY AND MAY BE MODIFIED BY THE ENGINEER.

CONSTRUCTION EXIT - TYPE 2

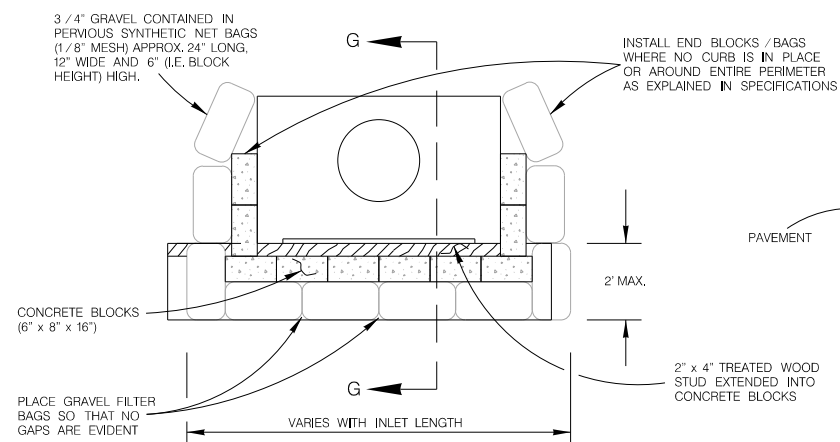

PLAN
SCALE : 1" = 5'

NOTE: GRAVEL FILTERS CAN BE USED ON PAVEMENT OR BARE GROUND.

CURB INLET GRAVEL FILTER

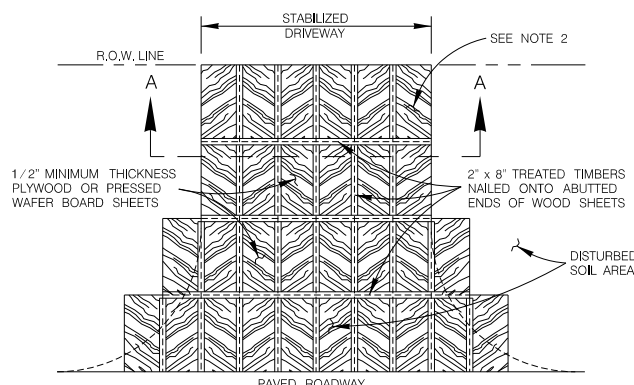

PLAN
SCALE : 1" = 20'

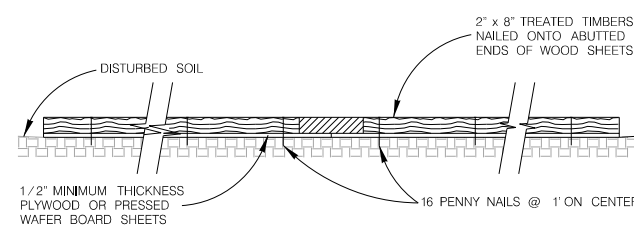

SECTION A-A
SCALE : 1" = 2'

GENERAL NOTES

1. THE LENGTH OF THE TYPE 3 CONSTRUCTION EXIT SHALL BE AS INDICATED ON THE PLANS, OR AS DIRECTED BY THE ENGINEER.
2. THE TYPE 3 CONSTRUCTION EXIT MAY BE CONSTRUCTED FROM OPEN GRADED CRUSHED STONE WITH A SIZE OF 2 TO 4 INCHES SPREAD A MINIMUM OF 4 INCHES THICK TO THE LIMITS SHOWN ON THE PLANS.
3. THE TREATED TIMBER PLANKS SHALL BE #2 GRADE MIN. AND SHOULD BE FREE FROM LARGE AND LOOSE KNOTS.
4. THE GUIDELINES SHOWN HEREON ARE SUGGESTIONS ONLY AND MAY BE MODIFIED BY THE ENGINEER.

CONSTRUCTION EXIT - TYPE 3

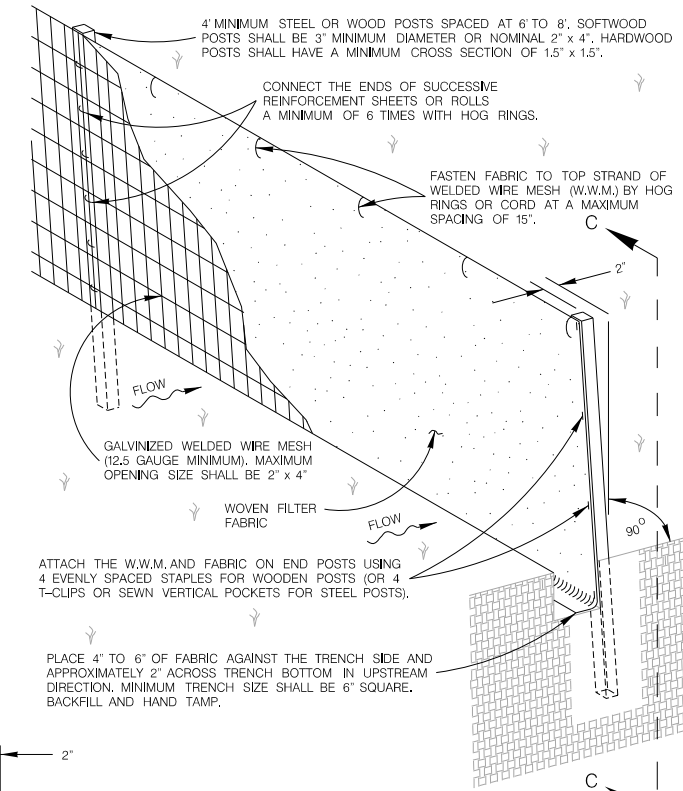

ISOMETRIC VIEW
SCALE : 1" = 2'

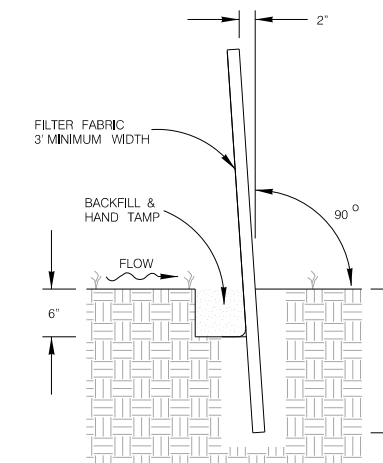

SECTION C-C
SCALE : 1" = 2'

SEDIMENT CONTROL FENCE USAGE GUIDELINES

A SEDIMENT CONTROL FENCE MAY BE CONSTRUCTED NEAR THE DOWNSTREAM PERIMETER OF A DISTURBED AREA ALONG A CONTOUR TO INTERCEPT SEDIMENT FROM OVERLAND RUN-OFF. A 2 YEAR STORM FREQUENCY MAY BE USED TO CALCULATE THE FLOW RATE TO BE FILTERED.

SEDIMENT CONTROL FENCE SHOULD BE SIZED TO FILTER A MAXIMUM FLOW THRU RATE OF 100 GPM / FT SQUARED. SEDIMENT CONTROL FENCE IS NOT RECOMMENDED TO CONTROL EROSION FROM A DRAINAGE AREA LARGER THAN 2 ACRES.

GENERAL NOTES

1. THE GUIDELINES SHOWN HEREON ARE SUGGESTIONS ONLY AND MAY BE MODIFIED BY THE ENGINEER.

TEMPORARY SEDIMENT CONTROL FENCE

JANUARY 2005

CITY OF SAN ANTONIO
CAPITAL IMPROVEMENTS MANAGEMENT SERVICES DEPARTMENT

TEMPORARY EROSION, SEDIMENT & WATER POLLUTION CONTROL MEASURES STANDARDS 1

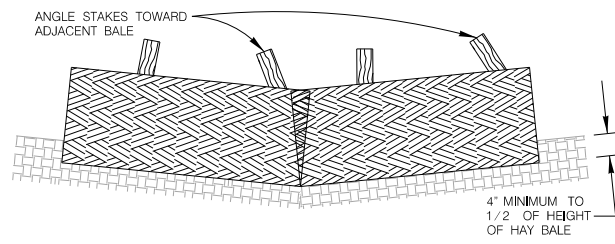

PROFILE VIEW
SCALE : 1" = 2'

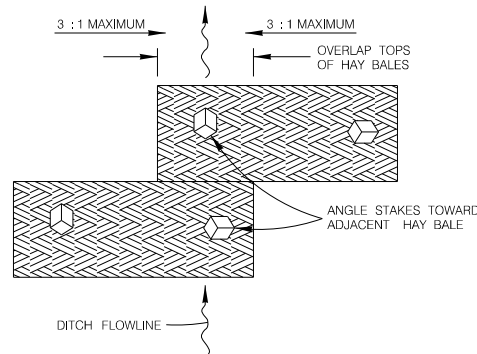

PLAN VIEW
SCALE : 1" = 2'

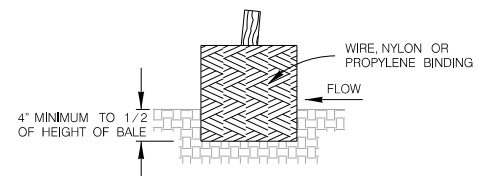

SECTION B-B
SCALE : 1" = 2'

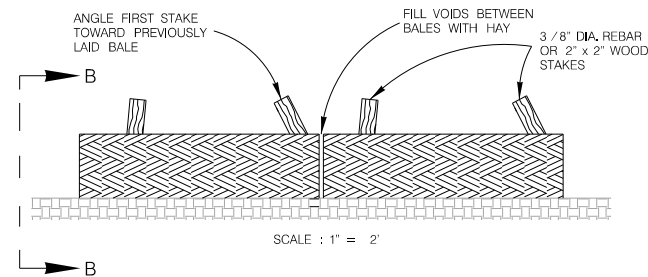

BALED HAY USAGE GUIDELINES

A BALED HAY INSTALLATION MAY BE CONSTRUCTED NEAR THE DOWNSTREAM PERIMETER OF A DISTURBED AREA ALONG A CONTOUR TO INTERCEPT SEDIMENT FROM OVERLAND RUNOFF. A TWO YEAR STORM FREQUENCY MAY BE USED TO CALCULATE THE FLOW RATE TO BE FILTERED. THE INSTALLATION SHOULD BE SIZED TO FILTER A MAXIMUM FLOW THRU RATE OF 5 GPM /FT SQUARED OF CROSS SECTIONAL AREA. BALED HAY MAY BE USED AT THE FOLLOWING LOCATIONS:

1. WHERE THE RUNOFF APPROACHING THE BALED HAY FLOWS OVER DISTURBED SOIL FOR LESS THAN 100'. IF THE SLOPE OF THE DISTURBED SOIL EXCEEDS 10 %, THE LENGTH OF SLOPE UPSTREAM OF THE BALED HAY SHOULD BE LESS THAN 50'.
2. WHERE THE INSTALLATION WILL BE REQUIRED FOR LESS THAN 3 MONTHS.
3. WHERE THE CONTRIBUTING DRAINAGE AREA IS LESS THAN 1/2 ACRE.

FOR BALED HAY INSTALLATIONS IN SMALL DITCHES, THE FOLLOWING ADDITIONAL CONDI-TIONAL CONSIDERATIONS APPLY:

1. THE DITCH SIDESLOPES SHOULD BE GRADED AS FLAT AS POSSIBLE TO MAXIMIZE THE DRAINAGE FLOW RATE THRU THE HAY.
2. THE DITCH SHOULD BE GRADED LARGE ENOUGH TO CONTAIN THE OVERLAPPING DRAINAGE WHEN SEDIMENT HAS FILLED TO THE TOP OF THE BALED HAY.

BALES SHOULD BE REPLACED USUALLY EVERY 2 MONTHS OR MORE OFTEN DURING WET WEATHER WHEN LOSS OF STRUCTURAL INTEGRITY IS ACCELERATED.

GENERAL NOTES

1. HAY BALES SHALL BE A MINIMUM OF 30" IN LENGTH AND WEIGH A MINIMUM OF 50 LBS.
2. HAY BALES SHALL BE BOUND BY EITHER WIRE OR NYLON OR POLYPROPYLENE STRING. THE BALES SHALL BE COMPOSED ENTIRELY OF VEGETABLE MATTER.
3. HAY BALES SHALL BE EMBEDDED IN THE SOIL A MINIMUM OF 4" AND, WHERE POSSIBLE, ONE-HALF THE HEIGHT OF THE BAILE.
4. HAY BALES SHALL BE PLACED IN A ROW WITH ENDS TIGHTLY ABUTTING THE ADJACENT BAILES. THE BALES SHALL BE PLACED WITH BINDINGS PARALLEL TO THE GROUND.
5. HAY BALES SHALL BE SECURELY ANCHORED IN PLACE WITH 3/8" DIA. REBAR OR 2" x 2" WOOD STAKES DRIVEN THROUGH THE BAILES. THE FIRST STAKE SHALL BE ANGLED TO-WARDS THE PREVIOUSLY LAID BAILE TO FORCE THE BAILES TOGETHER.
6. THE GUIDELINES SHOWN HEREON ARE SUGGESTIONS ONLY AND MAY BE MODIFIED BY THE ENGINEER.

BALED HAY FOR EROSION CONTROL

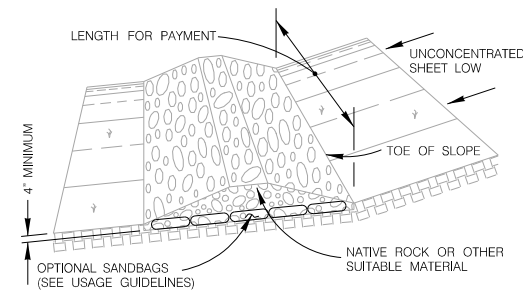

TYPE 1 FILTER DAM AT TOE OF SLOPE
SCALE : 1" = 10'

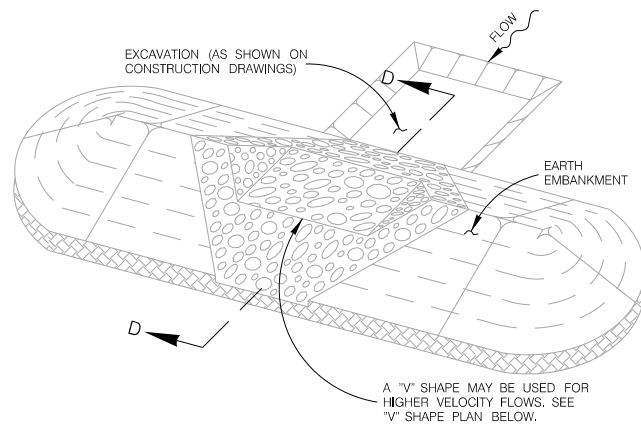

TYPE 1 & 2 FILTER DAM AT SEDIMENT TRAP
SCALE : 1" = 10'

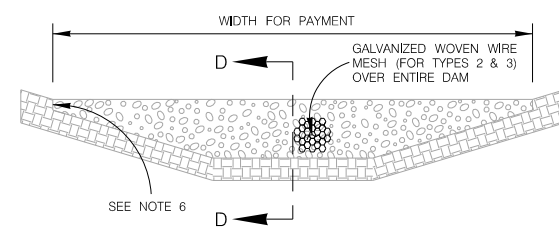

TYPE 1, 2 & 3 FILTER DAM AT CHANNEL SECTIONS
SCALE : 1" = 6'

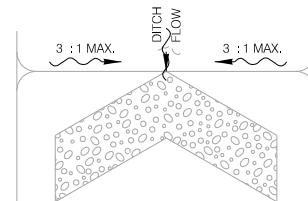

"V" SHAPE PLAN VIEW
NOT TO SCALE

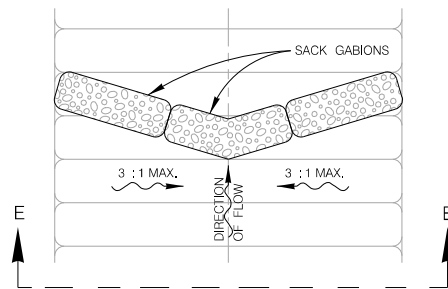

PLAN VIEW
SCALE : 1" = 10'

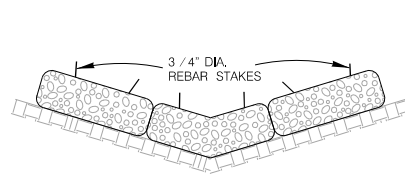

SECTION E-E
SCALE : 1" = 10'

TYPE 4 FILTER DAM AT DITCHES & SMALLER CHANNELS PLAN VIEW

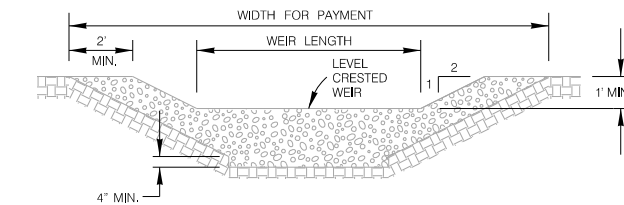

PROFILE OF TYPE 1 & 2 FILTER DAM AT SEDIMENT TRAP
SCALE : 1" = 6'

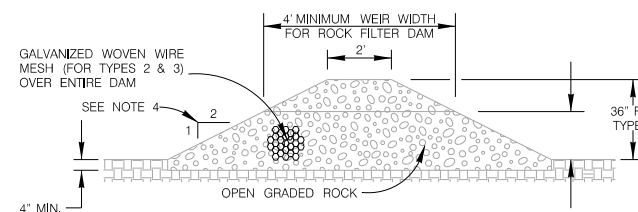

SECTION D-D
SCALE : 1" = 6'

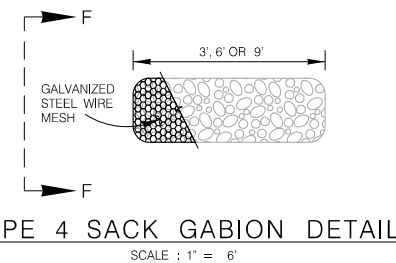

TYPE 4 SACK GABION DETAIL
SCALE : 1" = 6'

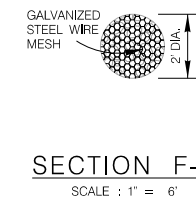

SECTION F-F
SCALE : 1" = 6'

ROCK FILTER DAM USAGE GUIDELINES

ROCK FILTER DAMS SHOULD BE CONSTRUCTED DOWNSTREAM FROM DISTURBED AREAS TO INTERCEPT SEDIMENT FROM OVERLOAD RUNOFF AND /OR CONCENTRATED FLOW. THE DAMS SHOULD BE SIZED TO FILTER A MAXIMUM FLOW THRU RATE OF 60 GPM /FT SQUARED OF CROSS SECTIONAL AREA. A 2 YEAR STORM FREQUENCY MAY BE USED TO CALCULATE THE FLOW RATE.

TYPE 1 (18" HIGH WITH NO WIRE MESH):

TYPE 1 MAY BE USED AT THE TOE OF SLOPES, AROUND INLETS, IN SMALL DITCHES AND AT DIKE OR SWALE OUTLETS. THIS TYPE OF DAM IS RECOMMENDED TO CONTROL EROSION FROM A DRAINAGE AREA OF 5 ACRES OR LESS. TYPE 1 MAY NOT BE USED IN CONCENTRATED HIGH VELOCITY FLOWS (APPROXIMATELY 8 FT./SEC. OR MORE) IN WHICH AGGREGATE WASH OUT MAY OCCUR. SANDBAGS MAY BE USED AT THE EMBEDDED FOUNDATION (4" DEEP MIN.) FOR BETTER FILTERING EFFICIENCY OF LOW FLOWS IF CALLED FOR ON THE PLANS OR AS DIRECTED BY THE ENGINEER.

TYPE 2 (18" HIGH WITH WIRE MESH):

TYPE 2 MAY BE USED IN DITCHES AND AT DIKE OR SWALE OUTLETS.

TYPE 3 (36" HIGH WITH WIRE MESH):

TYPE 3 MAY BE USED IN STREAM FLOW AND SHOULD BE SECURED TO THE STREAM BED.

TYPE 4 (SACK GABIONS):

TYPE 4 MAY BE USED IN DITCHES AND SMALLER CHANNELS TO FORM AN EROSION CONTROL DAM.

GENERAL NOTES

1. IF SHOWN ON THE PLANS OR DIRECTED BY THE ENGINEER, FILTER DAMS SHOULD BE PLACED NEAR THE TOE OF SLOPES WHERE EROSION IS ANTICIPATED, UPSTREAM AND / OR DOWNSTREAM AT DRAINAGE STRUCTURES, AND IN ROADWAY DITCHES AND CHANNELS TO COLLECT SEDIMENT.
2. MATERIALS (AGGREGATE, WIRE MESH, SANDBAGS, ETC.) SHALL BE AS INDICATED BY THE SPECIFICATION FOR ROCK FILTER DAMS FOR EROSION AND SEDIMENTATION CONTROL.
3. THE ROCK FILTER DAM DIMENSIONS SHALL BE AS INDICATED ON THE STORM WATER POLLUTION PREVENTION PLANS.
4. SIDE SLOPES SHOULD BE 2 : 1 OR FLATTER. DAMS WITHIN THE SAFETY ZONE SHALL HAVE SIDE SLOPES OF 6 : 1 OR FLATTER.
5. MAINTAIN A MINIMUM OF 1' BETWEEN TOP OF ROCK FILTER DAM WEIR AND TOP OF EMBANKMENT FOR FILTER DAMS AT SEDIMENT TRAPS.
6. FILTER DAMS SHOULD BE EMBEDDED A MINIMUM OF 4" INTO THE EXISTING GROUND.
7. THE SEDIMENT TRAP FOR PONDING OF SEDIMENT LADEN RUNOFF SHALL BE OF THE DIMENSIONS SHOWN ON THE PLANS.
8. ROCK FILTER DAM TYPES 2 & 3 SHALL BE SECURED WITH 20 GAUGE GALVANIZED WOVEN WIRE MESH WITH 1" DIAMETER HEXAGONAL OPENINGS. THE AGGREGATE SHALL BE PLACED ON THE MESH TO THE HEIGHT AND SLOPES SPECIFIED. THE MESH SHALL BE FOLDED AT THE UPSTREAM SIDE OVER THE AGGREGATE AND TIGHTLY SECURED TO ITSELF ON THE DOWNSTREAM SIDE USING WIRE TIES OR HOG RINGS. IN STREAM USE, THE MESH SHOULD BE SECURED OR STAKED TO THE STREAM BED PRIOR TO AGGREGATE PLACEMENT.
9. SACK GABIONS SHOULD BE STAKED DOWN WITH 3/4" DIA. REBAR STAKES.
10. FLOW OUTLET SHOULD BE ONTO A STABILIZED AREA (VEGETATION, ROCK, ETC.).
11. THE GUIDELINES SHOWN HEREON ARE SUGGESTIONS ONLY AND MAY BE MODIFIED BY THE ENGINEER.

JANUARY 2005

CITY OF SAN ANTONIO
CAPITAL IMPROVEMENTS MANAGEMENT SERVICES DEPARTMENT

TEMPORARY EROSION, SEDIMENT & WATER POLLUTION CONTROL MEASURES STANDARDS 2

ATTACHMENT E – Request to Temporarily Seal a Feature

Not applicable.

ATTACHMENT F – Structural Practices

Sediment generated by the proposed activities will be controlled through the use of silt fencing, gravel filter bags, erosion control matting and rock filter dams. Construction vehicle traffic will be routed in a manner to avoid, where possible, creating loose sediment or mud that could enter waterways.

ATTACHMENT G – Drainage Area Map

Attached – see the following sheet.

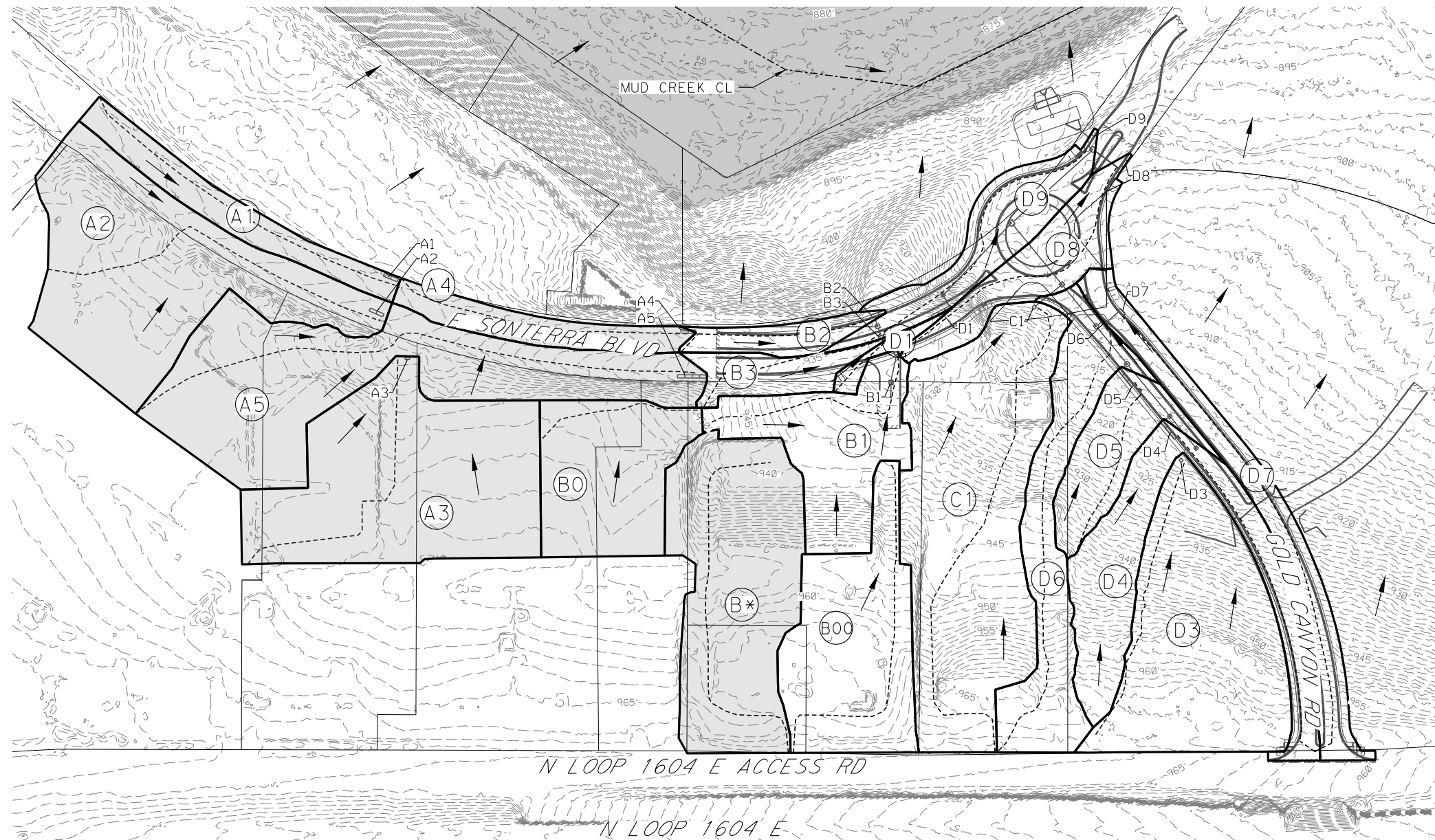

LEGEND

- (XX) DRAINAGE AREA
- DRAINAGE AREA BOUNDARY
- - - - FLOWPATH
- FLOW DIRECTION
- - - - xxx' - - - 1-FOOT CONTOUR
- BCAD PARCEL
- FEMA 100-YEAR FLOODPLAIN ZONE AE
- DRAINAGE AREAS NOT PART OF PROJECT AREA BUT USED TO OBTAIN BY-PASS FLOW IN GEOPAK MODEL



SCALE
1" = 200'

NOTES:

1. CONTOURS WERE DERIVED FROM TO 2017 LIDAR.
2. RAINFALL INTENSITIES CORRESPOND TO THE ATLAS 14 VALUES DISTRIBUTED BY THE CITY OF SAN ANTONIO.
3. HYDROLOGIC COMPUTATIONS BASED ON ULTIMATE DEVELOPMENT CONDITIONS.

Ultimate Development Time of Concentration Calculations

Basin	Precipitation Area	Sheet Flow					Shallow Concentrated				Total Tc (min)
		L (ft)	n	S (ft/ft)	P (in)	Tc (min)	L (ft)	S (ft/ft)	Surface	Tc (min)	
A1	2	100	0.01	0.01	4.04	5.0	440.45	0.01	PAVED	3.00	8.03
A2	2	100	0.01	0.02	4.04	5.0	34.25	0.03	UNPAVED	0.19	7.34
A3	2	100	0.01	0.01	4.04	5.0	427.02	0.03	PAVED	2.15	6.91
A4	2	100	0.01	0.02	4.04	5.0	356.91	0.03	PAVED	1.67	6.67
A5	2	100	0.01	0.00	4.04	5.0	42.46	0.07	UNPAVED	0.17	8.57
B*	2	100	0.01	0.04	4.04	5.0	745.41	0.03	PAVED	3.40	6.94
B0	2	100	0.01	0.02	4.04	5.0	505.60	0.05	PAVED	1.94	6.94
B00	2	100	0.01	0.03	4.04	5.0	167.57	0.04	PAVED	0.65	6.65
B1	2	100	0.01	0.08	4.04	5.0	469.28	0.05	PAVED	1.70	6.70
B2	2	36	0.01	0.08	4.04	5.0	288.74	0.06	PAVED	0.99	5.99
B3	2	57	0.01	0.19	4.04	5.0	269.87	0.04	PAVED	1.10	6.10
C1	2	100	0.01	0.03	4.04	5.0	244.94	0.04	PAVED	1.02	6.02
D1	2	100	0.01	0.12	4.04	5.0	347.44	0.06	PAVED	1.21	7.17
D3	2	100	0.01	0.04	4.04	5.0	368.99	0.10	PAVED	0.96	6.96
D4	2	42	0.01	0.14	4.04	5.0	92.58	0.08	PAVED	0.27	5.27
D5	2	100	0.01	0.13	4.04	5.0	347.56	0.12	PAVED	0.82	5.82
D6	2	100	0.01	0.03	4.04	5.0	512.31	0.09	PAVED	1.41	6.41
D7	2	31	0.01	0.12	4.04	5.0	151.90	0.12	PAVED	0.37	5.46
D8	2	38	0.01	0.30	4.04	5.0	28.08	0.06	PAVED	0.10	6.78
D9	2	49	0.01	0.20	4.04	5.0	303.72	0.07	PAVED	0.93	6.78

Ultimate Development Rational Q Values

Basin	Precipitation Area	AREA (AC)	Tc (min)	C	Intensity (in/hr)					Flows (cfs)				
					I - 2YR	I - 5YR	I - 10YR	I - 25YR	I - 100YR	Q - 2YR	Q - 5YR	Q - 10YR	Q - 25YR	Q - 100YR
A1	2	0.57	8.00	0.91	5.45	6.67	8.04	9.61	12.16	2.84	3.58	4.19	4.98	6.33
A2	2	2.33	7.34	0.97	5.70	7.17	8.39	10.03	12.69	12.87	16.20	18.96	22.35	28.68
A3	2	2.32	6.91	0.97	5.70	7.17	8.39	10.03	12.69	12.82	16.14	18.89	22.68	28.57
A4	2	0.44	6.67	0.95	5.70	7.17	8.39	10.03	12.69	2.38	3.00	3.51	4.25	5.30
A5	2	2.41	8.57	0.97	5.24	6.60	7.73	9.23	11.68	12.27	15.47	18.10	22.01	27.36
B*	2	1.92	6.94	0.97	5.70	7.17	8.39	10.03	12.69	10.59	13.33	15.61	18.66	23.60
B0	2	1.11	6.94	0.97	5.70	7.17	8.39	10.03	12.69	6.11	7.70	9.01	11.54	13.63
B00	2	1.42	5.65	0.97	5.98	7.52	8.80	10.53	13.30	8.23	10.35	12.11	14.02	18.30
B1	2	1.05	5.99	0.97	5.98	7.52	8.80	10.53	13.30	6.07	7.63	8.92	10.69	13.48
B2	2	0.27	6.10	0.97	5.98	7.52	8.80	10.53	13.30	1.55	1.95	2.28	2.72	3.45
B3	2	0.34	6.02	0.97	5.98	7.52	8.80	10.53	13.30	1.96	2.46	2.88	3.44	4.35
C1	2	2.74	7.17	0.97	5.70	7.17	8.39	10.03	12.69	15.12	19.03	22.28	26.44	33.70
D1	2	0.09	5.27	0.97	6.34	7.94	9.29	11.14	14.01	0.55	0.69	0.81	0.95	1.22
D3	2	2.00	5.82	0.97	5.98	7.52	8.80	10.53	13.30	11.58	14.56	17.03	20.64	25.75
D4	2	1.27	6.41	0.97	5.98	7.52	8.80	10.53	13.30	7.36	9.25	10.83	12.71	16.36
D5	2	0.59	5.46	0.97	6.34	7.94	9.29	11.14	14.01	3.63	4.55	5.32	6.22	8.03
D6	2	1.19	6.78	0.97	5.70	7.17	8.39	10.03	12.69	6.60	8.30	9.72	11.28	14.70
D7	2	0.83	7.28	0.97	5.70	7.17	8.39	10.03	12.69	4.85	6.11	7.15	8.45	10.82
D8	2	0.647	6.67	0.97	5.70	7.17	8.39	10.03	12.69	3.58	4.50	5.27	6.40	7.97
D9	2	0.603	6.61	0.97	5.70	7.17	8.39	10.03	12.69	3.32	4.18	4.90	5.99	7.41

MAESTAS 8122 DATAPoint DR., STE. 840
SAN ANTONIO, TX 78229
(210) 366-1988
TBPE No.: F-333
TBPLS No.: 10194506

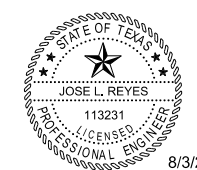

8/3/2023

NO.	DATE	REVISION	APPROVED BY

Freese and Nichols, Inc.
Texas Registered Engineering Firm F-2144
FREESE & NICHOLS 9601 McAllister Freeway, Suite 1008
San Antonio, Texas 78216
Phone - (210) 298-3800
web - www.freese.com

CITY OF SAN ANTONIO
PUBLIC WORKS DEPARTMENT

SONTERRA ROAD EXTENSION
DRAINAGE AREA MAP

PRELIMINARY	PROJECT NO.:	23-01849	DATE:	8/3/2023	
DRWN. BY:	GC	DSGN. BY:	GC	CHKD. BY:	JR

SHEET 1 OF 1

SHEET 86 OF 179

Date: 8/2/2023

ATTACHMENT H – Temporary Sediment Pond Plan and Calculations

Sediment ponds are not planned for this project.

ATTACHMENT I – Inspection and Maintenance

Key to maintaining the performance of and efficiency of the temporary BMPs is inspection and repair when needed. The project will use an established schedule of inspection to identify the weak or failing sections of the sediment controls and institute repairs immediately to ensure the continued performance of the installed BMPs. BMPs will be inspected at least weekly and after each rain event. Damaged BMPs will either be repaired or replaced as needed. Staging of the project activities will also be used to reduce the amount of ground damage to minimize the potential for sediment to enter the waterways. The areas adjacent to creeks and drainage ways shall have priority followed by protecting storm sewer inlets. If storms damage the BMPs, efforts will be made to immediately to restore them to original performance levels.

Silt Fence

- (1) Inspection will be made weekly or after each rainfall event and repair or replacement should be made promptly as needed by the contractor.
- (2) Remove sediment when buildup reaches 6 inches. Accumulated silt will be removed after each rainfall and disposed of in a manner which will not cause additional siltation.
- (3) Replace any torn fabric or install a second line of fencing parallel to the torn section.
- (4) Dikes will be Inspected and realigned as needed to prevent gaps between sections.
- (5) Replace or repair any sections crushed or collapsed during construction activity. If a section of fence is obstructing vehicular access, consider relocating it to a spot where it will provide equal protection, but will not obstruct vehicles. A triangular filter dike may be preferable to a silt fence at common vehicle access points.
- (6) When construction is complete, the sediment should be disposed of in a manner that will not cause additional siltation and the prior location of the silt fence should be revegetated. The fence itself should be disposed of in an approved landfill.

Construction Exit

- (1) Inspection will be made weekly or after each rainfall event and repair or replacement should be made promptly as needed by the contractor.
- (2) The entrance should be maintained in a condition, which will prevent tracking or flowing of sediment onto public rights-of-way. This may require periodic top dressing with additional stone as conditions demand and repair and/or cleanout of any measures used to trap sediment.
- (3) All sediment spilled, dropped, washed, or tracked onto public rights-of-way should be removed immediately by contractor.
- (4) When necessary, wheels should be cleaned to remove sediment prior to entrance onto public right-of-way.

- (5) When washing is required, it should be done on an area stabilized with crushed stone that drains into an approved sediment trap or sediment basin.
- (6) All sediment should be prevented from entering any storm drain, ditch, or water course by using approved methods.

Gravel Filter Bags

- (1) Inspection should be made weekly and after each rainfall by the responsible party. For installations in streambeds, additional daily inspections should be made. Repair or replacement should be made promptly as needed by the contractor.
- (2) Remove sediment when buildup reaches a depth of 3 inches. Removed sediment should be deposited in a suitable area and in such a manner that it will not erode.
- (3) Check placement of device to prevent gaps between device and curb.
- (4) Any loose gravel and torn bags will be repaired.
- (5) The berm will be reshaped as needed during inspection.
- (6) The berm will be replaced when the structure ceases to function as intended due to silt accumulation among the rocks, washout, construction traffic damage, etc.
- (7) The rock filter bags will be left in place until all upstream areas are stabilized and accumulated silt removed.

Rock Filter Dams

- (1) Inspection should be made weekly and after each rainfall by the responsible party. For installations in streambeds, additional daily inspections should be made. Repair or replacement should be made promptly as needed by the contractor.
- (2) Remove sediment and debris when buildup reaches 6 inches and dispose of the accumulated silt in an approved manner that will not cause any additional siltation.
- (3) Repair any loose wire sheathing.
- (4) The berm will be reshaped as needed during inspection.
- (5) The berm will be replaced when the structure ceases to function as intended due to silt accumulation among the rocks, washout, construction traffic damage, etc.
- (6) The rock filter dams will be left in place until all upstream areas are stabilized and accumulated silt removed.

Erosion Control Matting

- (1) Inspection should be made weekly and after each rainfall by the responsible party. For installations in streambeds, additional daily inspections should be made. Repair or replacement should be made promptly as needed by the contractor.
- (2) Damage from storms or normal construction activities such as tire ruts or disturbance should be repaired as soon as practical.

ATTACHMENT J – Schedule of Interim and Permanent Soil Stabilization Practices

Interim on-site stabilization measures, which are continuous, will include minimizing soil disturbances by exposing the smallest practical area of land required for the shortest period of time and maximizing use of natural vegetation. As soon as practical, all disturbed soil will be stabilized as per project specifications in accordance with pages 1-35 to 1-60 of TCEQ's Technical Guidance Manual (TGM) RG-348 (2005). Mulching, netting, erosion blankets and seeding are acceptable.

The management of land by using ground cover reduces erosion by reducing the flow rate of runoff and the raindrop impact. Bare soils should be seeded or otherwise stabilized within 14 calendar days after final grading or where construction activity has temporarily ceased for more than 21 days. Stabilization will involve simply sodding and fertilizing. Sediment that has escaped the site due to the failure of sediment and erosion controls should be removed as soon as possible to minimize offsite impacts. Permission should be obtained from adjacent landowners prior to offsite sediment removal.

Permanent Stormwater Section

Texas Commission on Environmental Quality

for Regulated Activities on the Edwards Aquifer Recharge Zone and Relating to 30 TAC §213.5(b)(4)(C), (D)(li), (E), and (5), Effective June 1, 1999

To ensure that the application is administratively complete, confirm that all fields in the form are complete, verify that all requested information is provided, consistently reference the same site and contact person in all forms in the application, and ensure forms are signed by the appropriate party.

Note: Including all the information requested in the form and attachments contributes to more streamlined technical reviews.

Signature

To the best of my knowledge, the responses to this form accurately reflect all information requested concerning the proposed regulated activities and methods to protect the Edwards Aquifer. This **Permanent Stormwater Section** is hereby submitted for TCEQ review and executive director approval. The application was prepared by:

Print Name of Customer/Agent: Jose L. Reyes, PE

Date: 06/13/2023

Signature of Customer/Agent

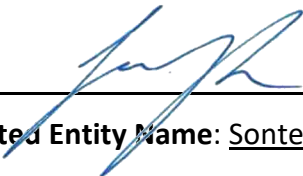



Regulated Entity Name: Sonterra Road Extension Project

Permanent Best Management Practices (BMPs)

Permanent best management practices and measures that will be used during and after construction is completed.

- Permanent BMPs and measures must be implemented to control the discharge of pollution from regulated activities after the completion of construction.
 N/A
- These practices and measures have been designed, and will be constructed, operated, and maintained to insure that 80% of the incremental increase in the annual mass loading of total suspended solids (TSS) from the site caused by the regulated activity is removed. These quantities have been calculated in accordance with technical guidance prepared or accepted by the executive director.
 The TCEQ Technical Guidance Manual (TGM) was used to design permanent BMPs and measures for this site.

A technical guidance other than the TCEQ TGM was used to design permanent BMPs and measures for this site. The complete citation for the technical guidance that was used is: _____

N/A

3. Owners must insure that permanent BMPs and measures are constructed and function as designed. A Texas Licensed Professional Engineer must certify in writing that the permanent BMPs or measures were constructed as designed. The certification letter must be submitted to the appropriate regional office within 30 days of site completion.

N/A

4. Where a site is used for low density single-family residential development and has 20 % or less impervious cover, other permanent BMPs are not required. This exemption from permanent BMPs must be recorded in the county deed records, with a notice that if the percent impervious cover increases above 20% or land use changes, the exemption for the whole site as described in the property boundaries required by 30 TAC §213.4(g) (relating to Application Processing and Approval), may no longer apply and the property owner must notify the appropriate regional office of these changes.

The site will be used for low density single-family residential development and has 20% or less impervious cover.

The site will be used for low density single-family residential development but has more than 20% impervious cover.

The site will not be used for low density single-family residential development.

5. The executive director may waive the requirement for other permanent BMPs for multi-family residential developments, schools, or small business sites where 20% or less impervious cover is used at the site. This exemption from permanent BMPs must be recorded in the county deed records, with a notice that if the percent impervious cover increases above 20% or land use changes, the exemption for the whole site as described in the property boundaries required by 30 TAC §213.4(g) (relating to Application Processing and Approval), may no longer apply and the property owner must notify the appropriate regional office of these changes.

Attachment A - 20% or Less Impervious Cover Waiver. The site will be used for multi-family residential developments, schools, or small business sites and has 20% or less impervious cover. A request to waive the requirements for other permanent BMPs and measures is attached.

The site will be used for multi-family residential developments, schools, or small business sites but has more than 20% impervious cover.

The site will not be used for multi-family residential developments, schools, or small business sites.

6. **Attachment B - BMPs for Upgradient Stormwater.**

- A description of the BMPs and measures that will be used to prevent pollution of surface water, groundwater, or stormwater that originates upgradient from the site and flows across the site is attached.
 - No surface water, groundwater or stormwater originates upgradient from the site and flows across the site, and an explanation is attached.
 - Permanent BMPs or measures are not required to prevent pollution of surface water, groundwater, or stormwater that originates upgradient from the site and flows across the site, and an explanation is attached.
7. **Attachment C - BMPs for On-site Stormwater.**
- A description of the BMPs and measures that will be used to prevent pollution of surface water or groundwater that originates on-site or flows off the site, including pollution caused by contaminated stormwater runoff from the site is attached.
 - Permanent BMPs or measures are not required to prevent pollution of surface water or groundwater that originates on-site or flows off the site, including pollution caused by contaminated stormwater runoff, and an explanation is attached.
8. **Attachment D - BMPs for Surface Streams.** A description of the BMPs and measures that prevent pollutants from entering surface streams, sensitive features, or the aquifer is attached. Each feature identified in the Geologic Assessment as sensitive has been addressed.
- N/A
9. The applicant understands that to the extent practicable, BMPs and measures must maintain flow to naturally occurring sensitive features identified in either the geologic assessment, executive director review, or during excavation, blasting, or construction.
- The permanent sealing of or diversion of flow from a naturally-occurring sensitive feature that accepts recharge to the Edwards Aquifer as a permanent pollution abatement measure has not been proposed.
 - Attachment E - Request to Seal Features.** A request to seal a naturally-occurring sensitive feature, that includes, for each feature, a justification as to why no reasonable and practicable alternative exists, is attached.
10. **Attachment F - Construction Plans.** All construction plans and design calculations for the proposed permanent BMP(s) and measures have been prepared by or under the direct supervision of a Texas Licensed Professional Engineer, and are signed, sealed, and dated. The plans are attached and, if applicable include:
- Design calculations (TSS removal calculations)
 - TCEQ construction notes
 - All geologic features
 - All proposed structural BMP(s) plans and specifications
- N/A

11. **Attachment G - Inspection, Maintenance, Repair and Retrofit Plan.** A plan for the inspection, maintenance, repairs, and, if necessary, retrofit of the permanent BMPs and measures is attached. The plan includes all of the following:
- Prepared and certified by the engineer designing the permanent BMPs and measures
 - Signed by the owner or responsible party
 - Procedures for documenting inspections, maintenance, repairs, and, if necessary retrofit
 - A discussion of record keeping procedures
- N/A
12. **Attachment H - Pilot-Scale Field Testing Plan.** Pilot studies for BMPs that are not recognized by the Executive Director require prior approval from the TCEQ. A plan for pilot-scale field testing is attached.
- N/A
13. **Attachment I - Measures for Minimizing Surface Stream Contamination.** A description of the measures that will be used to avoid or minimize surface stream contamination and changes in the way in which water enters a stream as a result of the construction and development is attached. The measures address increased stream flashing, the creation of stronger flows and in-stream velocities, and other in-stream effects caused by the regulated activity, which increase erosion that results in water quality degradation.
- N/A

Responsibility for Maintenance of Permanent BMP(s)

Responsibility for maintenance of best management practices and measures after construction is complete.

14. The applicant is responsible for maintaining the permanent BMPs after construction until such time as the maintenance obligation is either assumed in writing by another entity having ownership or control of the property (such as without limitation, an owner's association, a new property owner or lessee, a district, or municipality) or the ownership of the property is transferred to the entity. Such entity shall then be responsible for maintenance until another entity assumes such obligations in writing or ownership is transferred.
- N/A
15. A copy of the transfer of responsibility must be filed with the executive director at the appropriate regional office within 30 days of the transfer if the site is for use as a multiple single-family residential development, a multi-family residential development, or a non-residential development such as commercial, industrial, institutional, schools, and other sites where regulated activities occur.
- N/A

PERMANENT STORMWATER SECTION ATTACHMENTS

ATTACHMENT A - 20% or Less Impervious Cover Waiver

Not applicable.

ATTACHMENT B - BMPs for Upgradient Stormwater

Under proposed conditions, offsite surface water will flow into the existing sand filtration ponds on the southwest and northwest sides of the proposed Gold Canyon Rd and E. Sonterra Blvd limits. Flows from these areas will be diverted and finally allowed to enter Mud Creek. The proposed roadway along with curbs and sidewalks will slope towards the proposed batch detention on the northeast of the roundabout, allowing only the runoff from the proposed segment of roadway along with curbs and sidewalks to pass the proposed BMP.

ATTACHMENT C – BMPs for On-site Stormwater

Treatment for the runoff from the drainage area on the newly constructed streets, curbs and sidewalks shall be addressed by batch detention placed on the northeast side of the proposed roundabout at E. Sonterra Blvd and Gold Canyon Rd intersection.

ATTACHMENT D – BMPS FOR SURFACE STREAMS

No sensitive geologic features exist on the project site. The proposed project will only create new roadway, curb and sidewalk impervious cover and will treat storm-water runoff from E. Sonterra Blvd and Gold Canyon Rd prior to being discharged into Mud Creek northeast of the proposed improvements. Treatment of the roadway, curb, and sidewalk by batch detention will provide protection to surface streams.

Action plan if sensitive features are encountered:

1. Immediately stop construction in the vicinity of the feature.
2. Notify TCEQ San Antonio Regional office staff.
3. Contact a qualified professional Geologist (and Karst biologist, if necessary) to assess the sensitivity of the feature.
4. If necessary, install temporary erosion and sedimentation controls to protect the feature from surface contamination.
5. Develop and submit to the TCEQ for review a feature closure and/or protection plan.
6. Commence construction in the vicinity of the feature only after the feature closure/protection plans has been approved by the TCEQ and the feature has been permanently protected from surface contamination.

ATTACHMENT E – Request to Seal Features

Not applicable.

ATTACHMENT F – Construction Plans/Design Calculations

Attached. See Site Plan and Storm Water Pollution Prevention Plan.

PLAN VIEW LEGEND

- PROP. STORM SEWER
- PROP. CONCRETE CURB
- PROP. EDGE OF PAVEMENT
- - - - PROP. RIGHT OF WAY
- - - - EXIST RIGHT OF WAY
- - - - PROP. DRAINAGE EASEMENT
- - - - EXIST EASEMENT LINES
- FEMA 100-YEAR FLOODPLAIN ZONE AE

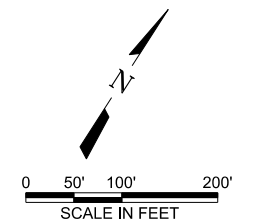
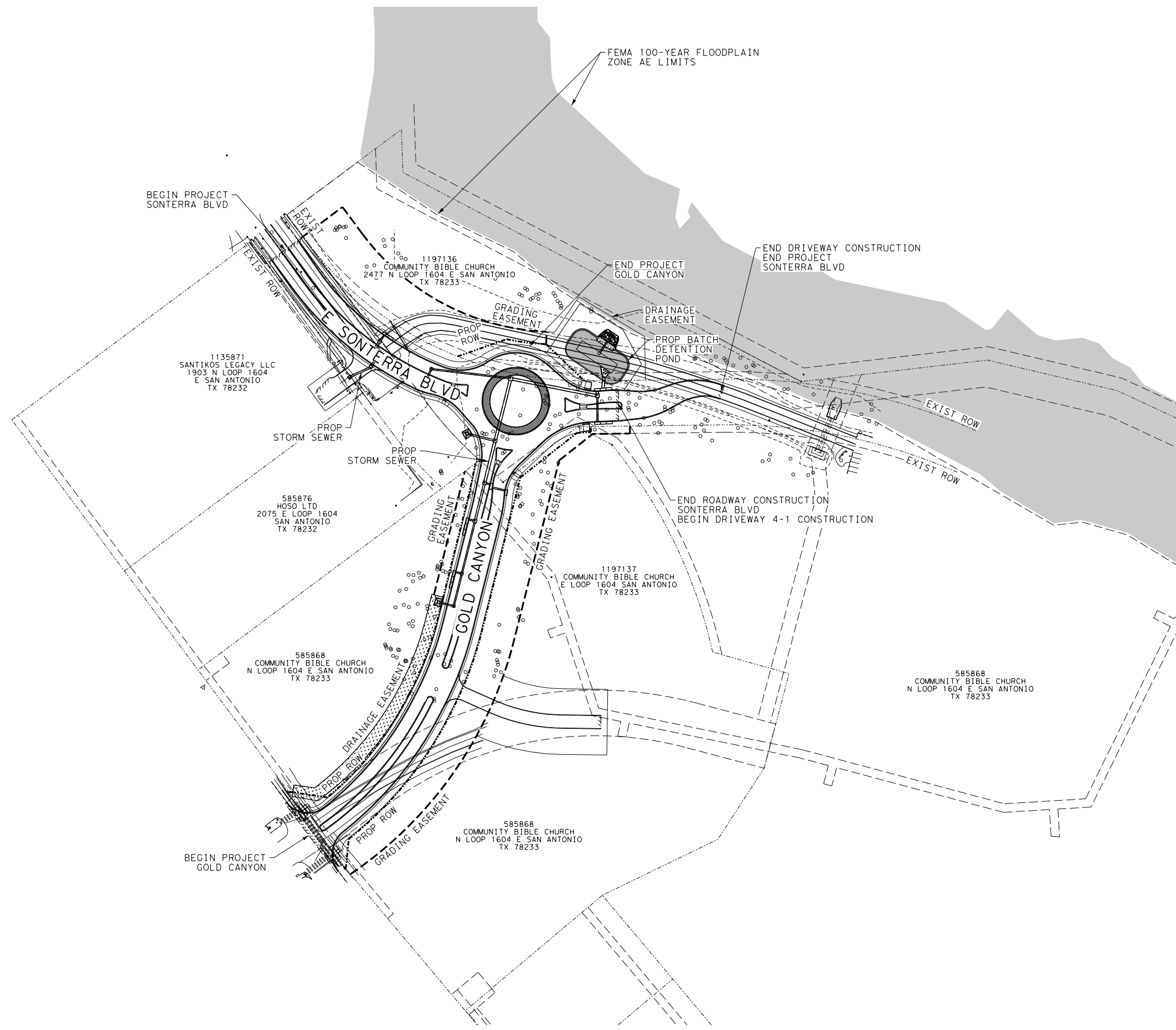

MAESTAS 8122 DATAPOINT DR., STE. 840
 SAN ANTONIO, TX 78229
 (210) 366-1988
 TBPE No.: F-333
 TBPLS No.: 10194506

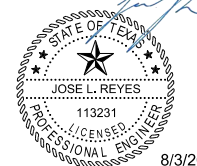

NO:	DATE	REVISION	APPROVED BY

Freese and Nichols, Inc.
 Texas Registered Engineering Firm F-2144
FREESE AND NICHOLS 9601 McAllister Freeway, Suite 1008
 San Antonio, Texas 78216
 Phone - (210) 298-3800
 web - www.freese.com

CITY OF SAN ANTONIO
 PUBLIC WORKS DEPARTMENT

SONTERRA ROAD EXTENSION
 SITE LAYOUT

PRELIMINARY	PROJECT NO.:	23-01849	DATE:	8/3/2023
DRWN. BY: GC	DSGN. BY: GC	CHKD. BY: JR	SHEET 1 OF 1	

Additional information is provided for cells with a red triangle in the upper right corner. Place the cursor over the cell.

Text shown in blue indicate location of instructions in the Technical Guidance Manual - RG-348.

Characters shown in red are data entry fields.

Characters shown in black (Bold) are calculated fields. Changes to these fields will remove the equations used in the spreadsheet.

1. The Required Load Reduction for the total project:

Calculations from RG-348

Pages 3-27 to 3-30

Page 3-29 Equation 3.3: $L_M = 27.2(A_N \times P)$

where:

$L_{M \text{ TOTAL PROJECT}}$ = Required TSS removal resulting from the proposed development = 80% of increased load
 A_N = Net increase in impervious area for the project
 P = Average annual precipitation, inches

Site Data: Determine Required Load Removal Based on the Entire Project

County =	Bexar	
Total project area included in plan *	4.44	acres
Predevelopment impervious area within the limits of the plan *	1.54	acres
Total post-development impervious area within the limits of the plan *	3.45	acres
Total post-development impervious cover fraction *	0.78	
P =	30	inches

$L_{M \text{ TOTAL PROJECT}}$ = **1562** lbs.

* The values entered in these fields should be for the total project area.

Number of drainage basins / outfalls areas leaving the plan area = **1**

2. Drainage Basin Parameters (This information should be provided for each basin):

Drainage Basin/Outfall Area No. = **1**

Total drainage basin/outfall area =	2.96	acres
Predevelopment impervious area within drainage basin/outfall area =	0.40	acres
Post-development impervious area within drainage basin/outfall area =	2.56	acres
Post-development impervious fraction within drainage basin/outfall area =	0.87	
$L_{M \text{ THIS BASIN}}$ =	1767	lbs.

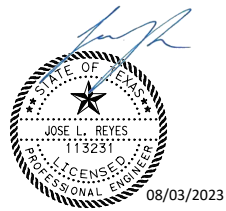

3. Indicate the proposed BMP Code for this basin.

Proposed BMP = **Batch Detention**
 Removal efficiency = **91** percent

- Aqualogic Cartridge Filter
- Bioretention
- Contech StormFilter
- Constructed Wetland
- Extended Detention
- Grassy Swale
- Retention / Irrigation
- Sand Filter
- Stormceptor
- Vegetated Filter Strips
- Vortechs
- Wet Basin
- Wet Vault
- Batch Detention

4. Calculate Maximum TSS Load Removed (L_R) for this Drainage Basin by the selected BMP Type.

RG-348 Page 3-33 Equation 3.7: $L_R = (\text{BMP efficiency}) \times P \times (A_i \times 34.6 + A_p \times 0.54)$

where:

A_C = Total On-Site drainage area in the BMP catchment area
 A_i = Impervious area proposed in the BMP catchment area
 A_p = Pervious area remaining in the BMP catchment area
 L_R = TSS Load removed from this catchment area by the proposed BMP

A_C =	2.96	acres
A_i =	2.56	acres
A_p =	0.40	acres
L_R =	2425	lbs

5. Calculate Fraction of Annual Runoff to Treat the drainage basin / outfall area

Desired L_{M THIS BASIN} = **1767** lbs.

F = **0.73**

6. Calculate Capture Volume required by the BMP Type for this drainage basin / outfall area.

Calculations from RG-348

Pages 3-34 to 3-36

Rainfall Depth = **0.86** inches
Post Development Runoff Coefficient = **0.71**
On-site Water Quality Volume = **6529** cubic feet

Calculations from RG-348 Pages 3-36 to 3-37

Off-site area draining to BMP = **7.51** acres
Off-site Impervious cover draining to BMP = **2.00** acres
Impervious fraction of off-site area = **0.27**
Off-site Runoff Coefficient = **0.24**
Off-site Water Quality Volume = **5640** cubic feet

Storage for Sediment = **2434**

Total Capture Volume (required water quality volume(s) x 1.20) = 14603 cubic feet 0.34 Acre-ft

The following sections are used to calculate the required water quality volume(s) for the selected BMP.
The values for BMP Types not selected in cell C45 will show NA.

7. Retention/Irrigation System

Designed as Required in RG-348

Pages 3-42 to 3-46

Required Water Quality Volume for retention basin = **NA** cubic feet

Irrigation Area Calculations:

Soil infiltration/permeability rate = **0.1** in/hr Enter determined permeability rate or assumed value of 0.1
Irrigation area = **NA** square feet
NA acres

8. Extended Detention Basin System

Designed as Required in RG-348

Pages 3-46 to 3-51

Required Water Quality Volume for extended detention basin = **NA** cubic feet

9. Filter area for Sand Filters

Designed as Required in RG-348

Pages 3-58 to 3-63

9A. Full Sedimentation and Filtration System

Water Quality Volume for sedimentation basin = **NA** cubic feet

Minimum filter basin area = **NA** square feet

Maximum sedimentation basin area = **NA** square feet For minimum water depth of 2 feet
Minimum sedimentation basin area = **NA** square feet For maximum water depth of 8 feet

9B. Partial Sedimentation and Filtration System

Water Quality Volume for combined basins = **NA** cubic feet

Minimum filter basin area = **NA** square feet

Maximum sedimentation basin area = **NA** square feet For minimum water depth of 2 feet
Minimum sedimentation basin area = **NA** square feet For maximum water depth of 8 feet

10. Bioretention System

Designed as Required in RG-348

Pages 3-63 to 3-65

Required Water Quality Volume for Bioretention Basin = **NA** cubic feet

11. Wet Basins

Designed as Required in RG-348

Pages 3-66 to 3-71

Required capacity of Permanent Pool = **NA** cubic feet Permanent Pool Capacity is 1.20 times the WQV
Required capacity at WQV Elevation = **NA** cubic feet Total Capacity should be the Permanent Pool Capacity plus a second WQV.

12. Constructed Wetlands

Designed as Required in RG-348

Pages 3-71 to 3-73

Required Water Quality Volume for Constructed Wetlands = **NA** cubic feet

13. AquaLogic™ Cartridge System

Designed as Required in RG-348

Pages 3-74 to 3-78

**** 2005 Technical Guidance Manual (RG-348) does not exempt the required 20% increase with maintenance contract with AquaLogic™.**

Required Sedimentation chamber capacity =	NA	cubic feet
Filter canisters (FCs) to treat WQV =	NA	cartridges
Filter basin area (RIA _F) =	NA	square feet

14. Stormwater Management StormFilter® by CONTECH

Required Water Quality Volume for Contech StormFilter System =	NA	cubic feet
--	-----------	------------

THE SIZING REQUIREMENTS FOR THE FOLLOWING BMPs / LOAD REMOVALS ARE BASED UPON FLOW RATES - NOT CALCULATED WATER QUALITY VOLUMES

15. Grassy Swales

Designed as Required in RG-348

Pages 3-51 to 3-54

Design parameters for the swale:

Drainage Area to be Treated by the Swale = A =	8.00	acres
Impervious Cover in Drainage Area =	4.00	acres
Rainfall intensity = i =	1.1	in/hr
Swale Slope =	0.01	ft/ft
Side Slope (z) =	3	
Design Water Depth = y =	0.33	ft
Weighted Runoff Coefficient = C =	0.54	
A _{CS} = cross-sectional area of flow in Swale =	13.17	sf
P _w = Wetted Perimeter =	40.62	feet
R _H = hydraulic radius of flow cross-section = A _{CS} /P _w =	0.32	feet
n = Manning's roughness coefficient =	0.2	

15A. Using the Method Described in the RG-348

Manning's Equation: $Q = \frac{1.49}{n} A_{CS} R_H^{2/3} S^{0.5}$

$b = \frac{0.134 \times Q}{y^{0.67} S^{0.5}} - zy = 38.51$ feet

Q = CiA = 4.71 cfs

To calculate the flow velocity in the swale:

V (Velocity of Flow in the swale) = Q/A_{CS} = 0.36 ft/sec

To calculate the resulting swale length:

L = Minimum Swale Length = V (ft/sec) * 300 (sec) = 107.24 feet

If any of the resulting values do not meet the design requirement set forth in RG-348, the design parameters must be modified and the solver rerun.

15B. Alternative Method using Excel Solver

Design Q = CiA =	4.71 cfs		
Manning's Equation Q =	0.76 cfs	Error 1 =	3.95
Swale Width=	6.00 ft		

Instructions are provided to the right (green comments).

Flow Velocity	0.36 ft/s
Minimum Length =	107.24 ft

Instructions are provided to the right (blue comments).

Design Width =	6 ft		
Design Discharge =	0.76 cfs	Error 2 =	3.95

To solve for bottom width of the trapezoidal swale (b) using the Excel solver: Excel can simultaneously solve the "Design Q" (C217) vs "Manning's Q" (C219) by varying the "Swale Width" (C220). The required "Swale Width" occurs when the "Design Q" = "Manning's Q"

First, highlight Cell F219 (Error 1 value). The equation showing in the fx screen for Cell F219 should be "= \$C\$217-\$C\$219" Then click on "Tools" and "Solver". The "Solver Parameters" screen pops up. The value in the "Set Target cell" should be \$F\$219 "Error 1 =" The value in the "By Changing Cells" should be \$C\$220 "Swale Width" Click on solve.

The resulting "Swale Width" must be less than 10 feet to meet the requirements of the TGM. If the resulting "Swale Width" exceeds 10 feet then the design parameters must be revised and the solver run again.

If there is not the option for "Solver" under "Tools" Click on "Tools" and "Add Ins" and then check "Solver Add-in" Then proceed as instructed above.

If you would like to increase the bottom width of the trapezoidal swale (b): Excel can simultaneously solve the "Design Q" (C217) vs "Design Discharge" (C232) by varying the "Design Depth" (C233).

Design Depth = 0.33 ft
 Flow Velocity = 0.32 cfs
 Minimum Length = 97.48 ft

If any of the resulting values do not meet the design requirement set forth in RG-348, the design parameters may be modified and the solver rerun.
 If any of the resulting values still do not meet the design requirement set forth in RG-348, widening the swale bottom value may not be possible.

16. Vegetated Filter Strips Designed as Required in RG-348 Pages 3-55 to 3-57

There are no calculations required for determining the load or size of vegetative filter strips.
 The 80% removal is provided when the contributing drainage area does not exceed 72 feet (direction of flow) and the sheet flow leaving the impervious cover is directed across 15 feet of engineered filter strips with maximum slope of 20% or across 50 feet of natural vegetation with a maximum slope of 10%. There can be a break in grade as long as no slope exceeds 20%.

If vegetative filter strips are proposed for an interim permanent BMP, they may be sized as described on Page 3-56 of RG-348.

17. Wet Vaults Designed as Required in RG-348 Pages 3-30 to 3-32 & 3-79

Required Load Removal Based upon Equation 3.3 = **NA** lbs

First calculate the load removal at 1.1 in/hour

RG-348 Page 3-30 Equation 3.4: $Q = CiA$

C = runoff coefficient for the drainage area = 0.72 **C = Runoff Coefficient = 0.546 (IC)² + 0.328 (IC) + 0.03**
 i = design rainfall intensity = 1.1 in/hour
 A = drainage area in acres = 1 acres

Q = flow rate in cubic feet per second = 0.80 cubic feet/sec

RG-348 Page 3-31 Equation 3.5: $V_{OR} = Q/A$

Q = Runoff rate calculated above = 0.80 cubic feet/sec
 A = Water surface area in the wet vault = 150 square feet

V_{OR} = Overflow Rate = 0.01 feet/sec

Percent TSS Removal from Figure 3-1 (RG-348 Page 3-31) = 53 percent

Load removed by Wet Vault = #VALUE! lbs

If a bypass occurs at a rainfall intensity of less than 1.1 in/hours
 Calculate the efficiency reduction for the actual rainfall intensity rate

Actual Rainfall Intensity at which Wet Vault bypass Occurs = 0.5 in/hour

Fraction of rainfall treated from Figure 3-2 RG-348 Page 3-32 = 0.75 percent
 Efficiency Reduction for Actual Rainfall Intensity = 0.83 percent

Resultant TSS Load removed by Wet Vault = #VALUE! lbs

18. Permeable Concrete Designed as Required in RG-348 Pages 3-79 to 3-83

PERMEABLE CONCRETE MAY ONLY BE USED ON THE CONTRIBUTING ZONE

19. BMPs Installed in a Series Designed as Required in RG-348 Pages 3-32

Michael E. Barrett, Ph.D., P.E. recommended that the coefficient for E_2 be changed from 0.5 to 0.65 on May 3, 2006

$E_{TOT} = [1 - ((1 - E_1) \times (1 - 0.65E_2) \times (1 - 0.25E_3))] \times 100 = 86.38$ percent NET EFFICIENCY OF THE BMPs IN THE SERIES

EFFICIENCY OF FIRST BMP IN THE SERIES = $E_1 = 75.00$ percent

EFFICIENCY OF THE SECOND BMP IN THE SERIES = $E_2 = 70.00$ percent

EFFICIENCY OF THE THIRD BMP IN THE SERIES = $E_3 = 0.00$ percent

THEREFORE, THE NET LOAD REMOVAL WOULD BE:
 (A_i AND A_p VALUES ARE FROM SECTION 3 ABOVE)

$L_R = E_{TOT} \times P \times (A_i \times 34.6 \times A_p \times 0.54) = 2301.70$ lbs

20. Stormceptor

Required TSS Removal in BMP Drainage Area = **NA** lbs
 Impervious Cover Overtreatment = 0.0000 ac
 TSS Removal for Uncaptured Area = 0.00 lbs

The required "Design Depth" for a 10-foot bottom width occurs when the "Design Q" (C217) = the "Design Discharge" (C232).

First set the desired bottom width in Cell C231.
 Highlight Cell F232. The equation showing in the fx screen for Cell F232 should be "= \$C\$217-\$C\$232"

Click on "Tools" and "Solver". The "Solver Parameters" screen pops up.
 The value in the "Set Target cell" should be \$F\$232 "Error 2"
 The value in the "By Changing Cells" should be \$C\$233 "Design Depth"
 Click on solve.

The resulting "Design Depth" must be equal to or less than 0.33 feet to meet the requirements of the TGM.
 If the resulting "Design Depth" exceeds 0.33 feet then the design parameters must be revised and the solver run again.
 First set the desired bottom width in Cell C231.
 Highlight Cell F232. The equation showing in the fx screen for Cell F232 should be "= \$C\$217-\$C\$232"
 Click on "Tools" and "Solver". The "Solver Parameters" screen pops up.
 The value in the "Set Target cell" should be \$F\$232 "Error 2"
 The value in the "By Changing Cells" should be \$C\$233 "Design Depth"
 Click on solve.

The resulting "Design Depth" must be equal to or less than 0.33 feet to meet the requirements of the TGM.
 If the resulting "Design Depth" exceeds 0.33 feet then the design parameters must be revised and the solver run again.

BMP Sizing

Effective Area = NA EA
Calculated Model Size(s) = #N/A
Actual Model Size (if multiple values provided in Calculated Model Size or if you are choosing a larger model size) = 0 Model Size
Surface Area = #N/A ft²
Overflow Rate = #VALUE! V_{or}
Rounded Overflow Rate = #VALUE! V_{or}
BMP Efficiency % = #VALUE! %
L_R Value = #VALUE! lbs
TSS Load Credit = #VALUE! lbs
Is Sufficient Treatment Available? (TSS Credit ≥ TSS Uncapt.) #VALUE!
TSS Treatment by BMP (LM + TSS Uncapt.) = #VALUE!

21. Vortech

Required TSS Removal in BMP Drainage Area= NA lbs
Impervious Cover Overtreatment= 0.0000 ac
TSS Removal for Uncaptured Area = 0.00 lbs
BMP Sizing
Effective Area = NA EA
Calculated Model Size(s) = #N/A
Actual Model Size (if choosing larger model size) = Vx1000 Pick Model Size
Surface Area = 7.10 ft²
Overflow Rate = #VALUE! V_{or}
Rounded Overflow Rate = #VALUE! V_{or}
BMP Efficiency % = #VALUE! %
L_R Value = #VALUE! lbs
TSS Load Credit = #VALUE! lbs
Is Sufficient Treatment Available? (TSS Credit ≥ TSS Uncapt.) #VALUE!
TSS Treatment by BMP (LM + TSS Uncapt.) = #VALUE!

Texas Commission on Environmental Quality
 Water Pollution Abatement Plan
 General Construction Notes

1. A written notice of construction must be submitted to the TCEQ regional office at least 48 hours prior to the start of any regulated activities. This notice must include:
 - the name of the approved project;
 - the activity start date; and
 - the contact information of the prime contractor.
2. All contractors conducting regulated activities associated with this project must be provided with complete copies of the approved Water Pollution Abatement Plan (WPAP) and the TCEQ letter indicating the specific conditions of its approval. During the course of these regulated activities, the contractors are required to keep on-site copies of the approved plan and approval letter.
3. If any sensitive feature(s) (caves, solution cavity, sink hole, etc.) is discovered during construction, all regulated activities near the sensitive feature must be suspended immediately. The appropriate TCEQ regional office must be immediately notified of any sensitive features encountered during construction. Construction activities may not be resumed until the TCEQ has reviewed and approved the appropriate protective measures in order to protect any sensitive feature and the Edwards Aquifer from potentially adverse impacts to water quality.
4. No temporary or permanent hazardous substance storage tank shall be installed within 150 feet of a water supply source, distribution system, well, or sensitive feature.
5. Prior to beginning any construction activity, all temporary erosion and sedimentation (E&S) control measures must be properly installed and maintained in accordance with the manufacturers specifications. If inspections indicate a control has been used inappropriately, or incorrectly, the applicant must replace or modify the control for site situations. These controls must remain in place until the disturbed areas have been permanently stabilized.
6. Any sediment that escapes the construction site must be collected and properly disposed of before the next rain event to ensure it is not washed into surface streams, sensitive features, etc.
7. Sediment must be removed from the sediment traps or sedimentation basins no later than when it occupies 50% of the basin's design capacity.
8. Litter, construction debris, and construction chemicals exposed to stormwater shall be prevented from being discharged offsite.
9. All excavated material that will be stored on-site must have proper E&S controls. For storage or disposal of spoils at another site on the Edwards Aquifer Recharge Zone, the owner of the site must receive approval of a water pollution abatement plan for the placement of fill material or mass grading prior to the placement of spoils at the other site.
10. If portions of the site will have a cease in construction activity lasting longer than 14 days, soil stabilization in those areas shall be initiated as soon as possible prior to the 14th day of inactivity. If activity will resume prior to the 21st day, stabilization measures are not required. If drought conditions or inclement weather prevent action by the 14th day, stabilization measures shall be initiated as soon as possible.
11. The following records should be maintained and made available to the TCEQ upon request:
 - the dates when major grading activities occur;
 - the dates when construction activities temporarily or permanently cease on a portion of the site; and
 - the dates when stabilization measures are initiated.
12. The holder of any approved Edward's Aquifer protection plan must notify the appropriate regional office in writing and obtain approval from the executive director prior to initiating any of the following:
 - A. any physical or operational modification of any best management practices (BMPs) or structure(s), including but not limited to temporary or permanent ponds, dams, berms, silt fences, and diversionary structures;
 - B. any change in the nature or character of the regulated activity from that which was originally approved;
 - C. any change that would significantly impact the ability to prevent pollution of the Edwards Aquifer; or
 - D. any development of land previously identified as undeveloped in the approved contributing zone plan.

Austin Regional Office
 12100 Park 35 Circle, Bldg A
 Austin, Texas 78753-1808
 Phone (512) 339-2929
 Fax (512) 339-3795

San Antonio Regional Office
 14250 Judson Road
 San Antonio, Texas 78233-4480
 Phone (210) 490-3096
 Fax (210) 545-4329

MAESTAS 8122 DATAPOINT DR., STE. 840
 SAN ANTONIO, TX 78229
 (210) 366-1988
 TBPE No.: F-333
 TBPLS No.: 10194506

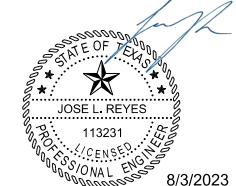

NO:	DATE	REVISION	APPROVED BY

Freese and Nichols, Inc.
 Texas Registered Engineering Firm F-2144
FREESE AND NICHOLS 9601 McAllister Freeway, Suite 1008
 San Antonio, Texas 78216
 Phone - (210) 298-3800
 web - www.freese.com

CITY OF SAN ANTONIO
 PUBLIC WORKS DEPARTMENT

SONTERRA ROAD EXTENSION
 PERMANENT STORMWATER POLLUTION
 PREVENTION PLAN NOTES

PRELIMINARY	PROJECT NO.:	23-01849	DATE:	8/3/2023	
DRWN. BY:	GC	DSGN. BY:	GC	CHKD. BY:	JR
SHEET 1 OF 1			SHEET 1 OF 1		

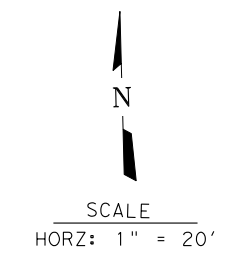
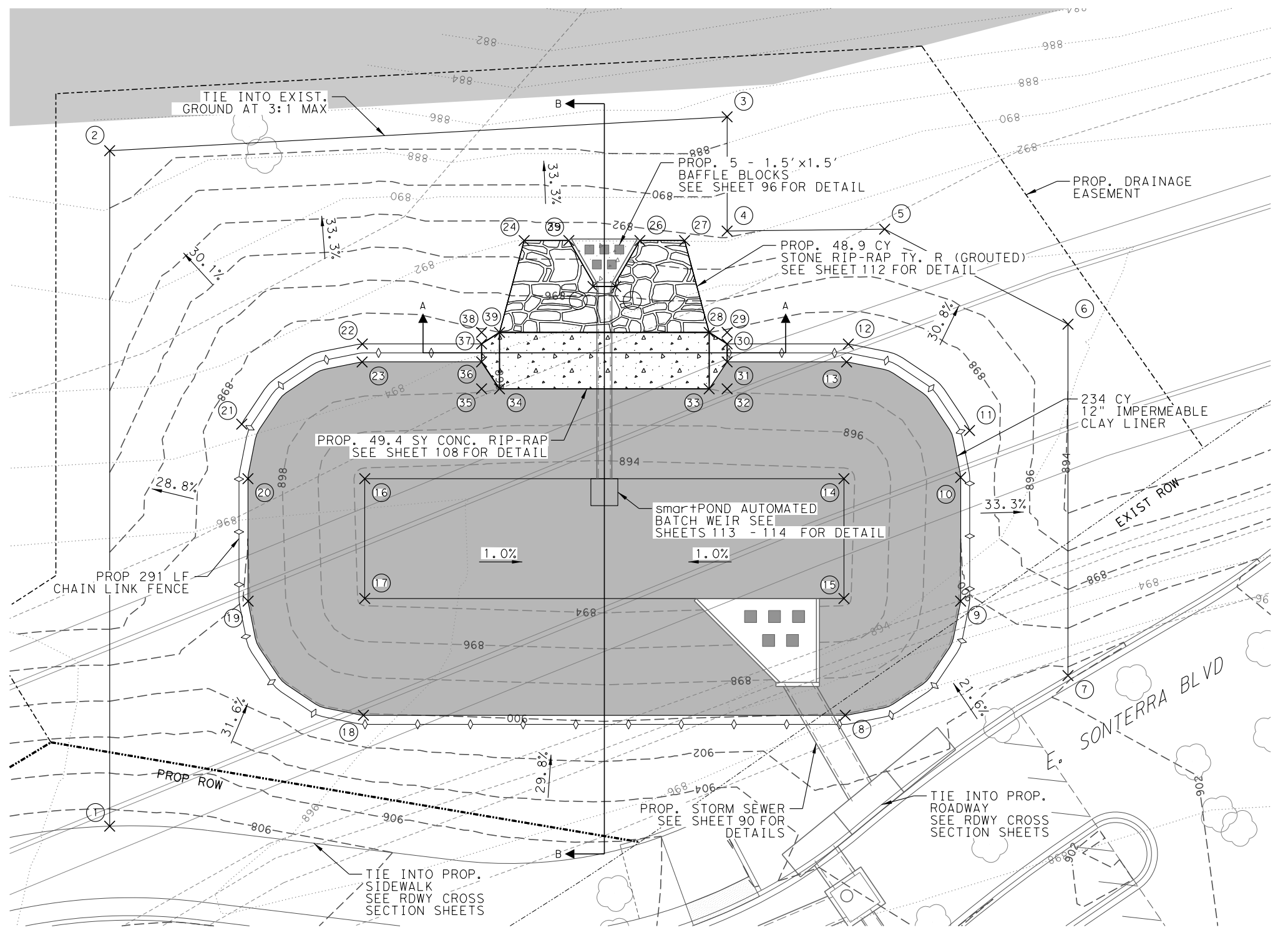

PLAN VIEW LEGEND

- PROP. STORM SEWER
- PROP. CONCRETE CURB
- PROP. EDGE OF PAVEMENT
- - - - PROP. RIGHT OF WAY
- - - - PROP. DRAINAGE EASEMENT
- - - - EXIST. RIGHT OF WAY
- GRADE BREAKLINE
- FEMA 100-YEAR FLOODPLAIN ZONE AE
- IMPERMEABLE CLAY LINER

ESTIMATED QUANTITIES				
ITEM	DESCRIPTION	UNIT	EST	FINAL
105.1	CHANNEL EXCAVATION (150 CY < X < 5,000 CY)	CY	184	
107.1	EMBANKMENT (FINAL) (DENS CONT) (TY A)	CY	1948	
107.1	EMBANKMENT (FINAL) (DENS CONT) (TY B)	CY	234	
307.1	CONCRETE STRUCTURE (HEADWALLS OR OUTFALL STRUCTURES)	LF	3	
401.1	REINFORCED CONCRETE PIPE (CLASS III) (24" DIA.)	CY	33	
407.4	CONCRETE COLLARS	CY	1	
505.1	CONCRETE RIPRAP (5" THICK) (100 < X < 4,000 SY)	SY	50	
507.2	CHAIN LINK WIRE FENCE (6')	LF	291	
520.1	HYDROMULCHING (RESIDENTIAL OR COMMERCIAL)	SY	2008	
SP1	smartPOND AUTOMATED BATCH WEIR	EA	1	
432.6016	RIPRAP (STONE TY R) (GROUT) (12 IN)	CY	49	

MAESTAS 8122 DATAPoint DR., STE. 840
SAN ANTONIO, TX 78229
(210) 366-1988
TBPE No.: F-333
TBPLS No.: 10194506

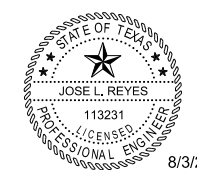

NOTE:
1. SEE SECTION A-A AND B-B ON SHEET 96.

POINT #	STA.	OFFSET	LT/RT	ELEV.	DESC.
1	16+44.38	94.94	LT	908.88	TIE TO RDWY
2	17+12.02	188.57	LT	886.91	TIE TO EXIST
3	18+00.39	135.19	LT	886.92	TIE TO EXIST
4	17+89.65	119.44	LT	891.58	TIE TO EXIST
5	18+11.55	104.89	LT	893.29	TIE TO EXIST
6	18+27.91	74.54	LT	894.12	TIE TO EXIST
7	17+94.88	26.07	LT	902.41	TIE TO RDWY
8	17+60.42	41.54	LT	900.10	EDGE OF POND
9	17+87.06	46.44	LT	900.10	EDGE OF POND
10	17+98.71	63.50	LT	899.90	EDGE OF POND
11	18+04.34	69.13	LT	899.87	TOP OF BERM
12	17+95.74	92.45	LT	899.87	TOP OF BERM
13	17+93.82	90.15	LT	899.90	TOP OF BERM

POINT #	STA.	OFFSET	LT/RT	ELEV.	DESC.
14	17+82.48	74.30	LT	893.40	POND TOE
15	17+71.22	57.77	LT	893.60	POND TOE
16	17+16.37	119.35	LT	893.40	POND TOE
17	17+05.11	102.83	LT	893.60	POND TOE
18	16+93.95	86.85	LT	900.10	EDGE OF POND
19	16+88.77	113.43	LT	900.10	EDGE OF POND
20	17+00.26	130.34	LT	899.90	EDGE OF POND
21	17+04.53	138.44	LT	899.87	TOP OF BERM
22	17+28.70	138.16	LT	899.87	TOP OF BERM
23	17+26.98	135.70	LT	899.90	TOP OF BERM
24	17+60.75	137.21	LT	893.05	ROCK RIP-RAP
25	17+66.91	133.01	LT	892.99	ROCK RIP-RAP
26	17+76.72	126.33	LT	892.72	ROCK RIP-RAP

POINT #	STA.	OFFSET	LT/RT	ELEV.	DESC.
27	17+82.88	122.13	LT	892.41	ROCK RIP-RAP
28	17+77.64	107.15	LT	898.00	ROCK RIP-RAP
29	17+80.12	105.46	LT	898.21	CONC RIP-RAP
30	17+79.04	103.87	LT	898.84	TOP OF BERM
31	17+77.35	101.39	LT	899.70	TOP OF BERM
32	17+74.82	97.68	LT	898.20	CONC RIP-RAP
33	17+72.34	99.36	LT	898.00	CONC RIP-RAP
34	17+43.42	119.08	LT	898.00	CONC RIP-RAP
35	17+40.94	120.77	LT	898.20	CONC RIP-RAP
36	17+43.47	124.48	LT	899.71	TOP OF BERM
37	17+45.16	126.96	LT	898.84	TOP OF BERM
38	17+46.24	128.55	LT	898.21	CONC RIP-RAP
39	17+48.72	126.86	LT	898.00	ROCK RIP-RAP

Date: 6/8/2023

NO.	DATE	REVISION	APPROVED BY

Freese and Nichols, Inc.
Texas Registered Engineering Firm F-2144
FREES & NICHOLS 9601 McAllister Freeway, Suite 1008
San Antonio, Texas 78216
Phone - (210) 298-3800
web - www.freese.com

CITY OF SAN ANTONIO
PUBLIC WORKS DEPARTMENT

SONTERRA ROAD EXTENSION
BATCH DETENTION POND
GRADING
SHEET 1 OF 1

PRELIMINARY	PROJECT NO.:	23-01849	DATE:	6/8/2023
DRWN. BY: GC	DSGN. BY: GC	CHKD. BY: JR	SHEET 95 OF 179	

PROGRAMMABLE LOGIC FLOW CHART

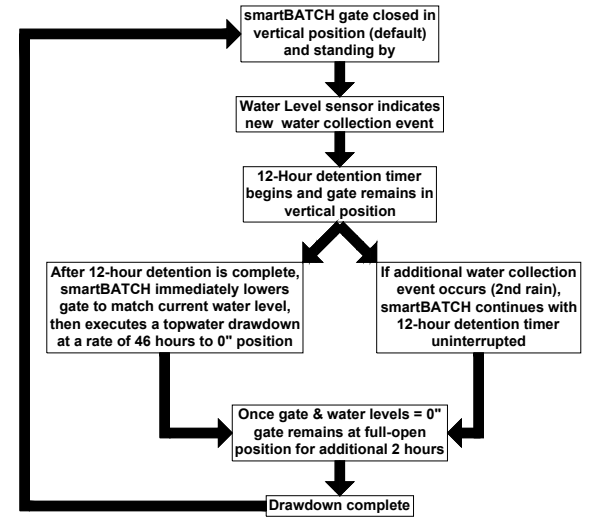

FRONT VIEW

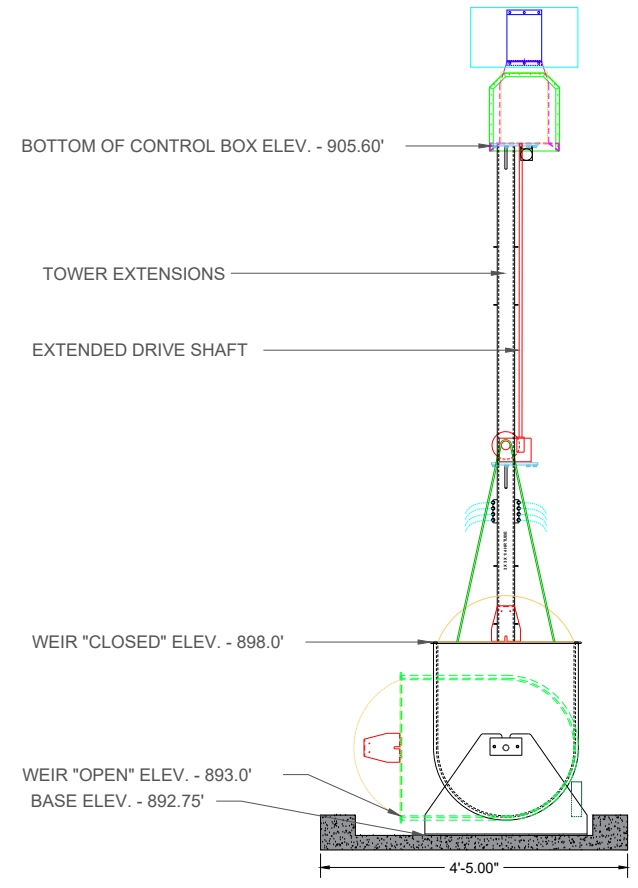

SIDE VIEW

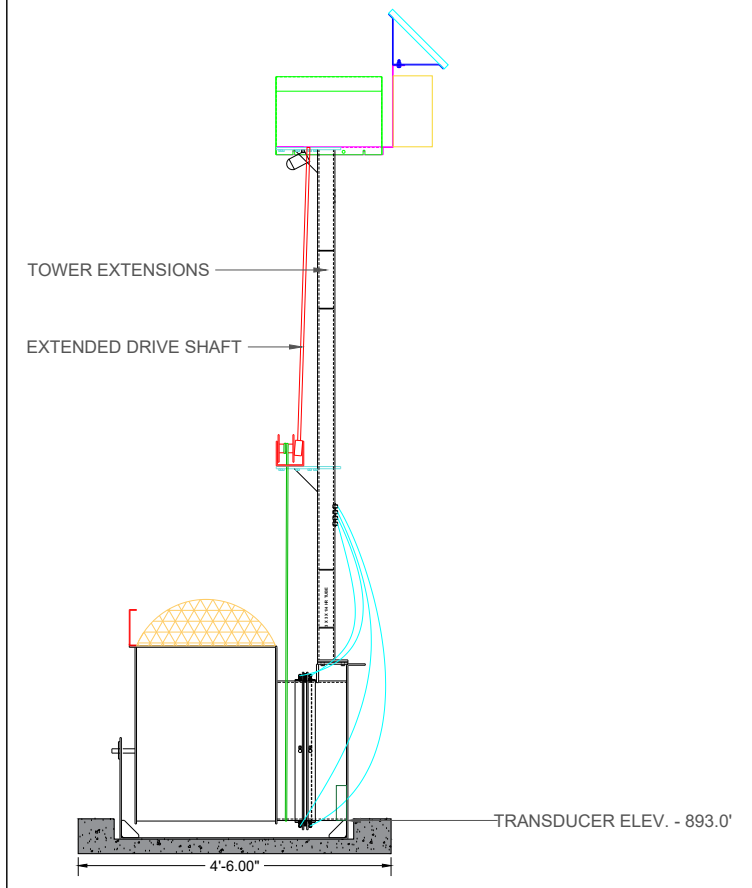

smartPOND
Automated Stormwater Control.

FOR ADDITIONAL INFORMATION PLEASE CONTACT: CONSTRUCTION ECO SERVICES, 832-456-1000, www.ecosvs.com

smartPOND Elevations - Outlet Structure #1

PROJECT NAME:	Gold Canyon/Sonterra Extension
Address:	San Antonio, Texas
DATE:	6/5/2023
SCALE:	N.T.S
SHEET NO.:	113-114

MAESTAS 8122 DATAPOINT DR., STE. 840
SAN ANTONIO, TX 78229
(210) 366-1988
TBPE No.: F-333
TBPLS No.: 10194506

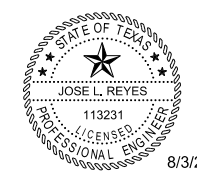

NO.	DATE	REVISION	APPROVED BY

Freese and Nichols, Inc.
Texas Registered Engineering Firm F-2144
FREESE & NICHOLS 9601 McAllister Freeway, Suite 1008
San Antonio, Texas 78216
Phone - (210) 298-3800
web - www.freese.com

CITY OF SAN ANTONIO
PUBLIC WORKS DEPARTMENT

SONTERRA ROAD EXTENSION
SMARTPOND AUTOMATED
BATCH WEIRD DETAILS

PRELIMINARY	PROJECT NO.:	23-01849	DATE:	6/5/2023	
DRWN. BY:	GC	DSGN. BY:	GC	CHKD. BY:	JR
SHEET 113 OF 179			SHEET 1 OF 2		

TOP VIEW

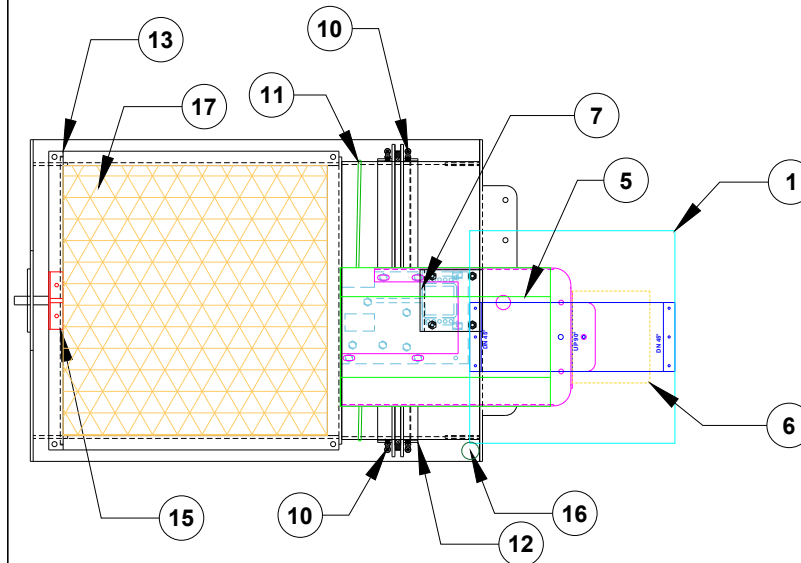

Parts List	
Item	smartBATCH Components
1	12 V SOLAR PANEL WITH 30 WATT CHARGING CAPACITY
2	ANTENNA (NOT DISPLAYED)
3	CELL DATA MODEM (NOT DISPLAYED)
4	CAMERA
5	WEATHERPROOF ELECTRONIC BOX
6	CONTROL BOX
7	PEDESTAL
8	REMOTE GREASE MANIFOLD
9	GREASE TUBES
10	GREASE FITTINGS
11	$\frac{3}{16}$ " Galvanized Cables
12	24" Rotary Valve
13	24" Drum
14	Outlet Pipe (Size TBD By Engineer, Max 24")
15	Inclinometer
16	Level Transducer
17	Beehive Grate
18	6" Concrete Pad (By Others, Size Varies)

FRONT VIEW

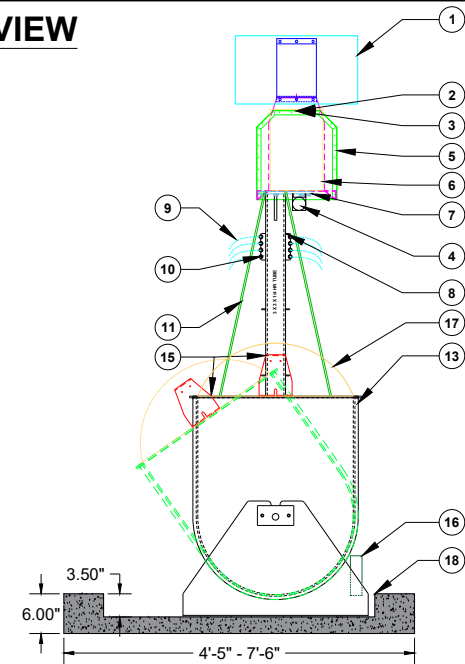

SIDE VIEW

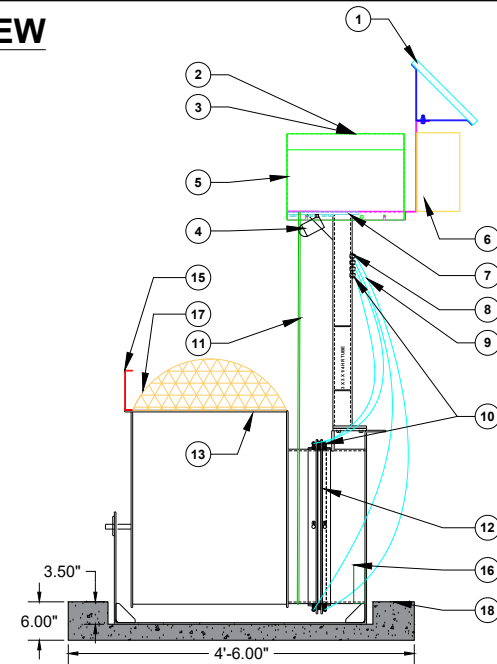

BACK VIEW

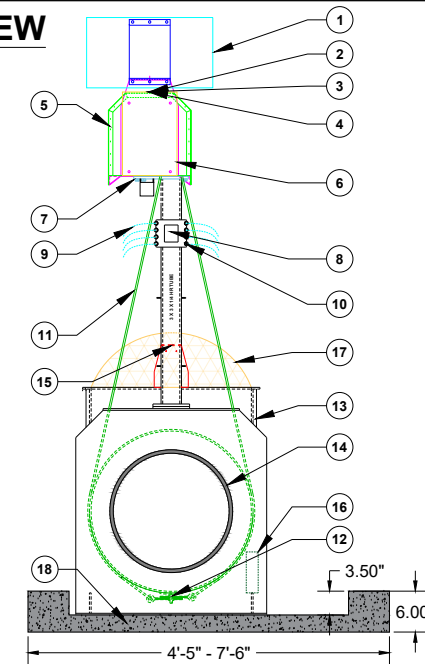

smartPOND
Automated Stormwater Control.

FOR ADDITIONAL INFORMATION PLEASE CONTACT: CONSTRUCTION ECO SERVICES, 832-456-1000, www.ecosvs.com



MAESTAS 8122 DATAPOINT DR., STE. 840
SAN ANTONIO, TX 78229
(210) 366-1988
TBPE No.: F-333
TBPLS No.: 10194506

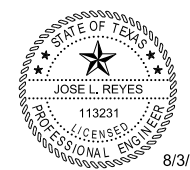

8/3/2023

NO.	DATE	REVISION	APPROVED BY

Freese and Nichols, Inc.
Texas Registered Engineering Firm F-2144
FREESE & NICHOLS 9601 McAllister Freeway, Suite 1008
San Antonio, Texas 78216
Phone - (210) 298-3800
web - www.freese.com

CITY OF SAN ANTONIO
PUBLIC WORKS DEPARTMENT

SONTERRA ROAD EXTENSION
SMARTPOND AUTOMATED
BATCH WEIRD DETAILS

SHEET 2 OF 2

PRELIMINARY	PROJECT NO.:	23-01849	DATE:	6/5/2023
DRWN. BY: GC	DSGN. BY: GC	CHKD. BY: JR	SHEET 114 OF 179	

ATTACHMENT G – Maintenance Plan

Attached following this page.

ATTACHMENT G

SUGGESTED MAINTENANCE PLAN AND SCHEDULE FOR BATCH DETENTION BASIN

PROJECT NAME: Sonterra Road Extension Project

LOCATION: Between E. Sonterra Blvd & Gold Canyon Rd at the N Loop 1604 E Access Rd and
Gold Canyon Rd

CITY, STATE ZIP: San Antonio, TX 78232

Inspections

Inspections should take place a minimum of twice a year. One inspection should take place during wet weather to determine if the basin is meeting the target detention time of 12 hours and a drawdown time of no more than 48 hours. The remaining inspections should occur between storm events so that the manual operation of the valve controller can be verified. The level sensor in the basin should be inspected and any debris or sediment in the area should be removed. The outlet structure and the trash screen should be inspected for signs of clogging. Debris and sediment should be removed from the orifice and outlets as described in previous sections. Debris obstructing the valve should be removed. During each inspection, erosion areas inside and downstream of this BMP should be identified and repaired/revegetated immediately.

Mowing

The basin, basin side-slopes, and embankment of the basin must be mowed to prevent woody growth and control weeds. A mulching mower should be used, or the grass clippings should be caught and removed. Mowing should take place at least twice a year, or more frequently if vegetation exceeds 18 inches in height. More frequent mowing to maintain aesthetic appeal may be necessary in landscaped areas.

Litter and Debris Removal

Litter and debris removal should take place at least twice a year, as part of the periodic mowing operations and inspections. Debris and litter should be removed from the surface of the basin. Particular attention should be paid to floatable debris around the outlet structure. The outlet should be checked for possible clogging or obstructions and any debris removed.

Erosion Control

The basin side slopes and embankment all may periodically suffer from slumping and erosion. To correct these problems, corrective action, such as regrading and revegetation, may be necessary. Correction of erosion control should take place whenever required based on periodic inspections.

Nuisance Control

Standing water or soggy conditions may occur in the basin. Some standing water may occur after a storm event since the valve may close with 2 to 3 inches of water in the basin. Some flow into the basin may also occur between storms due to spring flow and residential water use that enters the storm sewer system. Twice a year, the facility should be evaluated in terms of nuisance control (insects, weeds, odors, algae, etc.).

ATTACHMENT G

Structural Repairs and Replacement

With each inspection, any damage to structural elements of the basin (pipes, concrete drainage structures, retaining walls, etc.) should be identified and repaired immediately. An example of this type of repair can include patching of cracked concrete, sealing of voids, removal of vegetation from cracks and joints. The various inlet/outlet structures in a basin will eventually deteriorate and must be replaced.

Sediment Removal

A properly designed batch detention basin will accumulate quantities of sediment over time. The accumulated sediment can detract from the appearance of the facility and reduce the pollutant removal performance of the facility. The sediment also tends to accumulate near the outlet structures and can interfere with the level sensor operation. Sediment shall be removed from the basin at least every 5 years, when sediment depth exceeds 6 inches, when the sediment interferes with the level sensor or when the basin does not drain within 48 hours. Care should be taken not to compromise the basin lining during maintenance.

Logic Controller

The logic controller should be inspected as part of the twice yearly investigations. Verify that the external indicators (active, cycle in progress) are operating properly by turning the controller off and on, and by initiating a cycle by triggering the level sensor in the basin. The valve should be manually opened and closed using the open/close switch to verify valve operation and to assist in inspecting the valve for debris. The solar panel should be inspected and any dust or debris on the panel should be carefully removed. The controller and all other circuitry and wiring should be inspected for signs of corrosion, damage from insects, water leaks, or other damage. At the end of the inspection, the controller should be reset.

Responsible Party: City of San Antonio
Contact Person: Michael DiCiolla
Mailing Address: 6927 W Commerce St, Bldg 1
City, State: San Antonio, TX Zip: 78228
Telephone: (210) 207-0755 FAX: (210) 207-7900

Michael DiCiolla 6/21/2023
Signature of Responsible Party Date

The Maintenance Plan and Schedule for Permanent Erosion Control has been prepared by Jose L. Reyes, PE and is certified to be in compliance with TCEQ regulations.



Jose L. Reyes, PE

ATTACHMENT H – Pilot-Scale Field Testing Plan

Not applicable.

ATTACHMENT I – Measures for Minimizing Surface Stream Contamination

The proposed Sonterra Road Extension project improvements will create only new impervious cover for people using vehicles and pedestrians and will not increase risk to local streams. Treatment will be provided by the batch detention prior to entering the existing channel.

Agent Authorization Form
For Required Signature
Edwards Aquifer Protection Program
Relating to 30 TAC Chapter 213
Effective June 1, 1999

I Sean D. Strong, P.E.,
Print Name

Senior Engineer,
Title - Owner/President/Other

of The City of San Antonio,
Corporation/Partnership/Entity Name

have authorized Jose L. Reyes, PE
Print Name of Agent/Engineer

of Maestas & Associates, LLC
Print Name of Firm

to represent and act on the behalf of the above-named Corporation, Partnership, or Entity for the purpose of preparing and submitting this plan application to the Texas Commission on Environmental Quality (TCEQ) for the review and approval consideration of regulated activities.

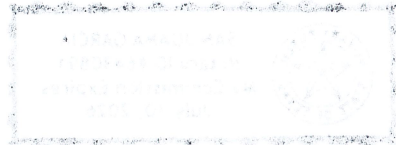

I also understand that:

1. The applicant is responsible for compliance with 30 Texas Administrative Code Chapter 213 and any condition of the TCEQ's approval letter. The TCEQ is authorized to assess administrative penalties of up to \$10,000 per day per violation.
2. For those submitting an application who are not the property owner, but who have the right to control and possess the property, additional authorization is required from the owner.
3. Application fees are due and payable at the time the application is submitted. The application fee must be sent to the TCEQ cashier or to the appropriate regional office. The application will not be considered until the correct fee is received by the commission.
4. A notarized copy of the Agent Authorization Form must be provided for the person preparing the application, and this form must accompany the completed application.
5. No person shall commence any regulated activity on the Edwards Aquifer Recharge Zone, Contributing Zone or Transition Zone until the appropriate application for the activity has been filed with and approved by the Executive Director.

SIGNATURE PAGE:

Sean D. Strong, P.E.
Applicant's Signature

08/02/2023
Date

THE STATE OF Texas §

County of Bexar §

BEFORE ME, the undersigned authority, on this day personally appeared Sean D. Strong known to me to be the person whose name is subscribed to the foregoing instrument and acknowledged to me that (s)he executed same for the purpose and consideration therein expressed.

GIVEN under my hand and seal of office on this 2nd day of August, 2023.

San Juana Garcia
NOTARY PUBLIC

San Juana Garcia
Typed or Printed Name of Notary

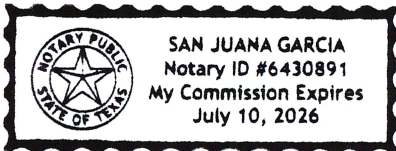

MY COMMISSION EXPIRES: July 10, 2026

Application Fee Form

Texas Commission on Environmental Quality

Name of Proposed Regulated Entity: Sonterra Road Extension Project

Regulated Entity Location: On the northeast side of the Loop 1604 and US-281 interchange.

Name of Customer: City of San Antonio

Contact Person: Jose L. Reyes, PE

Phone: 210-366-1988

Customer Reference Number (if issued): CN 600130652

Regulated Entity Reference Number (if issued): RN _____

Austin Regional Office (3373)

Hays

Travis

Williamson

San Antonio Regional Office (3362)

Bexar

Medina

Uvalde

Comal

Kinney

Application fees must be paid by check, certified check, or money order, payable to the **Texas Commission on Environmental Quality**. Your canceled check will serve as your receipt. **This form must be submitted with your fee payment.** This payment is being submitted to:

Austin Regional Office

San Antonio Regional Office

Mailed to: TCEQ - Cashier

Overnight Delivery to: TCEQ - Cashier

Revenues Section

12100 Park 35 Circle

Mail Code 214

Building A, 3rd Floor

P.O. Box 13088

Austin, TX 78753

Austin, TX 78711-3088

(512)239-0357

Site Location (Check All That Apply):

Recharge Zone

Contributing Zone

Transition Zone

<i>Type of Plan</i>	<i>Size</i>	<i>Fee Due</i>
Water Pollution Abatement Plan, Contributing Zone Plan: One Single Family Residential Dwelling	N/A Acres	\$
Water Pollution Abatement Plan, Contributing Zone Plan: Multiple Single Family Residential and Parks	N/A Acres	\$
Water Pollution Abatement Plan, Contributing Zone Plan: Non-residential	4.44 Acres	\$ 4,000
Sewage Collection System	N/A L.F.	\$
Lift Stations without sewer lines	N/A Acres	\$
Underground or Aboveground Storage Tank Facility	N/A Tanks	\$
Piping System(s)(only)	N/A Each	\$
Exception	N/A Each	\$
Extension of Time	N/A Each	\$

Signature:  _____

Date: 06/23/2023

Application Fee Schedule

Texas Commission on Environmental Quality

Edwards Aquifer Protection Program 30 TAC Chapter 213 (effective 05/01/2008)

Water Pollution Abatement Plans and Modifications

Contributing Zone Plans and Modifications

<i>Project</i>	<i>Project Area in Acres</i>	<i>Fee</i>
One Single Family Residential Dwelling	< 5	\$650
Multiple Single Family Residential and Parks	< 5	\$1,500
	5 < 10	\$3,000
	10 < 40	\$4,000
	40 < 100	\$6,500
	100 < 500	\$8,000
	≥ 500	\$10,000
Non-residential (Commercial, industrial, institutional, multi-family residential, schools, and other sites where regulated activities will occur)	< 1	\$3,000
	1 < 5	\$4,000
	5 < 10	\$5,000
	10 < 40	\$6,500
	40 < 100	\$8,000
	≥ 100	\$10,000

Organized Sewage Collection Systems and Modifications

<i>Project</i>	<i>Cost per Linear Foot</i>	<i>Minimum Fee- Maximum Fee</i>
Sewage Collection Systems	\$0.50	\$650 - \$6,500

Underground and Aboveground Storage Tank System Facility Plans and Modifications

<i>Project</i>	<i>Cost per Tank or Piping System</i>	<i>Minimum Fee- Maximum Fee</i>
Underground and Aboveground Storage Tank Facility	\$650	\$650 - \$6,500

Exception Requests

<i>Project</i>	<i>Fee</i>
Exception Request	\$500

Extension of Time Requests

<i>Project</i>	<i>Fee</i>
Extension of Time Request	\$150



TCEQ Use Only

TCEQ Core Data Form

For detailed instructions regarding completion of this form, please read the Core Data Form Instructions or call 512-239-5175.

SECTION I: General Information

1. Reason for Submission (If other is checked please describe in space provided.)		
<input checked="" type="checkbox"/> New Permit, Registration or Authorization (Core Data Form should be submitted with the program application.)		
<input type="checkbox"/> Renewal (Core Data Form should be submitted with the renewal form)	<input type="checkbox"/> Other	
2. Customer Reference Number (if issued)	Follow this link to search for CN or RN numbers in Central Registry**	3. Regulated Entity Reference Number (if issued)
CN 600130652		RN

SECTION II: Customer Information

4. General Customer Information		5. Effective Date for Customer Information Updates (mm/dd/yyyy)	
<input type="checkbox"/> New Customer		<input type="checkbox"/> Update to Customer Information	
<input type="checkbox"/> Change in Legal Name (Verifiable with the Texas Secretary of State or Texas Comptroller of Public Accounts)		<input type="checkbox"/> Change in Regulated Entity Ownership	
The Customer Name submitted here may be updated automatically based on what is current and active with the Texas Secretary of State (SOS) or Texas Comptroller of Public Accounts (CPA).			
6. Customer Legal Name (If an individual, print last name first: eg: Doe, John)		<i>If new Customer, enter previous Customer below:</i>	
7. TX SOS/CPA Filing Number	8. TX State Tax ID (11 digits)	9. Federal Tax ID (9 digits)	10. DUNS Number (if applicable)
11. Type of Customer:	<input type="checkbox"/> Corporation	<input type="checkbox"/> Individual	Partnership: <input type="checkbox"/> General <input type="checkbox"/> Limited
Government: <input type="checkbox"/> City <input type="checkbox"/> County <input type="checkbox"/> Federal <input type="checkbox"/> State <input type="checkbox"/> Other	<input type="checkbox"/> Sole Proprietorship	<input type="checkbox"/> Other:	
12. Number of Employees		13. Independently Owned and Operated?	
<input type="checkbox"/> 0-20 <input type="checkbox"/> 21-100 <input type="checkbox"/> 101-250 <input type="checkbox"/> 251-500 <input type="checkbox"/> 501 and higher		<input type="checkbox"/> Yes <input type="checkbox"/> No	
14. Customer Role (Proposed or Actual) – as it relates to the Regulated Entity listed on this form. Please check one of the following			
<input type="checkbox"/> Owner		<input type="checkbox"/> Operator	
<input type="checkbox"/> Occupational Licensee		<input type="checkbox"/> Owner & Operator	
<input type="checkbox"/> Responsible Party		<input type="checkbox"/> Voluntary Cleanup Applicant	
<input type="checkbox"/> Other:			
15. Mailing Address:			
	City	State	ZIP
		ZIP + 4	
16. Country Mailing Information (if outside USA)		17. E-Mail Address (if applicable)	
18. Telephone Number		19. Extension or Code	
() -			
		20. Fax Number (if applicable)	
		() -	

SECTION III: Regulated Entity Information

21. General Regulated Entity Information (If 'New Regulated Entity' is selected below this form should be accompanied by a permit application)	
<input checked="" type="checkbox"/> New Regulated Entity <input type="checkbox"/> Update to Regulated Entity Name <input type="checkbox"/> Update to Regulated Entity Information	
The Regulated Entity Name submitted may be updated in order to meet TCEQ Agency Data Standards (removal of organizational endings such as Inc, LP, or LLC).	
22. Regulated Entity Name (Enter name of the site where the regulated action is taking place.)	
Sonterra Road Extension Project	

23. Street Address of the Regulated Entity: <i>(No PO Boxes)</i>	Not Applicable						
	City		State		ZIP		ZIP + 4
24. County	Bexar						

Enter Physical Location Description if no street address is provided.

25. Description to Physical Location:	On the northeast side of the Loop 1604 and US-281 interchange.						
26. Nearest City					State	Nearest ZIP Code	
San Antonio					TX	78255	
27. Latitude (N) In Decimal:	29.6066			28. Longitude (W) In Decimal:	-98.4574		
Degrees	Minutes	Seconds	Degrees	Minutes	Seconds		
29	36	23.76	-98	27	26.64		
29. Primary SIC Code (4 digits)	30. Secondary SIC Code (4 digits)		31. Primary NAICS Code (5 or 6 digits)		32. Secondary NAICS Code (5 or 6 digits)		
1611	1629		237310		238990		
33. What is the Primary Business of this entity? <i>(Do not repeat the SIC or NAICS description.)</i>							
Roadway Improvements							
34. Mailing Address:	PO Box 839966						
	City	San Antonio	State	TX	ZIP	78283	ZIP + 4 3966
35. E-Mail Address:		Sean.Strong@sanantonio.gov					
36. Telephone Number		37. Extension or Code			38. Fax Number (if applicable)		
(210) 207-8037					(210) 207-4406		

39. TCEQ Programs and ID Numbers Check all Programs and write in the permits/registration numbers that will be affected by the updates submitted on this form. See the Core Data Form instructions for additional guidance.

<input type="checkbox"/> Dam Safety	<input type="checkbox"/> Districts	<input checked="" type="checkbox"/> Edwards Aquifer	<input type="checkbox"/> Emissions Inventory Air	<input type="checkbox"/> Industrial Hazardous Waste
<input type="checkbox"/> Municipal Solid Waste	<input type="checkbox"/> New Source Review Air	<input type="checkbox"/> OSSF	<input type="checkbox"/> Petroleum Storage Tank	<input type="checkbox"/> PWS
<input type="checkbox"/> Sludge	<input checked="" type="checkbox"/> Storm Water	<input type="checkbox"/> Title V Air	<input type="checkbox"/> Tires	<input type="checkbox"/> Used Oil
<input type="checkbox"/> Voluntary Cleanup	<input type="checkbox"/> Waste Water	<input type="checkbox"/> Wastewater Agriculture	<input type="checkbox"/> Water Rights	<input type="checkbox"/> Other:

SECTION IV: Preparer Information

40. Name:	Jose L. Reyes	41. Title:	Project Manager
42. Telephone Number	43. Ext./Code	44. Fax Number	45. E-Mail Address
(210) 366-1988	8111	(210) 366-1980	jreyes@maesce.com

SECTION V: Authorized Signature

46. By my signature below, I certify, to the best of my knowledge, that the information provided in this form is true and complete, and that I have signature authority to submit this form on behalf of the entity specified in Section II, Field 6 and/or as required for the updates to the ID numbers identified in field 39.

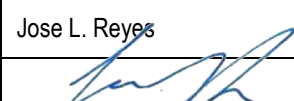
Company:	Maestas & Associates, LLC	Job Title:	President
Name (In Print):	Jose L. Reyes	Phone:	(210) 366- 1988
Signature:		Date:	07/27/2023