



# **VERAMENDI PRECINCT 18**

## **UNIT 1**

### **Organized Sewage Collection System Plan**

**December 2023**



# VERAMENDI PRECINCT 18

## UNIT 1

### Organized Sewage Collection System Plan

December 2023

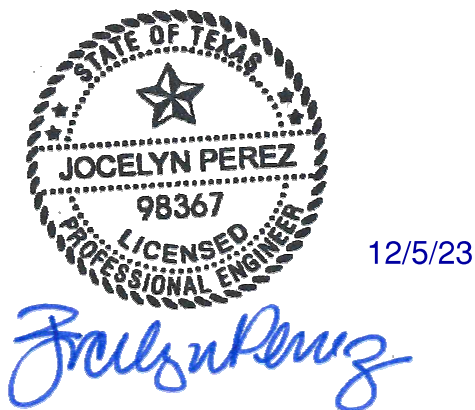



December 5, 2023

Ms. Lillian Butler  
Texas Commission on Environmental Quality  
Region 13  
14250 Judson Road  
San Antonio, Texas 78233-4480

Re: Veramendi Precinct 18 Unit 1  
Sewage Collection System Application

Dear Ms. Butler:

Please find included herein the Veramendi Precinct 18 Unit 1 Sewage Collection System Application. This Sewage Collection System Application has been prepared to be consistent with the regulations of the Texas Administrative Code (30 TAC 213, 217 and 290) and current policies for development over the Edwards Aquifer Recharge Zone.

This Sewage Collection System Application applies to the 11,445 linear feet of sewer main proposed as part of this project. Please review the plan information for the items it is intended to address. If acceptable, provide a written approval of the plan in order that construction may begin at the earliest opportunity.

Appropriate review fees (\$5,722.61) and fee application form are included. If you have questions or require additional information, please do not hesitate to contact me at your earliest convenience.

Sincerely,  
Pape-Dawson Engineers

Jocelyn Perez, P.E.  
Vice President

Attachments

P:\300\01\66\Word\Reports\SCS\230928-SCS Cover Letter.Docx



12/5/23

**EDWARDS AQUIFER  
APPLICATION COVER PAGE  
(TCEQ-20705)**

# Texas Commission on Environmental Quality

## Edwards Aquifer Application Cover Page

---

### Our Review of Your Application

**The Edwards Aquifer Program staff conducts an administrative and technical review of all applications. The turnaround time for administrative review can be up to 30 days as outlined in 30 TAC 213.4(e). Generally administrative completeness is determined during the intake meeting or within a few days of receipt. The turnaround time for technical review of an administratively complete Edwards Aquifer application is 90 days as outlined in 30 TAC 213.4(e). Please know that the review and approval time is directly impacted by the quality and completeness of the initial application that is received. In order to conduct a timely review, it is imperative that the information provided in an Edwards Aquifer application include final plans, be accurate, complete, and in compliance with [30 TAC 213](#).**

### Administrative Review

1. [Edwards Aquifer applications](#) must be deemed administratively complete before a technical review can begin. To be considered administratively complete, the application must contain completed forms and attachments, provide the requested information, and meet all the site plan requirements. The submitted application and plan sheets should be final plans. Please submit one full-size set of plan sheets with the original application, and half-size sets with the additional copies.

To ensure that all applicable documents are included in the application, the program has developed tools to guide you and web pages to provide all forms, checklists, and guidance. Please visit the below website for assistance: <http://www.tceq.texas.gov/field/eapp>.

2. This Edwards Aquifer Application Cover Page form (certified by the applicant or agent) must be included in the application and brought to the administrative review meeting.
3. Administrative reviews are scheduled with program staff who will conduct the review. Applicants or their authorized agent should call the appropriate regional office, according to the county in which the project is located, to schedule a review. The average meeting time is one hour.
4. In the meeting, the application is examined for administrative completeness. Deficiencies will be noted by staff and emailed or faxed to the applicant and authorized agent at the end of the meeting, or shortly after. Administrative deficiencies will cause the application to be deemed incomplete and returned.

An appointment should be made to resubmit the application. The application is re-examined to ensure all deficiencies are resolved. The application will only be deemed administratively complete when all administrative deficiencies are addressed.

5. If an application is received by mail, courier service, or otherwise submitted without a review meeting, the administrative review will be conducted within 30 days. The applicant and agent will be contacted with the results of the administrative review. If the application is found to be administratively incomplete, it can be retrieved from the regional office or returned by regular mail. If returned by mail, the regional office may require arrangements for return shipping.
6. If the geologic assessment was completed before October 1, 2004 and the site contains “possibly sensitive” features, the assessment must be updated in accordance with the *Instructions to Geologists* (TCEQ-0585 Instructions).

### Technical Review

1. When an application is deemed administratively complete, the technical review period begins. The regional office will distribute copies of the application to the identified affected city, county, and groundwater conservation district whose jurisdiction includes the subject site. These entities and the public have 30 days to provide comments on the application to the regional office. All comments received are reviewed by TCEQ.
2. A site assessment is usually conducted as part of the technical review, to evaluate the geologic assessment and observe existing site conditions. The site must be accessible to our staff. The site boundaries should be

clearly marked, features identified in the geologic assessment should be flagged, roadways marked and the alignment of the Sewage Collection System and manholes should be staked at the time the application is submitted. If the site is not marked the application may be returned.

3. We evaluate the application for technical completeness and contact the applicant and agent via Notice of Deficiency (NOD) to request additional information and identify technical deficiencies. There are two deficiency response periods available to the applicant. There are 14 days to resolve deficiencies noted in the first NOD. If a second NOD is issued, there is an additional 14 days to resolve deficiencies. If the response to the second notice is not received, is incomplete or inadequate, or provides new information that is incomplete or inadequate, the application must be withdrawn or will be denied. Please note that because the technical review is underway, whether the application is withdrawn or denied **the application fee will be forfeited.**
4. The program has 90 calendar days to complete the technical review of the application. If the application is technically adequate, such that it complies with the Edwards Aquifer rules, and is protective of the Edwards Aquifer during and after construction, an approval letter will be issued. Construction or other regulated activity may not begin until an approval is issued.

### Mid-Review Modifications

It is important to have final site plans prior to beginning the permitting process with TCEQ to avoid delays.

Occasionally, circumstances arise where you may have significant design and/or site plan changes after your Edwards Aquifer application has been deemed administratively complete by TCEQ. This is considered a “Mid-Review Modification”. Mid-Review Modifications may require redistribution of an application that includes the proposed modifications for public comment.

If you are proposing a Mid-Review Modification, two options are available:

- If the technical review has begun your application can be denied/withdrawn, your fees will be forfeited, and the plan will have to be resubmitted.
- TCEQ can continue the technical review of the application as it was submitted, and a modification application can be submitted at a later time.

If the application is denied/withdrawn, the resubmitted application will be subject to the administrative and technical review processes and will be treated as a new application. The application will be redistributed to the affected jurisdictions.

Please contact the regional office if you have questions. If your project is located in Williamson, Travis, or Hays County, contact TCEQ’s Austin Regional Office at 512-339-2929. If your project is in Comal, Bexar, Medina, Uvalde, or Kinney County, contact TCEQ’s San Antonio Regional Office at 210-490-3096

Please fill out all required fields below and submit with your application.

<b>1. Regulated Entity Name:</b> Veramendi Precinct 18 Unit 1				<b>2. Regulated Entity No.:</b>					
<b>3. Customer Name:</b> Veramendi PE - Emerald, LLC				<b>4. Customer No.:</b> 60612370					
<b>5. Project Type:</b> (Please circle/check one)	<input checked="" type="radio"/> New	Modification		Extension	Exception				
<b>6. Plan Type:</b> (Please circle/check one)	WPAP	CZP	<input checked="" type="radio"/> SCS	UST	AST	EXP	EXT	Technical Clarification	Optional Enhanced Measures
<b>7. Land Use:</b> (Please circle/check one)	<input checked="" type="radio"/> Residential		Non-residential		<b>8. Site (acres):</b>				
<b>9. Application Fee:</b>	\$5722.61		<b>10. Permanent BMP(s):</b>						
<b>11. SCS (Linear Ft.):</b>	11,445.21		<b>12. AST/UST (No. Tanks):</b>						
<b>13. County:</b>	Comal		<b>14. Watershed:</b>		Blieders Creek				

# Application Distribution

Instructions: Use the table below to determine the number of applications required. One original and one copy of the application, plus additional copies (as needed) for each affected incorporated city, county, and groundwater conservation district are required. Linear projects or large projects, which cross into multiple jurisdictions, can require additional copies. Refer to the “Texas Groundwater Conservation Districts within the EAPP Boundaries” map found at:

[http://www.tceq.texas.gov/assets/public/compliance/field\\_ops/eapp/EAPP%20GWCD%20map.pdf](http://www.tceq.texas.gov/assets/public/compliance/field_ops/eapp/EAPP%20GWCD%20map.pdf)

For more detailed boundaries, please contact the conservation district directly.

<b>Austin Region</b>			
<b>County:</b>	<b>Hays</b>	<b>Travis</b>	<b>Williamson</b>
Original (1 req.)	—	—	—
Region (1 req.)	—	—	—
County(ies)	—	—	—
Groundwater Conservation District(s)	<input type="checkbox"/> Edwards Aquifer Authority <input type="checkbox"/> Barton Springs/ Edwards Aquifer <input type="checkbox"/> Hays Trinity <input type="checkbox"/> Plum Creek	<input type="checkbox"/> Barton Springs/ Edwards Aquifer	NA
City(ies) Jurisdiction	<input type="checkbox"/> Austin <input type="checkbox"/> Buda <input type="checkbox"/> Dripping Springs <input type="checkbox"/> Kyle <input type="checkbox"/> Mountain City <input type="checkbox"/> San Marcos <input type="checkbox"/> Wimberley <input type="checkbox"/> Woodcreek	<input type="checkbox"/> Austin <input type="checkbox"/> Bee Cave <input type="checkbox"/> Pflugerville <input type="checkbox"/> Rollingwood <input type="checkbox"/> Round Rock <input type="checkbox"/> Sunset Valley <input type="checkbox"/> West Lake Hills	<input type="checkbox"/> Austin <input type="checkbox"/> Cedar Park <input type="checkbox"/> Florence <input type="checkbox"/> Georgetown <input type="checkbox"/> Jerrell <input type="checkbox"/> Leander <input type="checkbox"/> Liberty Hill <input type="checkbox"/> Pflugerville <input type="checkbox"/> Round Rock

<b>San Antonio Region</b>					
<b>County:</b>	<b>Bexar</b>	<b>Comal</b>	<b>Kinney</b>	<b>Medina</b>	<b>Uvalde</b>
Original (1 req.)	—	✓	—	—	—
Region (1 req.)	—	✓	—	—	—
County(ies)	—	✓	—	—	—
Groundwater Conservation District(s)	<input type="checkbox"/> Edwards Aquifer Authority <input type="checkbox"/> Trinity-Glen Rose	<input checked="" type="checkbox"/> Edwards Aquifer Authority	<input type="checkbox"/> Kinney	<input type="checkbox"/> EAA <input type="checkbox"/> Medina	<input type="checkbox"/> EAA <input type="checkbox"/> Uvalde
City(ies) Jurisdiction	<input type="checkbox"/> Castle Hills <input type="checkbox"/> Fair Oaks Ranch <input type="checkbox"/> Helotes <input type="checkbox"/> Hill Country Village <input type="checkbox"/> Hollywood Park <input type="checkbox"/> San Antonio (SAWS) <input type="checkbox"/> Shavano Park	<input type="checkbox"/> Bulverde <input type="checkbox"/> Fair Oaks Ranch <input type="checkbox"/> Garden Ridge <input checked="" type="checkbox"/> New Braunfels <input type="checkbox"/> Schertz	NA	<input type="checkbox"/> San Antonio ETJ (SAWS)	NA

I certify that to the best of my knowledge, that the application is complete and accurate. This application is hereby submitted to TCEQ for administrative review and technical review.

Jocelyn Perez, P.E.

Print Name of Customer/Authorized Agent

*Jocelyn Perez* 12/5/23

Signature of Customer/Authorized Agent Date

**\*\*FOR TCEQ INTERNAL USE ONLY\*\***

Date(s) Reviewed:		Date Administratively Complete:	
Received From:		Correct Number of Copies:	
Received By:		Distribution Date:	
EAPP File Number:		Complex:	
Admin. Review(s) (No.):		No. AR Rounds:	
Delinquent Fees (Y/N):		Review Time Spent:	
Lat./Long. Verified:		SOS Customer Verification:	
Agent Authorization Complete/Notarized (Y/N):		Fee Check:	Payable to TCEQ (Y/N):
Core Data Form Complete (Y/N):			Signed (Y/N):
Core Data Form Incomplete Nos.:			Less than 90 days old (Y/N):

**GENERAL INFORMATION  
FORM (TCEQ-0587)**

# General Information Form

## Texas Commission on Environmental Quality

For Regulated Activities on the Edwards Aquifer Recharge and Transition Zones and Relating to 30 TAC §213.4(b) & §213.5(b)(2)(A), (B) Effective June 1, 1999

**To ensure that the application is administratively complete, confirm that all fields in the form are complete, verify that all requested information is provided, consistently reference the same site and contact person in all forms in the application, and ensure forms are signed by the appropriate party.**

**Note: Including all the information requested in the form and attachments contributes to more streamlined technical reviews.**

## Signature

To the best of my knowledge, the responses to this form accurately reflect all information requested concerning the proposed regulated activities and methods to protect the Edwards Aquifer. This **General Information Form** is hereby submitted for TCEQ review. The application was prepared by:

Print Name of Customer/Agent: Jocelyn Perez, P.E.

Date: 12/5/23

Signature of Customer/Agent:

  
\_\_\_\_\_

## Project Information

1. Regulated Entity Name: Veramendi Precinct 18 Unit 1
2. County: Comal
3. Stream Basin: Blieders Creek
4. Groundwater Conservation District (If applicable): Edwards Aquifer Authority
5. Edwards Aquifer Zone:  
 Recharge Zone  
 Transition Zone
6. Plan Type:  
 WPAP  
 SCS  
 Modification  
 AST  
 UST  
 Exception Request



7. Customer (Applicant):

Contact Person: Garrett Mechler  
Entity: Veramendi PE - Emerald, LLC  
Mailing Address: PO Box 310699  
City, State: New Braunfels, Texas Zip: 78131  
Telephone: (830) 643-1338 FAX: \_\_\_\_\_  
Email Address: garrett.mechler@asaproperties.us.com

8. Agent/Representative (If any):

Contact Person: Jocelyn Perez, P.E.  
Entity: Pape-Dawson Engineers, Inc.  
Mailing Address: 1672 Independence Dr, Ste 102  
City, State: New Braunfels, Texas Zip: 78213  
Telephone: (210) 375-9000 FAX: (210) 375-9010  
Email Address: jperez@pape-dawson.com

9. Project Location:

- The project site is located inside the city limits of \_\_\_\_\_.
- The project site is located outside the city limits but inside the ETJ (extra-territorial jurisdiction) of New Braunfels.
- The project site is not located within any city's limits or ETJ.

10.  The location of the project site is described below. The description provides sufficient detail and clarity so that the TCEQ's Regional staff can easily locate the project and site boundaries for a field investigation.

From TCEQ's regional office, turn left and proceed approximately 1.5 miles to IH-35 north and turn left. Travel approximately 14.5 miles to exit 184 toward TX-337 and turn left. Proceed approximately 3.5 miles to TX-46 and stay left. Travel approximately 1.46 miles on TX-46/TX-337 to Word Pkwy. The project side is located approximately 1.0 miles Northwest of TX-46/TX-337 and Word Pkwy intersection.

11.  **Attachment A – Road Map.** A road map showing directions to and the location of the project site is attached. The project location and site boundaries are clearly shown on the map.
12.  **Attachment B - USGS / Edwards Recharge Zone Map.** A copy of the official 7 ½ minute USGS Quadrangle Map (Scale: 1" = 2000') of the Edwards Recharge Zone is attached. The map(s) clearly show:
- Project site boundaries.
  - USGS Quadrangle Name(s).
  - Boundaries of the Recharge Zone (and Transition Zone, if applicable).
  - Drainage path from the project site to the boundary of the Recharge Zone.
13.  **The TCEQ must be able to inspect the project site or the application will be returned.** Sufficient survey staking is provided on the project to allow TCEQ regional staff to locate

the boundaries and alignment of the regulated activities and the geologic or manmade features noted in the Geologic Assessment.

Survey staking will be completed by this date: once advised by TCEQ staff of inspection

14.  **Attachment C – Project Description.** Attached at the end of this form is a detailed narrative description of the proposed project. The project description is consistent throughout the application and contains, at a minimum, the following details:

- Area of the site
- Offsite areas
- Impervious cover
- Permanent BMP(s)
- Proposed site use
- Site history
- Previous development
- Area(s) to be demolished

15. Existing project site conditions are noted below:

- Existing commercial site
- Existing industrial site
- Existing residential site
- Existing paved and/or unpaved roads
- Undeveloped (Cleared)
- Undeveloped (Undisturbed/Uncleared)
- Other: \_\_\_\_\_

### ***Prohibited Activities***

16.  I am aware that the following activities are prohibited on the Recharge Zone and are not proposed for this project:

- (1) Waste disposal wells regulated under 30 TAC Chapter 331 of this title (relating to Underground Injection Control);
- (2) New feedlot/concentrated animal feeding operations, as defined in 30 TAC §213.3;
- (3) Land disposal of Class I wastes, as defined in 30 TAC §335.1;
- (4) The use of sewage holding tanks as parts of organized collection systems; and
- (5) New municipal solid waste landfill facilities required to meet and comply with Type I standards which are defined in §330.41(b), (c), and (d) of this title (relating to Types of Municipal Solid Waste Facilities).
- (6) New municipal and industrial wastewater discharges into or adjacent to water in the state that would create additional pollutant loading.

17.  I am aware that the following activities are prohibited on the Transition Zone and are not proposed for this project:

- (1) Waste disposal wells regulated under 30 TAC Chapter 331 (relating to Underground Injection Control);
- (2) Land disposal of Class I wastes, as defined in 30 TAC §335.1; and
- (3) New municipal solid waste landfill facilities required to meet and comply with Type I standards which are defined in §330.41 (b), (c), and (d) of this title.

### ***Administrative Information***

18. The fee for the plan(s) is based on:

- For a Water Pollution Abatement Plan or Modification, the total acreage of the site where regulated activities will occur.
- For an Organized Sewage Collection System Plan or Modification, the total linear footage of all collection system lines.
- For a UST Facility Plan or Modification or an AST Facility Plan or Modification, the total number of tanks or piping systems.
- A request for an exception to any substantive portion of the regulations related to the protection of water quality.
- A request for an extension to a previously approved plan.

19.  Application fees are due and payable at the time the application is filed. If the correct fee is not submitted, the TCEQ is not required to consider the application until the correct fee is submitted. Both the fee and the Edwards Aquifer Fee Form have been sent to the Commission's:

- TCEQ cashier
- Austin Regional Office (for projects in Hays, Travis, and Williamson Counties)
- San Antonio Regional Office (for projects in Bexar, Comal, Kinney, Medina, and Uvalde Counties)

20.  Submit one (1) original and one (1) copy of the application, plus additional copies as needed for each affected incorporated city, groundwater conservation district, and county in which the project will be located. The TCEQ will distribute the additional copies to these jurisdictions. The copies must be submitted to the appropriate regional office.

21.  No person shall commence any regulated activity until the Edwards Aquifer Protection Plan(s) for the activity has been filed with and approved by the Executive Director.

**ATTACHMENT A**

**VERAMENDI - Precinct 18 Unit 1  
New Braunfels, Texas  
Organized Sewage Collection System Plan**

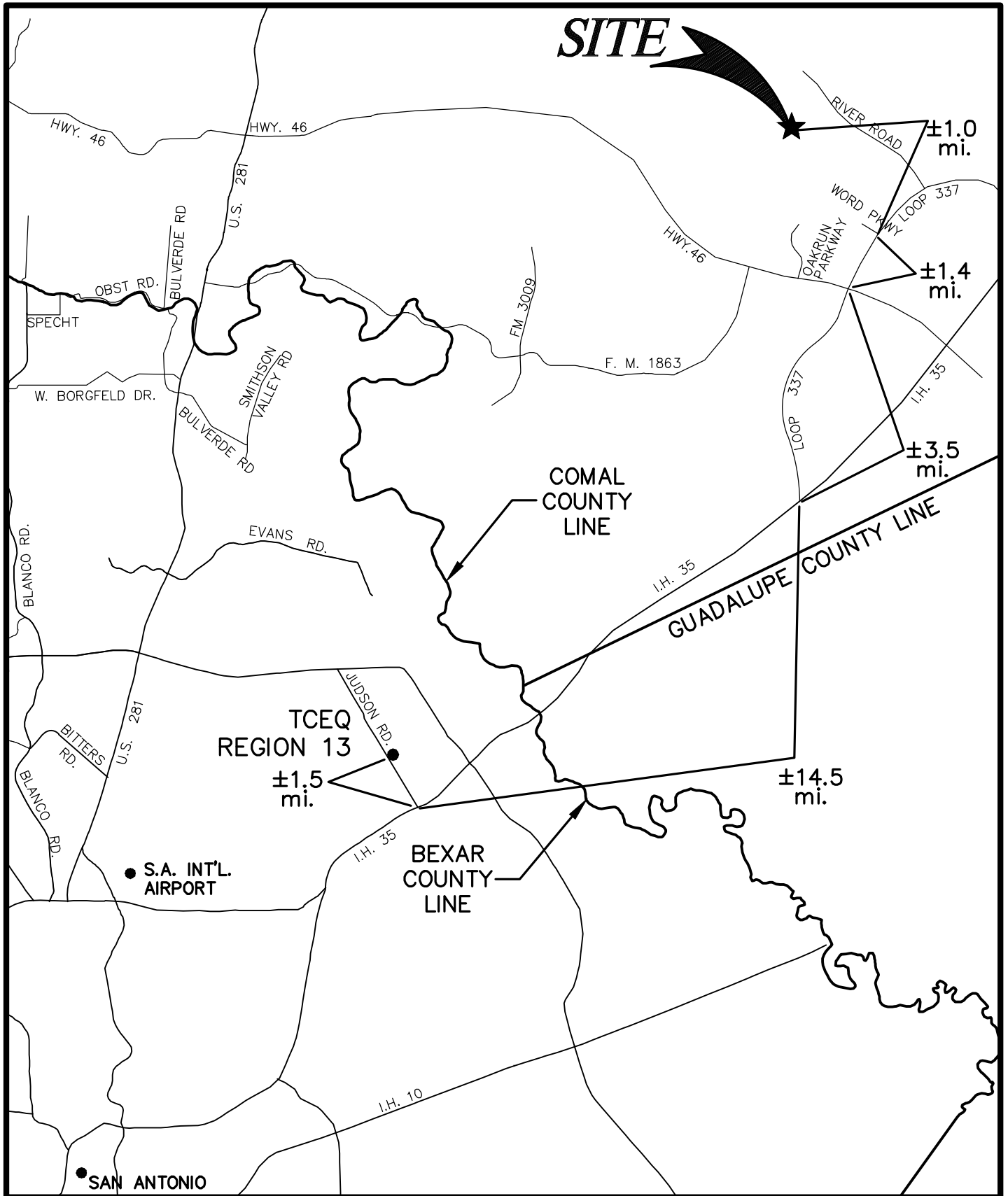

**ATTACHMENT B**



**VERAMENDI - PRECINCT 18 UNIT 1**  
**New Braunfels, Texas**  
**Organized Sewage Collection System Plan**

  
 SCALE: 1" = 2000'

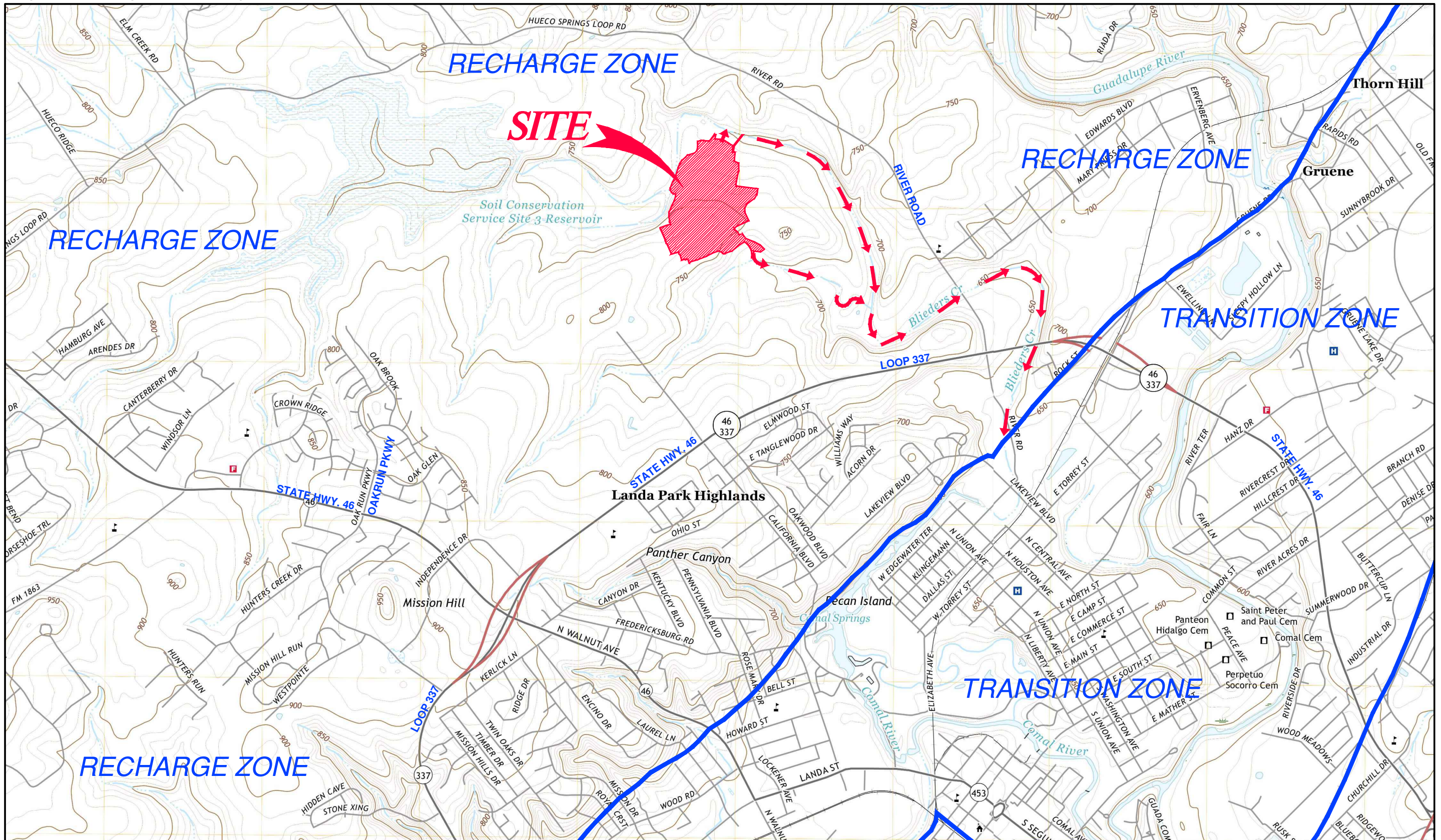

Date: Oct 04, 2023, 3:08pm User: D:\lynch  
 File: P:\300\01\66\Design\Environmental\SCS\003000166-sscs.dwg

GENERAL LOCATION MAP - NEW BRAUNFELS WEST, TX QUAD;  
 NEW BRAUNFELS EAST, TX QUAD  
 DRAINAGE FLOW   
 Pape-Dawson Engineers, Inc.

USGS/EDWARDS RECHARGE ZONE MAP  
 ATTACHMENT B



**ATTACHMENT C**



# VERAMENDI PRECINCT 18 UNIT 1

## Organized Sewage Collection System Plan

### Attachment C – Project Description

Veramendi Precinct 18 Units 1 is a 215 lot single-family residential development associated with an overall development of 121.98 acres within the Extra-Territorial Jurisdiction of the City of New Braunfels in Comal County, Texas. The site is located approximately 1.0 miles NW of TX-46/TX-337 and Word Pkwy intersection. The property is currently undeveloped, lies within the Blieders Creek watershed, and does contain 100-year floodplain.

The project Sewage Collection System (SCS) Application proposes the construction of a total of approximately 11,445.21 linear feet (LF) of sanitary sewer main to serve the proposed residential development over the Edwards Aquifer Recharge Zone. The proposed alignment will consist of approximately 9,985.21 linear feet (LF) of 8-inch (8") polyvinyl chloride (PVC), SDR 26 gravity sewer main and 1,460.00 linear feet (LF) of 8-inch (8") PVC, SDR 26 160-psi pressure rated sewer main centered at water line crossings, see included plan and profile exhibits for details. Regulated activities proposed include excavation, construction of sewer mains, manholes, backfill, and compaction. Approximately 26.49 acres may be disturbed as identified by the limits of the fifty foot (50') SCS/GA envelope shown on the plans; however additional grading will disturb approximately 121.98 acres as part of development of the overall unit as a part of the Veramendi Word Pkwy Phase 3, Precinct 18 Unit 1, and Precinct 4 Units 1, 2, & 3 WPAP

This project will result in an estimated additional 215 Living Unit Equivalent (LUEs). The permanent population associated with Veramendi Precinct 18 Unit 1 is estimated to be 860 people, based on four (4) persons per lot. Approximately 45,150 gallons per day (average flow) of domestic wastewater are estimated to be generated by this project. No Stub-outs are proposed with this SCS as this will complete this phase of the single-family development.

The sewage flow will be disposed of by conveyance to the existing Gruene Wastewater Treatment Center operated by New Braunfels Utilities (NBU). Potable water will be supplied by NBU. There are no naturally occurring sensitive features identified with the SCS envelope in the Geological Assessment.

**GEOLOGIC ASSESSMENT FORM**  
**(TCEQ-0585)**

***Geologic Site Assessment (WPAP)  
for Regulated Activities / Development  
on the Edwards Aquifer Recharge / Transition Zone***

***The Veramendi Subdivision  
+/- 2,400 Acres  
New Braunfels, Texas***

***FROST GEOSCIENCES CONTROL # FGS-E10139***

***May 9, 2017***

---

***Prepared exclusively for***

***ASA Properties, LLC  
2021 SH 46, Suite 101  
New Braunfels, Texas 78132***

***Frost GeoSciences***

***Geotechnical ▪ Construction Materials  
Forensics ▪ Environmental***

***13402 Western Oak • Helotes, Texas 78023 • Phone: (210) 372-1315 • Fax: (210) 372-1318***

# Frost GeoSciences

Geotechnical • Construction Materials  
Forensics • Environmental

13402 Western Oak  
Helotes, Texas 78023

Phone (210) 372-1315

Fax (210) 372-1318

[www.frostgeosciences.com](http://www.frostgeosciences.com)

TBPE Firm Registration # F-9227

TBPE Firm Registration # 50040

May 9, 2017

ASA Properties, LLC  
2021 SH 46, Suite 101  
New Braunfels, Texas 78132

Attn: Mr. Max Hartford

Re: Geologic Site Assessment (WPAP)  
for Regulated Activities / Development on the  
Edwards Aquifer Recharge / Transition Zone  
The Veramendi Subdivision  
+/- 2,400 Acres  
New Braunfels, Texas

Frost GeoSciences, Inc. Control # FGS-EI0139

Dear Sir:

Attached is a copy of the Geologic Assessment Report completed for the above referenced project site as it relates to 30 TAC §213.5(b)(3), effective June 1, 1999. Our investigation was conducted and this report was prepared in general accordance with the "Instructions to Geologists", TCEQ-0585-Instructions (Rev. 10-1-04). The results of our investigation, along with any recommendations for Best Management Practices (BMP's), are provided in the following report.

If you have any questions regarding this report, or if Frost GeoSciences, Inc. may be of additional assistance to you on this project, please feel free to call our office. It has been a pleasure to work with you and we wish to thank you for the opportunity to be of service to you on this project. We look forward to being of continued service.



Sincerely,  
Frost GeoSciences, Inc.

Steve Frost, C.P.G., P.G.  
President, Senior Geologist

Distribution: (1) ASA Properties, LLC  
(5) Pape Dawson Engineers



**Table of Contents**

GEOLOGIC ASSESSMENT FORM ..... 1

STRATIGRAPHIC COLUMN ..... 4

GEOLOGIC ASSESSMENT TABLE ..... 5

LOCATION ..... 12

METHODOLOGY ..... 12

RESEARCH & OBSERVATIONS ..... 13

    7.5 Minute Quadrangle Map Review ..... 13

    Recharge/Transition Zone ..... 13

    100-Year Floodplain ..... 14

    Soils ..... 15

    Narrative Description of the Site Geology ..... 18

BEST MANAGEMENT PRACTICES ..... 24

DISCLAIMER ..... 25

REFERENCES ..... 25

APPENDIX

A: Plate 1: Site Plan

    Plate 2: Street Map

    Plate 3: USGS Topographic Map

    Plate 4: Official Edwards Aquifer Recharge Zone Map

    Plate 5: FEMA Flood Map

    Plate 6: 1973 Aerial Photograph, 1"=2000'

    Plate 7: Geologic Map

    Plate 8: 2010 Aerial Photograph, 1"=2000'

    Plate 9: 2010 Aerial Photograph with PRF's, 1"=500M

B: Site Photographs

C: Site Geologic Map

# Geologic Assessment

## Texas Commission on Environmental Quality

For Regulated Activities on The Edwards Aquifer Recharge/transition Zones and Relating to 30 TAC §213.5(b)(3), Effective June 1, 1999

*To ensure that the application is administratively complete, confirm that all fields in the form are complete, verify that all requested information is provided, consistently reference the same site and contact person in all forms in the application, and ensure forms are signed by the appropriate party.*

*Note: Including all the information requested in the form and attachments contributes to more streamlined technical reviews.*

## Signature

To the best of my knowledge, the responses to this form accurately reflect all information requested concerning the proposed regulated activities and methods to protect the Edwards Aquifer. My signature certifies that I am qualified as a geologist as defined by 30 TAC Chapter 213.

Print Name of Geologist: Steve Frost, C.P.G., P.G. Telephone: (210) 372-1315

Date: May 9, 2017 Fax: (210) 372-1318

Representing: Frost GeoSciences, Inc.

Signature of Geologist:

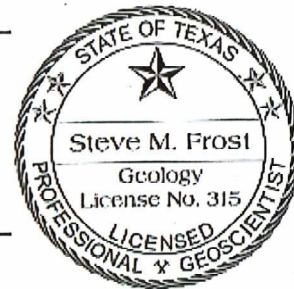
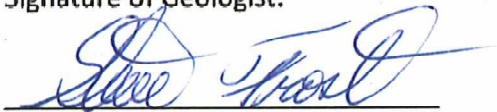

Regulated Entity Name: The Veramendi Subdivision

## Project Information

1. Date(s) Geologic Assessment was performed: June 16 through November 23, 2010

2. Type of Project:

WPAP

AST

SCS

UST

3. Location of Project:

Recharge Zone

Transition Zone

Contributing Zone within the Transition Zone

1 of 3

TCEQ-0585 (Rev.02-11-15)

May 9, 2017  
The Veramendi Subdivision  
Page 1

4.  **Attachment A - Geologic Assessment Table.** Completed Geologic Assessment Table (Form TCEQ-0585-Table) is attached.
5.  Soil cover on the project site is summarized in the table below and uses the SCS Hydrologic Soil Groups\* (Urban Hydrology for Small Watersheds, Technical Release No. 55, Appendix A, Soil Conservation Service, 1986). If there is more than one soil type on the project site, show each soil type on the site Geologic Map or a separate soils map.

**Table 1 - Soil Units, Infiltration Characteristics and Thickness**

Soil Name	Group*	Thickness(feet)
Rumple-Comfort Association Undulating (RUD)	C/D	1 to 2
Comfort Rock Outcrop Complex Undulating (CrD)	D/D	0 to 2
Brackett-Rock Outcrop-Comfort Complex Undulating (R/D)	C/D/D	0 to 2
Lewisville Silty Clay, 1 to 3 Percent Slopes (LeB)	B	2+
Medlin-Eckman Assoc. (MED/AIEC)	D	1-2
Orin Soils Frequently Flooded (Or)	A	2+

*\* Soil Group Definitions (Abbreviated)*

- A. Soils having a high infiltration rate when thoroughly wetted.
- B. Soils having a moderate infiltration rate when thoroughly wetted.
- C. Soils having a slow infiltration rate when thoroughly wetted.
- D. Soils having a very slow infiltration rate when thoroughly wetted.

6.  **Attachment B – Stratigraphic Column.** A stratigraphic column showing formations, members, and thicknesses is attached. The outcropping unit, if present, should be at the top of the stratigraphic column. Otherwise, the uppermost unit should be at the top of the stratigraphic column.
7.  **Attachment C – Site Geology.** A narrative description of the site specific geology including any features identified in the Geologic Assessment Table, a discussion of the potential for fluid movement to the Edwards Aquifer, stratigraphy, structure(s), and karst characteristics is attached.
8.  **Attachment D – Site Geologic Map(s).** The Site Geologic Map must be the same scale as the applicant's Site Plan. The minimum scale is 1" = 400'
 

Applicant's Site Plan Scale: 1" = 400 '

Site Geologic Map Scale: 1" = 400 '

Site Soils Map Scale (if more than 1 soil type): 1" = 2000 '
9. Method of collecting positional data:
  - Global Positioning System (GPS) technology.
  - Other method(s). Please describe method of data collection: 2010 Aerial Photograph
10.  The project site and boundaries are clearly shown and labeled on the Site Geologic Map.
11.  Surface geologic units are shown and labeled on the Site Geologic Map.



12.  Geologic or manmade features were discovered on the project site during the field investigation. They are shown and labeled on the Site Geologic Map and are described in the attached Geologic Assessment Table.
- Geologic or manmade features were not discovered on the project site during the field investigation.
13.  The Recharge Zone boundary is shown and labeled, if appropriate.
14. All known wells (test holes, water, oil, unplugged, capped and/or abandoned, etc.): If applicable, the information must agree with Item No. 20 of the WPAP Application Section.
- There are 9 (#) wells present on the project site and the locations are shown and labeled. (Check all of the following that apply.)
- The wells are not in use and have been properly abandoned.
- The wells are not in use and will be properly abandoned.
- The wells are in use and comply with 16 TAC Chapter 76.
- There are no wells or test holes of any kind known to exist on the project site.

**Administrative Information**

15.  Submit one (1) original and one (1) copy of the application, plus additional copies as needed for each affected incorporated city, groundwater conservation district, and county in which the project will be located. The TCEQ will distribute the additional copies to these jurisdictions. The copies must be submitted to the appropriate regional office.



## Stratigraphic Column

[Hydrogeologic subdivisions modified from Maclay and Small (1976); groups, formations, and members modified from Rose (1972); lithology modified from Dunham (1962); and porosity type modified from Choquette and Pray (1970). CU, confining unit; AQ, aquifer]

Hydrogeologic subdivision	Group, formation, or member	Hydro-logic function	Thickness (feet)	Lithology	Field identification	Cavern development	Porosity/permeability type				
Upper Cretaceous	Upper confining units	Eagle Ford Group	CU	30 – 50	Brown, flaggy shale and argillaceous limestone	Thin flagstones; petroliferous	None	Primary porosity lost/ low permeability			
		Buda Limestone	CU	40 – 50	Buff, light gray, dense mudstone	Porcelaneous limestone with calcite-filled veins	Minor surface karst	Low porosity/low permeability			
		Del Rio Clay	CU	40 – 50	Blue-green to yellow-brown clay	Fossiliferous; <i>Ilymatogyra arletina</i>	None	None/primary upper confining unit			
Lower Cretaceous	Edwards aquifer	Edwards Group	Person Formation	I	Georgetown Formation	Karst AQ; not karst CU	2 – 20	Reddish-brown, gray to light tan marly limestone	Marker fossil; <i>Waconella wacoensis</i>	None	Low porosity/low permeability
				II	Cyclic and marine members, undivided	AQ	80 – 90	Mudstone to packstone; <i>mitolid</i> grainstone; chert	Thin graded cycles; massive beds to relatively thin beds; crossbeds	Many subsurface; might be associated with earlier karst development	Laterally extensive; both fabric and not fabric/water-yielding
				III	Leached and collapsed members, undivided	AQ	70 – 90	Crystalline limestone, mudstone to grainstone; chert; collapsed breccia	Bioturbated iron-stained beds separated by massive limestone beds; stromatolitic limestone	Extensive lateral development; large rooms	Majority not fabric/one of the most permeable
				IV	Regional dense member	CU	20 – 24	Dense, argillaceous mudstone	Wispy iron-oxide stains	Very few; only vertical fracture enlargement	Not fabric/low permeability; vertical barrier
				V	Grainstone member	AQ	50 – 60	<i>Mitolid</i> grainstone; mudstone to wackestone; chert	White crossbedded grainstone	Few	Not fabric/ recrystallization reduces permeability
				VI	Kirschberg evaporite member	AQ	50 – 60	Highly altered crystalline limestone; chalky mudstone; chert	Boxwork voids, with neospar and travertine frame	Probably extensive cave development	Majority fabric/one of the most permeable
				VII	Dolomitic member	AQ	110 – 130	Mudstone to grainstone; crystalline limestone; chert	Massively bedded light gray, <i>Toucasia</i> abundant	Caves related to structure or bedding planes	Mostly not fabric; some bedding plane-fabric/water-yielding
				VIII	Basal nodular member	Karst AQ; not karst CU	50 – 60	Shaly, nodular limestone; mudstone and <i>mitolid</i> grainstone	Massive, nodular and mottled, <i>Exogyra texana</i>	Large lateral caves at surface; a few caves near Cibolo Creek	Fabric; stratigraphically controlled/large conduit flow at surface; no permeability in subsurface
				Lower confining unit	Upper member of the Glen Rose Limestone	CU; evaporite beds AQ	350 – 500	Yellowish tan, thinly bedded limestone and marl	Stair-step topography; alternating limestone and marl	Some surface cave development	Some water production at evaporite beds/relatively impermeable

**GEOLOGIC ASSESSMENT TABLE**      **PROJECT NAME:** The Veramendi Subdivision      **FGS-EI0139**

1	LOCATION		FEATURE CHARACTERISTICS										EVALUATION			PHYSICAL SETTING		
	2*	3*	2A	2B	3	4			5	5A	6	7	8A	8B	9	10	11	12
FEATURE	LATITUDE	LONGITUDE	FEATURE TYPE	POINTS	FORMATION	DIMENSIONS (FEET)			TREND (DEGREES)	DOM	DENSITY (NO/FT)	APERTURE (FEET)	INFILL	RELATIVE INFILTRATION RATE	TOTAL	SENSITIVITY	CATCHMENT AREA (ACRES)	TOPOGRAPHY
						X	Y	Z		10					< 40	> 40	< 1.6	> 1.6
S-1	29° 43.144'	98° 09.282'	CD	5	Kep	25	60	1.5	-	-	-	-	F	10	15	15	X	Hillside
S-2	29° 43.193'	98° 09.291'	CD	5	Kep	20	20	1	-	-	-	-	F	10	15	15	X	Hillside
S-3	29° 43.218'	98° 09.362'	SC	20	Kep	2	3	2	-	-	-	-	F	12	32	32	X	Hillside
S-4	29° 43.253'	98° 09.412'	MB	30	Kep	3	3	?	-	-	-	-	X	7	37	37	X	Hillside
S-5	29° 43.635'	98° 08.837'	MB	30	Kep	3	3	?	-	-	-	-	X	7	37	37	X	Drainage
S-6	29° 43.650'	98° 08.902'	MB	30	Kep	3	3	?	-	-	-	-	X	7	37	37	X	Drainage
S-7	29° 43.660'	98° 08.978'	MB	30	Kep	3	3	?	-	-	-	-	X	7	37	37	X	Drainage
S-8	29° 43.600'	98° 09.153'	MB	30	Kep	3	3	?	-	-	-	-	X	7	37	37	X	Hillside
S-9	29° 43.497'	98° 08.917'	CD	5	Kep	65	200	6+	-	-	-	-	F	10	15	15	X	Hillside
S-10	29° 43.610'	98° 08.893'	CD	5	Kep	4	4	2	-	-	-	-	F	10	15	15	X	Hillside
S-11	29° 43.545'	98° 09.052'	MB	30	Kep	3	3	?	-	-	-	-	X	7	37	37	X	Hillside
S-12	29° 43.298'	98° 09.381'	SC	20	Kep	2	2.5	1.5	-	-	-	-	O/F	12	32	32	X	Hillside
S-13	29° 43.539'	98° 09.168'	SC	20	Kep	0.25	1	1.5	-	-	-	-	O/F	10	30	30	X	Hillside
S-14	29° 43.500'	98° 09.079'	CD	5	Kep	4	4	2	-	-	-	-	X	10	15	15	X	Hillside
S-15	29° 43.497'	98° 09.096'	MB	30	Kep	3	3	?	-	-	-	-	X	7	37	37	X	Hillside
S-16	29° 43.464'	98° 09.138'	MB	30	Kep	3	3	?	-	-	-	-	X	7	37	37	X	Hillside
S-17	29° 43.440'	98° 09.174'	MB	30	Kep	3	3	?	-	-	-	-	X	7	37	37	X	Hillside
S-18	29° 43.424'	98° 09.245'	MB	30	Kep	3	3	?	-	-	-	-	X	7	37	37	X	Hillside
S-19	29° 43.371'	98° 09.270'	MB	30	Kep	3	3	?	-	-	-	-	X	7	37	37	X	Hillside
S-20	29° 43.339'	98° 09.324'	MB	30	Kep	3	3	?	-	-	-	-	X	7	37	37	X	Hillside
S-21	29° 43.298'	98° 09.381'	MB	30	Kep	3	3	?	-	-	-	-	X	7	37	37	X	Hillside
S-22	29° 43.708'	98° 09.881'	CD	5	Kep	40	50	1.5	-	-	-	-	C/F	10	15	15	X	Hillside
S-23	29° 43.750'	98° 09.884'	SC	20	Kep	1.5	2	2	-	-	-	-	O/F	12	32	32	X	Hillside
S-24	29° 44.199'	98° 09.510'	MB	30	Kep	3	3	?	-	-	-	-	X	7	37	37	X	Floodplain
S-25	29° 44.247'	98° 09.560'	MB	30	Kep	3	3	?	-	-	-	-	X	7	37	37	X	Floodplain

\* DATUM      1927 North American Datum (NAD27)      Date      May 9, 2017      Sheet      1      of      7



**GEOLOGIC ASSESSMENT TABLE**      **PROJECT NAME:** The Veramendi Subdivision      **FGS-EI0139**

LOCATION		FEATURE CHARACTERISTICS										EVALUATION			PHYSICAL SETTING			
1	2*	3*	2A	2B	3	4			5	5A	6	7	8A	8B	9	10	11	12
FEATURE	LATITUDE	LONGITUDE	FEATURE TYPE	POINTS	FORMATION	DIMENSIONS (FEET)			TREND (DEGREES)	DOM	DENSITY (NO/FT)	APERTURE (FEET)	INFILL	RELATIVE INFILTRATION RATE	TOTAL	SENSITIVITY	CATCHMENT AREA (ACRES)	TOPOGRAPHY
						X	Y	Z		10					< 40	≥ 40	<1.6	≥1.6
S-26	29° 44.148'	98° 09.382'	MB	30	Kep	3	3	?	-	-	-	-	X	7	37	37	X	Floodplain
S-27	29° 43.909'	98° 09.970'	SC	20	Kep	0.5	1	3	-	-	-	-	O/F	12	32	32	X	Hillside
S-28	29° 44.178'	98° 09.317'	MB	30	Kep	0.3	3	?	-	-	-	-	X	7	37	37	X	Floodplain
S-29	29° 44.163'	98° 09.493'	MB	30	Kep	0.75	0.75	?	-	-	-	-	N	35	65	65	X	Hillside
S-30	29° 44.160'	98° 09.483'	CD	5	Kep	55	55	4	-	-	-	-	O/F	10	15	15	X	Hillside
S-31	29° 43.939'	98° 10.082'	SC	20	Kep	2	3	3.5	-	-	-	-	O/F	12	32	32	X	Hillside
S-32	29° 44.000'	98° 10.049'	MB	30	Kep	3	3	?	-	-	-	-	X	7	37	37	X	Hillside
S-33	29° 44.056'	98° 09.963'	MB	30	Kep	3	3	?	-	-	-	-	X	7	37	37	X	Hillside
S-34	29° 44.107'	98° 09.888'	MB	30	Kep	3	3	?	-	-	-	-	X	7	37	37	X	Hillside
S-35	29° 44.147'	98° 09.825'	MB	30	Kep	3	3	?	-	-	-	-	X	7	37	37	X	Hillside
S-36	29° 44.184'	98° 09.671'	MB	30	Kep	3	3	?	-	-	-	-	X	7	37	37	X	Floodplain
S-37	29° 44.118'	98° 09.782'	MB	30	Kep	3	3	?	-	-	-	-	X	7	37	37	X	Floodplain
S-38	29° 44.222'	98° 09.450'	SCZ	30	Kep	500	800	-	-	-	-	-	N/C	20	50	50	X	Floodplain
S-39	29° 44.121'	98° 09.285'	MB	30	Kep	150	225	-	-	-	-	-	N	4	34	34	X	Hillside
S-40	29° 43.882'	98° 09.046'	MB	30	Kep	0.75	0.75	?	-	-	-	-	N	35	65	65	X	Hilltop
S-41	29° 43.857'	98° 08.925'	MB	30	Kep	0.75	0.75	?	-	-	-	-	N	35	65	65	X	Hillside
S-42	29° 43.845'	98° 08.907'	CD	5	Kep	100	140	5	-	-	-	-	F	10	15	15	X	Hillside
S-43	29° 43.657'	98° 08.735'	MB	30	Kep	3	3	?	-	-	-	-	X	7	37	37	X	Hillside
S-44	29° 43.656'	98° 08.736'	SC	20	Kep	1	1	2	-	-	-	-	O/F	12	32	32	X	Hillside
S-45	29° 43.680'	98° 08.719'	MB	30	Kep	30	75	-	-	-	-	-	C	7	37	37	X	Hillside
S-46	29° 43.693'	98° 08.7138'	MB	30	Kep	20	20	-	-	-	-	-	F	7	37	37	X	Hillside
S-47	29° 43.692'	98° 08.737'	MB	30	Kep	3	3	?	-	-	-	-	X	7	37	37	X	Hillside
S-48	29° 43.718'	98° 08.743'	MB	30	Kep	3	3	?	-	-	-	-	X	7	37	37	X	Drainage
S-49	29° 43.766'	98° 08.678'	O <sub>PR</sub>	5	Kep	10	20	-	N 40°	10	1 / 2	0.08	C/F	20	35	35	X	Drainage
S-50	29° 43.770'	98° 08.672'	MB	30	Kep	3	3	?	-	-	-	-	X	7	37	37	X	Drainage

\* DATUM 1927 North American Datum (NAD27)      Date May 9, 2017      Sheet 2 of 7



FEATURE	LOCATION			FEATURE CHARACTERISTICS											EVALUATION			PHYSICAL SETTING	
	2*	3*	2A	2B	3	4			5	5A	6	7	8A	8B	9	10	11	12	
	LATITUDE	LONGITUDE	FEATURE TYPE	POINTS	FORMATION	DIMENSIONS (FEET)			TREND (DEGREES)	DOM	DENSITY (NO/FT)	APERTURE (FEET)	INFILL	RELATIVE INFILTRATION RATE	TOTAL	SENSITIVITY	CATCHMENT AREA (ACRES)	TOPOGRAPHY	
S-51	29° 43.771'	98° 08.654'	MB	30	Kep	3	20	3	-	-	-	-	C	25	55	<1.6	X	Drainage	
S-52	29° 43.773'	98° 08.625'	O <sup>FR</sup>	5	Kep	10	15	-	N 115°	-	1 / 1.5	0.08	C/F	25	30	>1.6	X	Drainage	
S-53	29° 43.775'	98° 08.617'	MB	30	Kep	3	3	7	-	-	-	-	X	7	37	>1.6	X	Drainage	
S-54	29° 43.818'	98° 08.588'	SCZ	30	Kep	10	100	-	-	-	-	-	O/F	7	37	>1.6	X	Hillside	
S-55	29° 43.883'	98° 08.597'	MB	30	Kep	3	3	7	-	-	-	-	X	7	37	>1.6	X	Drainage	
S-56	29° 43.937'	98° 08.605'	MB	30	Kep	3	3	7	-	-	-	-	X	7	37	>1.6	X	Drainage	
S-57	29° 43.925'	98° 08.452'	CD	5	Kep	10	15	1.5	-	-	-	-	F	10	15	>1.6	X	Hillside	
S-58	29° 43.939'	98° 08.372'	CD	5	Kep	30	40	2	-	-	-	-	F	10	15	>1.6	X	Hillside	
S-59	29° 43.975'	98° 08.580'	MB	30	Kep	3	3	7	-	-	-	-	X	7	37	>1.6	X	Drainage	
S-60	29° 44.029'	98° 08.493'	MB	30	Kep	3	3	7	-	-	-	-	X	7	37	>1.6	X	Streambed	
S-61	29° 44.044'	98° 08.428'	MB	30	Kep	3	3	7	-	-	-	-	X	7	37	>1.6	X	Streambed	
S-62	29° 44.005'	98° 08.297'	MB	30	Kep	3	3	7	-	-	-	-	X	7	37	>1.6	X	Streambed	
S-63	29° 44.012'	98° 08.195'	MB	30	Kep	3	3	7	-	-	-	-	X	7	37	>1.6	X	Streambed	
S-64	29° 43.956'	98° 08.983'	C	30	Kep	2	3	5+	-	-	-	-	N	30	60	>1.6	X	Hillside	
S-65	29° 43.958'	98° 08.095'	MB	30	Kep	3	3	7	-	-	-	-	X	7	37	>1.6	X	Floodplain	
S-66	29° 43.897'	98° 08.002'	MB	30	Kep	3	3	7	-	-	-	-	X	7	37	>1.6	X	Floodplain	
S-67	29° 43.882'	98° 07.978'	MB	30	Kep	3	3	7	-	-	-	-	X	7	37	>1.6	X	Floodplain	
S-68	29° 43.818'	98° 07.985'	MB	30	Kep	3	3	7	-	-	-	-	X	7	37	>1.6	X	Streambed	
S-69	29° 43.768'	98° 07.996'	SC	20	Kep	10+	20	0.75	-	-	-	-	N	9	29	>1.6	X	Streambed	
S-70	29° 43.775'	98° 07.961'	O <sup>VR</sup>	5	Kep	3	15	2	-	-	3 / 1	0.06	N	9	14	>1.6	X	Floodplain	
S-71	29° 43.758'	98° 07.937'	MB	30	Kep	3	3	7	-	-	-	-	X	7	37	>1.6	X	Floodplain	
S-72	29° 43.782'	98° 07.870'	MB	30	Kep	3	3	7	-	-	-	-	X	7	37	>1.6	X	Streambed	
S-73	29° 43.755'	98° 07.905'	SC	20	Kep	1	1.5	6+	-	-	-	-	N	9	29	>1.6	X	Streambed	
S-74	29° 43.782'	98° 07.855'	SCZ	30	Kep	30	600	-	-	-	-	-	N/O/F	9	39	>1.6	X	Cliff	
S-75	29° 43.830'	98° 07.785'	MB	30	Kep	3	3	7	-	-	-	-	X	7	37	>1.6	X	Floodplain	

\* DATUM 1927 North American Datum (NAD27) Date May 9, 2017 Sheet 3 of 7



**GEOLOGIC ASSESSMENT TABLE**      **PROJECT NAME:** The Veramendi Subdivision      **FGS-EI0139**

1	LOCATION			FEATURE CHARACTERISTICS										EVALUATION			PHYSICAL SETTING	
	2*	3*	2A	2B	3	4			5	5A	6	7	8A	8B	9	10	11	12
	LATITUDE	LONGITUDE	FEATURE TYPE	POINTS	FORMATION	DIMENSIONS (FEET)			TREND (DEGREES)	DOM	DENSITY (NO/FT)	APERTURE (FEET)	INFILL	RELATIVE INFILTRATION RATE	TOTAL	SENSITIVITY	CATCHMENT AREA (ACRES)	TOPOGRAPHY
S-76	29° 43.882'	98° 07.978'	MB	30	Kep	3	3	?	-	-	-	-	X	7	37	37	<1.6	Streambed
S-77	29° 43.748'	98° 08.053'	CZ/SHZ	30	Kep	100	100	-	-	-	-	-	O/F	35	65	65	X	Hilltop
S-78	29° 43.876'	98° 08.041'	MB	30	Kep	0.75	0.75	?	-	-	-	-	N	35	65	65	X	Hillside
S-79	29° 43.868'	98° 08.030'	CD	5	Kep	100	100	4	-	-	-	-	F	10	15	15	X	Hillside
S-80	29° 44.001'	98° 07.965'	MB	30	Kep	3	3	?	-	-	-	-	X	7	37	37	X	Floodplain
S-81	29° 44.079'	98° 07.992'	MB	30	Kep	3	3	?	-	-	-	-	X	7	37	37	X	Floodplain
S-82	29° 44.158'	98° 08.022'	MB	30	Kep	3	3	?	-	-	-	-	X	7	37	37	X	Floodplain
S-83	29° 44.232'	98° 08.069'	MB	30	Kep	3	3	?	-	-	-	-	X	7	37	37	X	Floodplain
S-84	29° 44.305'	98° 08.113'	MB	30	Kep	3	3	?	-	-	-	-	X	7	37	37	X	Floodplain
S-85	29° 44.385'	98° 08.165'	MB	30	Kep	3	3	?	-	-	-	-	X	7	37	37	X	Streambed
S-86	29° 44.434'	98° 08.303'	MB	30	Kep	3	3	?	-	-	-	-	X	7	37	37	X	Floodplain
S-87	29° 43.614'	98° 08.322'	CD	5	Kep	5	8	1	-	-	-	-	F	10	15	15	X	Hillside
S-88	29° 43.943'	98° 08.271'	SC	20	Kep	2	2.5	1	-	-	-	-	F	12	32	32	X	Hillside
S-89	29° 43.964'	98° 08.235'	SCZ	20	Kep	30	120	-	-	-	-	-	N/O	10	30	30	X	Hillside
S-90	29° 44.160'	98° 08.185'	CD	5	Kep	4	6	1	-	-	-	-	F	10	15	15	X	Hillside
S-91	29° 44.009'	98° 08.301'	O <sup>FR</sup>	5	Kep	12	150	-	N 140°	-	1/2	0.08	C/F	25	30	30	X	Floodplain
S-92	29° 44.060'	98° 08.378'	SH	20	Kep	30	60	3	-	-	-	-	F	19	39	39	X	Hillside
S-93	29° 44.217'	98° 07.989'	CD	5	Kep	2	2.5	0.5	-	-	-	-	F	10	15	15	X	Hillside
S-94	29° 44.051'	98° 07.985'	CD	5	Kep	50	150	5	-	-	-	-	N/F	10	15	15	X	Floodplain
S-95	29° 44.456'	98° 08.434'	MB	30	Kep	3	3	?	-	-	-	-	X	7	37	37	X	Floodplain
S-96	29° 44.476'	98° 08.563'	MB	30	Kep	3	3	?	-	-	-	-	X	7	37	37	X	Floodplain
S-97	29° 44.538'	98° 08.649'	MB	30	Kep	3	3	?	-	-	-	-	X	7	37	37	X	Floodplain
S-98	29° 44.540'	98° 08.710'	MB	30	Kep	3	3	?	-	-	-	-	X	7	37	37	X	Streambed
S-99	29° 44.506'	98° 08.731'	MB	30	Kep	3	3	?	-	-	-	-	X	7	37	37	X	Streambed
S-100	29° 44.416'	98° 08.732'	MB	30	Kep	3	3	?	-	-	-	-	X	7	37	37	X	Streambed

\* DATUM 1927 North American Datum (NAD27)      Date May 9, 2017      Sheet 4 of 7



**GEOLOGIC ASSESSMENT TABLE**      **PROJECT NAME:** The Veramendi Subdivision      **FGS-EI0139**

1	LOCATION			FEATURE CHARACTERISTICS										EVALUATION			PHYSICAL SETTING	
	2*	3*	2A	2B	3	4			5	5A	6	7	8A	8B	TOTAL	SENSITIVITY	CATCHMENT AREA (ACRES)	TOPOGRAPHY
	LATITUDE	LONGITUDE	FEATURE TYPE	POINTS	FORMATION	DIMENSIONS (FEET)			TREND (DEGREES)	DOM	DENSITY (NO/FT)	APERTURE (FEET)	INFILL	RELATIVE INFILTRATION RATE				
FEATURE						X	Y	Z		10					< 40	> 40	< 1.6	> 1.6
S-101	29° 44.416'	98° 08.732'	MB	30	Kep	3	3	?	-	-	-	-	-	7	37	37	X	Sireambed
S-102	29° 44.230'	98° 08.773'	MB	30	Kep	3	3	?	-	-	-	-	-	7	37	37	X	Sireambed
S-103	29° 44.188'	98° 08.802'	MB	30	Kep	3	3	?	-	-	-	-	-	7	37	37	X	Sireambed
S-104	29° 44.167'	98° 08.857'	MB	30	Kep	3	3	?	-	-	-	-	-	7	37	37	X	Sireambed
S-105	29° 44.162'	98° 08.946'	MB	30	Kep	3	3	?	-	-	-	-	-	7	37	37	X	Sireambed
S-106	29° 44.156'	98° 09.033'	MB	30	Kep	3	3	?	-	-	-	-	-	7	37	37	X	Sireambed
S-107	29° 44.152'	98° 09.118'	MB	30	Kep	3	3	?	-	-	-	-	-	7	37	37	X	Sireambed
S-108	29° 44.185'	98° 09.217'	MB	30	Kep	3	3	?	-	-	-	-	-	7	37	37	X	Sireambed
S-109	29° 44.449'	98° 09.285'	SH	20	Kep	5	10	1	-	-	-	-	-	12	32	32	X	Hillside
S-110	29° 44.393'	98° 09.229'	O <sup>FR</sup>	5	Kep	20	40	-	N 45°	10	1 / 1	0.08	N/C	25	40	40	X	Sireambed
S-111	29° 44.391'	98° 09.183'	O <sup>FR</sup>	5	Kep	20	150	-	N 40°	10	1 / 1	0.08	N/C	25	40	40	X	Sireambed
S-112	29° 44.388'	98° 09.129'	O <sup>FR</sup>	5	Kep	4	300	-	-	-	3 / 1	0.06	N/C	20	25	25	X	Floodplain
S-113	29° 44.425'	98° 09.202'	SC	20	Kep	0.75	1	2.5	-	-	-	-	O/F	15	35	35	X	Hillside
S-114	29° 44.409'	98° 08.986'	SH	20	Kep	10	12	1	-	-	-	-	F	12	32	32	X	Hillside
S-115	29° 44.570'	98° 09.098'	MB	30	Kep	0.75	0.75	?	-	-	-	-	N	35	65	65	X	Hillside
S-116	29° 44.270'	98° 09.232'	SC <sup>H</sup>	20	Kep	1	1	3	-	-	-	-	F	12	32	32	X	Hillside
S-117	29° 44.351'	98° 09.339'	MB	30	Kep	30	50	6	-	-	-	-	N	15	45	45	X	Sireambed
S-118	29° 44.265'	98° 09.030'	CDZ	5	Kep	300	1000	-	-	-	-	-	F	10	15	15	X	Floodplain
S-119	29° 44.168'	98° 09.619'	MB	30	Kep	3	75	3	-	-	-	-	C	15	45	45	X	Sireambed
S-120	29° 44.242'	98° 08.913'	O <sup>FR</sup>	5	Kep	40	350	-	N 50°	10	1 / 2	0.08	C	25	40	40	X	Sireambed
S-121	29° 44.629'	98° 09.090'	SC	20	Kep	2	2	1.5	-	-	-	-	F	12	32	32	X	Hillside
S-122	29° 44.743'	98° 08.887'	CD	5	Kep	30	70	4	-	-	-	-	F	10	15	15	X	Drainage
S-123	29° 44.660'	98° 08.712'	O <sup>FR</sup>	5	Kep	50	150	-	N 70°	-	1 / 2	0.08	F	20	25	25	X	Sireambed
S-124	29° 44.675'	98° 08.695'	CD	5	Kep	80	170	8	-	-	-	-	F	10	15	15	X	Hillside
S-125	29° 44.127'	98° 09.046'	SC	20	Kep	2	3	1	-	-	-	-	F	12	32	32	X	Floodplain

\* DATUM      1927 North American Datum (NAD27)      Date      May 9, 2017      Sheet      5      of      7



**GEOLOGIC ASSESSMENT TABLE**      **PROJECT NAME:** The Veramendi Subdivision      **FGS-EI0139**

1	LOCATION			FEATURE CHARACTERISTICS							EVALUATION			PHYSICAL SETTING				
	2*	3*	2A	2B	3	4		5	5A	6	7	8A	8B	9	10	11	12	
	LATITUDE	LONGITUDE	FEATURE TYPE	POINTS	FORMATION	DIMENSIONS (FEET)		TREND (DEGREES)	DOM	DENSITY (NO/FT)	APERTURE (FEET)	INFILL	RELATIVE INFILTRATION RATE	TOTAL	SENSITIVITY	CATCHMENT AREA (ACRES)	TOPOGRAPHY	
S-126	29° 44.557'	98° 08.645'	SCZ	20	Kep	30	600	-	-	-	-	C/N	15	35	35	<1.6	X	Floodplain
S-127	29° 44.821'	98° 08.588'	MB	30	Kep	0.75	0.75	?	-	-	-	N	35	65	65	X	X	Hilltop
S-128	29° 44.670'	98° 08.013'	CD	5	Kep	60	65	4	-	-	-	F	10	15	15		X	Hillside
S-129	29° 44.659'	98° 07.996'	MB	30	Kep	0.75	0.75	?	-	-	-	N	35	65	65	X		Hilltop
S-130	29° 44.656'	98° 07.991'	MB	30	Kep	0.75	0.75	?	-	-	-	N	35	65	65	X		Hilltop
S-131	29° 44.338'	98° 07.805'	CD	5	Kep	70	90	3	-	-	-	F	10	15	15		X	Hillside
S-132	29° 44.382'	98° 07.502'	CD	5	Kep	20	70	3	-	-	-	F	10	15	15		X	Hillside
S-133	29° 45.186'	98° 08.255'	O <sup>PR</sup>	5	Kep	40	100	-	N 65°	-	1 / 2	N	20	25	25		X	Drainage
S-134	29° 44.881'	98° 07.761'	O <sup>PR</sup>	5	Kep	30	100	-	N 40°	10	1 / 2	N	20	35	35		X	Drainage
S-135	29° 44.916'	98° 07.704'	O <sup>PR</sup>	5	Kep	40	60	-	N 140°	-	1 / 2	N	20	25	25		X	Drainage
S-136	29° 44.560'	98° 07.125'	O <sup>PR</sup>	5	Kep	15	20	-	N 7°	-	1 / 2	N	20	25	25		X	Drainage
S-137	29° 44.336'	98° 07.793'	MB	30	Kep	0.75	0.75	?	-	-	-	N	35	65	65	X		Hillside

\* DATUM 1927 North American Datum (NAD27)

2A TYPE	TYPE	2B POINTS
C	Cave	30
SC	Solution Cavity	20
SF	Solution-enlarged fracture(s)	20
F	Fault	20
O	Other natural bedrock features	5
MB	Manmade feature in bedrock	30
SW	Swallow Hole	30
SH	Sinkhole	20
CD	Non-karst closed depression	5
Z	Zone, clustered or aligned features	30

N	8A INFILLING
N	None, exposed bedrock
C	Coarse - cobbles, breakdown, sand, gravel
O	Loose or soft mud or soil, organics, leaves, sticks, dark colors
F	Fines, compacted clay-rich sediment, soil profile, gray or red colors
V	Vegetation. Give details in narrative description
FS	Flowstone, cements, cave deposits
X	Other materials

12 TOPOGRAPHY  
Cliff, Hilltop, Hillside, Drainage, Floodplain, Streambed

I have read, I understood and I have followed the Texas Commission on Environmental Quality's Instructions to Geologists. The information presented here complies with that document and is a true representation of the conditions observed in the field. My signature certifies that I am qualified as a geologist as defined by 30 TAC 213.

Signature *Steve M. Frost*

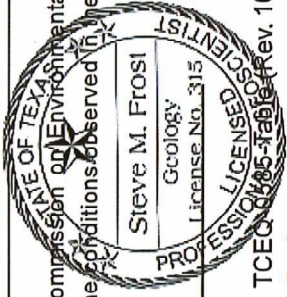

Date May 9, 2017 Sheet 6 of 7

**Frost Geosciences**

Geotechnical • Construction Materials • Forensics • Environmental



**GEOLOGIC ASSESSMENT TABLE** PROJECT NAME: The Veramendi Subdivision FGS-E10139

LOCATION		FEATURE CHARACTERISTICS										EVALUATION			PHYSICAL SETTING			
1	2*	3*	2A	2B	3	4			5	5A	6	7	8A	8B	9	10	11	12
FEATURE	LATITUDE	LONGITUDE	FEATURE TYPE	POINTS	FORMATION	DIMENSIONS (FEET)			TREND (DEGREES)	DOM	DENSITY (NO/FT)	APERTURE (FEET)	INFILL	RELATIVE INFILTRATION RATE	TOTAL	SENSITIVITY	CATCHMENT AREA (ACRES)	TOPOGRAPHY
						X	Y	Z								< 40	< 1.6	
S-138	29° 44.382'	98° 07.687'	SH	20	Kep	30	40	2	-	-	-	-	F	15	35	35	X	Hillside
S-139	29° 44.661'	98° 07.779'	O <sup>FR</sup>	5	Kep	B	10	-	N 70°	-	1 / 2	0.08	C/F	15	20	20	X	Hillside
S-140	29° 45.001'	98° 08.094'	SC	20	Kep	2	4	2	-	-	-	-	O/F	12	32	32	X	Hillside
S-141	29° 45.176'	98° 08.164'	SC	20	Kep	0.25	2.5	2	-	-	-	-	O/F	12	32	32	X	Hillside
S-142	29° 43.319'	98° 09.171'	SH	20	Kep	100	150	4	-	-	-	-	F	15	35	35	X	Hillside
S-143	29° 44.022'	98° 07.369'	SCZ	20	Kep	30	2.800	-	-	-	-	-	N/O	12	32	32	X	Cliff
S-144	29° 45.163'	98° 08.014'	SCZ	20	Kep	30	3.600	-	-	-	-	-	N/O	12	32	32	X	Cliff
S-145	29° 44.287'	98° 09.495'	CDZ	30	Kep	600	1,000	-	-	-	-	-	O/F	30	60	60	X	Streambed
S-146	29° 44.969'	98° 08.534'	F	20	Kep	-	-	-	N 55°	-	-	-	-	15	35	35	X	Hillside
S-147	29° 45.017'	98° 08.031'	F	20	Kep	-	-	-	N 45°	-	-	-	-	15	35	35	X	Hillside
S-148	29° 43.175'	98° 09.430'	MB	30	Kep	3	3	?	-	-	-	-	X	7	37	37	X	Hillside

\* DATUM 1927 North American Datum (NAD27)

2A TYPE	TYPE	2B POINTS
C	Cave	30
SC	Solution Cavity	20
SF	Solution-enlarged fracture(s)	20
F	Fault	20
O	Other natural bedrock features	5
MB	Manmade feature in bedrock	30
SW	Swallow Hole	30
SH	Sinkhole	20
CD	Non-karst closed depression	5
Z	Zone, clustered or aligned features	30

N	8A INFILLING
N	None, exposed bedrock
C	Coarse - cobbles, breakdown, sand, gravel
O	Loose or soft mud or soil, organics, leaves, sticks, dark colors
F	Fines, compacted clay-rich sediment, soil profile, gray or red colors
V	Vegetation. Give details in narrative description
FS	Flowstone, cements, cave deposits
X	Other materials

Cliff, Hilltop, Hillside, Drainage, Floodplain, Streambed	12 TOPOGRAPHY

I have read, I understand and I have followed the Texas Commission on Environmental Quality's Instructions to Geologists. The information presented here complies with that document and is a true representation of the conditions observed in the field. My signature certifies that I am qualified as a geologist as defined by 30 TAC 213.

*Steve M. Prosi*

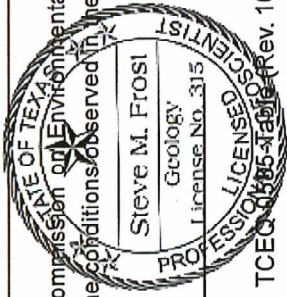

Signature Steve M. Prosi Date May 9, 2017 Sheet 7 of 7



## LOCATION

The project site consists of approximately 2,400 acres of land located along and north of Loop 337 and east and west of River Road in New Braunfels, Texas. An overall view of the area is shown on copies of the site plan, a street map, the USGS Topographic Map, the Edwards Aquifer Recharge Zone Map, the Flood Insurance Rate Map (FIRM), a 1973 aerial photograph from the USDA at a scale of 1"=2000', a geologic map, a 2010 aerial photograph at a scale of 1"=2000', and a 2010 aerial photograph at a scale of 1"=500M, Plates 1 through 9 in Appendix A.

## METHODOLOGY

The Geologic Assessment was performed by Mr. Steve Frost, C.P.G., President and Senior Geologist with Frost GeoSciences, Inc and several employees of Frost GeoSciences, Inc. including Ms. TG Bey, Biologist, Mr. Reza Eshmaly, Geologist, James Akers, and Spencer Templen. Mr. Frost is a Licensed Professional Geoscientist in the State of Texas (License # 315) and is a Certified Professional Geologist with the American Institute of Professional Geologist (Certification # 10176).

Frost GeoSciences, Inc. researched the geology of the area in the immediate vicinity of the project site. The research included, but was not limited to, the Geologic Atlas of Texas, San Antonio Sheet, FIRM maps, Edwards Aquifer Recharge Zone Maps, USGS 7.5 Minute Quadrangle Maps, the Geologic Map of the New Braunfels, Texas 30 X 60 Minute Quadrangle, the USGS Water-Resources Investigations Report 94-4117, and the USDA Soil Survey of Comal & Hays County, Texas.

After reviewing the available information, a field investigation was performed to identify any geologic or man-made potential recharge features. A transect spacing of approximately 50 feet or less, depending on vegetation thickness, was used to inspect the project site. A 2010 aerial photograph, in conjunction with a hand held Garmin eTrex Summit Global Positioning System with an Estimated Potential Error ranging from 7 to 12 feet, was used to navigate around the property and identify the locations of potential recharge features, as recommended in the "Instructions to Geologists", TCEQ-0585-Instructions (Rev. 10-1-04). The locations of any potential

May 9, 2017

The Veramendi Subdivision  
Page 12

recharge features noted in the field were identified on the Site Geologic Map in Appendix C of this report. A copy of a 2010 aerial photograph at an approximate scale of 1"=500M, indicating the locations of the potential recharge features, is included on Plate 9 in Appendix A. The Geologic Assessment Form (Rev. 2-11-15), Stratigraphic Column, and the Geologic Assessment Table have been filled with the appropriate information for this project site and are included on pages 1-11 of this report.

## **RESEARCH & OBSERVATIONS**

### **7.5 Minute Quadrangle Map Review**

According to the USGS 7.5 Minute Quadrangle Maps, New Braunfels West, Texas Sheet (1988), New Braunfels East, Texas Sheet (1994), Sattler, Texas Sheet (1994), and Hunter, Texas Sheet (1994), the elevation of the project site ranges from 630 feet at the eastern corner of the project site within the River Pasture along the Guadalupe River to 845 feet along the western property lines of Pastures 1 and 3. These elevations are calculated above mean sea level (AMSL). A landing strip and a stock pond are noted within Pasture 1. A residential structure and several associated barns and sheds are visible near the northern limits of Pasture 1. Two stock ponds were noted within Pasture 2. One stock pond and a spillway for a flood control dam was noted within Pasture 3. The surface runoff from the project site flows into unnamed tributaries of Blieders Creek, Blieders Creek, unnamed tributaries of the Guadalupe River, and the Guadalupe River. State Highway 46 (Loop 337) is located immediately south of the project site. River Road separates Pastures 2 and 4 to the west from the River Pasture to the east. A copy of the above referenced USGS 7.5 Minute Quadrangle Map, indicating the location of the project site, is included in this report on Plate 3 in Appendix A.

### **Recharge / Transition Zone**

According to Official Edwards Aquifer Recharge Zone Map, New Braunfels West, Texas Sheet, New Braunfels East, Texas Sheet, Sattler, Texas Sheet, and Hunter, Texas Sheet, (1996),

*May 9, 2017*

*The Veramendi Subdivision  
page 13*

the project site is located within the Recharge Zone of the Edwards Aquifer. A copy of the Official Edwards Aquifer Recharge Zone Map, indicating the location of the project site, is included on Plate 4 in Appendix A.

### 100-Year Floodplain

The Federal Emergency Management Agency (FEMA) Flood Insurance Rate Map for Comal County, Texas, Community Panel Numbers 48091C0270F, 48091C0290F, 48091C0435F, & 48029C0455F (Revised 9/02/09) were reviewed to determine if the project site is located in areas prone to flooding. A review of the above-mentioned panels indicate that portions of the project site is located within the 100 year floodplain. The project site is located within Zone AE, Zone A, Zone X Shaded, and Zone X.

According to the panel legend, Zone AE represents areas within the 100 year floodplain where base flood elevations have been determined. The areas of the property within Zone AE are generally located along Blieders Creek and the Guadalupe River.

Zone A represents areas within the 100 year floodplain where base flood elevations have not been determined. The areas of the property within Zone A are generally areas along tributaries immediately upgradient of areas determined to be within Zone AE.

Zone X shaded represents areas of 0.2% annual chance of flooding, areas of 1% annual chance of flooding with average depths of less than 1 foot or with drainage areas less than 1 square mile, and areas protected by levees from 1% annual chance of flooding. The areas of the property with Zone X Shaded are generally narrow bands located immediately adjacent to areas determined to be within Zone AE.

Zone X represents areas determined to be outside the 0.2% annual chance floodplain. A copy of the Comal County, Texas, FIRM maps, indicating the location of the project site, is included in this report on Plate 5 in Appendix A.



## Soils

According to the United States Department of Agriculture, Soil Conservation Service, Soil Survey of Comal & Hays County, Texas (1982), the project site is located on the Rumble-Comfort Association (RUD), the Comfort - Rock Outcrop Complex, Undulating (CrD), the Brackett - Rock Outcrop - Comfort Complex, Undulating (BtD), the Lewisville Silty Clay, 1 to 3 percent slopes (LeB), the Medlin-Eckrant Association (MEC/MED), and the Orif Soils, Frequently Flooded (Or). A copy of the 1973 aerial photograph (approximate scale: 1"=2000') from the USDA Soil Survey of Comal & Hays County, Texas (1982) indicating the location of the project site and the soil types is included on Plate 6 in Appendix A.

The Rumble-Comfort Association (RuD) consists of shallow and moderately deep soils on uplands in the Edwards Plateau Land Resource Area. The surface layer of the Rumble Soil is dark reddish brown very cherty clay loam about 10 inches thick. Rounded chert and limestone cobbles and gravel cover about 20 percent of the surface. The subsoil to a depth of 14 inches is dark reddish-brown very cherty clay, and to a depth of 28 inches it is dark reddish-brown extremely stony clay. The underlying material is indurated fractured limestone. The Comfort Soil is dark brown, neutral, extremely stony clay about 7 inches thick. The subsoil to a depth of 12 inches is dark reddish-brown, mildly alkaline, extremely stony clay. The underlying material is indurated fractured limestone. The soil is noncalcareous throughout. The soils in this association are well drained. Surface runoff is medium, but varies due to the occurrence of caves, fracture zones, and sinks. Permeability is moderately slow. Water erosion is a moderate hazard.

The Comfort-Rock Outcrop Complex consists of shallow, clayey soils and Rock Outcrop on side slopes and on hilltops and ridgetops on uplands in the Edwards Plateau Land Resource Area. The Comfort Extremely Stony Clay makes up 49 to more than 95 percent of the complex, but on the average it makes up 70 percent. Rock Outcrop and areas of soil less than 4 inches deep make up 5 to 36 percent, but the average is 15 percent. Typically, the surface layer of the Comfort soil is dark brown extremely stony clay about 6 inches thick. Cobbles and stones as much as 4 feet across cover about 45 percent of the surface. The subsoil extends to a depth of 13

inches. It is dark reddish brown extremely stony clay. The underlying material is indurated fractured limestone. The soil is mildly alkaline and noncalcareous throughout. The Comfort Soil is well drained. Surface runoff is slow to medium. Permeability is slow, and the available water capacity is very low. Water erosion is a slight hazard. This soil has a USDA Texture Classification of extremely stony clay, stony clay, very stony clay, and weathered bedrock. The Unified Classification is CH, GC, CL, or SC. The AASHO Classification is A-2-7, and A-7-6. This soil has an average permeability from 0.6 to 0.2 inches/hour.

The Brackett-Rock Outcrop-Comfort Complex consists of shallow, loamy and clayey soils and rock outcrops on uplands in the Edwards Plateau Land Resource Area. The Brackett Soil makes up 30 to 60 percent of the complex, but on the average it makes up 50 percent. Rock Outcrops make up 10 to 40 percent of the complex, but the average is 20 percent. The Comfort Soil makes up 10 to 20 percent, but the average is 15 percent. Typically, the surface layer of the Brackett Soil is grayish brown gravelly clay loam about 6 inches thick. The subsoil extends to a depth of 17 inches. It is very pale brown and pale yellow gravelly clay loam. The underlying material is weakly cemented limestone interbedded with thin layers of indurated limestone. The soil is moderately alkaline and calcareous throughout. Typically, the areas of Rock Outcrop consist of exposures of limestone bedrock. There is some soil material in the narrow fractures in the rock. In some areas, however, the rock is flat and is covered by soil material as much as 3 inches thick. Typically, the surface layer of the Comfort Soil is dark brown extremely stony clay about 4 inches thick. The subsoil extends to a depth of 11 inches. It is dark reddish brown extremely stony clay. The underlying material is indurated fractured limestone. The soil is moderately alkaline and noncalcareous throughout. The soils in this complex are well drained. Surface runoff is medium to rapid. Permeability is moderately slow in the Brackett Soil and slow in the Comfort Soil. The available water capacity is very low. Water erosion is a severe hazard.

The Lewisville Silty Clay consists of deep, gently sloping soil on stream terraces. Typically, the surface layer is dark grayish brown silty clay about 15 inches thick. The subsoil to a depth of 33 inches

May 9, 2017

The Veramendi Subdivision  
page 16



is light brown silty clay, and to a depth of 63 inches is reddish yellow silty clay. The soil is moderately alkaline and calcareous throughout. This soil is well drained, surface runoff is medium, and permeability is moderate.

The Medlin-Eckrant Association consists of very shallow to shallow and deep soils on uplands in the Edwards Plateau Land Resource Area. There are narrow limestone ledges at the top of some slopes. The Medlin and Eckrant soils each make up 20 to 80 of a mapped area. Together, on the average, they make up about 95 percent of the mapped area. A typical area is 50 percent Medlin soil and 45 percent Eckrant soil. Typically, the Medlin soil has a grayish brown surface layer about 11 inches thick that is stony clay in the upper part and clay in the lower part. The subsoil, from 11 to 50 inches, is light yellowish brown clay that has yellowish brown and olive yellow mottles. The underlying material to a depth of 80 inches is light gray shaly clay that has yellow and olive yellow mottles. The soil is moderately alkaline and calcareous throughout. The Medlin soils is well drained. Surface runoff is rapid. Permeability is very slow. Water enters rapidly when the soil is dry and cracked and very slow when it is wet. Water erosion is a severe hazard. Typically, the surface layer of the Eckrant soil is very dark gray extremely stony clay about 16 inches thick. The underlying material is fractured limestone bedrock. The soil is moderately alkaline and noncalcareous throughout. The Eckrant soil is well drained. Surface runoff is rapid. Permeability is moderately slow. Water erosion is a severe hazard.

The Orif Soils, Frequently Flooded consist of deep nearly level soils on flood plains of large creeks and rivers. These soils are adjacent to the stream channels. Typically, the surface layer is grayish brown moderately alkaline gravelly loamy sand about 20 inches thick. The underlying layer to a depth of 60 inches is very gravelly loamy sand stratified with very gravelly sand, very gravelly sandy loam, and loam. These soils are well drained. Flooding occurs several times in most years and is of very brief duration. Floodwaters are swift and destructive. Surface runoff is slow, permeability is rapid.

## Narrative Description of the Site Geology

The project site consists of approximately 2,400 acres of land located along and north of Loop 337 and east and west of River Road in New Braunfels, Texas. An overall view of the area is shown on Plates 1 through 9 in Appendix A. The project site exists as ranch land used to graze cattle and is the main ranching operation for the Word-Borchers Ranch. The project site has a very well developed soil layer on the property giving way to relatively few rock outcrops and dense stands of native grasses. Frost GeoSciences, Inc. after finding large piles of bulldozed rubble within 40 year old stands of trees, researched historic aerial photography and made note that the property appears to have undergone numerous episodes of land clearing dating back at least 40 to 50 years. These historic land clearing operations appear to have culled much of the rock rubble from the surface. The majority (80+% ) of the 2,400 acre ranch appears to have been bulldozed at some point with many areas having been cleared repeatedly. This clearing process has produced many small non karst closed depressions resulting from pulling trees out and plucking boulders. There are so many of these across the property that it is not practical to itemize them within this report. The areas that have not been cleared historically appear to be along steep slopes and cliffs, and within major drainage areas. The majority of the site appears to support a thick soil cover and as a result very few potential recharge features were encountered when compared to the size of the property.

The variations in the vegetative cover across the project site are visible in the 2010 aerial photographs on Plates 8 and 9 in Appendix A and in the site visit photographs included in Appendix B. One hundred and forty eight Potential Recharge Features (PRF's) were identified during our site inspection. Nineteen of these are considered sensitive by Frost GeoSciences, Inc. The sensitive features are highlighted on the Geologic Assessment Tables on pages 4 through 10.

### **Non-Karst Closed Depressions (CD)**

Potential Recharge Features S-1, S-2, S-10, S-14, S-22, S-57, S-58, S-87, S-90, S-93, and S-118, consist of notable non-karst closed depressions created by historic bulldozing on the property. These



features are typical of the thousands of similar features and appear to have been created by either the removal of trees or the plucking of boulders. Typically these feature are relatively small (less than 10 feet in any dimension and usually only a foot or two deep. Potential Recharge Features S-9, S-30, S-42, S-79, S-122, S-124, S-128, S-131, and S-132 are non-karst closed depressions consisting of excavated stock ponds used to water livestock, These features vary greatly in both size and shape, however, all of these features show evidence of ponding water for prolonged periods of time. PRF's S-9 and S-124 were holding water at the time of our site inspections. Potential Recharge Feature S-94 is a non-karst closed depression consisting of a stream scour adjacent to Blieders Creek. The bottoms of all of these features are lined with clay and show evidence of holding water. These 22 features are not considered sensitive by FGS. These features score a 15 on the Geologic Assessment Table.

Potential Recharge Feature S-145 consists of large non-karst closed depression created behind the Flood Control Dam within Pasture 3. This non-karst closed depression showed evidence of rapid infiltration into the subsurface after several heavy rainfall events during June and September. Due to the overall size of this feature and the rate that the feature drains into the subsurface, additional points were added for a ZONE rating. This feature is considered sensitive by FGS. This feature scores a 60 on the Geologic Assessment Table.

#### **Manmade Features in Bedrock (MB)**

Potential Recharge Features S-4 through S-8, S-11, S-15 through S-21, S-24 through S-26, S-28, S-32 through S-37, S-43, S-47, S-48, S-50, S-53, S-55, S-56, S-59 through S-63, S-65 through S-68, S-71, S-72, S-75, S-76, S-80 through S-86, S-95 through S-108, and S-148 are manmade features in bedrock consisting of sanitary sewer manholes along two sewer outfall lines. The two sewer outfall lines combine within Blieders Creek at Potential Recharge Feature S-67. These 64 features are not considered sensitive by FGS. These features score a 37 on the Geologic Assessment Table.

Potential Recharge Features S-29, S-40, S-41, S-78, S-115, S-127, S-129, S-130, and S-137



consist of existing or recently drilled water wells. PRF's S-40 and S-127 are operational and in use at this time. PRF's S-29, S-78, and S-129 are wells associated with old windmills and do not appear to be operational at this time. The remaining PRF's are recently drilled wells consisting of open holes with no casing. These appear to be associated with either testing the groundwater availability or are planned as future water supply wells for livestock. These 9 features are considered sensitive by FGS. These features score a 65 on the Geologic Assessment Table.

Potential Recharge Feature S-39 consists of an area that had been excavated down to bedrock and used as quarry materials for roads on the ranch. This feature is not considered sensitive by FGS. This feature scores a 34 on the Geologic Assessment Table.

Potential Recharge Feature S-45 consists of an area of limestone cobbles and boulders. It is believed that the cobbles and boulders were the left over spoils from the excavation of a nearby sanitary sewer lift station. This feature is not considered sensitive by FGS. This feature scores a 37 on the Geologic Assessment Table.

Potential Recharge Feature S-46 consists of an old abandoned sanitary sewer lift station. The lift station was abandoned after the remaining sewer outfall line was constructed. This feature is not considered sensitive by FGS. This feature scores a 37 on the Geologic Assessment Table.

Potential Recharge Features S-51 and S-119 consist of areas along existing sewer lines that occur within stream channels where the scour of the stream has eroded compacted material out of the sewer trench. The scour at PRF S-51 also occurs in conjunction with an area of highly weathered and altered limestone increasing the probability of rapid infiltration into the subsurface. These 2 features are considered sensitive by FGS. These features score a 45 and 55 respectively on the Geologic Assessment Table.

Potential Recharge Feature S-117 consists of a large erosion scour located at the discharge pipe for the flood control dam along Blieders Creek. This feature was inspected after heavy rains in September and did not show evidence of standing water. This feature is considered sensitive by FGS. This feature scores a 45 on the Geologic Assessment Table.

**Cave (C)**

Potential Recharge Feature S-64 consists of a relatively small cave located near a hilltop in Pasture 2. The cave opening is approximately 2 feet wide and 3 feet long and has an initial drop of approximately 5 feet. An area of stressed vegetation around the cave opening indicated that the air inside the cave may not be suitable for long term or even short term occupation so no attempt was made to investigate the interior of the cave beyond what could be seen from the surface. A deflated area approximately 30 feet wide, 50 feet long and 3 feet deep was noted around the cave entrance. This is likely the result of soil erosion into the cave. This feature is considered sensitive by FGS. This feature scores a 60 on the Geologic Assessment Table.

**Solution Cavity (SC)**

Potential Recharge Features S-3, S-12, S-13, S-23, S-27, S-31, S-44, S-69, S-73, S-74, S-88, S-113, S-116, S-121, S-125, S-140, and S-141 consist of solution cavities of various dimensions. A machete was used to probe the depth of the features and determine the nature of the infilling. These cavities all contained a hard clay plug preventing rapid infiltration of water into the subsurface. This was somewhat expected given the extensive soil development across the property. These 17 features are not considered sensitive by FGS. These features score a 29 to 35 on the Geologic Assessment Table.

Potential Recharge Feature S-38 consists of an area of dissolved and scoured limestone outcrop associated with the spillway for the flood control dam. Some of the scours and dissolved limestone extended 3 to 4 feet down and none were noted holding water, even after periods of heavy rains, indicating rapid infiltration into the subsurface. This feature is considered sensitive by FGS. This feature scores a 50 on the Geologic Assessment Table.

Potential Recharge Features S-54, S-126, S-143, and S-144 consists of zones of solution cavities within cliff faces. These represent horizontal features that trend upgradient as they extend into the bedrock cliff. FGS is of the opinion that these features represent discharge features associated with the outlets of subsurface bedding plain features. These 4 features are not considered sensitive by FGS. These features score between a 32 and 37 on the Geologic Assessment Table.



**Sinkhole (SH)**

Potential Recharge Features S-77 consists of three small closed depressions (sinkholes) likely resulting from soil deflation within a 100 X 100 foot area and two caves approximately 100 feet apart within the same area. The depressions were infilled with loose soil and leaves, rock rubble and some hard packed clay in areas. Evidence of rapid infiltration into the subsurface was noted in some areas. These features are considered sensitive by FGS. These features score a 65 on the Geologic Assessment Table.

Potential Recharge Features S-92, S-109, S-114, S-138, and S-142 consists of areas believed to be the result of soil deflation into the subsurface creating karst formed closed depressions or sinkholes. For these purposes, it is not believed by FGS that these are sinkholes in the classic sense that a collapse has occurred creating a depression. Rather, FGS believes these features are purely the result of erosion of surface soils into subsurface features. These features all contained small areas in the bottoms with no grasses indicating that water ponds for prolonged periods of time. As a result, it did not appear that these features provide rapid infiltration into the subsurface. These 5 features are not considered sensitive by FGS. These features score a 32 to 39 on the Geologic Assessment Table.

**Fault (F)**

Potential Recharge Features S-146 and S-147 consist of faults noted on the Bureau of Economic Geology, Geologic Map of the New Braunfels, Texas 30 X 60 Minute Quadrangle (2000). Evidence of PRF S-146 was somewhat confirmed in the field with fractures noted at PRF S-133, however, the bearings of the fractures were not the same as the strike of the proposed fault. No fractures or other field evidence associated with PRF S-147 were noted in the field at the time of the on-site inspection. These 2 features are not considered sensitive by FGS. These features score a 35 on the Geologic Assessment Table.

**Other Natural Bedrock Feature (O)**

Potential Recharge Features S-49, S-52, S-70, S-91, S-112, S-123, S-133, S-134, S-135, S-136, and S-139 consist of natural rock outcrops with either vuggy limestone (O<sup>VR</sup>) or fractured bedrock (O<sup>FR</sup>). The



sizes of these outcrops and the strike of the fractures varied greatly. These 11 features are not considered sensitive by FGS. These features score a 14 to 35 on the Geologic Assessment Table.

Potential Recharge Features S-110, S-111, and S-120 consist of natural rock outcrops with fractured bedrock ( $O^{FR}$ ). The sizes of these outcrops and the strike of the fractures varied greatly. These 3 features are considered sensitive by FGS. These features score a 40 on the Geologic Assessment Table.

According to the USGS 7.5 Minute Quadrangle Maps, New Braunfels West, Texas Sheet (1988), New Braunfels East, Texas Sheet (1994), Sattler, Texas Sheet (1994), and Hunter, Texas Sheet (1994), the elevation of the project site ranges from 630 feet at the eastern corner of the project site within the River Pasture along the Guadalupe River to 845 feet along the western property lines of Pastures 1 and 3. These elevations are calculated above mean sea level (AMSL). According to topographic data obtained from Pape Dawson Engineers, the elevations on the project site range from 625 feet at the eastern corner of the project site to 845 feet along the western property lines of Pastures 1 and 3. A copy of the site plan, indicating the boundary of the project site and the elevations, is included on Plate I in Appendix A and on the Site Geologic Map in Appendix C of this report.

According to the Bureau of Economic Geology, Geologic Map of the New Braunfels, Texas 30 X 60 Minute Quadrangle (2000), the project site is covered by the Cretaceous Edwards Person Limestone.

The Cyclic and Marine Member of the Cretaceous Edwards Person Limestone consists of mudstone to packstone and miliolid grainstone with chert. The member is characterized by massive beds of limestone to relatively thin beds of limestone with some crossbedding. The Cyclic and Marine Member forms a few caves some that are laterally extensive. Overall thickness ranges from 80 to 90 feet thick.

The Leached and Collapsed Member of the Edwards Person Limestone consists of crystalline limestone, mudstone to grainstone with chert, and collapsed breccia. This member



**ORGANIZED SEWAGE  
COLLECTION SYSTEM PLAN  
(TCEQ-0582)**



# Organized Sewage Collection System Application

## Texas Commission on Environmental Quality

For Regulated Activities on the Edwards Aquifer Recharge Zone and Relating to 30 TAC §213.5(c), Effective June 1, 1999

***To ensure that the application is administratively complete, confirm that all fields in the form are complete, verify that all requested information is provided, consistently reference the same site and contact person in all forms in the application, and ensure forms are signed by the appropriate party.***

***Note: Including all the information requested in the form and attachments contributes to more streamlined technical reviews.***

**Regulated Entity Name:** Veramendi Precinct 18 Unit 1

1.  **Attachment A – SCS Engineering Design Report.** This Engineering Design Report is provided to fulfill the requirements of 30 TAC Chapter 217, including 217.10 of Subchapter A, §§217.51 – 217.70 of Subchapter C, and Subchapter D as applicable, and is required to be submitted with this SCS Application Form.

## ***Customer Information***

2. The entity and contact person responsible for providing the required engineering certification of testing for this sewage collection system upon completion (including private service connections) and every five years thereafter to the appropriate TCEQ region office pursuant to 30 TAC §213.5(c) is:

Contact Person: Jason Theurer

Entity: New Braunfels Utilities

Mailing Address: 355 FM 306

City, State: New Braunfels, TX

Zip: 78130

Telephone: (830) 608-8830

Fax: \_\_\_\_\_

Email Address: jtheurer@nbutexas.com

***The appropriate regional office must be informed of any changes in this information within 30 days of the change.***

3. The engineer responsible for the design of this sewage collection system is:

Contact Person: Jocelyn Perez

Texas Licensed Professional Engineer's Number: 98367

Entity: Pape-Dawson Engineers

Mailing Address: 1672 Independence Dr, Ste. 102

City, State: New Braunfels, TX

Zip: 78132

Telephone: (830) 632-5633

Fax: \_\_\_\_\_

Email Address: jperez@pape-dawson.com

## Project Information

4. Anticipated type of development to be served (estimated future population to be served, plus adequate allowance for institutional and commercial flows):

- Residential: Number of single-family lots: 215
- Multi-family: Number of residential units: \_\_\_\_\_
- Commercial
- Industrial
- Off-site system (not associated with any development)
- Other: \_\_\_\_\_

5. The character and volume of wastewater is shown below:

100% Domestic 45,150 gallons/day  
 \_\_\_\_\_% Industrial \_\_\_\_\_ gallons/day  
 \_\_\_\_\_% Commingled \_\_\_\_\_ gallons/day  
 Total gallons/day: (215 LUE)x(210gpd/LUE)=45,150 gpd

6. Existing and anticipated infiltration/inflow is 750 gpd/acre gallons/day. This will be addressed by: adequate sizing of the sewer main.

7. A Water Pollution Abatement Plan (WPAP) is required for construction of any associated commercial, industrial or residential project located on the Recharge Zone.

- The WPAP application for this development was approved by letter dated \_\_\_\_\_. A copy of the approval letter is attached.
- The WPAP application for this development was submitted to the TCEQ on concurrently, but has not been approved.
- A WPAP application is required for an associated project, but it has not been submitted.
- There is no associated project requiring a WPAP application.

8. Pipe description:

**Table 1 - Pipe Description**

<i>Pipe Diameter(Inches)</i>	<i>Linear Feet (1)</i>	<i>Pipe Material (2)</i>	<i>Specifications (3)</i>
8" Gravity	9985.21	PVC SDR 26	ASTM D3034, ASTM D3212
8" Pressure Rated	1460	PVC SDR 26	ASTM D2241, ASTM D3139, ASTM C1173

**Total Linear Feet: 11,445.21**

(1) Linear feet - Include stub-outs and double service connections. Do not include private service laterals.

(2) Pipe Material - If PVC, state SDR value.

(3) Specifications - ASTM / ANSI / AWWA specification and class numbers should be included.

9. The sewage collection system will convey the wastewater to the Gruene Wastewater (name) Treatment Plant. The treatment facility is:

- Existing  
 Proposed

10. All components of this sewage collection system will comply with:

- The City of New Braunfels standard specifications.  
 Other. Specifications are attached.

11.  No force main(s) and/or lift station(s) are associated with this sewage collection system.  
 A force main(s) and/or lift station(s) is associated with this sewage collection system and the **Lift Station/Force Main System Application** form (TCEQ-0624) is included with this application.

### ***Alignment***

12.  There are no deviations from uniform grade in this sewage collection system without manholes and with open cut construction.

13.  There are no deviations from straight alignment in this sewage collection system without manholes.

**Attachment B - Justification and Calculations for Deviation in Straight Alignment without Manholes.** A justification for deviations from straight alignment in this sewage collection system without manholes with documentation from pipe manufacturer allowing pipe curvature is attached.

For curved sewer lines, all curved sewer line notes (TCEQ-0596) are included on the construction plans for the wastewater collection system.

### ***Manholes and Cleanouts***

14.  Manholes or clean-outs exist at the end of each sewer line(s). These locations are listed below: (Please attach additional sheet if necessary)

**Table 2 - Manholes and Cleanouts**

<i>Line</i>	<i>Shown on Sheet</i>	<i>Station</i>	<i>Manhole or Clean-out?</i>
See attached	Of		
	Of		
	Of		
	Of		
	Of		
	Of		



<i>Line</i>	<i>Shown on Sheet</i>	<i>Station</i>	<i>Manhole or Clean-out?</i>
	Of		
	Of		
	Of		
	Of		

15.  Manholes are installed at all Points of Curvature and Points of Termination of a sewer line.
16.  The maximum spacing between manholes on this project for each pipe diameter is no greater than:

<b>Pipe Diameter (inches)</b>	<b>Max. Manhole Spacing (feet)</b>
6 - 15	500
16 - 30	800
36 - 48	1000
≥54	2000

- Attachment C – Justification for Variance from Maximum Manhole Spacing.** The maximum spacing between manholes on this project (for each pipe diameter used) is greater than listed in the table above. A justification for any variance from the maximum spacing is attached, and must include a letter from the entity which will operate and maintain the system stating that it has the capability to maintain lines with manhole spacing greater than the allowed spacing.
17.  All manholes will be monolithic, cast-in-place concrete.
- The use of pre-cast manholes is requested for this project. The manufacturer's specifications and construction drawings, showing the method of sealing the joints, are attached.

## **Site Plan Requirements**

**Items 18 - 25 must be included on the Site Plan.**

18.  The Site Plan must have a minimum scale of 1" = 400'.  
Site Plan Scale: 1" = 400'.
19.  The Site Plan must include the sewage collection system general layout, including manholes with station numbers, and sewer pipe stub outs (if any). Site plan must be overlain by topographic contour lines, using a contour interval of not greater than ten feet and showing the area within both the five-year floodplain and the 100-year floodplain of any drainage way.
20. Lateral stub-outs:  
 The location of all lateral stub-outs are shown and labeled.

- No lateral stub-outs will be installed during the construction of this sewer collection system.

21. Location of existing and proposed water lines:

- The entire water distribution system for this project is shown and labeled.
- If not shown on the Site Plan, a Utility Plan is provided showing the entire water and sewer systems.
- There will be no water lines associated with this project.

22. 100-year floodplain:

- After construction is complete, no part of this project will be in or cross a 100-year floodplain, either naturally occurring or manmade. (Do not include streets or concrete-lined channels constructed above of sewer lines.)
- After construction is complete, all sections located within the 100-year floodplain will have water-tight manholes. These locations are listed in the table below and are shown and labeled on the Site Plan. (Do not include streets or concrete-lined channels constructed above sewer lines.)

**Table 3 - 100-Year Floodplain**

<i>Line</i>	<i>Sheet</i>	<i>Station</i>
A	5.06 of	1+00 to 1+73.50
	of	to
	of	to
	of	to

23. 5-year floodplain:

- After construction is complete, no part of this project will be in or cross a 5-year floodplain, either naturally occurring or man-made. (Do not include streets or concrete-lined channels constructed above sewer lines.)
- After construction is complete, all sections located within the 5-year floodplain will be encased in concrete or capped with concrete. These locations are listed in the table below and are shown and labeled on the Site Plan. (Do not include streets or concrete-lined channels constructed above sewer lines.)

**Table 4 - 5-Year Floodplain**

<i>Line</i>	<i>Sheet</i>	<i>Station</i>
	of	to
	of	to
	of	to
	of	to

- 24.  Legal boundaries of the site are shown.

25.  The **final plans and technical specifications** are submitted for the TCEQ's review. Each sheet of the construction plans and specifications are dated, signed, and sealed by the Texas Licensed Professional Engineer responsible for the design on each sheet.

**Items 26 - 33 must be included on the Plan and Profile sheets.**

26.  All existing or proposed water line crossings and any parallel water lines within 9 feet of sewer lines are listed in the table below. These lines must have the type of pressure rated pipe to be installed shown on the plan and profile sheets. Any request for a variance from the required pressure rated piping at crossings must include a variance approval from 30 TAC Chapter 290.

- There will be no water line crossings.  
 There will be no water lines within 9 feet of proposed sewer lines.

**Table 5 - Water Line Crossings**

<i>Line</i>	<i>Station or Closest Point</i>	<i>Crossing or Parallel</i>	<i>Horizontal Separation Distance</i>	<i>Vertical Separation Distance</i>
See attached				

27. Vented Manholes:

- No part** of this sewer line is within the 100-year floodplain and vented manholes are not required by 30 TAC Chapter 217.
- A portion** of this sewer line is within the 100-year floodplain and vented manholes will be provided at less than 1500 foot intervals. These water-tight manholes are listed in the table below and labeled on the appropriate profile sheets.
- A portion** of this sewer line is within the 100-year floodplain and an alternative means of venting shall be provided at less than 1500 feet intervals. A description of the alternative means is described on the following page.
- A portion** of this sewer line is within the 100-year floodplain; however, there is no interval longer than 1500 feet located within. No vented manholes will be used.

**Table 6 - Vented Manholes**

<i>Line</i>	<i>Manhole</i>	<i>Station</i>	<i>Sheet</i>
See Attached			



<i>Line</i>	<i>Manhole</i>	<i>Station</i>	<i>Sheet</i>

28. Drop manholes:

- There are no drop manholes associated with this project.
- Sewer lines which enter new or existing manholes or "manhole structures" higher than 24 inches above the manhole invert are listed in the table below and labeled on the appropriate profile sheets. These lines meet the requirements of 30 TAC §217.55(l)(2)(H).

**Table 7 - Drop Manholes**

<i>Line</i>	<i>Manhole</i>	<i>Station</i>	<i>Sheet</i>
N/A			

29. Sewer line stub-outs (For proposed extensions):

- The placement and markings of all sewer line stub-outs are shown and labeled.
- No sewer line stub-outs are to be installed during the construction of this sewage collection system.

30. Lateral stub-outs (For proposed private service connections):

- The placement and markings of all lateral stub-outs are shown and labeled.
- No lateral stub-outs are to be installed during the construction of this sewage collection system.

31. Minimum flow velocity (From Appendix A)

- Assuming pipes are flowing full; all slopes are designed to produce flows equal to or greater than 2.0 feet per second for this system/line.

32. Maximum flow velocity/slopes (From Appendix A)

- Assuming pipes are flowing full, all slopes are designed to produce maximum flows of less than or equal to 10 feet per second for this system/line.
- Attachment D – Calculations for Slopes for Flows Greater Than 10.0 Feet per Second.** Assuming pipes are flowing full, some slopes produce flows which are greater than 10 feet per second. These locations are listed in the table below. Calculations are attached.

**Table 8 - Flows Greater Than 10 Feet per Second**

<i>Line</i>	<i>Profile Sheet</i>	<i>Station to Station</i>	<i>FPS</i>	<i>% Slope</i>	<i>Erosion/Shock Protection</i>

33. Assuming pipes are flowing full, where flows are  $\geq 10$  feet per second, the provisions noted below have been made to protect against pipe displacement by erosion and/or shock under 30 TAC §217.53(l)(2)(B).

- Concrete encasement shown on appropriate Plan and Profile sheets for the locations listed in the table above.
- Steel-reinforced, anchored concrete baffles/retards placed every 50 feet shown on appropriate Plan and Profile sheets for the locations listed in the table above.
- N/A

**Administrative Information**

- 34.  The final plans and technical specifications are submitted for TCEQ review. Each sheet of the construction plans and specifications are dated, signed, and sealed by the Texas Licensed Professional Engineer responsible for the design on each sheet.
- 35.  Standard details are shown on the detail sheets, which are dated, signed, and sealed by the Texas Licensed Professional Engineer, as listed in the table below:

**Table 9 - Standard Details**

<i>Standard Details</i>	<i>Shown on Sheet</i>
Lateral stub-out marking <b>[Required]</b>	5.30 of
Manhole, showing inverts comply with 30 TAC §217.55(l)(2) <b>[Required]</b>	5.30 of
Alternate method of joining lateral to existing SCS line for potential future connections <b>[Required]</b>	5.30 of
Typical trench cross-sections <b>[Required]</b>	5.30 of
Bolted manholes <b>[Required]</b>	5.30 of
Sewer Service lateral standard details <b>[Required]</b>	5.30 of
Clean-out at end of line <b>[Required, if used]</b>	N/A of
Baffles or concrete encasement for shock/erosion protection <b>[Required, if flow velocity of any section of pipe &gt;10 fps]</b>	N/A of
Detail showing Wastewater Line/Water Line Crossing <b>[Required, if crossings are proposed]</b>	5.06 of
Mandrel detail or specifications showing compliance with 30 TAC §217.57(b) and (c) <b>[Required, if Flexible Pipe is used]</b>	5.30 of

<i>Standard Details</i>	<i>Shown on Sheet</i>
Drop manholes [Required, if a pipe entering a manhole is more than 24 inches above manhole invert]	N/A of

36.  All organized sewage collection system general construction notes (TCEQ-0596) are included on the construction plans for this sewage collection system.
37.  All proposed sewer lines will be sufficiently surveyed/staked to allow an assessment prior to TCEQ executive director approval. If the alignments of the proposed sewer lines are not walkable on that date, the application will be deemed incomplete and returned.
- Survey staking was completed on this date: when advised by TCEQ of site visit
38.  Submit one (1) original and one (1) copy of the application, plus additional copies as needed for each affected incorporated city, groundwater conservation district, and county in which the project will be located. The TCEQ will distribute the additional copies to these jurisdictions. The copies must be submitted to the appropriate regional office.
39.  Any modification of this SCS application will require TCEQ approval, prior to construction, and may require submission of a revised application, with appropriate fees.

## **Signature**

To the best of my knowledge, the responses to this form accurately reflect all information requested concerning the proposed regulated activities and methods to protect the Edwards Aquifer. This **Organized Sewage Collection System Application** is hereby submitted for TCEQ review and executive director approval. The system was designed in accordance with the requirements of 30 TAC §213.5(c) and 30 TAC §217 and prepared by:

Print Name of Licensed Professional Engineer: Jocelyn Perez, P.E.

Date: 12/5/23

Place engineer's seal here:



Signature of Licensed Professional Engineer:

Jocelyn Perez



## Appendix A-Flow Velocity Table

**Flow Velocity (Flowing Full)** All gravity sewer lines on the Edwards Aquifer Recharge Zone shall be designed and constructed with hydraulic slopes sufficient to give a velocity when flowing full of not less than 2.0 feet per second, and not greater than 10 feet per second. The grades shown in the following table are based on Manning's formula and an n factor of 0.013 and shall be the minimum and maximum acceptable slopes unless provisions are made otherwise.

**Table 10 - Slope Velocity**

Pipe Diameter(Inches)	% Slope required for minimum flow velocity of 2.0 fps	% Slope which produces flow velocity of 10.0 fps
6	0.50	12.35
8	0.33	8.40
10	0.25	6.23
12	0.20	4.88
15	0.15	3.62
18	0.11	2.83
21	0.09	2.30
24	0.08	1.93
27	0.06	1.65
30	0.055	1.43
33	0.05	1.26
36	0.045	1.12
39	0.04	1.01
>39	*	*

\*For lines larger than 39 inches in diameter, the slope may be determined by Manning's formula (as shown below) to maintain a minimum velocity greater than 2.0 feet per second when flowing full and a maximum velocity less than 10 feet per second when flowing full.

$$v = \frac{1.49}{n} \times R_h^{0.67} \times \sqrt{S}$$

**Figure 1 - Manning's Formula**

Where:

$v$  = velocity (ft/sec)

$n$  = Manning's roughness coefficient (0.013)

$R_h$  = hydraulic radius (ft)

$S$  = slope (ft/ft)

# VERAMENDI PRECINCT 18 UNIT 1

## Organized Sewage Collection System Application (TCEQ-0582)

Table 2 – Manholes and Cleanouts

Line	Shown on Sheet	Station	Manhole or Cleanout
"A"	C5.10	40+24.98	M.H. "A22"
"B"	C5.11	6+75.40	M.H. "B3"
"C"	C5.12	6+37.95	M.H."C3"
"D"	C5.13	7+60.46	M.H. "D4"
"E"	C5.14	6+18.02	M.H. "E6"
"F"	C5.15	6+19.00	M.H "F2"
"G"	C5.18	21+93.08	M.H. "G11"
"H"	C5.19	3+01.86	M.H. "H2"
"I"	C5.20	8+22.00	M.H. "I3"
"J"	C5.21	5+17.00	M.H. "J1"
"K"	C5.23	13+75.49	M.H. "K5"

**VERAMENDI PRECINCT 18 UNIT 1**  
**Organized Sewage Collection System Application (TCEQ-0582)**

**Table 3 – 100-Year Floodplain**

Line	Shown on Sheet	Station
"A"	C5.06	1+00.00 to 1+73.53



**VERAMENDI PRECINCT 18 UNIT 1**  
**Organized Sewage Collection System Application (TCEQ-0582)**

**Table 4 – 5-Year Floodplain**

Line	Shown on Sheet	Station
"A"	C5.06	1+00.00 to 1+73.53

# VERAMENDI PRECINCT 18 UNIT 1

## Organized Sewage Collection System Application (TCEQ-0582)

**Table 5 - Water Line Crossings**

Line	Station or Closest Point	Crossing or Parallel	Horizontal Separation Distance	Vertical Separation Distance (ft)
"A"	9+80.42	Crossing	--	2.44
"A"	12+83.42	Crossing	--	3.68
"A"	29+44.50	Crossing	--	1.54
"A"	30+93.50	Crossing	--	3.05
"A"	32+30.50	Crossing	--	3.96
"A"	37+96.63	Crossing	--	2.91
"A"	39+69.98	Crossing	--	3.12
"B"	1+62.03	Crossing	--	5.16
"B"	2+32.03	Crossing	--	7.91
"B"	2+42.03	Crossing	--	8.08
"B"	4+72.03	Crossing	--	8.51
"B"	4+82.06	Crossing	--	8.37
"B"	5+52.03	Crossing	--	7.36
"B"	5+62.03	Crossing	--	7.22
"B"	6+32.07	Crossing	--	5.35
"B"	6+42.08	Crossing	--	4.92
"D"	1+90.49	Crossing	--	2.56
"D"	2+00.49	Crossing	--	2.57
"D"	3+24.86	Crossing	--	3.62
"D"	3+34.93	Crossing	--	3.71
"D"	5+01.19	Crossing	--	4.54
"D"	5+11.22	Crossing	--	4.72
"D"	6+15.46	Crossing	--	5.63
"D"	6+25.46	Crossing	--	5.56

# VERAMENDI PRECINCT 18 UNIT 1

## Organized Sewage Collection System Application (TCEQ-0582)

Line	Station or Closest Point	Crossing or Parallel	Horizontal Separation Distance	Vertical Separation Distance (ft)
"D"	7+05.46	Crossing	--	4.53
"D"	7+15.46	Crossing	--	4.40
"E"	1+71.86	Crossing	--	3.47
"E"	1+81.62	Crossing	--	3.41
"E"	2+70.23	Crossing	--	3.41
"E"	2+80.23	Crossing	--	3.45
"E"	3+57.37	Crossing	--	6.40
"E"	3+67.37	Crossing	--	6.94
"E"	4+37.37	Crossing	--	8.75
"F"	1+12.01	Crossing	--	6.50
"F"	5+42.34	Crossing	--	5.99
"F"	5+52.34	Crossing	--	5.48
"G"	1+55.17	Crossing	--	4.65
"G"	3+45.00	Crossing	--	4.43
"G"	3+55.00	Crossing	--	4.31
"G"	6+28.61	Crossing	--	4.74
"G"	6+38.62	Crossing	--	4.80
"G"	9+17.44	Crossing	--	3.69
"G"	9+26.90	Crossing	--	3.77
"G"	10+93.98	Crossing	--	3.52
"G"	11+04.02	Crossing	--	3.50
"G"	12+81.62	Crossing	--	3.40
"G"	12+91.62	Crossing	--	3.41
"G"	14+81.62	Crossing	--	4.21
"G"	14+91.62	Crossing	--	4.28

TABLE 5 - WATER LINE CROSSINGS  
Organized Sewage Collection System Application

# VERAMENDI PRECINCT 18 UNIT 1

## Organized Sewage Collection System Application (TCEQ-0582)

Line	Station or Closest Point	Crossing or Parallel	Horizontal Separation Distance	Vertical Separation Distance (ft)
"G"	16+81.82	Crossing	--	3.84
"H"	1+12.00	Crossing	--	2.46
"I"	1+12.00	Crossing	--	3.57
"I"	1+48.30	Crossing	--	3.76
"I"	2+58.30	Crossing	--	4.20
"I"	2+68.50	Crossing	--	4.24
"I"	3+78.50	Crossing	--	4.33
"I"	3+88.50	Crossing	--	4.25
"I"	4+98.30	Crossing	--	3.44
"I"	5+08.50	Crossing	--	3.52
"I"	6+18.50	Crossing	--	5.73
"I"	6+28.50	Crossing	--	5.96
"J"	1+12.00	Crossing	--	5.29
"J"	1+98.16	Crossing	--	7.69
"J"	2+08.16	Crossing	--	7.83
"J"	3+27.49	Crossing	--	7.11
"J"	3+37.49	Crossing	--	6.93
"J"	4+56.81	Crossing	--	4.78
"J"	4+66.81	Crossing	--	4.60
"K"	1+12.00	Crossing	--	2.66
"K"	1+45.83	Crossing	--	3.34
"K"	2+62.82	Crossing	--	3.95
"K"	2+72.82	Crossing	--	3.97
"K"	3+92.34	Crossing	--	4.21
"K"	4+02.15	Crossing	--	4.23

TABLE 5 - WATER LINE CROSSINGS  
Organized Sewage Collection System Application



**VERAMENDI PRECINCT 18 UNIT 1**

**Organized Sewage Collection System Application (TCEQ-0582)**

Line	Station or Closest Point	Crossing or Parallel	Horizontal Separation Distance	Vertical Separation Distance (ft)
"K"	5+21.50	Crossing	--	4.29
"K"	5+52.97	Crossing	--	3.30
"K"	6+66.96	Crossing	--	3.88
"K"	6+76.96	Crossing	--	3.90
"K"	7+66.96	Crossing	--	4.08
"K"	7+76.96	Crossing	--	4.10
"K"	8+71.96	Crossing	--	4.29
"K"	8+81.96	Crossing	--	4.31
"K"	9+71.96	Crossing	--	4.16
"K"	9+81.96	Crossing	--	4.13
"K"	10+71.96	Crossing	--	3.86
"K"	11+50.10	Crossing	--	3.68
"K"	12+39.26	Crossing	--	3.92
"K"	12+49.26	Crossing	--	3.94
"K"	13+28.32	Crossing	--	3.71
"K"	13+38.32	Crossing	--	3.69

# VERAMENDI PRECINCT 18 UNIT 1

## Organized Sewage Collection System Application (TCEQ-0582)

Table 6 – Vented Manholes

Line	Manhole	Station	Sheet
"A"	M.H. "A3"	8+95.29	C5.07
"A"	M.H. "A6"	14+44.42	C5.07
"A"	M.H. "A9"	19+82.66	C5.08
"A"	M.H. "A12"	23+71.74	C5.08
"A"	M.H. "A15"	28+14.94	C5.09
"A"	M.H. "A17"	32+42.50	C5.09
"A"	M.H. "A19"	38+08.63	C5.10
"A"	M.H. "A22"	40+24.98	C5.10
"B"	M.H. "B3"	6+75.40	C5.11
"C"	M.H. "C3"	6+37.95	C5.12
"D"	M.H. "D3"	5+55.46	C5.13
"D"	M.H. "D4"	7+60.46	C5.13
"E"	M.H. "E5"	5+36.02	C5.14
"E"	M.H. "E6"	6+18.02	C5.14
"F"	M.H. "F2"	6+19.00	C5.15
"G"	M.H. "G3"	7+26.14	C5.16
"G"	M.H. "G5"	9+97.24	C5.17
"G"	M.H. "G9"	18+89.04	C5.18
"G"	M.H. "G11"	21+93.08	C5.18
"H"	M.H. "H2"	3+01.86	C5.19
"I"	M.H. "I1"	4+27.00	C5.20
"I"	M.H. "I3"	8+22.00	C5.20
"J"	M.H. "J1"	5+17.00	C5.21
"K"	M.H. "K2"	6+24.49	C5.22

**ATTACHMENT A**  
**(Engineering Design Report)**

**VERAMENDI PRECINCT 18 UNIT 1**  
**Engineering Design Report**  
**8" PVC SDR 26**

**TABLE OF CONTENTS**

PROJECT INFORMATION ..... 1

GRAVITY SANITARY SEWER PIPING: FLOW & CAPACITY ANALYSIS..... 1

    Odor Control ..... 2

    Flow Calculation ..... 2

    Capacity Calculation ..... 3

    Conclusion ..... 5

GENERAL STRUCTURAL COMPONENTS..... 5

    Project Materials (Pipe and Joints): ..... 5

    Project Materials (Bedding): ..... 6

    Project Materials (Manholes): ..... 6

    Project Materials (Manhole Covers): ..... 7

    Minimum and Maximum Slopes ..... 7

    Backfill ..... 7

    Trenching ..... 7

    Minimum and Maximum Trench Width ..... 8

    Corrosion Prevention ..... 8

    Manholes (General) ..... 8

    Manholes (Inverts) ..... 9

    Manholes (Ventilation) ..... 9

FLEXIBLE PIPE COMPUTATIONS ..... 9

    Live Load Calculations ..... 9

    Buckling Pressure Calculations ..... 9

    Allowable Buckling Pressure: ..... 10

    Pressure Under Installed Conditions ..... 11

    Installation Temperature Effects ..... 12

    Tensile Strength ..... 13

    Strain ..... 13

    Modulus of Soil Reaction ..... 13

    Zeta Calculation ..... 14

    Pipe Stiffness ..... 15

    Deflection ..... 15



# **VERAMENDI PRECINCT 18 UNIT 1**

## **Engineering Design Report**

### **8" PVC SDR 26**

This Engineering Design Report has been prepared to comply with the Texas Commission on Environmental Quality's Design Criteria for Domestic Wastewater Systems (30 TAC 217), and regulations over the Edwards Aquifer Recharge Zone (30 TAC 213). Please note, throughout this application, the more stringent of New Braunfels Utilities (NBU) or TCEQ regulations shall apply.

#### **PROJECT INFORMATION**

Veramendi Precinct 18 Unit 1 is a 215 single family home residential project to be constructed in conjunction with an overall development of 121.98 acres. The Precinct 18 Unit 1 project site is located approximately approx. 1.0 mi NW of TX-46/TX-337 and Word Pkwy intersection within the Extra-Territorial Jurisdiction of the City of New Braunfels in Comal County, Texas, and is located entirely over the Edwards Aquifer Recharge Zone. The site lies within the Bleiders Creek watershed and contains 100-year floodplain. There are no naturally occurring sensitive geological features identified in the Geologic Assessment.

The Veramendi Precinct 18 Unit 1 Sewage Collection System (SCS) Application proposes the construction of a total of approximately 11,445.21 linear feet (LF) of sewer main to serve the development. The proposed alignment will consist of approximately 9985.21 LF of 8-inch (8") PVC, SDR 26 gravity sewer main and 1460.00 linear feet (LF) of 8-inch (8") PVC SDR 26 160-psi pressure rated sewer main centered at water line crossings. See included plan and profile exhibits for details. Regulated activities proposed include excavation, construction of sewer mains, backfill and compaction. Approximately 26.49 acres of the project site may be disturbed for this SCS installation as identified by the limits of the fifty-foot (50') SCS/GA envelope shown on the plans.

This project will result in 215 LUEs for the single-family residential development. Approximately 45,150 gpd average flow is anticipated for this development based on 210 gpd/LUE. The sewage flow will be disposed of by conveyance to the existing Gruene Wastewater Treatment Center operated by New Braunfels Utilities (NBU).

# VERAMENDI PRECINCT 18 UNIT 1

## Engineering Design Report

### 8" PVC SDR 26

Please refer to Sheet C5.00 to C5.40 of the attached sewer plans, which show the proposed service area and its topographic features, for information regarding the capability of the existing system and facilities to handle this increased flow. This system is designed to have a minimum structural life of 50 years.

Safety considerations are the responsibility of the contractor. Safety protection shall be accomplished in accordance with the most recent requirements of the Occupational Safety and Health Administration (OSHA) Standards and Interpretations.

#### GRAVITY SANITARY SEWER PIPING: FLOW & CAPACITY ANALYSIS

Basis for average flow used for design of collection system (check one or more):

Per Capita Contributions:  \_\_\_\_\_  
Service Connections: \_\_\_\_\_  
Land Area and Use:  \_\_\_\_\_  
Fixture Analysis: \_\_\_\_\_

#### Odor Control

Odor Control is not necessary on this project as it is a gravity line and there will be no conditions where sewage is standing and will become septic.

#### Flow Calculation

Peaking Factor used for design:  $\frac{[18+(0.0206 \times F)^{0.5}]}{[4+(0.0206 \times F)^{0.5}]} \times F$

$$F = 210 \text{ (gal/LUE/day)} \times (\#LUE) / 1440$$

Peaking Factor is based on: **NBU Specifications for peak dry weather flow (from NBU 2.9.3)**

Total LUEs = 215

1 LUE = 210 gallons per day (average sewage flow)

**Avg. Daily Dry Weather Flow** = 215 LUEs x (210 gpd/LUE) = 45,150 gpd = **31.35 gpm**

$F = 210 \text{ (gal/LUE/day)} \times (215 \text{ LUE}) / 1440 = 31.35 \text{ gpm}$

**Peak Dry Weather Flow** =  $\frac{[18+(0.0206 \times 31.35)^{0.5}]}{[4+(0.0206 \times 31.35)^{0.5}]} \times 31.35 = \underline{\underline{122.72 \text{ gpm}}}$

Infiltration = 750 gallons per acre served

**Avg. Daily Wet Weather Flow** = 31.35 gpm + [(750gpd/acre) x 54.53 acres]/1440 = **59.75 gpm**

# VERAMENDI PRECINCT 18 UNIT 1

## Engineering Design Report

### 8" PVC SDR 26

**Peak Wet Weather Flow** =  $122.72 \text{ gpm} + [(750 \text{ gpd/acre}) \times 54.53 \text{ acres}] / 1440 = \underline{151.12 \text{ gpm}}$

Please note that capacities are determined using Manning's equation for pipes flowing full with an "n" value of 0.013. A reference for Manning's Equation can be found in "The Uni-Bell Handbook of PVC Pipe: Design and Construction".

#### Capacity Calculation

Characteristics of 8" ASTM D3034, SDR 26, PVC Sewer Pipe:

Nominal Size = 8"

Outer Diameter ( $D_o$ ) = 8.40"

Minimum Wall Thickness ( $t$ ) = 0.323"

Inner Diameter ( $D_i$ ) = 7.75"

Characteristics of 8" ASTM 2241, Class 160, SDR 26, PVC Sewer Pipe:

Nominal Size = 8"

Outer Diameter ( $D_o$ ) = 8.625"

Minimum Wall Thickness ( $t$ ) = 0.332"

Inner Diameter ( $D_i$ ) = 7.961"

Manning's Equation:

$$Q = (k/n)(A)(R^{2/3})(S^{1/2})$$

$$v = Q/A$$

Where:

$Q$  = Discharge (cfs)

$k$  = Constant [(1.49  $\text{ft}^{1/3}$ )/sec.]

$n$  = Manning's roughness coefficient (unitless)

$A$  = Flow area ( $\text{ft}^2$ )

$R$  = Hydraulic Radius (ft)

=  $A/P$  = Cross sectional area of flow ( $\text{ft}^2$ )/Wetted perimeter (ft.)

# VERAMENDI PRECINCT 18 UNIT 1

## Engineering Design Report

### 8" PVC SDR 26

$S = \text{Slope (ft/ft)}$

$v = \text{Velocity of flow (ft/s)}$

$n = 0.013$  [as required by 30 TAC 213.53 A(i)]

Calculations for 8" ASTM D3034, SDR 26, PVC Sewer Pipe:

$$A = \pi(D_i^2)/4 = \pi(7.75 \text{ in})^2/4 = 47.17 \text{ in}^2 = 0.33 \text{ ft}^2$$

$$P = \pi(D_i) = \pi(7.75 \text{ in}) = 24.35 \text{ in} = 2.03 \text{ ft}$$

$$R = A/P = 0.33 \text{ ft}^2/2.03 \text{ ft} = 0.16 \text{ ft}$$

$$S = 0.0034$$

$$Q = [(1.49 \text{ ft}^{1/3}/\text{sec})/0.013](0.33 \text{ ft}^2)(0.16 \text{ ft})^{2/3}(0.0034)^{1/2}$$

$$Q = 0.65 \text{ cfs} = 291 \text{ gpm} = Q_{full}$$

$$v = 0.65 \text{ cfs}/0.33 \text{ ft}^2 = \mathbf{1.98 \text{ ft/s}}$$

$$Q_{max} \text{ at } 85\% \text{ of full flow capacity} = 0.65 \text{ cfs} (0.85)(7.48 \text{ gallons}/1 \text{ cf})(60 \text{ sec}/1 \text{ min.}) = \mathbf{248 \text{ gpm}}$$

$$Q_{max} \text{ at } 65\% \text{ of full flow capacity} = 0.65 \text{ cfs} (0.65)(7.48 \text{ gallons}/1 \text{ cf})(60 \text{ sec}/1 \text{ min.}) = \mathbf{190 \text{ gpm}}$$

Calculations for 8" ASTM 2241, Class 160, SDR 26, PVC Sewer Pipe:

$$A = \pi(D_i^2)/4 = \pi(7.961 \text{ in})^2/4 = 49.78 \text{ in}^2 = 0.35 \text{ ft}^2$$

$$P = \pi(D_i) = \pi(7.961 \text{ in}) = 25.01 \text{ in} = 2.08 \text{ ft}$$

$$R = A/P = 0.35 \text{ ft}^2/2.08 \text{ ft} = 0.17 \text{ ft}$$

$$S = 0.0034$$

$$Q = [(1.49 \text{ ft}^{1/3}/\text{sec})/0.013](0.35 \text{ ft}^2)(0.17 \text{ ft})^{2/3}(0.0034)^{1/2}$$

$$Q = 0.70 \text{ cfs} = 313 \text{ gpm} = Q_{full}$$

$$v = 0.70 \text{ cfs}/0.35 \text{ ft}^2 = \mathbf{2.02 \text{ ft/s}}$$

$$Q_{max} \text{ at } 85\% \text{ of full flow capacity} = 0.70 \text{ cfs} (0.85)(7.48 \text{ gallons}/1 \text{ cf})(60 \text{ sec}/1 \text{ min.}) = \mathbf{266 \text{ gpm}}$$

$$Q_{max} \text{ at } 65\% \text{ of full flow capacity} = 0.70 \text{ cfs} (0.65)(7.48 \text{ gallons}/1 \text{ cf})(60 \text{ sec}/1 \text{ min.}) = \mathbf{204 \text{ gpm}}$$



**VERAMENDI PRECINCT 18 UNIT 1**  
**Engineering Design Report**  
**8" PVC SDR 26**

Nominal Main Size (in)	Outer Diameter (in)	Minimum Slope (%)	Area (ft <sup>2</sup> )	Hydraulic Radius (A/P) ft	R <sup>2/3</sup>	S <sup>1/2</sup>	Q-Full (cfs)	Max Pipe (%)	Velocity (ft/s)	Q-Max (gpm)	Qpeak (gpm)
8 (NR)	8.40	0.34	0.33	0.16	0.30	0.058	0.65	85	1.98	248	151.12
8 (PR)	8.625	0.34	0.35	0.17	0.30	0.058	0.70	85	2.02	266	151.12
8 (NR)	8.40	0.34	0.33	0.16	0.30	0.058	0.65	65	1.98	190	122.72
8 (PR)	8.625	0.34	0.35	0.17	0.30	0.058	0.70	65	2.02	204	122.72

Due to rounding all flow velocities will meet 2 fps requirement.

**Conclusion**

The proposed 8" pipe (NR & PR) with a minimum slope of 0.34% has sufficient capacity to convey the projected Peak Dry Weather and Peak Wet Weather flows under 65% and 85% respectively.

**GENERAL STRUCTURAL COMPONENTS**

**Project Materials (Pipe and Joints):**

Nominal Pipe Diameter (in)	Linear Feet	Pipe Material	National Standard Specification for Pipe Material	National Standard for Pipe Joints
8	9,985.21	PVC SDR 26	ASTM D3034	ASTM D3212
8 pressure rated	1,460	PVC SDR 26	ASTM 2241, Class 160	ASTM D3139 ASTM C1173

Note: Section 217.53 (j)(4) requires a minimum pipe diameter of 6 inches for all gravity sanitary sewer collection system piping.

Watertight, size on size resilient connectors conforming to ASTM C-923 have been specified for connecting pipe to manholes. See NBU Standard Specification for Construction Detail.

Where a collection system parallels a water supply pipe and a nine-foot separation distance cannot be achieved, Section 217.53 (d)(3)(A)(i) requires a collection system pipe be constructed of cast iron, ductile

# VERAMENDI PRECINCT 18 UNIT 1

## Engineering Design Report

### 8" PVC SDR 26

iron, or PVC meeting ASTM specifications with at least a 150 pounds per square inch (psi) rating for both the pipe and joints. The proposed project will not include any separations less than nine-feet.

Where a collection system pipe crosses a water supply line and a nine-foot separation distance cannot be achieved, Section 217.53(d)(3)(B)(i) requires the collection system pipe be constructed of cast iron, ductile iron, or PVC with a minimum pressure rating of 150 psi. The proposed project will not include any water supply lines.

#### Project Materials (Bedding):

The specified bedding will comply with ASTM D2321-11 Class I, II or III for materials and densification. A minimum of 6 inches of bedding is required for all pipe.

Pipe Diameter (in)	Pipe Material	Bedding Class
8	PVC	Class I & Class III

The selection of bedding class is based on NBU detail for sanitary sewer pipe laid in a trench. Initial backfill for the pipe sizes shown above will be Class I. Secondary backfill will be Class III. See Table 2 of ASTM D2321-11 "Soil Classes" in Appendix A of this subsection.

#### Project Materials (Manholes):

Section 217.55 (f) prohibits the use of bricks to adjust a manhole cover to grade or construct a manhole. The proposed project will comply with this requirement.

The inside diameter of a manhole must be no less than 48 inches.

Section 217.55 (n) requires watertight, size-on-size resilient connectors that allow for differential settlement and must conform to American Society for Testing and Materials C-923. The proposed project complies with this requirement.

Under 30 TAC 213.5(C)(3)(A), all manholes over the Recharge Zone must be watertight, with watertight rings and covers. The proposed project complies with this requirement.

# VERAMENDI PRECINCT 18 UNIT 1

## Engineering Design Report

### 8" PVC SDR 26

The materials specified for manhole construction are precast concrete.

#### Project Materials (Manhole Covers):

Manhole covers must be constructed of impervious materials. If personnel entry is required, a minimum 30-inch diameter clear opening must be provided. Inclusion of steps in a manhole is prohibited. If a manhole must be located within a 100-year floodplain then a means of preventing inflow is required. A manhole cover that is located in a roadway must meet or exceed the American Association of State Highways and Transportation Officials Standard M-306 for load bearing.

Under 30 TAC 213.5 (c)(3)(A), all manholes over the Edwards Aquifer Recharge Zone must be watertight, with watertight rings and covers. This proposed project complies with this requirement.

#### Minimum and Maximum Slopes

Note: All pipes are designed with a slope that will provide a velocity of at least 2 ft/s flowing full, as calculated using Manning's equation with an "n" value of 0.013. Additionally, the collection system is designed to ensure that, with pipes flowing full, the velocities will be less than 10 feet per second.

The following are the minimum and maximum slopes for each pipe diameter:

Pipe Diameter: 8"(NR & PR) Min. Slope: 0.34% Max. Slope: 8.30%

#### Backfill

Note: The backfill will be free of stones greater than 6 inches in diameter and free of organic or any other unstable material. See NBU details for additional specifications.

#### Trenching

Note: The trench width will be minimized while still allowing adequate width for proper compaction of backfill, and while still ensuring that at least 6 inches of backfill exists below and on each side of the pipe. The trench walls will be vertical to at least one foot above the pipe.

# VERAMENDI PRECINCT 18 UNIT 1

## Engineering Design Report

### 8" PVC SDR 26

Trenching will occur over the Recharge Zone and will comply with 30 TAC 213.5.

#### Minimum and Maximum Trench Width

Based on NBU Standard Drawing and 30 TAC 217.54:

Pipe Diameter: 8" (NR) Min. Trench Width: 22" Max. Trench Width: 34"

Pipe Diameter: 8" (PR) Min. Trench Width: 23" Max. Trench Width: 35"

These trench widths account for the bell diameter.

#### Corrosion Prevention

Proposed collection system components (pipes, manholes, etc.) will not be susceptible to deterioration through the corrosive effects of an anaerobic sewage environment. The interior of the manholes, however, are to be coated with a NBU approved sewer structural coating. Epoxy coating specifically approved. The epoxy coating on the interior walls of the manhole provide interior corrosion protection.

#### Manholes (General)

Note: Manholes are provided at all changes in size, grade or alignment of pipe, at the intersection of all pipes and at the end of all lines that may be extended at a future date. A clean-out with watertight plugs may be installed instead of a manhole if no extensions are anticipated. Clean outs must pass all testing requirements outlined for gravity collection pipes.

The project complies with the maximum manhole spacing allowed by the TCEQ:

Pipe Diameter (in)	Max. Manhole Spacing (ft)
6 - 15	500
18 - 30	800
36 - 48	1000
54 or larger	2000



# VERAMENDI PRECINCT 18 UNIT 1

## Engineering Design Report

### 8" PVC SDR 26

Manhole Spacing:

Pipe Diameter: 8" Max. Spacing: 464.97 LF

#### Manholes (Inverts)

The bottom of a manhole must contain a U-shaped channel, which is a smooth continuation of the inlet, and outlet pipes. The bench above the channel must be sloped a minimum of 0.5 inches per foot. Note, a manhole connected to a pipe less than 15 inches in diameter must have a channel depth equal to at least half the largest pipe's diameter.

#### Manholes (Ventilation)

Vented manholes are proposed for this SCS. Refer to the plans and details for additional information.

#### FLEXIBLE PIPE COMPUTATIONS

Please note, all flexible pipe computations are based on engineering principles and practices for the design of buried PVC pipe systems. Equations used can be found in "The Uni-Bell PVC Pipe Association Handbook of PVC Pipe: Design and Construction". Please note, the equations used may be in a different format than shown in the Uni-Bell Handbook.

#### Live Load Calculations

Minimum burial depth without concrete encasement is six (6) feet. Based on Table 6-6 Live Loads on PVC pipe (from Uni-Bell Handbook for PVC) for this sewer line would be 1.39 psi.

#### Buckling Pressure Calculations

This area of the Edwards Aquifer is unsaturated; consequently, there are no anticipated areas where sewer pipe will be placed below the water table. The value of  $hw=0$  as there will be no height or time period of perched water or groundwater above the pipe crowns of the proposed sewer line.

The value of H for use in these calculations is fifteen (15) feet as it exceeds the maximum burial depth for this line. The value of  $\gamma_s$  equals 143 pcf is a conservative value based on a dry unit weight of 135 pcf and a

**VERAMENDI PRECINCT 18 UNIT 1**  
**Engineering Design Report**  
**8" PVC SDR 26**

moisture content of 6%. This value is conservative as it corresponds to saturated unit weights of commonly used backfill materials. Please see information from Raba-Kistner provided in Appendix B.

**Allowable Buckling Pressure:**

$$q_a = 0.4 * \sqrt{32 * R_w * B' * E_b * (E * I / D^3)} \quad \text{Equation 1}$$

$$q_a = 0.4 * \sqrt{32 * 1 * 0.40 * 400 * (400,000 * 0.003 / 8.08^3)} = 43.17 \text{ psi (8" PVC SDR26, NR)}$$

$$q_a = 0.4 * \sqrt{32 * 1 * 0.40 * 400 * (400,000 * 0.003 / 8.29^3)} = 41.54 \text{ psi (8" PVC SDR26, PR)}$$

$$R_w = 1 - 0.33 * (h_w/h) \quad \text{Equation 2}$$

$$R_w = 1 - 0.33 * (0/240) = 1$$

$$B' = \frac{I}{I + 4 * e^{-0.065H}} \quad \text{Equation 3}$$

$$B' = \frac{1}{1 + 4 * e^{-0.065 * 15}} = 0.40$$

$$I = t^3/12 * (\text{inches}^3/\text{linear inch}) \quad \text{Equation 4}$$

$$I = 0.323^3/12 = 0.003 \text{ in}^3 \text{ (8" PVC SDR 26, NR)}$$

$$I = 0.332^3/12 = 0.003 \text{ in}^3 \text{ (8" PVC SDR 26, PR)}$$

$$D = D_o - t \quad \text{Equation 5}$$

$$D = 8.40 \text{ inches} - 0.323 \text{ inches} = 8.08 \text{ inches (8" PVC SDR 26, NR)}$$

$$D = 8.625 \text{ inches} - 0.332 \text{ inches} = 8.29 \text{ inches (8" PVC SDR 26, PR)}$$

Where:

$q_a$  = Allowable buckling pressure, pounds per square inch (psi)

$h$  = Height of soil surface above top of pipe in inches (in)

$h_w$  = Height of water surface above top of pipe in inches (in) (groundwater elevation)

**VERAMENDI PRECINCT 18 UNIT 1**  
**Engineering Design Report**  
**8" PVC SDR 26**

- $R_w$  = Water buoyancy factor. If  $h_w = 0$ ,  $R_w = 1$ . If  $0 \leq h_w \leq h$  (groundwater elevation is between the top of the pipe and the ground surface), calculate  $R_w$  with Equation 2
- $H$  = Depth of burial in feet (ft) from ground surface to crown of pipe.
- $B'$  = Empirical coefficient of elastic support
- $E_b$  = Modulus of soil reaction for the bedding material (psi)
- $E$  = Modulus of elasticity of the pipe material (psi)
- $I$  = Moment of inertia of the pipe wall cross section per linear inch of pipe,  $\text{inch}^4/\text{lineal inch} = \text{inch}^3$ . For solid wall pipe, "I" can be calculated with Equation 4
- $t$  = Pipe structural wall thickness (in)
- $D$  = Mean pipe diameter (in)
- $D_o$  = Pipe outer diameter (in)

**Pressure Under Installed Conditions**

$$q_p = \gamma_w * h_w + R_w * (W_c / D) + L_l \quad \text{Equation 6}$$

$$q_p = 0.361 * 0 + 1 * (125.17/8.08) + 1.39 = 16.88 \text{ psi (8" PVC SDR 26, NR)}$$

$$q_p = 0.361 * 0 + 1 * (128.43/8.29) + 1.39 = 16.88 \text{ psi (8" PVC SDR 26, PR)}$$

Where:

- $q_p$  = Pressure applied to pipe under installed conditions (psi)
- $\gamma_w$  = 0.0361 pounds per cubic inch (pci), specific weight of water
- $W_c$  = Vertical soil load on the pipe per unit length in pounds per linear inch (lb/in)
- $L_l$  = Live load (lbs)

$$W_c = \gamma_s * H * (D + t) / 144 \quad \text{Equation 7}$$

$$W_c = 143 * 15 * (8.08 + 0.323) / 144 = 125.17 \text{ lb/in}^2 \text{ (8" PVC SDR 26, NR)}$$

$$W_c = 143 * 15 * (8.29 + 0.332) / 144 = 128.43 \text{ lb/in}^2 \text{ (8" PVC SDR 26, PR)}$$

# VERAMENDI PRECINCT 18 UNIT 1

## Engineering Design Report

### 8" PVC SDR 26

Where:

- $\gamma_s$  = Specific weight of soil in pounds per cubic foot (pcf)
- D = Mean pipe diameter (in)

Pipe Diameter: 8" (NR) Pipe Material: PVC, SDR 26  $q_a$ : 43.17  $q_p$ : 16.88

Pipe Diameter: 8" (PR) Pipe Material: PVC, SDR 26  $q_a$ : 41.54  $q_p$ : 16.88

Since  $q_a \geq q_p$ , the specific pipe is acceptable for the proposed installation.

#### Wall Crushing Calculations

No portion of the proposed sewer line is located in the 5-year floodplain.

$$H = (24 * P_c * A) / (\gamma_s * D_o) \quad (\text{Equation 8})$$

$$A = t(\text{in}) \times 12(\text{in} / \text{ft}) \quad (\text{Equation 9})$$

$$H = (24 * 4,000 * 3.876) / (143 * 8.4) = 309.77 \text{ (8" PVC, SDR 26, NR)}$$

$$A = 0.323(\text{in}) \times 12(\text{in} / \text{ft}) = 3.876$$

$D_o$  = outside pipe diameter, in.

$P_c$  = compressive stress or hydrostatic design basis (HDB). For typical PVC pipe assume 4,000 psi. For any other pipe material, the HDB must be supplied by the pipe manufacturer.

A = surface area of the pipe wall, in.<sup>2</sup>/ft [conversion factor of 12 applied to change from ft. to in.]

$\gamma_s$  = specific weight of soil in pounds per cubic foot (pcf)

H = Depth of burial in feet (ft) from ground surface to crown of pipe.

24 = conversions and coefficients

#### Installation Temperature Effects

Flexible pipe will be installed under favorable ambient conditions, per pipe manufacturer's specifications.

# VERAMENDI PRECINCT 18 UNIT 1

## Engineering Design Report

### 8" PVC SDR 26

#### Tensile Strength

The information below is from "The Uni-Bell Handbook of PVC Pipe: Design and Construction" Table 2.1 pages 14-15. This applies to all PVC SDR-26 pipe.

Pipe Material: PVC SDR 26      Tensile Strength: 7,000      Cell Class (PVC only) 12454

#### Strain

The conditions of this installation are such that strain-related failure will not be a problem. Strain is generally not a performance-limiting factor for buried PVC pipe or a design-limiting criterion for PVC pipes according to the Uni-Bell Handbook of PVC Pipe (Chapter VII, Pages 255 and 257). As pipe deflection will be below 5%, strain-related failure is not anticipated.

#### Modulus of Soil Reaction

The modulus of soil reaction for the bedding material,  $E_b$ , is 400 psi.

This value was determined using the "Table 1: Soil Classification Chart" and "Table 2: Soil Classes" from ASTM D2321-11 and "Average Values of Modulus of Soil Reaction,  $E$ " Table 7.3 from "The Uni-Bell Handbook of PVC Pipe: Design and Construction" attached in Appendix A of this subsection. Based on NBU detail, Class III material was chosen. As the secondary backfill (Class III) has a lower Modulus of Soil Reaction than initial backfill (Class I), its value was used in the calculations that follow. Class III on Table 2 corresponds to coarse-grained soils with fines (GM, GC, SM or SC) and sandy or gravelly fine-grained soils (CL or ML). On Table 7.3, coarse-grained soils with fines at a slight compaction have an  $E'$  equal to 400 psi.

The modulus of soil reaction for the in-situ soil,  $E'_n$ , is 3,000 psi

This value was determined using the "Table 1: Soil Classification Chart" and "Table 2: Soil Classes" from ASTM D 2321-11 and "Average Values of Modulus of Soil Reaction,  $E$ " Table 7.3 from "The Uni-Bell Handbook of PVC Pipe: Design and Construction" attached in Appendix A of this subsection. Based on NBU detail, Class I material was chosen, which includes crushed rock as shown on Table 2. Compacted



**VERAMENDI PRECINCT 18 UNIT 1**  
**Engineering Design Report**  
**8" PVC SDR 26**

crushed rock on Table 7.3 has an E' equal to 3,000 psi. Values in Table 7.3 are based on empirical data and derived from laboratory and field tests for buried pipe.

Bedding to in-situ soil modulus of soil reaction ratio =  $E_b/E'_n = \underline{400 \text{ psi}/3,000 \text{ psi} = 0.13}$

**Zeta Calculation**

Where native soil is significantly weaker than bedding material, or where predicted deflection approaches 5%, the effect of native soil must be quantified using Leonhardt's Zeta factor. If the ration of bedding modulus to soil modulus is not equal to 1.0, a zeta factor must be calculated by using the equations below, where zeta is a factor, which corrects for the effect of in-situ soil on pipe stability (Uni-Bell Handbook of Pipe, page 267). To calculate zeta, directly use the formulas below. The calculations that are done to determine the zeta factors for the different pipe diameters must be included with this submittal.

$$zeta = \frac{1.44}{f + (1.44 - f) * (E_b / E'_n)} \quad \text{Equation 10}$$

$$zeta = \frac{1.44}{1.22 + (1.44 - 1.22) * 0.13} = 1.15(8'' \text{ PVC SDR 26, NR})$$

$$zeta = \frac{1.44}{1.22 + (1.44 - 1.22) * 0.13} = 1.15(8'' \text{ PVC SDR 26, PR})$$

$$f = \frac{b/d_a - 1}{1.154 + 0.444 * (b/d_a - 1)} \quad \text{Equation 11}$$

$$f = \frac{(34/8.40) - 1}{1.154 + 0.444 * ((34/8.40) - 1)} = 1.22(8'' \text{ PVC SDR 26, NR})$$

$$f = \frac{(35/8.625) - 1}{1.154 + 0.444 * ((35/8.625) - 1)} = 1.22(8'' \text{ PVC SDR 26, PR})$$

Where:

- f = Pipe/trench width coefficient
- b = Trench width (in)

**VERAMENDI PRECINCT 18 UNIT 1**  
**Engineering Design Report**  
**8" PVC SDR 26**

$d_a$  = Pipe diameter (in)

$E_b$  = Modulus of soil reaction for the bedding material (psi)

$E'_n$  = Modulus of soil reaction for the in-situ soil (psi)

Pipe Diameter: 8" (NR) Trench Width: 34" Zeta: 1.15

Pipe Diameter: 8" (PR) Trench Width: 35" Zeta: 1.15

**Pipe Stiffness**

Ps is based on National Reference Standards and manufacturer's data. Please see Table 7.1 of the "The Uni-Bell Handbook of PVC Pipe: Design and Construction" listing the pipe stiffness of 8" PVC SDR 26 as 115 psi for E = 400,000 psi and 8" PVC SDR 26 as 160 psi for E = 400,000 psi.

Pipe Diameter: 8" Pipe Material: PVC SDR 26 (NR) Ps: 115 psi

Pipe Diameter: 8" Pipe Material: PVC SDR 26 (PR) Ps: 115 psi

**Deflection**

Maximum allowable deflection in installed lines is 5% (per 30 TAC 217), as determined by the deflection analysis and verified by a mandrel test. It is recommended that the percent of vertical deflection is below this range; however, a 7.5% deflection limit (recommended by ASTM D3034) provides a conservative factor of safety against structural failure (Handbook of PVC Pipe, page 249).

Note: Per Table 7.2 attached in Appendix A of the SCS Application, K = 0.096 when the bedding angle is 90 degrees. A bedding angle of 90 degrees is required as shown on NBU detail.

$$\Delta Y / D(\%) = \frac{K * (L_p + L_1) * 100}{(0.149 * P_s) + (0.061 * zeta * E_b)}$$

Equation 12

$$\Delta Y / D(\%) = \frac{0.096 * (14.90 + 1.39) * 100}{(0.149 * 115) + (0.061 * 1.15 * 400)} = 3.46\%(8" \text{ PVC SDR 26, NR})$$

**VERAMENDI PRECINCT 18 UNIT 1**  
**Engineering Design Report**  
**8" PVC SDR 26**

$$L_p = \frac{143 * 15}{144} = 14.90 \text{ psi}$$

- %ΔY/D = Predicted % vertical deflection under load
- ΔY = Change in vertical pipe diameter under load
- D = Undeformed mean pipe diameter (in)
- K = Bedding angle constant
- γ<sub>s</sub> = Unit weight of soil (pcf)
- H = Depth of burial (ft) from ground surface to crown of pipe
- L<sub>p</sub> = Prism load (psi)

Type of Pipe Material	P <sub>s</sub> (psi)	Zeta Factor Assumed or Calculated	E <sub>b</sub> (psi)	% Deflection
8" PVC SDR 26 (NR)	115	1.15	400	3.46
8" PVC SDR 26 (PR)	115	1.15	400	3.46

All pipes proposed for this project have a maximum predicted deflection below 5.0%

**Signature, Seal and Date of the Texas Professional Engineer Below:**



12/5/23

*Jocelyn Perez*

# **APPENDIX A (TABLES)**

**TABLE 7.3  
AVERAGE VALUES OF MODULUS OF SOIL REACTION, E'  
(For Initial Flexible Pipe Deflection)**

**From Uni-Bell Handbook of PVC Pipe: Design and Construction, Fourth Edition (2001)**

Soil type-pipe bedding material (Unified Classification System <sup>a</sup> ) (1)	E' for Degree of Compaction of Bedding, in pounds per square inch			
	Dumped (2)	Slight, < 85% Proctor, <40% relative density (3)	Moderate, 85%-95% Proctor, 40%-70% relative density (4)	High, >95% Proctor, >70% relative density (5)
Fine-grained Soils (LL>50) <sup>b</sup> Soils with medium to high plasticity, CH, MH, CH-MH	No data available; consult a competent soils engineer; Otherwise use E' = 0			
Fine-grained Soils (LL<50) Soils with medium to no plasticity, CL, ML, ML-CL, with less than 25% coarse- grained particles	50	200	400	1,000
Fine-grained Soils (LL<50) Soils with medium to no plasticity, CL, ML, ML-CL, with more than 25% coarse-grained particles Coarse-grained Soils with Fines GM, GC, SM, SC <sup>c</sup> contains more than 12% fines	100	400	1,000	2,000
Coarse-grained Soils with Little or no Fines GW, GP, SW, SP <sup>c</sup> contains less than 12% fines	200	1,000	2,000	3,000
Crushed Rock	1,000	3,000	3,000	3,000
Accuracy in Terms of Percentage Deflection <sup>d</sup>	± 2	± 2	± 1	± 0.5
<sup>a</sup> ASTM Designation D 2487, USBR Designation E-3. <sup>b</sup> LL = Liquid limit. <sup>c</sup> Or any borderline soil beginning with one of these symbols (i.e. GM-GC, GC-SC). <sup>d</sup> For ± 1% accuracy and predicted deflection of 3%, actual deflection would be between 2% and 4% Note: Values applicable only for fills less than 50 ft (15 m). Table does not include any safety factor. For use in predicting initial deflections only, appropriate Deflection Lag Factor must be applied for long-term deflections. If bedding falls on the borderline between two compaction categories, select lower E' value or average the two values. Percentage Proctor based on laboratory maximum dry density from test standards using about 12,500 ft-lb/cu ft (598,000 J/m <sup>3</sup> ) (ASTM D 698, AASHTO T-99, USBR Designation E-11). 1 psi = 6.9 kPa.				

SOURCE: "Soil Reaction for Buried Flexible Pipe" by Amster K. Howard, U.S. Bureau of Reclamation, Denver, Colorado. Reprinted with permission from American Society of Civil Engineers.



**TABLE 6.6**  
**LIVE LOADS ON PVC PIPE**  
**From Uni-Bell Handbook of PVC Pipe: Design and Construction, Fourth Edition (2001)**

Height of Cover (ft)	Live Load Transferred to Pipe, lb/in <sup>2</sup>			Height of Cover (ft)	Live Load Transferred to Pipe, lb/in <sup>2</sup>		
	Highway H20 <sup>1</sup>	Railway E80 <sup>2</sup>	Airport <sup>3</sup>		Highway H20 <sup>1</sup>	Railway E80 <sup>2</sup>	Airport <sup>3</sup>
1	12.50			14	*	4.17	3.06
2	5.56	26.39	13.14	16	*	3.47	2.29
3	4.17	23.61	12.28	18	*	2.78	1.91
4	2.78	18.40	11.27	20	*	2.08	1.53
5	1.74	16.67	10.09	22	*	1.91	1.14
6	1.39	15.63	8.79	24	*	1.74	1.05
7	1.22	12.15	7.85	26	*	1.39	*
8	0.69	11.11	6.93	28	*	1.04	*
10	*	7.64	6.09	30	*	0.69	*
12	*	5.56	4.76	35	*	*	*
				40	*	*	*

<sup>1</sup> Simulates 20 ton truck traffic + impact (Source: ASTM A 796)

<sup>2</sup> Simulates 80,000 lb/ft railway load + impact (Source: ASTM A 796)

<sup>3</sup> 180,000 lbs. dual tandem gear assembly. 26 inch spacing between tires and 66 inch center-to-center spacing between fore and aft tires under a rigid pavement 12 inches thick + impact.

\* Negligible live load influence.

# SOIL CLASSIFICATION CHART

## From ASTM D2321-11: Standard Practice for Underground Installation of Thermoplastic Pipe for Sewers and Other Gravity-Flow Applications

TABLE 1 Soil Classification Chart (see Classification D2487)

Criteria for Assigning Group Symbols and Group Names Using Laboratory Tests <sup>A</sup>				Soil Classification		
				Group Symbol	Group Name <sup>B</sup>	
Coarse-Grained Soils More than 50% retained on No. 200 sieve	Gravels More than 50% of coarse fraction retained on No. 4 sieve	Clean gravels	$C \geq 4$ and $1 \leq C_c \leq 3^C$	GW	Well-graded gravel <sup>D</sup>	
		Less than 5% of fines <sup>E</sup>	$Cu < 4$ and/or $1 > C_c > 3^C$	GP	Poorly graded gravel <sup>D</sup>	
	Sands 50% or more of coarse fraction passes on No. 4 sieve	Gravels with more than 12% fines <sup>E</sup>	Fines classify as ML or MH	GM	Silty gravel <sup>DFG</sup>	
			Fines classify as CL or CH	GC	Clayey gravel <sup>DFG</sup>	
		Clean sands	$Cu \geq 6$ and $1 \leq C_c \leq 3^C$	SW	Well-graded sand <sup>H</sup>	
		Less than 5% fines <sup>I</sup>	$Cu < 6$ and/or $1 > C_c > 3^C$	SP	Poorly graded sand <sup>H</sup>	
		Sand with fines	Fines classify as ML or MH	SM	Silty sand <sup>FGH</sup>	
	More than 12% fines <sup>I</sup>	Fines classify as CL or CH	SC	Clayey sand <sup>FGH</sup>		
Fine-Grained Soils 50% or more passes the No. 200 Sieve	Silts and clays Liquid limit less than 50	Inorganic	$PI > 7$ and plots on or above "A" line <sup>J</sup>	CL	Lean clay <sup>KLM</sup>	
			$PI < 4$ and plots below "A" line <sup>J</sup>	ML	silt <sup>KLM</sup>	
	Silts and clays Liquid limit 50 or more	Organic	Liquid Limit-Oven dried	$< 0.75$	OL	Organic clay <sup>KLMN</sup>
			Liquid Limit-Not dried			Organic silt <sup>KLMO</sup>
		Inorganic	PI plots on or above "A" line		CH	Fat clay <sup>KLM</sup>
			Plots below "A" line		MH	Elastic silt <sup>KLM</sup>
Organic	Liquid Limit-Oven Dried	$< 0.75$	OH	Organic clay <sup>KLMP</sup>		
	Liquid Limit-Not Dried			Organic silt <sup>KLMQ</sup>		
Highly organic soils	Primarily organic matter, dark in color, and organic odor			PT	peat	

<sup>A</sup> Based on the material passing the 3-in. (75-mm) sieve.

<sup>B</sup> If field sample contained cobbles or boulders, or both, add "with cobbles or boulders, or both" to group name.

<sup>C</sup>  $Cu = D_{60} / D_{10}$

$$C_c = \frac{(D_{30})^2}{D_{10} \times D_{60}}$$

<sup>D</sup> If soil contains  $\geq 15\%$  sand, add "with sand" to group name.

<sup>E</sup> Gravels with 5 to 12 % fines require dual symbols:

GW-GM well-graded gravel with silt:

GW-GC well-graded gravel with clay

GP-GM poorly graded gravel with silt

GP-GC poorly graded gravel with clay

<sup>F</sup> If fines classify as CL-ML, use dual symbol GC-GM, or SC-SM.

<sup>G</sup> If fines are organic, add "with organic fines" to group name.

<sup>H</sup> If soil contains  $\geq 15\%$  gravel, add "with gravel" to group name.

<sup>I</sup> Sands with 5 to 12 % fines require dual symbols:

SW-SM well graded sand with silt

SW-SC well-graded sand with clay

SP-SM poorly graded sand with silt

SP-SC poorly graded sand with clay

<sup>J</sup> If Atterberg limits plot in hatched area, soil is a CL-ML, silty clay (see Test Method D4318).

<sup>K</sup> If soil contains 15 to 29 % plus No. 200, add "with sand" or "with gravel", whichever is predominant.

<sup>L</sup> If soil contains  $\geq 30\%$  plus No. 200, predominantly sand, add "sandy" to group name.

<sup>M</sup> If soil contains  $\geq 30\%$  plus No. 200, predominantly gravel, add "gravelly" to group name.

<sup>N</sup>  $PI \geq 4$  and plots on or above "A" line.

<sup>O</sup>  $PI < 4$  or plots below "A" line.

<sup>P</sup>  $PI$  plots on or above "A" line.

<sup>Q</sup>  $PI$  plots below "A" line.

## SOIL CLASSIFICATION CHART

### From ASTM D2321-11: Standard Practice for Underground Installation of Thermoplastic Pipe for Sewers and Other Gravity-Flow Applications

**TABLE 2 Soil Classes**

Soil Group <sup>A,B</sup>	Soil Class	American Association of State Highway and Transportation Officials (AASHTO) Soil Groups <sup>C</sup>
Crushed rock, angular <sup>D</sup> , 100% passing 1-1/2 in. sieve, <=15 % passing #4 sieve, <= 25 % passing 3/8 in. sieve and <= 12 % passing #200 sieve	Class I	--
Clean, coarse grained soils: SW, SP, GW, GP or any soil beginning with one of these symbols with <= 12 % passing #200 sieve <sup>E,F</sup>	Class II	A1, A3
Coarse grained soils with fines: GM, GC, SM, SC or any soil beginning with one of these symbols, containing > 12 % passing #200 sieve; Sandy or gravelly fine-grained soils: CL, ML, or any soil beginning with one of these symbols, with >= 30 % retained on #200 sieve	Class III	A-2-4, A-2-5, A-2-6, or A-4 or A-6 soils with more than 30% retained on #200 sieve
Fine-grained soils: CL, ML, or any soil beginning with one of these symbols, with <30 % retained on #200 sieve	Class IV	A-2-7, or A-4, or A-6 soils with 30% or less retained on #200 sieve
MH, CH, OL, OH, PT	Class V Not for use as embedment	A5, A7

<sup>A</sup> See Classification D2487, Standard Classification of Soils for Engineering Purposes (Unified Soil Classification System).

<sup>B</sup> Limits may be imposed on the soil group to meet project or local requirements if the specified soil remains within the group. For example, some project applications require a Class I material with minimal fines to address specific structural or hydraulic conditions and the specification may read "Use Class I soil with a maximum of 5% passing the #200 sieve."

<sup>C</sup> AASHTO M145, Classification of Soils and Soil Aggregate Mixtures.

<sup>D</sup> All particle face shall be fractured.

<sup>E</sup> Materials such as broken coral, shells, and recycled concrete, with  $\leq$  12% passing a No. 200 sieve, are considered to be Class II materials. These materials should only be used when evaluated and approved by the Engineer.

<sup>F</sup> Uniform fine sands (SP) with more than 50% passing a No. 100 sieve (0.006 in., 0.15 mm) are very sensitive to moisture and should not be used as backfill unless specifically allowed in the contract documents. If use of these materials is allowed, compaction and handling procedures should follow the guidelines for Class III materials.

## SOIL CLASSIFICATION CHART

### From ASTM D2321-11: Standard Practice for Underground Installation of Thermoplastic Pipe for Sewers and Other Gravity-Flow Applications

**TABLE 3 Recommendations for Installation and Use of Soils and Aggregates for Foundation and Pipe-Zone Embedment**

Soil Class <sup>A</sup>	Class I <sup>B</sup>	Class II	Class III	Class IV
General Recommendations and Restrictions	Acceptable and common where no migration is probable or when combined with a geotextile filter media. Suitable for use as a drainage blanket and under drain where adjacent material is suitably graded or when used with a geotextile filter fabric (see X1.8).	Where hydraulic gradient exists check gradation to minimize migration. Clean groups are suitable for use as a drainage blanket and underdrain (see Table 2). Uniform fine sands (SP) with more than 50 % passing a #100 sieve (0.006 in., 0.15 mm) behave like silts and should be treated as Class IV soils.	Do not use where water conditions in trench prevent proper placement and compaction. Not recommended for use with pipes with stiffness of 9 psi or less.	Difficult to achieve high-soil stiffness. Do not use where water conditions in trench prevent proper placement and compaction. Not recommended for use with pipes with stiffness of 9 psi or less.
Foundation	Suitable as foundation and for replacing over-excavated and unstable trench bottom as restricted above.	Suitable as foundation and for replacing over-excavated and unstable trench bottom as restricted above. Install and compact in 12 in. (300 mm) maximum layers.	Suitable for replacing over-excavated trench bottom as restricted above. Install and compact in 6 in. (150 mm) maximum layers.	Suitable for replacing over-excavated trench bottom as restricted above. Install and compact in 6-in (150 mm) maximum layers.
Pipe Embedment	Suitable as restricted above. Work material under pipe to provide uniform haunch support.	Suitable as restricted above. Work material under pipe to provide uniform haunch support.	Suitable as restricted above. Difficult to place and compact in the haunch zone.	Suitable as restricted above. Difficult to place and compact in the haunch zone.
Embedment Compaction: Min Recommended Percent Compaction, SPD <sup>D</sup>	See Note <sup>C</sup>	85 % (SW and SP soils) For GW and GP soils See Note <sup>E</sup>	90 %	95 %
Relative Compactive Effort Required to Achieve Minimum Percent Compaction	Low	Moderate	High	Very high
Compaction Methods	Vibration or impact	Vibration or impact	Impact	Impact
Required Moisture Control	None	None	Maintain near optimum to minimize compactive effort	Maintain near optimum to minimize compactive effort

<sup>A</sup> Class V materials are unsuitable as embedment. They may be used as final backfill as permitted by the engineer.

<sup>B</sup> Class I materials have higher stiffness than Class II materials, but data on specific soil stiffness of placed, uncompacted Class I materials can be taken equivalent to Class II materials compacted to 95% of maximum standard Proctor density (SPD95), and the soil stiffness of compacted Class I materials can be taken equivalent to Class II materials compacted to 100% of maximum standard Proctor density (SPD100). Even if placed uncompacted (that is, dumped), Class I materials should always be worked into the haunch zone to assure completed placement.

<sup>C</sup> Suitable compaction typically achieved by dumped placement (that is, uncompacted but worked into haunch zone to ensure complete placement).

<sup>D</sup> SPD is standard Proctor density as determined by Test Method D698.

<sup>E</sup> Place and compact GW and GP soils with at least two passes of compaction equipment.

**FIGURE 7.4  
BEDDING ANGLE**

From Uni-Bell Handbook of PVC Pipe: Design and Construction, Fourth Edition (2001)

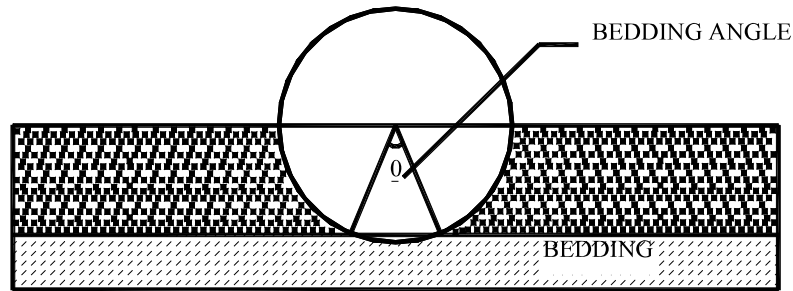

**TABLE 7.1  
PVC PIPE STIFFNESS (psi)**

<u>DR or SDR</u>	<u>Min. E = 400,000 psi</u>	<u>Min. E = 500,000 psi</u>
64	7	9
51	14	18
42	26	32
41	28	35
35	46	57
33.5	52	65
32.5	57	71
28	91	114
26	115	144
25	129	161
21	224	279
18	364	455
17	437	546
14	815	1,019
13.5	916	1,145

**TABLE 7.2  
VALUES OF BEDDING CONSTANT, K**

<u>BEDDING ANGLE (DEGREES)</u>	<u>K</u>
0	0.110
30	0.108
45	0.105
60	0.102
90	0.096
120	0.090
180	0.083



# **APPENDIX B (SOIL UNIT WEIGHT VALUES)**



January 14, 2009

**Raba-Kistner Consultants, Inc.**  
 12821 W. Golden Lane  
 P.O. Box 690287, San Antonio, TX 78269-0287  
 (210) 699-9090 • FAX (210) 699-6426  
 www.rkci.com

Charles P. "Frosty" Forster, P.E., P.G.  
 Pape Dawson Engineers  
 555 East Ramsey  
 San Antonio, Texas 78216

**RE: Soil Unit Weight Values for Backfill Materials  
 Various Projects  
 San Antonio, Texas**

Dear Mr. Forster:

**Raba-Kistner Consultants Inc. (R-K)** is pleased to submit this letter providing general guidance for selecting design soil unit weights for use in utility trench design.

In general, the following table contains a list of the frequently used trench backfill materials in the San Antonio area. The table also contains approximate values for the soil dry unit weight, moist unit weight and saturated unit weight for these materials assuming 90 to 95 percent compaction utilizing a standard Proctor (ASTM D 698.)

MATERIAL DESCRIPTION	DRY UNIT WEIGHT, PCF	MOIST UNIT WEIGHT, PCF	SATURATED UNIT WEIGHT, PCF
TxDOT TEX-113E Type A, Gr. 1 or 2	130	137	143
TxDOT TEX-113E Type A, Gr. 3 thru 5	128	135	143
Limestone Millings	115	124	134
Gravelly Clay	110	120	132
Clay	100	120	127
Clayey Sand	95	106	123
Gravel (Clean)	115	120	134
Sand (Clean)	92	98	120
Pit Run Gravel	127	137	142

We appreciate the opportunity to be of service to you. If you have any questions or need additional assistance, please call.

Very truly yours,

**RABA-KISTNER CONSULTANTS, INC.**

*[Handwritten Signature]*  
 1/14/09

Chris L. Schultz, P.E.  
 Senior Vice President

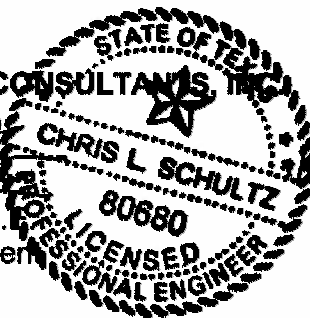

CLS/mem

**APPENDIX C (STANDARD SPECS  
AND PRE-CAST MANHOLES  
SPECS)**

# 48" Dia. Concentric Cones

18" Yeild

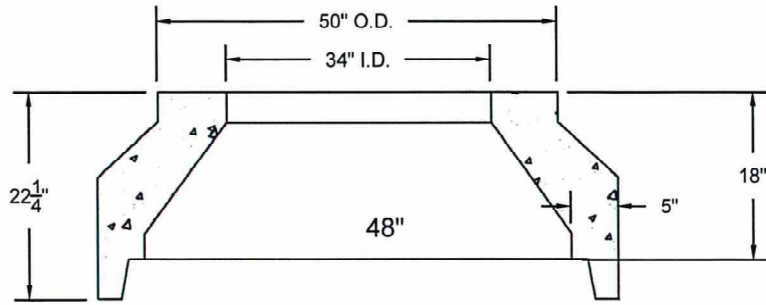

24" Yeild

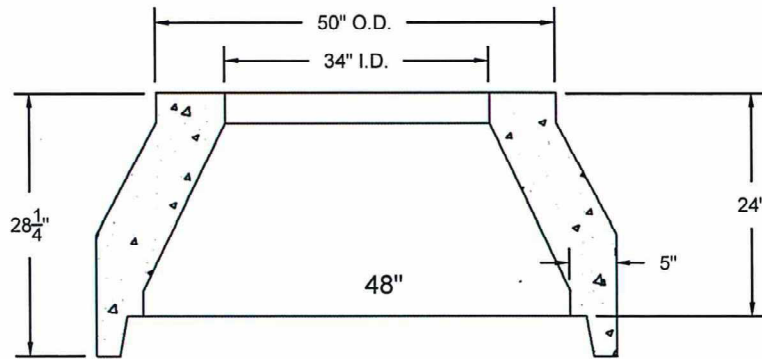

32" Yeild

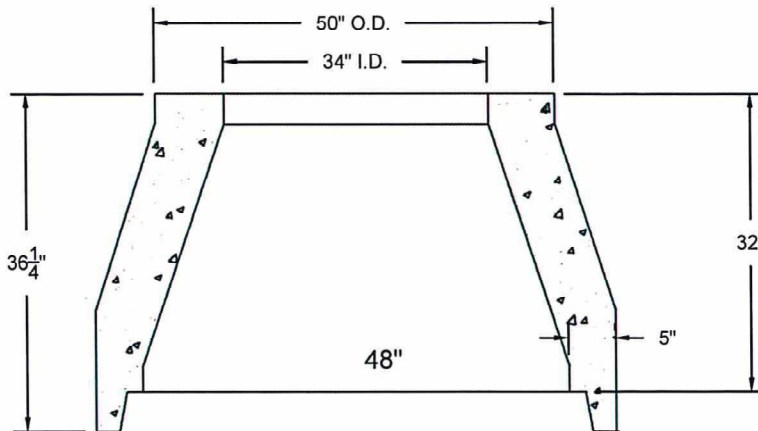

**NOTES:**

1. Concrete: 4,000 PSI, 28 day Strength. Exceeds ASTM C - 478 - 11
2. Welded wire fabric strength  $f_y = 65,000$  psi.
3. Live Load - AASHOT HS-20.

*Charlotte's  
Concrete, Inc.*

Charlotte's Concrete, Inc.

4950 Lane Dr.  
San Antonio, Tx. 78263  
Ph. (210) 648-4774



FOR 18", 24" & 32" Concentric Cones

JOB

DRAWN BY CA

DATE 08-06-15

REV. NO. -

SHEET

1 of 1

FILE

**PRE-CAST MANHOLE  
DRAWINGS &  
SPECIFICATIONS**



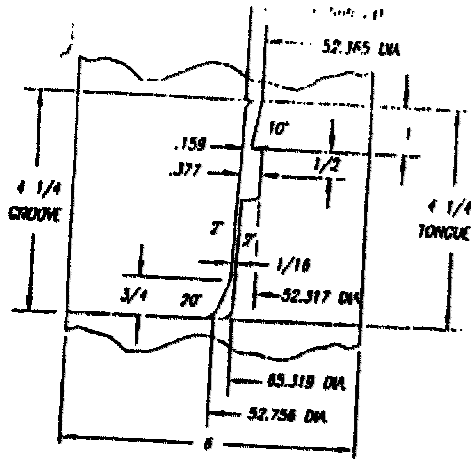

7/8" STYLE RING  
SCALE: 3/8"=1

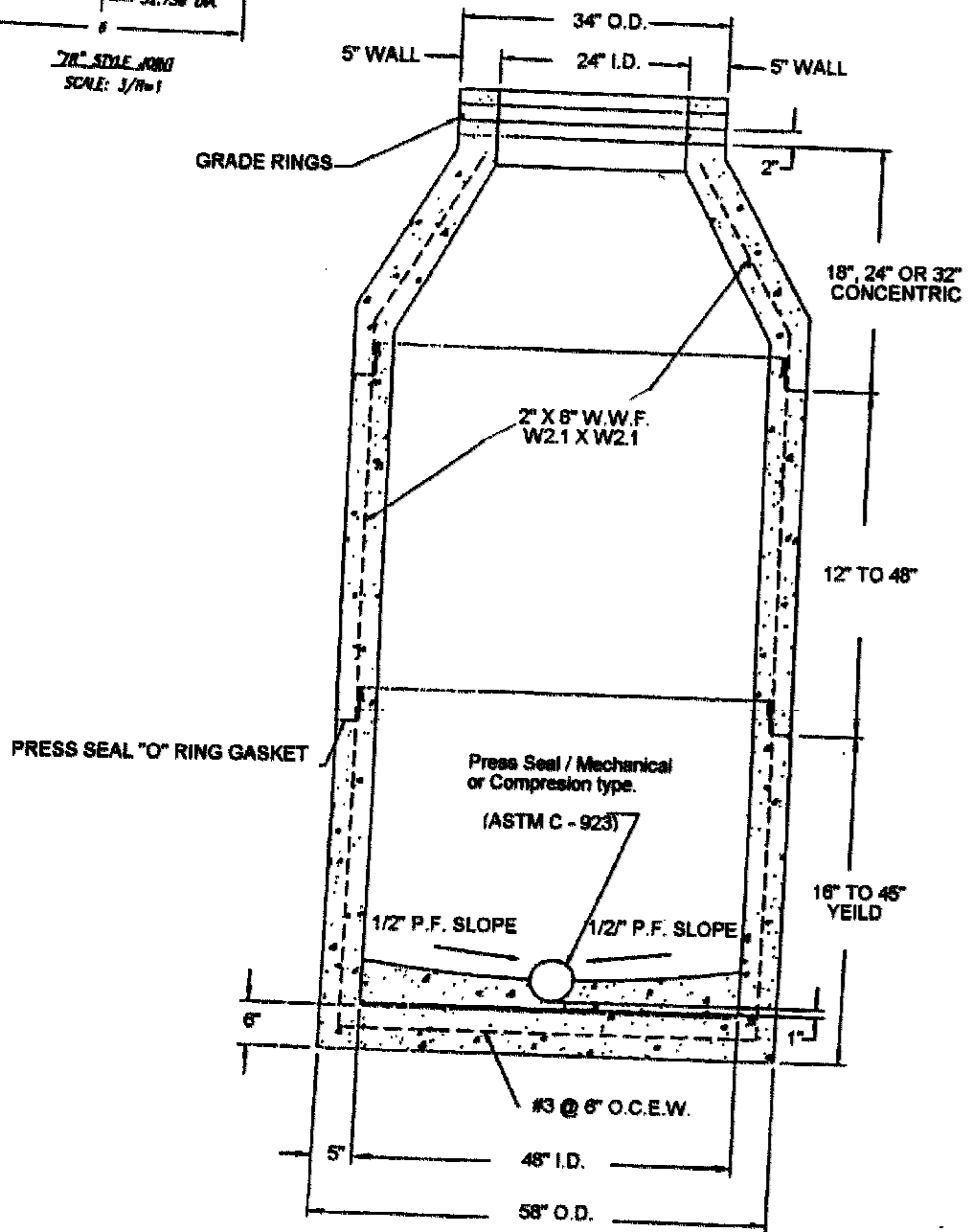

ALL MATERIALS MEET  
OR EXCEED ASTM C-476

CHARLOTES CONCRETE
48" x 48" BUREAU/STOCK-UP
1/2" FLAT TOP IN FRONT
CHARLOTES

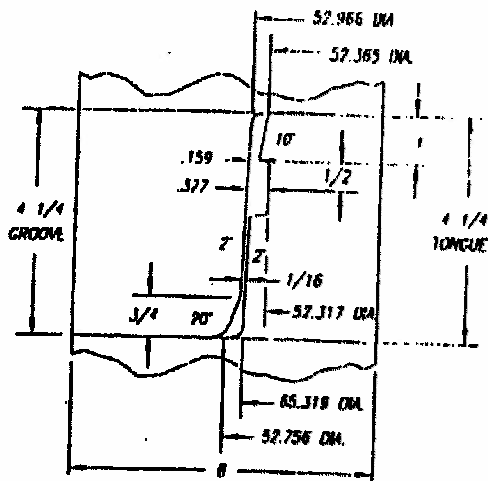

7 1/2" STEEL PIPE  
SCALE: 3/8"=1"

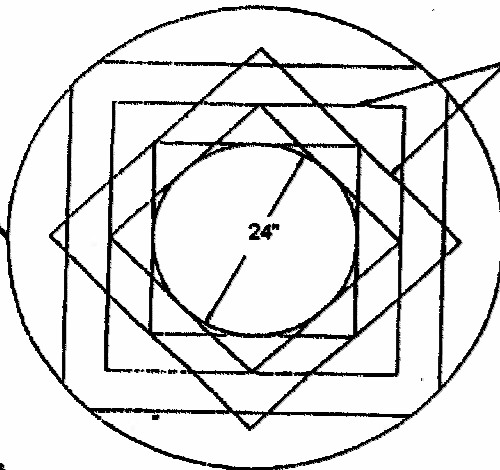

Slab Top w/ "O" Ring

#5 Bars @ 5" O.C.E.W.

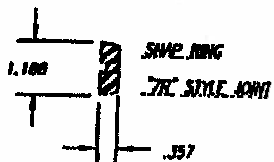

Grade Rings

Flattop Slab

Manhole R & C

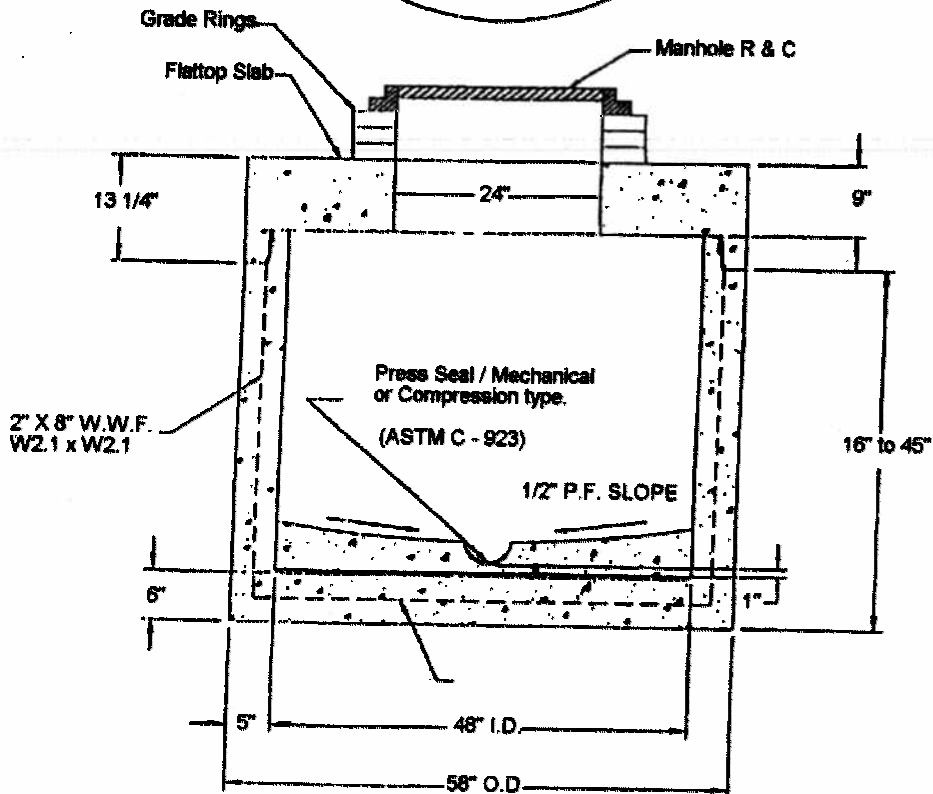

13 1/4"

24"

9"

2" X 8" W.W.F.  
W2.1 x W2.1

Press Seal / Mechanical  
or Compression type.  
(ASTM C - 923)

1/2" P.F. SLOPE

16" to 45"

6"

48" I.D.

58" O.D.

NO. OF COPIES	1
DATE	11/15/78
BY	CHARLOTTE
FOR	CHARLOTTE CONCRETE
DESCRIPTION	48" x 45" BASE/STACK-UP w/ FLAT TOP 7 1/2" DIA. PIPE
SCALE	AS SHOWN
PROJECT	CHARLOTTE

Concrete @ 4000 psi  
Steel Grade 60  
ASTM C - 478  
H - 20 Traffic Rated

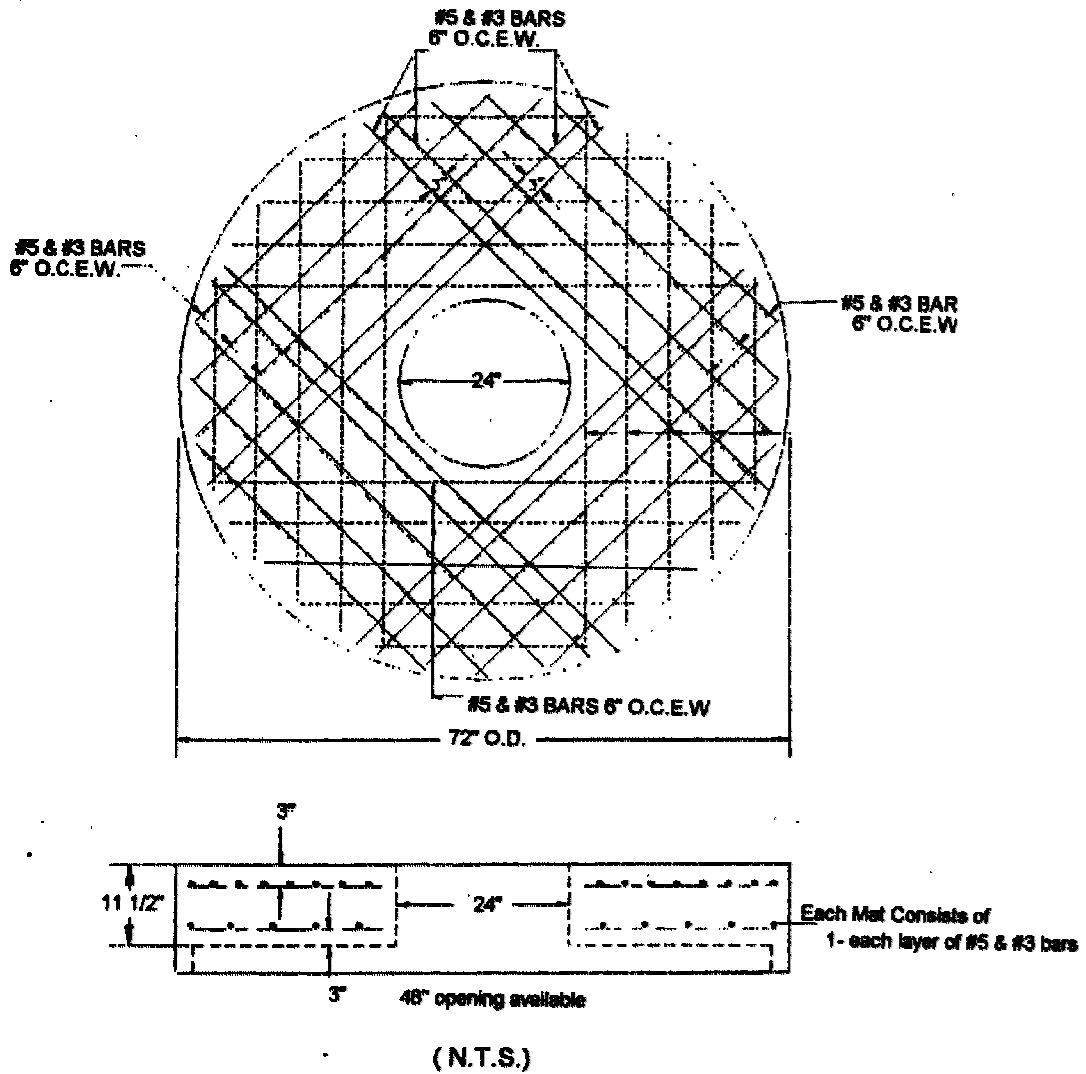

Charlotte's Concrete, Inc.

60" I.D.  
FLATTOP SLAB

CONCRETE @ 4000psi  
 STEEL GRADE 60  
 ASTM C - 478  
 H - 20 TRAFFIC RATED

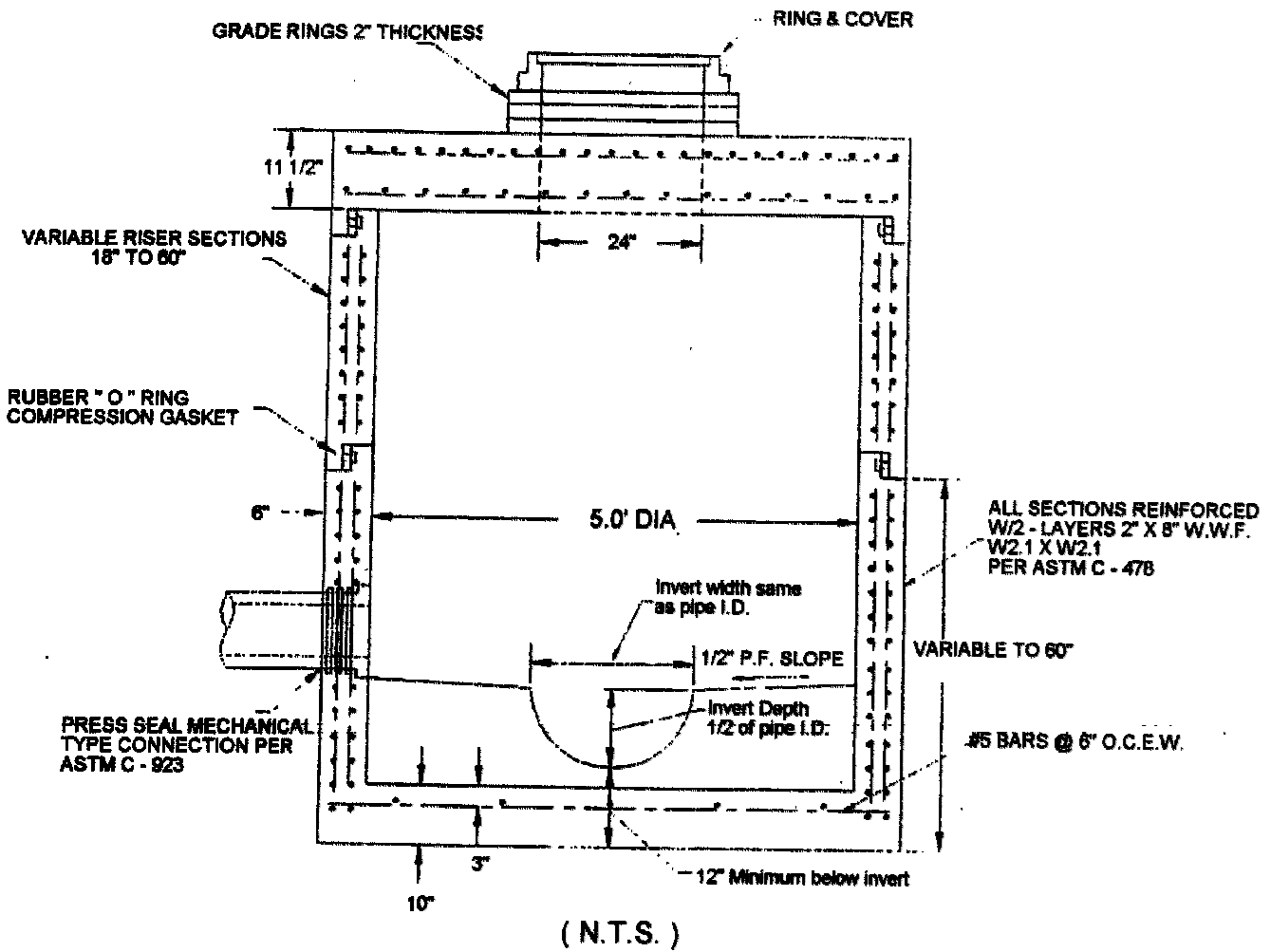

Charlotte's Concrete, Inc.

60" DIA. MANHOLE  
W/ FLATTOP

**CONCRETE @ 4000psi**  
**STEEL GRADE 60**  
**ASTM C - 478**  
**H - 20 TRAFFIC RATED**

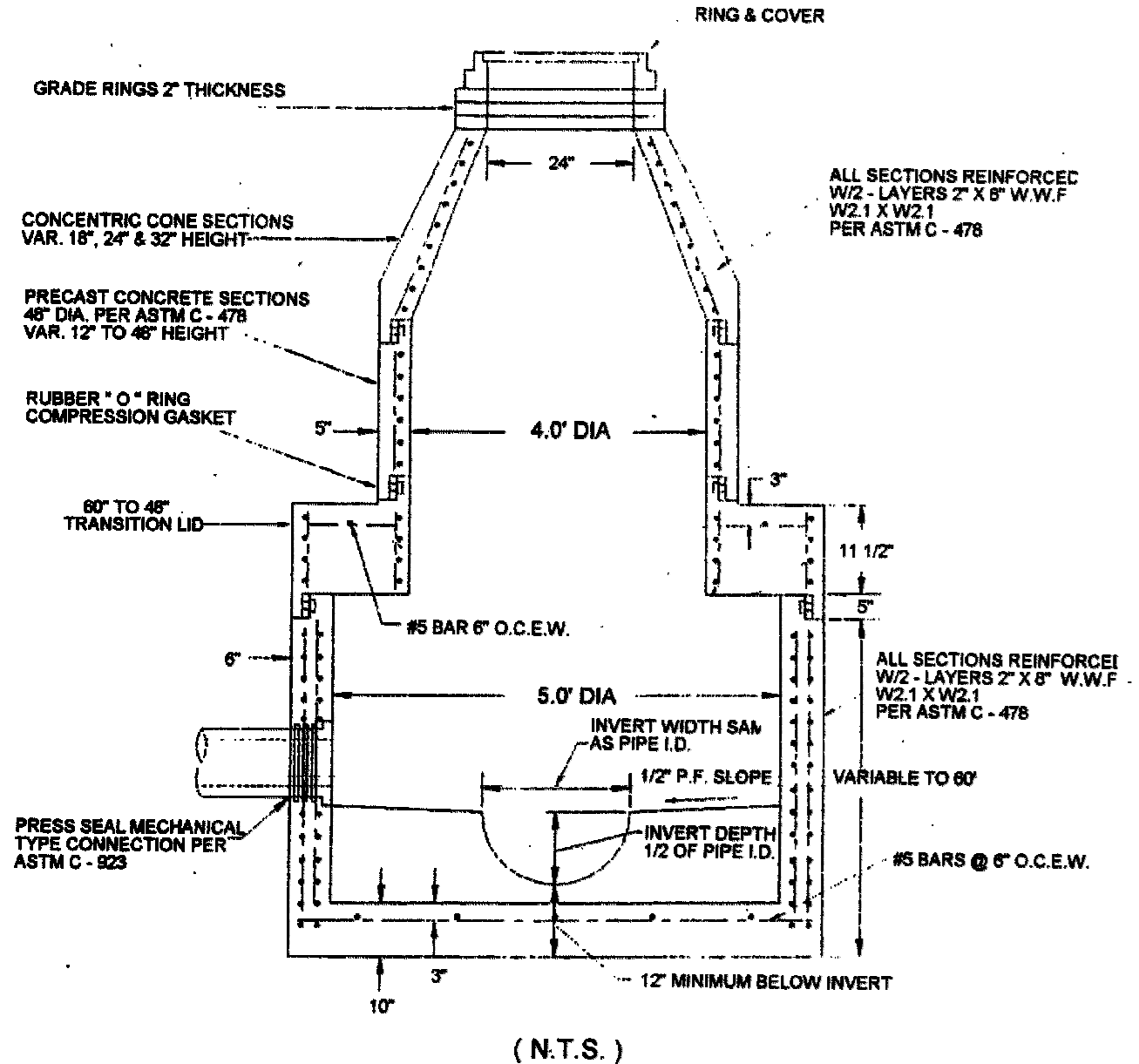

Charlotte's Concrete, Inc.

60" DIA. M.H. TO  
 48" DIA. M.H.



Concrete @ 4000 psi  
Steel Grade 60  
ASTM C - 478  
H - 20 Traffic Rated

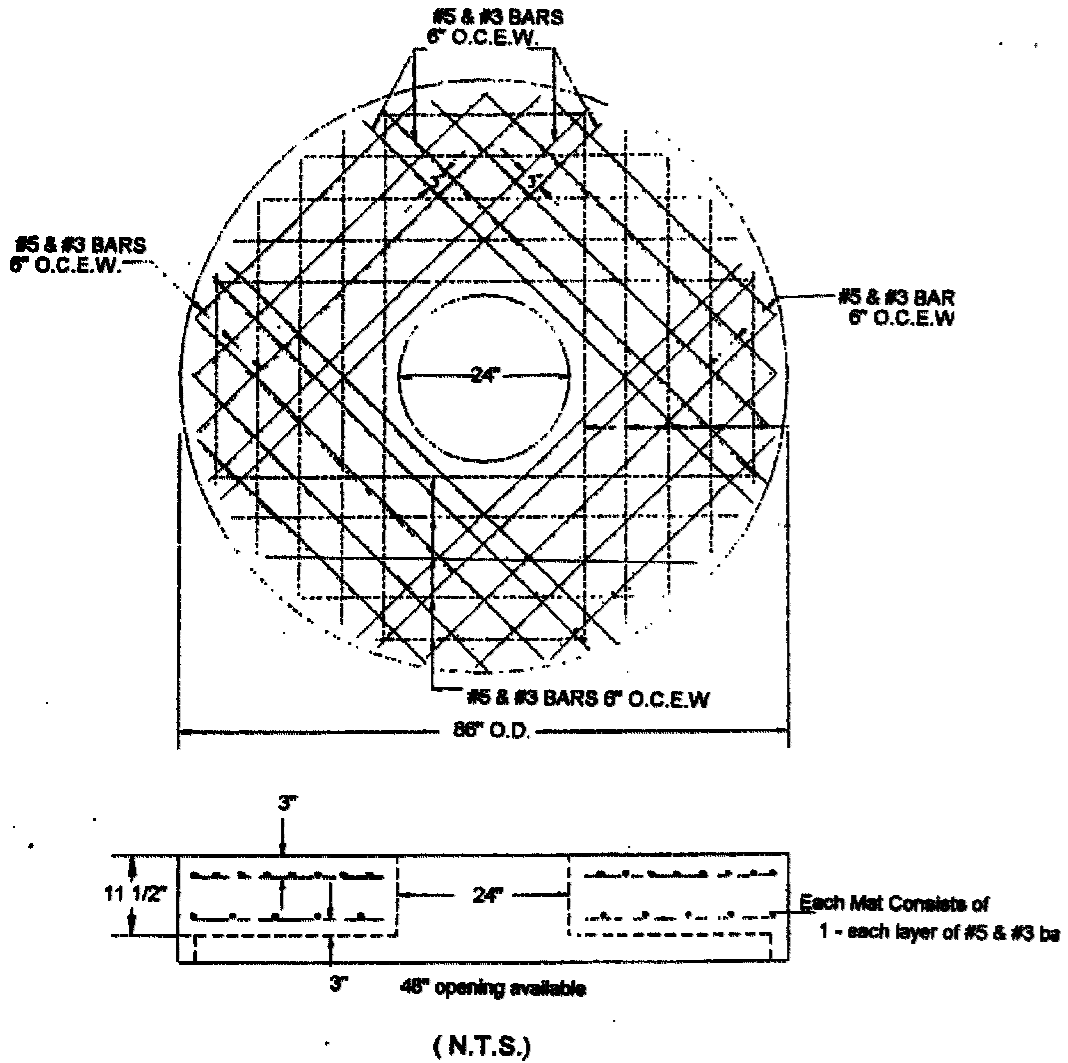

Charlotte's Concrete, Inc.

72" I.D.  
FLATTOP SLAB

CONCRETE @ 4000psi  
STEEL GRADE 60  
ASTM C - 478  
H - 20 TRAFFIC RATED

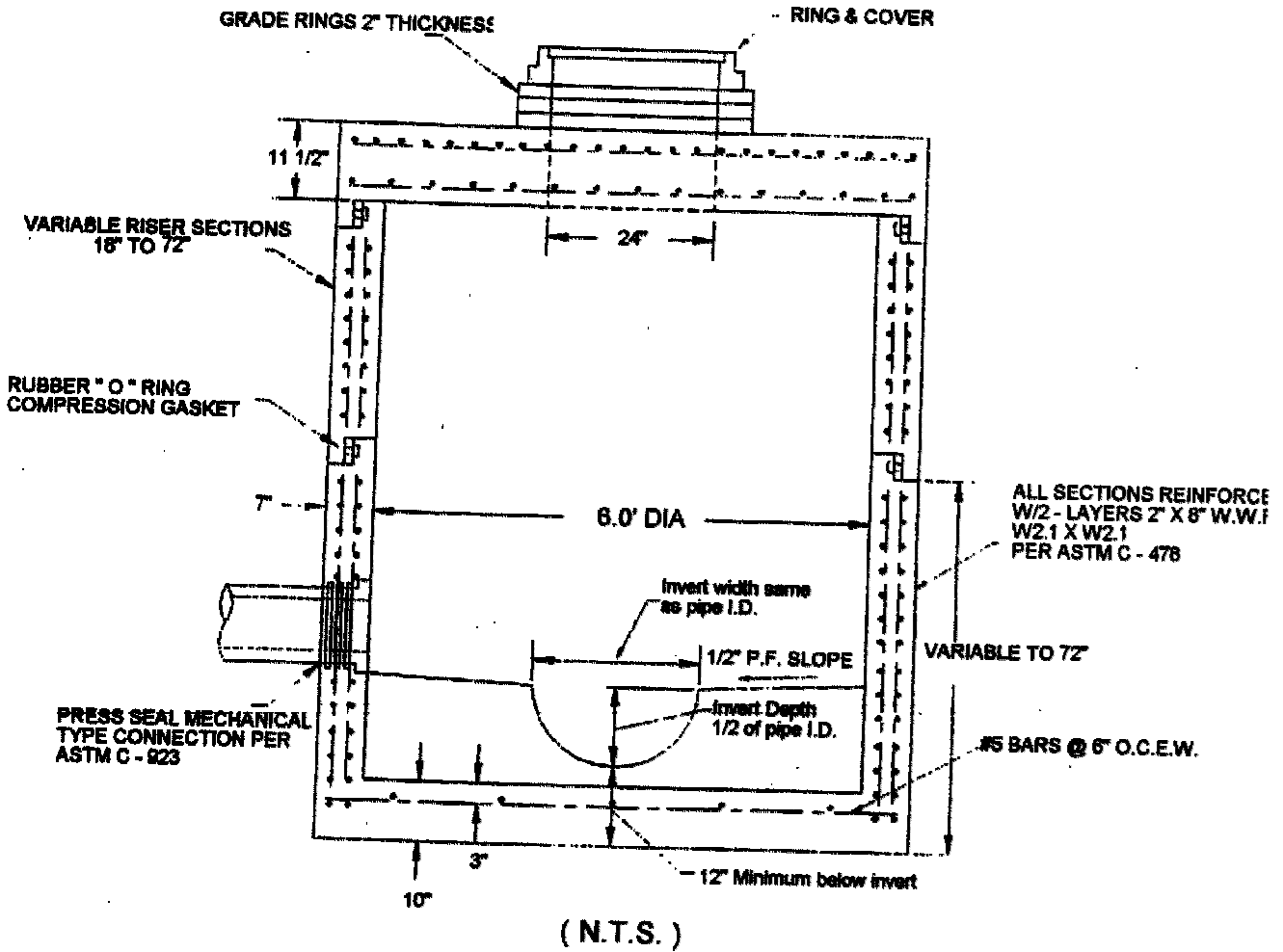

Charlotte's Concrete, Inc.

72" DIA. MANHOLE  
W/ FLATTOP

**CONCRETE @ 4000psi**  
**STEEL GRADE 60**  
**ASTM C - 478**  
**H - 20 TRAFFIC RATED**

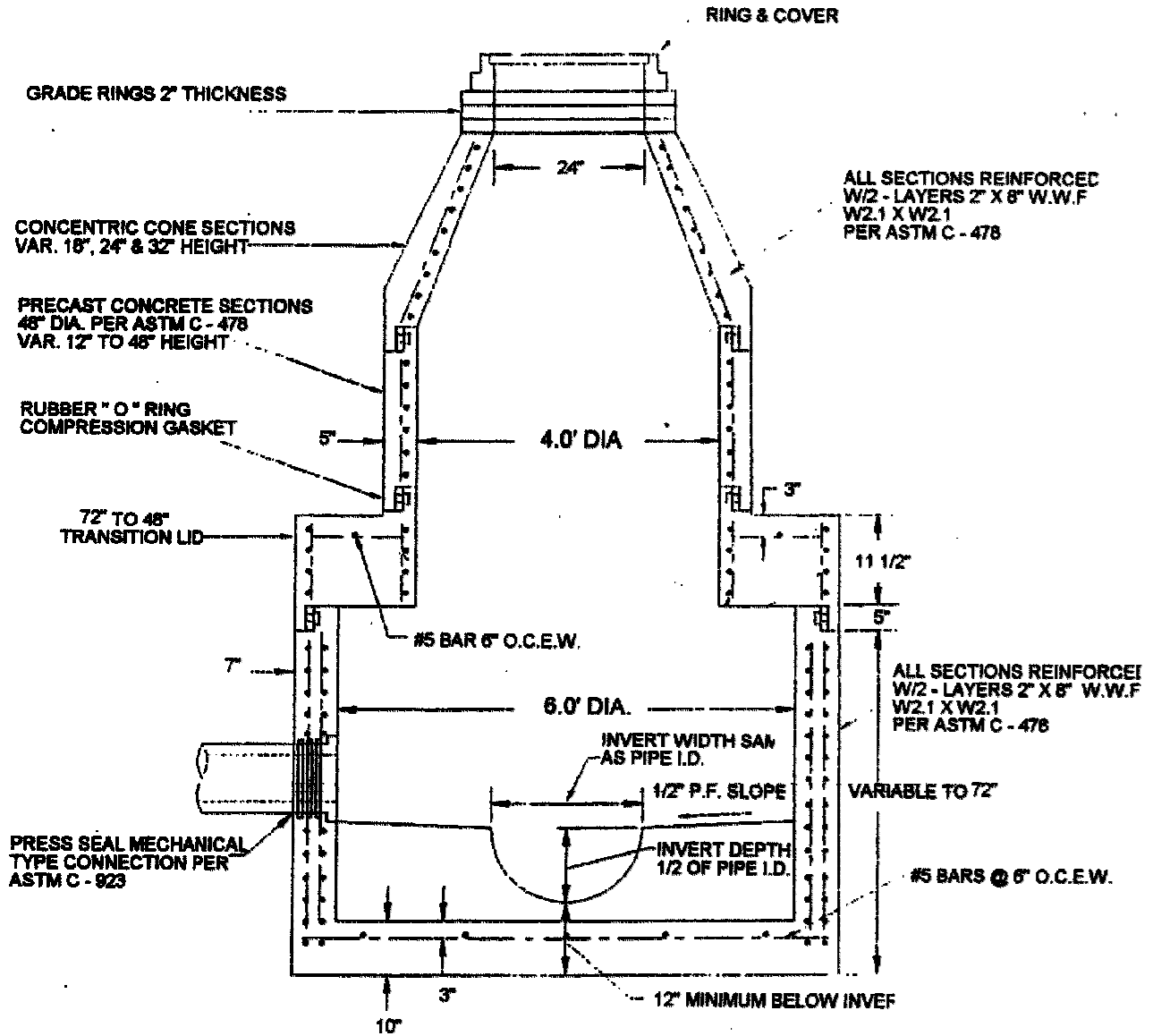

( N.T.S. )

Charlotte's Concrete, Inc.

72" DIA. M.H. TO  
 48" DIA. M.H.

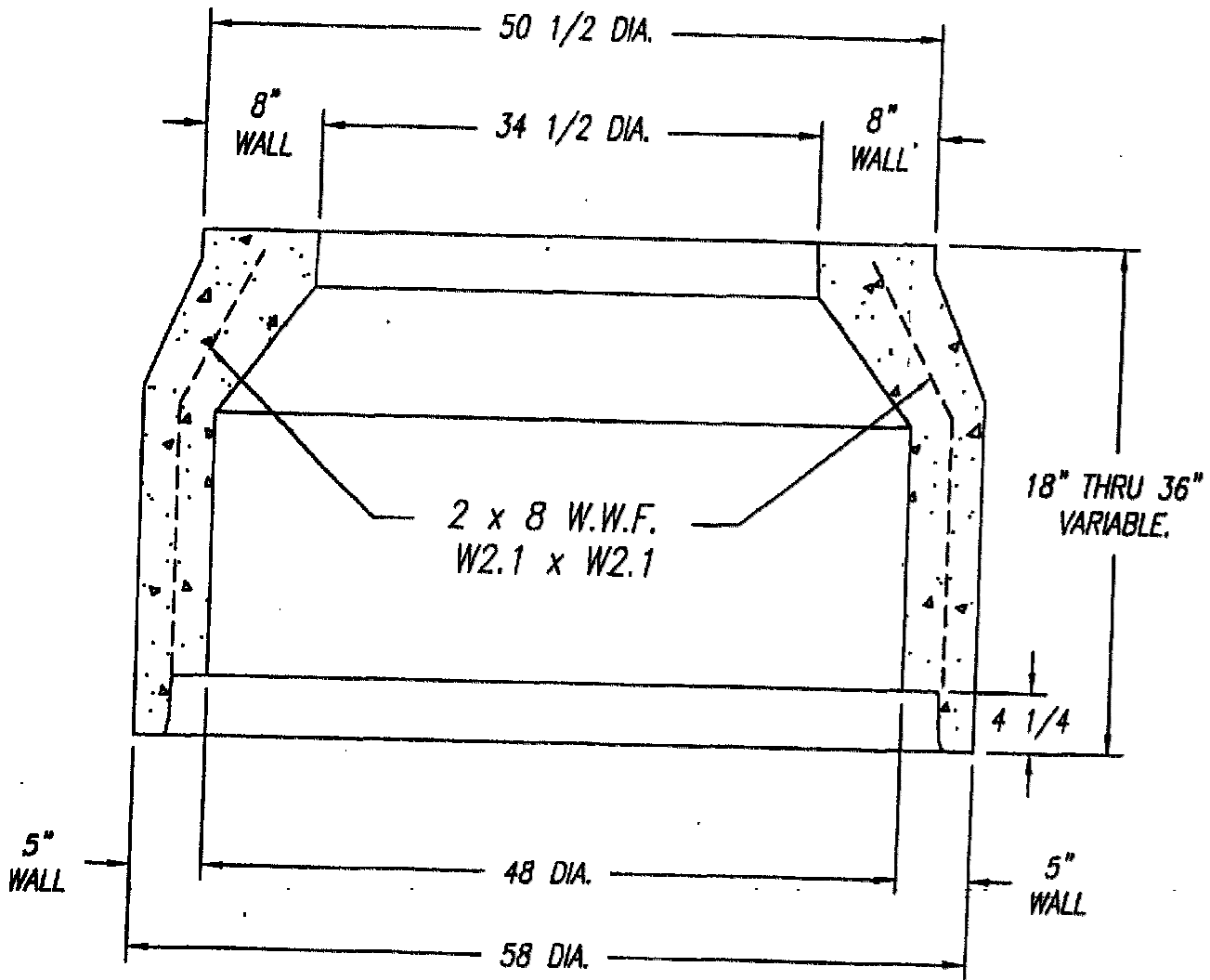

(7R JOINT)

REF. FORM DWG. 3-303-5561

		<p><b>QUINN</b> MACHINE &amp; FOUNDRY CORP. A MEMBER OF THE BIESSEY FAMILY OF COMPANIES BOONE, IOWA U.S.A.</p>	
<p><small>THIS PRINT IS THE PROPERTY OF INTERNATIONAL PIPE MACHINERY CORP. IT IS CONFIDENTIAL AND NOT TO BE REPRODUCED WITHOUT OUR EXPRESSED PERMISSION AND MUST BE RETURNED UPON REQUEST.</small></p>			
<p><b>CHARLOTTE'S</b></p>			
<p>48 x 5 x 34 1/2 x 8 x 36 &amp; 18 CONCENTRIC CONCRETE SECTION</p>			
DRAFTER	JJK	4/19/02	REV.
CHECKED			
<p>SCALE: 1/16" = 1"</p>			<p><b>CONCENTRIC</b></p>

# Precast Manholes

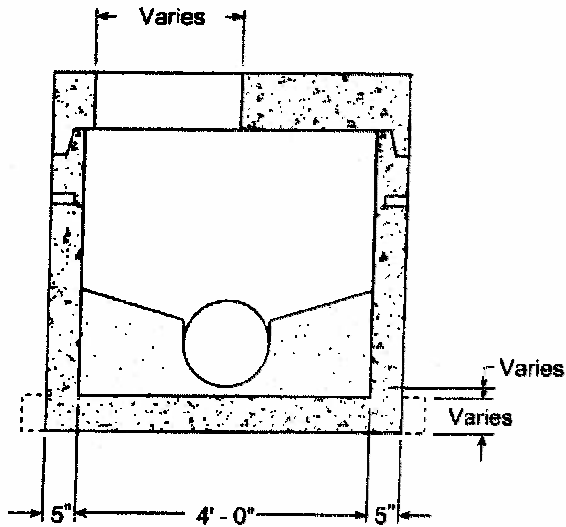

**Flattop Illustration**  
for Shallow Manhole

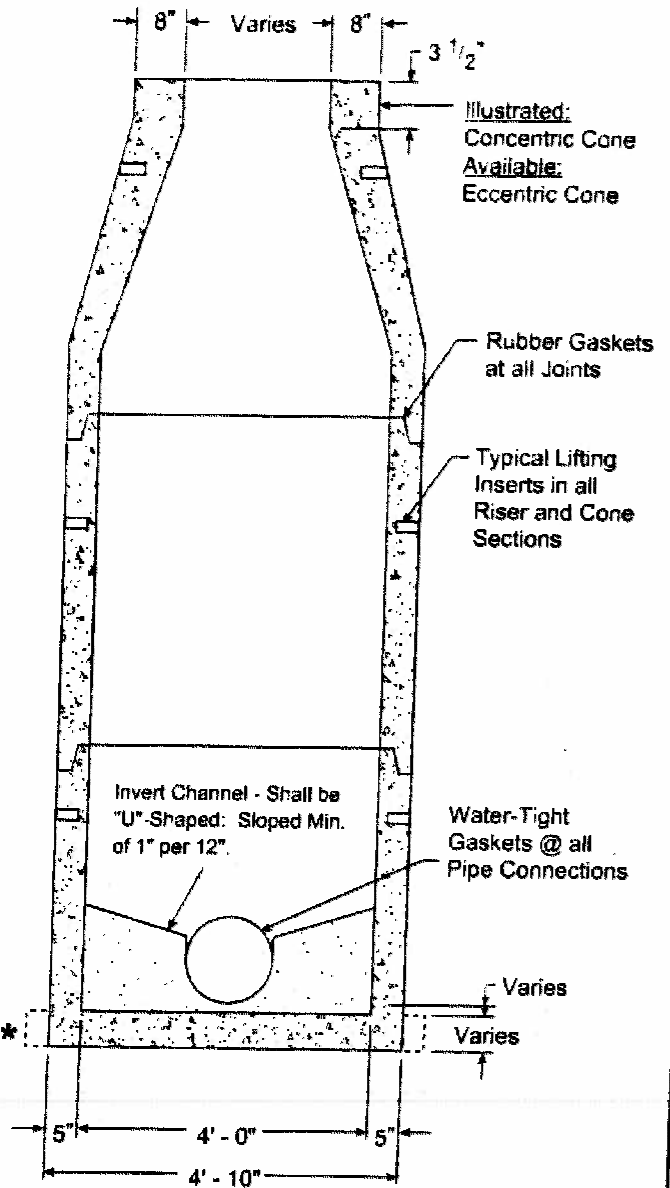

**Section View**  
4' I.D. Manhole - Regular Base  
with Reducing Cone

## Materials & Features

HOLES AS SPECIFIED: Max diameter = 32"  
 CONCRETE: 5,000 PSI, 28 day strength.  
 REINFORCING: Meets or exceeds ASTM C478 requirements.  
 Average weight of 24" depth base w/8" invert = 4,500 lbs.  
 Estimated weight of riser and cone sections = 870 lbs. / vt. ft.

\* - Extended base is available to meet local requirements.

In the event a boot is loose contact your Hanson representative to resolve.

*"Manufactured to your specifications."*

-No Scale-  
 All dimensions subject to allowable specification tolerances.

TITLE	PLANT	STATE	SECTION/PAGE	DATE	
4' I.D. Manhole Regular Base w/ Reducing Cone	All Plants	TX	5.5	08-15-06	

Contact Hanson

Go to Index

EXIT

# Precast Manholes

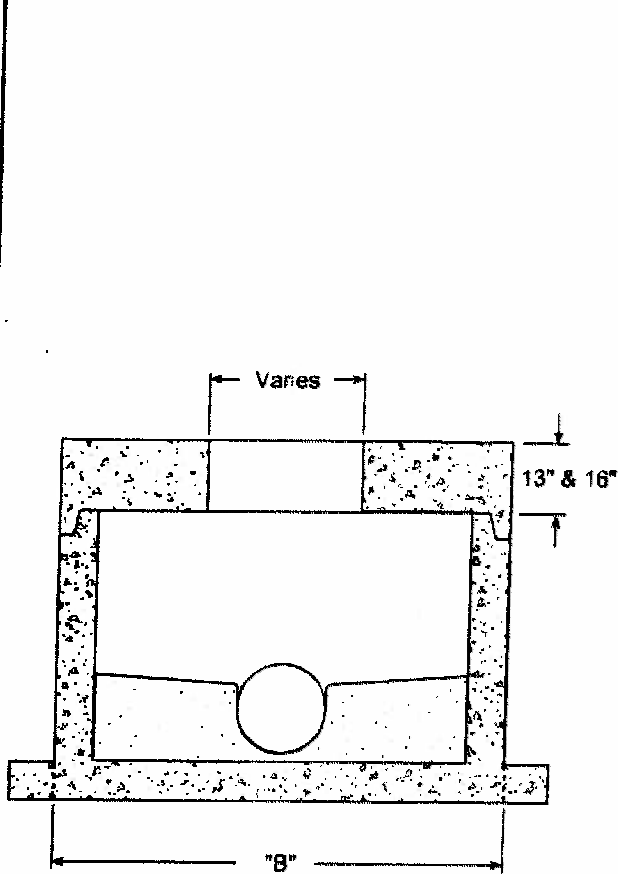

**Flattop Illustration**  
for Shallow Manhole

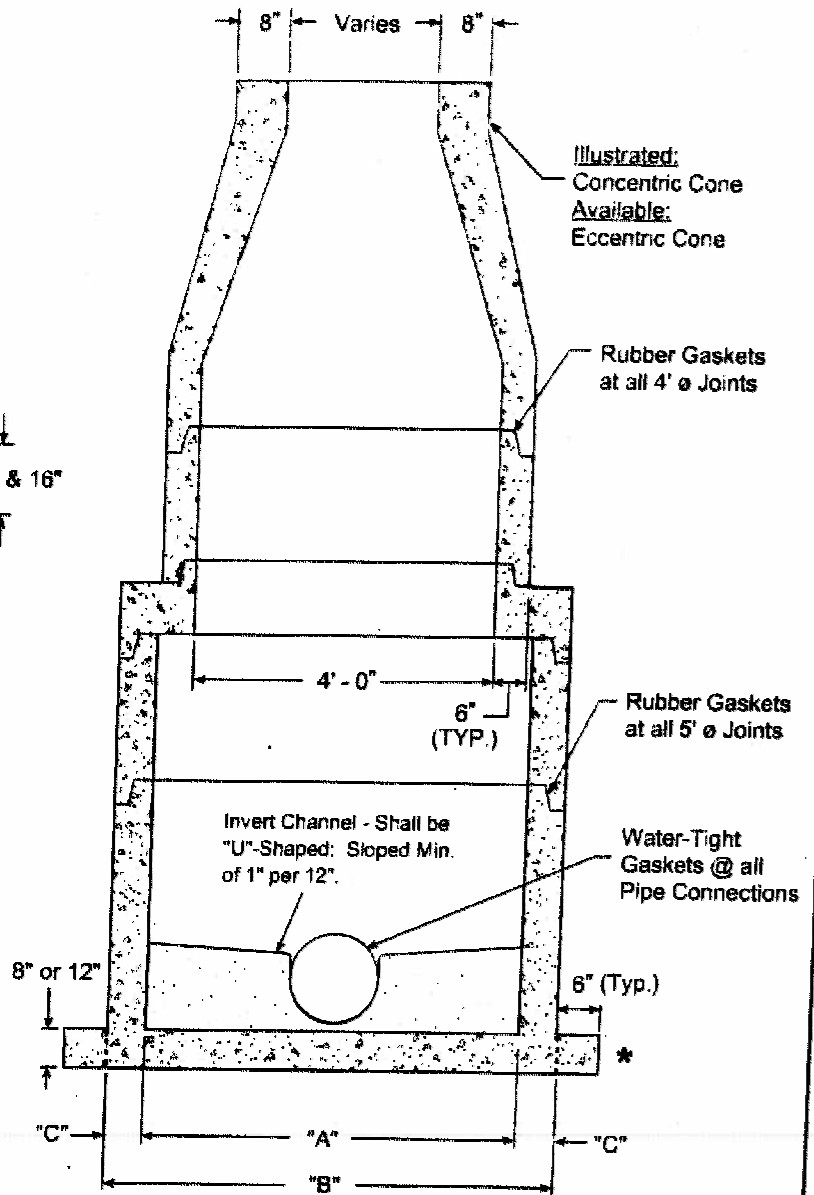

**Section View**  
5' 1/4' & 6' 1/4' I.D. Manhole  
Extended Base with Reducing Cone

## Materials & Features

**HOLES AS SPECIFIED:** for 5' I.D. max diameter = 40"  
for 6' I.D. max diameter = 54"

**CONCRETE:** 5,000 PSI, 28 day strength.

**REINFORCING:** Meets or exceeds ASTM C478 requirements.

Average weight of 24" depth base w/8" invert:

for 5' I.D. = 7,500 lbs.

for 6' I.D. = 10,600 lbs.

Estimated weight of riser and sections:

for 5' I.D. = 1,325 lbs. / vt. ft.

for 6' I.D. = 1,800 lbs. / vt. ft.

For pipe sizes 15" and larger, invert shall be equal to the larger pipe diameter.

\* - Extended base shown; Regular base also available."

In the event a boot is loose contact your Hanson representative to resolve.

*"Manufactured to your specifications."*

Pipe Size	I.D. "A"	O.D. "B"	Wall Thk. "C"
5'	5' - 0"	6' - 0"	6"
6'	6' - 0"	7' - 2"	7"

-No Scale-  
All dimensions subject to allowable specification tolerances.

TITLE	PLANT	STATE	SECTION/PAGE	DATE	
5' 1/4' & 6' 1/4' I.D. Manhole Extended Base w/Reducing Cone	All Plants	TX	5.6	08-15-06	

Contact Hanson

Go to Index

EXIT



# Precast Manholes

For Pipe Entering the Manhole at Excessive Depths Above the Flow Line Out, the Contractor May be Responsible for Grout Work Necessary to Bring Channel up to Flow Line on Inlet Pipe.

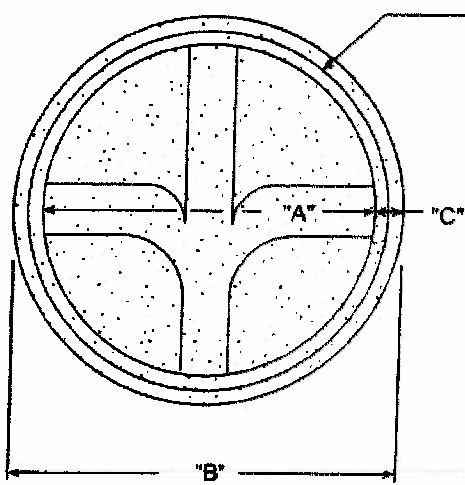
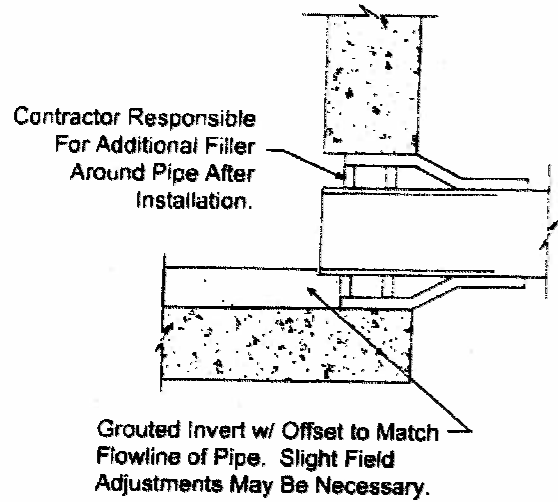

**Plan View**

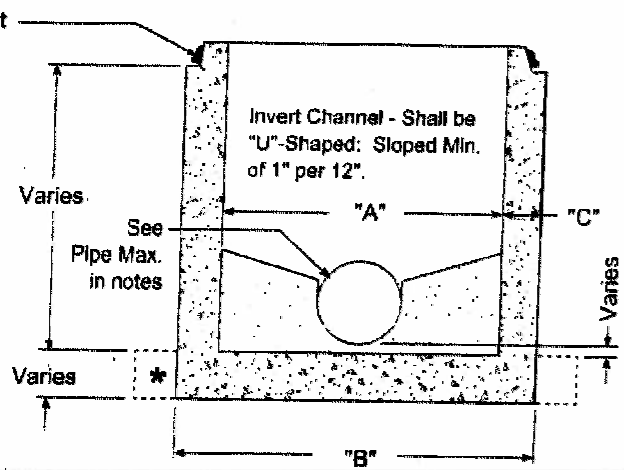

**Section View**

## Materials & Features

### HOLES AS SPECIFIED:

- For 4' I.D. max. diameter = 32"
- For 5' I.D. max. diameter = 40"
- For 6' I.D. max. diameter = 54"

CONCRETE: 5,000 PSI, 28 day strength

REINFORCING: Meets or exceeds ASTM C478 requirements.

Average weight of 24" depth base w/8" invert = 4,500 lbs

Water-tight gaskets at all pipe connections.

\* - Regular base shown: Extended base also available.

In the event a boot is loose contact your Hanson representative to resolve.

Pipe Size	I.D. "A"	O.D. "B"	Wall Thk. "C"
4'	4'-0"	4'-10"	5"
5'	5'-0"	6'-0"	6"
6'	6'-0"	7'-2"	7"

-No Scale-  
All dimensions subject to allowable specification tolerances.

TITLE	PLANT	STATE	SECTION/PAGE	DATE	
<b>Details: 4', 5' &amp; 6' I.D. Precast Regular Manhole Base</b>	All Plants	TX	5.7	08-15-06	

Contact Hanson

Go to Index

EXIT

**Precast Manholes**

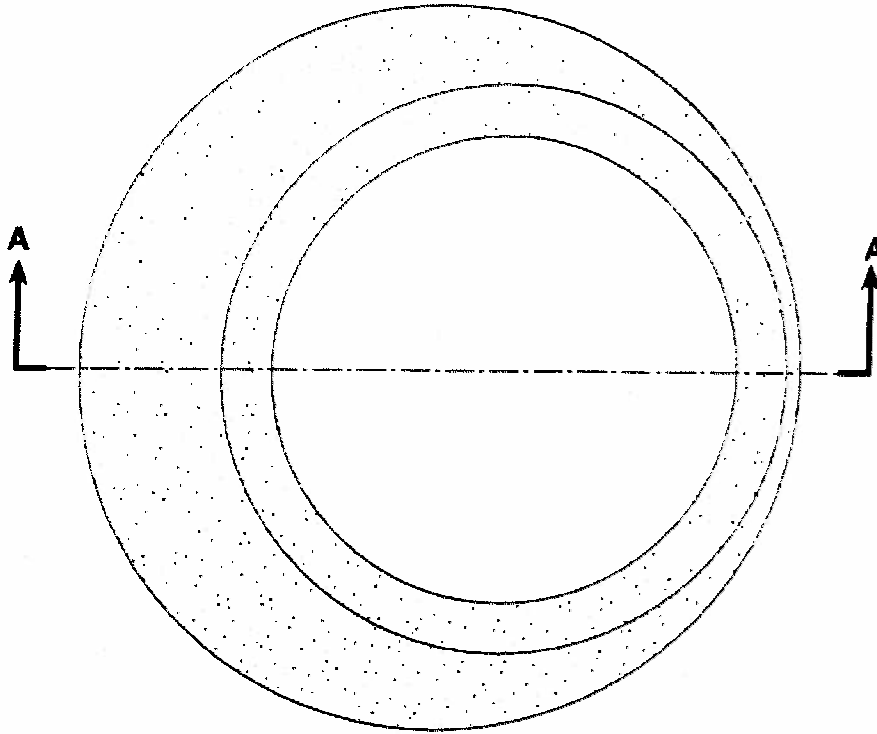

**Plan View**

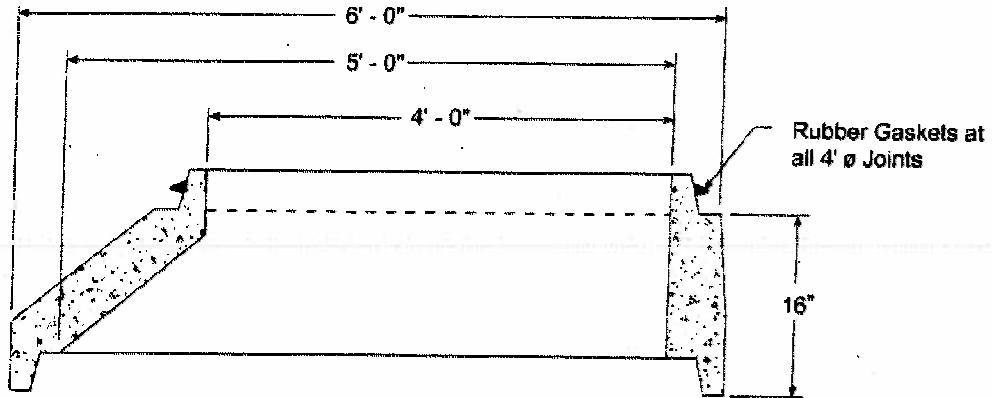

**Section View**

**Materials & Features**

CONCRETE: 5,000 PSI, 28 day strength.  
 REINFORCING: Meets or exceeds ASTM C478 requirements.  
 CONSTRUCTION OF PRECAST is in accordance with ASTM C478.  
 Concrete is poured according to ACI-500.

-No Scale-  
 All dimensions subject to allowable  
 specification tolerances.

TITLE	PLANT	STATE	SECTION/PAGE	DATE
5' x 4' Conical Adaptor	Waco	TX	5 8	08-15-06



Contact Hanson

Go to Index

EXIT

# Precast Manholes

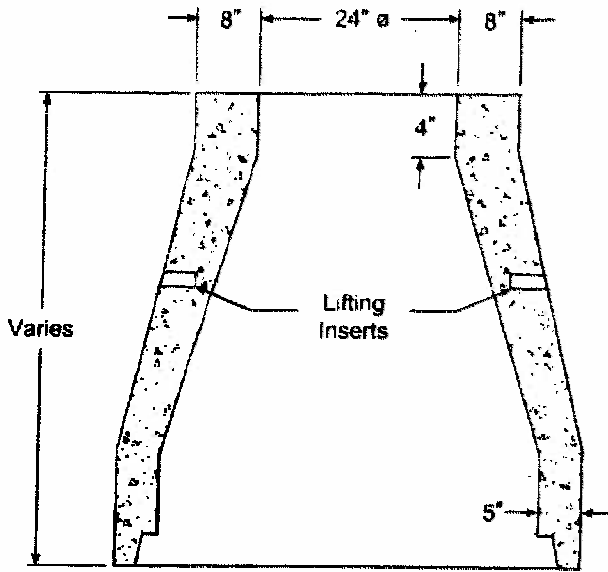

**Concentric Cone**  
24"  $\varnothing$  Opening

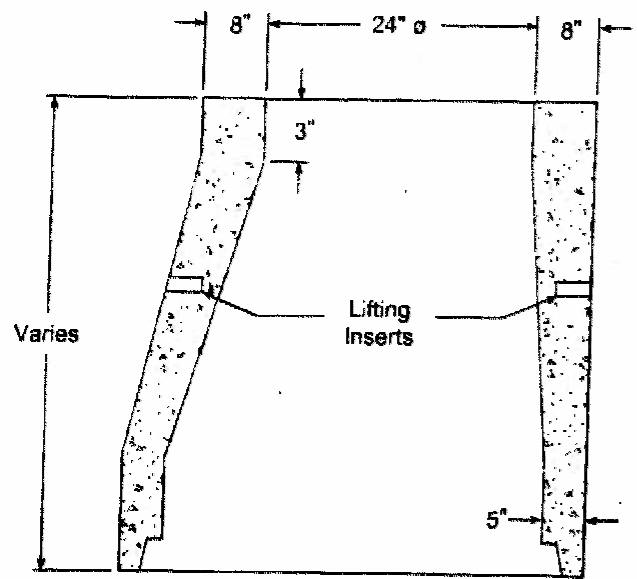

**Eccentric Cone**  
24"  $\varnothing$  Opening

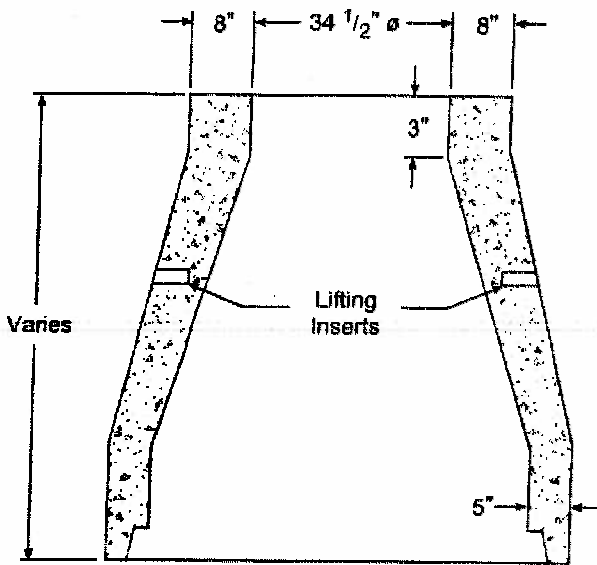

**Concentric Cone**  
34 1/2"  $\varnothing$  Opening

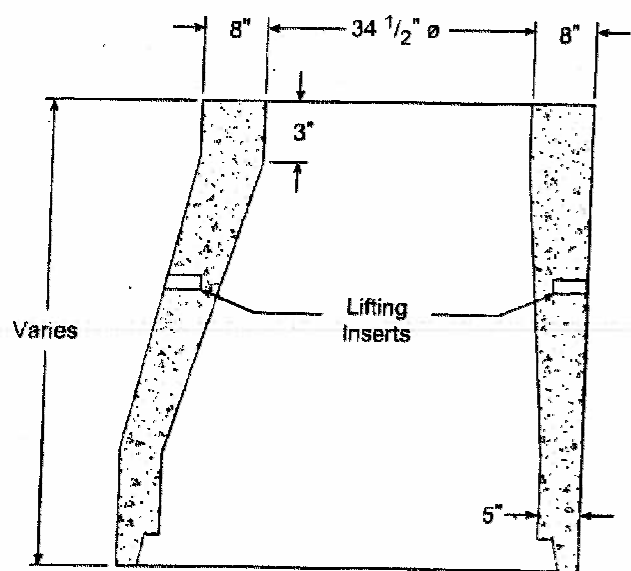

**Eccentric Cone**  
34 1/2"  $\varnothing$  Opening

## Materials & Features

CONCRETE: 5,000 PSI, 28 day strength.  
 REINFORCING: Meets or exceeds ASTM C478 requirements.  
 30"  $\varnothing$  also available in North Texas.

-No Scale-  
 All dimensions subject to allowable specification tolerances.

TITLE	PLANT	STATE	SECTION/PAGE	DATE
Hanson 48" Manhole Reducing Cone Detail	Waco Houston	TX	5.9	08-15-06



Contact Hanson

Go to Index

EXIT

# Precast Manholes

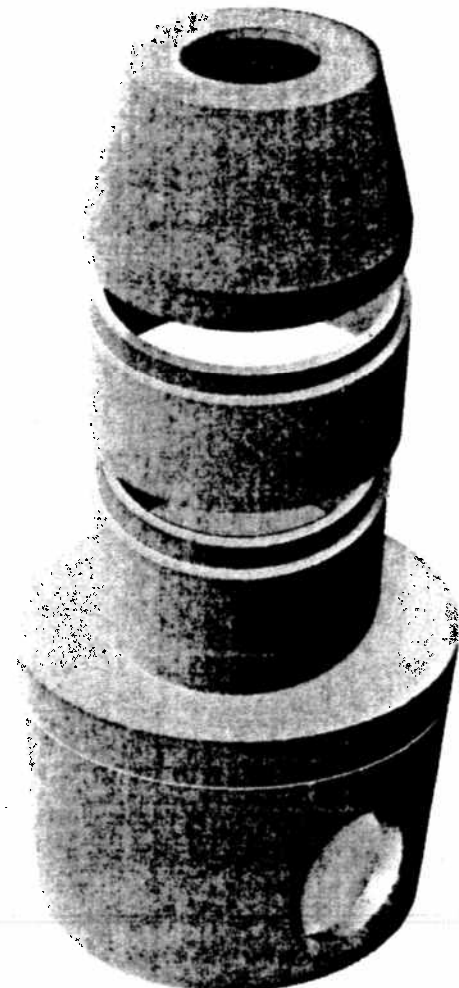
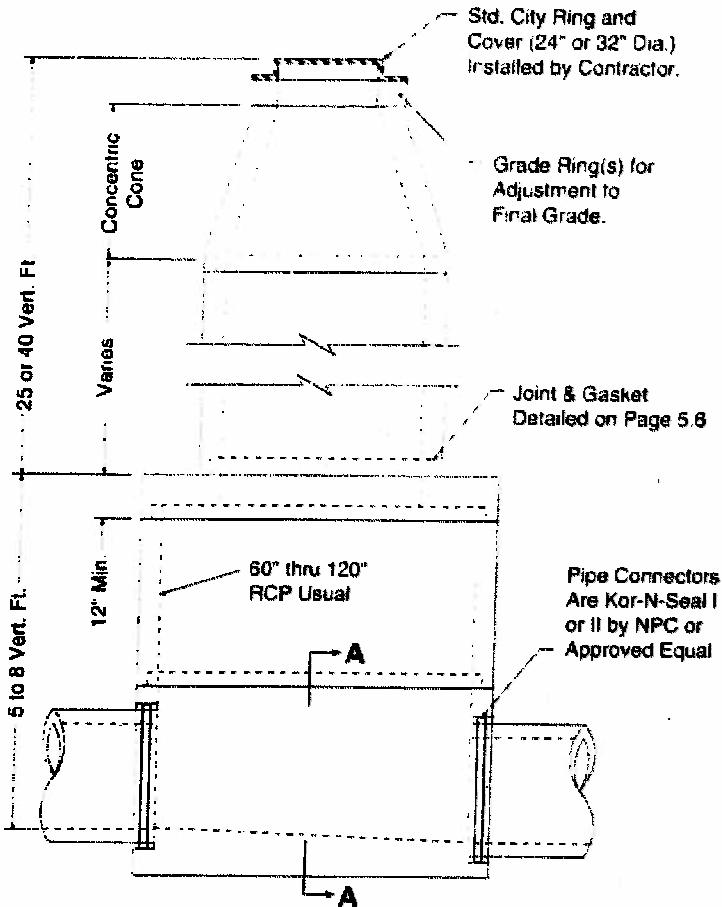

**Isometric View**

**w/ Precast Base**

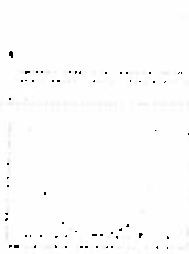

**Section A-A**

**Base Slab Reinforcing**

**30' Deep Structure**

- 60"ø - 8" Thick Slab min. - #5 @ 8" ea.way
- 72"ø - 8" Thick Slab min. - #5 @ 8" ea.way
- 84"ø - 8" Thick Slab min. - #5 @ 6" ea.way
- 96"ø - 10" Thick Slab min. - #5 @ 6" ea.way

**45' Deep Structure**

- 60"ø - 8" Thick Slab min. - #5 @ 8" ea.way
- 72"ø - 8" Thick Slab min. - #5 @ 8" ea.way
- 84"ø - 10" Thick Slab min. - #5 @ 6" ea.way
- 96"ø - 12" Thick Slab min. - #5 @ 6" ea.way

All Reinforcing has 1 1/2" cover from top of slab.

**Materials & Features**

CONCRETE: 5,000 PSI in 28 days.  
 REINFORCING STEEL, per ASTM A-615, Grade 60.  
 REINFORCING to meet AASHTO HS 20-44 Loading.  
 DESIGN EQUAL TO OR EXCEEDS ASTM C-478  
 In the event a boot is loose contact your Hanson representative to resolve.

**Note:**

- Inverts shall be specifically sized for connecting pipes; and shall be U-Shaped with the min. depth 3/4 of the largest pipe diameter.

-No Scale-  
 All dimensions subject to allowable specification tolerances.

TITLE	PLANT	STATE	SECTION, PAGE	DATE
30 & 45 Ft. Depth 60" thru 96" Large Base Manhole	Houston San Antonio	TX	5.10	08-15-06



Contact Hanson

Go to Index



# Precast Manholes

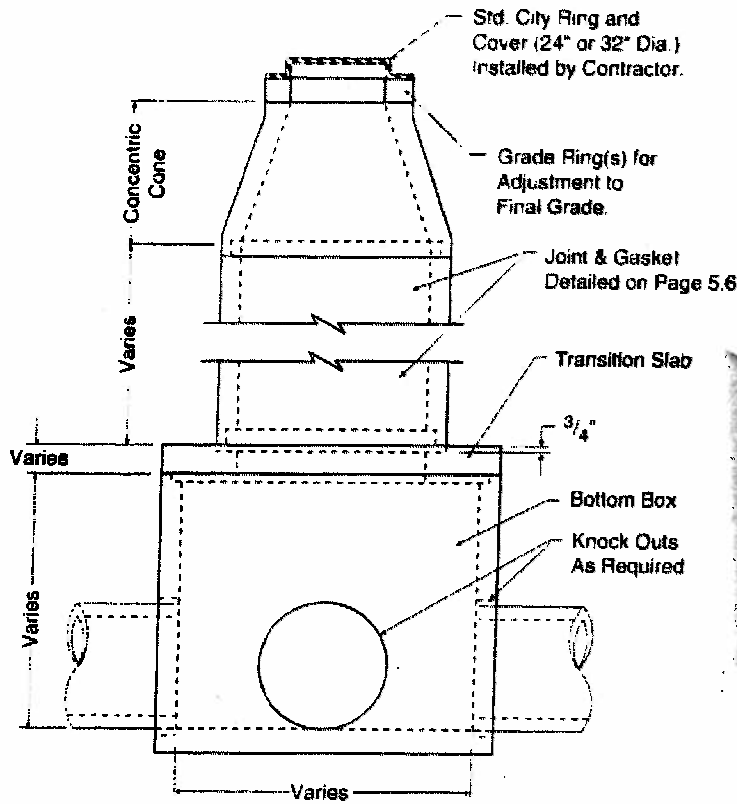

**Side View**

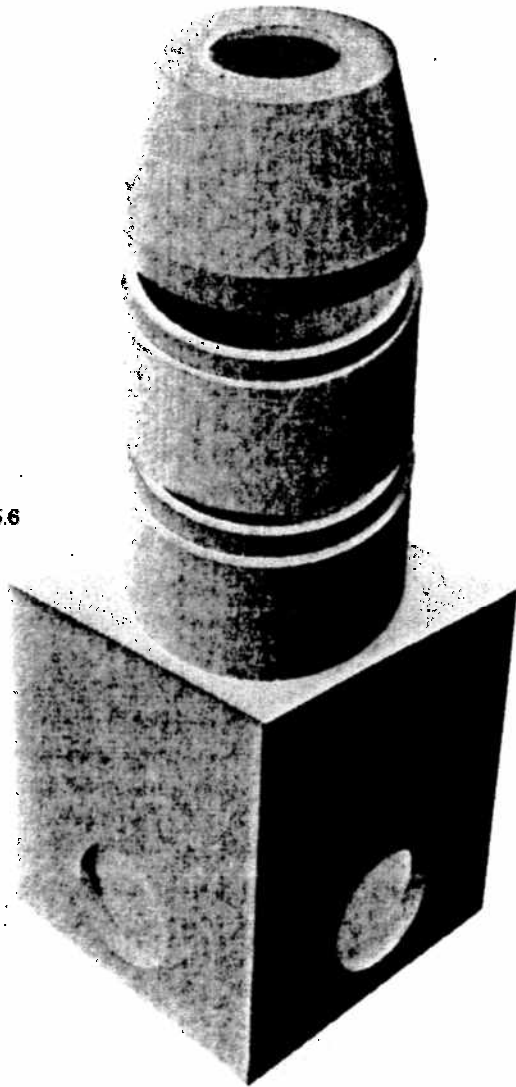

**Isometric View**

## Materials & Features

CONCRETE: 5,000 PSI in 28 days.

REINFORCING STEEL: per ASTM A-615 / A-185

REINFORCING to meet AASHTO HS 20-44 Loading.

BASE DESIGN EQUAL TO OR EXCEEDS ASTM C-357

RISER DESIGN EQUAL TO OR EXCEEDS ASTM C-478

In the event a boot is loose contact your Hanson representative to resolve.

-No Scale-  
All dimensions subject to allowable specification tolerances.

TITLE	PLANT	STATE	SECTION/PAGE	DATE	
Type "C" Manhole	Houston San Antonio	TX	5.11	08-15-06	

Contact Hanson

Go to Index

EXIT 

# Precast Manholes

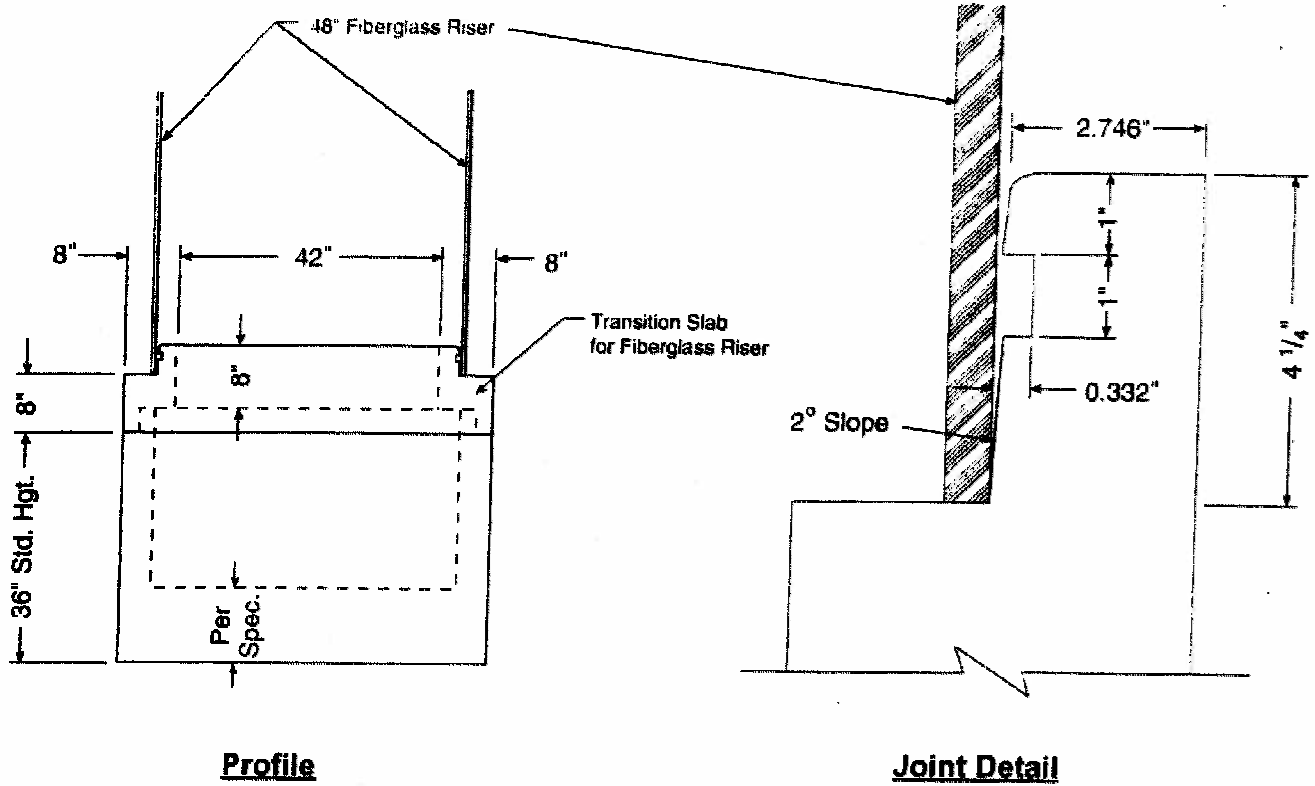

## Materials & Features

CONCRETE: 5,000 PSI in 28 days.  
 REINFORCING STEEL: per ASTM A-615, Grade 60.  
 REINFORCING to meet AASHTO HS 20-44 Loading.  
 DESIGN EQUAL TO OR EXCEEDS ASTM C-478

**-No Scale-**  
 All dimensions subject to allowable specification tolerances.

TITLE	PLANT	STATE	SECTION/PAGE	DATE	
ASTM C-478 Special Base	Houston	TX	5.12	C8-15-06	

Contact Hanson

Go to Index

EXIT 



# Precast Manholes

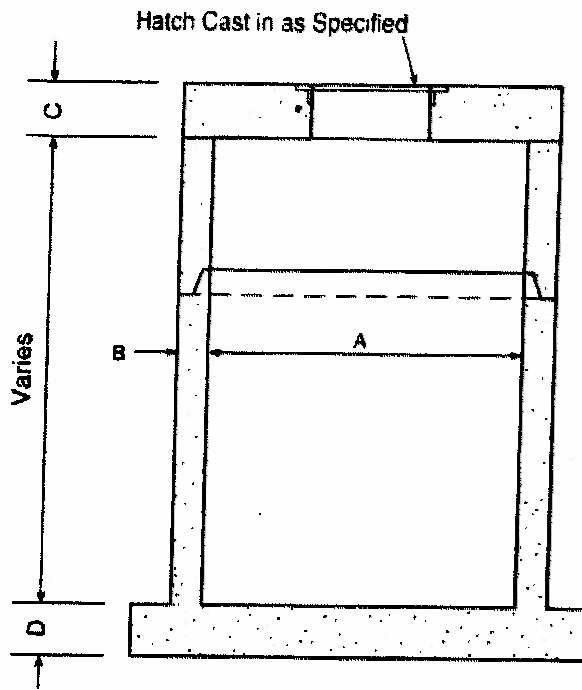

**Section View**

(Base configuration for 60", 72" & 84")

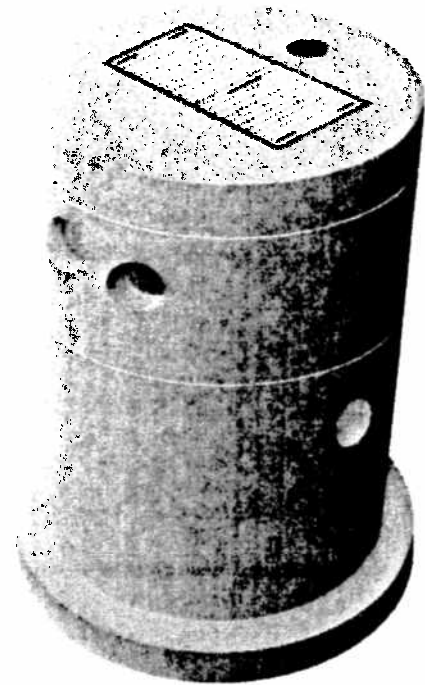

**Isometric View**

Product Dimensions				
A	B	C	D	
60"	Contact your local Hanson representative for product dimensions.			
72"				
84"				
96"				
108"				
120"				
132"				
144"				

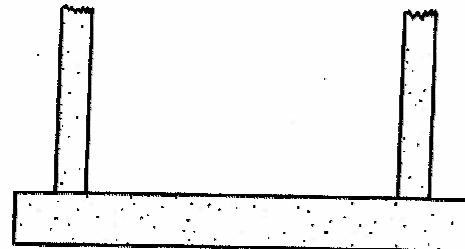

**Section View**

Base configuration for 96"

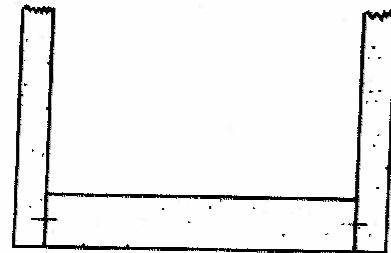

**Section View**

Base configuration for 108"-144"

## Materials & Features

CONCRETE: 5,000 PSI in 28 days.

REINFORCING STEEL: per ASTM A-615 / A-185

REINFORCING to meet AASHTO HS 20-44 Loading.

BASE DESIGN EQUAL TO OR EXCEEDS ASTM C-357

RISER DESIGN EQUAL TO OR EXCEEDS ASTM C-478

(A). Hatches as specified by Engineer.

In the event a boot is loose contact your Hanson representative to resolve.

-No Scale-

All dimensions subject to allowable specification tolerances.

TITLE	PLANT	STATE	SECTION/PAGE	DATE	
Typical Wetwells - Various Diameters	All Plants	TX	5.13	08-15-06	

Contact Hanson

Go to Index

EXIT

①

### "O"-Ring Gasket

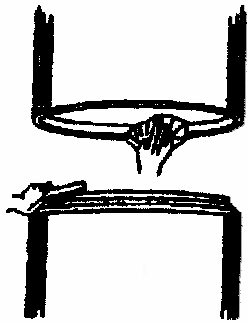

Carefully clean all dirt & foreign objects from the joining surface of the bell or groove end of pipe.

Carefully clean spigot or tongue end of pipe, including the gasket recess. Inspect the bell and spigot ends of each section to make sure they are free from cracks, chips or voids that will interfere with gasket.

Improperly prepared bell and spigot surfaces may prevent homing of the pipe or keep the gasket from sealing.

②

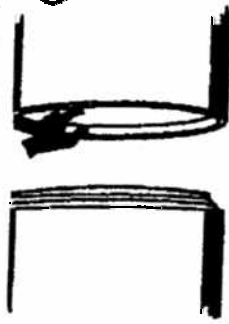

Lubricate bell joint surface liberally, covering entire inside surface using proper pipe gasket lubricant.

③



Lubricate the gasket thoroughly before it is placed on the spigot or tongue.

Bell and Gasket not lubricated or improperly lubricated may cause the gasket to roll and leak or possibly damage the bell.

④

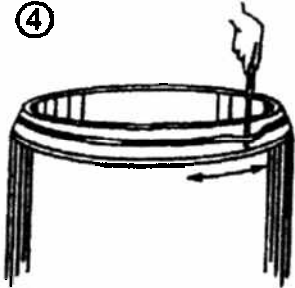

#### \*\*IMPORTANT\*\*

Fit the gasket carefully, equalizing the rubber gasket stretch by running a smooth, round object (inserted between the gasket & spigot) around the entire circumference several times.

Unequal stretch could cause bunching of the gasket and may cause leaks in the joint or crack the bell.

⑤

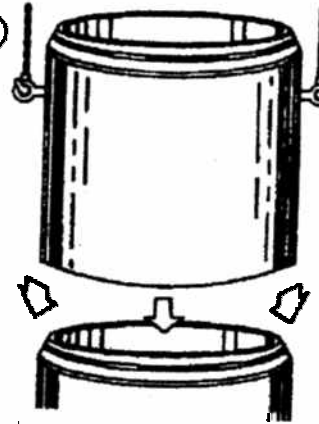

Align the bell & spigot to be joined. Before homing the joint, check that the gasket is in contact with the bell end entrance taper around the entire circumference.

Do not force sections together. If sections do not seat properly, unstack and contact your Hanson Sales Representative.

Improper alignment can dislodge gasket, causing leaks or possibly breaking the bell.

### Profile Gasket

1. Manhole sections should be handled with extreme caution to avoid chipping of the bell or spigot ends. Proper lifting devices must be used on all sections.
2. Inspect gasket sealing area for any voids or rough edges that may interfere with the seal.
3. Place the 4-G Gasket in the step of the spigot. (Making sure that the pointed end of the gasket is toward the end of the pipe as shown in Fig A.)
4. **\*\*IMPORTANT\*\*** Equalize the stretch on the gasket by pulling the sealing lube away from the spigot at least one inch and then releasing the gasket. Repeat this every three or four inches around the circumference of the pipe. Equalization of stretch makes sure that the gasket has the same stretched cross-section and tension throughout. **\*\*Do not lube the gasket or spigot end of the pipe.\*\***
5. Remove all dirt and other foreign matter from the inside surface of the bell. Apply lube to the inner surface of the bell including the

lead-in taper surface on the outer edge of the bell. Align spigot with the bell. Gasket should touch lead-in taper around the entire circumference before pushing the pipe home.

6. Push the manhole section carefully, until the spigot is all the way home. (Fig B) Do not force sections together. If sections do not seat properly, unstack and contact your Hanson Sales Representative.
7. Every manhole will not come home exactly the same. Differences in application, consistency of lubricants, dimensions in the spigot and groove will cause variations in installation. If joining problems arise, please contact the manhole manufacturer immediately rather than forcing manhole sections together with subsequent damage to the manhole.
8. All testing should be performed prior to backfill of the manhole. Problems can not be detected after the manhole is backfilled. **Testing the manhole after backfill voids all warranties.**



Fig. A

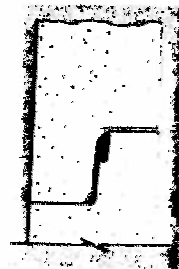

Fig. B

**Note:** Manholes in excess of 30' in depth must be vacuum tested prior to backfill. The loads presented by soils and possible groundwater at 30' in addition to the load from the vacuum may exceed the design capacity of the pipe to manhole connector.

TITLE	PLANT	STATE	SECTION/PAGE	DATE
O-Ring & Profile Gasket Installation on Manholes	All Plants	TX	5.14	08-15-06



Contact Hanson

Go to Index

EXIT

# Precast Manholes

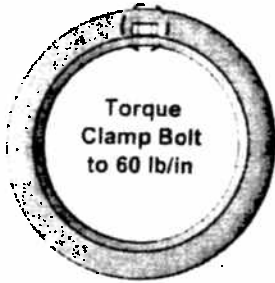

**Single Clamp**

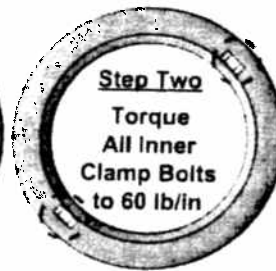
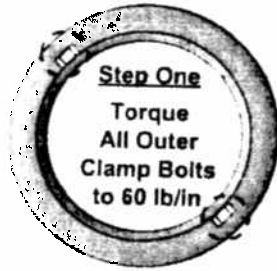

**Multiple Clamps**

## Instructions

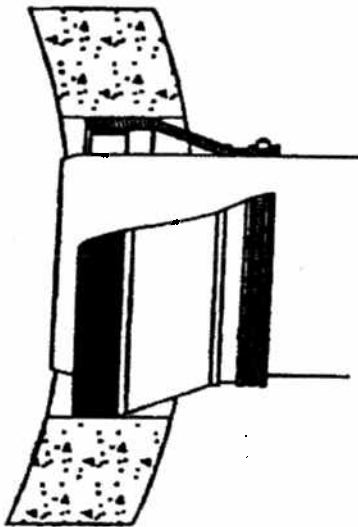

1. Clean pipe and boot to ensure no dirt or foreign materials are present.
2. Clamping surface on pipe must be clean and smooth.
3. Center pipe in opening and insert until pipe is at least equal to the inside plane of the manhole.
4. Attach take-up clamps(s) and stagger screw(s) of clamps(s) around the groove of the gasket so that take-up pressure will be equalized. Make sure each clamp is completely in the correct groove.
5. Using a torque ratchet or torque wrench, gradually tighten all screw(s) of clamp(s) in an alternating pattern to 60 lbs/in torque.
6. After reaching 60 lbs/in torque on final screw, check all screws again to ensure equal compression of all clamps.
7. If system is to be tested, testing shall be completed prior to backfilling, following all recommendations and requirements of the test system manufacturer. Vacuum testing shall be conducted in accordance with ASTM C-1244.
8. Adjust pipe to line and grade. Use proper bedding, backfill materials and techniques so that pipe deflection and deformation is minimized.
9. Any pipe stubs installed in the manhole must be positively restrained from movement.
10. Vacuum testing after backfill voids warranty.

**For more information contact your local Hanson Representative.**

TITLE	PLANT	STATE	SECTION PAGE	DATE	
Pipe to Manhole Connector Installation Guide	All Plants	TX	5.15	08-15-06	

**Contact Hanson**

**Go to Index**

**EXIT** 

**CONCRETE 4000 PSI  
REINF 60000 PSI  
HS 20 LOADING**

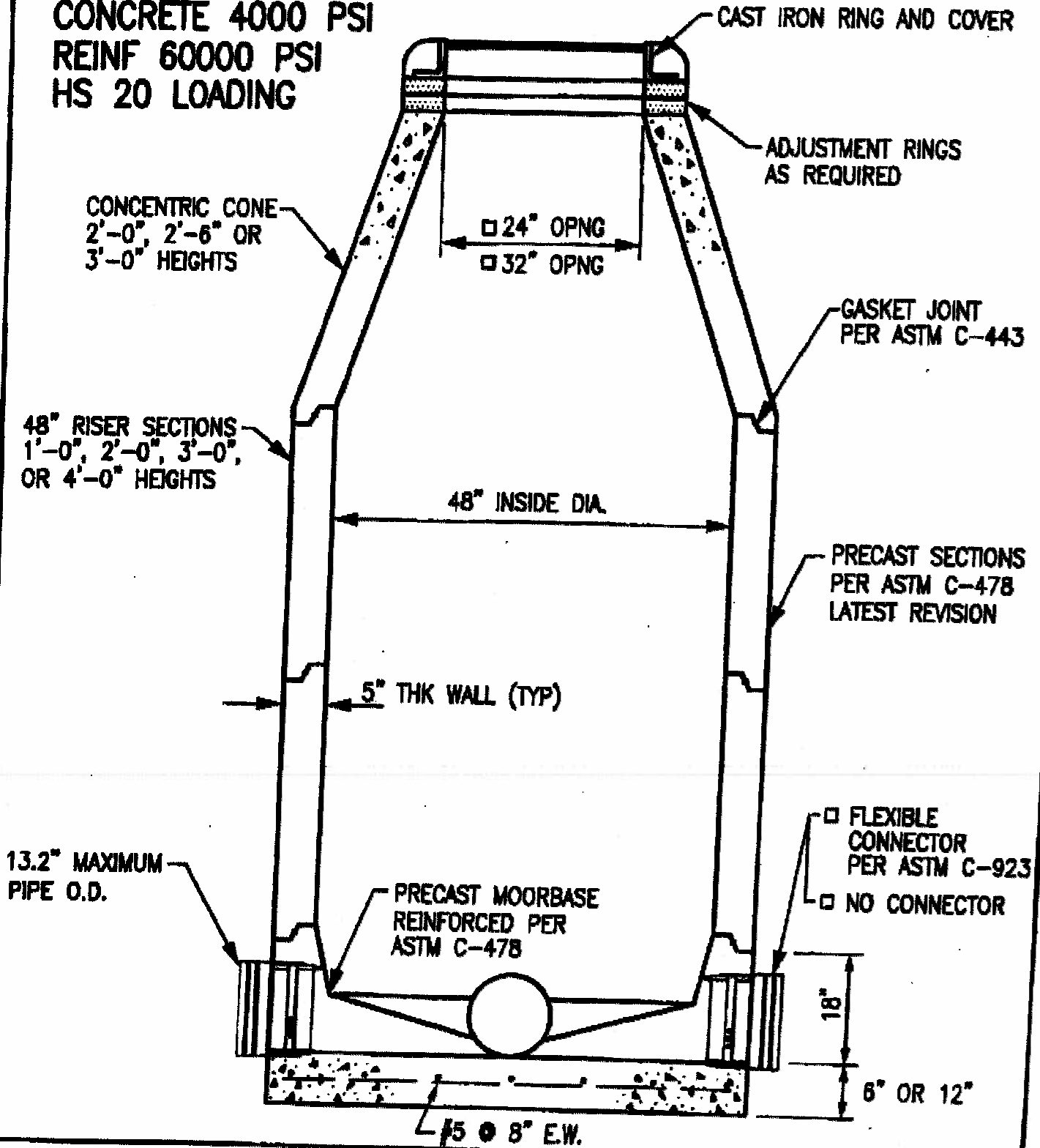

**Rinker**  
MATERIALS  
**Moor-Tex**

2735 HWY. 36 NORTH  
MAILING: P.O. BOX 1088  
SEALY, TEXAS 77474  
PH: (979) 885-7403  
(281) 375-6121  
FAX: (979) 885-7001

REV.	DESCRIPTION	DATE
DATE: 8-09-02	SCALE: 3/4"=1'-0"	BY: RB
<b>48" PRECAST CONCENTRIC MANHOLE WITH MOORBASE</b>		
JOB: 2002	FILE: 48CM	DWG. NO. 48CM

**TEMPORARY STORMWATER  
SECTION (TCEQ-0602)**

# Temporary Stormwater Section

## Texas Commission on Environmental Quality

for Regulated Activities on the Edwards Aquifer Recharge Zone and Relating to 30 TAC §213.5(b)(4)(A), (B), (D)(I) and (G); Effective June 1, 1999

**To ensure that the application is administratively complete, confirm that all fields in the form are complete, verify that all requested information is provided, consistently reference the same site and contact person in all forms in the application, and ensure forms are signed by the appropriate party.**

**Note: Including all the information requested in the form and attachments contributes to more streamlined technical reviews.**

## Signature

To the best of my knowledge, the responses to this form accurately reflect all information requested concerning the proposed regulated activities and methods to protect the Edwards Aquifer. This **Temporary Stormwater Section** is hereby submitted for TCEQ review and executive director approval. The application was prepared by:

Print Name of Customer/Agent: Jocelyn Perez, P.E.

Date: 12/5/23

Signature of Customer/Agent:

  
\_\_\_\_\_

Regulated Entity Name: Veramendi Precinct 18 Unit 1

## Project Information

### Potential Sources of Contamination

*Examples: Fuel storage and use, chemical storage and use, use of asphaltic products, construction vehicles tracking onto public roads, and existing solid waste.*

1. Fuels for construction equipment and hazardous substances which will be used during construction:

The following fuels and/or hazardous substances will be stored on the site: Construction staging area

These fuels and/or hazardous substances will be stored in:

Aboveground storage tanks with a cumulative storage capacity of less than 250 gallons will be stored on the site for less than one (1) year.



- Aboveground storage tanks with a cumulative storage capacity between 250 gallons and 499 gallons will be stored on the site for less than one (1) year.
  - Aboveground storage tanks with a cumulative storage capacity of 500 gallons or more will be stored on the site. An Aboveground Storage Tank Facility Plan application must be submitted to the appropriate regional office of the TCEQ prior to moving the tanks onto the project.
  - Fuels and hazardous substances will not be stored on the site.
2.  **Attachment A - Spill Response Actions.** A site specific description of the measures to be taken to contain any spill of hydrocarbons or hazardous substances is attached.
  3.  Temporary aboveground storage tank systems of 250 gallons or more cumulative storage capacity must be located a minimum horizontal distance of 150 feet from any domestic, industrial, irrigation, or public water supply well, or other sensitive feature.
  4.  **Attachment B - Potential Sources of Contamination.** A description of any activities or processes which may be a potential source of contamination affecting surface water quality is attached.

### ***Sequence of Construction***

5.  **Attachment C - Sequence of Major Activities.** A description of the sequence of major activities which will disturb soils for major portions of the site (grubbing, excavation, grading, utilities, and infrastructure installation) is attached.
  - For each activity described, an estimate (in acres) of the total area of the site to be disturbed by each activity is given.
  - For each activity described, include a description of appropriate temporary control measures and the general timing (or sequence) during the construction process that the measures will be implemented.
6.  Name the receiving water(s) at or near the site which will be disturbed or which will receive discharges from disturbed areas of the project: Bleiders Creek

### ***Temporary Best Management Practices (TBMPs)***

*Erosion control examples: tree protection, interceptor swales, level spreaders, outlet stabilization, blankets or matting, mulch, and sod. Sediment control examples: stabilized construction exit, silt fence, filter dikes, rock berms, buffer strips, sediment traps, and sediment basins. Please refer to the Technical Guidance Manual for guidelines and specifications. All structural BMPs must be shown on the site plan.*

7.  **Attachment D – Temporary Best Management Practices and Measures.** TBMPs and measures will prevent pollution of surface water, groundwater, and stormwater. The construction-phase BMPs for erosion and sediment controls have been designed to retain sediment on site to the extent practicable. The following information is attached:

- A description of how BMPs and measures will prevent pollution of surface water, groundwater or stormwater that originates upgradient from the site and flows across the site.
  - A description of how BMPs and measures will prevent pollution of surface water or groundwater that originates on-site or flows off site, including pollution caused by contaminated stormwater runoff from the site.
  - A description of how BMPs and measures will prevent pollutants from entering surface streams, sensitive features, or the aquifer.
  - A description of how, to the maximum extent practicable, BMPs and measures will maintain flow to naturally-occurring sensitive features identified in either the geologic assessment, TCEQ inspections, or during excavation, blasting, or construction.
8.  The temporary sealing of a naturally-occurring sensitive feature which accepts recharge to the Edwards Aquifer as a temporary pollution abatement measure during active construction should be avoided.
- Attachment E - Request to Temporarily Seal a Feature.** A request to temporarily seal a feature is attached. The request includes justification as to why no reasonable and practicable alternative exists for each feature.
  - There will be no temporary sealing of naturally-occurring sensitive features on the site.
9.  **Attachment F - Structural Practices.** A description of the structural practices that will be used to divert flows away from exposed soils, to store flows, or to otherwise limit runoff discharge of pollutants from exposed areas of the site is attached. Placement of structural practices in floodplains has been avoided.
10.  **Attachment G - Drainage Area Map.** A drainage area map supporting the following requirements is attached:
- For areas that will have more than 10 acres within a common drainage area disturbed at one time, a sediment basin will be provided.
  - For areas that will have more than 10 acres within a common drainage area disturbed at one time, a smaller sediment basin and/or sediment trap(s) will be used.
  - For areas that will have more than 10 acres within a common drainage area disturbed at one time, a sediment basin or other equivalent controls are not attainable, but other TBMPs and measures will be used in combination to protect down slope and side slope boundaries of the construction area.
  - There are no areas greater than 10 acres within a common drainage area that will be disturbed at one time. A smaller sediment basin and/or sediment trap(s) will be used in combination with other erosion and sediment controls within each disturbed drainage area.

- There are no areas greater than 10 acres within a common drainage area that will be disturbed at one time. Erosion and sediment controls other than sediment basins or sediment traps within each disturbed drainage area will be used.
11.  **Attachment H - Temporary Sediment Pond(s) Plans and Calculations.** Temporary sediment pond or basin construction plans and design calculations for a proposed temporary BMP or measure have been prepared by or under the direct supervision of a Texas Licensed Professional Engineer. All construction plans and design information must be signed, sealed, and dated by the Texas Licensed Professional Engineer. Construction plans for the proposed temporary BMPs and measures are attached.
- N/A
12.  **Attachment I - Inspection and Maintenance for BMPs.** A plan for the inspection of each temporary BMP(s) and measure(s) and for their timely maintenance, repairs, and, if necessary, retrofit is attached. A description of the documentation procedures, recordkeeping practices, and inspection frequency are included in the plan and are specific to the site and/or BMP.
13.  All control measures must be properly selected, installed, and maintained in accordance with the manufacturer's specifications and good engineering practices. If periodic inspections by the applicant or the executive director, or other information indicate a control has been used inappropriately, or incorrectly, the applicant must replace or modify the control for site situations.
14.  If sediment escapes the construction site, off-site accumulations of sediment must be removed at a frequency sufficient to minimize offsite impacts to water quality (e.g., fugitive sediment in street being washed into surface streams or sensitive features by the next rain).
15.  Sediment must be removed from sediment traps or sedimentation ponds not later than when design capacity has been reduced by 50%. A permanent stake will be provided that can indicate when the sediment occupies 50% of the basin volume.
16.  Litter, construction debris, and construction chemicals exposed to stormwater shall be prevented from becoming a pollutant source for stormwater discharges (e.g., screening outfalls, picked up daily).

### ***Soil Stabilization Practices***

*Examples: establishment of temporary vegetation, establishment of permanent vegetation, mulching, geotextiles, sod stabilization, vegetative buffer strips, protection of trees, or preservation of mature vegetation.*

17.  **Attachment J - Schedule of Interim and Permanent Soil Stabilization Practices.** A schedule of the interim and permanent soil stabilization practices for the site is attached.

18.  Records must be kept at the site of the dates when major grading activities occur, the dates when construction activities temporarily or permanently cease on a portion of the site, and the dates when stabilization measures are initiated.
19.  Stabilization practices must be initiated as soon as practicable where construction activities have temporarily or permanently ceased.

### ***Administrative Information***

20.  All structural controls will be inspected and maintained according to the submitted and approved operation and maintenance plan for the project.
21.  If any geologic or manmade features, such as caves, faults, sinkholes, etc., are discovered, all regulated activities near the feature will be immediately suspended. The appropriate TCEQ Regional Office shall be immediately notified. Regulated activities must cease and not continue until the TCEQ has reviewed and approved the methods proposed to protect the aquifer from any adverse impacts.
22.  Silt fences, diversion berms, and other temporary erosion and sediment controls will be constructed and maintained as appropriate to prevent pollutants from entering sensitive features discovered during construction.

**ATTACHMENT A**

# VERAMENDI PRECINCT 18 UNIT 1

## Organized Sewage Collection System Plan

### Attachment A – Spill Response Actions

In the event of an accidental leak or spill:

- Spill must be contained and cleaned up immediately.
- Spills will not be merely buried or washed with water.
- Contractor shall take action to contain spill. Contractor may use sand or other absorbent material stockpiled on site to absorb spill. Absorbent material should be spread over the spill area to absorb the spilled product.
- In the event of an uncontained discharge the contractor shall utilize onsite equipment to construct berms downgradient of the spill with sand or other absorbent material to contain and absorb the spilled product.
- Spill containment/absorbent materials along with impacted media must be collected and stored in such a way so as not to continue to affect additional media (soil/water). Once the spill has been contained, collected material should be placed on poly or plastic sheeting until removed from the site. The impacted media and cleanup materials should be covered with plastic sheeting and the edges weighed down with paving bricks or other similarly dense objects as the material is being accumulated. This will prevent the impacted media and cleanup materials from becoming airborne in windy conditions or impacting runoff during a rain event. The stockpiled materials should not be located within an area of concentrated runoff such as along a curb line or within a swale.
- Contaminated soils and cleanup materials will be sampled for waste characterization. When the analysis results are known the contaminated soils and cleanup materials will be removed from the site and disposed in a permitted landfill in accordance with applicable regulations.
- The contractor will be required to notify the owner, who will in turn contact TCEQ to notify them in the event of a significant hazardous/reportable quantity spill. Additional notifications as required by the type and amount of spill will be conducted by owner or owner's representative.

In the event of an accidental significant or hazardous spill:

The contractor will be required to report significant or hazardous spills in reportable quantities to:

- Notify the TCEQ by telephone as soon as possible and within 24 hours at 512-339-2929 (Austin) or 210-490-3096 (San Antonio) between 8 AM and 5 PM. After hours, contact the Environmental Release Hotline at 1-800-832-8224. It is the contractor's responsibility to have all emergency phone numbers at the construction site. [https://www.tceq.texas.gov/response/spills/spill\\_rq.html](https://www.tceq.texas.gov/response/spills/spill_rq.html)
- For spills of federal reportable quantities, in conformance with the requirements in 40 CFR parts 110,119, and 302, the contractor should notify the National Response Center at (800) 424-8802.



## **VERAMENDI PRECINCT 18 UNIT 1**

### **Organized Sewage Collection System Plan**

- Notification should first be made by telephone and followed up with a written report.
- The services of a spills contractor or a Haz-Mat team should be obtained immediately. Construction personnel should not attempt to clean up until the appropriate and qualified staffs have arrived at the job site.
- Other agencies which may need to be consulted include, but are not limited to, the City Police Department, County Sheriff Office, Fire Departments, etc.
- Contaminated soils will be sampled for waste characterization. When the analysis results are known the contaminated soils will be removed from the site and disposed in a permitted landfill in accordance with applicable regulations.

Additional guidance can be obtained from TCEQ's Technical Guidance Manual (TGM) RG-348 (2005) Section 1.4.16. Contractor shall review this section.

**ATTACHMENT B**

# VERAMENDI PRECINCT 18 UNIT 1

## Organized Sewage Collection System Plan

### Attachment B – Potential Sources of Contamination

Other potential sources of contamination during construction include:

- |                      |   |  |
|----------------------|---|--|
| Potential Source     | ● | Asphalt products used on this project.   |
| Preventative Measure | ■ | After placement of asphalt, emulsion or coatings, the contractor will be responsible for immediate cleanup should an unexpected rain occur. For the duration of the asphalt product curing time, the contractor will maintain standby personnel and equipment to contain any asphalt wash-off should an unexpected rain occur. The contractor will be instructed not to place asphalt products on the ground within 48 hours of a forecasted rain. |
| Potential Source     | ● | Oil, grease, fuel and hydraulic fluid contamination from construction equipment and vehicle dripping.  |
| Preventative Measure | ■ | Vehicle maintenance when possible will be performed within the construction staging area.  |
|                      | ■ | Construction vehicles and equipment shall be checked regularly for leaks and repaired immediately.   |
| Potential Source     | ● | Accidental leaks or spills of oil, petroleum products and substances listed under 40 CFR parts 110, 117, and 302 used or stored temporarily on site.   |
| Preventative Measure | ■ | Contractor to incorporate into regular safety meetings, a discussion of spill prevention and appropriate disposal procedures.  |
|                      | ■ | Contractor's superintendent or representative overseer shall enforce proper spill prevention and control measures.   |
|                      | ■ | Hazardous materials and wastes shall be stored in covered containers and protected from vandalism.   |
|                      | ■ | A stockpile of spill cleanup materials shall be stored on site where it will be readily accessible.  |
| Potential Source     | ● | Miscellaneous trash and litter from construction workers and material wrappings.   |
| Preventive Measure   | ■ | Trash containers will be placed throughout the site to encourage proper trash disposal.  |
| Potential Source     | ● | Construction debris.   |
| Preventive Measure   | ■ | Construction debris will be monitored daily by contractor. Debris will be collected weekly and placed in disposal bins. Situations requiring immediate attention will be addressed on a case by case basis.  |

# VERAMENDI PRECINCT 18 UNIT 1

## Organized Sewage Collection System Plan

- |                      |   |   |
|----------------------|---|---|
| Potential Source     | ● | Spills/Overflow of waste from portable toilets  |
| Preventative Measure | ■ | Portable toilets will be placed away from high traffic vehicular areas and storm drain inlets.  |
|                      | ■ | Portable toilets will be placed on a level ground surface.  |
|                      | ■ | Portable toilets will be inspected regularly for leaks and will be serviced and sanitized at time intervals that will maintain sanitary conditions. |

**ATTACHMENT C**

# VERAMENDI PRECINCT 18 UNIT 1

## Organized Sewage Collection System Plan

### Attachment C – Sequence of Major Activities

Veramendi Precinct 18 Unit 1 SCS will be constructed concurrently with four (4) other developments. The sequence of major activities which disturb soil during construction on this site will be divided into two stages. The first is site preparation that will include installation of TBMPs as illustrated on Exhibit 1, clearing and grubbing of vegetation where applicable, and mass grading and stockpiling of soils. This will disturb approximately 121.98 acres for all development. The second is construction that will include construction of 320 single-family homes with associated streets, four (4) batch detention basins, construction of new pavement area, landscaping and site cleanup. This will disturb approximately 121.98 acres. Approximately 26.49 acres of the project site may be disturbed for this SCS installation, including excavation, construction of sewer mains, backfill and compaction.

**ATTACHMENT D**



# VERAMENDI PRECINCT 18 UNIT 1

## Organized Sewage Collection System Plan

### Attachment D – Temporary Best Management Practices and Measures

A description of how BMPs and measures will prevent pollution of surface water, groundwater or stormwater that originates upgradient from the site and flows across the site.

***No upgradient water will cross the site. Upgradient water will be intercepted through earthen channels around the site. All TBMPs are adequate for the drainage areas they serve.***

b. A description of how BMPs and measures will prevent pollution of surface water or groundwater that originates on-site or flows off site, including pollution caused by contaminated stormwater runoff from the site.

***Site preparation, which is the initiation of all activity on the project, will disturb the largest amount of soil. Therefore, before any of this work can begin, the clearing and grading contractor will be responsible for the installation of all on-site control measures. The methodology for pollution prevention of on-site stormwater will include: (1) erection of silt fences along the downgradient boundary of construction activities for temporary erosion and sedimentation controls, (2) installation of rock berms with silt fencing downgradient from areas of concentrated stormwater flow for temporary erosion control, (3) Installation of gravel bags and drain inlet protection at inlets and downgradient areas of construction activities for sediment control (4) installation of stabilized construction entrance/exit(s) to reduce the dispersion of sediment from the site, and (5) installation of construction staging area(s).***

***Prior to the initiation of construction, all previously installed control measures will be repaired or reestablished for their designed or intended purpose. This work, which is the remainder of all activity on the project, may also disturb additional soil. The construction contractor will be responsible for the installation of all remaining on-site control measures that includes installation of the concrete truck washout pit(s), as construction phasing warrants.***

***Temporary measures are intended to provide a method of slowing the flow of runoff from the construction site in order to allow sediment and suspended solids to settle out of the runoff. By containing the sediment and solids within the site, they will not enter surface streams and/or sensitive features.***

c. A description of how BMPs and measures will prevent pollutants from entering surface streams, sensitive features, or the aquifer.

***Temporary measures are intended to provide a method of slowing the flow of runoff from the construction site in order to allow sediment and suspended solids to settle out of the runoff. By containing the sediment and solids within the site, they will not enter surface streams and/or sensitive features.***

## VERAMENDI PRECINCT 18 UNIT 1

### Organized Sewage Collection System Plan

- d. A description of how, to the maximum extent practicable, BMPs and measures will maintain flow to naturally-occurring sensitive features identified in either the geologic assessment, TCEQ inspections, or during excavation, blasting, or construction.

***BMP measures utilized in this plan are intended to allow stormwater to continue downstream after passing through the BMPs. This will allow stormwater runoff to continue downgradient to streams or features that may exist downstream of the site.***

**ATTACHMENT F**

# VERAMENDI PRECINCT 18 UNIT 1

## Organized Sewage Collection System Plan

### Attachment F – Structural Practices

The following structural measures will be installed prior to the initiation of site preparation activities:

- Erection of silt fences along the downgradient boundary of construction activities and rock berms with silt fence for secondary protection, as located on Exhibit 1 and illustrated in Exhibit 2.
- Installation of gravel bags and drain inlet protection at inlets and downgradient areas of construction activities, as located on Exhibit 1 and illustrated in Exhibit 2.
- Installation of stabilized construction entrance/exit(s) and construction staging area(s), as located on Exhibit 1, and illustrated on Exhibit 2.

The following structural measures will be installed at the initiation of construction activities or as appropriate based on the construction sequencing:

- Installation of concrete truck washout pit(s), as required and located on Exhibit 1 and illustrated on Exhibit 2.

**ATTACHMENT G**

# VERAMENDI PRECINCT 18 UNIT 1

## Organized Sewage Collection System Plan

### Attachment G – Drainage Area Map

No more than ten (10) acres will be disturbed within a common drainage area at one time as construction of civil infrastructure (utilities, roads, drainage, etc.) will precede home building construction. All TBMPs utilized are adequate for the drainage areas served.

**ATTACHMENT I**



# VERAMENDI PRECINCT 18 UNIT 1

## Organized Sewage Collection System Plan

### INSPECTIONS

Designated and qualified person(s) shall inspect Pollution Control Measures weekly and within 24 hours after a storm event. An inspection report that summarizes the scope of the inspection, names and qualifications of personnel conducting the inspection, date of the inspection, major observations, and actions taken as a result of the inspection shall be recorded and maintained as part of Storm Water TPDES data for a period of three years after the Notice of Termination (NOT) has been filed. A copy of the Inspection Report Form is provided in this Storm Water Pollution Prevention Plan.

As a minimum, the inspector shall observe: (1) significant disturbed areas for evidence of erosion, (2) storage areas for evidence of leakage from the exposed stored materials, (3) structural controls (rock berm outlets, silt fences, drainage swales, etc.) for evidence of failure or excess siltation (over 6 inches deep), (4) vehicle exit point for evidence of off-site sediment tracking, (5) vehicle storage areas for signs of leaking equipment or spills, (6) concrete truck rinse-out pit for signs of potential failure, (7) embankment, spillways, and outlet of sediment basin (where applicable) for erosion damage, and (8) sediment basins (where applicable) for evidence that basin has accumulated 50% of its volume in silt. Deficiencies noted during the inspection will be corrected and documented within seven calendar days following the inspection or before the next anticipated storm event if practicable.

Contractor shall review Sections 1.3 and 1.4 of TCEQ's Technical Guidance Manual for additional BMP inspection and maintenance requirements.

# VERAMENDI PRECINCT 18 UNIT 1

## Organized Sewage Collection System Plan

Pollution Prevention Measure	Inspected in Compliance	Corrective Action Required	
		Description (use additional sheet if necessary)	Date Completed
<b>Best Management Practices</b>			
Natural vegetation buffer strips			
Temporary vegetation			
Permanent vegetation			
Sediment control basin			
Silt fences			
Rock berms			
Gravel filter bags			
Drain inlet protection			
Other structural controls			
Vehicle exits (off-site tracking)			
Material storage areas (leakage)			
Equipment areas (leaks, spills)			
Concrete washout pit (leaks, failure)			
General site cleanliness			
Trash receptacles			
<b>Evidence of Erosion</b>			
Site preparation			
Roadway or parking lot construction			
Utility construction			
Drainage construction			
Building construction			
<b>Major Observations</b>			
Sediment discharges from site			
BMPs requiring maintenance			
BMPs requiring modification			
Additional BMPs required			

\_\_\_\_\_ A brief statement describing the qualifications of the inspector is included in this SWP3.

"I certify under penalty of law that this document and all attachments were prepared under my direction or supervision in accordance with a system designed to assure that qualified personnel properly gather and evaluate the information submitted. Based on my inquiry of the person or persons who manage the system, or those persons directly responsible for gathering the information, the information submitted is, to the best of my knowledge and belief, true, accurate, and complete. I am aware there are significant penalties for submitting false information, including the possibility of fine and imprisonment for knowing violations."

"I further certify I am an authorized signatory in accordance with the provisions of 30 TAC §305.128."

\_\_\_\_\_  
Inspector's Name

\_\_\_\_\_  
Inspector's Signature

\_\_\_\_\_  
Date

# VERAMENDI PRECINCT 18 UNIT 1 Organized Sewage Collection System Plan

## PROJECT MILESTONE DATES

Date when major site grading activities begin:

<u>Construction Activity</u>	<u>Date</u>
Installation of BMPs	
_____	_____
_____	_____
_____	_____
_____	_____

Dates when construction activities temporarily or permanently cease on all or a portion of the project:

<u>Construction Activity</u>	<u>Date</u>
_____	_____
_____	_____
_____	_____
_____	_____

Dates when stabilization measures are initiated:

<u>Stabilization Activity</u>	<u>Date</u>
_____	_____
_____	_____
_____	_____
_____	_____
_____	_____
Removal of BMPs	
_____	_____

**ATTACHMENT J**

# VERAMENDI PRECINCT 18 UNIT 1

## Organized Sewage Collection System Plan

### Attachment J - Schedule of Interim and Permanent Soil Stabilization Practices

Interim on-site stabilization measures, which are continuous, will include minimizing soil disturbances by exposing the smallest practical area of land required for the shortest period of time and maximizing use of natural vegetation. As soon as practical, all disturbed soil will be stabilized as per project specifications in accordance with pages 1-35 to 1-60 of TCEQ's Technical Guidance Manual (TGM) RG-348 (2005). Mulching, netting, erosion blankets and seeding are acceptable.

Stabilization measures will be initiated as soon as practicable in portions of the site where construction activities have temporarily or permanently ceased, and except as provided below, will be initiated no more than fourteen (14) days after the construction activity in that portion of the site has temporarily or permanently ceased. Where construction activity on a portion of the site is temporarily ceased, and earth disturbing activities will be resumed within twenty-one (21) days, temporary stabilization measures do not have to be initiated on that portion of site. In areas experiencing droughts where the initiation of stabilization measures by the 14<sup>th</sup> day after construction activity has temporarily or permanently ceased is precluded by seasonably arid conditions, stabilization measures must be initiated as soon as practicable.

**AGENT AUTHORIZATION FORM  
(TCEQ-0599)**

**Agent Authorization Form**  
For Required Signature  
Edwards Aquifer Protection Program  
Relating to 30 TAC Chapter 213  
Effective June 1, 1999

I \_\_\_\_\_ Garrett Mechler \_\_\_\_\_  
Print Name

\_\_\_\_\_ VP, Operations \_\_\_\_\_  
Title - Owner/President/Other

of \_\_\_\_\_ Veramendi PE – Emerald, LLC \_\_\_\_\_  
Corporation/Partnership/Entity Name

have authorized \_\_\_\_\_ Pape-Dawson Engineers, Inc. \_\_\_\_\_  
Print Name of Agent/Engineer

of \_\_\_\_\_ Pape-Dawson Engineers, Inc. \_\_\_\_\_  
Print Name of Firm

to represent and act on the behalf of the above named Corporation, Partnership, or Entity for the purpose of preparing and submitting this plan application to the Texas Commission on Environmental Quality (TCEQ) for the review and approval consideration of regulated activities.

I also understand that:

1. The applicant is responsible for compliance with 30 Texas Administrative Code Chapter 213 and any condition of the TCEQ's approval letter. The TCEQ is authorized to assess administrative penalties of up to \$10,000 per day per violation.
2. For those submitting an application who are not the property owner, but who have the right to control and possess the property, additional authorization is required from the owner.
3. Application fees are due and payable at the time the application is submitted. The application fee must be sent to the TCEQ cashier or to the appropriate regional office. The application will not be considered until the correct fee is received by the commission.
4. A notarized copy of the Agent Authorization Form must be provided for the person preparing the application, and this form must accompany the completed application.
5. No person shall commence any regulated activity on the Edwards Aquifer Recharge Zone, Contributing Zone or Transition Zone until the appropriate application for the activity has been filed with and approved by the Executive Director.



SIGNATURE PAGE:

[Handwritten Signature]  
Applicant's Signature

11/10/2023  
Date

THE STATE OF Texas §  
County of Comal §

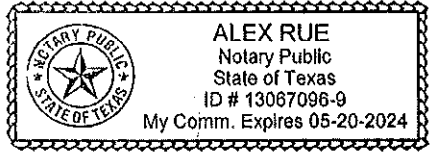

BEFORE ME, the undersigned authority, on this day personally appeared Garrett Mechtler known to me to be the person whose name is subscribed to the foregoing instrument, and acknowledged to me that (s)he executed same for the purpose and consideration therein expressed.

GIVEN under my hand and seal of office on this 10 day of November, 2023

[Handwritten Signature]  
NOTARY PUBLIC

Alex Rue  
Typed or Printed Name of Notary

MY COMMISSION EXPIRES: 5/20/2024

**APPLICATION FEE FORM  
(TCEQ-0574)**

# Application Fee Form

## Texas Commission on Environmental Quality

Name of Proposed Regulated Entity: Veramendi Precinct 18 Unit 1

Regulated Entity Location: Approximately 1.0 miles Northwest of TX-46/TX-337 and Word Pkwy intersection

Name of Customer: Veramendi PE - Emerald, LLC

Contact Person: Garrett Mechler

Phone: 830-643-1338

Customer Reference Number (if issued): CN 606123701

Regulated Entity Reference Number (if issued): RN \_\_\_\_\_

### Austin Regional Office (3373)

Hays

Travis

Williamson

### San Antonio Regional Office (3362)

Bexar

Medina

Uvalde

Comal

Kinney

Application fees must be paid by check, certified check, or money order, payable to the **Texas Commission on Environmental Quality**. Your canceled check will serve as your receipt. **This form must be submitted with your fee payment.** This payment is being submitted to:

Austin Regional Office

San Antonio Regional Office

Mailed to: TCEQ - Cashier

Overnight Delivery to: TCEQ - Cashier

Revenues Section

12100 Park 35 Circle

Mail Code 214

Building A, 3rd Floor

P.O. Box 13088

Austin, TX 78753

Austin, TX 78711-3088

(512)239-0357

### Site Location (Check All That Apply):

Recharge Zone

Contributing Zone

Transition Zone

<i>Type of Plan</i>	<i>Size</i>	<i>Fee Due</i>
Water Pollution Abatement Plan, Contributing Zone Plan: One Single Family Residential Dwelling	Acres	\$
Water Pollution Abatement Plan, Contributing Zone Plan: Multiple Single Family Residential and Parks	Acres	\$
Water Pollution Abatement Plan, Contributing Zone Plan: Non-residential	Acres	\$
Sewage Collection System	11,445.21 L.F.	\$ 5,722.61
Lift Stations without sewer lines	Acres	\$
Underground or Aboveground Storage Tank Facility	Tanks	\$
Piping System(s)(only)	Each	\$
Exception	Each	\$
Extension of Time	Each	\$

Signature: 

Date: 12/5/23

## Application Fee Schedule

Texas Commission on Environmental Quality

Edwards Aquifer Protection Program 30 TAC Chapter 213 (effective 05/01/2008)

### **Water Pollution Abatement Plans and Modifications**

#### **Contributing Zone Plans and Modifications**

<b>Project</b>	<b>Project Area in Acres</b>	<b>Fee</b>
One Single Family Residential Dwelling	< 5	\$650
Multiple Single Family Residential and Parks	< 5	\$1,500
	5 < 10	\$3,000
	10 < 40	\$4,000
	40 < 100	\$6,500
	100 < 500	\$8,000
	≥ 500	\$10,000
Non-residential (Commercial, industrial, institutional, multi-family residential, schools, and other sites where regulated activities will occur)	< 1	\$3,000
	1 < 5	\$4,000
	5 < 10	\$5,000
	10 < 40	\$6,500
	40 < 100	\$8,000
	≥ 100	\$10,000

#### **Organized Sewage Collection Systems and Modifications**

<b>Project</b>	<b>Cost per Linear Foot</b>	<b>Minimum Fee- Maximum Fee</b>
Sewage Collection Systems	\$0.50	\$650 - \$6,500

#### **Underground and Aboveground Storage Tank System Facility Plans and Modifications**

<b>Project</b>	<b>Cost per Tank or Piping System</b>	<b>Minimum Fee- Maximum Fee</b>
Underground and Aboveground Storage Tank Facility	\$650	\$650 - \$6,500

#### **Exception Requests**

<b>Project</b>	<b>Fee</b>
Exception Request	\$500

***Extension of Time Requests***

<b><i>Project</i></b>	<b><i>Fee</i></b>
Extension of Time Request	\$150

**CORE DATA FORM  
(TCEQ-10400)**



TCEQ Use Only

# TCEQ Core Data Form

For detailed instructions regarding completion of this form, please read the Core Data Form Instructions or call 512-239-5175.

## SECTION I: General Information

<b>1. Reason for Submission</b> (If other is checked please describe in space provided.)		
<input checked="" type="checkbox"/> New Permit, Registration or Authorization (Core Data Form should be submitted with the program application.)		
<input type="checkbox"/> Renewal (Core Data Form should be submitted with the renewal form)	<input type="checkbox"/> Other	
<b>2. Customer Reference Number</b> (if issued)	<a href="#">Follow this link to search for CN or RN numbers in Central Registry**</a>	<b>3. Regulated Entity Reference Number</b> (if issued)
CN 606123701		RN

## SECTION II: Customer Information

<b>4. General Customer Information</b>	<b>5. Effective Date for Customer Information Updates</b> (mm/dd/yyyy)	Veramendi	
<input type="checkbox"/> New Customer <input type="checkbox"/> Update to Customer Information <input type="checkbox"/> Change in Regulated Entity Ownership <input type="checkbox"/> Change in Legal Name (Verifiable with the Texas Secretary of State or Texas Comptroller of Public Accounts)			
<b>The Customer Name submitted here may be updated automatically based on what is current and active with the Texas Secretary of State (SOS) or Texas Comptroller of Public Accounts (CPA).</b>			
<b>6. Customer Legal Name</b> (If an individual, print last name first: eg: Doe, John)		If new Customer, enter previous Customer below:	
Veramendi PE - Emerald, LLC			
<b>7. TX SOS/CPA Filing Number</b>	<b>8. TX State Tax ID</b> (11 digits)	<b>9. Federal Tax ID</b> (9 digits)	<b>10. DUNS Number</b> (if applicable)
0803277761	32070223675	87-1034195	
<b>11. Type of Customer:</b>	<input type="checkbox"/> Corporation	<input type="checkbox"/> Individual	Partnership: <input type="checkbox"/> General <input type="checkbox"/> Limited
Government: <input type="checkbox"/> City <input type="checkbox"/> County <input type="checkbox"/> Federal <input type="checkbox"/> State <input type="checkbox"/> Other	<input type="checkbox"/> Sole Proprietorship	<input type="checkbox"/> Other:	
<b>12. Number of Employees</b>		<b>13. Independently Owned and Operated?</b>	
<input type="checkbox"/> 0-20 <input type="checkbox"/> 21-100 <input type="checkbox"/> 101-250 <input type="checkbox"/> 251-500 <input type="checkbox"/> 501 and higher		<input type="checkbox"/> Yes <input type="checkbox"/> No	
<b>14. Customer Role</b> (Proposed or Actual) – as it relates to the Regulated Entity listed on this form. Please check one of the following			
<input type="checkbox"/> Owner <input type="checkbox"/> Operator <input type="checkbox"/> Owner & Operator <input type="checkbox"/> Occupational Licensee <input type="checkbox"/> Responsible Party <input type="checkbox"/> Voluntary Cleanup Applicant <input type="checkbox"/> Other:			
<b>15. Mailing Address:</b>			
	City	State	ZIP                      ZIP + 4
<b>16. Country Mailing Information</b> (if outside USA)		<b>17. E-Mail Address</b> (if applicable)	
<b>18. Telephone Number</b>	<b>19. Extension or Code</b>	<b>20. Fax Number</b> (if applicable)	
(    ) -		(    ) -	

## SECTION III: Regulated Entity Information

<b>21. General Regulated Entity Information</b> (If "New Regulated Entity" is selected below this form should be accompanied by a permit application)
<input checked="" type="checkbox"/> New Regulated Entity <input type="checkbox"/> Update to Regulated Entity Name <input type="checkbox"/> Update to Regulated Entity Information
<b>The Regulated Entity Name submitted may be updated in order to meet TCEQ Agency Data Standards (removal of organizational endings such as Inc, LP, or LLC).</b>
<b>22. Regulated Entity Name</b> (Enter name of the site where the regulated action is taking place.)
Veramendi Precinct 18 Unit 1



23. Street Address of the Regulated Entity: <i>(No PO Boxes)</i>							
	City		State		ZIP		ZIP + 4
24. County	Comal						

**Enter Physical Location Description if no street address is provided.**

25. Description to Physical Location:	Approximately 1.0 miles Northwest of TX-46/TX-337 and Word Pkwy intersection						
26. Nearest City					State	Nearest ZIP Code	
New Braunfels					TX	78130	
27. Latitude (N) In Decimal:	29.7387			28. Longitude (W) In Decimal:	-98.1441		
Degrees	Minutes	Seconds	Degrees	Minutes	Seconds		
29	44	19.4	98	08	38.7		
29. Primary SIC Code (4 digits)	30. Secondary SIC Code (4 digits)		31. Primary NAICS Code (5 or 6 digits)		32. Secondary NAICS Code (5 or 6 digits)		
1623			237110				
33. What is the Primary Business of this entity? <i>(Do not repeat the SIC or NAICS description.)</i>							
Sewage collection system for single-family residential							
34. Mailing Address:	PO Box 310699						
	City	New Braunfels	State	TX	ZIP	78131	ZIP + 4
35. E-Mail Address:							
36. Telephone Number			37. Extension or Code		38. Fax Number <i>(if applicable)</i>		
( 830 ) 643-1338					( ) -		

**39. TCEQ Programs and ID Numbers** Check all Programs and write in the permits/registration numbers that will be affected by the updates submitted on this form. See the Core Data Form instructions for additional guidance.

<input type="checkbox"/> Dam Safety	<input type="checkbox"/> Districts	<input checked="" type="checkbox"/> Edwards Aquifer	<input type="checkbox"/> Emissions Inventory Air	<input type="checkbox"/> Industrial Hazardous Waste
<input type="checkbox"/> Municipal Solid Waste	<input type="checkbox"/> New Source Review Air	<input type="checkbox"/> OSSF	<input type="checkbox"/> Petroleum Storage Tank	<input type="checkbox"/> PWS
<input type="checkbox"/> Sludge	<input type="checkbox"/> Storm Water	<input type="checkbox"/> Title V Air	<input type="checkbox"/> Tires	<input type="checkbox"/> Used Oil
<input type="checkbox"/> Voluntary Cleanup	<input type="checkbox"/> Waste Water	<input type="checkbox"/> Wastewater Agriculture	<input type="checkbox"/> Water Rights	<input type="checkbox"/> Other:

**SECTION IV: Preparer Information**

40. Name:	Greg Latimer, P.E.		41. Title:	Project Manager
42. Telephone Number	43. Ext./Code	44. Fax Number	45. E-Mail Address	
( 830 ) 632-5633		( ) -	glatimer@pape-dawson.com	

**SECTION V: Authorized Signature**

**46.** By my signature below, I certify, to the best of my knowledge, that the information provided in this form is true and complete, and that I have signature authority to submit this form on behalf of the entity specified in Section II, Field 6 and/or as required for the updates to the ID numbers identified in field 39.

Company:	Pape-Dawson Engineers, Inc.	Job Title:	Vice President
Name <i>(In Print)</i> :	Jocelyn Perez, P.E.	Phone:	( 830 ) 632- 5633
Signature:		Date:	12/5/23

# **EXHIBITS**



Date: Nov 17, 2023, 9:27am User: D:\pawson\pawson\Projects\2023\01\43\Design\Environmental\11-17-2023-45-wpapp.dwg  
 Plot: P:\300\01\43\Design\Environmental\11-17-2023-45-wpapp.dwg

THIS DOCUMENT HAS BEEN PRODUCED FROM MATERIAL THAT WAS STORED AND/OR TRANSMITTED ELECTRONICALLY AND MAY HAVE BEEN INADVERTENTLY ALTERED. RELY ONLY ON FINAL HARDCOPY MATERIALS BEARING THE CONSULTANT'S ORIGINAL SIGNATURE AND SEAL. AERIAL IMAGERY PROVIDED BY GOOGLE/© UNLESS OTHERWISE NOTED. Imagery © 2016, CAPOCO, Digital Globe, Texas Orthology Program, USDA Farm Service Agency.

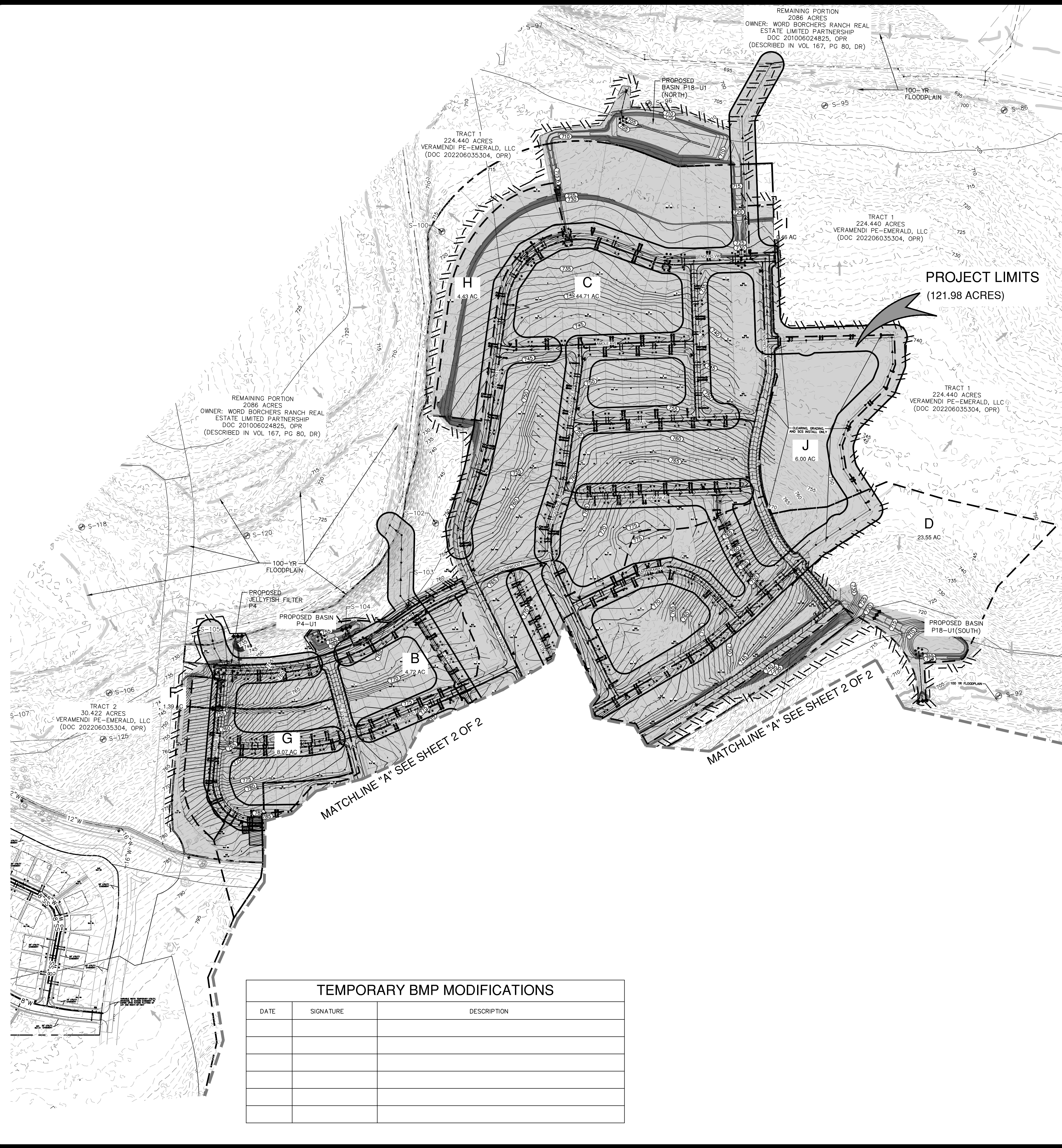

### TCEQ WATER POLLUTION ABATEMENT PLAN GENERAL CONSTRUCTION NOTES

- A WRITTEN NOTICE OF CONSTRUCTION MUST BE SUBMITTED TO THE TCEQ REGIONAL OFFICE AT LEAST 48 HOURS PRIOR TO THE START OF CONSTRUCTION OF ANY REGULATED ACTIVITIES. THIS NOTICE MUST INCLUDE:
    - THE NAME OF THE APPROVED PROJECT;
    - THE ACTIVITY START DATE; AND
    - THE CONTACT INFORMATION OF THE PRIME CONTRACTOR.
  - ALL CONTRACTORS CONDUCTING REGULATED ACTIVITIES ASSOCIATED WITH THIS PROJECT MUST BE PROVIDED WITH COMPLETE COPIES OF THE APPROVED WATER POLLUTION ABATEMENT PLAN (WPAP) AND THE TCEQ LETTER INDICATING THE SPECIFIC CONDITIONS OF ITS APPROVAL. DURING THE COURSE OF THESE REGULATED ACTIVITIES, THE CONTRACTORS ARE REQUIRED TO KEEP ON-SITE COPIES OF THE APPROVED PLAN AND APPROVAL LETTER.
  - IF ANY SENSITIVE FEATURE(S) (CAVES, SOLUTION CAVITY, SINK HOLE, ETC.) IS DISCOVERED DURING CONSTRUCTION, ALL REGULATED ACTIVITIES NEAR THE SENSITIVE FEATURE MUST BE SUSPENDED IMMEDIATELY. THE APPROPRIATE TCEQ REGIONAL OFFICE MUST BE IMMEDIATELY NOTIFIED OF ANY SENSITIVE FEATURES ENCOUNTERED DURING CONSTRUCTION. CONSTRUCTION ACTIVITIES MAY NOT BE RESUMED UNTIL THE TCEQ HAS REVIEWED AND APPROVED THE APPROPRIATE PROTECTIVE MEASURES IN ORDER TO PROTECT ANY SENSITIVE FEATURE AND THE EDWARDS AQUIFER FROM POTENTIALLY ADVERSE IMPACTS TO WATER QUALITY.
  - NO TEMPORARY OR PERMANENT HAZARDOUS SUBSTANCE STORAGE TANK SHALL BE INSTALLED WITHIN 150 FEET OF A WATER SUPPLY SOURCE, DISTRIBUTION SYSTEM, WELL, OR SENSITIVE FEATURE.
  - PRIOR TO BEGINNING ANY CONSTRUCTION ACTIVITY, ALL TEMPORARY EROSION AND SEDIMENTATION (E&S) CONTROL MEASURES MUST BE PROPERLY INSTALLED AND MAINTAINED IN ACCORDANCE WITH THE APPROVED PLANS AND MANUFACTURERS SPECIFICATIONS. IF INSPECTIONS INDICATE A CONTROL HAS BEEN USED INAPPROPRIATELY, OR INCORRECTLY, THE APPLICANT MUST REPLACE OR MODIFY THE CONTROL FOR THE SITE SITUATIONS. THESE CONTROLS MUST REMAIN IN PLACE UNTIL THE DISTURBED AREAS HAVE BEEN PERMANENTLY STABILIZED.
  - ANY SEDIMENT THAT ESCAPES THE CONSTRUCTION SITE MUST BE COLLECTED AND PROPERLY DISPOSED OF BEFORE THE NEXT RAIN EVENT TO ENSURE IT IS NOT WASHED INTO SURFACE STREAMS, SENSITIVE FEATURES, ETC.
  - SEDIMENT MUST BE REMOVED FROM THE SEDIMENT TRAPS OR SEDIMENT BASINS NOT LATER THAN WHEN IT OCCUPIES 50% OF THE BASIN'S DESIGN CAPACITY.
  - LITTER, CONSTRUCTION DEBRIS, AND CONSTRUCTION CHEMICALS EXPOSED TO STORMWATER SHALL BE PREVENTED FROM BEING DISCHARGED OFFSITE. CHROME
  - ALL SPOILS (EXCAVATED MATERIAL) GENERATED FROM THE PROJECT SITE MUST BE STORED ON-SITE WITH PROPER E&S CONTROLS. FOR STORAGE OR DISPOSAL OF SPOILS AT ANOTHER SITE ON THE EDWARDS AQUIFER RECHARGE ZONE, THE OWNER OF THE SITE MUST RECEIVE APPROVAL OF A WATER POLLUTION ABATEMENT PLAN FOR THE PLACEMENT OF FILL MATERIAL OR MASS GRADING PRIOR TO THE PLACEMENT OF SPOILS AT THE OTHER SITE.
  - IF PORTIONS OF THE SITE WILL HAVE A TEMPORARY OR PERMANENT CEASE IN CONSTRUCTION ACTIVITY LASTING LONGER THAN 14 DAYS, SOIL STABILIZATION IN THOSE AREAS SHALL BE INITIATED AS SOON AS POSSIBLE PRIOR TO THE 14TH DAY OF INACTIVITY. IF ACTIVITY WILL RESUME PRIOR TO THE 21ST DAY, STABILIZATION MEASURES ARE NOT REQUIRED. IF DROUGHT CONDITIONS OR INCLEMENT WEATHER PREVENT ACTION BY THE 14TH DAY, STABILIZATION MEASURES SHALL BE INITIATED AS SOON AS POSSIBLE.
  - THE FOLLOWING RECORDS SHALL BE MAINTAINED AND MADE AVAILABLE TO THE TCEQ UPON REQUEST:
    - THE DATES WHEN MAJOR GRADING ACTIVITIES OCCUR;
    - THE DATES WHEN CONSTRUCTION ACTIVITIES TEMPORARILY OR PERMANENTLY CEASE ON A PORTION OF THE SITE; AND
    - THE DATES WHEN STABILIZATION MEASURES ARE INITIATED.
  - THE HOLDER OF ANY APPROVED EDWARDS AQUIFER PROTECTION PLAN MUST NOTIFY THE APPROPRIATE REGIONAL OFFICE IN WRITING AND OBTAIN APPROVAL FROM THE EXECUTIVE DIRECTOR PRIOR TO INITIATING ANY OF THE FOLLOWING:
    - ANY PHYSICAL OR OPERATIONAL MODIFICATION OF ANY WATER POLLUTION ABATEMENT STRUCTURE(S), INCLUDING BUT NOT LIMITED TO PONDS, DAMS, BERMS, SEWAGE TREATMENT PLANTS, AND DIVERSIONARY STRUCTURES;
    - ANY CHANGE IN THE NATURE OR CHARACTER OF THE REGULATED ACTIVITY FROM THAT WHICH WAS ORIGINALLY APPROVED OR A CHANGE WHICH WOULD SIGNIFICANTLY IMPACT THE ABILITY OF THE PLAN TO PREVENT POLLUTION OF THE EDWARDS AQUIFER;
    - ANY DEVELOPMENT OF LAND PREVIOUSLY IDENTIFIED AS UNDEVELOPED IN THE ORIGINAL WATER POLLUTION ABATEMENT PLAN.
- SAN ANTONIO REGIONAL OFFICE  
 14250 JUDSON ROAD  
 SAN ANTONIO TEXAS 78233-4480  
 PHONE (210) 490-3096  
 FAX (210) 545-4329

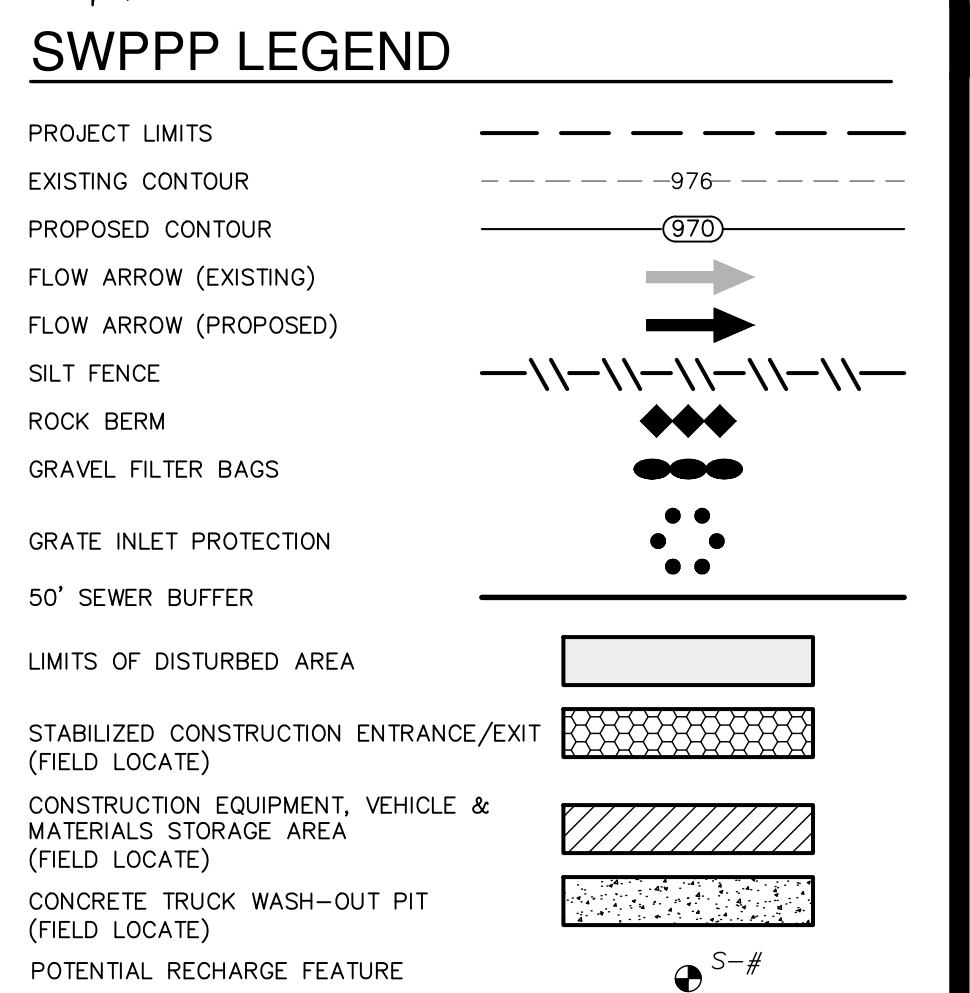
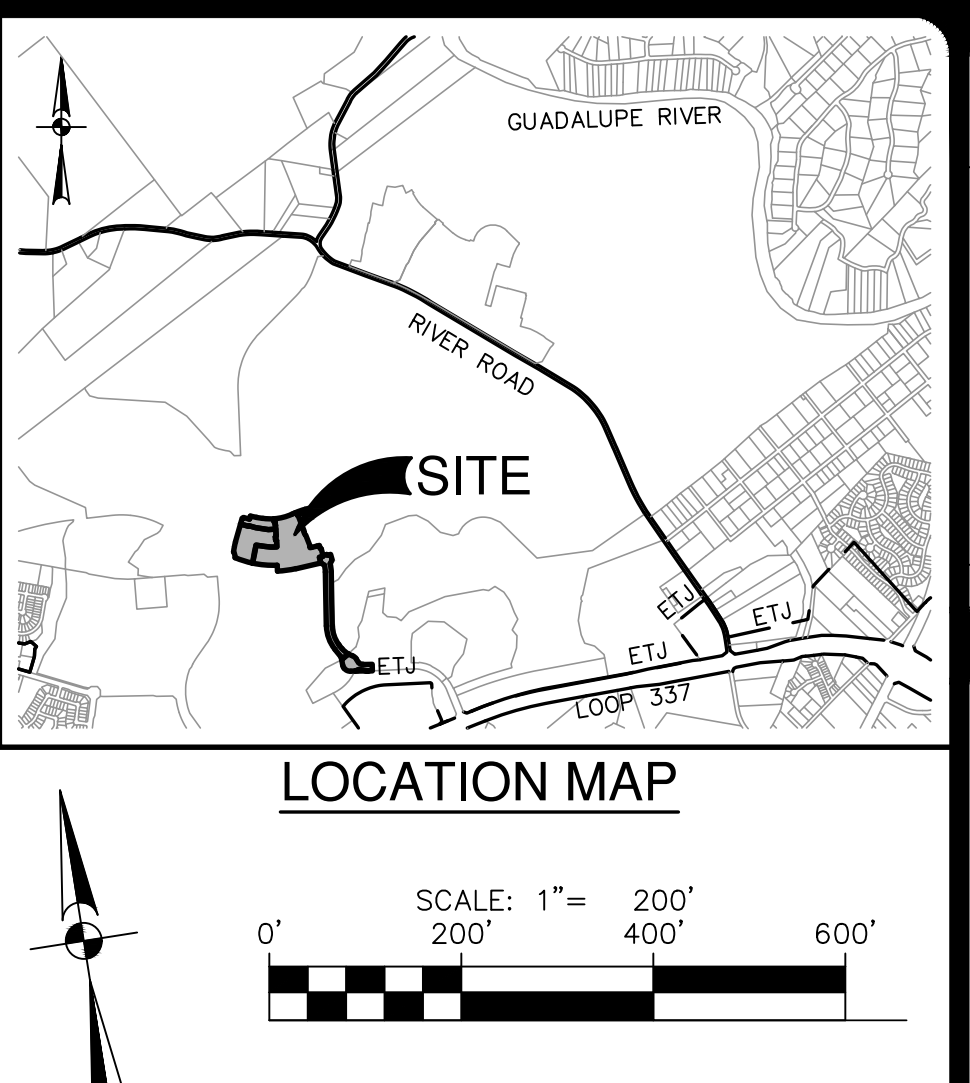

#### GENERAL NOTES

- DO NOT DISTURB VEGETATED AREAS (TREES, GRASS, WEEDS, BRUSH, ETC.) ANY MORE THAN NECESSARY FOR CONSTRUCTION.
- CONSTRUCTION ENTRANCE/EXIT LOCATION, CONCRETE WASH-OUT PIT, AND CONSTRUCTION EQUIPMENT AND MATERIAL STORAGE YARD TO BE DETERMINED IN THE FIELD.
- STORM WATER POLLUTION PREVENTION CONTROLS MAY NEED TO BE MODIFIED IN THE FIELD TO ACCOMPLISH THE DESIRED EFFECT. ALL MODIFICATIONS ARE TO BE NOTED ON THIS EXHIBIT AND SIGNED AND DATED BY THE RESPONSIBLE PARTY.
- RESTRICT ENTRY/EXIT TO THE PROJECT SITE TO DESIGNATED LOCATIONS BY USE OF ADEQUATE FENCING, IF NECESSARY.
- ALL STORM WATER POLLUTION PREVENTION CONTROLS ARE TO BE MAINTAINED AND IN WORKING CONDITIONS AT ALL TIMES.
- FOR A COMPLETE LISTING OF TEMPORARY STORM WATER POLLUTION PREVENTION CONTROLS REFER TO THE TPDES STORM WATER POLLUTION PREVENTION PLAN.
- STORM WATER POLLUTION PREVENTION STRUCTURES SHOULD BE CONSTRUCTED WITHIN THE SITE BOUNDARIES. SOME OF THESE FEATURES MAY BE SHOWN OUTSIDE THE SITE BOUNDARIES ON THIS PLAN FOR VISUAL CLARITY.
- AS SOON AS PRACTICAL, ALL DISTURBED SOIL THAT WILL NOT BE COVERED BY IMPERVIOUS COVER SUCH AS PARKWAY AREAS, EASEMENT AREAS, EMBANKMENT SLOPES, ETC. WILL BE STABILIZED PER APPLICABLE PROJECT SPECIFICATIONS.
- BEST MANAGEMENT PRACTICES MAY BE INSTALLED IN STAGES TO COINCIDE WITH THE DISTURBANCE OF UPGRADE AREAS.
- BEST MANAGEMENT PRACTICES MAY BE REMOVED IN STAGES ONCE THE WATERSHED FOR THAT PORTION CONTROLLED BY THE BEST MANAGEMENT PRACTICES HAS BEEN STABILIZED IN ACCORDANCE WITH TPDES REQUIREMENTS.
- UPON COMPLETION OF THE PROJECT, INCLUDING SITE STABILIZATION, AND BEFORE FINAL PAYMENT IS ISSUED, CONTRACTOR SHALL REMOVE ALL SEDIMENT AND EROSION CONTROL MEASURES, PAYING SPECIAL ATTENTION TO ROCK BERMS IN DRAINAGE FEATURES.
- WHERE VEGETATED FILTER STRIPS ARE INDICATED, CONTRACTOR SHALL VERIFY THAT SUFFICIENT VEGETATION EXISTS, OTHERWISE CONTRACTOR SHALL PLACE SILT FENCING IN LIEU OF VEGETATED FILTER STRIP.
- SHADED AREA □ DENOTES LIMITS OF DISTURBED AREAS. OTHER AREAS WITHIN THE PROJECT LIMITS, WITH THE EXCEPTION OF A CONSTRUCTION EQUIPMENT AND MATERIAL STORAGE YARD, ARE NOT A PART OF THIS TPDES STORM WATER POLLUTION PREVENTION PLAN (SWP3) AND WILL NOT BE DISTURBED BY CIVIL CONSTRUCTION ACTIVITIES.
- PRIOR TO BEGINNING CONSTRUCTION, CONTRACTOR SHALL COORDINATE PLACEMENT OF TEMPORARY BEST MANAGEMENT PRACTICES WITHIN TXDOT RIGHT-OF-WAY WITH TXDOT.
- NBU WILL FUNCTION AS A SECONDARY OPERATOR ON THIS PROJECT AND WILL BE INSTALLING ELECTRIC UTILITIES FOR ON-SITE CONSTRUCTION AND OFF-SITE FEED TO THE PROJECT.
- PER TPDES REQUIREMENTS, DISTURBED AREAS ON WHICH CONSTRUCTION ACTIVITIES HAVE CEASED (TEMPORARILY OR PERMANENTLY) SHALL BE STABILIZED WITHIN 14 DAYS UNLESS ACTIVITY RESUMES WITHIN 21 DAYS. SEEDING DOES NOT CONSTITUTE AS STABILIZATION.

DATE	SIGNATURE	DESCRIPTION

THE ENGINEERING SEAL HAS BEEN AFFIXED TO THIS SHEET ONLY FOR THE PURPOSE OF DEMONSTRATING COMPLIANCE WITH THE WATER POLLUTION ABATEMENT PLANS (WPAP) REGULATIONS.  
 THIS SHEET HAS BEEN PREPARED FOR PURPOSES OF THE WPAP ONLY. ALL OTHER CIVIL ENGINEERING RELATED INFORMATION SHOULD BE ACQUIRED FROM THE APPROPRIATE SHEET IN THE CIVIL IMPROVEMENT PLANS.

**EXHIBIT 1**

DATE	
NO.	
REVISION	

11-17-2023

**Jocelyn Perez**  
 PROFESSIONAL ENGINEER

**PAPE-DAWSON ENGINEERS**

NEW BRUNNELS | SAN ANTONIO | AUSTIN | HOUSTON | FT WORTH | DALLAS  
 1075 INDEPENDENCE DR. STE 102 | NEW BRUNNELS, TX 78122 | 800.652.5653  
 TEXAS ENGINEERING FIRM #479 | TEXAS SURVEYING FIRM #1008880

VERAMENDI WORD PKWY PHASE 3,  
 PRECINCT 18 UNIT 1, PRECINCT 4 UNIT 1, 2, & 3  
 WATER POLLUTION ABATEMENT PLAN  
 TEMPORARY POLLUTION ABATEMENT PLAN

PLAT NO.	
JOB NO.	30001-45
DATE	SEPTEMBER 2023
DESIGNER	GDL
CHECKED	DRAWN
SHEET	1 OF 2

FOR PERMIT



**TCEQ WATER POLLUTION ABATEMENT PLAN GENERAL CONSTRUCTION NOTES**

1. A WRITTEN NOTICE OF CONSTRUCTION MUST BE SUBMITTED TO THE TCEQ REGIONAL OFFICE AT LEAST 48 HOURS PRIOR TO THE START OF CONSTRUCTION OF ANY REGULATED ACTIVITIES. THIS NOTICE MUST INCLUDE:
  - THE NAME OF THE APPROVED PROJECT;
  - THE ACTIVITY START DATE; AND
  - THE CONTACT INFORMATION OF THE PRIME CONTRACTOR.
2. ALL CONTRACTORS CONDUCTING REGULATED ACTIVITIES ASSOCIATED WITH THIS PROJECT MUST BE PROVIDED WITH COMPLETE COPIES OF THE APPROVED WATER POLLUTION ABATEMENT PLAN (WPAP) AND THE TCEQ LETTER INDICATING THE SPECIFIC CONDITIONS OF ITS APPROVAL. DURING THE COURSE OF THESE REGULATED ACTIVITIES, THE CONTRACTORS ARE REQUIRED TO KEEP ON-SITE COPIES OF THE APPROVED PLAN AND APPROVAL LETTER.
3. IF ANY SENSITIVE FEATURE(S) (CAVES, SOLUTION CAVITY, SINK HOLE, ETC.) IS DISCOVERED DURING CONSTRUCTION, ALL REGULATED ACTIVITIES NEAR THE SENSITIVE FEATURE MUST BE SUSPENDED IMMEDIATELY. THE APPROPRIATE TCEQ REGIONAL OFFICE MUST BE IMMEDIATELY NOTIFIED OF ANY SENSITIVE FEATURES ENCOUNTERED DURING CONSTRUCTION. CONSTRUCTION ACTIVITIES MAY NOT BE RESUMED UNTIL THE TCEQ HAS REVIEWED AND APPROVED THE APPROPRIATE PROTECTIVE MEASURES IN ORDER TO PROTECT ANY SENSITIVE FEATURE AND THE EDWARDS AQUIFER FROM POTENTIALLY ADVERSE IMPACTS TO WATER QUALITY.
4. NO TEMPORARY OR PERMANENT HAZAROUS SUBSTANCE STORAGE TANK SHALL BE INSTALLED WITHIN 150 FEET OF A WATER SUPPLY SOURCE, DISTRIBUTION SYSTEM, WELL, OR SENSITIVE FEATURE.
5. PRIOR TO BEGINNING ANY CONSTRUCTION ACTIVITY, ALL TEMPORARY EROSION AND SEDIMENTATION (E&S) CONTROL MEASURES MUST BE PROPERLY INSTALLED AND MAINTAINED IN ACCORDANCE WITH THE APPROVED PLANS AND MANUFACTURERS SPECIFICATIONS. IF INSPECTIONS INDICATE A CONTROL HAS BEEN USED INAPPROPRIATELY, OR INCORRECTLY, THE APPLICANT MUST REPLACE OR MODIFY THE CONTROL FOR THE SITE SITUATIONS. THESE CONTROLS MUST REMAIN IN PLACE UNTIL THE DISTURBED AREAS HAVE BEEN PERMANENTLY STABILIZED.
6. ANY SEDIMENT THAT ESCAPES THE CONSTRUCTION SITE MUST BE COLLECTED AND PROPERLY DISPOSED OF BEFORE THE NEXT RAIN EVENT TO ENSURE IT IS NOT WASHED INTO SURFACE STREAMS, SENSITIVE FEATURES, ETC.
7. SEDIMENT MUST BE REMOVED FROM THE SEDIMENT TRAPS OR SEDIMENT BASINS NOT LATER THAN WHEN IT OCCUPIES 50% OF THE BASIN'S DESIGN CAPACITY.
8. LITTER, CONSTRUCTION DEBRIS, AND CONSTRUCTION CHEMICALS EXPOSED TO STORMWATER SHALL BE PREVENTED FROM BEING DISCHARGED OFFSITE. CHROME
9. ALL SPOILS (EXCAVATED MATERIAL) GENERATED FROM THE PROJECT SITE MUST BE STORED ON-SITE WITH PROPER E&S CONTROLS. FOR STORAGE OR DISPOSAL OF SPOILS AT ANOTHER SITE ON THE EDWARDS AQUIFER RECHARGE ZONE, THE OWNER OF THE SITE MUST RECEIVE APPROVAL OF A WATER POLLUTION ABATEMENT PLAN FOR THE PLACEMENT OF FILL MATERIAL OR MASS GRADING PRIOR TO THE PLACEMENT OF SPOILS AT THE OTHER SITE.
10. IF PORTIONS OF THE SITE WILL HAVE A TEMPORARY OR PERMANENT CEASE IN CONSTRUCTION ACTIVITY LASTING LONGER THAN 14 DAYS, SOIL STABILIZATION IN THOSE AREAS SHALL BE INITIATED AS SOON AS POSSIBLE PRIOR TO THE 14TH DAY OF INACTIVITY. IF ACTIVITY WILL RESUME PRIOR TO THE 21ST DAY, STABILIZATION MEASURES ARE NOT REQUIRED. IF DROUGHT CONDITIONS OR INCLEMENT WEATHER PREVENT ACTION BY THE 14TH DAY, STABILIZATION MEASURES SHALL BE INITIATED AS SOON AS POSSIBLE.
11. THE FOLLOWING RECORDS SHALL BE MAINTAINED AND MADE AVAILABLE TO THE TCEQ UPON REQUEST:
  - THE DATES WHEN MAJOR GRADING ACTIVITIES OCCUR;
  - THE DATES WHEN CONSTRUCTION ACTIVITIES TEMPORARILY OR PERMANENTLY CEASE ON A PORTION OF THE SITE; AND
  - THE DATES WHEN STABILIZATION MEASURES ARE INITIATED.
12. THE HOLDER OF ANY APPROVED EDWARDS AQUIFER PROTECTION PLAN MUST NOTIFY THE APPROPRIATE REGIONAL OFFICE IN WRITING AND OBTAIN APPROVAL FROM THE EXECUTIVE DIRECTOR PRIOR TO INITIATING ANY OF THE FOLLOWING:
  - A. ANY PHYSICAL OR OPERATIONAL MODIFICATION OF ANY WATER POLLUTION ABATEMENT STRUCTURE(S), INCLUDING BUT NOT LIMITED TO PONDS, DAMS, BERMS, SEWAGE TREATMENT PLANTS, AND DIVERSIONARY STRUCTURES;
  - B. ANY CHANGE IN THE NATURE OR CHARACTER OF THE REGULATED ACTIVITY FROM THAT WHICH WAS ORIGINALLY APPROVED OR A CHANGE WHICH WOULD SIGNIFICANTLY IMPACT THE ABILITY OF THE PLAN TO PREVENT POLLUTION OF THE EDWARDS AQUIFER;
  - C. ANY DEVELOPMENT OF LAND PREVIOUSLY IDENTIFIED AS UNDEVELOPED IN THE ORIGINAL WATER POLLUTION ABATEMENT PLAN.

SAN ANTONIO REGIONAL OFFICE  
14250 JUDSON ROAD  
SAN ANTONIO TEXAS 78233-4480  
PHONE (210) 490-3096  
FAX (210) 545-4329

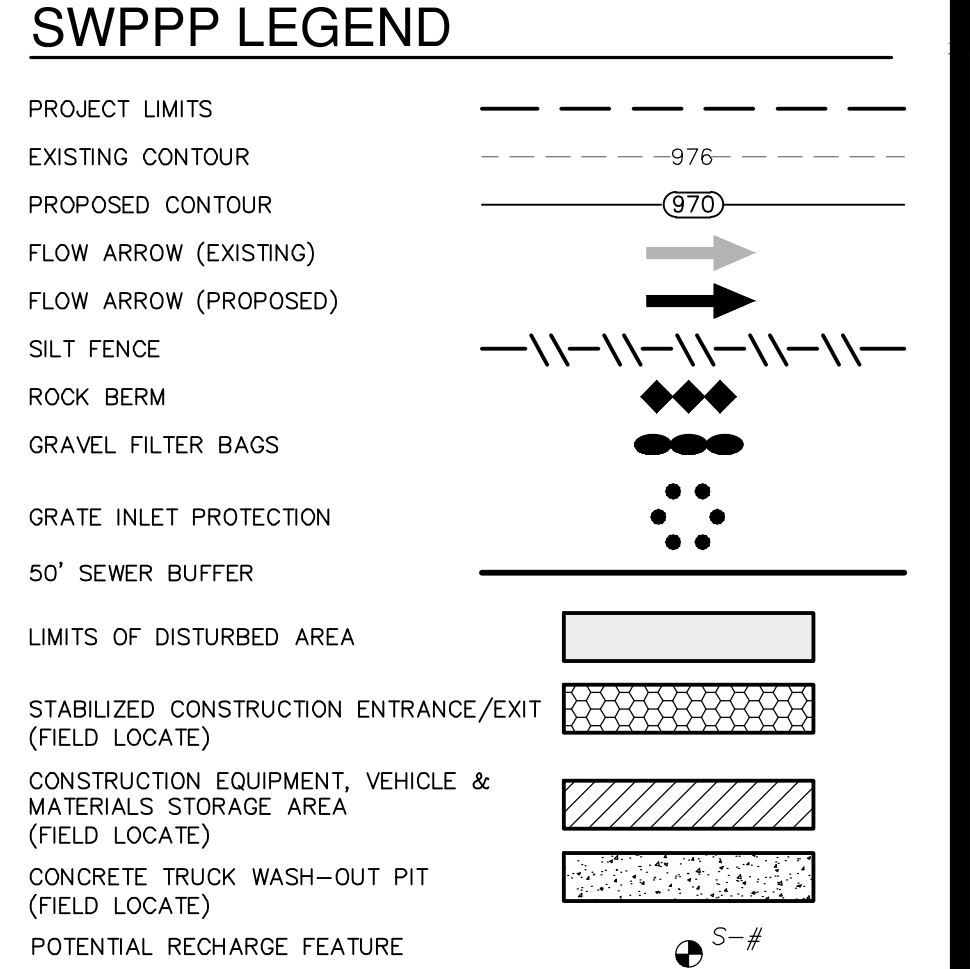
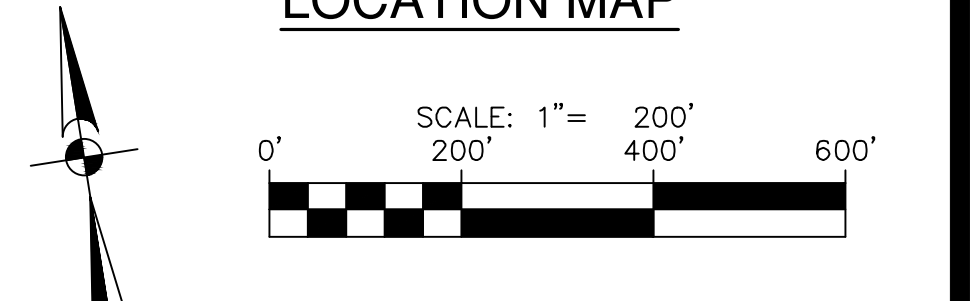
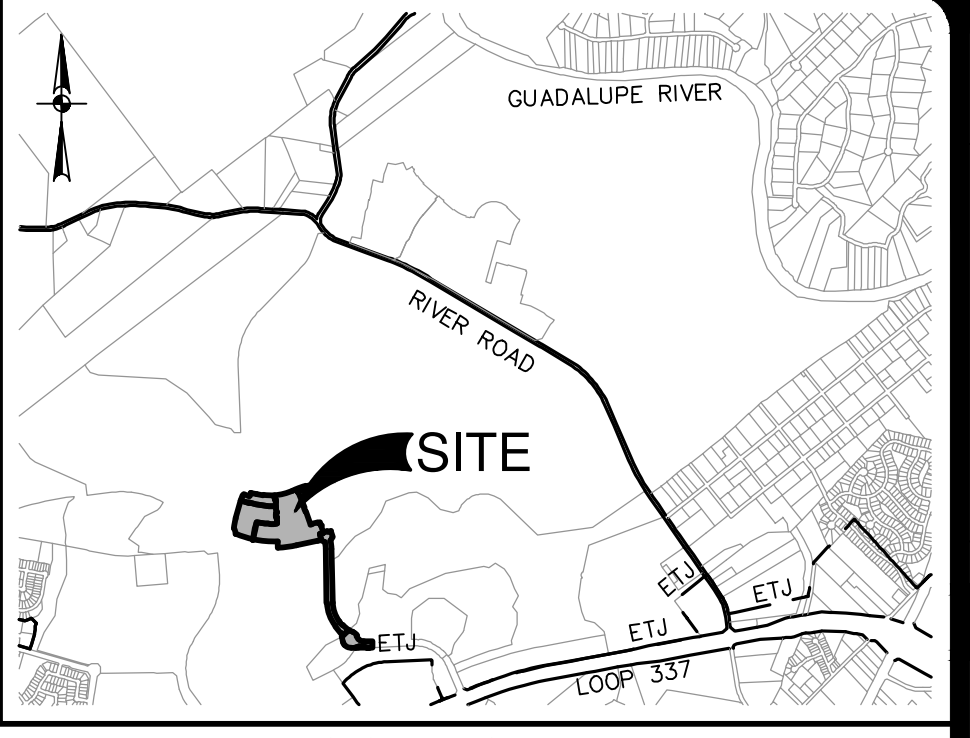

**GENERAL NOTES**

1. DO NOT DISTURB VEGETATED AREAS (TREES, GRASS, WEEDS, BRUSH, ETC.) ANY MORE THAN NECESSARY FOR CONSTRUCTION.
2. CONSTRUCTION ENTRANCE/EXIT LOCATION, CONCRETE WASH-OUT PIT, AND CONSTRUCTION EQUIPMENT AND MATERIAL STORAGE YARD TO BE DETERMINED IN THE FIELD.
3. STORM WATER POLLUTION PREVENTION CONTROLS MAY NEED TO BE MODIFIED IN THE FIELD TO ACCOMPLISH THE DESIRED EFFECT. ALL MODIFICATIONS ARE TO BE NOTED ON THIS EXHIBIT AND SIGNED AND DATED BY THE RESPONSIBLE PARTY.
4. RESTRICT ENTRY/EXIT TO THE PROJECT SITE TO DESIGNATED LOCATIONS BY USE OF ADEQUATE FENCING, IF NECESSARY.
5. ALL STORM WATER POLLUTION PREVENTION CONTROLS ARE TO BE MAINTAINED AND IN WORKING CONDITIONS AT ALL TIMES.
6. FOR A COMPLETE LISTING OF TEMPORARY STORM WATER POLLUTION PREVENTION CONTROLS REFER TO THE TPDES STORM WATER POLLUTION PREVENTION PLAN.
7. STORM WATER POLLUTION PREVENTION STRUCTURES SHOULD BE CONSTRUCTED WITHIN THE SITE BOUNDARIES. SOME OF THESE FEATURES MAY BE SHOWN OUTSIDE THE SITE BOUNDARIES ON THIS PLAN FOR VISUAL CLARITY.
8. AS SOON AS PRACTICAL, ALL DISTURBED SOIL THAT WILL NOT BE COVERED BY IMPROVED VEGETATION, PARKWAY AREAS, EASEMENT AREAS, EMBANKMENT SLOPES, ETC. WILL BE STABILIZED PER APPLICABLE PROJECT SPECIFICATIONS.
9. BEST MANAGEMENT PRACTICES MAY BE INSTALLED IN STAGES TO COINCIDE WITH THE DISTURBANCE OF UPGRADE AREAS.
10. BEST MANAGEMENT PRACTICES MAY BE REMOVED IN STAGES ONCE THE WATERSHED FOR THAT PORTION CONTROLLED BY THE BEST MANAGEMENT PRACTICES HAS BEEN STABILIZED IN ACCORDANCE WITH TPDES REQUIREMENTS.
11. UPON COMPLETION OF THE PROJECT, INCLUDING SITE STABILIZATION, AND BEFORE FINAL PAYMENT IS ISSUED, CONTRACTOR SHALL REMOVE ALL SEDIMENT AND EROSION CONTROL MEASURES, PAYING SPECIAL ATTENTION TO ROCK BERMS IN DRAINAGE FEATURES.
12. WHERE VEGETATED FILTER STRIPS ARE INDICATED, CONTRACTOR SHALL VERIFY THAT SUFFICIENT VEGETATION EXISTS. OTHERWISE CONTRACTOR SHALL PLACE SILT FENCING IN LIEU OF VEGETATED FILTER STRIP.
13. SHADED AREA DENOTES LIMITS OF DISTURBED AREAS. OTHER AREAS WITHIN THE PROJECT LIMITS, WITH THE EXCEPTION OF A CONSTRUCTION EQUIPMENT AND MATERIAL STORAGE YARD, ARE NOT A PART OF THIS TPDES STORM WATER POLLUTION PREVENTION PLAN (SWP3) AND WILL NOT BE DISTURBED BY CIVIL CONSTRUCTION ACTIVITIES.
14. PRIOR TO BEGINNING CONSTRUCTION, CONTRACTOR SHALL COORDINATE PLACEMENT OF TEMPORARY BEST MANAGEMENT PRACTICES WITHIN TxDOT RIGHT-OF-WAY WITH TxDOT.
15. NBUL WILL FUNCTION AS A SECONDARY OPERATOR ON THIS PROJECT AND WILL BE INSTALLING ELECTRIC UTILITIES FOR ON-SITE CONSTRUCTION AND OFF-SITE FEED TO THE PROJECT.
16. PER TPDES REQUIREMENTS, DISTURBED AREAS ON WHICH CONSTRUCTION ACTIVITIES HAVE CEASED (TEMPORARILY OR PERMANENTLY) SHALL BE STABILIZED WITHIN 14 DAYS UNLESS ACTIVITY RESUMES WITHIN 21 DAYS. SEEDING DOES NOT CONSTITUTE AS STABILIZATION.

THE ENGINEERING SEAL HAS BEEN AFFIXED TO THIS SHEET ONLY FOR THE PURPOSE OF DEMONSTRATING COMPLIANCE WITH THE WATER POLLUTION ABATEMENT PLANS (WPAP) REGULATIONS.

THIS SHEET HAS BEEN PREPARED FOR PURPOSES OF THE WPAP ONLY. ALL OTHER CIVIL ENGINEERING RELATED INFORMATION SHOULD BE ACQUIRED FROM THE APPROPRIATE SHEET IN THE CIVIL IMPROVEMENT PLANS.

**EXHIBIT 1**

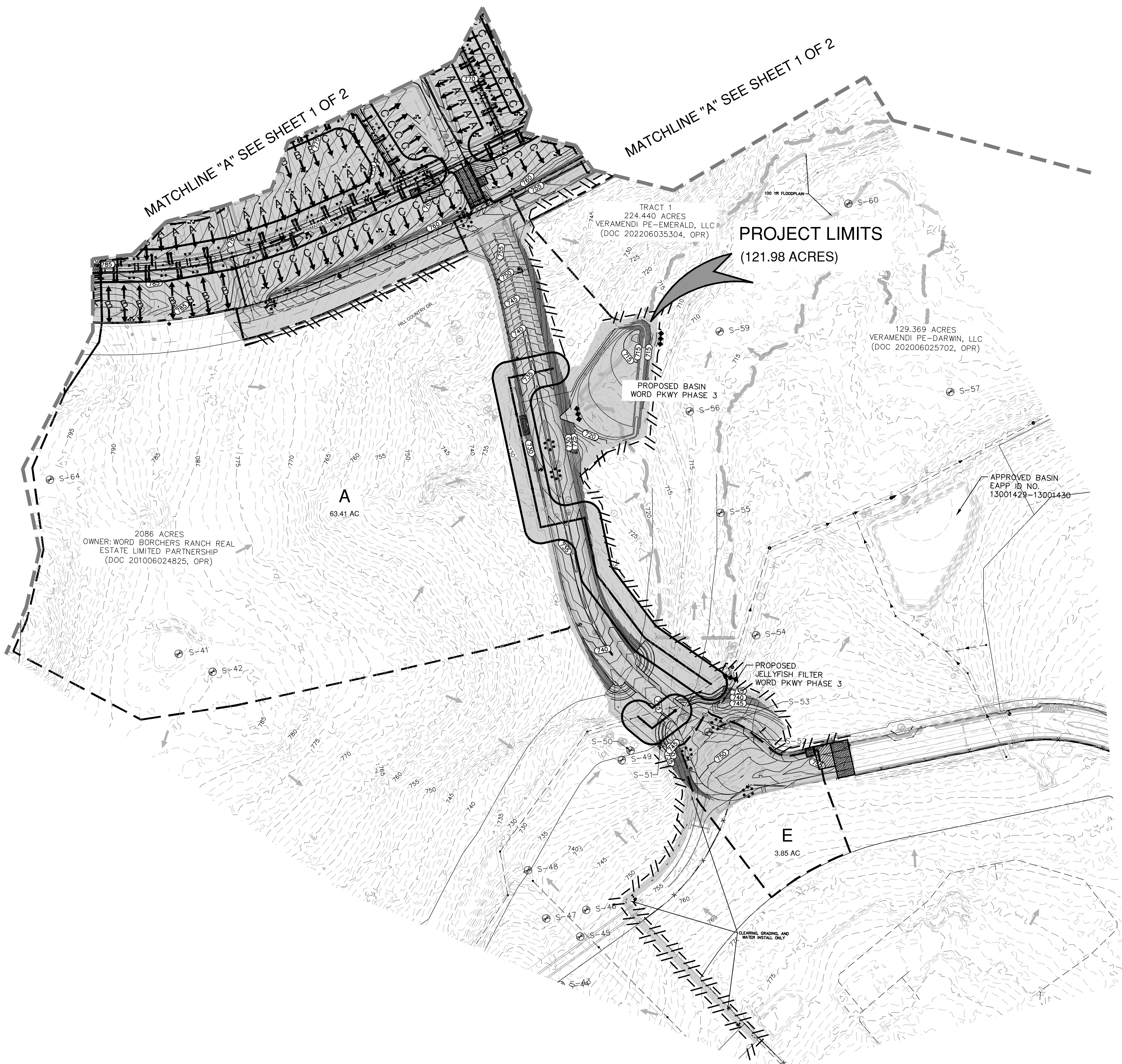

MATCHLINE "A" SEE SHEET 1 OF 2

MATCHLINE "A" SEE SHEET 1 OF 2

**PROJECT LIMITS**  
(121.98 ACRES)

TRACT 1  
224.440 ACRES  
VERAMENDI PE-EMERALD, LLC  
(DOC 202206035304, OPR)

129.369 ACRES  
VERAMENDI PE-DARWIN, LLC  
(DOC 202006025702, OPR)

2086 ACRES  
OWNER: WORD BORCHERS RANCH REAL ESTATE LIMITED PARTNERSHIP  
(DOC 201006024825, OPR)

A  
63.41 AC

E  
3.85 AC

TEMPORARY BMP MODIFICATIONS		
DATE	SIGNATURE	DESCRIPTION

DATE	
NO.	
REVISION	

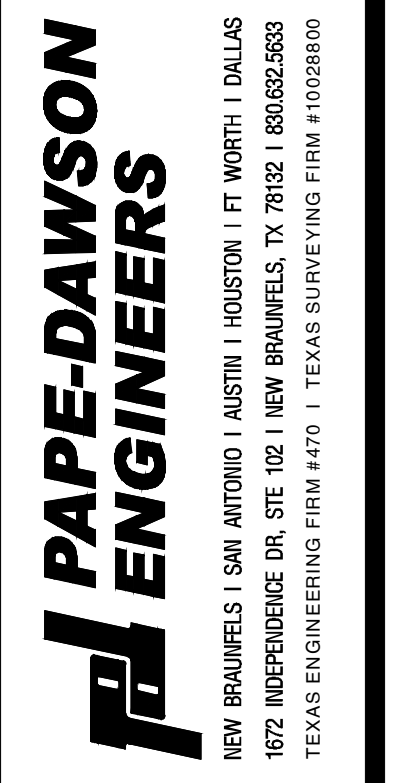
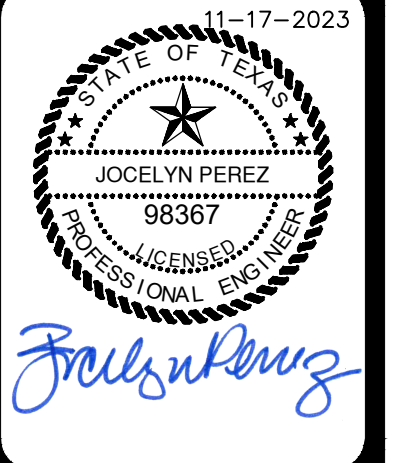

**VERAMENDI WORD PKWY PHASE 3,  
PRECINCT 18 UNIT 1, PRECINCT 4 UNIT 1, 2, & 3  
WATER POLLUTION ABATEMENT PLAN  
TEMPORARY POLLUTION ABATEMENT PLAN**

PLAT NO.	
JOB NO.	30001-45
DATE	SEPTEMBER 2023
DESIGNER	
CHECKED	DRAWN
SHEET	2 OF 2

FOR PERMIT

Date: Dec 01, 2023, 9:33am User: D:\jpc\act... File: P:\30001\01\45\Design\Environmental\18-30001-45-wp3p.dwg

THIS DOCUMENT HAS BEEN PRODUCED FROM MATERIAL THAT WAS STORED AND/OR TRANSMITTED ELECTRONICALLY AND MAY HAVE BEEN INADVERTENTLY ALTERED. RELY ONLY ON FINAL HARDCOPY MATERIALS BEARING THE CONSULTANT'S ORIGINAL SIGNATURE AND SEAL. AERIAL IMAGERY PROVIDED BY GOOGLE/UNLESS OTHERWISE NOTED. Imagery © 2016, CAPOCO, Digital Globe, Texas Orthographic Program, USDA Farm Service Agency.



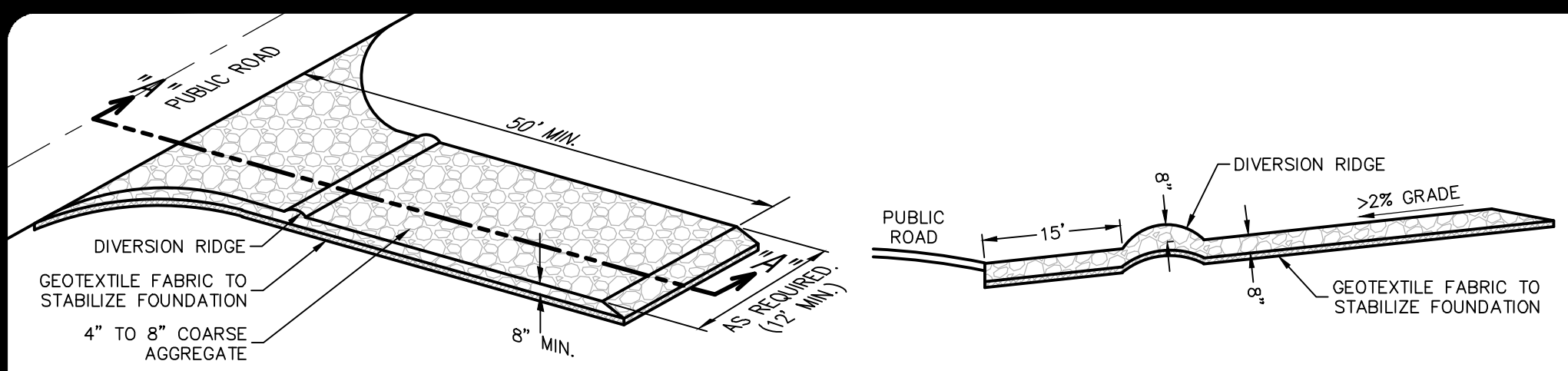

**SCHEMATIC OF TEMPORARY CONSTRUCTION ENTRANCE/EXIT**



**SECTION "A-A" OF A CONSTRUCTION ENTRANCE/EXIT**

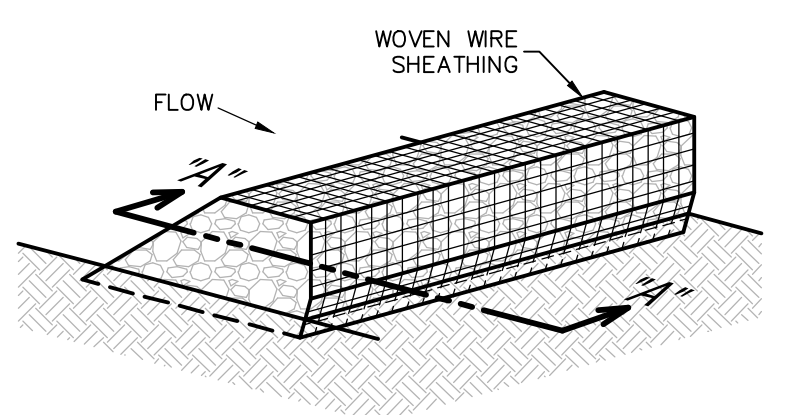

**ISOMETRIC PLAN VIEW**

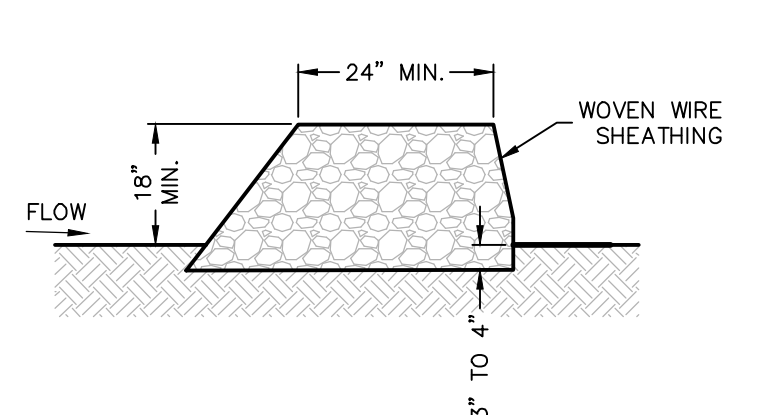

**SECTION "A-A"**

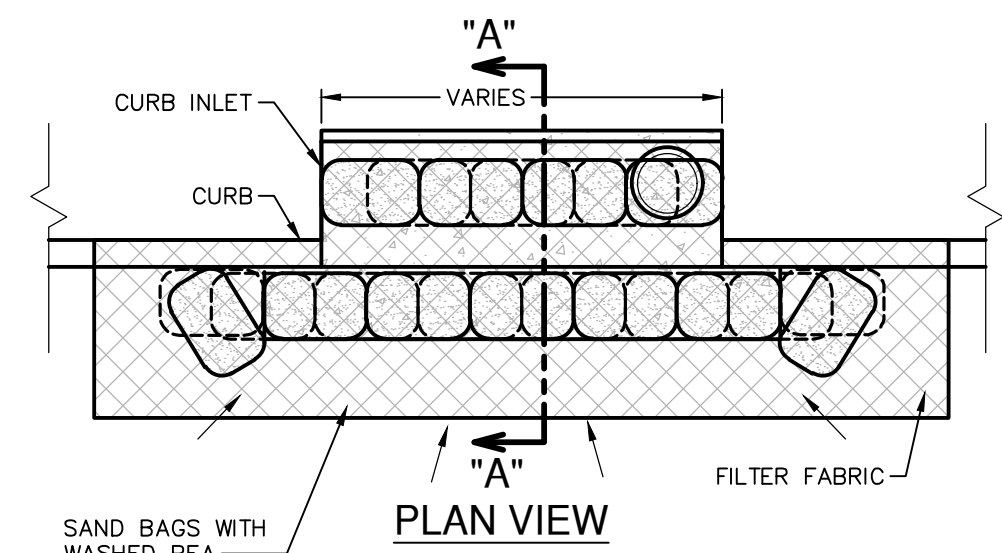

**PLAN VIEW**

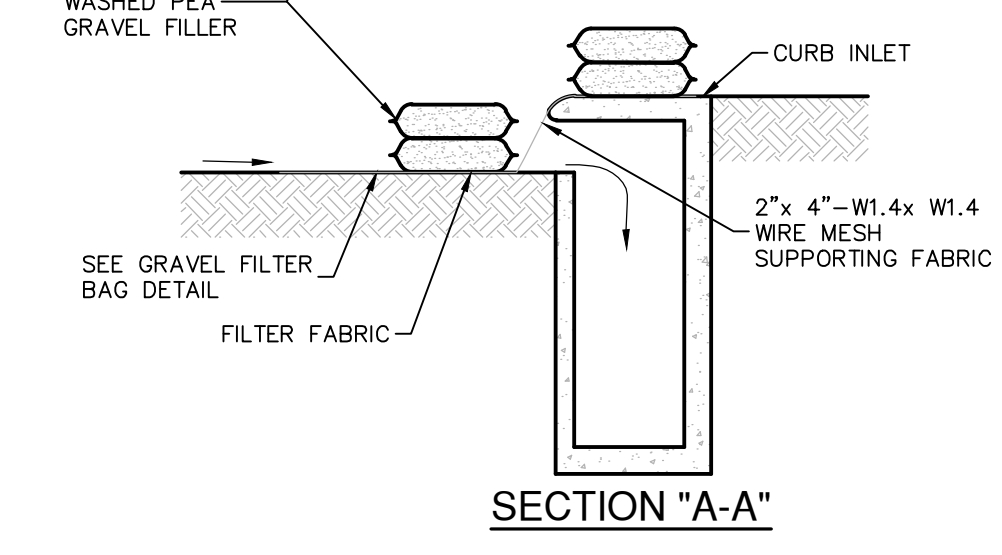

**SECTION "A-A"**

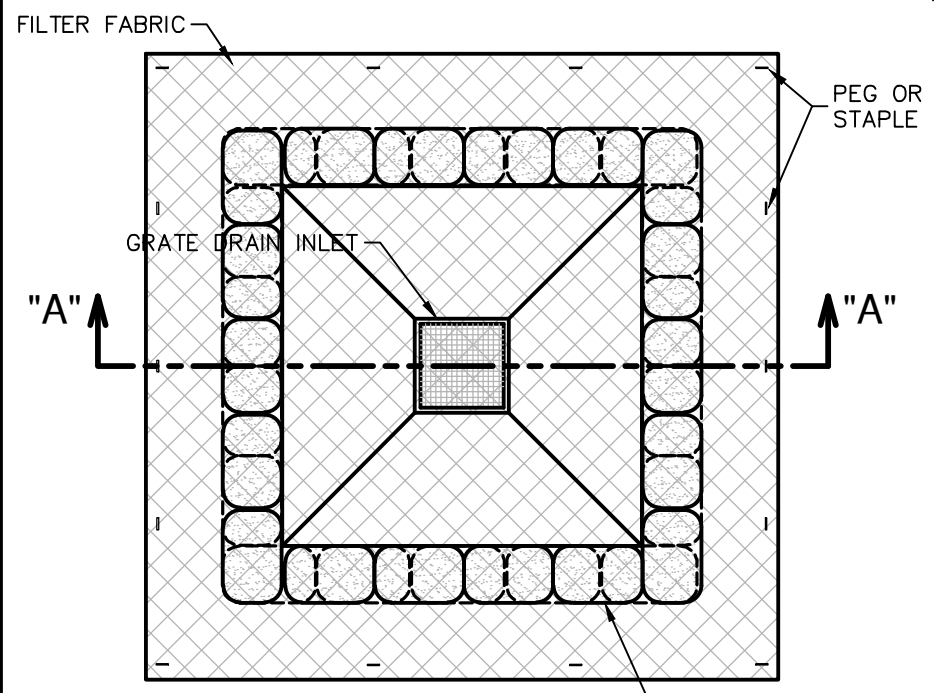

**PLAN VIEW**

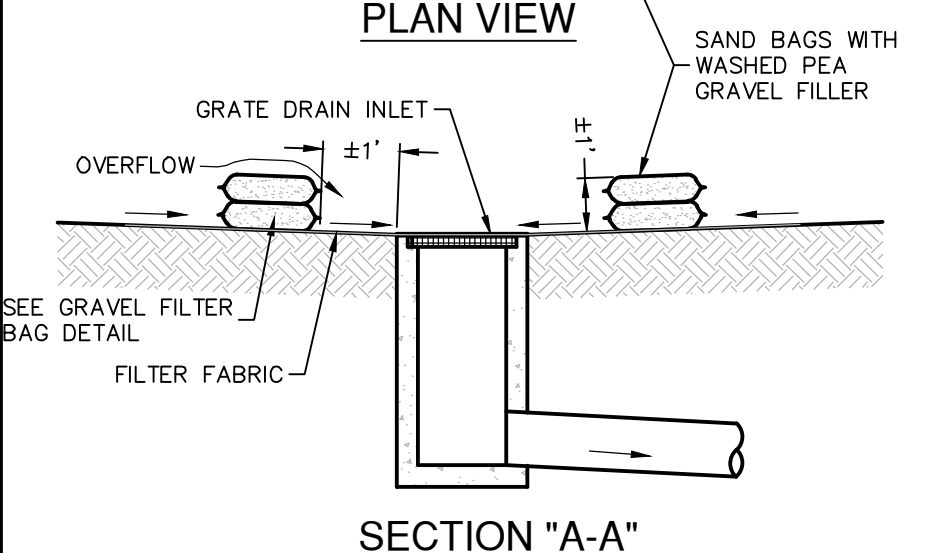

**SECTION "A-A"**

**MATERIALS**  
 1. THE AGGREGATE SHOULD CONSIST OF 4-INCH TO 8-INCH WASHED STONE OVER A STABLE FOUNDATION AS SPECIFIED IN THE PLAN.  
 2. THE AGGREGATE SHOULD BE PLACED WITH A MINIMUM THICKNESS OF 8-INCHES.  
 3. THE GEOTEXTILE FABRIC SHOULD BE DESIGNED SPECIFICALLY FOR USE AS A SOIL FILTRATION MEDIA WITH AN APPROXIMATE WEIGHT OF 6 OZ/YD<sup>2</sup>, A MULLEN BURST RATING OF 140 LB/IN<sup>2</sup>, AND AN EQUIVALENT OPENING SIZE GREATER THAN A NUMBER 50 SIEVE.  
 4. IF A WASHING FACILITY IS REQUIRED, A LEVEL AREA WITH A MINIMUM OF 4-INCH DIAMETER WASHED STONE OR COMMERCIAL ROCK SHOULD BE INCLUDED IN THE PLANS. DIVERT WASTEWATER TO A SEDIMENT TRAP OR BASIN.

**INSTALLATION**  
 1. AVOID CURVES ON PUBLIC ROADS AND STEEP SLOPES. REMOVE VEGETATION AND OTHER OBJECTIONABLE MATERIAL FROM THE FOUNDATION AREA. GRADE CROWN FOUNDATION FOR POSITIVE DRAINAGE.  
 2. THE MINIMUM WIDTH OF THE ENTRANCE/EXIT SHOULD BE 12 FEET OR THE FULL WIDTH OF EXIT ROADWAY, WHICHEVER IS GREATER.  
 3. THE CONSTRUCTION ENTRANCE SHOULD BE AT LEAST 50 FEET LONG.  
 4. IF THE SLOPE TOWARD THE ROAD EXCEEDS 2%, CONSTRUCT A RIDGE, 6-INCHES TO 8-INCHES HIGH WITH 3:1 (H:V) SIDE SLOPES, ACROSS THE FOUNDATION APPROXIMATELY 15 FEET FROM THE ENTRANCE TO DIVERT RUNOFF AWAY FROM THE PUBLIC ROAD.  
 5. PLACE GEOTEXTILE FABRIC AND GRADE FOUNDATION TO IMPROVE STABILITY, ESPECIALLY WHERE WET CONDITIONS ARE ANTICIPATED.  
 6. PLACE STONE TO DIMENSIONS AND GRADE SHOWN ON PLANS. LEAVE SURFACE SMOOTH AND SLOPE FOR DRAINAGE.  
 7. DIVERT ALL SURFACE RUNOFF AND DRAINAGE FROM THE STONE PAD TO A SEDIMENT TRAP OR BASIN.  
 8. INSTALL PIPE UNDER PAD AS NEEDED TO MAINTAIN PROPER PUBLIC ROAD DRAINAGE.

**STABILIZED CONSTRUCTION ENTRANCE/EXIT DETAIL**

NOT-TO-SCALE

**COMMON TROUBLE POINTS**  
 1. INADEQUATE RUNOFF CONTROL—SEDIMENT WASHES ONTO PUBLIC ROAD.  
 2. STONE TOO SMALL OR GEOTEXTILE FABRIC ABSENT, RESULTS IN MUDDY CONDITION AS STONE IS PRESSED INTO SOIL.  
 3. PAD TOO SHORT FOR HEAVY CONSTRUCTION TRAFFIC—EXTEND PAD BEYOND THE MINIMUM 50-FOOT LENGTH AS NECESSARY.  
 4. PAD NOT FLARED SUFFICIENTLY AT ROAD SURFACE, RESULTS IN MUD BEING TRACKED ON TO ROAD AND POSSIBLE DAMAGE TO ROAD.  
 5. UNSTABLE FOUNDATION — USE GEOTEXTILE FABRIC UNDER PAD AND/OR IMPROVE FOUNDATION DRAINAGE.

**INSPECTION AND MAINTENANCE GUIDELINES**  
 1. THE ENTRANCE SHOULD BE MAINTAINED IN A CONDITION, WHICH WILL PREVENT TRACKING OR FLOWING OF SEDIMENT ONTO PUBLIC RIGHTS-OF-WAY. THIS MAY REQUIRE PERIODIC TOP DRESSING WITH ADDITIONAL STONE AS CONDITIONS DEMAND AND REPAIR AND/OR CLEANOUT OF ANY MEASURES USED TO TRAP SEDIMENT.  
 2. ALL SEDIMENT SPILLED, DROPPED, WASHED OR TRACKED ONTO PUBLIC RIGHTS-OF-WAY SHOULD BE REMOVED IMMEDIATELY BY CONTRACTOR.  
 3. WHEN NECESSARY, WHEELS SHOULD BE CLEANED TO REMOVE SEDIMENT PRIOR TO ENTERING ONTO PUBLIC RIGHT-OF-WAY.  
 4. WHEN WASHING IS REQUIRED, IT SHOULD BE DONE ON AN AREA STABILIZED WITH CRUSHED STONE THAT DRAINS INTO AN APPROVED SEDIMENT TRAP OR SEDIMENT BASIN.  
 5. ALL SEDIMENT SHOULD BE PREVENTED FROM ENTERING ANY STORM DRAIN, DITCH OR WATER COURSE BY USING APPROVED METHODS.

**ROCK BERMS**  
 THE PURPOSE OF A ROCK BERM IS TO SERVE AS A CHECK DAM IN AREAS OF CONCENTRATED FLOW, TO INTERCEPT SEDIMENT-LADEN RUNOFF, DETAIN THE SEDIMENT AND RELEASE THE WATER IN SHEET FLOW. THE ROCK BERM SHOULD BE USED WHEN THE CONTRIBUTING DRAINAGE AREA IS LESS THAN 5 ACRES. ROCK BERMS ARE USED IN AREAS WHERE THE VOLUME OF RUNOFF IS TOO GREAT FOR A SILT FENCE TO CONTAIN. THEY ARE LESS EFFECTIVE FOR SEDIMENT REMOVAL THAN SILT FENCES, PARTICULARLY FOR FINE PARTICLES, BUT ARE ABLE TO WITHSTAND HIGHER FLOWS THAN A SILT FENCE. AS SUCH, ROCK BERMS ARE OFTEN USED IN AREAS OF CHANNEL FLOWS (DITCHES, GULLIES, ETC.). ROCK BERMS ARE MOST EFFECTIVE AT REDUCING BERM LOAD IN CHANNELS AND SHOULD NOT BE SUBSTITUTED FOR OTHER EROSION AND SEDIMENT CONTROL MEASURES FURTHER UP THE WATERSHED.

**INSPECTION AND MAINTENANCE GUIDELINES**  
 1. INSPECTION SHOULD BE MADE WEEKLY AND AFTER EACH RAINFALL BY THE RESPONSIBLE PARTY. FOR INSTALLATIONS IN STREAMBEDS, ADDITIONAL DAILY INSPECTIONS SHOULD BE MADE.  
 2. REMOVE SEDIMENT AND OTHER DEBRIS WHEN BUILDUP REACHES 6 INCHES AND DISPOSE OF THE ACCUMULATED SILT IN AN APPROVED MANNER THAT WILL NOT CAUSE ANY ADDITIONAL SILTATION.  
 3. REPAIR ANY LOOSE WIRE SHEATHING.  
 4. THE BERM SHOULD BE RESHAPED AS NEEDED DURING INSPECTION.  
 5. THE BERM SHOULD BE REPLACED WHEN THE STRUCTURE CEASES TO FUNCTION AS INTENDED DUE TO SILT ACCUMULATION AMONG THE ROCKS, WASHOUT, CONSTRUCTION TRAFFIC DAMAGE, ETC.  
 6. THE ROCK BERM SHOULD BE LEFT IN PLACE UNTIL ALL UPSTREAM AREAS ARE STABILIZED AND ACCUMULATED SILT REMOVED.

**MATERIALS**  
 1. THE BERM STRUCTURE SHOULD BE SECURED WITH A WOVEN WIRE SHEATHING HAVING MAXIMUM OPENING OF 1 INCH AND A MINIMUM WIRE DIAMETER OF 20 GAUGE GALVANIZED AND SHOULD BE SECURED WITH SHOAT RINGS.  
 2. CLEAN, OPEN GRADED 3-INCH TO 5-INCH DIAMETER ROCK SHOULD BE USED, EXCEPT IN AREAS WHERE HIGH VELOCITIES OR LARGE VOLUMES OF FLOW ARE EXPECTED, WHERE 5-INCH TO 8-INCH DIAMETER ROCKS MAY BE USED.

**INSTALLATION**  
 1. LAY OUT THE WOVEN WIRE SHEATHING PERPENDICULAR TO THE FLOW LINE. THE SHEATHING SHOULD BE 20 GAUGE WOVEN WIRE MESH WITH 1 INCH OPENINGS.  
 2. BERM SHOULD HAVE A TOP WIDTH OF 2 FEET MINIMUM WITH SIDE SLOPES BEING 2:1 (H:V) OR FLATTER.  
 3. PLACE THE ROCK ALONG THE SHEATHING AS SHOWN IN THE DIAGRAM TO A HEIGHT NOT LESS THAN 18".  
 4. WRAP THE WIRE SHEATHING AROUND THE ROCK AND SECURE WITH THE WIRE SO THAT THE ENDS OF THE SHEATHING OVERLAP AT LEAST 2 INCHES, AND THE BERM RETAINS ITS SHAPE WHEN WALKED UPON.  
 5. BERM SHOULD BE BUILT ALONG THE CONTOUR AT ZERO PERCENT GRADE OR AS NEAR AS POSSIBLE.  
 6. THE ENDS OF THE BERM SHOULD BE TIED INTO EXISTING UPSLOPE GRADE AND THE BERM SHOULD BE BURIED IN A TRENCH APPROXIMATELY 3 TO 4 INCHES DEEP TO PREVENT FAILURE OF THE CONTROL.

**COMMON TROUBLE POINTS**  
 1. INSUFFICIENT BERM HEIGHT OR LENGTH (RUNOFF QUICKLY ESCAPES OVER THE TOP OR AROUND THE SIDES OF BERM).  
 2. BERM NOT INSTALLED PERPENDICULAR TO FLOW LINE (RUNOFF ESCAPING ANOTHER ONE SIDE).

**ROCK BERM DETAIL**

NOT-TO-SCALE

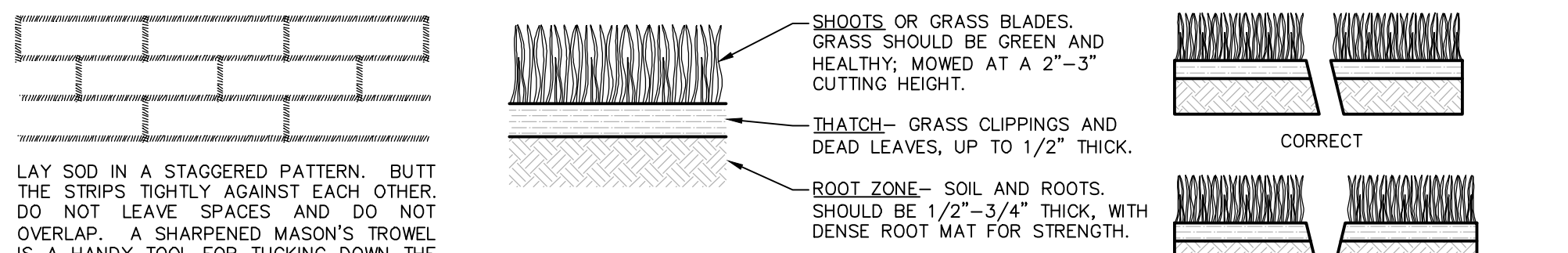

**SOD INSTALLATION**

**APPEARANCE OF GOOD SOD**  
 NOTES:  
 1. ROLL SOD IMMEDIATELY TO ACHIEVE FIRM CONTACT WITH THE SOIL.  
 2. WATER TO A DEPTH OF 4" AS NEEDED. WATER WELL AS SOON AS THE SOD IS LAID.  
 3. MOW WHEN THE SOD IS ESTABLISHED - IN 2-3 WEEKS. SET THE MOWER HIGH (2"-3").

**GENERAL INSTALLATION (VA. DEPT. OF CONSERVATION, 1992)**  
 1. SOD SHOULD NOT BE CUT OR LAID IN EXCESSIVELY WET OR DRY WEATHER. SOD ALSO SHOULD NOT BE LAID ON SOIL SURFACES THAT ARE FROZEN.  
 2. DURING PERIODS OF HIGH TEMPERATURE, THE SOIL SHOULD BE LIGHTLY IRRIGATED IMMEDIATELY PRIOR TO LAYING THE SOD, TO COOL THE SOIL AND REDUCE ROOT BURNING AND DIEBACK.  
 3. THE FIRST ROW OF SOD SHOULD BE LAID IN A STRAIGHT LINE WITH SUBSEQUENT ROWS PLACED PARALLEL TO AND BUTTING TIGHTLY AGAINST EACH OTHER. LATERAL JOINTS SHOULD BE STAGGERED TO PROMOTE MORE UNIFORM GROWTH AND STRENGTH. CARE SHOULD BE EXERCISED TO ENSURE THAT SOD IS NOT STRETCHED OR OVERLAPPED AND THAT ALL JOINTS ARE BUTTED TIGHT IN ORDER TO PREVENT VOIDS WHICH WOULD CAUSE DRYING OF THE ROOTS (SEE FIGURE ABOVE).  
 4. ON SLOPES 3:1 OR GREATER, OR WHERE EROSION MAY BE A PROBLEM, SOD SHOULD BE LAID WITH STAGGERED JOINTS AND SECURED BY STAPLING OR OTHER APPROVED METHODS. SOD SHOULD BE INSTALLED WITH THE LENGTH PERPENDICULAR TO THE SLOPE (ON CONTOUR).  
 5. AS SODDING OF CLEARLY DEFINED AREAS IS COMPLETED, SOD SHOULD BE ROLLED OR TAMPED TO PROVIDE FIRM CONTACT BETWEEN ROOTS AND SOIL.  
 6. AFTER ROLLING, SOD SHOULD BE IRRIGATED TO A DEPTH SUFFICIENT THAT THE UNDERSIDE OF THE SOD PAD AND THE SOIL 4 INCHES BELOW THE SOD IS THOROUGHLY WET.  
 7. UNTIL SUCH TIME A GOOD ROOT SYSTEM BECOMES DEVELOPED, IN THE ABSENCE OF ADEQUATE RAINFALL, WATERING SHOULD BE PERFORMED AS OFTEN AS NECESSARY TO MAINTAIN MOIST SOIL TO A DEPTH OF AT LEAST 4 INCHES.  
 8. THE FIRST MOWING SHOULD NOT BE ATTEMPTED UNTIL THE SOD IS FIRMLY ROOTED, USUALLY 2-3 WEEKS. NOT MORE THAN ONE THIRD OF THE GRASS LEAF SHOULD BE REMOVED AT ANY ONE CUTTING.

**SOD INSTALLATION DETAIL**

NOT-TO-SCALE

**MATERIALS**  
 1. SOD SHOULD BE MACHINE CUT AT A UNIFORM SOIL THICKNESS OF 3/4" INCH (± 1/4" INCH) AT THE TIME OF CUTTING. THIS THICKNESS SHOULD EXCLUDE SHOOT GROWTH AND THATCH.  
 2. PIECES OF SOD SHOULD BE CUT TO THE SUPPLIER'S STANDARD WIDTH AND LENGTH, WITH A MAXIMUM ALLOWABLE DEVIATION IN ANY DIMENSION OF 5%. TORN OR UNEVEN PADS SHOULD NOT BE ACCEPTABLE.  
 3. STANDARD SIZE SECTIONS OF SOD SHOULD BE STRONG ENOUGH TO SUPPORT THEIR OWN WEIGHT AND THEIR SIZE AND SHAPE WHEN SUSPENDED FROM A FIRM GRASP ON ONE END OF THE SECTION.  
 4. SOD SHOULD BE HARVESTED, DELIVERED, AND INSTALLED WITHIN A PERIOD OF 36 HOURS.

**SITE PREPARATION**  
 1. PRIOR TO SOD PREPARATION, AREAS TO BE SODDED SHOULD BE BROUGHT TO FINAL GRADE IN ACCORDANCE WITH THE APPROVED PLAN.  
 2. THE SURFACE SHOULD BE CLEARED OF ALL TRASH, DEBRIS AND OF ALL ROOTS, BRUSH, WIRE GRADE STAKES AND OTHER OBJECTS THAT WOULD INTERFERE WITH PLANTING, FERTILIZING OR MAINTENANCE OPERATIONS.  
 3. FERTILIZE ACCORDING TO SOIL TESTS. FERTILIZER NEEDS CAN BE DETERMINED BY A SOIL TESTING LABORATORY OR REGIONAL RECOMMENDATIONS CAN BE MADE BY COUNTY AGRICULTURAL EXTENSION AGENTS. FERTILIZER SHOULD BE WORKED INTO THE SOIL TO A DEPTH OF 3 INCHES WITH A DISC, SPRINGTOOTH HARROW OR OTHER SUITABLE EQUIPMENT ON SLOPING LAND, THE FINAL HARROWING OR DISCING OPERATION SHOULD BE ON THE CONTOUR.

**INSTALLATION IN CHANNELS**  
 1. SOD STRIPS IN WATERWAYS SHOULD BE LAID PERPENDICULAR TO THE DIRECTION OF FLOW. CARE SHOULD BE TAKEN TO BUTT ENDS OF STRIPS TIGHTLY (SEE FIGURE ABOVE).  
 2. AFTER ROLLING OR TAMPING, SOD SHOULD BE PEGGED OR STAPLED TO RESIST WASHOUT DURING THE ESTABLISHMENT PERIOD. MESH OR OTHER NETTING MAY BE PEGGED OVER THE SOD FOR EXTRA PROTECTION IN CRITICAL AREAS.

**INSPECTION AND MAINTENANCE GUIDELINES**  
 1. SOD SHOULD BE INSPECTED WEEKLY AND AFTER EACH RAIN EVENT TO LOCATE AND REPAIR ANY DAMAGE.  
 2. DAMAGE FROM STORMS OR NORMAL CONSTRUCTION ACTIVITIES SUCH AS TIRE RUTS OR DISTURBANCE OF SWALE STABILIZATION SHOULD BE REPAIRED AS SOON AS PRACTICAL.

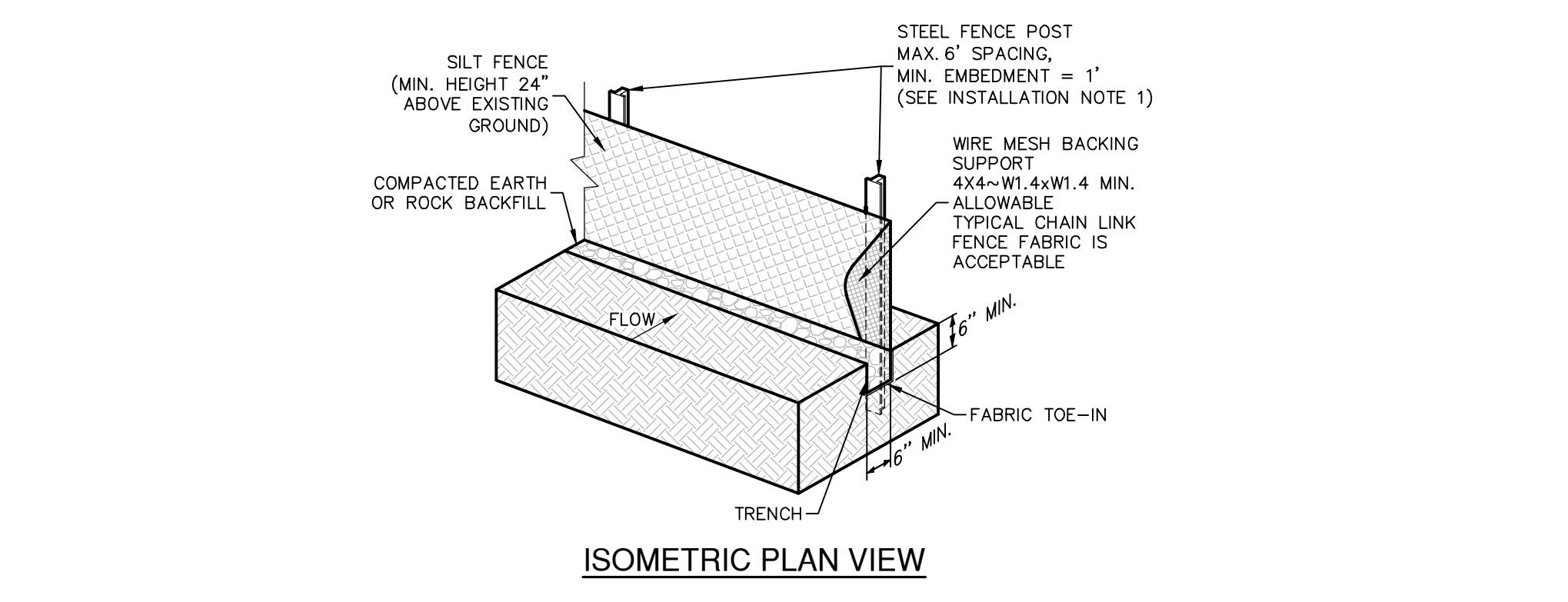

**ISOMETRIC PLAN VIEW**

**SILT FENCE**  
 A SILT FENCE IS A BARRIER CONSISTING OF GEOTEXTILE FABRIC SUPPORTED BY METAL POSTS TO PREVENT SOIL AND SEDIMENT LOSS FROM A SITE. WHEN PROPERLY USED, SILT FENCES CAN BE HIGHLY EFFECTIVE AT CONTROLLING SEDIMENT FROM DISTURBED AREAS. THEY CAUSE RUNOFF TO POND, ALLOWING HEAVIER SOLIDS TO SETTLE OUT. IF NOT PROPERLY INSTALLED, SILT FENCES ARE NOT LIKELY TO BE EFFECTIVE.  
 THE PURPOSE OF A SILT FENCE IS TO INTERCEPT AND DETAIN WATER-BORN SEDIMENT FROM UNPROTECTED AREAS OF A LIMITED EXTENT. SILT FENCE IS USED DURING THE PERIOD OF CONSTRUCTION NEAR THE PERIMETER OF A DISTURBED AREA TO INTERCEPT SEDIMENT WHILE ALLOWING WATER TO PERCOLATE THROUGH. THIS FENCE SHOULD REMAIN IN PLACE UNTIL THE DISTURBED AREA IS PERMANENTLY STABILIZED. SILT FENCE SHOULD NOT BE USED WHERE THERE IS A CONCENTRATION OF WATER IN A CHANNEL OR DRAINAGE WAY. IF CONCENTRATED FLOW OCCURS AFTER INSTALLATION, CORRECTIVE ACTION MUST BE TAKEN SUCH AS PLACING A ROCK BERM IN THE AREAS OF CONCENTRATED FLOW.  
 SILT FENCING WITHIN THE SITE MAY BE TEMPORARILY MOVED DURING THE DAY TO ALLOW CONSTRUCTION ACTIVITY PROVIDED IT IS REPLACED AND PROPERLY ANCHORED TO THE GROUND AT THE END OF THE DAY. SILT FENCES ON THE PERIMETER OF THE SITE OR AROUND DRAINAGE WAYS SHOULD NOT BE MOVED AT ANY TIME.

**MATERIALS**  
 1. SILT FENCE MATERIAL SHOULD BE POLYPROPYLENE, POLYETHYLENE, OR POLYAMIDE WOVEN OR NONWOVEN FABRIC. THE FABRIC SHOULD BE 36 INCHES, WITH A MINIMUM UNIT WEIGHT OF 4.5 OZ/YD, MULLEN BURST STRENGTH EXCEEDING 190 LB/IN<sup>2</sup>, ULTRAVIOLET STABILITY EXCEEDING 70%, AND MINIMUM APPARENT OPENING SIZE OF U.S. SIEVE NUMBER 30.  
 2. FENCE POSTS SHOULD BE MADE OF HOT ROLLED STEEL, AT LEAST 4 FEET LONG WITH TEE OR Y-BAR CROSS SECTION, SURFACE PAINTED OR GALVANIZED, MINIMUM WEIGHT 1.25 LB/FT, AND BRINDELL HARDNESS EXCEEDING 140.  
 3. WOVEN WIRE BACKING TO SUPPORT THE FABRIC SHOULD BE GALVANIZED 2" X 4" WELDED WIRE, 12 GAUGE MINIMUM.

**INSTALLATION**  
 1. STEEL POSTS, WHICH SUPPORT THE SILT FENCE, SHOULD BE INSTALLED ON A SLIGHT ANGLE TOWARD THE ANTICIPATED RUNOFF SOURCE. POSTS MUST BE EMBEDDED A MINIMUM OF 1-FOOT DEEP AND SPACED NOT MORE THAN 8 FEET ON CENTER. WHERE WATER CONCENTRATES, THE MAXIMUM SPACING SHOULD BE 6 FEET.  
 2. LAY OUT FENCING DOWN-SLOPE OF DISTURBED AREA, FOLLOWING THE CONTOUR AS CLOSELY AS POSSIBLE. THE FENCE SHOULD BE SITED SO THAT THE MAXIMUM DRAINAGE AREA IS 1/4 ACRE/100 FEET OF FENCE.

**SILT FENCE DETAIL**

NOT-TO-SCALE

**GENERAL NOTES**  
 1. CONTRACTOR TO INSTALL 2"x4"-W1.4xW1.4 WIRE MESH SUPPORTING FILTER FABRIC OVER THE INLET OPENING. FABRIC MUST BE SECURED TO WIRE BACKING WITH CLIPS OR WIRE TIES AT THIS LOCATION. SAND BAGS FILLED WITH WASHED PEA GRAVEL SHOULD BE PLACED ON TOP OF WIRE MESH ON TOP OF THE INLET AS SHOWN ON THIS DETAIL TO HOLD WIRE MESH IN PLACE. SANDBAGS FILLED WITH WASHED PEA GRAVEL SHOULD ALSO BE PLACED ALONG THE CUTTER AS SHOWN ON THIS DETAIL TO HOLD WIRE MESH IN PLACE. SAND BAGS TO BE STACKED TO FORM A CONTINUOUS BARRIER AROUND INLETS.  
 2. THE BAGS SHOULD BE TIGHTLY ABUTTED AGAINST EACH OTHER TO PREVENT RUNOFF FROM FLOWING BETWEEN THE BAGS.  
 3. CHECK PLACEMENT OF DEVICE TO PREVENT GAPS BETWEEN DEVICE AND CURB.  
 4. INSPECT FILTER FABRIC AND PATCH OR REPLACE IF TORN OR MISSING.  
 5. STRUCTURES SHOULD BE REMOVED AND THE AREA STABILIZED ONLY AFTER THE REMAINING DRAINAGE AREA HAS BEEN PROPERLY STABILIZED.

**INSPECTION AND MAINTENANCE GUIDELINES**  
 1. INSPECTION SHOULD BE MADE WEEKLY AND AFTER EACH RAINFALL. REPAIR OR REPLACEMENT SHOULD BE MADE PROMPTLY AS NEEDED BY THE CONTRACTOR.  
 2. REMOVE SEDIMENT WHEN BUILDUP REACHES A DEPTH OF 3 INCHES. REMOVED SEDIMENT SHOULD BE DEPOSITED IN A SUITABLE AREA AND IN SUCH A MANNER THAT IT WILL NOT ERODE.  
 3. CHECK PLACEMENT OF DEVICE TO PREVENT GAPS BETWEEN DEVICE AND CURB.  
 4. INSPECT FILTER FABRIC AND PATCH OR REPLACE IF TORN OR MISSING.  
 5. STRUCTURES SHOULD BE REMOVED AND THE AREA STABILIZED ONLY AFTER THE REMAINING DRAINAGE AREA HAS BEEN PROPERLY STABILIZED.

**BAGGED GRAVEL CURB INLET PROTECTION DETAIL**

NOT-TO-SCALE

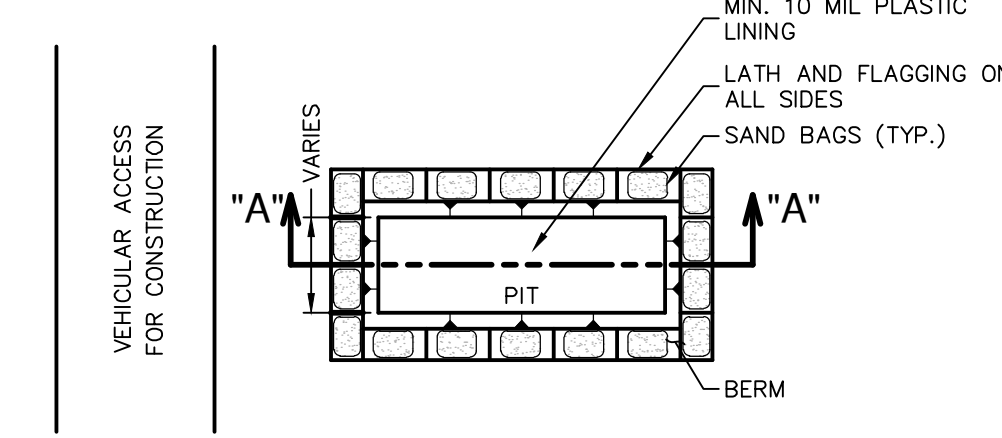

**PLAN VIEW**

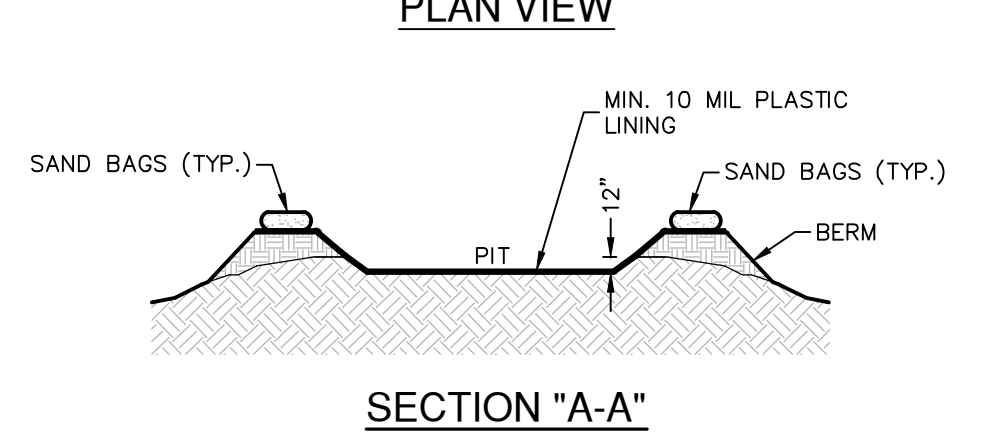

**SECTION "A-A"**

**GENERAL NOTES**  
 1. DETAIL ABOVE ILLUSTRATES MINIMUM DIMENSIONS. PIT CAN BE INCREASED IN SIZE DEPENDING ON EXPECTED FREQUENCY OF USE.  
 2. WASHOUT PIT SHALL BE LOCATED IN AN AREA EASILY ACCESSIBLE TO CONSTRUCTION TRAFFIC.  
 3. WASHOUT PIT SHALL NOT BE LOCATED IN AREAS SUBJECT TO INUNDATION FROM STORM WATER RUNOFF.  
 4. LOCATE WASHOUT AREA AT LEAST 50 FEET FROM SENSITIVE FEATURES, STORM DRAINS, OPEN DITCHES OR WATER BODIES.  
 5. TEMPORARY CONCRETE WASHOUT FACILITY SHOULD BE CONSTRUCTED WITH SUFFICIENT QUANTITY AND VOLUME TO CONTAIN ALL LIQUID AND CONCRETE WASTE GENERATED BY WASHOUT OPERATIONS.

**MATERIALS**  
 PLASTIC LINING MATERIAL SHOULD BE A MINIMUM OF 10 MIL IN POLYETHYLENE SHEETING AND SHOULD BE FREE OF HOLES, TEARS, OR OTHER DEFECTS THAT COMPROMISE THE IMPERMEABILITY OF THE MATERIAL.

**MAINTENANCE**  
 1. WHEN TEMPORARY CONCRETE WASHOUT FACILITIES ARE NO LONGER REQUIRED FOR THE WORK, THE HARDENED CONCRETE SHOULD BE REMOVED AND DISPOSED OF.  
 2. MATERIALS USED TO CONSTRUCT TEMPORARY CONCRETE WASHOUT FACILITIES SHOULD BE REMOVED FROM THE SITE OF THE WORK AND DISPOSED OF.  
 3. HOLES, DEPRESSIONS OR OTHER GROUND DISTURBANCES CAUSED BY THE REMOVAL OF THE TEMPORARY CONCRETE WASHOUT FACILITIES SHOULD BE BACKFILLED AND REPAIRED.

**CONCRETE TRUCK WASHOUT PIT DETAIL**

NOT-TO-SCALE

**GENERAL NOTES**  
 1. THE SANDBAGS SHOULD BE FILLED WITH WASHED PEA GRAVEL AND STACKED TO FORM A CONTINUOUS BARRIER ABOUT 1 FOOT HIGH AROUND INLETS.  
 2. THE BAGS SHOULD BE TIGHTLY ABUTTED AGAINST EACH OTHER TO PREVENT RUNOFF FROM FLOWING BETWEEN THE BAGS.  
 3. CHECK PLACEMENT OF DEVICE TO PREVENT GAPS BETWEEN DEVICE AND CURB.  
 4. INSPECT FILTER FABRIC AND PATCH OR REPLACE IF TORN OR MISSING.  
 5. STRUCTURES SHOULD BE REMOVED AND THE AREA STABILIZED ONLY AFTER THE REMAINING DRAINAGE AREA HAS BEEN PROPERLY STABILIZED.

**BAGGED GRAVEL GRATE INLET PROTECTION DETAIL**

NOT-TO-SCALE

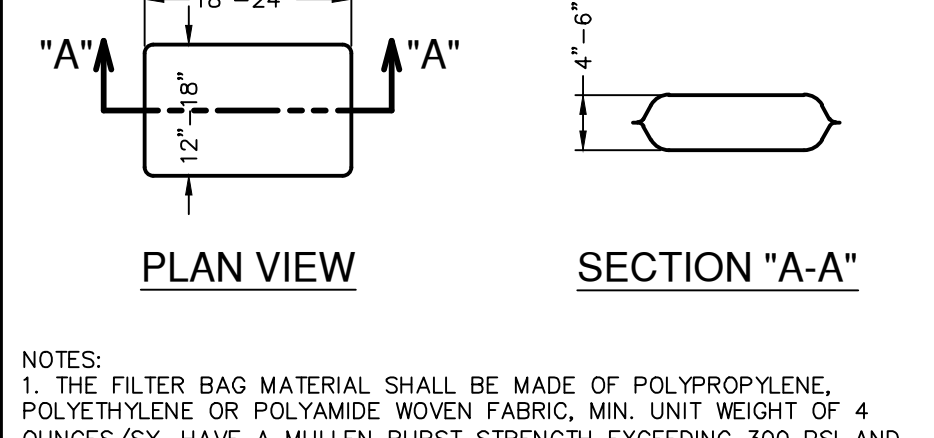

**PLAN VIEW**

**SECTION "A-A"**

**GRAVEL FILTER BAG DETAIL**

NOT-TO-SCALE

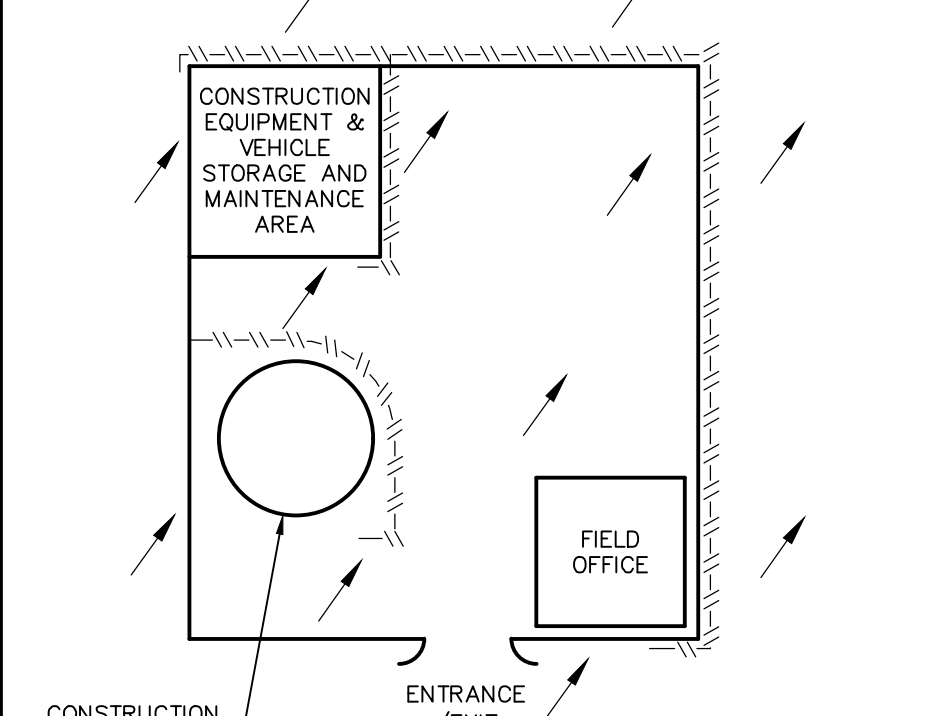

**CONSTRUCTION STAGING AREA**

**LEGEND**  
 - - - SILT FENCE  
 - - - FLOW ARROWS

THIS SHEET HAS BEEN PREPARED FOR PURPOSES OF THE SWP3 ONLY. ALL OTHER CIVIL ENGINEERING RELATED INFORMATION SHOULD BE ACQUIRED FROM THE APPROPRIATE SHEET IN THE CIVIL IMPROVEMENT PLANS.

DATE	
NO.	
REVISION	

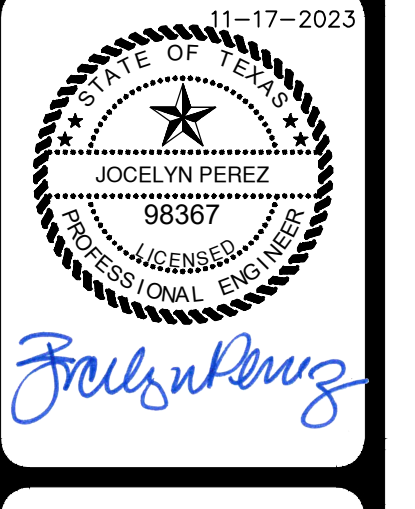

**PAPE-DAWSON ENGINEERS**  
 NEW BRUNSWICK | SAN ANTONIO | AUSTIN | HOUSTON | FT. WORTH | DALLAS  
 1075 INDEPENDENCE DR. STE. 102 | NEW BRUNSWICK, TX 78102 | 800.632.9583  
 TEXAS ENGINEERING FIRM #479 | TEXAS SURVEYING FIRM #1008860

**VERAMENDI WORD PKWY PHASE 3, PRECINCT 18 UNIT 1, PRECINCT 4 UNIT 1, 2, & 3**  
**WATER POLLUTION ABATEMENT PLAN DETAILS**

PLAT NO.	30001-45
JOB NO.	30001-45
DATE	SEPTEMBER 2023
DESIGNER	GDL
CHECKED	DRAWN
SHEET	1 OF 2

FOR PERMIT



**FINAL PLAN AND PROFILE  
SHEETS**



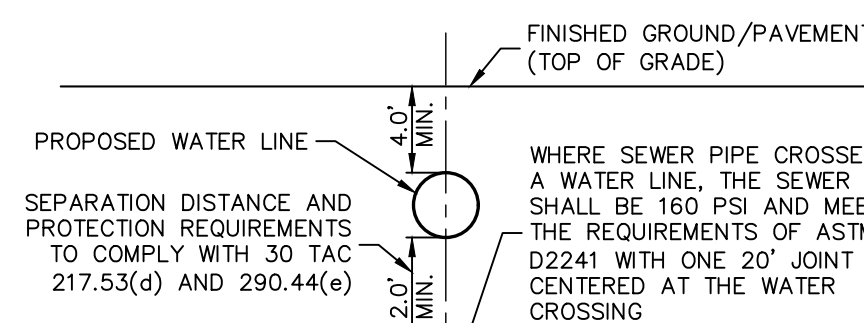

WASTEWATER (NBU JOB NO. WW-226996)			
ITEM	UNIT	QUANTITY	
8" SANITARY SEWER PIPE	LF	11,445	
LUES	EA	215	
6" WASTEWATER SERVICE	EA	215	
48" MANHOLES	EA	62	

**TYPICAL SANITARY SEWER/WATER CROSSING DETAIL**  
NOT-TO-SCALE

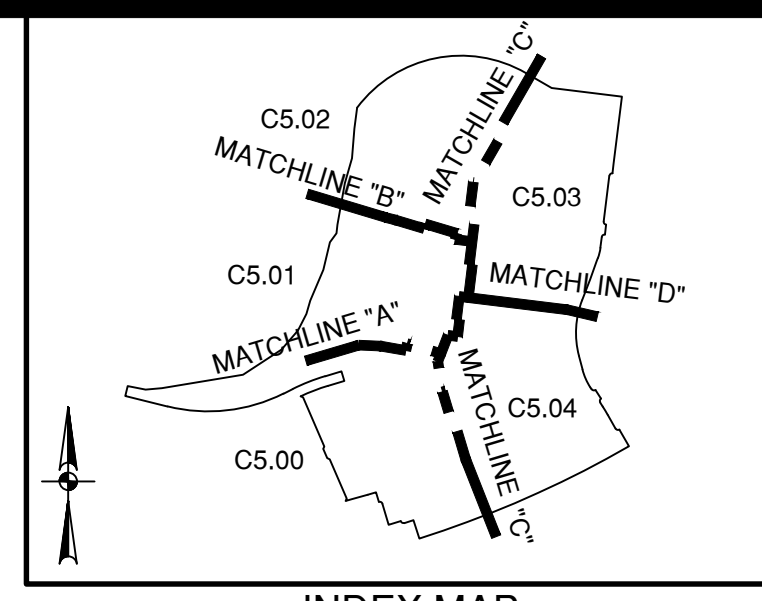

**INDEX MAP**  
SCALE: 1" = 1000'

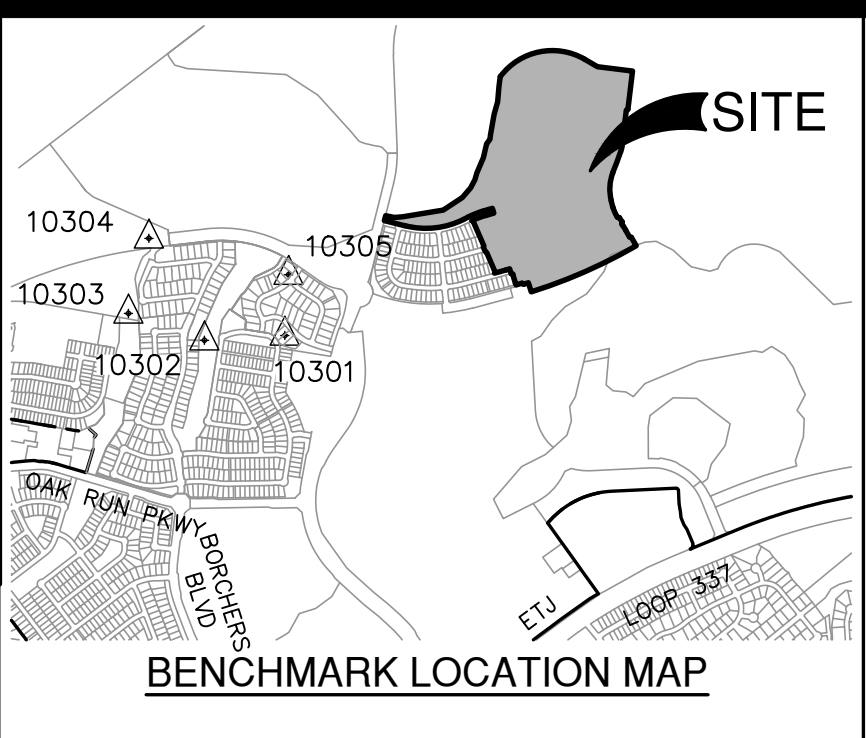

**BENCHMARKS**

HORIZONTAL AND VERTICAL CONTROL POINTS				
Point #	Northing	Easting	Elevation	Full Description
10300	13819253.76	2237967.00	787.38	SET I.R. REDCAP (TRAV)
10301	13816937.43	2237678.90	782.13	SET I.R. REDCAP (TRAV)
10302	13816887.26	2236841.89	758.22	SET I.R. REDCAP (TRAV)
10303	13817166.65	2236050.01	763.76	SET MAG NAL (TRAV)
10304	13817949.35	2236263.15	751.35	SET MAG NAL (TRAV)
10305	13817569.79	2237717.86	753.14	SET MAG NAL (TRAV)

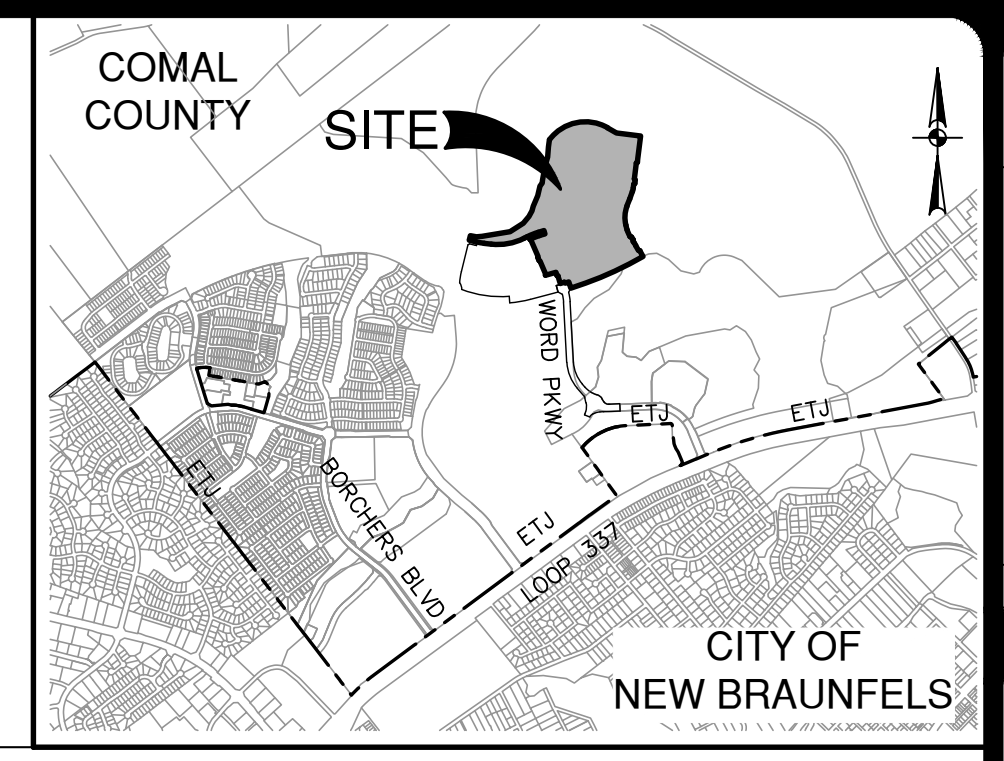

**LOCATION MAP**  
NOT-TO-SCALE

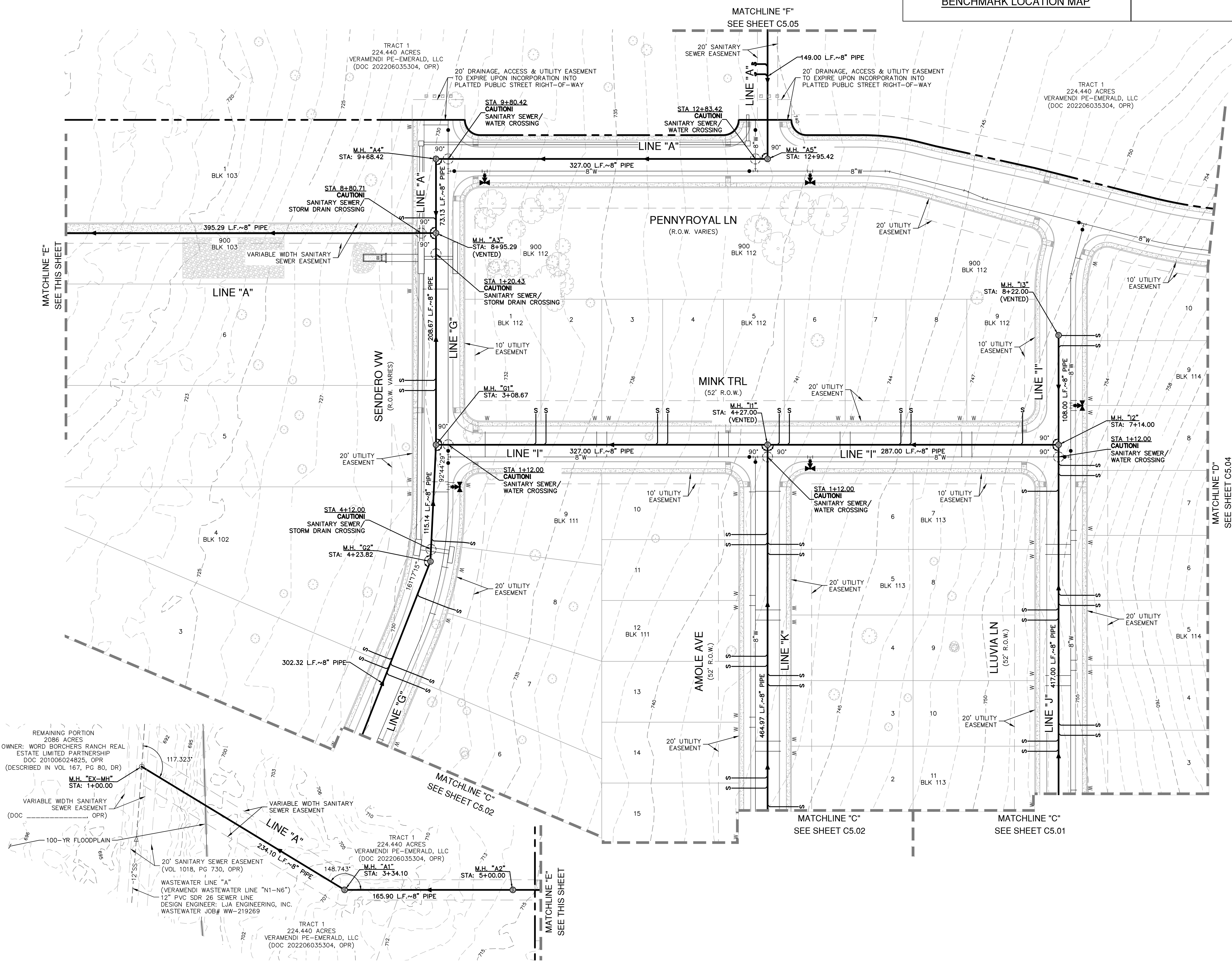
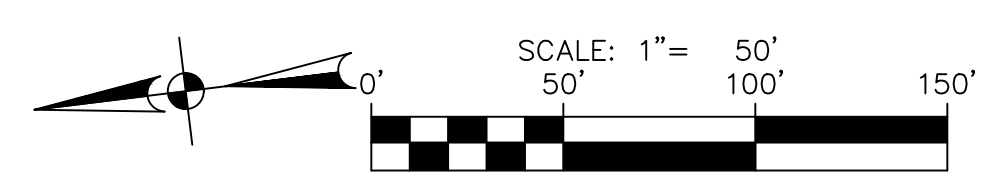

**SEWER LEGEND**

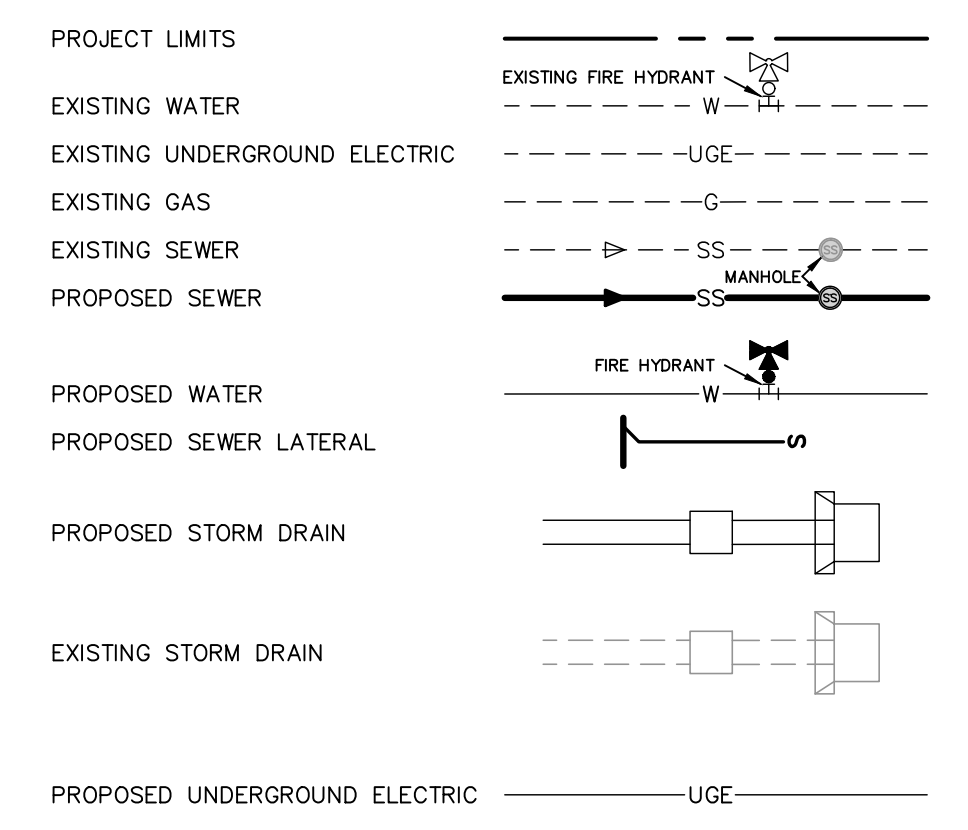

**FLOODPLAIN NOTE**

1. NO PORTION OF ANY LOT ON THIS PROJECT IS WITHIN AN INDICATED SPECIAL FLOOD HAZARD ZONE ACCORDING TO THE FEMA FIRM MAP NO. 48091C0435F EFFECTIVE DATE 9/2/2009.

**CITY OF NEW BRAUNFELS NOTES**

- NO VALVES, HYDRANTS, ETC. SHALL BE CONSTRUCTED WITHIN CURBS, SIDEWALKS, OR DRIVEWAYS.
- ALL UTILITIES TO BE CONSTRUCTED PRIOR TO STREETS.
- THIS PROJECT INCLUDES UTILITY INSTALLATIONS GREATER THAN 5- FEET IN DEPTH. DEEP TRENCHES POSE COMPACTION TESTING AND CONSTRUCTION CHALLENGES AND CITY METHODS FOR TESTING AND COMPACTION MAY NOT BE ACHIEVABLE. A UTILITY COMPACTION PLAN WILL BE REQUIRED AND MUST BE SUBMITTED FOR APPROVAL TO CITY PRIOR TO UTILITY INSTALLATION.
- UTILITY TRENCH COMPACTION - ALL UTILITY TRENCH COMPACTION TESTS WITHIN THE STREET PAVEMENT/SIDEWALK SECTION SHALL BE THE RESPONSIBILITY OF THE DEVELOPER'S GEOTECHNICAL ENGINEER. FILL MATERIAL SHALL BE PLACED IN UNIFORM LAYERS NOT TO EXCEED TWELVE INCHES (12") LOOSE. DETERMINE THE MAXIMUM LIFT THICKNESS BASED ON THE ABILITY OF THE COMPACTION OPERATION AND EQUIPMENT USED TO MEET THE REQUIRED DENSITY. EACH LAYER OF MATERIAL SHALL BE COMPACTED TO A MINIMUM 95% DENSITY AND TESTED FOR DENSITY AND MOISTURE IN ACCORDANCE WITH TEST METHODS TEX-113-E, TEX-114-E, TEX-115-E. THE NUMBER AND LOCATION OF REQUIRED TESTS SHALL BE DETERMINED BY THE GEOTECHNICAL ENGINEER AND APPROVED BY THE CITY OF NEW BRAUNFELS STREET INSPECTOR. AT A MINIMUM, TESTS SHALL BE TAKEN EVERY 200 LF FOR EACH LIFT AND EVERY OTHER SERVICE LINE. UPON COMPLETION OF TESTING THE GEOTECHNICAL ENGINEER SHALL PROVIDE THE CITY OF NEW BRAUNFELS STREET INSPECTOR WITH ALL TESTING DOCUMENTATION AND A CERTIFICATION STATING THAT THE PLACEMENT OF FILL MATERIAL HAS BEEN COMPLETED IN ACCORDANCE WITH THE PLANS. ADDITIONAL TESTING MAY BE REQUESTED BY THE CITY OF NEW BRAUNFELS INSPECTOR.

**CAUTION!!**

CONTRACTOR SHALL BE REQUIRED TO LOCATE ALL PUBLIC OR PRIVATE UTILITIES INCLUDING BUT NOT LIMITING TO: WATER, SEWER, TELEPHONE AND FIBER OPTIC LINES, SITE LIGHTING ELECTRIC, SECONDARY ELECTRIC, PRIMARY ELECTRICAL DISTRIBUTION, LANDSCAPE IRRIGATION FACILITIES, AND GAS LINES. ANY UTILITY CONFLICTS THAT ARISE SHOULD BE COMMUNICATED TO THE ENGINEER IMMEDIATELY AND PRIOR TO CONSTRUCTION. THE CONTRACTOR SHALL CONTACT "TEXAS 811" A MINIMUM OF 48 HOURS PRIOR TO THE START OF CONSTRUCTION. ANY DAMAGE TO EXISTING UTILITIES SHALL BE THE SOLE RESPONSIBILITY OF THE CONTRACTOR AND THE REPAIR SHALL BE AT CONTRACTOR'S SOLE EXPENSE WHETHER THE UTILITY IS SHOWN ON THESE PLANS OR NOT.

**TRENCH EXCAVATION SAFETY PROTECTION:**

CONTRACTOR AND/OR CONTRACTOR'S INDEPENDENTLY RETAINED EMPLOYEE OR STRUCTURAL DESIGN/ GEOTECHNICAL/ SAFETY/EQUIPMENT CONSULTANT, IF ANY, SHALL REVIEW THESE PLANS AND ANY AVAILABLE GEOTECHNICAL INFORMATION AND THE ANTICIPATED INSTALLATION SITES WITHIN THE PROJECT WORK AREA IN ORDER TO IMPLEMENT CONTRACTOR'S TRENCH EXCAVATION SAFETY PROTECTION SYSTEMS, PROGRAMS AND /OR PROCEDURES FOR THE PROJECT DESCRIBED IN THE CONTRACT DOCUMENTS. THE CONTRACTOR'S IMPLEMENTATION OF THESE SYSTEMS, PROGRAMS AND/OR PROCEDURES SHALL PROVIDE FOR ADEQUATE TRENCH EXCAVATION SAFETY PROTECTION THAT COMPLY WITH AS A MINIMUM, OSHA STANDARDS FOR TRENCH EXCAVATIONS. SPECIFICALLY, CONTRACTOR AND/OR CONTRACTOR'S INDEPENDENTLY RETAINED EMPLOYEE OR SAFETY CONSULTANT SHALL IMPLEMENT A TRENCH SAFETY PROGRAM IN ACCORDANCE WITH OSHA STANDARDS GOVERNING THE PRESENCE AND ACTIVITIES OF INDIVIDUALS WORKING IN AND AROUND TRENCH EXCAVATION.

DATE	NO.	REVISION

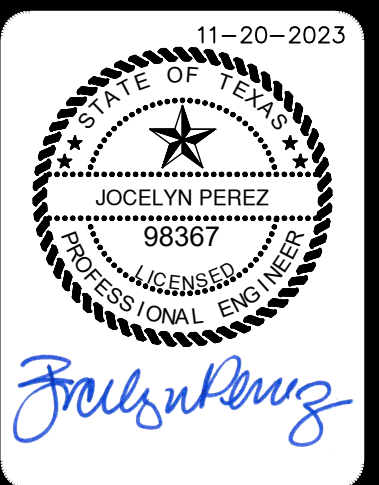

**PAPE-DAWSON ENGINEERS**  
1672 INDEPENDENCE DR. STE 102 | NEW BRAUNFELS, TX 78132 | 800.632.5693  
TEXAS ENGINEERING FIRM #470 | TEXAS SURVEYING FIRM #1008800

**VERAMENDI PRECINCT 18 UNIT 1**  
NEW BRAUNFELS, TEXAS  
**OVERALL SANITARY SEWER PLAN**

JOB NO.	30001-66
DATE	07-03-2023
DESIGNER	GDL
CHECKED	DRAWN BH
SHEET	C5.03

**FOR PERMIT**

Date: Nov 20, 2023, 1:48pm User ID: Dlynch  
File: P:\3001\01\66\Design\Civil\SS0A-30001-66.dwg

THIS DOCUMENT HAS BEEN PRODUCED FROM MATERIAL THAT WAS STORED AND/OR TRANSMITTED ELECTRONICALLY AND MAY HAVE BEEN INADVERTENTLY ALTERED. RELY ONLY ON FINAL HARD COPY MATERIALS BEARING THE CONSULTANT'S ORIGINAL SIGNATURE AND SEAL. AERIAL IMAGERY PROVIDED BY GOOGLE(S) UNLESS OTHERWISE NOTED. Imagery © 2016, CAPOCO, DigitalGlobe, Texas Orthographic Program, USDA Farm Service Agency.



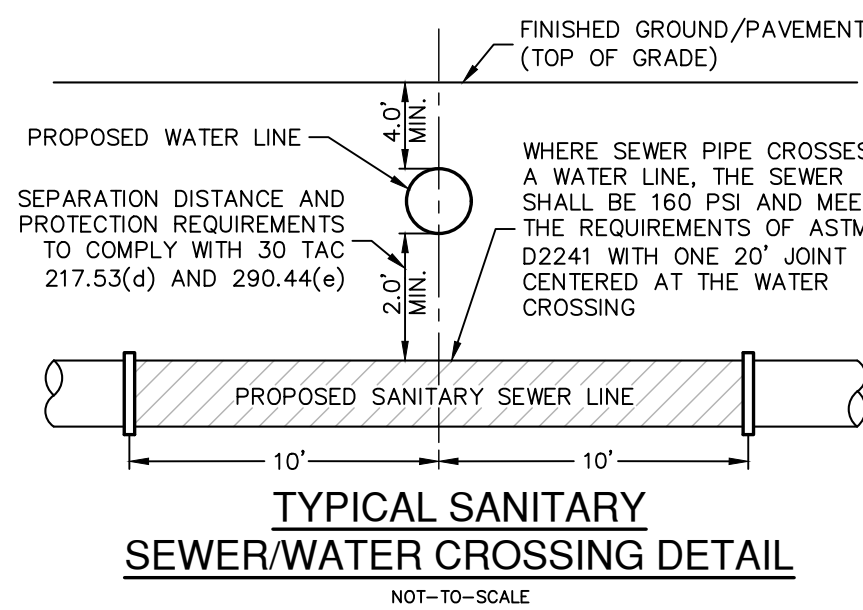

WASTEWATER (NBU JOB NO. WW-226996)			
ITEM	UNIT	QUANTITY	
8" SANITARY SEWER PIPE	LF	11,445	
LUEs	EA	215	
6" WASTEWATER SERVICE	EA	215	
48" MANHOLES	EA	62	

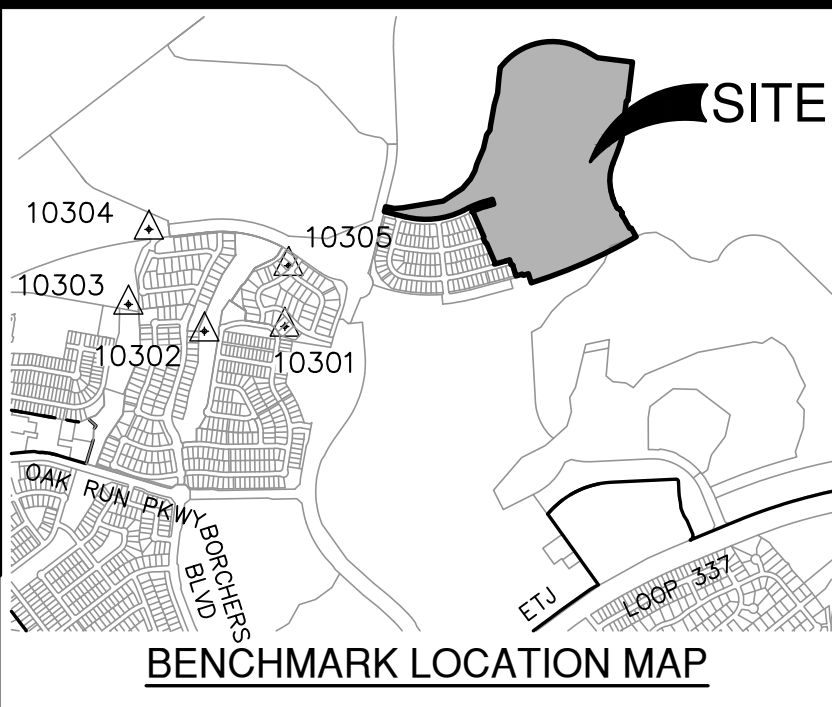
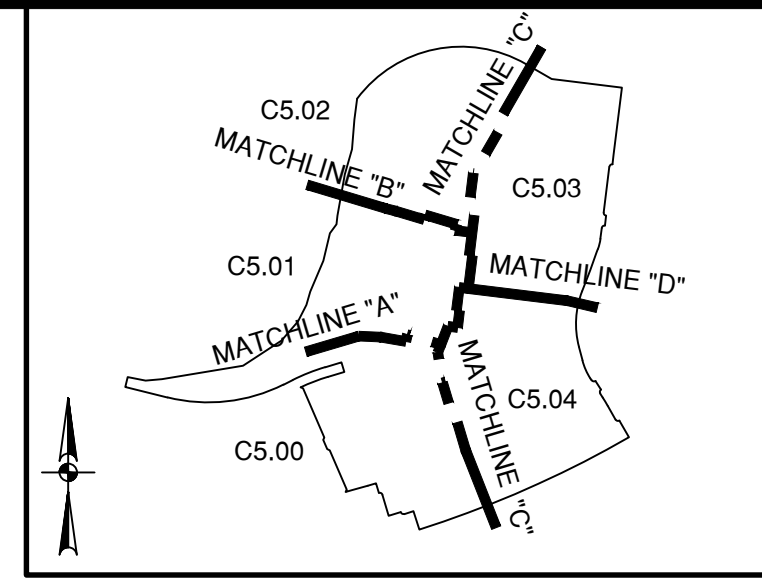

BENCHMARKS				
HORIZONTAL AND VERTICAL CONTROL POINTS				
Point #	Northing	Easting	Elevation	Full Description
10300	13819253.76	2237967.00	787.38	SET I.R. REDCAP (TRAV)
10301	13816937.43	2237678.90	782.13	SET I.R. REDCAP (TRAV)
10302	13816887.26	2236841.89	758.22	SET I.R. REDCAP (TRAV)
10303	13817166.65	2236500.01	763.76	SET MAG NAL (TRAV)
10304	13817949.35	2236263.15	751.35	SET MAG NAL (TRAV)
10305	13817569.79	2237177.86	753.14	SET MAG NAL (TRAV)

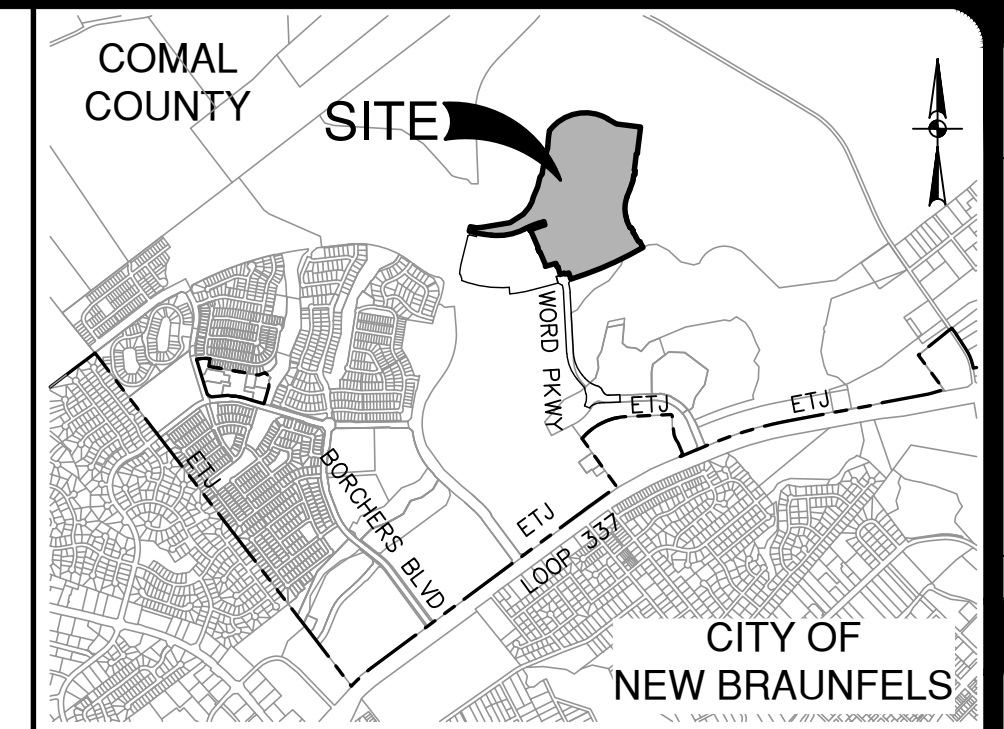

NO.	REVISION	DATE

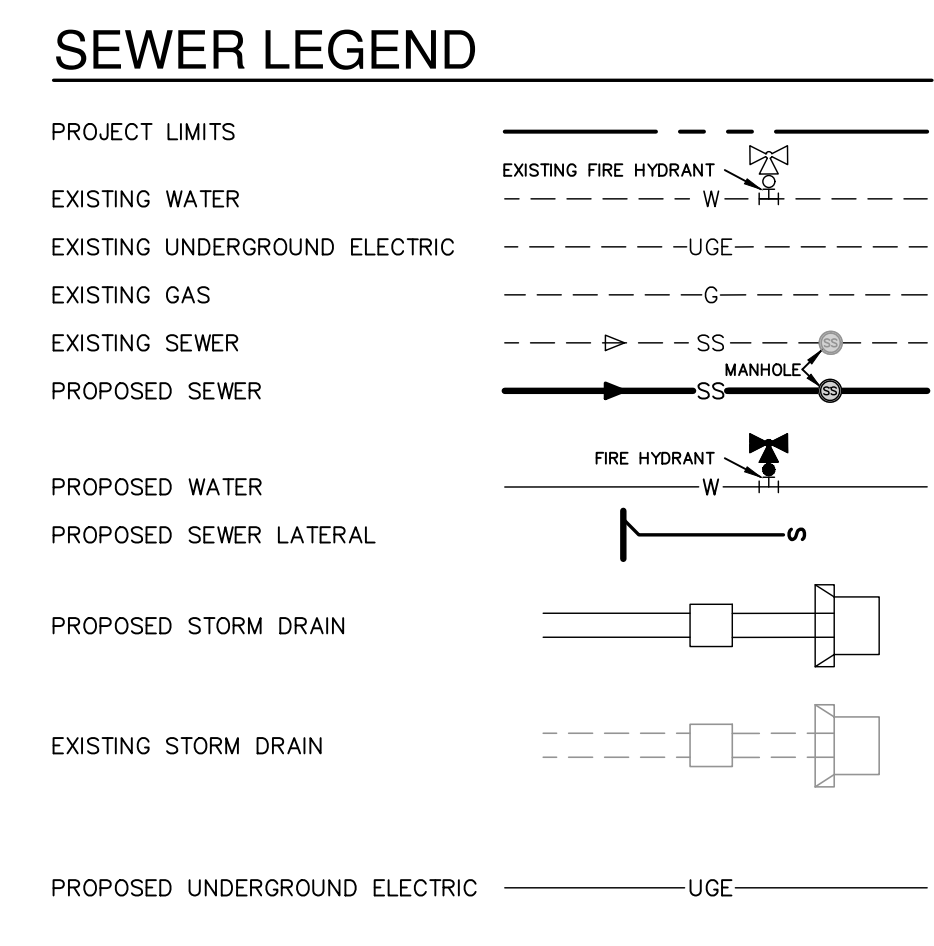
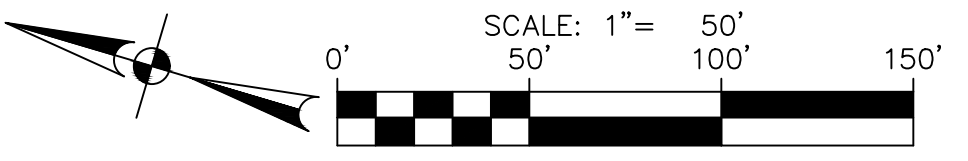
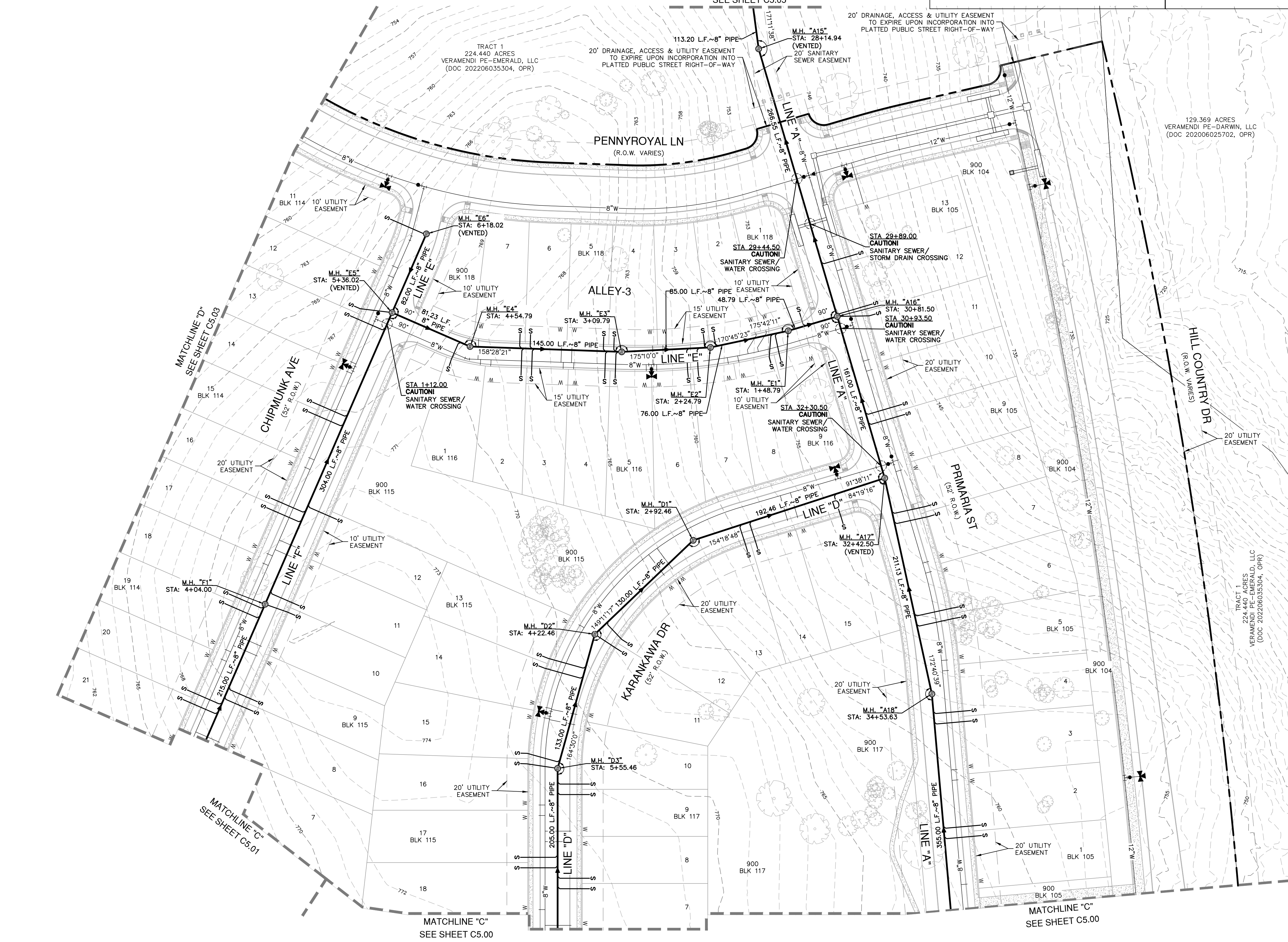
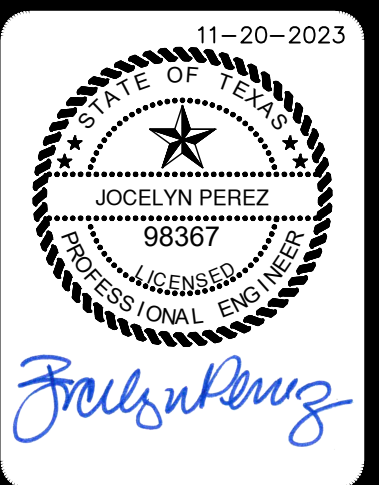

**FLOODPLAIN NOTE**  
 1. NO PORTION OF ANY LOT ON THIS PROJECT IS WITHIN AN INDICATED SPECIAL FLOOD HAZARD ZONE ACCORDING TO THE FEMA FIRM MAP NO. 48091C0435F EFFECTIVE DATE 9/2/2009.

**CITY OF NEW BRAUNFELS NOTES**  
 1. NO VALVES, HYDRANTS, ETC. SHALL BE CONSTRUCTED WITHIN CURBS, SIDEWALKS, OR DRIVEWAYS.  
 2. ALL UTILITIES TO BE CONSTRUCTED PRIOR TO STREETS.  
 3. THIS PROJECT INCLUDES UTILITY INSTALLATIONS GREATER THAN 5- FEET IN DEPTH. DEEP TRENCHES POSE COMPACTION TESTING AND CONSTRUCTION CHALLENGES AND CITY METHODS FOR TESTING AND COMPACTION MAY NOT BE ACHIEVABLE. A UTILITY COMPACTION PLAN WILL BE REQUIRED AND MUST BE SUBMITTED FOR APPROVAL TO CITY PRIOR TO UTILITY INSTALLATION.  
 4. UTILITY TRENCH COMPACTION - ALL UTILITY TRENCH COMPACTION TESTS WITHIN THE STREET PAVEMENT/SIDEWALK SECTION SHALL BE THE RESPONSIBILITY OF THE DEVELOPER'S GEOTECHNICAL ENGINEER. FILL MATERIAL SHALL BE PLACED IN UNIFORM LAYERS NOT TO EXCEED TWELVE INCHES (12") THICK. DETERMINE THE MAXIMUM LIFT THICKNESS BASED ON THE ABILITY OF THE COMPACTING OPERATION AND EQUIPMENT USED TO MEET THE REQUIRED DENSITY. EACH LAYER OF MATERIAL SHALL BE COMPACTED TO A MINIMUM 95% DENSITY AND TESTED FOR DENSITY AND MOISTURE IN ACCORDANCE WITH TEST METHODS TEX-113-E, TEX-114-E, TEX-115-E. THE NUMBER AND LOCATION OF REQUIRED TESTS SHALL BE DETERMINED BY THE GEOTECHNICAL ENGINEER AND APPROVED BY THE CITY OF NEW BRAUNFELS STREET INSPECTOR. AT A MINIMUM, TESTS SHALL BE TAKEN EVERY 200 LF FOR EACH LIFT AND EVERY OTHER SERVICE LINE. UPON COMPLETION OF TESTING THE GEOTECHNICAL ENGINEER SHALL PROVIDE THE CITY OF NEW BRAUNFELS STREET INSPECTOR WITH ALL TESTING DOCUMENTATION AND A CERTIFICATION STATING THAT THE PLACEMENT OF FILL MATERIAL HAS BEEN COMPLETED IN ACCORDANCE WITH THE PLANS. ADDITIONAL DENSITY TESTS MAY BE REQUESTED BY THE CITY OF NEW BRAUNFELS INSPECTOR.

**CAUTION!!**  
 CONTRACTOR SHALL BE REQUIRED TO LOCATE ALL PUBLIC OR PRIVATE UTILITIES INCLUDING BUT NOT LIMITING TO: WATER, SEWER, TELEPHONE AND FIBER OPTIC LINES, SITE LIGHTING ELECTRIC, SECONDARY ELECTRIC, PRIMARY ELECTRICAL, DUCTS, IRRIGATION FACILITIES, AND GAS LINES. ANY UTILITY CONFLICTS THAT ARISE SHOULD BE COMMUNICATED TO THE ENGINEER IMMEDIATELY AND PRIOR TO CONSTRUCTION. THE CONTRACTOR SHALL CONTACT "TEXAS 811" A MINIMUM OF 48 HOURS PRIOR TO THE START OF CONSTRUCTION. ANY DAMAGE TO EXISTING UTILITIES SHALL BE THE SOLE RESPONSIBILITY OF THE CONTRACTOR AND THE REPAIR SHALL BE AT CONTRACTOR'S SOLE EXPENSE WHETHER THE UTILITY IS SHOWN ON THESE PLANS OR NOT.

**TRENCH EXCAVATION SAFETY PROTECTION:**  
 CONTRACTOR AND/OR CONTRACTOR'S INDEPENDENTLY RETAINED EMPLOYEE OR STRUCTURAL DESIGN/ GEOTECHNICAL/ SAFETY/EQUIPMENT CONSULTANT, IF ANY, SHALL REVIEW THESE PLANS AND ANY AVAILABLE GEOTECHNICAL INFORMATION AND THE ANTICIPATED INSTALLATION SITES WITHIN THE PROJECT WORK AREA IN ORDER TO IMPLEMENT CONTRACTOR'S TRENCH EXCAVATION SAFETY PROTECTION SYSTEMS, PROGRAMS AND /OR PROCEDURES FOR THE PROJECT DESCRIBED IN THE CONTRACT DOCUMENTS. THE CONTRACTOR'S IMPLEMENTATION OF THESE SYSTEMS, PROGRAMS AND/OR PROCEDURES SHALL PROVIDE FOR ADEQUATE TRENCH EXCAVATION SAFETY PROTECTION THAT COMPLY WITH AS A MINIMUM, OSHA STANDARDS FOR TRENCH EXCAVATIONS. SPECIFICALLY, CONTRACTOR AND/OR CONTRACTOR'S INDEPENDENTLY RETAINED EMPLOYEE OR SAFETY CONSULTANT SHALL IMPLEMENT A TRENCH SAFETY PROGRAM IN ACCORDANCE WITH OSHA STANDARDS GOVERNING THE PRESENCE AND ACTIVITIES OF INDIVIDUALS WORKING IN AND AROUND TRENCH EXCAVATION.

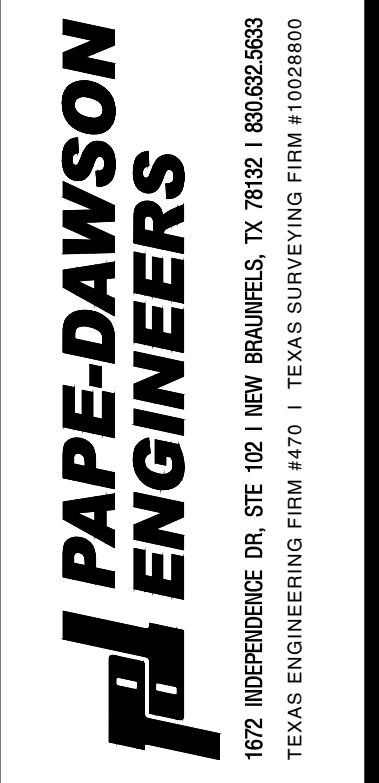

**VERAMENDI PRECINCT 18 UNIT 1**  
 NEW BRAUNFELS, TEXAS  
**OVERALL SANITARY SEWER PLAN**

PLAT NO.	
JOB NO.	30001-66
DATE	07-03-2023
DESIGNER	GDL
CHECKED	DRAWN BH
SHEET	C5.04

FOR PERMIT



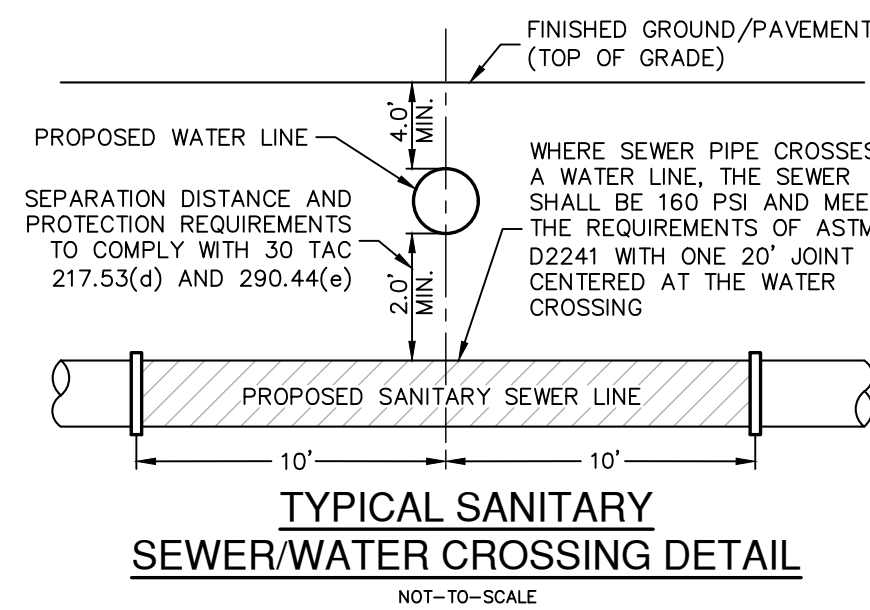

WASTEWATER (NBU JOB NO. WW-226996)		
ITEM	UNIT	QUANTITY
8" SANITARY SEWER PIPE	LF	11,445
LUES	EA	215
6" WASTEWATER SERVICE	EA	215
48" MANHOLES	EA	62

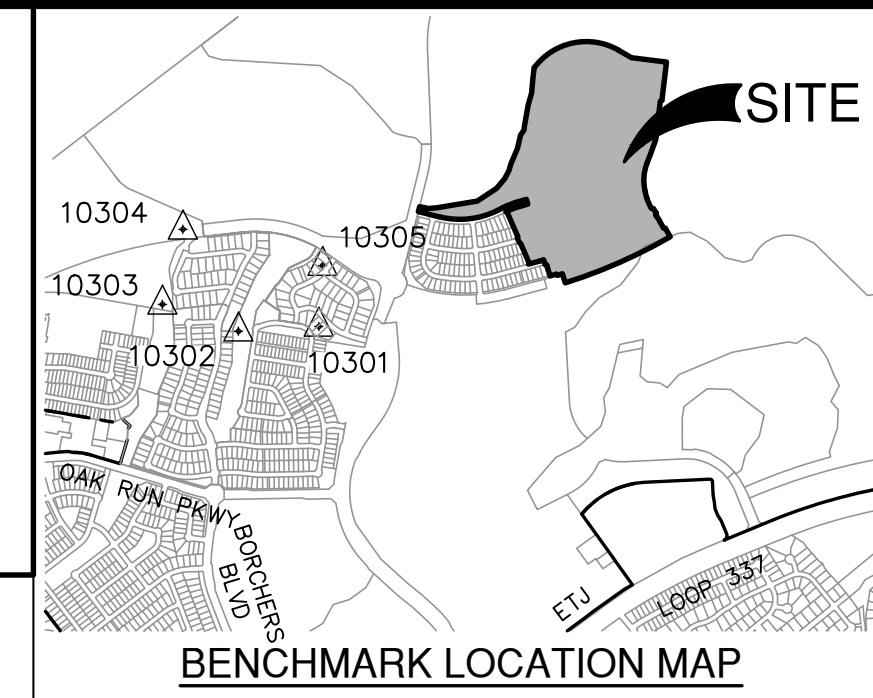
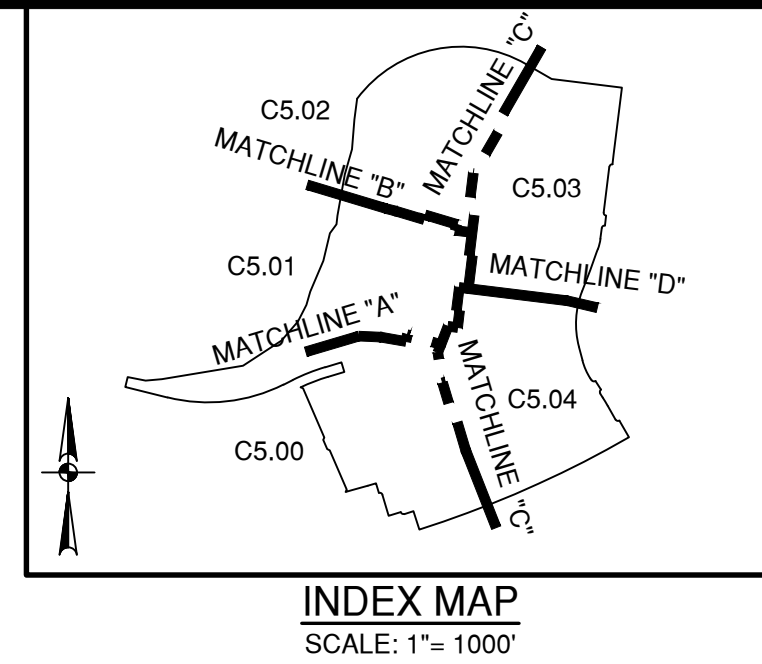

BENCHMARKS			
HORIZONTAL AND VERTICAL CONTROL POINTS			
Point #	Northing	Easting	Full Description
10300	13819253.76	2237967.00	SET I.R. REDCAP (TRAV)
10301	13816937.43	2237678.90	SET I.R. REDCAP (TRAV)
10302	13816887.26	2236841.89	SET I.R. REDCAP (TRAV)
10303	13817666.65	2236050.01	SET MAG NAIL (TRAV)
10304	13817949.35	2236263.15	SET MAG NAIL (TRAV)
10305	13817569.78	2237717.86	SET MAG NAIL (TRAV)

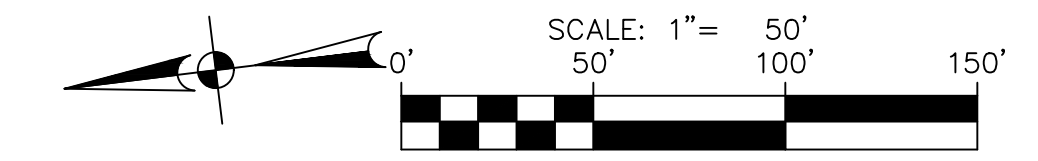
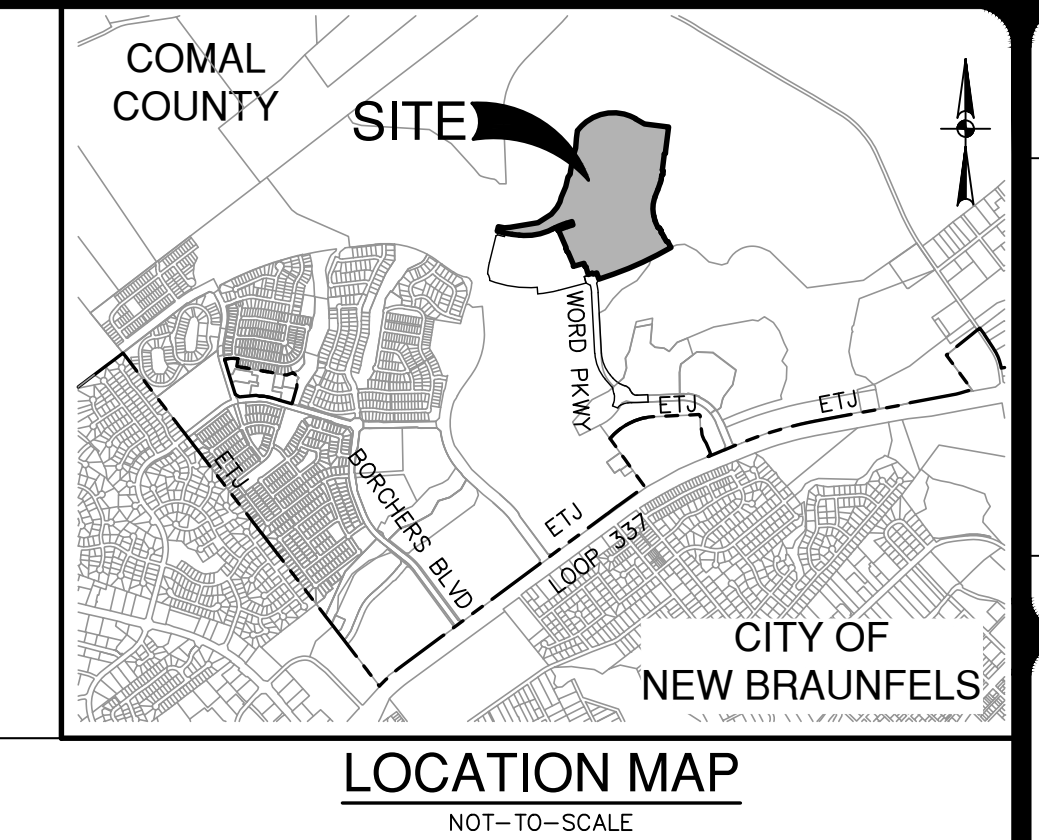

DATE: \_\_\_\_\_

NO. REVISION: \_\_\_\_\_

11-20-2023

JOCELYN PEREZ  
98367  
PROFESSIONAL ENGINEER

*J. Pape-Dawson*

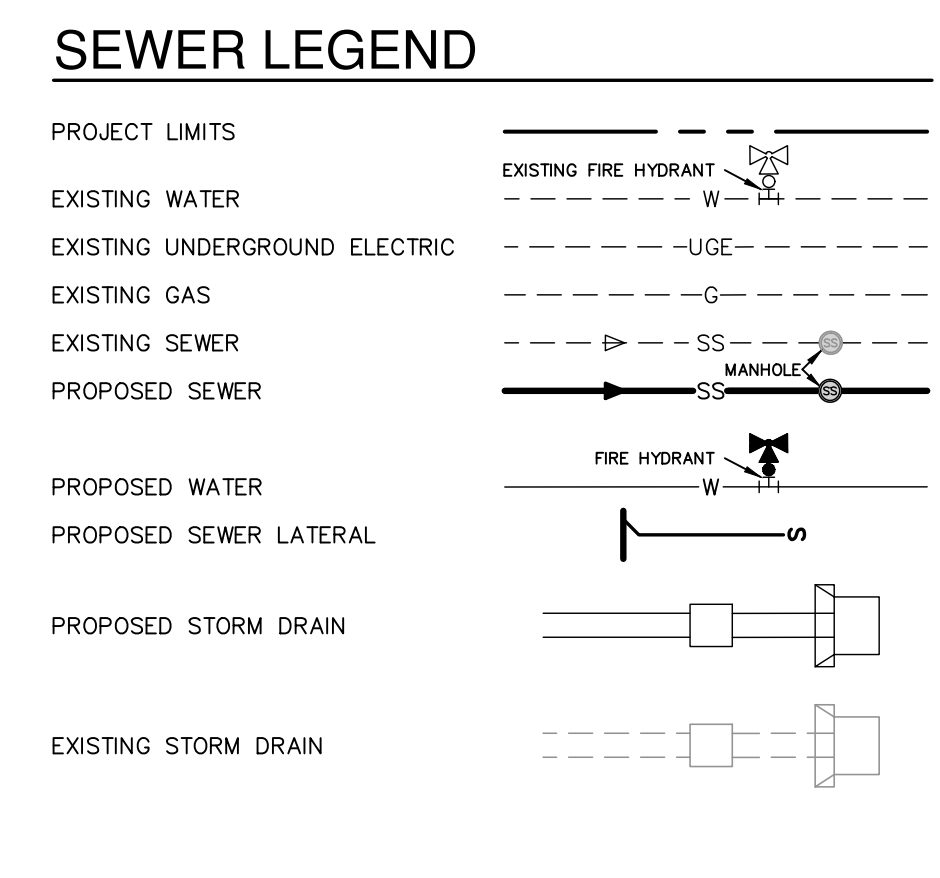
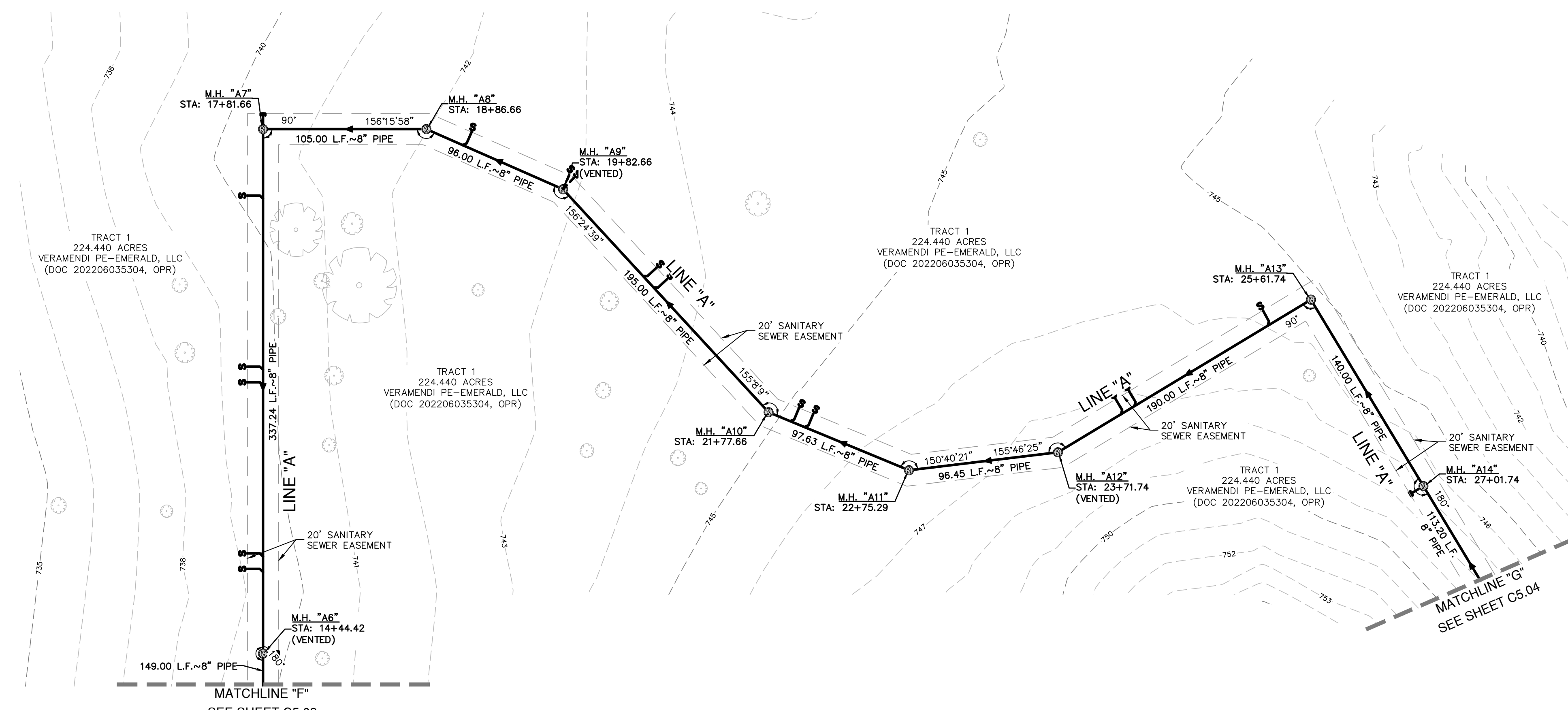

**FLOODPLAIN NOTE**

1. NO PORTION OF ANY LOT ON THIS PROJECT IS WITHIN AN INDICATED SPECIAL FLOOD HAZARD ZONE ACCORDING TO THE FEMA FIRM MAP NO. 48091C0435F EFFECTIVE DATE 9/2/2009.

**CITY OF NEW BRAUNFELS NOTES**

1. NO VALVES, HYDRANTS, ETC. SHALL BE CONSTRUCTED WITHIN CURBS, SIDEWALKS, OR DRIVEWAYS.

2. ALL UTILITIES TO BE CONSTRUCTED PRIOR TO STREETS.

3. THIS PROJECT INCLUDES UTILITY INSTALLATIONS GREATER THAN 5- FEET IN DEPTH. DEEP TRENCHES POSE COMPACTION TESTING AND CONSTRUCTION CHALLENGES AND CITY METHODS FOR TESTING AND COMPACTION MAY NOT BE ACHIEVABLE. A UTILITY COMPACTION PLAN WILL BE REQUIRED AND MUST BE SUBMITTED FOR APPROVAL TO CITY PRIOR TO UTILITY INSTALLATION.

4. UTILITY TRENCH COMPACTION - ALL UTILITY TRENCH COMPACTION TESTS WITHIN THE STREET PAVEMENT/SIDEWALK SECTION SHALL BE THE RESPONSIBILITY OF THE DEVELOPER'S GEOTECHNICAL ENGINEER. FILL MATERIAL SHALL BE PLACED IN UNIFORM LAYERS NOT TO EXCEED TWELVE INCHES (12") LOOSE. DETERMINE THE MAXIMUM LIFT THICKNESS BASED ON THE ABILITY OF THE COMPACTING OPERATION AND EQUIPMENT USED TO MEET THE REQUIRED DENSITY. EACH LAYER OF MATERIAL SHALL BE COMPACTED TO A MINIMUM 95% DENSITY AND TESTED FOR DENSITY AND MOISTURE IN ACCORDANCE WITH TEST METHODS TEX-113-E, TEX-114-E, TEX-115-E. THE NUMBER AND LOCATION OF REQUIRED TESTS SHALL BE DETERMINED BY THE GEOTECHNICAL ENGINEER AND APPROVED BY THE CITY OF NEW BRAUNFELS STREET INSPECTOR. AT A MINIMUM, TESTS SHALL BE TAKEN EVERY 200 LF FOR EACH LIFT AND EVERY OTHER SERVICE LINE. UPON COMPLETION OF TESTING THE GEOTECHNICAL ENGINEER SHALL PROVIDE THE CITY OF NEW BRAUNFELS STREET INSPECTOR WITH ALL TESTING DOCUMENTATION AND A CERTIFICATION STATING THAT THE PLACEMENT OF FILL MATERIAL HAS BEEN COMPLETED IN ACCORDANCE WITH THE PLANS. ADDITIONAL DENSITY TESTS MAY BE REQUESTED BY THE CITY OF NEW BRAUNFELS INSPECTOR.

**CAUTION!!**

CONTRACTOR SHALL BE REQUIRED TO LOCATE ALL PUBLIC OR PRIVATE UTILITIES INCLUDING BUT NOT LIMITING TO: WATER, SEWER, TELEPHONE AND FIBER OPTIC LINES, SITE LIGHTING ELECTRIC, SECONDARY ELECTRIC, PRIMARY ELECTRICAL DUCTBANKS, LANDSCAPE IRRIGATION FACILITIES, AND GAS LINES. ANY UTILITY CONFLICTS THAT ARISE SHOULD BE COMMUNICATED TO THE ENGINEER IMMEDIATELY AND PRIOR TO CONSTRUCTION. THE CONTRACTOR SHALL CONTACT "TEXAS 811" A MINIMUM OF 48 HOURS PRIOR TO THE START OF CONSTRUCTION. ANY DAMAGE TO EXISTING UTILITIES SHALL BE THE SOLE RESPONSIBILITY OF THE CONTRACTOR AND THE REPAIR SHALL BE AT CONTRACTOR'S SOLE EXPENSE WHETHER THE UTILITY IS SHOWN ON THESE PLANS OR NOT.

**TRENCH EXCAVATION SAFETY PROTECTION:**

CONTRACTOR AND/OR CONTRACTOR'S INDEPENDENTLY RETAINED EMPLOYEE OR STRUCTURAL DESIGN/ GEOTECHNICAL/ SAFETY/EQUIPMENT CONSULTANT, IF ANY, SHALL REVIEW THESE PLANS AND ANY AVAILABLE GEOTECHNICAL INFORMATION AND THE ANTICIPATED INSTALLATION SITES WITHIN THE PROJECT WORK AREA IN ORDER TO IMPLEMENT CONTRACTOR'S TRENCH EXCAVATION SAFETY PROTECTION SYSTEMS, PROGRAMS AND /OR PROCEDURES FOR THE PROJECT DESCRIBED IN THE CONTRACT DOCUMENTS. THE CONTRACTOR'S IMPLEMENTATION OF THESE SYSTEMS, PROGRAMS AND/OR PROCEDURES SHALL PROVIDE FOR ADEQUATE TRENCH EXCAVATION SAFETY PROTECTION THAT COMPLY WITH AS A MINIMUM, OSHA STANDARDS FOR TRENCH EXCAVATIONS. SPECIFICALLY, CONTRACTOR AND/OR CONTRACTOR'S INDEPENDENTLY RETAINED EMPLOYEE OR SAFETY CONSULTANT SHALL IMPLEMENT A TRENCH SAFETY PROGRAM IN ACCORDANCE WITH OSHA STANDARDS GOVERNING THE PRESENCE AND ACTIVITIES OF INDIVIDUALS WORKING IN AND AROUND TRENCH EXCAVATION.

**PAPE-DAWSON ENGINEERS**

1672 INDEPENDENCE DR, STE 102 | NEW BRAUNFELS, TX 78132 | 800.632.5633  
TEXAS ENGINEERING FIRM #470 | TEXAS SURVEYING FIRM #1008800

**VERAMENDI PRECINCT 18 UNIT 1**  
NEW BRAUNFELS, TEXAS

**OVERALL SANITARY SEWER PLAN**

PLAT NO.	
JOB NO.	30001-66
DATE	07-03-2023
DESIGNER	GDL
CHECKED	✓ DRAWN BH
SHEET	C5.05

Date: Nov 20, 2023, 1:50pm User ID: Dlynch  
File: P:\3001\01\66\Design\Civil\SSDA-30001-66.dwg

FOR PERMIT



**CITY OF NEW BRAUNFELS NOTES**

- NO VALVES, HYDRANTS, ETC. SHALL BE CONSTRUCTED WITHIN CURBS, SIDEWALKS, OR DRIVEWAYS.
- ALL UTILITIES TO BE CONSTRUCTED PRIOR TO STREETS.
- THIS PROJECT INCLUDES UTILITY INSTALLATIONS GREATER THAN 5- FEET IN DEPTH. DEEP TRENCHES POSE COMPACTION TESTING AND CONSTRUCTION CHALLENGES AND CITY METHODS FOR TESTING AND COMPACTION MAY NOT BE ACHIEVABLE. A UTILITY COMPACTION PLAN WILL BE REQUIRED AND MUST BE SUBMITTED FOR APPROVAL TO CITY PRIOR TO UTILITY INSTALLATION.
- UTILITY TRENCH COMPACTION - ALL UTILITY TRENCH COMPACTION TESTS WITHIN THE STREET PAVEMENT/SIDEWALK SECTION SHALL BE THE RESPONSIBILITY OF THE DEVELOPER'S GEOTECHNICAL ENGINEER. FILL MATERIAL SHALL BE PLACED IN UNIFORM LAYERS NOT TO EXCEED TWELVE INCHES (12") LOOSE. DETERMINE THE MAXIMUM LIFT THICKNESS BASED ON THE ABILITY OF THE COMPACTING OPERATION AND EQUIPMENT USED TO MEET THE REQUIRED DENSITY. EACH LAYER OF MATERIAL SHALL BE COMPACTED TO A MINIMUM 95% DENSITY AND TESTED FOR DENSITY AND MOISTURE IN ACCORDANCE WITH TEST METHODS TEX-113-E, TEX-114-E, TEX-115-E. THE NUMBER AND LOCATION OF REQUIRED TESTS SHALL BE DETERMINED BY THE GEOTECHNICAL ENGINEER AND APPROVED BY THE CITY OF NEW BRAUNFELS STREET INSPECTOR. AT A MINIMUM, TESTS SHALL BE TAKEN EVERY 200 LF FOR EACH LIFT AND EVERY OTHER SERVICE LINE. UPON COMPLETION OF TESTING THE GEOTECHNICAL ENGINEER SHALL PROVIDE THE CITY OF NEW BRAUNFELS STREET INSPECTOR WITH ALL TESTING DOCUMENTATION AND A CERTIFICATION STATING THAT THE PLACEMENT OF FILL MATERIAL HAS BEEN COMPLETED IN ACCORDANCE WITH THE PLANS. ADDITIONAL DENSITY TESTS MAY BE REQUESTED BY THE CITY OF NEW BRAUNFELS STREET INSPECTOR.



**SEWER LEGEND**

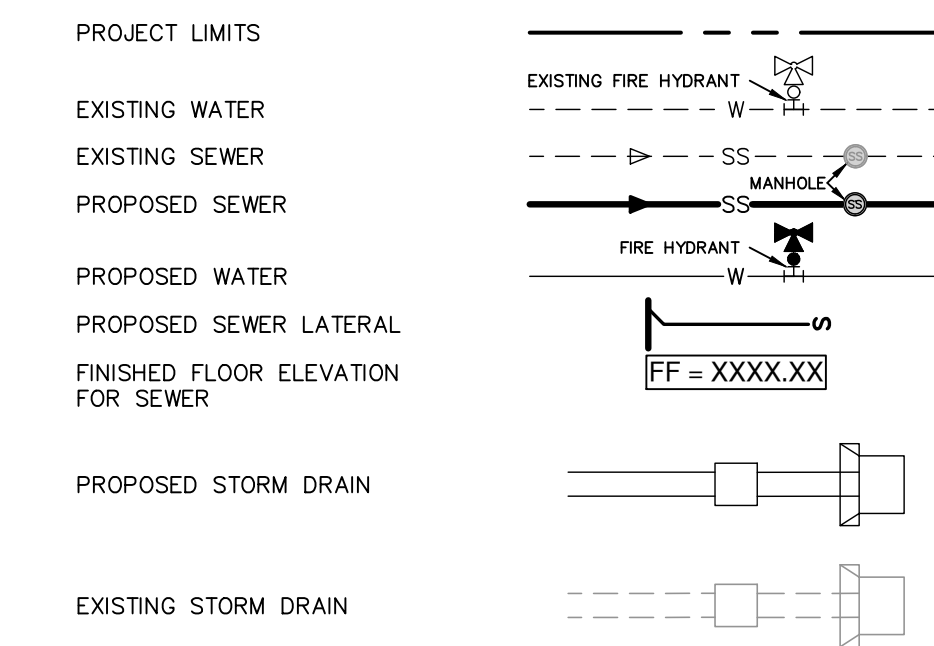

**NOTES**

- SEWER PIPE WHERE WATER LINE CROSSES SHALL BE 160 P.S.I. AND MEET THE REQUIREMENTS OF ASTM D2241 WITH ONE 20' JOINT CENTERED AT WATER MAIN.
- NO VERTICAL STACKS ALLOWED FOR ANY LOTS UNLESS OTHERWISE SPECIFIED BY THE ENGINEER.
- WHEN HORIZONTAL DISTANCE BETWEEN SEWER PIPES AND WATER MAIN IS LESS THAN 9 FOOT OF SEPARATION, SEWER MAIN SHALL BE INSTALLED WITH 150 PSI (MIN) PRESSURE PIPE AND FITTINGS IN ACCORDANCE WITH NBU'S WATER CONNECTION POLICY IN THE VICINITY OF WATER MAINS. (SEE SEWER NOTES SHEET C5.30)
- CONTRACTOR SHALL ENSURE THAT MANHOLES OUTSIDE OF PAVED AREAS ARE SET WITH TOP ELEVATIONS 2" ABOVE FINISHED GRADE WITH CONCRETE RING ENCASUREMENT. CONTRACTOR SHALL ENSURE THAT MANHOLES IN PAVED AREAS ARE SET TO MATCH TOP OF FINISHED GRADE.
- ALL SEWER PIPES SHALL BE 8" PVC (SDR 26), UNLESS OTHERWISE NOTED.
- CONTRACTOR IS TO VERIFY EXISTING INVERT OF SANITARY SEWER MAIN AND ALERT ENGINEER IMMEDIATELY OF ANY DIFFERENCE FROM INVERT SHOWN ON PLANS.
- CONTRACTOR SHALL PROTECT ALL EXISTING FENCES. ANY FENCE DAMAGED BY THE CONTRACTOR SHALL BE REPAIRED BY THE CONTRACTOR AT THEIR EXPENSE.
- THE CONTRACTOR WILL BE RESPONSIBLE FOR DETERMINING EXACT LOCATION OF ALL UTILITIES AND DRAINAGE STRUCTURES WHETHER SHOWN ON THE PLANS OR NOT. THE CONTRACTOR SHALL UNCOVER EXISTING UTILITIES PRIOR TO CONSTRUCTION TO VERIFY SIZE, GRADE, AND LOCATION. THE CONTRACTOR SHALL NOTIFY THE ENGINEER IMMEDIATELY OF ANY DEVIATIONS FROM PLANS PRIOR TO BEGINNING CONSTRUCTION. ANY DAMAGE TO EXISTING UTILITIES, WHETHER SHOWN ON THE PLANS OR NOT, SHALL BE THE CONTRACTOR'S RESPONSIBILITY TO REPAIR, AT HIS EXPENSE.
- SEE THIS SHEET FOR TYPICAL SANITARY SEWER/WATER CROSSING DETAIL.
- IF A CONFLICT EXISTS BETWEEN THE VARIOUS SUBMITTED DOCUMENTS (ENGINEERING CALCULATIONS, PROJECTED SPECIFICATIONS, PROJECTED PLANS, ADDENDUMS, ETC.), THE FOLLOWING DOCUMENTS TAKE PRECEDENCE: SPECIFICATIONS GOVERN OVER PLANS, SPECIAL CONDITIONS GOVERN OVER SPECIFICATIONS AND PLANS. ADDENDUMS TAKE PRECEDENCE OVER ALL.
- LAST 20 L.F. OF 8" STUB-OUT SHALL BE CONSTRUCTED OF P.V.C. SDR 26 (160 P.S.I.) PRESSURE PIPE.
- ALL SEWER PIPE LATERALS SHALL BE SDR 26 (CLASS 160) PVC PIPE AND SHALL HAVE A MINIMUM SLOPE OF 2%.
- WASTEWATER LATERALS SHALL BE LAID WITH A MINIMUM OF 36 INCHES OF COVER.
- NEW MANHOLES MUST BE CONSTRUCTED OF OR LINED WITH A CORROSION RESISTANT MATERIAL WHERE NEW CONSTRUCTION CONNECTS TO AN EXISTING MANHOLE THAT IS NOT CONSTRUCTED OF A CORROSION RESISTANT MATERIAL. THE EXISTING MANHOLE MUST BE LINED WITH OR REPLACED WITH A CORROSION RESISTANT MATERIAL.
- 48" MANHOLES ARE REQUIRED FOR ALL MAINS UP TO 18" IN DIAMETER.

**NOTE:**  
FOR PAVEMENT DESIGN SECTION SEE GEOTECHNICAL ENGINEERING REPORT.

**FLOODPLAIN NOTE**

- NO PORTION OF ANY LOT ON THIS PROJECT IS WITHIN AN INDICATED SPECIAL FLOOD HAZARD ZONE ACCORDING TO THE FEMA FIRM MAP NO. 48187C0095F EFFECTIVE DATE 9/2/2009.

**CAUTION!!**

CONTRACTOR SHALL BE REQUIRED TO LOCATE ALL PUBLIC OR PRIVATE UTILITIES INCLUDING BUT NOT LIMITING TO: WATER, SEWER, TELEPHONE AND FIBER OPTIC LINES, SITE LIGHTING ELECTRIC, SECONDARY ELECTRIC, PRIMARY ELECTRICAL, DUCTBANKS, LANDSCAPE IRRIGATION FACILITIES, AND GAS LINES. ANY UTILITY CONFLICTS THAT ARISE SHOULD BE COMMUNICATED TO THE ENGINEER IMMEDIATELY AND PRIOR TO CONSTRUCTION. THE CONTRACTOR SHALL CONTACT "TEXAS 811" A MINIMUM OF 48 HOURS PRIOR TO THE START OF CONSTRUCTION. ANY DAMAGE TO EXISTING UTILITIES SHALL BE THE SOLE RESPONSIBILITY OF THE CONTRACTOR AND THE REPAIR SHALL BE AT CONTRACTOR'S SOLE EXPENSE WHETHER THE UTILITY IS SHOWN ON THESE PLANS OR NOT.

**TRENCH EXCAVATION SAFETY PROTECTION:**

CONTRACTOR AND/OR CONTRACTOR'S INDEPENDENTLY RETAINED EMPLOYEE OR STRUCTURAL DESIGN/ GEOTECHNICAL/ SAFETY/EQUIPMENT CONSULTANT, IF ANY, SHALL REVIEW THESE PLANS AND ANY AVAILABLE GEOTECHNICAL INFORMATION AND THE ANTICIPATED INSTALLATION SITES WITHIN THE PROJECT WORK AREA IN ORDER TO IMPLEMENT CONTRACTOR'S TRENCH EXCAVATION SAFETY PROTECTION SYSTEMS, PROGRAMS AND /OR PROCEDURES FOR THE PROJECT DESCRIBED IN THE CONTRACT DOCUMENTS. THE CONTRACTOR'S IMPLEMENTATION OF THESE SYSTEMS, PROGRAMS AND/OR PROCEDURES SHALL PROVIDE FOR ADEQUATE TRENCH EXCAVATION SAFETY PROTECTION THAT COMPLY WITH AS A MINIMUM, OSHA STANDARDS FOR TRENCH EXCAVATIONS. SPECIFICALLY, CONTRACTOR AND/OR CONTRACTOR'S INDEPENDENTLY RETAINED EMPLOYEE OR SAFETY CONSULTANT SHALL IMPLEMENT A TRENCH SAFETY PROGRAM IN ACCORDANCE WITH OSHA STANDARDS GOVERNING THE PRESENCE AND ACTIVITIES OF INDIVIDUALS WORKING IN AND AROUND TRENCH EXCAVATION.

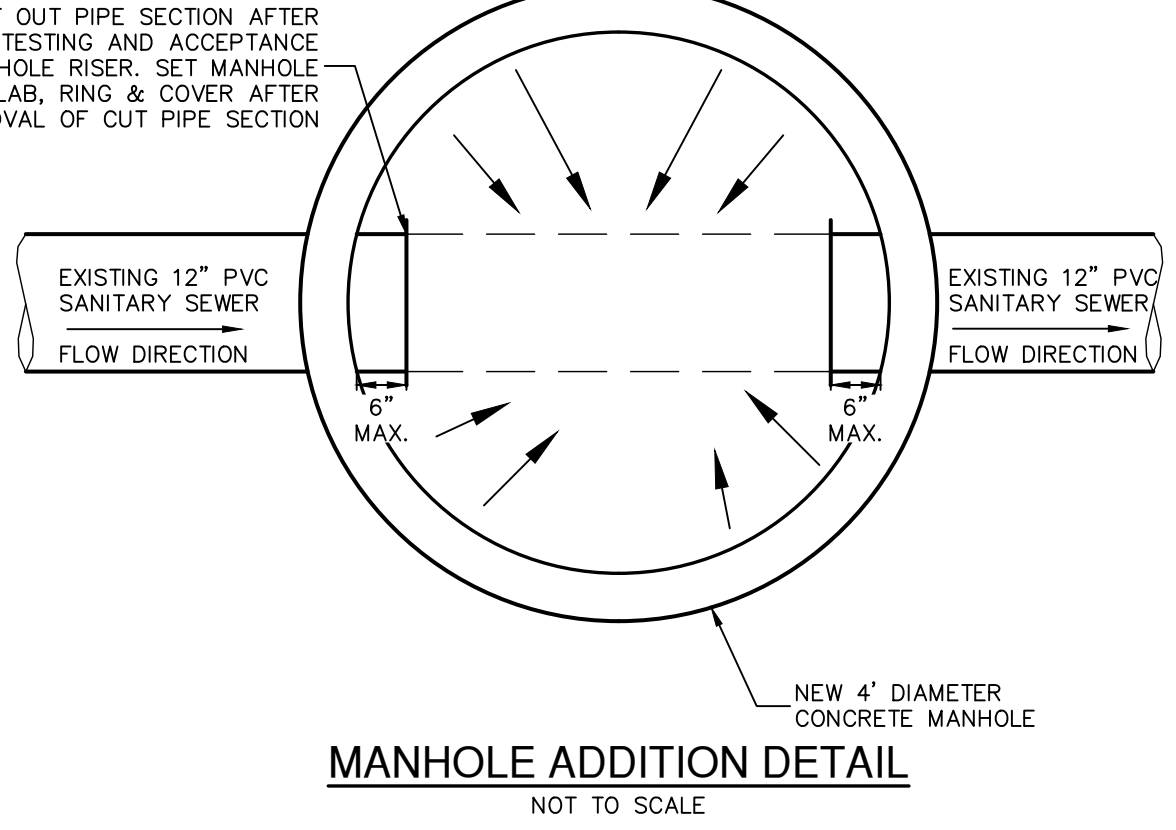
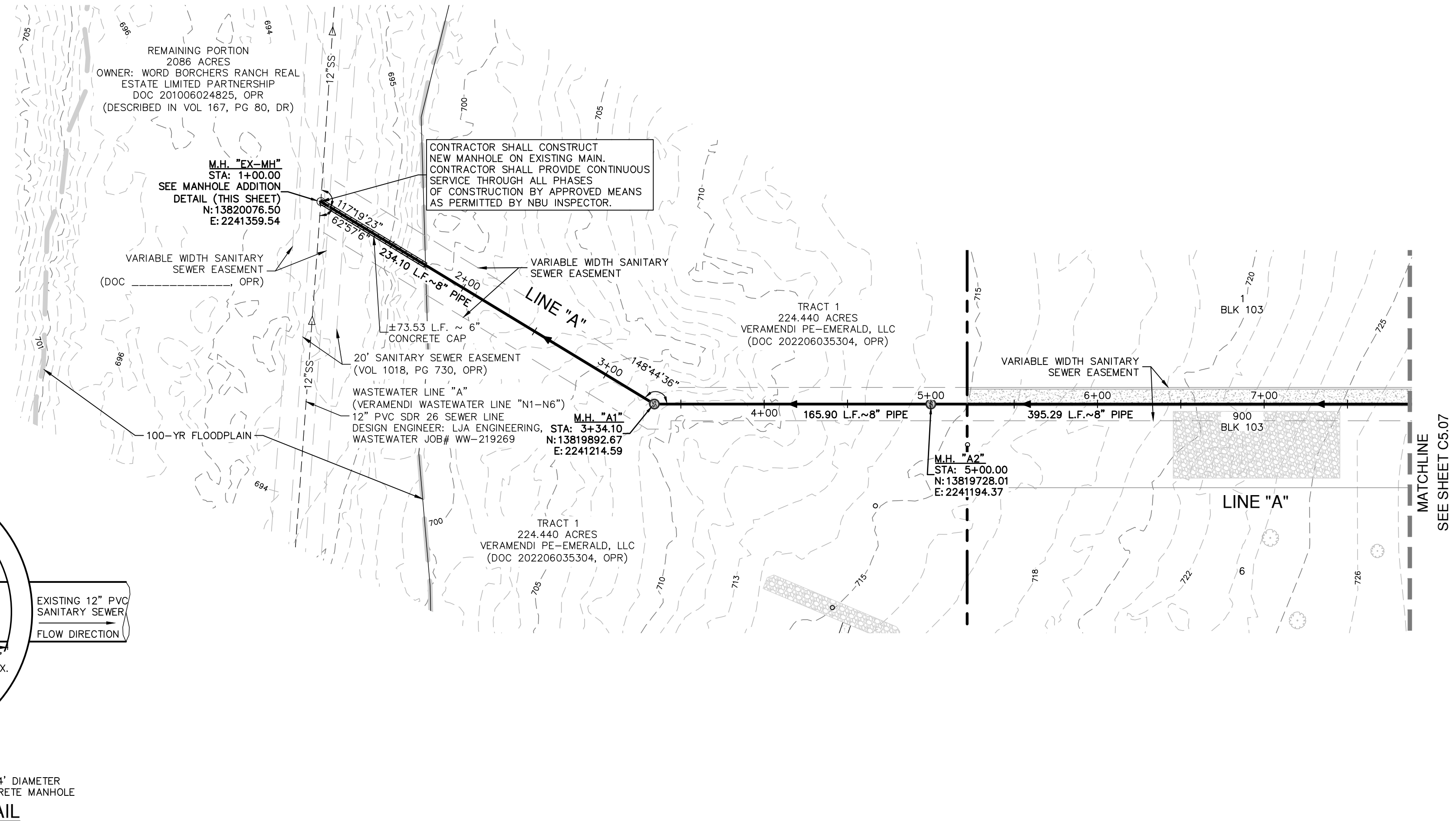

**SANITARY SEWER LINE "A"**  
STA 1+00.00 TO 8+00.00  
VERTICAL SCALE: 1" = 5'  
HORIZONTAL SCALE: 1" = 50'

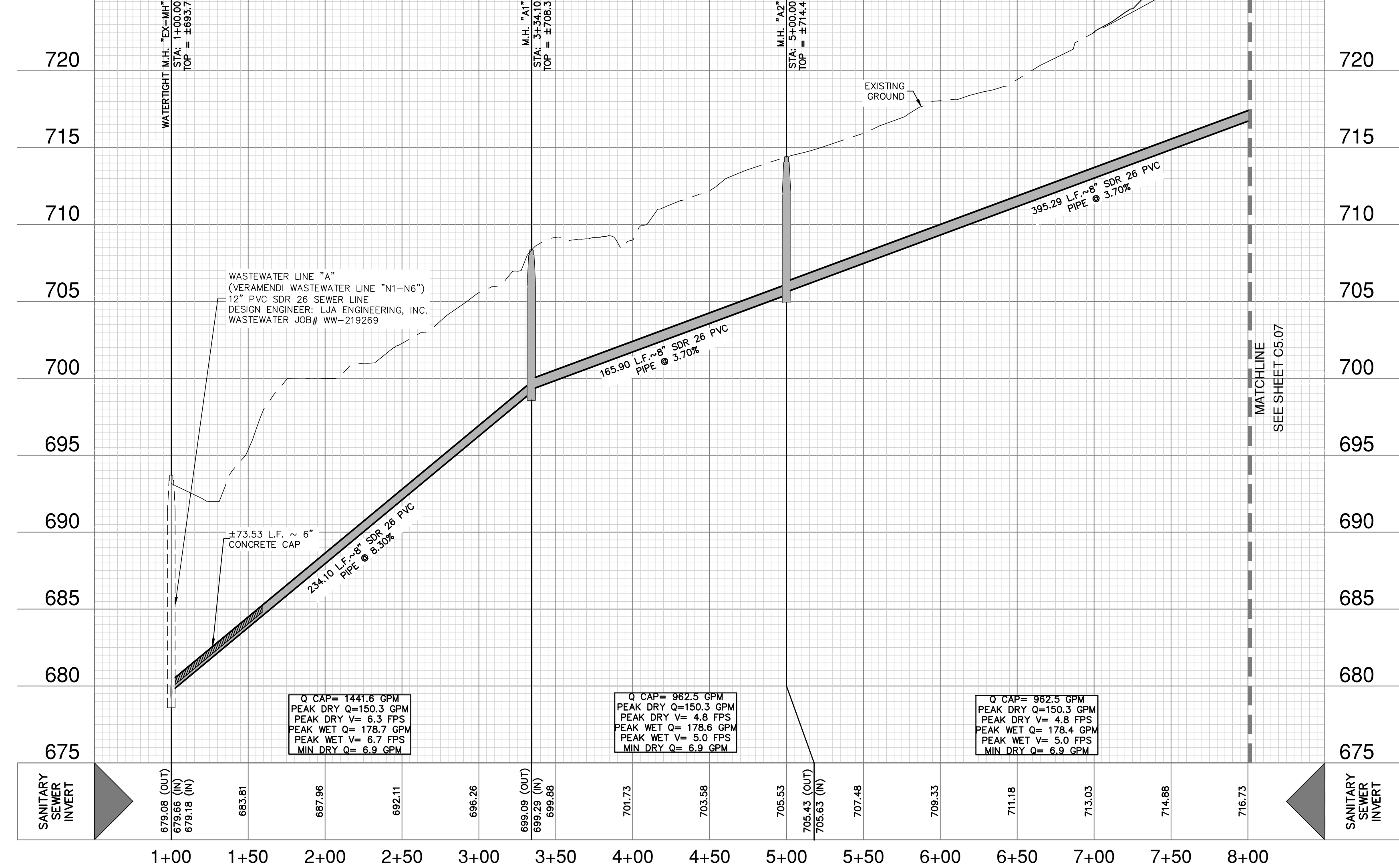

DATE: \_\_\_\_\_

NO. REVISION: \_\_\_\_\_

**PAPE-DAWSON ENGINEERS**

1672 INDEPENDENCE DR. STE 102 | NEW BRAUNFELS, TX 78132 | 800.632.5693  
TEXAS ENGINEERING FIRM #470 | TEXAS SURVEYING FIRM #1008890

**VERAMENDI PRECINCT 18 UNIT 1**  
NEW BRAUNFELS, TEXAS

**SANITARY SEWER LINE A - PLAN & PROFILE**  
STA 1+00.00 TO 8+00.00

JOB NO. 30001-66  
DATE 07-03-2023  
DESIGNER GDL  
CHECKED GDL DRAWN BH  
SHEET C5.06

Date: Nov 20, 2023, 1:51pm User ID: Dlynch  
File: P:\3001\01\66\Design\Chal\SSA-30001-66.dwg

**FOR PERMIT**



**CITY OF NEW BRAUNFELS NOTES**

- NO VALVES, HYDRANTS, ETC. SHALL BE CONSTRUCTED WITHIN CURBS, SIDEWALKS, OR DRIVEWAYS.
- ALL UTILITIES TO BE CONSTRUCTED PRIOR TO STREETS.
- THIS PROJECT INCLUDES UTILITY INSTALLATIONS GREATER THAN 5- FEET IN DEPTH. DEEP TRENCHES POSE COMPACTION TESTING AND CONSTRUCTION CHALLENGES AND CITY METHODS FOR TESTING AND COMPACTION MAY NOT BE ACHIEVABLE. A UTILITY COMPACTION PLAN WILL BE REQUIRED AND MUST BE SUBMITTED FOR APPROVAL TO CITY PRIOR TO UTILITY INSTALLATION.
- UTILITY TRENCH COMPACTION - ALL UTILITY TRENCH COMPACTION TESTS WITHIN THE STREET PAVEMENT/SIDEWALK SECTION SHALL BE THE RESPONSIBILITY OF THE DEVELOPER'S GEOTECHNICAL ENGINEER. FILL MATERIAL SHALL BE PLACED IN UNIFORM LAYERS NOT TO EXCEED TWELVE INCHES (12") LOOSE. DETERMINE THE MAXIMUM LIFT THICKNESS BASED ON THE ABILITY OF THE COMPACTION OPERATION AND EQUIPMENT USED TO MEET THE REQUIRED DENSITY. EACH LAYER OF MATERIAL SHALL BE COMPACTED TO A MINIMUM 95% DENSITY AND TESTED FOR DENSITY AND MOISTURE IN ACCORDANCE WITH TEST METHODS TEX-113-E, TEX-114-E, TEX-115-E. THE NUMBER AND LOCATION OF REQUIRED TESTS SHALL BE DETERMINED BY THE GEOTECHNICAL ENGINEER AND APPROVED BY THE CITY OF NEW BRAUNFELS STREET INSPECTOR. AT A MINIMUM, TESTS SHALL BE TAKEN EVERY 200 LF FOR EACH LIFT AND EVERY OTHER SERVICE LINE. UPON COMPLETION OF TESTING THE GEOTECHNICAL ENGINEER SHALL PROVIDE THE CITY OF NEW BRAUNFELS STREET INSPECTOR WITH ALL TESTING DOCUMENTATION AND A CERTIFICATION STATING THAT THE PLACEMENT OF FILL MATERIAL HAS BEEN COMPLETED IN ACCORDANCE WITH THE PLANS. ADDITIONAL DENSITY TESTS MAY BE REQUESTED BY THE CITY OF NEW BRAUNFELS INSPECTOR.

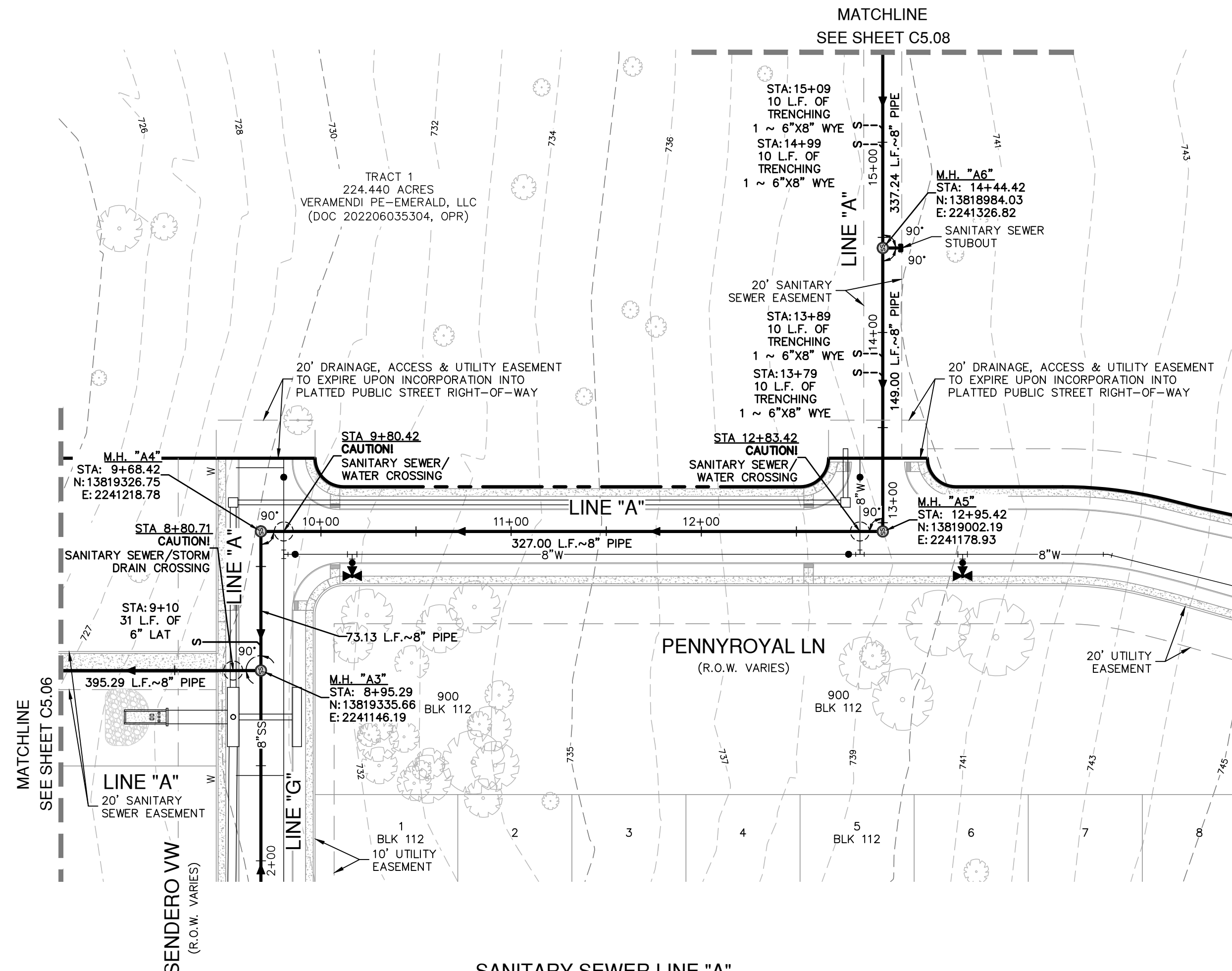
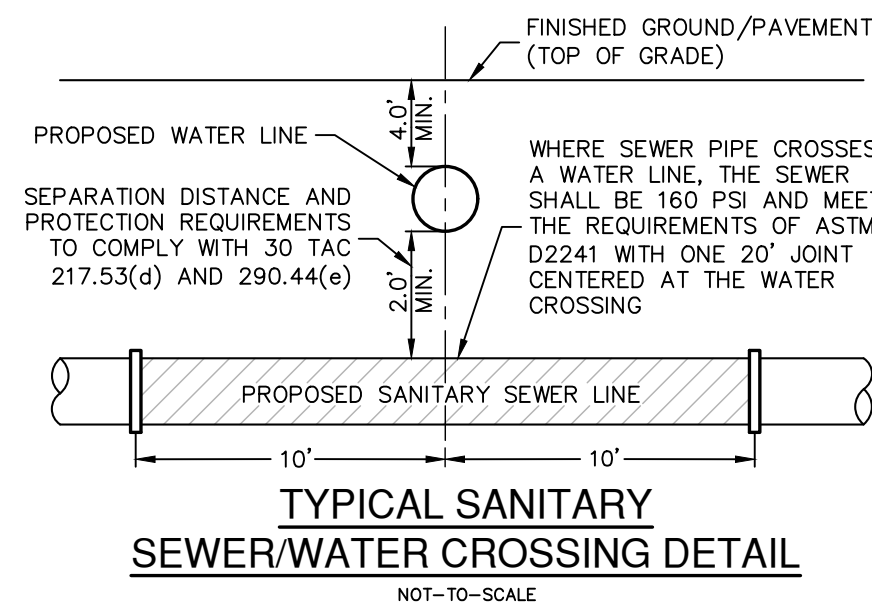

**SANITARY SEWER LINE "A"**  
STA 8+00.00 TO 16+00.00  
VERTICAL SCALE: 1" = 5'  
HORIZONTAL SCALE: 1" = 50'

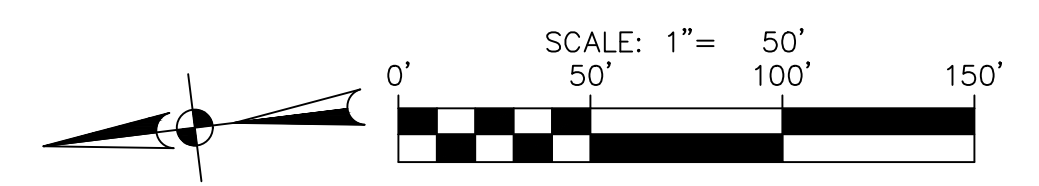
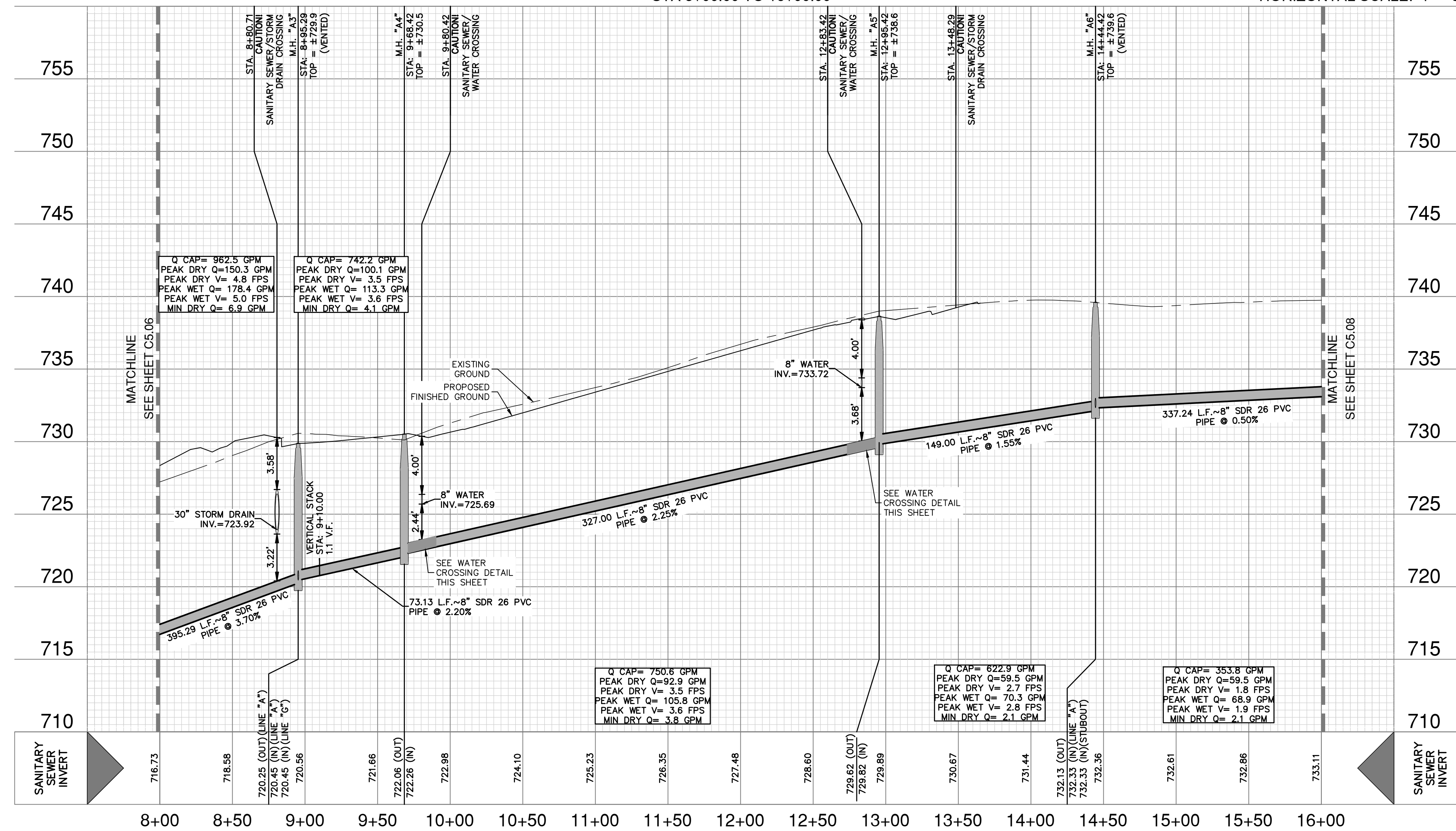

**SEWER LEGEND**

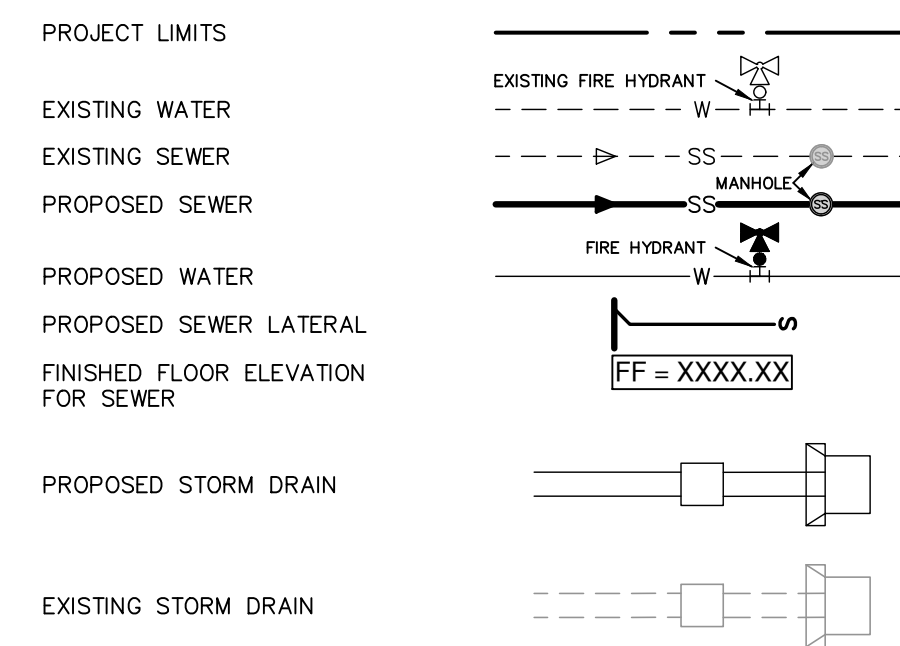

**NOTES**

- SEWER PIPE WHERE WATER LINE CROSSES SHALL BE 160 P.S.I. AND MEET THE REQUIREMENTS OF ASTM D2241 WITH ONE 20" JOINT CENTERED AT WATER MAIN.
- NO VERTICAL STACKS ALLOWED FOR ANY LOTS UNLESS OTHERWISE SPECIFIED BY THE ENGINEER.
- WHEN HORIZONTAL DISTANCE BETWEEN SEWER PIPES AND WATER MAIN IS LESS THAN 9 FEET OF SEPARATION, SEWER MAIN SHALL BE INSTALLED WITH 150 PSI (MIN) PRESSURE PIPE AND FITTINGS IN ACCORDANCE WITH NBU'S WATER CONNECTION POLICY IN THE VICINITY OF WATER MAINS. (SEE SEWER NOTES SHEET C5.30)
- CONTRACTOR SHALL ENSURE THAT MANHOLES OUTSIDE OF PAVED AREAS ARE SET WITH TOP ELEVATIONS 2" ABOVE FINISHED GRADE WITH CONCRETE RING ENGASEMENT. CONTRACTOR SHALL ENSURE THAT MANHOLES IN PAVED AREAS ARE SET TO MATCH TOP OF FINISHED GRADE.
- ALL SEWER PIPES SHALL BE 8" PVC (SDR 26), UNLESS OTHERWISE NOTED.
- CONTRACTOR IS TO VERIFY EXISTING INVERT OF SANITARY SEWER MAIN AND ALERT ENGINEER IMMEDIATELY OF ANY DIFFERENCE FROM INVERT SHOWN ON PLANS.
- CONTRACTOR SHALL PROTECT ALL EXISTING FENCES. ANY FENCE DAMAGED BY THE CONTRACTOR SHALL BE REPAIRED BY THE CONTRACTOR AT THEIR EXPENSE.
- THE CONTRACTOR WILL BE RESPONSIBLE FOR DETERMINING EXACT LOCATION OF ALL UTILITIES AND DRAINAGE STRUCTURES WHETHER SHOWN ON THE PLANS OR NOT. THE CONTRACTOR SHALL UNCOVER EXISTING UTILITIES PRIOR TO CONSTRUCTION TO VERIFY SIZE, GRADE, AND LOCATION. THE CONTRACTOR SHALL NOTIFY THE ENGINEER IMMEDIATELY OF ANY DEVIATIONS FROM PLANS PRIOR TO BEGINNING CONSTRUCTION. ANY DAMAGE TO EXISTING UTILITIES, WHETHER SHOWN ON THE PLANS OR NOT, SHALL BE THE CONTRACTOR'S RESPONSIBILITY TO REPAIR, AT HIS EXPENSE.
- SEE THIS SHEET FOR TYPICAL SANITARY SEWER/WATER CROSSING DETAIL.
- IF A CONFLICT EXISTS BETWEEN THE VARIOUS SUBMITTED DOCUMENTS (ENGINEERING CALCULATIONS, PROJECTED SPECIFICATIONS, PROJECTED PLANS, ADDENDUMS, ETC.), THE FOLLOWING DOCUMENTS TAKE PRECEDENCE: SPECIFICATIONS GOVERN OVER PLANS, SPECIAL CONDITIONS GOVERN OVER SPECIFICATIONS AND PLANS. ADDENDUMS TAKE PRECEDENCE OVER ALL.
- LAST 20 LF. OF 8" STUB-OUT SHALL BE CONSTRUCTED OF P.V.C. SDR 26 (160 P.S.I.) PRESSURE PIPE.
- ALL SEWER PIPE LATERALS SHALL BE SDR 26 (CLASS 160) PVC PIPE AND SHALL HAVE A MINIMUM SLOPE OF 2%.
- WASTEWATER LATERALS SHALL BE LAID WITH A MINIMUM OF 36 INCHES OF COVER.
- NEW MANHOLES MUST BE CONSTRUCTED OF OR LINED WITH A CORROSION RESISTANT MATERIAL. WHERE NEW CONSTRUCTION CONNECTS TO AN EXISTING MANHOLE THAT IS NOT CONSTRUCTED OF A CORROSION RESISTANT MATERIAL THE EXISTING MANHOLE MUST BE LINED WITH OR REPLACED WITH A CORROSION RESISTANT MATERIAL.
- 48" MANHOLES ARE REQUIRED FOR ALL MAINS UP TO 18" IN DIAMETER.

**NOTE:** FOR PAVEMENT DESIGN SECTION SEE GEOTECHNICAL ENGINEERING REPORT.

**FLOODPLAIN NOTE**

- NO PORTION OF ANY LOT ON THIS PROJECT IS WITHIN AN INDICATED SPECIAL FLOOD HAZARD ZONE ACCORDING TO THE FEMA FIRM MAP NO. 48187C0095F EFFECTIVE DATE 9/2/2009.

**CAUTION!!**

CONTRACTOR SHALL BE REQUIRED TO LOCATE ALL PUBLIC OR PRIVATE UTILITIES INCLUDING BUT NOT LIMITING TO: WATER, SEWER, TELEPHONE AND FIBER OPTIC LINES, SITE LIGHTING ELECTRIC, SECONDARY ELECTRIC, PRIMARY ELECTRICAL, DUCTBANKS, LANDSCAPE IRRIGATION FACILITIES, AND GAS LINES. ANY UTILITY CONFLICTS THAT ARISE SHOULD BE COMMUNICATED TO THE ENGINEER IMMEDIATELY AND PRIOR TO CONSTRUCTION. THE CONTRACTOR SHALL CONTACT "TEXAS 811" A MINIMUM OF 48 HOURS PRIOR TO THE START OF CONSTRUCTION. ANY DAMAGE TO EXISTING UTILITIES SHALL BE THE SOLE RESPONSIBILITY OF THE CONTRACTOR AND THE REPAIR SHALL BE AT CONTRACTOR'S SOLE EXPENSE WHETHER THE UTILITY IS SHOWN ON THESE PLANS OR NOT.

**TRENCH EXCAVATION SAFETY PROTECTION:**

CONTRACTOR AND/OR CONTRACTOR'S INDEPENDENTLY RETAINED EMPLOYEE OR STRUCTURAL DESIGN/ GEOTECHNICAL/ SAFETY/EQUIPMENT CONSULTANT, IF ANY, SHALL REVIEW THESE PLANS AND ANY AVAILABLE GEOTECHNICAL INFORMATION AND THE ANTICIPATED INSTALLATION SITES WITHIN THE PROJECT WORK AREA IN ORDER TO IMPLEMENT CONTRACTOR'S TRENCH EXCAVATION SAFETY PROTECTION SYSTEMS, PROGRAMS AND /OR PROCEDURES FOR THE PROJECT DESCRIBED IN THE CONTRACT DOCUMENTS. THE CONTRACTOR'S IMPLEMENTATION OF THESE SYSTEMS, PROGRAMS AND/OR PROCEDURES SHALL PROVIDE FOR ADEQUATE TRENCH EXCAVATION SAFETY PROTECTION THAT COMPLY WITH AS A MINIMUM, OSHA STANDARDS FOR TRENCH EXCAVATIONS. SPECIFICALLY, CONTRACTOR AND/OR CONTRACTOR'S INDEPENDENTLY RETAINED EMPLOYEE OR SAFETY CONSULTANT SHALL IMPLEMENT A TRENCH SAFETY PROGRAM IN ACCORDANCE WITH OSHA STANDARDS GOVERNING THE PRESENCE AND ACTIVITIES OF INDIVIDUALS WORKING IN AND AROUND TRENCH EXCAVATION.

DATE	
NO.	REVISION



**PAPE-DAWSON ENGINEERS**  
1672 INDEPENDENCE DR. STE 102 | NEW BRAUNFELS, TX 78132 | 800.632.5693  
TEXAS ENGINEERING FIRM #470 | TEXAS SURVEYING FIRM #10088800

**VERAMENDI PRECINCT 18 UNIT 1**  
NEW BRAUNFELS, TEXAS  
**SANITARY SEWER LINE A - PLAN & PROFILE**  
STA 8+00.00 TO 16+00.00

JOB NO.	30001-66
DATE	07-03-2023
DESIGNER	GDL
CHECKED	DRAWN BH
SHEET	C5.07

**FOR PERMIT**



**CITY OF NEW BRAUNFELS NOTES**

- NO VALVES, HYDRANTS, ETC. SHALL BE CONSTRUCTED WITHIN CURBS, SIDEWALKS, OR DRIVEWAYS.
- ALL UTILITIES TO BE CONSTRUCTED PRIOR TO STREETS.
- THIS PROJECT INCLUDES UTILITY INSTALLATIONS GREATER THAN 5- FEET IN DEPTH. DEEP TRENCHES POSE COMPACTION TESTING AND CONSTRUCTION CHALLENGES AND CITY METHODS FOR TESTING AND COMPACTION MAY NOT BE ACHIEVABLE. A UTILITY COMPACTION PLAN WILL BE REQUIRED AND MUST BE SUBMITTED FOR APPROVAL TO CITY PRIOR TO UTILITY INSTALLATION.
- UTILITY TRENCH COMPACTION - ALL UTILITY TRENCH COMPACTION TESTS WITHIN THE STREET PAVEMENT/SIDEWALK SECTION SHALL BE THE RESPONSIBILITY OF THE DEVELOPER'S GEOTECHNICAL ENGINEER. FILL MATERIAL SHALL BE PLACED IN UNIFORM LAYERS NOT TO EXCEED TWELVE INCHES (12") LOOSE. DETERMINE THE MAXIMUM LIFT THICKNESS BASED ON THE ABILITY OF THE COMPACTION OPERATION AND EQUIPMENT USED TO MEET THE REQUIRED DENSITY. EACH LAYER OF MATERIAL SHALL BE COMPACTED TO A MINIMUM 95% DENSITY AND TESTED FOR DENSITY AND MOISTURE IN ACCORDANCE WITH TEST METHODS TEX-113-E, TEX-114-E, TEX-115-E. THE NUMBER AND LOCATION OF REQUIRED TESTS SHALL BE DETERMINED BY THE GEOTECHNICAL ENGINEER AND APPROVED BY THE CITY OF NEW BRAUNFELS STREET INSPECTOR. AT A MINIMUM, TESTS SHALL BE TAKEN EVERY 200 LF FOR EACH LIFT AND EVERY OTHER SERVICE LINE. UPON COMPLETION OF TESTING THE GEOTECHNICAL ENGINEER SHALL PROVIDE THE CITY OF NEW BRAUNFELS STREET INSPECTOR WITH ALL TESTING DOCUMENTATION AND A CERTIFICATION STATING THAT THE PLACEMENT OF FILL MATERIAL HAS BEEN COMPLETED IN ACCORDANCE WITH THE PLANS. ADDITIONAL DENSITY TESTS MAY BE REQUESTED BY THE CITY OF NEW BRAUNFELS INSPECTOR.

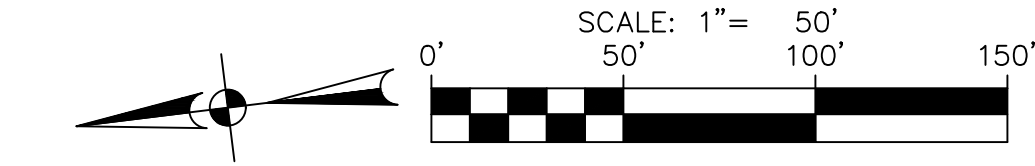

**SEWER LEGEND**

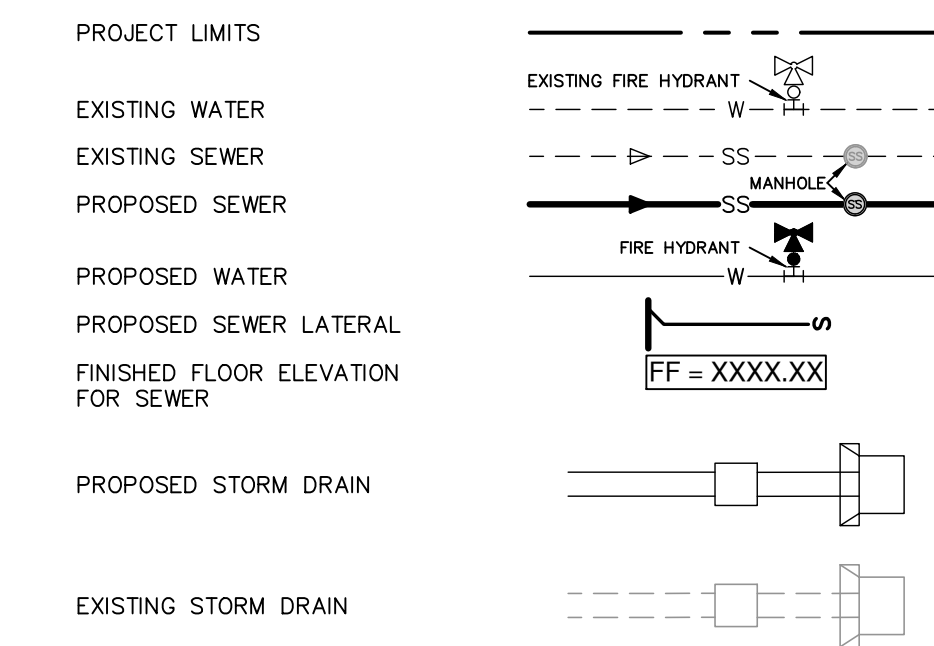

**NOTES**

- SEWER PIPE WHERE WATER LINE CROSSES SHALL BE 160 P.S.I. AND MEET THE REQUIREMENTS OF ASTM D2241 WITH ONE 20" JOINT CENTERED AT WATER MAIN.
- NO VERTICAL STACKS ALLOWED FOR ANY LOTS UNLESS OTHERWISE SPECIFIED BY THE ENGINEER.
- WHEN HORIZONTAL DISTANCE BETWEEN SEWER PIPES AND WATER MAIN IS LESS THAN 9 FEET SEPARATION, SEWER MAIN SHALL BE INSTALLED WITH 150 PSI (MIN) PRESSURE PIPE AND FITTINGS IN ACCORDANCE WITH NBU'S WATER CONNECTION POLICY IN THE VICINITY OF WATER MAINS. (SEE SEWER NOTES SHEET C5.30)
- CONTRACTOR SHALL ENSURE THAT MANHOLES OUTSIDE OF PAVED AREAS ARE SET WITH TOP ELEVATIONS 2" ABOVE FINISHED GRADE WITH CONCRETE RING ENGAGEMENT. CONTRACTOR SHALL ENSURE THAT MANHOLES IN PAVED AREAS ARE SET TO MATCH TOP OF FINISHED GRADE.
- ALL SEWER PIPES SHALL BE 8" PVC (SDR 26), UNLESS OTHERWISE NOTED.
- CONTRACTOR IS TO VERIFY EXISTING INVERT OF SANITARY SEWER MAIN AND ALERT ENGINEER IMMEDIATELY OF ANY DIFFERENCE FROM INVERT SHOWN ON PLANS.
- CONTRACTOR SHALL PROTECT ALL EXISTING FENCES. ANY FENCE DAMAGED BY THE CONTRACTOR SHALL BE REPAIRED BY THE CONTRACTOR AT THEIR EXPENSE.
- THE CONTRACTOR WILL BE RESPONSIBLE FOR DETERMINING EXACT LOCATION OF ALL UTILITIES AND DRAINAGE STRUCTURES WHETHER SHOWN ON THE PLANS OR NOT. THE CONTRACTOR SHALL UNCOVER EXISTING UTILITIES PRIOR TO CONSTRUCTION TO VERIFY SIZE, GRADE, AND LOCATION. THE CONTRACTOR SHALL NOTIFY THE ENGINEER IMMEDIATELY OF ANY DEVIATIONS FROM PLANS PRIOR TO BEGINNING CONSTRUCTION. ANY DAMAGE TO EXISTING UTILITIES, WHETHER SHOWN ON THE PLANS OR NOT, SHALL BE THE CONTRACTOR'S RESPONSIBILITY TO REPAIR, AT HIS EXPENSE.
- SEE THIS SHEET FOR TYPICAL SANITARY SEWER/WATER CROSSING DETAIL.
- IF A CONFLICT EXISTS BETWEEN THE VARIOUS SUBMITTED DOCUMENTS (ENGINEERING CALCULATIONS, PROJECTED SPECIFICATIONS, PROJECTED PLANS, ADDENDUMS, ETC.), THE FOLLOWING DOCUMENTS TAKE PRECEDENCE: SPECIFICATIONS GOVERN OVER PLANS, SPECIAL CONDITIONS GOVERN OVER SPECIFICATIONS AND PLANS. ADDENDUMS TAKE PRECEDENCE OVER ALL.
- LAST 20' L.F. OF 8" STUB-OUT SHALL BE CONSTRUCTED OF P.V.C. SDR 26 (160 P.S.I.) PRESSURE PIPE.
- ALL SEWER PIPE LATERALS SHALL BE SDR 26 (CLASS 160) PVC PIPE AND SHALL HAVE A MINIMUM SLOPE OF 2%.
- WASTEWATER LATERALS SHALL BE LAID WITH A MINIMUM OF 36 INCHES OF COVER.
- NEW MANHOLES MUST BE CONSTRUCTED OF OR LINED WITH A CORROSION RESISTANT MATERIAL WHERE NEW CONSTRUCTION CONNECTS TO AN EXISTING MANHOLE THAT IS NOT CONSTRUCTED OF A CORROSION RESISTANT MATERIAL. THE EXISTING MANHOLE MUST BE LINED WITH OR REPLACED WITH A CORROSION RESISTANT MATERIAL.
- 48" MANHOLES ARE REQUIRED FOR ALL MAINS UP TO 18" IN DIAMETER.

**NOTE:** FOR PAVEMENT DESIGN SECTION SEE GEOTECHNICAL ENGINEERING REPORT.

**FLOODPLAIN NOTE**

- NO PORTION OF ANY LOT ON THIS PROJECT IS WITHIN AN INDICATED SPECIAL FLOOD HAZARD ZONE ACCORDING TO THE FEMA FIRM MAP NO. 48187C0095F EFFECTIVE DATE 9/2/2009.

**CAUTION!!**

CONTRACTOR SHALL BE REQUIRED TO LOCATE ALL PUBLIC OR PRIVATE UTILITIES INCLUDING BUT NOT LIMITING TO: WATER, SEWER, TELEPHONE AND FIBER OPTIC LINES, SITE LIGHTING ELECTRIC, SECONDARY ELECTRIC, PRIMARY ELECTRICAL, DUCTIRIANS, LANDSCAPE IRRIGATION FACILITIES, AND GAS LINES. ANY UTILITY CONFLICTS THAT ARISE SHOULD BE COMMUNICATED TO THE ENGINEER IMMEDIATELY AND PRIOR TO CONSTRUCTION. THE CONTRACTOR SHALL CONTACT "TEXAS 811" A MINIMUM OF 48 HOURS PRIOR TO THE START OF CONSTRUCTION. ANY DAMAGE TO EXISTING UTILITIES SHALL BE THE SOLE RESPONSIBILITY OF THE CONTRACTOR AND THE REPAIR SHALL BE AT CONTRACTOR'S SOLE EXPENSE WHETHER THE UTILITY IS SHOWN ON THESE PLANS OR NOT.

**TRENCH EXCAVATION SAFETY PROTECTION:**

CONTRACTOR AND/OR CONTRACTOR'S INDEPENDENTLY RETAINED EMPLOYEE OR STRUCTURAL DESIGN/ GEOTECHNICAL/ SAFETY/EQUIPMENT CONSULTANT, IF ANY, SHALL REVIEW THESE PLANS AND ANY AVAILABLE GEOTECHNICAL INFORMATION AND THE ANTICIPATED INSTALLATION SITES WITHIN THE PROJECT WORK AREA IN ORDER TO IMPLEMENT CONTRACTOR'S TRENCH EXCAVATION SAFETY PROTECTION SYSTEMS, PROGRAMS AND /OR PROCEDURES FOR THE PROJECT DESCRIBED IN THE CONTRACT DOCUMENTS. THE CONTRACTOR'S IMPLEMENTATION OF THESE SYSTEMS, PROGRAMS AND/OR PROCEDURES SHALL PROVIDE FOR ADEQUATE TRENCH EXCAVATION SAFETY PROTECTION THAT COMPLY WITH AS A MINIMUM, OSHA STANDARDS FOR TRENCH EXCAVATIONS. SPECIFICALLY, CONTRACTOR AND/OR CONTRACTOR'S INDEPENDENTLY RETAINED EMPLOYEE OR SAFETY CONSULTANT SHALL IMPLEMENT A TRENCH SAFETY PROGRAM IN ACCORDANCE WITH OSHA STANDARDS GOVERNING THE PRESENCE AND ACTIVITIES OF INDIVIDUALS WORKING IN AND AROUND TRENCH EXCAVATION.

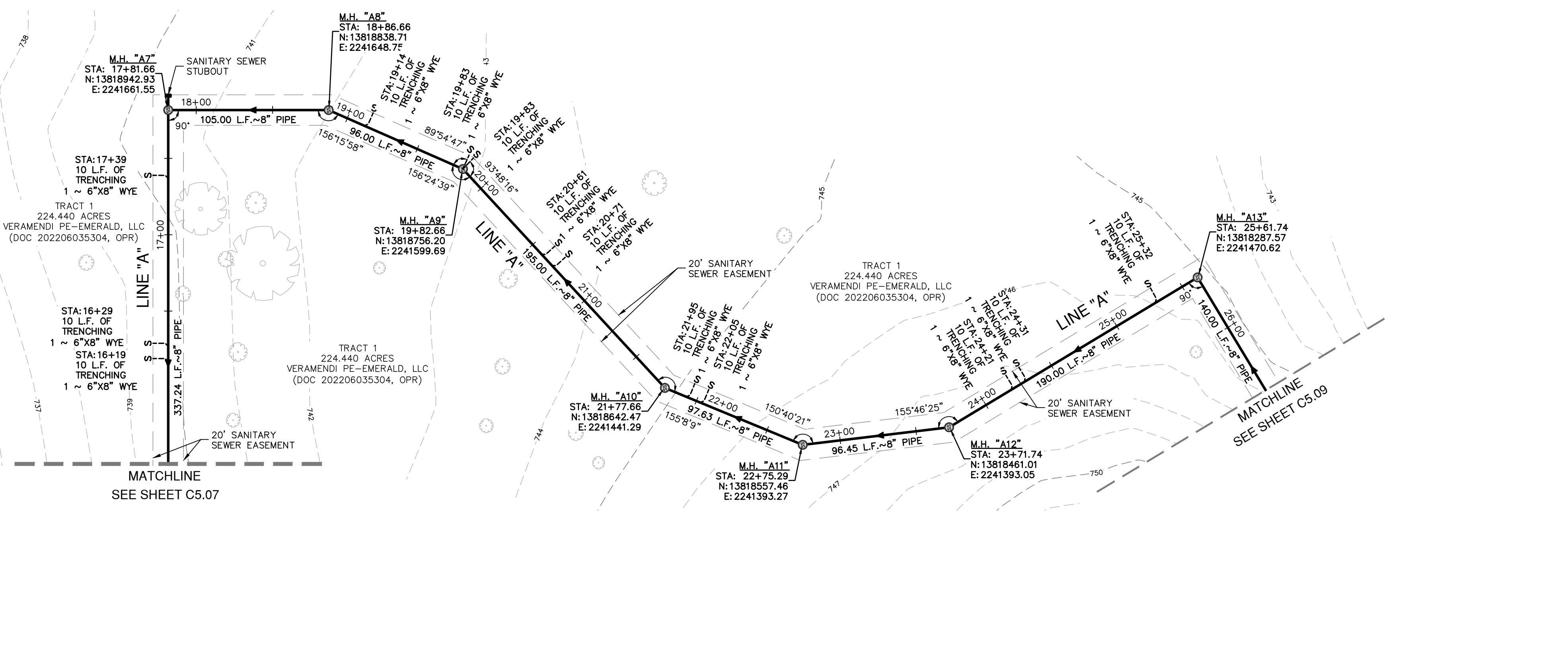

**SANITARY SEWER LINE "A"  
STA 16+00.00 TO 27+00.00**  
VERTICAL SCALE: 1" = 5'  
HORIZONTAL SCALE: 1" = 50'

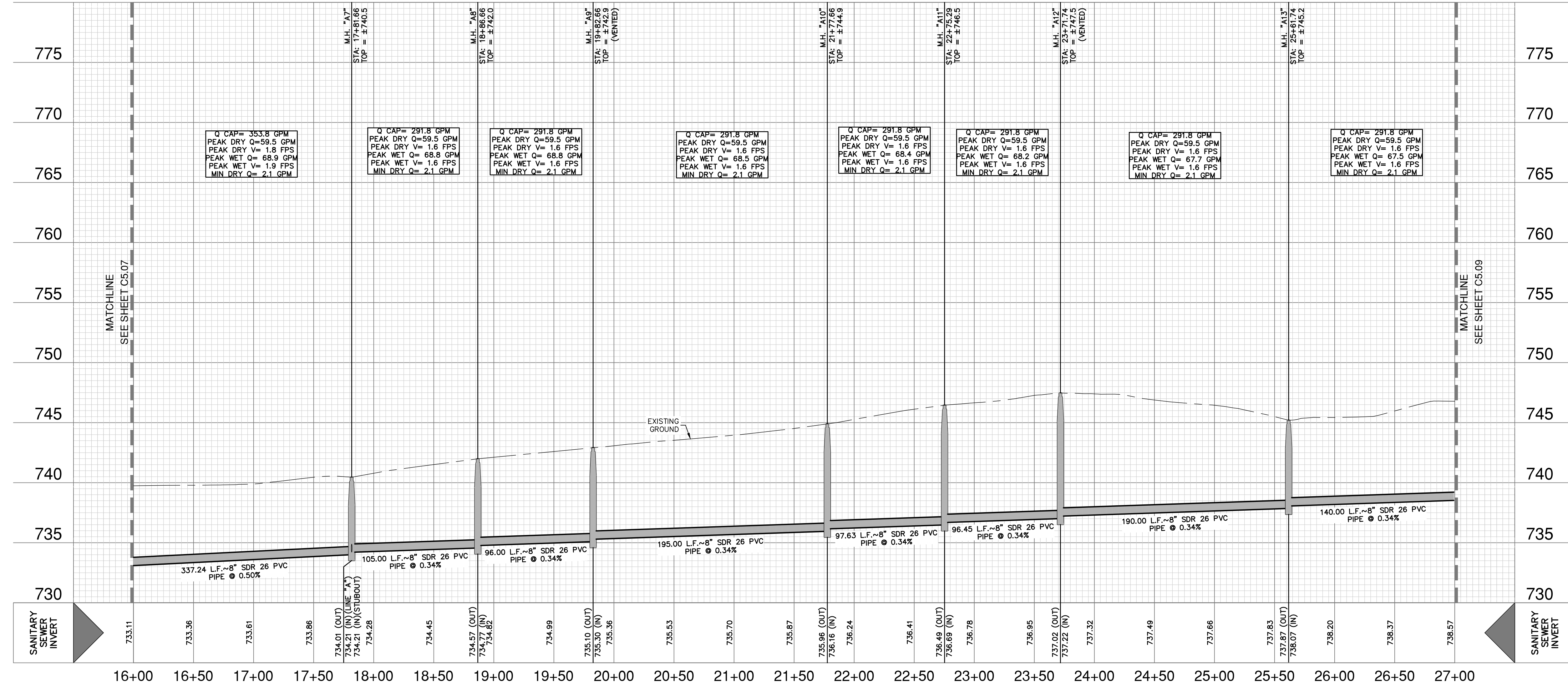

DATE: \_\_\_\_\_

NO. REVISION: \_\_\_\_\_

11-20-2023

Jocelyn Perez  
Professional Engineer

**PAPE-DAWSON ENGINEERS**

1672 INDEPENDENCE DR. STE 102 | NEW BRAUNFELS, TX 78132 | 800.632.5693  
TEXAS ENGINEERING FIRM #470 | TEXAS SURVEYING FIRM #1008800

**VERAMENDI PRECINCT 18 UNIT 1**  
NEW BRAUNFELS, TEXAS

**SANITARY SEWER LINE A - PLAN & PROFILE**  
STA 16+00.00 TO 27+00.00

JOB NO. 30001-66  
DATE 07-03-2023  
DESIGNER GDL  
CHECKED [initials] DRAWN BH  
SHEET C5.08

Date: Nov 20, 2023, 1:53pm User ID: Dlynch  
File: P:\3001\01\Veramendi\Design\Chil\SSA-30001-66.dwg

THIS DOCUMENT HAS BEEN PRODUCED FROM MATERIAL THAT WAS STORED AND/OR TRANSMITTED ELECTRONICALLY AND MAY HAVE BEEN INADVERTENTLY ALTERED. RELY ONLY ON FINAL HARD COPY MATERIALS BEARING THE CONSULTANT'S ORIGINAL SIGNATURE AND SEAL. AERIAL IMAGERY PROVIDED BY GOOGLE/UNLESS OTHERWISE NOTED. Imagery © 2016, CAPOCO, DigitalGlobe, Texas Orthology Program, USDA Farm Service Agency.

**FOR PERMIT**



**CITY OF NEW BRAUNFELS NOTES**

- NO VALVES, HYDRANTS, ETC. SHALL BE CONSTRUCTED WITHIN CURBS, SIDEWALKS, OR DRIVEWAYS.
- ALL UTILITIES TO BE CONSTRUCTED PRIOR TO STREETS.
- THIS PROJECT INCLUDES UTILITY INSTALLATIONS GREATER THAN 5- FEET IN DEPTH. DEEP TRENCHES POSE COMPACTION TESTING AND CONSTRUCTION CHALLENGES AND CITY METHODS FOR TESTING AND COMPACTION MAY NOT BE ACHIEVABLE. A UTILITY COMPACTION PLAN WILL BE REQUIRED AND MUST BE SUBMITTED FOR APPROVAL TO CITY PRIOR TO UTILITY INSTALLATION.
- UTILITY TRENCH COMPACTION - ALL UTILITY TRENCH COMPACTION TESTS WITHIN THE STREET PAVEMENT/SIDEWALK SECTION SHALL BE THE RESPONSIBILITY OF THE DEVELOPER'S GEOTECHNICAL ENGINEER. FILL MATERIAL SHALL BE PLACED IN UNIFORM LAYERS NOT TO EXCEED TWELVE INCHES (12") LOOSE. DETERMINE THE MAXIMUM LIFT THICKNESS BASED ON THE ABILITY OF THE COMPACTION OPERATION AND EQUIPMENT USED TO MEET THE REQUIRED DENSITY. EACH LAYER OF MATERIAL SHALL BE COMPACTED TO A MINIMUM 95% DENSITY AND TESTED FOR DENSITY AND MOISTURE IN ACCORDANCE WITH TEST METHODS TEX-113-E, TEX-114-E, TEX-115-E. THE NUMBER AND LOCATION OF REQUIRED TESTS SHALL BE DETERMINED BY THE GEOTECHNICAL ENGINEER AND APPROVED BY THE CITY OF NEW BRAUNFELS STREET INSPECTOR. AT A MINIMUM, TESTS SHALL BE TAKEN EVERY 200 LF FOR EACH LIFT AND EVERY OTHER SERVICE LINE. UPON COMPLETION OF TESTING THE GEOTECHNICAL ENGINEER SHALL PROVIDE THE CITY OF NEW BRAUNFELS STREET INSPECTOR WITH ALL TESTING DOCUMENTATION AND A CERTIFICATION STATING THAT THE PLACEMENT OF FILL MATERIAL HAS BEEN COMPLETED IN ACCORDANCE WITH THE PLANS. ADDITIONAL DENSITY TESTS MAY BE REQUESTED BY THE CITY OF NEW BRAUNFELS INSPECTOR.

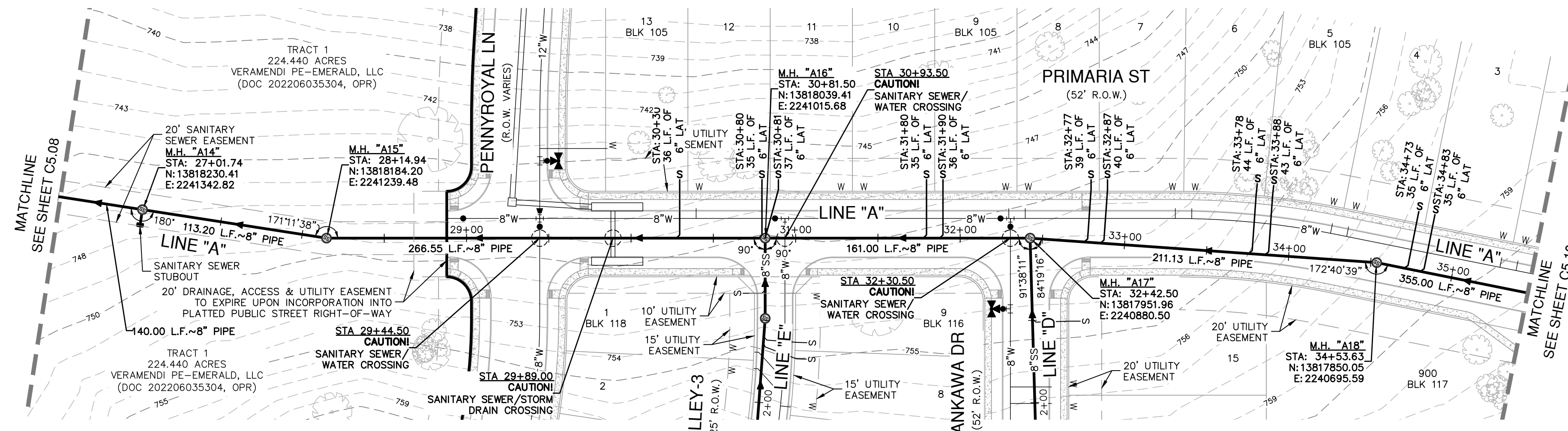
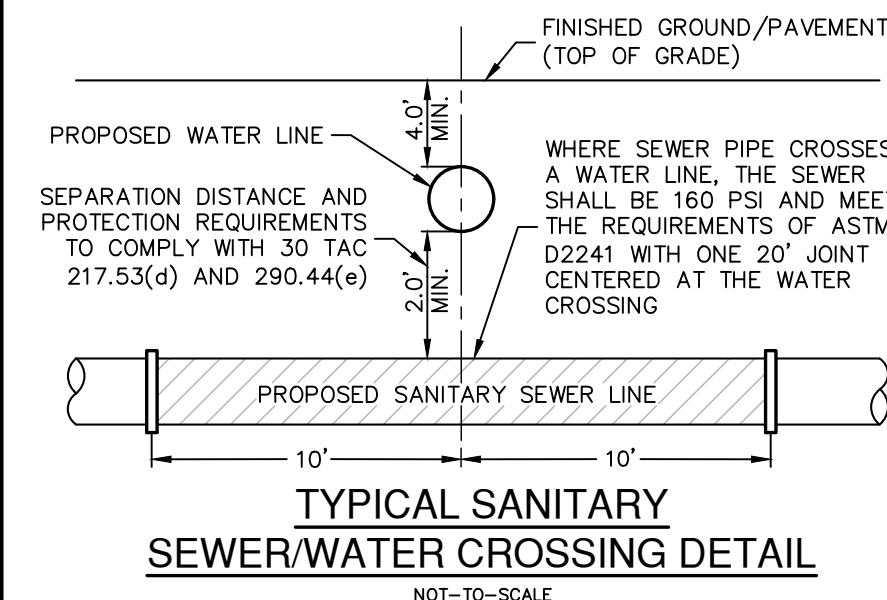

**SANITARY SEWER LINE "A"**  
STA 26+50.00 TO 36+00.00

**VERTICAL SCALE: 1" = 5'**  
**HORIZONTAL SCALE: 1" = 50'**

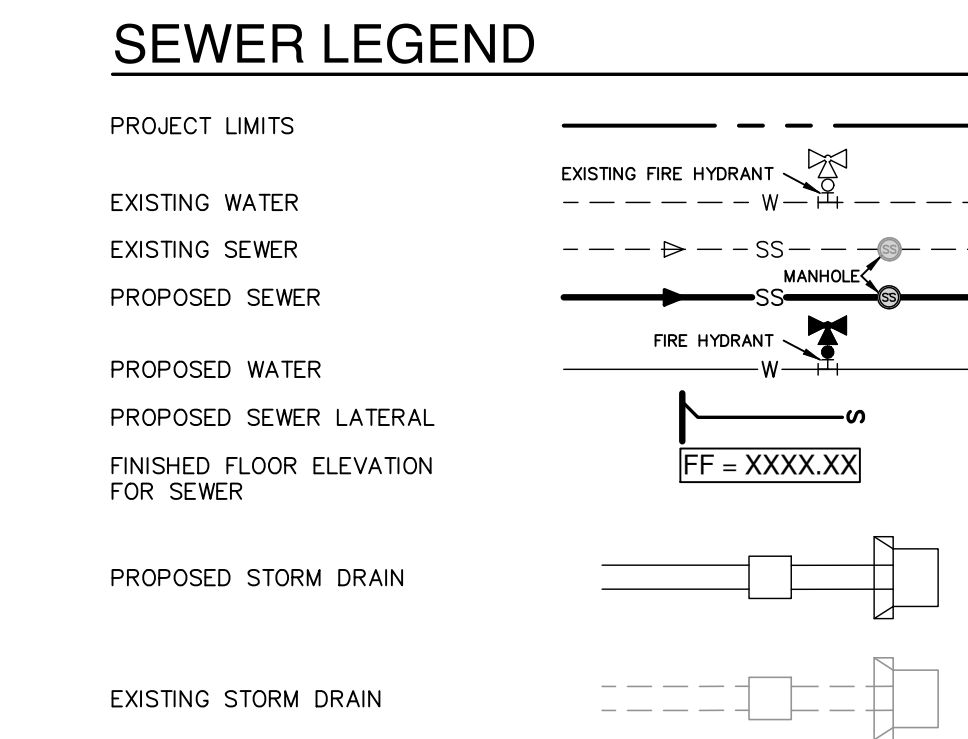
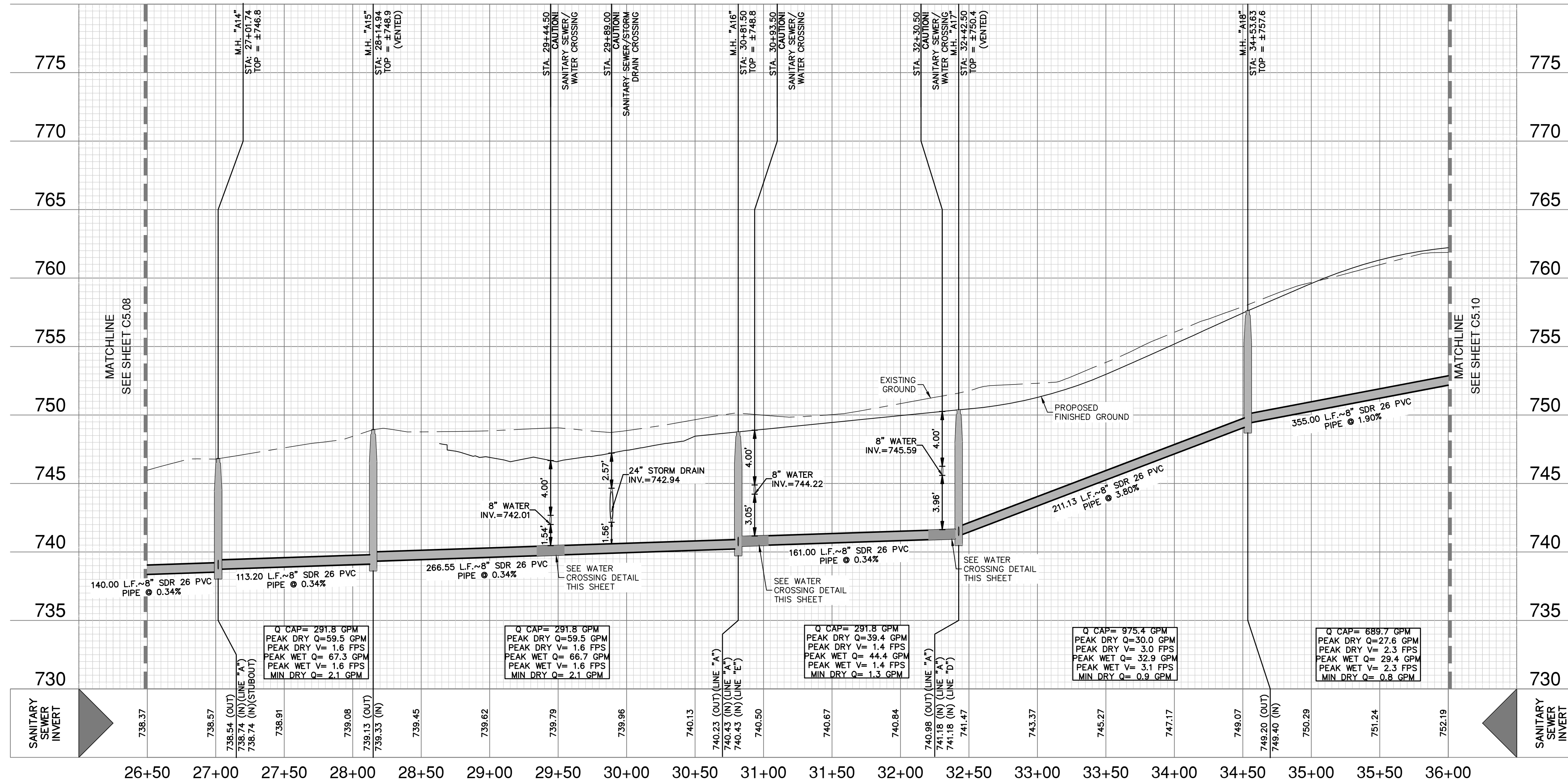

- NOTES**
- SEWER PIPE WHERE WATER LINE CROSSES SHALL BE 160 P.S.I. AND MEET THE REQUIREMENTS OF ASTM D2241 WITH ONE 20' JOINT CENTERED AT WATER MAIN.
  - NO VERTICAL STACKS ALLOWED FOR ANY LOTS UNLESS OTHERWISE SPECIFIED BY THE ENGINEER.
  - WHEN HORIZONTAL DISTANCE BETWEEN SEWER PIPES AND WATER MAIN IS LESS THAN 9 FEET OF SEPARATION, SEWER MAIN SHALL BE INSTALLED WITH 150 PSI (MIN) PRESSURE PIPE AND FITTINGS IN ACCORDANCE WITH NBUS' WATER CONNECTION POLICY IN THE VICINITY OF WATER MAINS. (SEE SEWER NOTES SHEET C5.30)
  - CONTRACTOR SHALL ENSURE THAT MANHOLES OUTSIDE OF PAVED AREAS ARE SET WITH TOP ELEVATIONS 2" ABOVE FINISHED GRADE WITH CONCRETE RING ENCASUREMENT. CONTRACTOR SHALL ENSURE THAT MANHOLES IN PAVED AREAS ARE SET TO MATCH TOP OF FINISHED GRADE.
  - ALL SEWER PIPES SHALL BE 8" PVC (SDR 26), UNLESS OTHERWISE NOTED.
  - CONTRACTOR IS TO VERIFY EXISTING INVERT OF SANITARY SEWER MAIN AND ALERT ENGINEER IMMEDIATELY OF ANY DIFFERENCE FROM INVERT SHOWN ON PLANS.
  - CONTRACTOR SHALL PROTECT ALL EXISTING FENCES. ANY FENCE DAMAGED BY THE CONTRACTOR SHALL BE REPAIRED BY THE CONTRACTOR AT THEIR EXPENSE.
  - THE CONTRACTOR SHALL BE RESPONSIBLE FOR DETERMINING EXACT LOCATION OF ALL UTILITIES AND DRAINAGE STRUCTURES WHETHER SHOWN ON THE PLANS OR NOT. THE CONTRACTOR SHALL UNCOVER EXISTING UTILITIES PRIOR TO CONSTRUCTION TO VERIFY SIZE, GRADE, AND LOCATION. THE CONTRACTOR SHALL NOTIFY THE ENGINEER IMMEDIATELY OF ANY DEVIATIONS FROM PLANS PRIOR TO BEGINNING CONSTRUCTION. ANY DAMAGE TO EXISTING UTILITIES, WHETHER SHOWN ON THE PLANS OR NOT, SHALL BE THE CONTRACTOR'S RESPONSIBILITY TO REPAIR, AT HIS EXPENSE.
  - SEE THIS SHEET FOR TYPICAL SANITARY SEWER/WATER CROSSING DETAIL.
  - IF A CONFLICT EXISTS BETWEEN THE VARIOUS SUBMITTED DOCUMENTS (ENGINEERING CALCULATIONS, PROJECTED SPECIFICATIONS, PROJECTED PLANS, ADDENDUMS, ETC.), THE FOLLOWING DOCUMENTS TAKE PRECEDENCE: SPECIFICATIONS GOVERN OVER PLANS, SPECIAL CONDITIONS GOVERN OVER SPECIFICATIONS AND PLANS. ADDENDUMS TAKE PRECEDENCE OVER ALL.
  - LAST 20 LF. OF 8" STUB-OUT SHALL BE CONSTRUCTED OF P.V.C. SDR 26 (160 P.S.I.) PRESSURE PIPE.
  - ALL SEWER PIPE LATERALS SHALL BE SDR 26 (CLASS 160) PVC PIPE AND SHALL HAVE A MINIMUM SLOPE OF 2%.
  - WASTEWATER LATERALS SHALL BE LAID WITH A MINIMUM OF 36 INCHES OF COVER.
  - NEW MANHOLES MUST BE CONSTRUCTED OF OR LINED WITH A CORROSION RESISTANT MATERIAL WHERE NEW CONSTRUCTION CONNECTS TO AN EXISTING MANHOLE THAT IS NOT CONSTRUCTED OF A CORROSION RESISTANT MATERIAL. THE EXISTING MANHOLE MUST BE LINED WITH OR REPLACED WITH A CORROSION RESISTANT MATERIAL.
  - 48" MANHOLES ARE REQUIRED FOR ALL MAINS UP TO 18" IN DIAMETER.
- NOTE:**  
FOR PAVEMENT DESIGN SECTION SEE GEOTECHNICAL ENGINEERING REPORT.

- FLOODPLAIN NOTE**
- NO PORTION OF ANY LOT ON THIS PROJECT IS WITHIN AN INDICATED SPECIAL FLOOD HAZARD ZONE ACCORDING TO THE FEMA FIRM MAP NO. 48187C0095F EFFECTIVE DATE 9/2/2009.
- CAUTION!!**  
CONTRACTOR SHALL BE REQUIRED TO LOCATE ALL PUBLIC OR PRIVATE UTILITIES INCLUDING BUT NOT LIMITING TO: WATER, SEWER, TELEPHONE AND FIBER OPTIC LINES, SITE LIGHTING ELECTRIC, SECONDARY ELECTRIC, PRIMARY ELECTRICAL, DUCTBANK IRRIGATION FACILITIES, AND GAS LINES. ANY UTILITY CONFLICTS THAT ARISE SHOULD BE COMMUNICATED TO THE ENGINEER IMMEDIATELY AND PRIOR TO CONSTRUCTION. THE CONTRACTOR SHALL CONTACT "TEXAS 811" A MINIMUM OF 48 HOURS PRIOR TO THE START OF CONSTRUCTION. ANY DAMAGE TO EXISTING UTILITIES SHALL BE THE SOLE RESPONSIBILITY OF THE CONTRACTOR AND THE REPAIR SHALL BE AT CONTRACTOR'S SOLE EXPENSE WHETHER THE UTILITY IS SHOWN ON THESE PLANS OR NOT.
- TRENCH EXCAVATION SAFETY PROTECTION:**  
CONTRACTOR AND/OR CONTRACTOR'S INDEPENDENTLY RETAINED EMPLOYEE OR SAFETY CONSULTANT SHALL BE RESPONSIBLE FOR THE DESIGN, IMPLEMENTATION, AND MAINTENANCE OF TRENCH EXCAVATION SAFETY PROTECTION SYSTEMS, PROGRAMS AND /OR PROCEDURES FOR THE PROJECT DESCRIBED IN THE CONTRACT DOCUMENTS. THE CONTRACTOR'S IMPLEMENTATION OF THESE SYSTEMS, PROGRAMS AND/OR PROCEDURES SHALL PROVIDE FOR ADEQUATE TRENCH EXCAVATION SAFETY PROTECTION THAT COMPLY WITH AS A MINIMUM, OSHA STANDARDS FOR TRENCH EXCAVATIONS. SPECIFICALLY, CONTRACTOR AND/OR CONTRACTOR'S INDEPENDENTLY RETAINED EMPLOYEE OR SAFETY CONSULTANT SHALL IMPLEMENT A TRENCH SAFETY PROGRAM IN ACCORDANCE WITH OSHA STANDARDS GOVERNING THE PRESENCE AND ACTIVITIES OF INDIVIDUALS WORKING IN AND AROUND TRENCH EXCAVATION.

DATE: \_\_\_\_\_

NO. REVISION: \_\_\_\_\_

11-20-2023

STATE OF TEXAS  
JOCELYN PEREZ  
98367  
PROFESSIONAL ENGINEER

**PAPE-DAWSON ENGINEERS**  
1672 INDEPENDENCE DR. STE 102 | NEW BRAUNFELS, TX 78132 | 800.632.5693  
TEXAS ENGINEERING FIRM #479 | TEXAS SURVEYING FIRM #1008900

**VERAMENDI PRECINCT 18 UNIT 1**  
NEW BRAUNFELS, TEXAS

**SANITARY SEWER LINE A - PLAN & PROFILE**  
STA 26+50.00 TO 36+00.00

JOB NO. 30001-66  
DATE 07-03-2023  
DESIGNER GDL  
CHECKED GDL DRAWN BH  
SHEET C5.09

Date: Nov 20, 2023, 1:53pm User ID: Dlynch  
File: P:\3001\01\66\Design\Chil\SSA-30001-66.dwg

**FOR PERMIT**



**CITY OF NEW BRAUNFELS NOTES**

- NO VALVES, HYDRANTS, ETC. SHALL BE CONSTRUCTED WITHIN CURBS, SIDEWALKS, OR DRIVEWAYS.
- ALL UTILITIES TO BE CONSTRUCTED PRIOR TO STREETS.
- THIS PROJECT INCLUDES UTILITY INSTALLATIONS GREATER THAN 5- FEET IN DEPTH. DEEP TRENCHES POSE COMPACTION TESTING AND CONSTRUCTION CHALLENGES AND CITY METHODS FOR TESTING AND COMPACTION MAY NOT BE ACHIEVABLE. A UTILITY COMPACTION PLAN WILL BE REQUIRED AND MUST BE SUBMITTED FOR APPROVAL TO CITY PRIOR TO UTILITY INSTALLATION.
- UTILITY TRENCH COMPACTION - ALL UTILITY TRENCH COMPACTION TESTS WITHIN THE STREET PAVEMENT/SIDEWALK SECTION SHALL BE THE RESPONSIBILITY OF THE DEVELOPER'S GEOTECHNICAL ENGINEER. FILL MATERIAL SHALL BE PLACED IN UNIFORM LAYERS NOT TO EXCEED TWELVE INCHES (12") LOOSE. DETERMINE THE MAXIMUM LIFT THICKNESS BASED ON THE ABILITY OF THE COMPACTING OPERATION AND EQUIPMENT USED TO MEET THE REQUIRED DENSITY. EACH LAYER OF MATERIAL SHALL BE COMPACTED TO A MINIMUM 95% DENSITY AND TESTED FOR DENSITY AND MOISTURE IN ACCORDANCE WITH TEST METHODS TEX-113-E, TEX-114-E, TEX-115-E. THE NUMBER AND LOCATION OF REQUIRED TESTS SHALL BE DETERMINED BY THE GEOTECHNICAL ENGINEER AND APPROVED BY THE CITY OF NEW BRAUNFELS STREET INSPECTOR. AT A MINIMUM, TESTS SHALL BE TAKEN EVERY 200 LF FOR EACH LIFT AND EVERY OTHER SERVICE LINE. UPON COMPLETION OF TESTING THE GEOTECHNICAL ENGINEER SHALL PROVIDE THE CITY OF NEW BRAUNFELS STREET INSPECTOR WITH ALL TESTING DOCUMENTATION AND A CERTIFICATION STATING THAT THE PLACEMENT OF FILL MATERIAL HAS BEEN COMPLETED IN ACCORDANCE WITH THE PLANS. ADDITIONAL DENSITY TESTS MAY BE REQUESTED BY THE CITY OF NEW BRAUNFELS INSPECTOR.

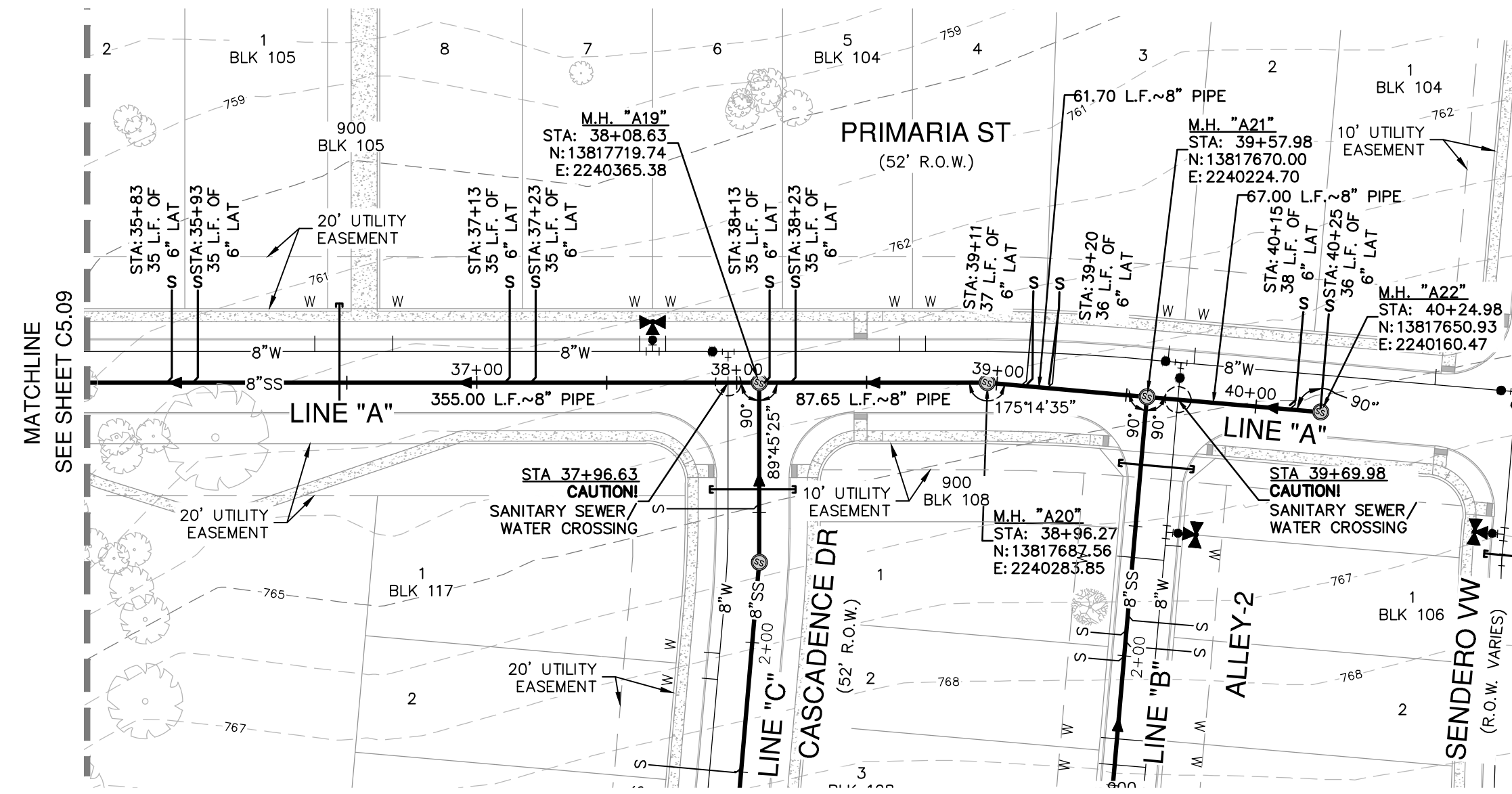
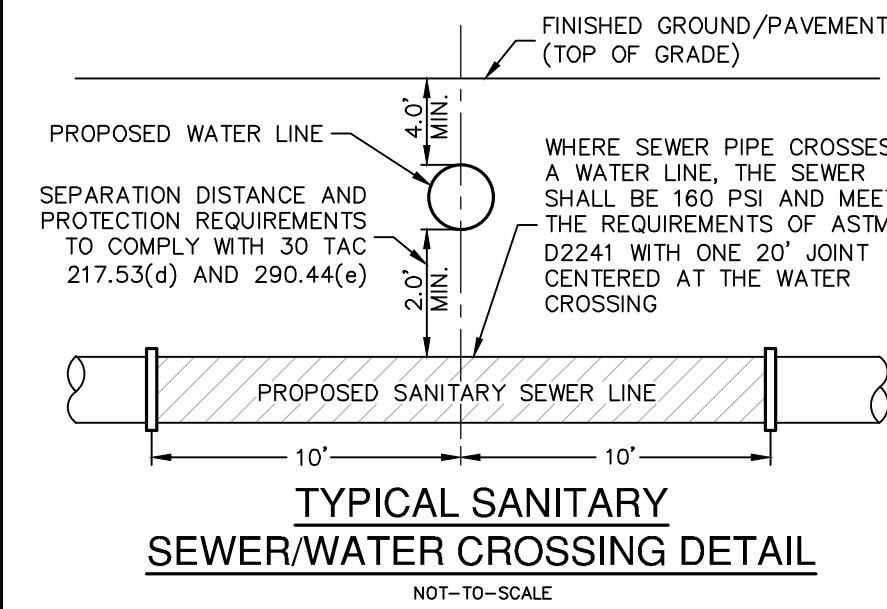

**SANITARY SEWER LINE "A"**  
STA 36+00.00 TO 40+24.98  
VERTICAL SCALE: 1" = 5'  
HORIZONTAL SCALE: 1" = 50'

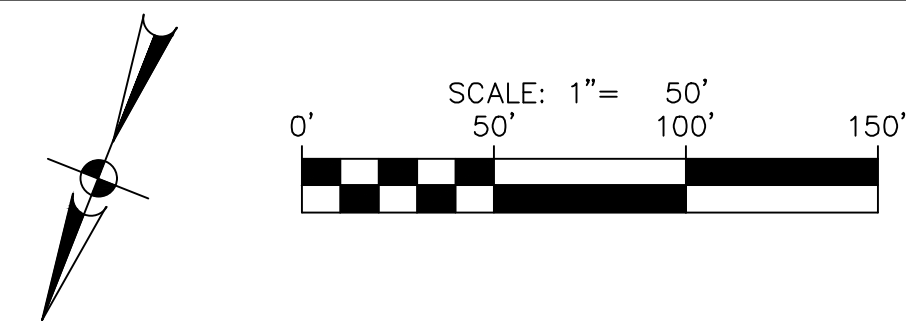
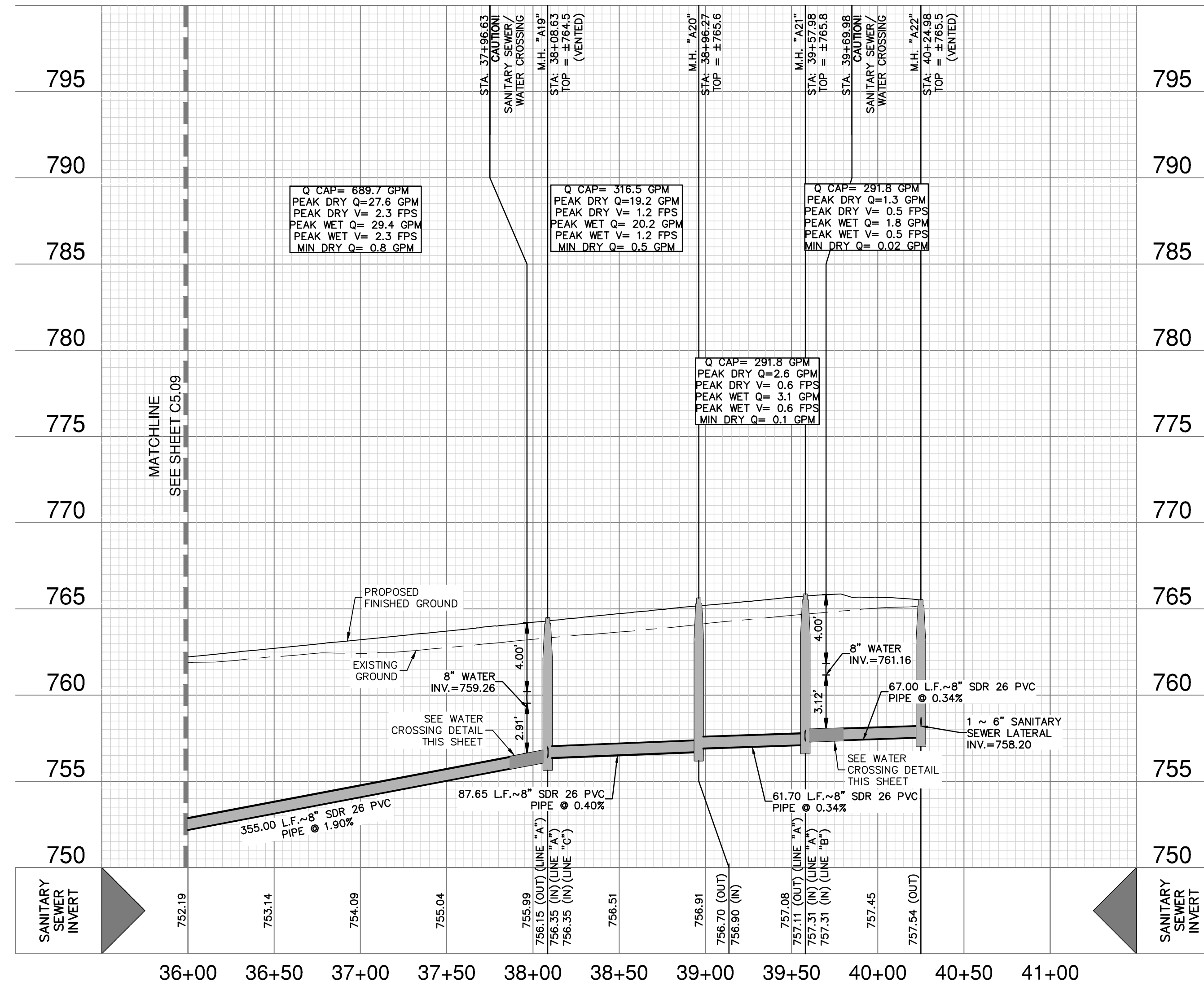

**SEWER LEGEND**

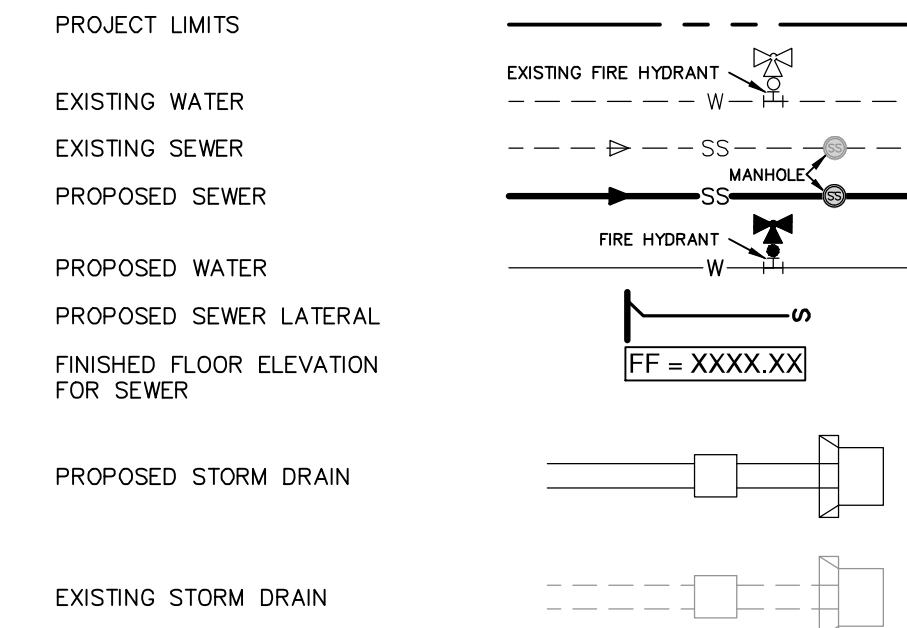

**NOTES**

- SEWER PIPE WHERE WATER LINE CROSSES SHALL BE 160 P.S.I. AND MEET THE REQUIREMENTS OF ASTM D2241 WITH ONE 20" JOINT CENTERED AT WATER MAIN.
- NO VERTICAL STACKS ALLOWED FOR ANY LOTS UNLESS OTHERWISE SPECIFIED BY THE ENGINEER.
- WHEN HORIZONTAL DISTANCE BETWEEN SEWER PIPES AND WATER MAIN IS LESS THAN 9 FEET OF SEPARATION, SEWER MAIN SHALL BE INSTALLED WITH 150 PSI (MIN) PRESSURE PIPE AND FITTINGS IN ACCORDANCE WITH NBU'S WATER CONNECTION POLICY IN THE VICINITY OF WATER MAINS. (SEE SEWER NOTES SHEET C5.30)
- CONTRACTOR SHALL ENSURE THAT MANHOLES OUTSIDE OF PAVED AREAS ARE SET WITH TOP ELEVATIONS 2" ABOVE FINISHED GRADE WITH CONCRETE RING ENCASUREMENT. CONTRACTOR SHALL ENSURE THAT MANHOLES IN PAVED AREAS ARE SET TO MATCH TOP OF FINISHED GRADE.
- ALL SEWER PIPES SHALL BE 8" PVC (SDR 26), UNLESS OTHERWISE NOTED.
- CONTRACTOR IS TO VERIFY EXISTING INVERT OF SANITARY SEWER MAIN AND ALERT ENGINEER IMMEDIATELY OF ANY DIFFERENCE FROM INVERT SHOWN ON PLANS.
- CONTRACTOR SHALL PROTECT ALL EXISTING FENCES. ANY FENCE DAMAGED BY THE CONTRACTOR SHALL BE REPAIRED BY THE CONTRACTOR AT THEIR EXPENSE.
- THE CONTRACTOR WILL BE RESPONSIBLE FOR DETERMINING EXACT LOCATION OF ALL UTILITIES AND DRAINAGE STRUCTURES WHETHER SHOWN ON THE PLANS OR NOT. THE CONTRACTOR SHALL UNCOVER EXISTING UTILITIES PRIOR TO CONSTRUCTION TO VERIFY SIZE, GRADE, AND LOCATION. THE CONTRACTOR SHALL NOTIFY THE ENGINEER IMMEDIATELY OF ANY DEVIATIONS FROM PLANS PRIOR TO BEGINNING CONSTRUCTION. ANY DAMAGE TO EXISTING UTILITIES, WHETHER SHOWN ON THE PLANS OR NOT, SHALL BE THE CONTRACTOR'S RESPONSIBILITY TO REPAIR, AT HIS EXPENSE.
- SEE THIS SHEET FOR TYPICAL SANITARY SEWER/WATER CROSSING DETAIL.
- IF A CONFLICT EXISTS BETWEEN THE VARIOUS SUBMITTED DOCUMENTS (ENGINEERING CALCULATIONS, PROJECTED SPECIFICATIONS, PROJECTED PLANS, ADDENDUMS, ETC.), THE FOLLOWING DOCUMENTS TAKE PRECEDENCE: SPECIFICATIONS GOVERN OVER PLANS, SPECIAL CONDITIONS GOVERN OVER SPECIFICATIONS AND PLANS. ADDENDUMS TAKE PRECEDENCE OVER ALL.
- LAST 20 LF. OF 8" STUB-OUT SHALL BE CONSTRUCTED OF P.V.C. SDR 26 (160 P.S.I.) PRESSURE PIPE.
- ALL SEWER PIPE LATERALS SHALL BE SDR 26 (CLASS 160) PVC PIPE AND SHALL HAVE A MINIMUM SLOPE OF 2%.
- WASTEWATER LATERALS SHALL BE LAID WITH A MINIMUM OF 36 INCHES OF COVER.
- NEW MANHOLES MUST BE CONSTRUCTED OF OR LINED WITH A CORROSION RESISTANT MATERIAL. WHERE NEW CONSTRUCTION CONNECTS TO AN EXISTING MANHOLE THAT IS NOT CONSTRUCTED OF A CORROSION RESISTANT MATERIAL, THE EXISTING MANHOLE MUST BE LINED WITH OR REPLACED WITH A CORROSION RESISTANT MATERIAL.
- 48" MANHOLES ARE REQUIRED FOR ALL MAINS UP TO 18" IN DIAMETER.

**NOTE:**  
FOR PAVEMENT DESIGN SECTION SEE GEOTECHNICAL ENGINEERING REPORT.

**FLOODPLAIN NOTE**

- NO PORTION OF ANY LOT ON THIS PROJECT IS WITHIN AN INDICATED SPECIAL HAZARD ZONE ACCORDING TO THE FEMA FIRM MAP NO. 48187C0095F EFFECTIVE DATE 9/2/2009.

**CAUTION!!**

CONTRACTOR SHALL BE REQUIRED TO LOCATE ALL PUBLIC OR PRIVATE UTILITIES INCLUDING BUT NOT LIMITING TO: WATER, SEWER, TELEPHONE AND FIBER OPTIC LINES, SITE LIGHTING ELECTRIC, SECONDARY ELECTRIC, PRIMARY ELECTRICAL, DUCTS, IRRIGATION FACILITIES, AND GAS LINES. ANY UTILITY CONFLICTS THAT ARISE SHOULD BE COMMUNICATED TO THE ENGINEER IMMEDIATELY AND PRIOR TO CONSTRUCTION. THE CONTRACTOR SHALL CONTACT "TEXAS 811" A MINIMUM OF 48 HOURS PRIOR TO THE START OF CONSTRUCTION. ANY DAMAGE TO EXISTING UTILITIES SHALL BE THE SOLE RESPONSIBILITY OF THE CONTRACTOR AND THE REPAIR SHALL BE AT CONTRACTOR'S SOLE EXPENSE WHETHER THE UTILITY IS SHOWN ON THESE PLANS OR NOT.

**TRENCH EXCAVATION SAFETY PROTECTION:**

CONTRACTOR AND/OR CONTRACTOR'S INDEPENDENTLY RETAINED EMPLOYEE OR STRUCTURAL DESIGN/ GEOTECHNICAL/ SAFETY/EQUIPMENT CONSULTANT, IF ANY, SHALL REVIEW THESE PLANS AND ANY AVAILABLE GEOTECHNICAL INFORMATION AND THE ANTICIPATED INSTALLATION SITES WITHIN THE PROJECT WORK AREA IN ORDER TO IMPLEMENT CONTRACTOR'S TRENCH EXCAVATION SAFETY PROTECTION SYSTEMS, PROGRAMS AND /OR PROCEDURES FOR THE PROJECT DESCRIBED IN THE CONTRACT DOCUMENTS. THE CONTRACTOR'S IMPLEMENTATION OF THESE SYSTEMS, PROGRAMS AND/OR PROCEDURES SHALL PROVIDE FOR ADEQUATE TRENCH EXCAVATION SAFETY PROTECTION THAT COMPLY WITH AS A MINIMUM, OSHA STANDARDS FOR TRENCH EXCAVATIONS. SPECIFICALLY, CONTRACTOR AND/OR CONTRACTOR'S INDEPENDENTLY RETAINED EMPLOYEE OR SAFETY CONSULTANT SHALL IMPLEMENT A TRENCH SAFETY PROGRAM IN ACCORDANCE WITH OSHA STANDARDS GOVERNING THE PRESENCE AND ACTIVITIES OF INDIVIDUALS WORKING IN AND AROUND TRENCH EXCAVATION.

NO.	REVISION	DATE

**PAPE-DAWSON ENGINEERS**  
1672 INDEPENDENCE DR, STE 102 | NEW BRAUNFELS, TX 78132 | 800.632.5633  
TEXAS ENGINEERING FIRM #470 | TEXAS SURVEYING FIRM #10088800

**VERAMENDI PRECINCT 18 UNIT 1**  
NEW BRAUNFELS, TEXAS  
**SANITARY SEWER LINE A - PLAN & PROFILE**  
STA 36+00.00 TO 40+24.98

JOB NO.	30001-66
DATE	07-03-2023
DESIGNER	GDL
CHECKED	DL
DRAWN	BH
SHEET	C5.10

Date: Jun 29, 2023, 11:55am User ID: cprocher  
File: P:\3001\01\Gis\Design\Chal\SSA-30001-66.dwg



**CITY OF NEW BRAUNFELS NOTES**

- NO VALVES, HYDRANTS, ETC. SHALL BE CONSTRUCTED WITHIN CURBS, SIDEWALKS, OR DRIVEWAYS.
- ALL UTILITIES TO BE CONSTRUCTED PRIOR TO STREETS.
- THIS PROJECT INCLUDES UTILITY INSTALLATIONS GREATER THAN 5- FEET IN DEPTH. DEEP TRENCHES POSE COMPACTION TESTING AND CONSTRUCTION CHALLENGES AND CITY METHODS FOR TESTING AND COMPACTION MAY NOT BE ACHIEVABLE. A UTILITY COMPACTION PLAN WILL BE REQUIRED AND MUST BE SUBMITTED FOR APPROVAL TO CITY PRIOR TO UTILITY INSTALLATION.
- UTILITY TRENCH COMPACTION - ALL UTILITY TRENCH COMPACTION TESTS WITHIN THE STREET PAVEMENT/SIDEWALK SECTION SHALL BE THE RESPONSIBILITY OF THE DEVELOPER'S GEOTECHNICAL ENGINEER. FILL MATERIAL SHALL BE PLACED IN UNIFORM LAYERS NOT TO EXCEED TWELVE INCHES (12") LOOSE. DETERMINE THE MAXIMUM LIFT THICKNESS BASED ON THE ABILITY OF THE COMPACTING OPERATION AND EQUIPMENT USED TO MEET THE REQUIRED DENSITY. EACH LAYER OF MATERIAL SHALL BE COMPACTED TO A MINIMUM 95% DENSITY AND TESTED FOR DENSITY AND MOISTURE IN ACCORDANCE WITH TEST METHODS TEX-113-E, TEX-114-E, TEX-115-E. THE NUMBER AND LOCATION OF REQUIRED TESTS SHALL BE DETERMINED BY THE GEOTECHNICAL ENGINEER AND APPROVED BY THE CITY OF NEW BRAUNFELS STREET INSPECTOR. AT A MINIMUM, TESTS SHALL BE TAKEN EVERY 200 LF FOR EACH LIFT AND EVERY OTHER SERVICE LINE. UPON COMPLETION OF TESTING THE GEOTECHNICAL ENGINEER SHALL PROVIDE THE CITY OF NEW BRAUNFELS STREET INSPECTOR WITH ALL TESTING DOCUMENTATION AND A CERTIFICATION STATING THAT THE PLACEMENT OF FILL MATERIAL HAS BEEN COMPLETED IN ACCORDANCE WITH THE PLANS. ADDITIONAL DENSITY TESTS MAY BE REQUESTED BY THE CITY OF NEW BRAUNFELS INSPECTOR.

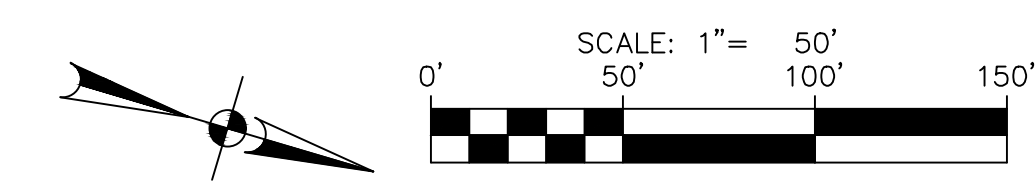
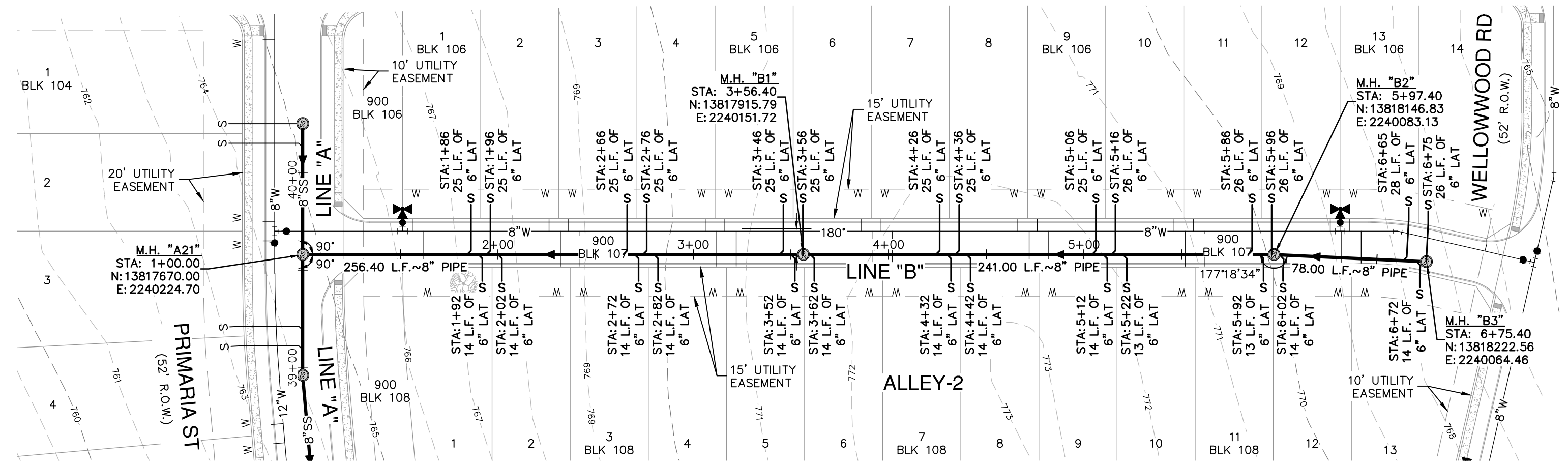
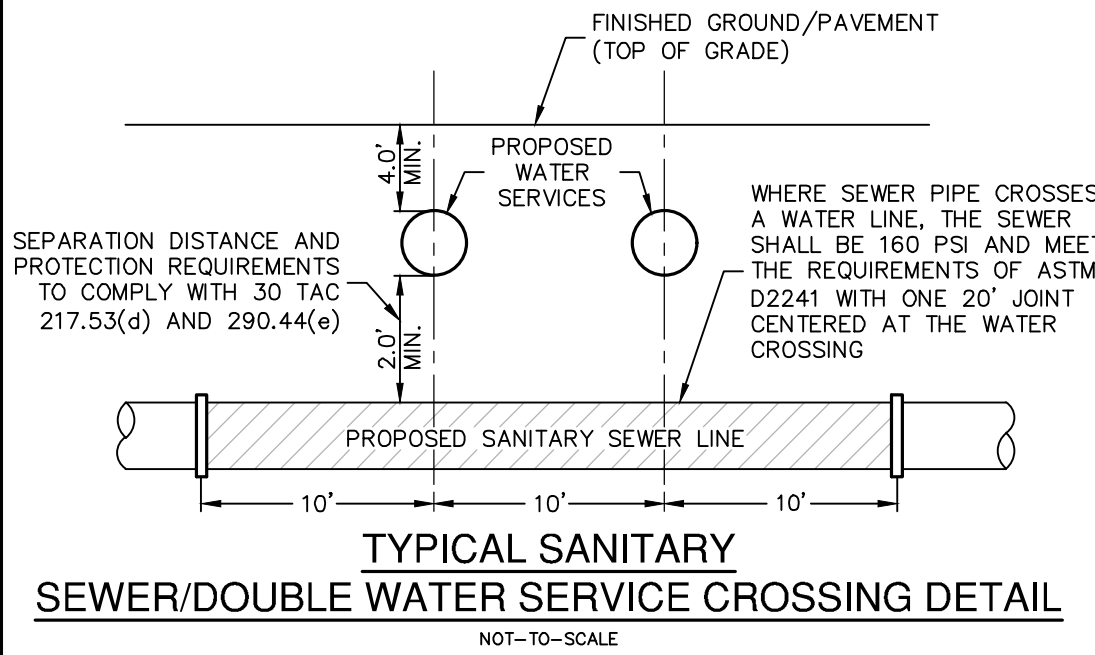

**SEWER LEGEND**

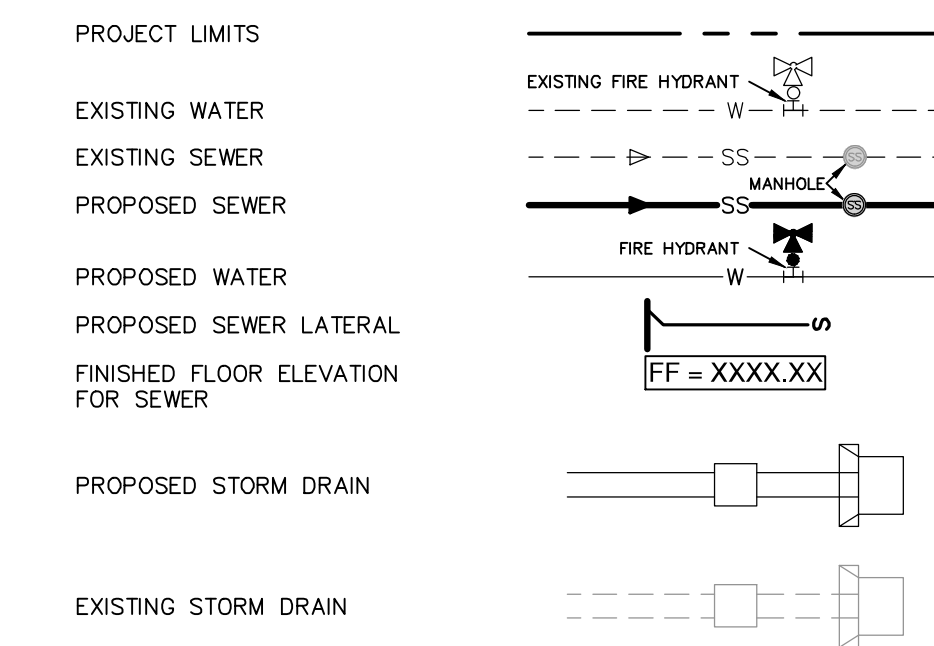

**NOTES**

- SEWER PIPE WHERE WATER LINE CROSSES SHALL BE 160 P.S.I. AND MEET THE REQUIREMENTS OF ASTM D2241 WITH ONE 20" JOINT CENTERED AT WATER MAIN.
- NO VERTICAL STACKS ALLOWED FOR ANY LOTS UNLESS OTHERWISE SPECIFIED BY THE ENGINEER.
- WHEN HORIZONTAL DISTANCE BETWEEN SEWER PIPES AND WATER MAIN IS LESS THAN 9 FEET OF SEPARATION, SEWER MAIN SHALL BE INSTALLED WITH 150 PSI (MIN) PRESSURE PIPE AND FITTINGS IN ACCORDANCE WITH NBU'S WATER CONNECTION POLICY IN THE VICINITY OF WATER MAINS. (SEE SEWER NOTES SHEET C5.30)
- CONTRACTOR SHALL ENSURE THAT MANHOLES OUTSIDE OF PAVED AREAS ARE SET WITH TOP ELEVATIONS 2" ABOVE FINISHED GRADE WITH CONCRETE RING ENCASUREMENT. CONTRACTOR SHALL ENSURE THAT MANHOLES IN PAVED AREAS ARE SET TO MATCH TOP OF FINISHED GRADE.
- ALL SEWER PIPES SHALL BE 8" PVC (SDR 26), UNLESS OTHERWISE NOTED.
- CONTRACTOR IS TO VERIFY EXISTING INVERT OF SANITARY SEWER MAIN AND ALERT ENGINEER IMMEDIATELY OF ANY DIFFERENCE FROM INVERT SHOWN ON PLANS.
- CONTRACTOR SHALL PROTECT ALL EXISTING FENCES. ANY FENCE DAMAGED BY THE CONTRACTOR SHALL BE REPAIRED BY THE CONTRACTOR AT THEIR EXPENSE.
- THE CONTRACTOR WILL BE RESPONSIBLE FOR DETERMINING EXACT LOCATION OF ALL UTILITIES AND DRAINAGE STRUCTURES WHETHER SHOWN ON THE PLANS OR NOT. THE CONTRACTOR SHALL UNCOVER EXISTING UTILITIES PRIOR TO CONSTRUCTION TO VERIFY SIZE, GRADE, AND LOCATION. THE CONTRACTOR SHALL NOTIFY THE ENGINEER IMMEDIATELY OF ANY DEVIATIONS FROM PLANS PRIOR TO BEGINNING CONSTRUCTION. ANY DAMAGE TO EXISTING UTILITIES, WHETHER SHOWN ON THE PLANS OR NOT, SHALL BE THE CONTRACTOR'S RESPONSIBILITY TO REPAIR, AT HIS EXPENSE.
- SEE THIS SHEET FOR TYPICAL SANITARY SEWER/WATER CROSSING DETAIL.
- IF A CONFLICT EXISTS BETWEEN THE VARIOUS SUBMITTED DOCUMENTS (ENGINEERING CALCULATIONS, PROJECTED SPECIFICATIONS, PROJECTED PLANS, ADDENDUMS, ETC.), THE FOLLOWING DOCUMENTS TAKE PRECEDENCE: SPECIFICATIONS GOVERN OVER PLANS, SPECIAL CONDITIONS GOVERN OVER SPECIFICATIONS AND PLANS. ADDENDUMS TAKE PRECEDENCE OVER ALL.
- LAST 20 L.F. OF 8" STUB-OUT SHALL BE CONSTRUCTED OF P.V.C. SDR 26 (160 P.S.I.) PRESSURE PIPE.
- ALL SEWER PIPE LATERALS SHALL BE SDR 26 (CLASS 160) PVC PIPE AND SHALL HAVE A MINIMUM SLOPE OF 2%.
- WASTEWATER LATERALS SHALL BE LAID WITH A MINIMUM OF 36 INCHES OF COVER.
- NEW MANHOLES MUST BE CONSTRUCTED OF OR LINED WITH A CORROSION RESISTANT MATERIAL WHERE NEW CONSTRUCTION CONNECTS TO AN EXISTING MANHOLE THAT IS NOT CONSTRUCTED OF A CORROSION RESISTANT MATERIAL. EXISTING MANHOLE MUST BE LINED WITH OR REPLACED WITH A CORROSION RESISTANT MATERIAL.
- 48" MANHOLES ARE REQUIRED FOR ALL MAINS UP TO 18" IN DIAMETER.

**FLOODPLAIN NOTE**

- NO PORTION OF ANY LOT ON THIS PROJECT IS WITHIN AN INDICATED SPECIAL FLOOD HAZARD ZONE ACCORDING TO THE FEMA FIRM MAP NO. 48187C0095F EFFECTIVE DATE 9/2/2009.

**CAUTION!!**

CONTRACTOR SHALL BE REQUIRED TO LOCATE ALL PUBLIC OR PRIVATE UTILITIES INCLUDING BUT NOT LIMITING TO: WATER, SEWER, TELEPHONE AND FIBER OPTIC LINES, SITE LIGHTING ELECTRIC, SECONDARY ELECTRIC, PRIMARY ELECTRICAL DUCTS, LANDSCAPE IRRIGATION FACILITIES, AND GAS LINES. ANY UTILITY CONFLICTS THAT ARISE SHOULD BE COMMUNICATED TO THE ENGINEER IMMEDIATELY AND PRIOR TO CONSTRUCTION. THE CONTRACTOR SHALL CONTACT "TEXAS 811" A MINIMUM OF 48 HOURS PRIOR TO THE START OF CONSTRUCTION. ANY DAMAGE TO EXISTING UTILITIES SHALL BE THE SOLE RESPONSIBILITY OF THE CONTRACTOR AND THE REPAIR SHALL BE AT CONTRACTOR'S SOLE EXPENSE WHETHER THE UTILITY IS SHOWN ON THESE PLANS OR NOT.

**TRENCH EXCAVATION SAFETY PROTECTION:**

CONTRACTOR AND/OR CONTRACTOR'S INDEPENDENTLY RETAINED EMPLOYEE OR STRUCTURAL DESIGN/ GEOTECHNICAL/ SAFETY/EQUIPMENT CONSULTANT, IF ANY, SHALL REVIEW THESE PLANS AND ANY AVAILABLE GEOTECHNICAL INFORMATION AND THE ANTICIPATED INSTALLATION SITES WITHIN THE PROJECT WORK AREA IN ORDER TO IMPLEMENT CONTRACTOR'S TRENCH EXCAVATION SAFETY PROTECTION SYSTEMS, PROGRAMS AND /OR PROCEDURES FOR THE PROJECT DESCRIBED IN THE CONTRACT DOCUMENTS. THE CONTRACTOR'S IMPLEMENTATION OF THESE SYSTEMS, PROGRAMS AND/OR PROCEDURES SHALL PROVIDE FOR ADEQUATE TRENCH EXCAVATION SAFETY PROTECTION THAT COMPLY WITH AS A MINIMUM, OSHA STANDARDS FOR TRENCH EXCAVATIONS. SPECIFICALLY, CONTRACTOR AND/OR CONTRACTOR'S INDEPENDENTLY RETAINED EMPLOYEE OR SAFETY CONSULTANT SHALL IMPLEMENT A TRENCH SAFETY PROGRAM IN ACCORDANCE WITH OSHA STANDARDS GOVERNING THE PRESENCE AND ACTIVITIES OF INDIVIDUALS WORKING IN AND AROUND TRENCH EXCAVATION.

**SANITARY SEWER LINE "B" STA 1+00.00 TO 6+75.40**  
**VERTICAL SCALE: 1" = 5'**  
**HORIZONTAL SCALE: 1" = 50'**

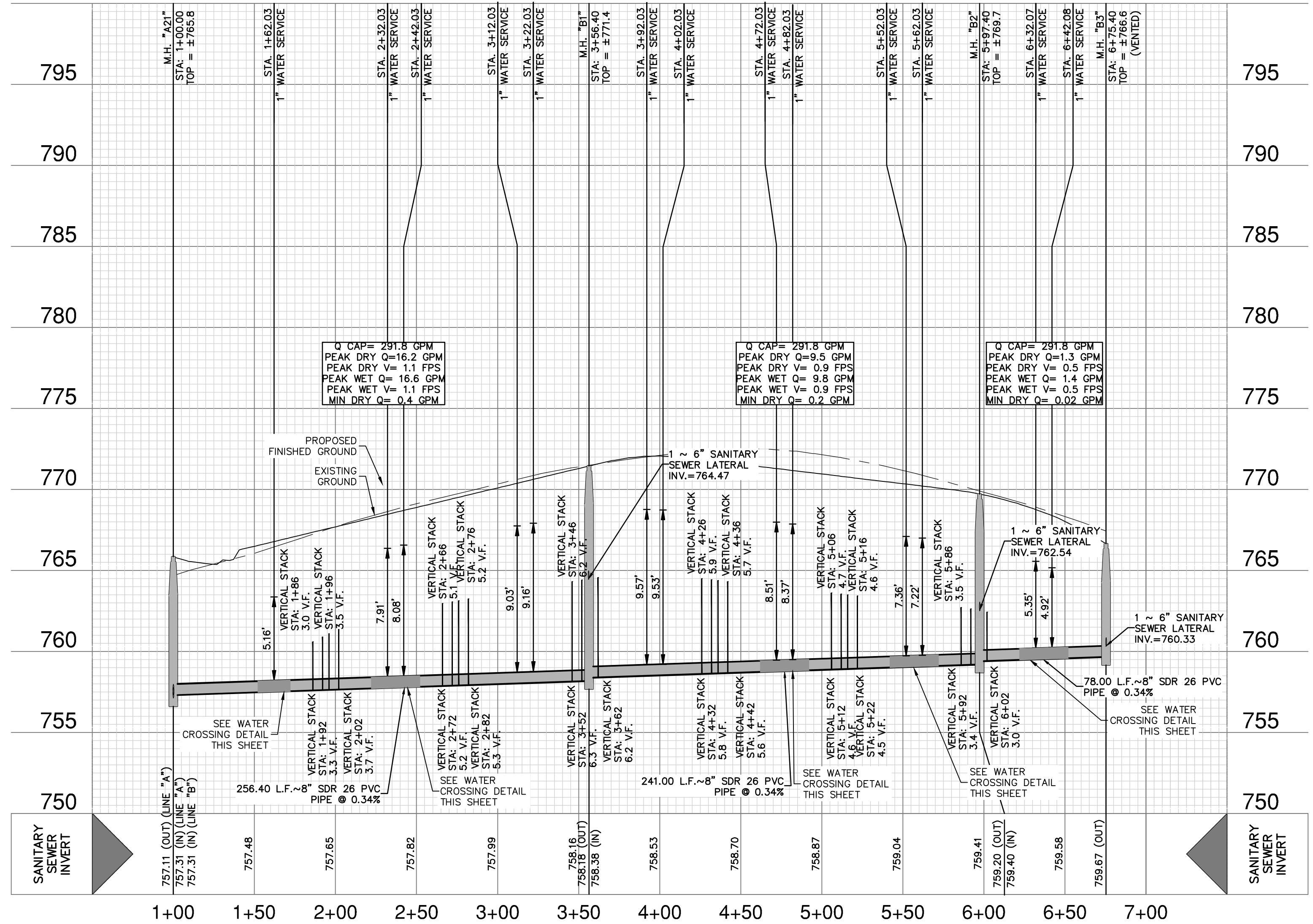

DATE: \_\_\_\_\_

NO. REVISION: \_\_\_\_\_

11-21-2023

Jocelyn Perez  
Professional Engineer

**PAPE-DAWSON ENGINEERS**

1672 INDEPENDENCE DR. STE 102 | NEW BRAUNFELS, TX 78132 | 800.632.5633  
 TEXAS SURVEYING FIRM #1008800

**VERAMENDI PRECINCT 18 UNIT 1**  
 NEW BRAUNFELS, TEXAS

**SANITARY SEWER LINE B - PLAN & PROFILE**  
 STA 1+00.00 TO 6+75.40

JOB NO. 30001-66  
 DATE 07-03-2023  
 DESIGNER GDL  
 CHECKED [initials] DRAWN BH  
 SHEET C5.11







**CITY OF NEW BRAUNFELS NOTES**

- NO VALVES, HYDRANTS, ETC. SHALL BE CONSTRUCTED WITHIN CURBS, SIDEWALKS, OR DRIVEWAYS.
- ALL UTILITIES TO BE CONSTRUCTED PRIOR TO STREETS.
- THIS PROJECT INCLUDES UTILITY INSTALLATIONS GREATER THAN 5- FEET IN DEPTH. DEEP TRENCHES POSE COMPACTION TESTING AND CONSTRUCTION CHALLENGES AND CITY METHODS FOR TESTING AND COMPACTION MAY NOT BE ACHIEVABLE. A UTILITY COMPACTION PLAN WILL BE REQUIRED AND MUST BE SUBMITTED FOR APPROVAL TO CITY PRIOR TO UTILITY INSTALLATION.
- UTILITY TRENCH COMPACTION - ALL UTILITY TRENCH COMPACTION TESTS WITHIN THE STREET PAVEMENT/SIDEWALK SECTION SHALL BE THE RESPONSIBILITY OF THE DEVELOPER'S GEOTECHNICAL ENGINEER. FILL MATERIAL SHALL BE PLACED IN UNIFORM LAYERS NOT TO EXCEED TWELVE INCHES (12") LOOSE. DETERMINE THE MAXIMUM LIFT THICKNESS BASED ON THE ABILITY OF THE COMPACTION OPERATION AND EQUIPMENT USED TO MEET THE REQUIRED DENSITY. EACH LAYER OF MATERIAL SHALL BE COMPACTED TO A MINIMUM 95% DENSITY AND TESTED FOR DENSITY AND MOISTURE IN ACCORDANCE WITH TEST METHODS TEX-113-E, TEX-114-E, TEX-115-E. THE NUMBER AND LOCATION OF REQUIRED TESTS SHALL BE DETERMINED BY THE GEOTECHNICAL ENGINEER AND APPROVED BY THE CITY OF NEW BRAUNFELS STREET INSPECTOR. AT A MINIMUM, TESTS SHALL BE TAKEN EVERY 200 LF FOR EACH LIFT AND EVERY OTHER SERVICE LINE. UPON COMPLETION OF TESTING THE GEOTECHNICAL ENGINEER SHALL PROVIDE THE CITY OF NEW BRAUNFELS STREET INSPECTOR WITH ALL TESTING DOCUMENTATION AND A CERTIFICATION STATING THAT THE PLACEMENT OF FILL MATERIAL HAS BEEN COMPLETED IN ACCORDANCE WITH THE PLANS. ADDITIONAL DENSITY TESTS MAY BE REQUESTED BY THE CITY OF NEW BRAUNFELS INSPECTOR.

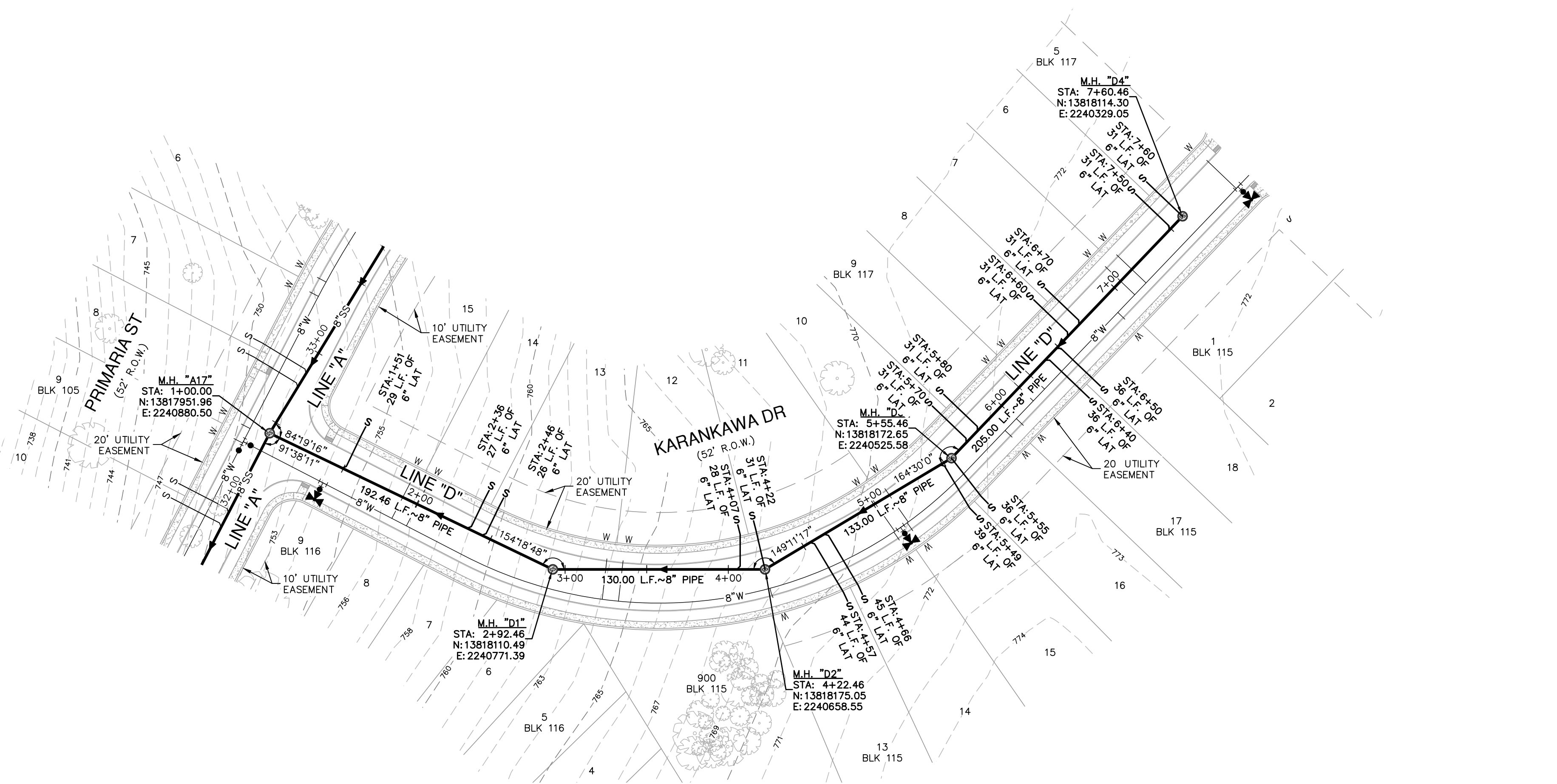
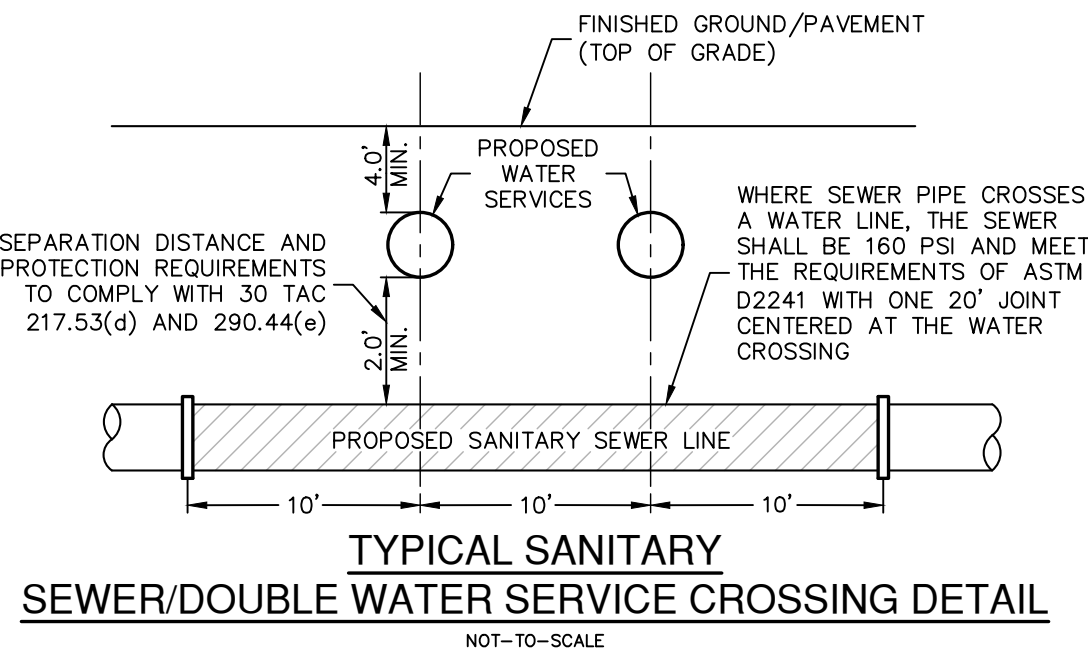

**SANITARY SEWER LINE "D"**  
STA 1+00.00 TO 7+60.46  
VERTICAL SCALE: 1" = 5'  
HORIZONTAL SCALE: 1" = 50'

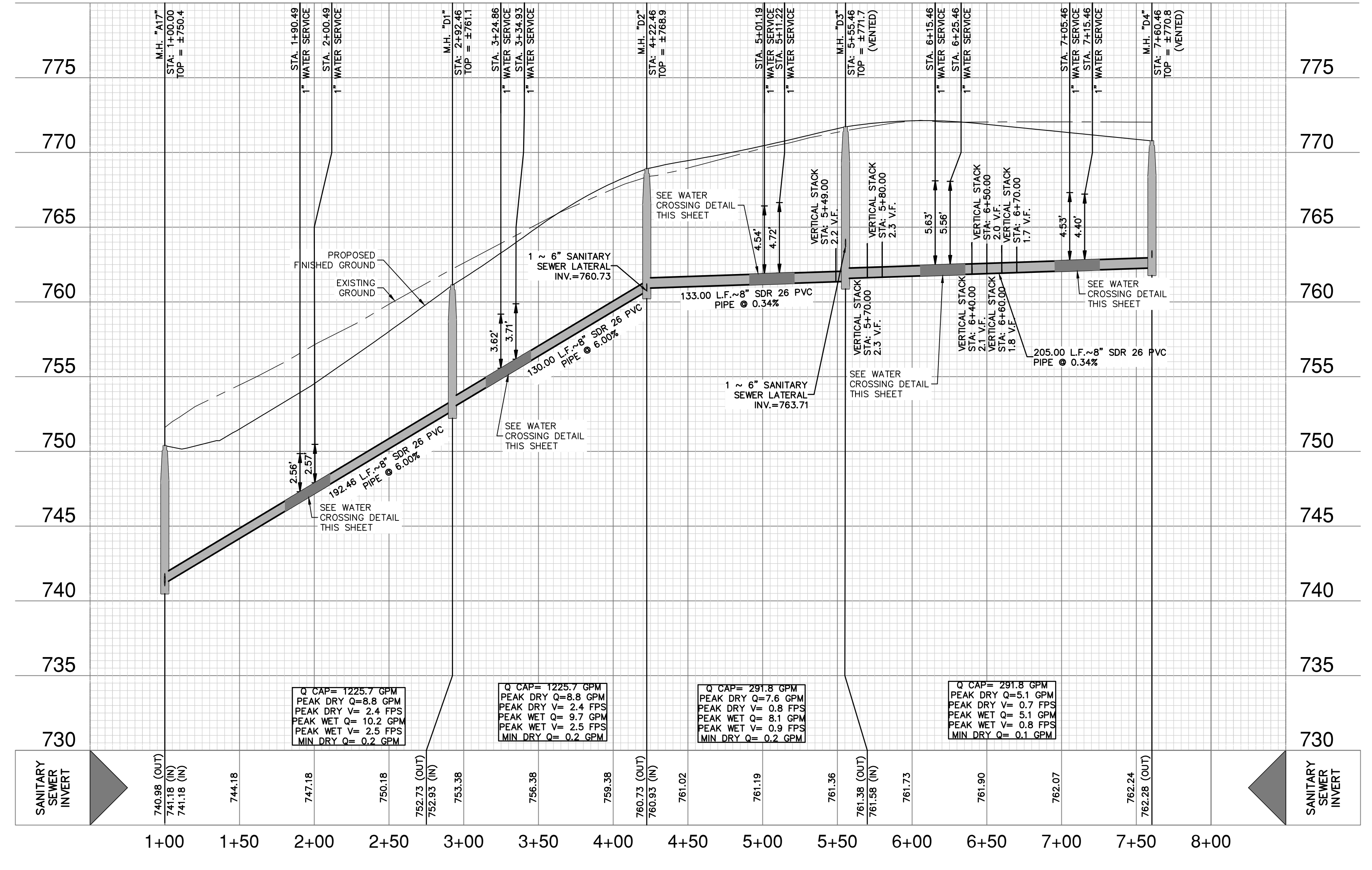

Q CAP = 1225.7 GPM PEAK DRY Q = 8.8 GPM PEAK DRY V = 2.4 FPS PEAK WET Q = 10.2 GPM PEAK WET V = 2.5 FPS MIN DRY Q = 0.2 GPM	Q CAP = 1225.7 GPM PEAK DRY Q = 8.8 GPM PEAK DRY V = 2.4 FPS PEAK WET Q = 9.7 GPM PEAK WET V = 2.5 FPS MIN DRY Q = 0.2 GPM	Q CAP = 291.8 GPM PEAK DRY Q = 7.8 GPM PEAK DRY V = 0.8 FPS PEAK WET Q = 8.1 GPM PEAK WET V = 0.9 FPS MIN DRY Q = 0.2 GPM	Q CAP = 291.8 GPM PEAK DRY Q = 5.1 GPM PEAK DRY V = 0.7 FPS PEAK WET Q = 5.1 GPM PEAK WET V = 0.8 FPS MIN DRY Q = 0.1 GPM
--	---	--	--

**SEWER LEGEND**

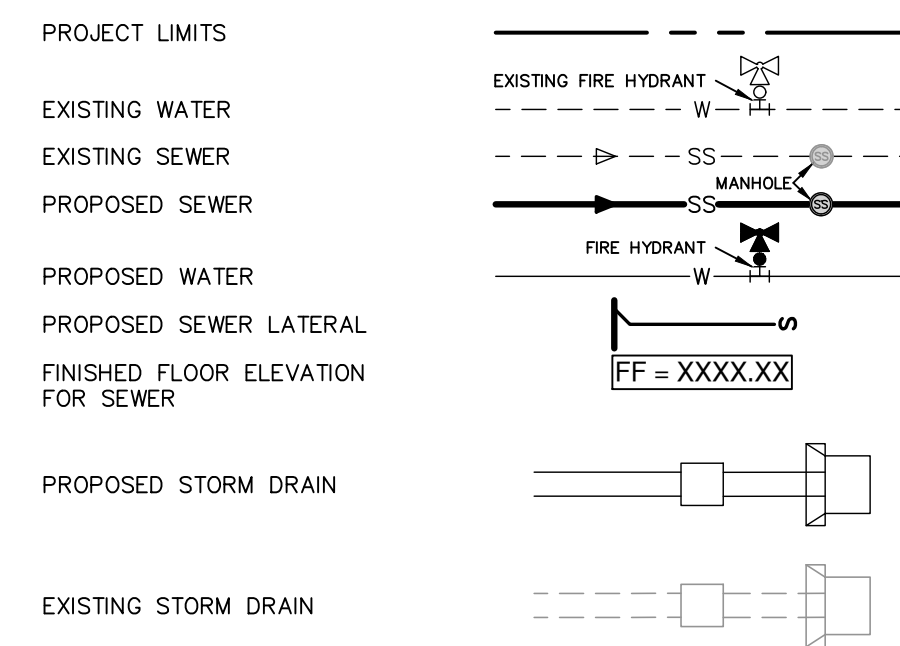

**NOTES**

- SEWER PIPE WHERE WATER LINE CROSSES SHALL BE 160 P.S.I. AND MEET THE REQUIREMENTS OF ASTM D2241 WITH ONE 20' JOINT CENTERED AT WATER MAIN.
- NO VERTICAL STACKS ALLOWED FOR ANY LOTS UNLESS OTHERWISE SPECIFIED BY THE ENGINEER.
- WHEN HORIZONTAL DISTANCE BETWEEN SEWER PIPES AND WATER MAIN IS LESS THAN 9 FOOT OF SEPARATION, SEWER MAIN SHALL BE INSTALLED WITH 150 PSI (MIN) PRESSURE PIPE AND FITTINGS IN ACCORDANCE WITH NBU'S WATER CONNECTION POLICY IN THE VICINITY OF WATER MAINS. (SEE SEWER NOTES SHEET C5.30)
- CONTRACTOR SHALL ENSURE THAT MANHOLES OUTSIDE OF PAVED AREAS ARE SET WITH TOP ELEVATIONS 2" ABOVE FINISHED GRADE WITH CONCRETE RING ENCASUREMENT. CONTRACTOR SHALL ENSURE THAT MANHOLES IN PAVED AREAS ARE SET TO MATCH TOP OF FINISHED GRADE.
- ALL SEWER PIPES SHALL BE 8" PVC (SDR 26), UNLESS OTHERWISE NOTED.
- CONTRACTOR IS TO VERIFY EXISTING INVERT OF SANITARY SEWER MAIN AND ALERT ENGINEER IMMEDIATELY OF ANY DIFFERENCE FROM INVERT SHOWN ON PLANS.
- CONTRACTOR SHALL PROTECT ALL EXISTING FENCES. ANY FENCE DAMAGED BY THE CONTRACTOR SHALL BE REPAIRED BY THE CONTRACTOR AT THEIR EXPENSE.
- THE CONTRACTOR WILL BE RESPONSIBLE FOR DETERMINING EXACT LOCATION OF ALL UTILITIES AND DRAINAGE STRUCTURES WHETHER SHOWN ON THE PLANS OR NOT. THE CONTRACTOR SHALL UNCOVER EXISTING UTILITIES PRIOR TO CONSTRUCTION TO VERIFY SIZE, GRADE, AND LOCATION. THE CONTRACTOR SHALL NOTIFY THE ENGINEER IMMEDIATELY OF ANY DEVIATIONS FROM PLANS PRIOR TO BEGINNING CONSTRUCTION. ANY DAMAGE TO EXISTING UTILITIES, WHETHER SHOWN ON THE PLANS OR NOT, SHALL BE THE CONTRACTOR'S RESPONSIBILITY TO REPAIR, AT HIS EXPENSE.
- SEE THIS SHEET FOR TYPICAL SANITARY SEWER/WATER CROSSING DETAIL.
- IF A CONFLICT EXISTS BETWEEN THE VARIOUS SUBMITTED DOCUMENTS (ENGINEERING CALCULATIONS, PROJECTED SPECIFICATIONS, PROJECTED PLANS, ADDENDUMS, ETC.), THE FOLLOWING DOCUMENTS TAKE PRECEDENCE: SPECIFICATIONS GOVERN OVER PLANS, SPECIAL CONDITIONS GOVERN OVER SPECIFICATIONS AND PLANS. ADDENDUMS TAKE PRECEDENCE OVER ALL.
- LAST 20 LF. OF 8" STUB-OUT SHALL BE CONSTRUCTED OF P.V.C. SDR 26 (160 P.S.I.) PRESSURE PIPE.
- ALL SEWER PIPE LATERALS SHALL BE SDR 26 (CLASS 160) PVC PIPE AND SHALL HAVE A MINIMUM SLOPE OF 2%.
- WASTEWATER LATERALS SHALL BE LAID WITH A MINIMUM OF 36 INCHES OF COVER.
- NEW MANHOLES MUST BE CONSTRUCTED OF OR LINED WITH A CORROSION RESISTANT MATERIAL. WHERE NEW CONSTRUCTION CONNECTS TO AN EXISTING MANHOLE THAT IS NOT CONSTRUCTED OF A CORROSION RESISTANT MATERIAL THE EXISTING MANHOLE MUST BE LINED WITH OR REPLACED WITH A CORROSION RESISTANT MATERIAL.
- 48" MANHOLES ARE REQUIRED FOR ALL MAINS UP TO 18" IN DIAMETER.

**NOTE:**  
FOR PAVEMENT DESIGN SECTION SEE GEOTECHNICAL ENGINEERING REPORT.

**FLOODPLAIN NOTE**

- NO PORTION OF ANY LOT ON THIS PROJECT IS WITHIN AN INDICATED SPECIAL FLOOD HAZARD ZONE ACCORDING TO THE FEMA FIRM MAP NO. 48187C0095F EFFECTIVE DATE 9/2/2009.

**CAUTION!!**

CONTRACTOR SHALL BE REQUIRED TO LOCATE ALL PUBLIC OR PRIVATE UTILITIES INCLUDING BUT NOT LIMITING TO: WATER, SEWER, TELEPHONE AND FIBER OPTIC LINES, SITE LIGHTING ELECTRIC, SECONDARY ELECTRIC, PRIMARY ELECTRICAL DUCTBANKS, LANDSCAPE IRRIGATION FACILITIES, AND GAS LINES. ANY UTILITY CONFLICTS THAT ARISE SHOULD BE COMMUNICATED TO THE ENGINEER IMMEDIATELY AND PRIOR TO CONSTRUCTION. THE CONTRACTOR SHALL CONTACT "TEXAS 811" A MINIMUM OF 48 HOURS PRIOR TO THE START OF CONSTRUCTION. ANY DAMAGE TO EXISTING UTILITIES SHALL BE THE SOLE RESPONSIBILITY OF THE CONTRACTOR AND THE REPAIR SHALL BE AT CONTRACTOR'S SOLE EXPENSE WHETHER THE UTILITY IS SHOWN ON THESE PLANS OR NOT.

**TRENCH EXCAVATION SAFETY PROTECTION:**

CONTRACTOR AND/OR CONTRACTOR'S INDEPENDENTLY RETAINED EMPLOYEE OR STRUCTURAL DESIGN/ GEOTECHNICAL/ SAFETY/EQUIPMENT CONSULTANT, IF ANY, SHALL REVIEW THESE PLANS AND ANY AVAILABLE GEOTECHNICAL INFORMATION AND THE ANTICIPATED INSTALLATION SITES WITHIN THE PROJECT WORK AREA IN ORDER TO IMPLEMENT CONTRACTOR'S TRENCH EXCAVATION SAFETY PROTECTION SYSTEMS, PROGRAMS AND /OR PROCEDURES FOR THE PROJECT DESCRIBED IN THE CONTRACT DOCUMENTS. THE CONTRACTOR'S IMPLEMENTATION OF THESE SYSTEMS, PROGRAMS AND/OR PROCEDURES SHALL PROVIDE FOR ADEQUATE TRENCH EXCAVATION SAFETY PROTECTION THAT COMPLY WITH AS A MINIMUM, OSHA STANDARDS FOR TRENCH EXCAVATIONS. SPECIFICALLY, CONTRACTOR AND/OR CONTRACTOR'S INDEPENDENTLY RETAINED EMPLOYEE OR SAFETY CONSULTANT SHALL IMPLEMENT A TRENCH SAFETY PROGRAM IN ACCORDANCE WITH OSHA STANDARDS GOVERNING THE PRESENCE AND ACTIVITIES OF INDIVIDUALS WORKING IN AND AROUND TRENCH EXCAVATION.

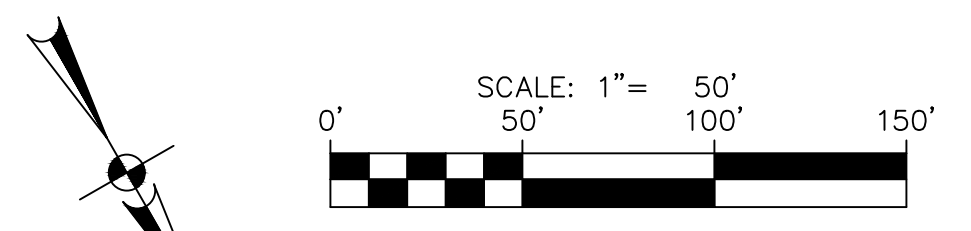

DATE: \_\_\_\_\_

NO. REVISION: \_\_\_\_\_

6-29-2023

Jocelyn Perez  
Professional Engineer

**PAPE-DAWSON ENGINEERS**

1672 INDEPENDENCE DR, STE 102 | NEW BRAUNFELS, TX 78132 | 800.632.5693  
TEXAS ENGINEERING FIRM #470 | TEXAS SURVEYING FIRM #1008800

**VERAMENDI PRECINCT 18 UNIT 1**  
NEW BRAUNFELS, TEXAS

**SANITARY SEWER LINE D - PLAN & PROFILE**  
STA 1+00.00 TO 7+60.46

JOB NO. 30001-66  
DATE 07-03-2023  
DESIGNER GDL  
CHECKED GDL DRAWN BH  
SHEET C5.13

**FOR PERMIT**



**CITY OF NEW BRAUNFELS NOTES**

- NO VALVES, HYDRANTS, ETC. SHALL BE CONSTRUCTED WITHIN CURBS, SIDEWALKS, OR DRIVEWAYS.
- ALL UTILITIES TO BE CONSTRUCTED PRIOR TO STREETS.
- THIS PROJECT INCLUDES UTILITY INSTALLATIONS GREATER THAN 5- FEET IN DEPTH. DEEP TRENCHES POSE COMPACTION TESTING AND CONSTRUCTION CHALLENGES AND CITY METHODS FOR TESTING AND COMPACTION MAY NOT BE ACHIEVABLE. A UTILITY COMPACTION PLAN WILL BE REQUIRED AND MUST BE SUBMITTED FOR APPROVAL TO CITY PRIOR TO UTILITY INSTALLATION.
- UTILITY TRENCH COMPACTION - ALL UTILITY TRENCH COMPACTION TESTS WITHIN THE STREET PAVEMENT/SIDEWALK SECTION SHALL BE THE RESPONSIBILITY OF THE DEVELOPER'S GEOTECHNICAL ENGINEER. FILL MATERIAL SHALL BE PLACED IN UNIFORM LAYERS NOT TO EXCEED TWELVE INCHES (12") LOOSE. DETERMINE THE MAXIMUM LIFT THICKNESS BASED ON THE ABILITY OF THE COMPACTING OPERATION AND EQUIPMENT USED TO MEET THE REQUIRED DENSITY. EACH LAYER OF MATERIAL SHALL BE COMPACTED TO A MINIMUM 95% DENSITY AND TESTED FOR DENSITY AND MOISTURE IN ACCORDANCE WITH TEST METHODS TEX-113-E, TEX-114-E, TEX-115-E. THE NUMBER AND LOCATION OF REQUIRED TESTS SHALL BE DETERMINED BY THE GEOTECHNICAL ENGINEER AND APPROVED BY THE CITY OF NEW BRAUNFELS STREET INSPECTOR. AT A MINIMUM, TESTS SHALL BE TAKEN EVERY 200 LF FOR EACH LIFT AND EVERY OTHER SERVICE LINE. UPON COMPLETION OF TESTING THE GEOTECHNICAL ENGINEER SHALL PROVIDE THE CITY OF NEW BRAUNFELS STREET INSPECTOR WITH ALL TESTING DOCUMENTATION AND A CERTIFICATION STATING THAT THE PLACEMENT OF FILL MATERIAL HAS BEEN COMPLETED IN ACCORDANCE WITH THE PLANS. ADDITIONAL DENSITY TESTS MAY BE REQUESTED BY THE CITY OF NEW BRAUNFELS INSPECTOR.

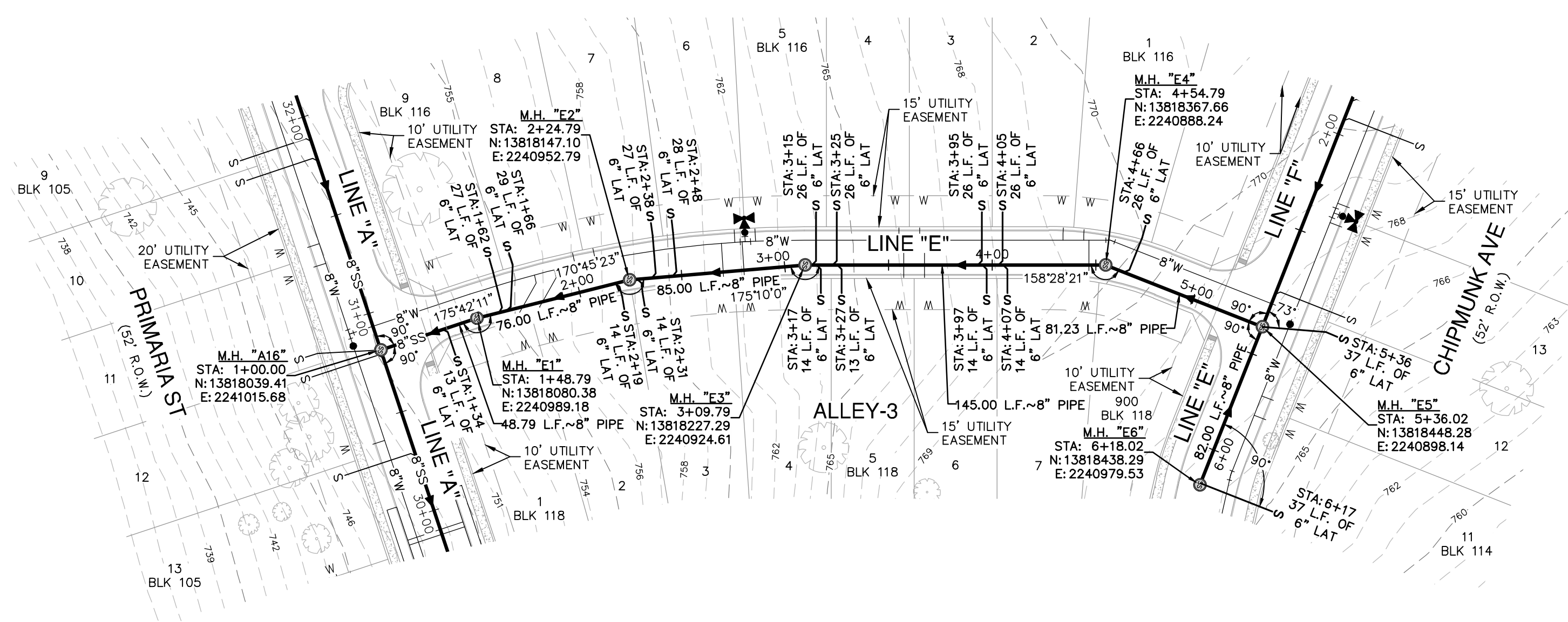
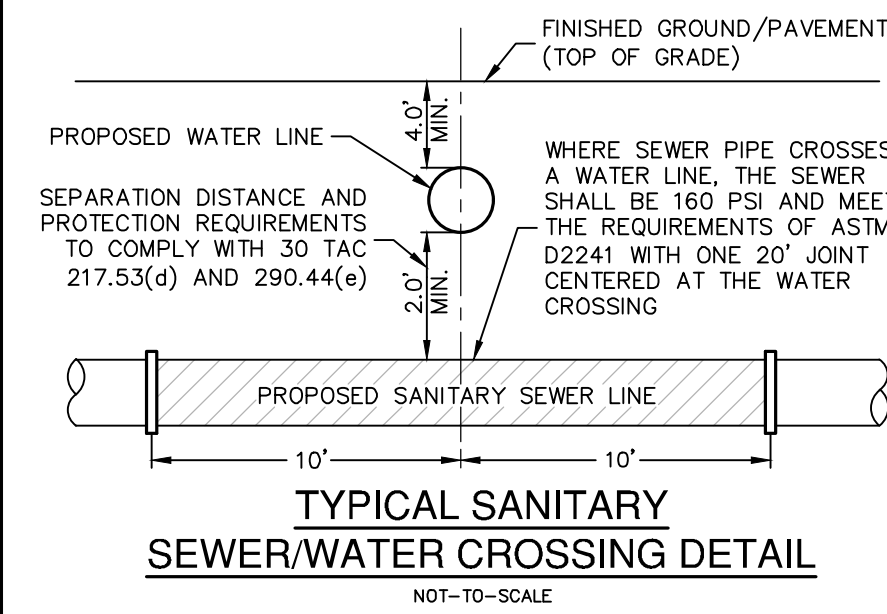
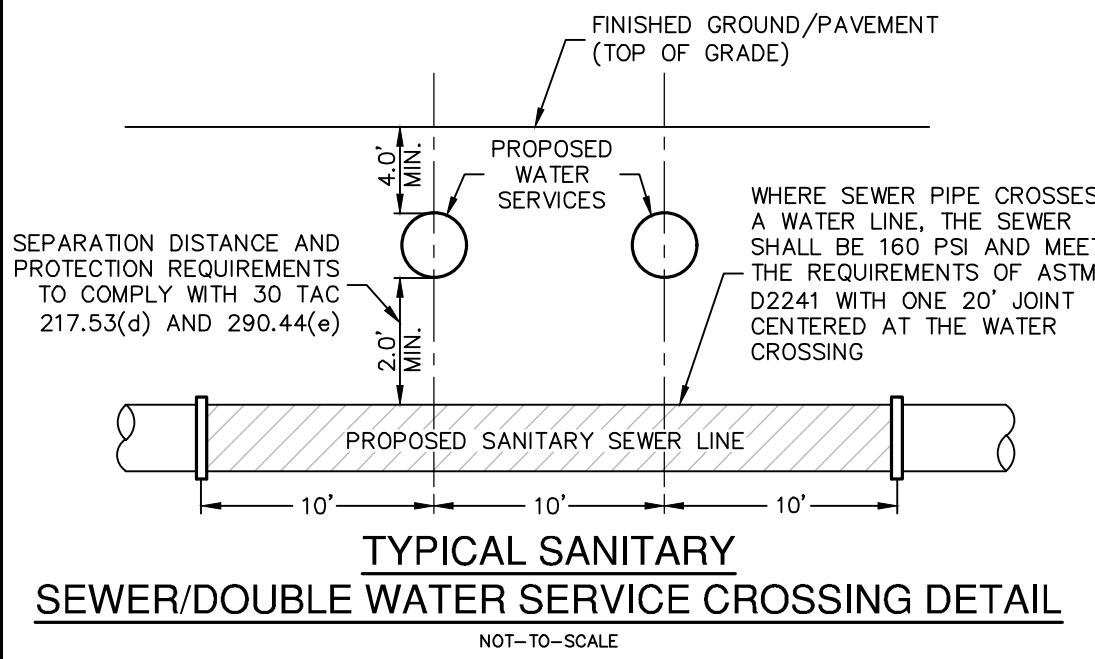

**SANITARY SEWER LINE "E"**  
STA 1+00.00 TO 6+18.02  
VERTICAL SCALE: 1" = 5'  
HORIZONTAL SCALE: 1" = 50'

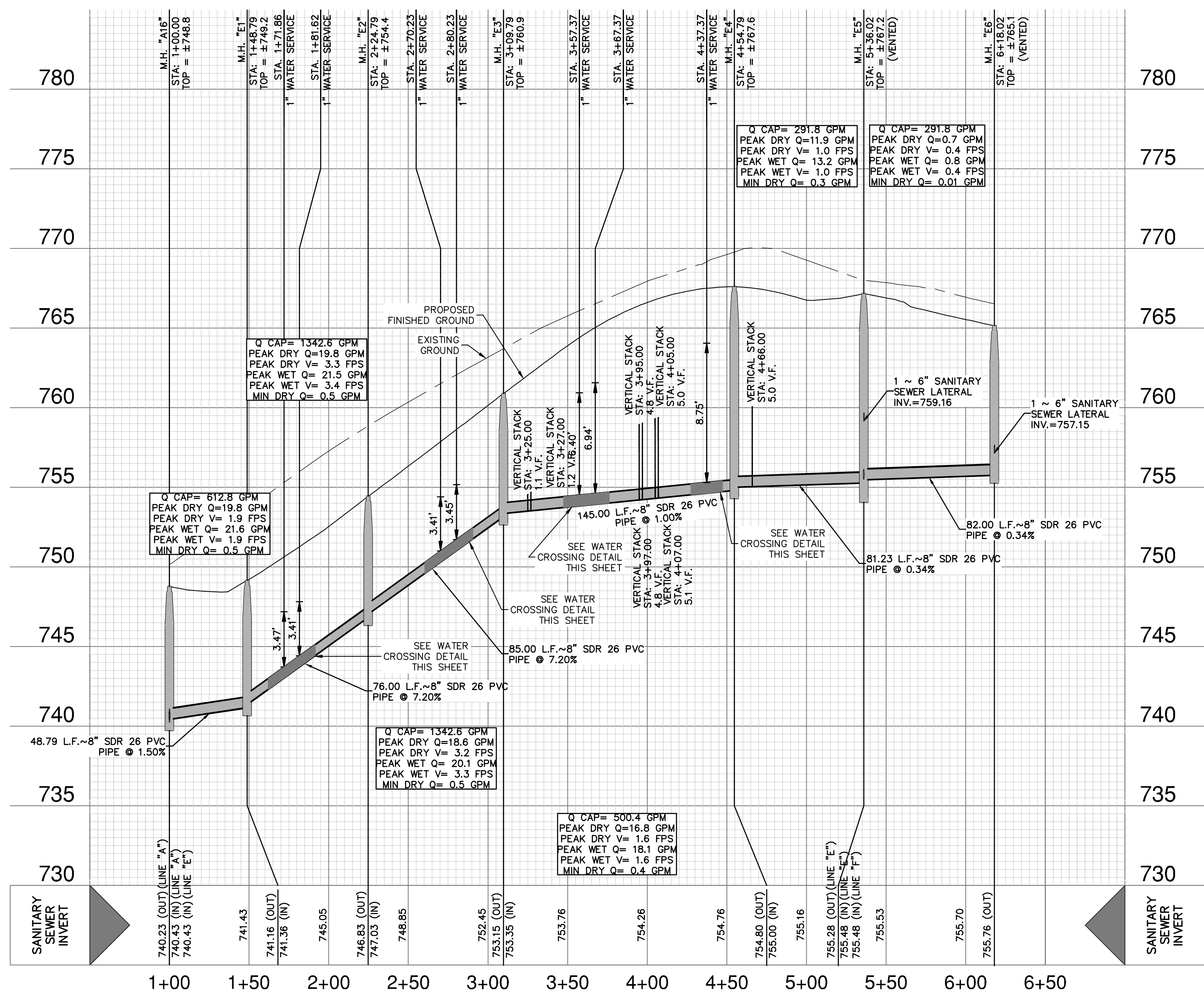

**SEWER LEGEND**

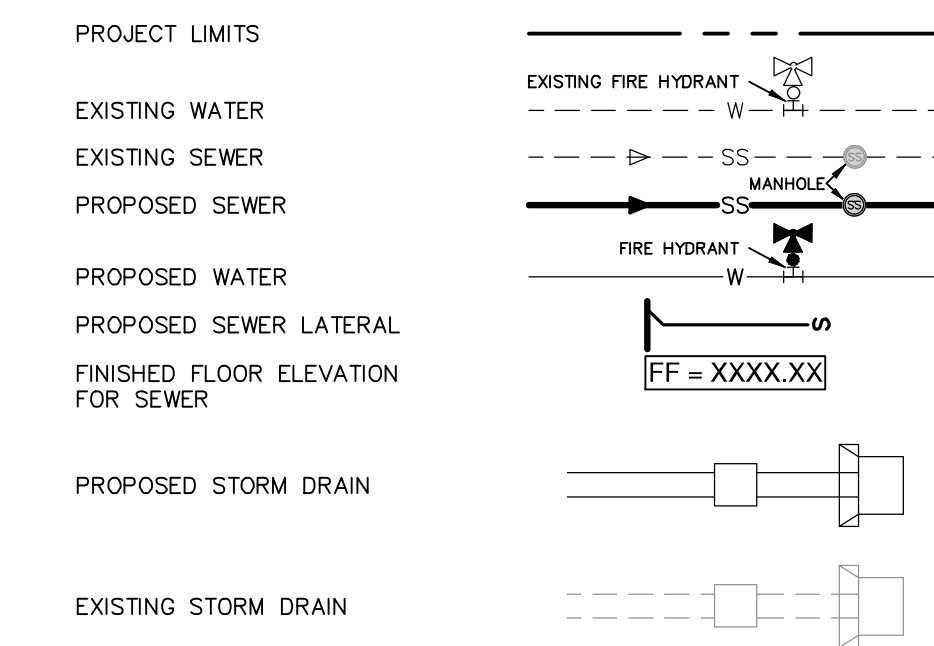

**NOTES**

- SEWER PIPE WHERE WATER LINE CROSSES SHALL BE 160 P.S.I. AND MEET THE REQUIREMENTS OF ASTM D2241 WITH ONE 20' JOINT CENTERED AT WATER MAIN.
- NO VERTICAL STACKS ALLOWED FOR ANY LOTS UNLESS OTHERWISE SPECIFIED BY THE ENGINEER.
- WHEN HORIZONTAL DISTANCE BETWEEN SEWER PIPES AND WATER MAIN IS LESS THAN 9 FEET OF SEPARATION, SEWER MAIN SHALL BE INSTALLED WITH 150 PSI (MIN) PRESSURE PIPE AND FITTINGS IN ACCORDANCE WITH NBU'S WATER CONNECTION POLICY IN THE VICINITY OF WATER MAINS. (SEE SEWER NOTES SHEET C5.30)
- CONTRACTOR SHALL ENSURE THAT MANHOLES OUTSIDE OF PAVED AREAS ARE SET WITH TOP ELEVATIONS 2" ABOVE FINISHED GRADE WITH CONCRETE RING ENCASUREMENT. CONTRACTOR SHALL ENSURE THAT MANHOLES IN PAVED AREAS ARE SET TO MATCH TOP OF FINISHED GRADE.
- ALL SEWER PIPES SHALL BE 8" PVC (SDR 26), UNLESS OTHERWISE NOTED.
- CONTRACTOR IS TO VERIFY EXISTING INVERT OF SANITARY SEWER MAIN AND ALERT ENGINEER IMMEDIATELY OF ANY DIFFERENCE FROM INVERT SHOWN ON PLANS.
- CONTRACTOR SHALL PROTECT ALL EXISTING FENCES. ANY FENCE DAMAGED BY THE CONTRACTOR SHALL BE REPAIRED BY THE CONTRACTOR AT HIS EXPENSE.
- THE CONTRACTOR WILL BE RESPONSIBLE FOR DETERMINING EXACT LOCATION OF ALL UTILITIES AND DRAINAGE STRUCTURES WHETHER SHOWN ON THE PLANS OR NOT. THE CONTRACTOR SHALL UNCOVER EXISTING UTILITIES PRIOR TO CONSTRUCTION TO VERIFY SIZE, GRADE, AND LOCATION. THE CONTRACTOR SHALL NOTIFY THE ENGINEER IMMEDIATELY OF ANY DEVIATIONS FROM PLANS PRIOR TO BEGINNING CONSTRUCTION. ANY DAMAGE TO EXISTING UTILITIES, WHETHER SHOWN ON THE PLANS OR NOT, SHALL BE THE CONTRACTOR'S RESPONSIBILITY TO REPAIR, AT HIS EXPENSE.
- SEE THIS SHEET FOR TYPICAL SANITARY SEWER/WATER CROSSING DETAIL.
- IF A CONFLICT EXISTS BETWEEN THE VARIOUS SUBMITTED DOCUMENTS (ENGINEERING CALCULATIONS, PROJECTED SPECIFICATIONS, PROJECTED PLANS, ADDENDUMS, ETC.), THE FOLLOWING DOCUMENTS TAKE PRECEDENCE: SPECIFICATIONS GOVERN OVER PLANS, SPECIAL CONDITIONS GOVERN OVER SPECIFICATIONS AND PLANS. ADDENDUMS TAKE PRECEDENCE OVER ALL.
- LAST 20 LF. OF 8" STUB-OUT SHALL BE CONSTRUCTED OF P.V.C. SDR 26 (160 P.S.I.) PRESSURE PIPE.
- ALL SEWER PIPE LATERALS SHALL BE SDR 26 (CLASS 160) PVC PIPE AND SHALL HAVE A MINIMUM SLOPE OF 2%.
- WASTEWATER LATERALS SHALL BE LAID WITH A MINIMUM OF 36 INCHES OF COVER.
- NEW MANHOLES MUST BE CONSTRUCTED OF OR LINED WITH A CORROSION RESISTANT MATERIAL. WHERE NEW CONSTRUCTION CONNECTS TO AN EXISTING MANHOLE THAT IS NOT CONSTRUCTED OF A CORROSION RESISTANT MATERIAL, THE EXISTING MANHOLE MUST BE LINED WITH OR REPLACED WITH A CORROSION RESISTANT MATERIAL.
- 48" MANHOLES ARE REQUIRED FOR ALL MAINS UP TO 18" IN DIAMETER.

**FLOODPLAIN NOTE**

- NO PORTION OF ANY LOT ON THIS PROJECT IS WITHIN AN INDICATED SPECIAL FLOOD HAZARD ZONE ACCORDING TO THE FEMA FIRM MAP NO. 48187C0095F EFFECTIVE DATE 9/2/2009.

**CAUTION!!**

CONTRACTOR SHALL BE REQUIRED TO LOCATE ALL PUBLIC OR PRIVATE UTILITIES INCLUDING BUT NOT LIMITING TO: WATER, SEWER, TELEPHONE AND FIBER OPTIC LINES, SITE LIGHTING ELECTRIC, SECONDARY ELECTRIC, PRIMARY ELECTRICAL, DUCTBANKS, LANDSCAPE IRRIGATION FACILITIES, AND GAS LINES. ANY UTILITY CONFLICTS THAT ARISE SHOULD BE COMMUNICATED TO THE ENGINEER IMMEDIATELY AND PRIOR TO CONSTRUCTION. THE CONTRACTOR SHALL CONTACT "TEXAS 811" A MINIMUM OF 48 HOURS PRIOR TO THE START OF CONSTRUCTION. ANY DAMAGE TO EXISTING UTILITIES SHALL BE THE SOLE RESPONSIBILITY OF THE CONTRACTOR AND THE REPAIR SHALL BE AT CONTRACTOR'S SOLE EXPENSE WHETHER THE UTILITY IS SHOWN ON THESE PLANS OR NOT.

**TRENCH EXCAVATION SAFETY PROTECTION:**

CONTRACTOR AND/OR CONTRACTOR'S INDEPENDENTLY RETAINED EMPLOYEE OR STRUCTURAL DESIGN/ GEOTECHNICAL/ SAFETY/EQUIPMENT CONSULTANT, IF ANY, SHALL REVIEW THESE PLANS AND ANY AVAILABLE GEOTECHNICAL INFORMATION AND THE ANTICIPATED INSTALLATION SITES WITHIN THE PROJECT WORK AREA IN ORDER TO IMPLEMENT CONTRACTOR'S TRENCH EXCAVATION SAFETY PROTECTION SYSTEMS, PROGRAMS AND /OR PROCEDURES FOR THE PROJECT DESCRIBED IN THE CONTRACT DOCUMENTS. THE CONTRACTOR'S IMPLEMENTATION OF THESE SYSTEMS, PROGRAMS AND/OR PROCEDURES SHALL PROVIDE FOR ADEQUATE TRENCH EXCAVATION SAFETY PROTECTION THAT COMPLY WITH AS A MINIMUM, OSHA STANDARDS FOR TRENCH EXCAVATIONS. SPECIFICALLY, CONTRACTOR AND/OR CONTRACTOR'S INDEPENDENTLY RETAINED EMPLOYEE OR SAFETY CONSULTANT SHALL IMPLEMENT A TRENCH SAFETY PROGRAM IN ACCORDANCE WITH OSHA STANDARDS GOVERNING THE PRESENCE AND ACTIVITIES OF INDIVIDUALS WORKING IN AND AROUND TRENCH EXCAVATION.

DATE: \_\_\_\_\_

NO. REVISION: \_\_\_\_\_

11-21-2023

JOCELYN PEREZ  
98367  
PROFESSIONAL ENGINEER

Brubaker

**PAPE-DAWSON ENGINEERS**

1672 IMPERIAL DR, STE 102 | NEW BRAUNFELS, TX 78132 | 800.632.5633  
TEXAS ENGINEERING FIRM #479 | TEXAS SURVEYING FIRM #1008800

**VERAMENDI PRECINCT 18 UNIT 1**  
NEW BRAUNFELS, TEXAS

**SANITARY SEWER LINE E - PLAN & PROFILE**  
STA 1+00.00 TO 6+18.02

JOB NO. 30001-66  
DATE 07-03-2023  
DESIGNER GDL  
CHECKED [initials] DRAWN BH  
SHEET C5.14

**FOR PERMIT**

Date: Nov 21, 2023, 4:00pm User ID: Atkamble  
File: C:\Users\LOCAL\_... \Temp\AcPublish\_2224\55E\_30001-66.dwg

THIS DOCUMENT HAS BEEN PRODUCED FROM MATERIAL THAT HAS STORED AND/OR TRANSMITTED ELECTRONICALLY AND MAY HAVE BEEN INADEQUATELY ALTERED. RELY ONLY ON FINAL HARDCOPY MATERIALS BEARING THE CONSULTANT'S ORIGINAL SIGNATURE AND SEAL. AERIAL IMAGERY PROVIDED BY GOOGLE/UNLESS OTHERWISE NOTED. Imagery © 2016, CAPCO/2016 Digital Globe, Texas Orthographic Program, USDA Farm Service Agency.



**CITY OF NEW BRAUNFELS NOTES**

- NO VALVES, HYDRANTS, ETC. SHALL BE CONSTRUCTED WITHIN CURBS, SIDEWALKS, OR DRIVEWAYS.
- ALL UTILITIES TO BE CONSTRUCTED PRIOR TO STREETS.
- THIS PROJECT INCLUDES UTILITY INSTALLATIONS GREATER THAN 5- FEET IN DEPTH. DEEP TRENCHES POSE COMPACTION TESTING AND CONSTRUCTION CHALLENGES AND CITY METHODS FOR TESTING AND COMPACTION MAY NOT BE ACHIEVABLE. A UTILITY COMPACTION PLAN WILL BE REQUIRED AND MUST BE SUBMITTED FOR APPROVAL TO CITY PRIOR TO UTILITY INSTALLATION.
- UTILITY TRENCH COMPACTION - ALL UTILITY TRENCH COMPACTION TESTS WITHIN THE STREET PAVEMENT/SIDEWALK SECTION SHALL BE THE RESPONSIBILITY OF THE DEVELOPER'S GEOTECHNICAL ENGINEER. FILL MATERIAL SHALL BE PLACED IN UNIFORM LAYERS NOT TO EXCEED TWELVE INCHES (12") LOOSE. DETERMINE THE MAXIMUM LIFT THICKNESS BASED ON THE ABILITY OF THE COMPACTION OPERATION AND EQUIPMENT USED TO MEET THE REQUIRED DENSITY. EACH LAYER OF MATERIAL SHALL BE COMPACTED TO A MINIMUM 95% DENSITY AND TESTED FOR DENSITY AND MOISTURE IN ACCORDANCE WITH TEST METHODS TEX-113-E, TEX-114-E, TEX-115-E. THE NUMBER AND LOCATION OF REQUIRED TESTS SHALL BE DETERMINED BY THE GEOTECHNICAL ENGINEER AND APPROVED BY THE CITY OF NEW BRAUNFELS STREET INSPECTOR. AT A MINIMUM, TESTS SHALL BE TAKEN EVERY 200 LF FOR EACH LIFT AND EVERY OTHER SERVICE LINE. UPON COMPLETION OF TESTING THE GEOTECHNICAL ENGINEER SHALL PROVIDE THE CITY OF NEW BRAUNFELS STREET INSPECTOR WITH ALL TESTING DOCUMENTATION AND A CERTIFICATION STATING THAT THE PLACEMENT OF FILL MATERIAL HAS BEEN COMPLETED IN ACCORDANCE WITH THE PLANS. ADDITIONAL DENSITY TESTS MAY BE REQUESTED BY THE CITY OF NEW BRAUNFELS STREET INSPECTOR.

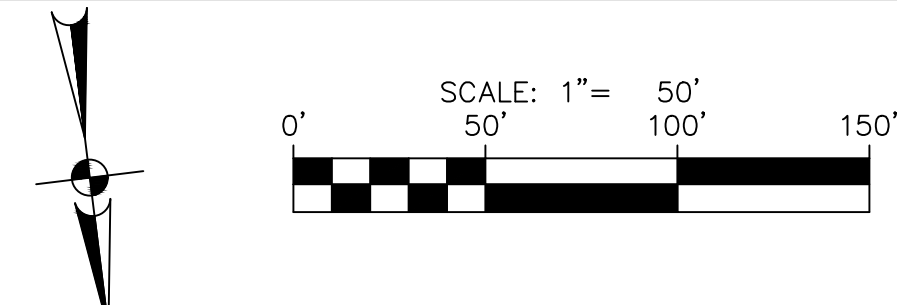
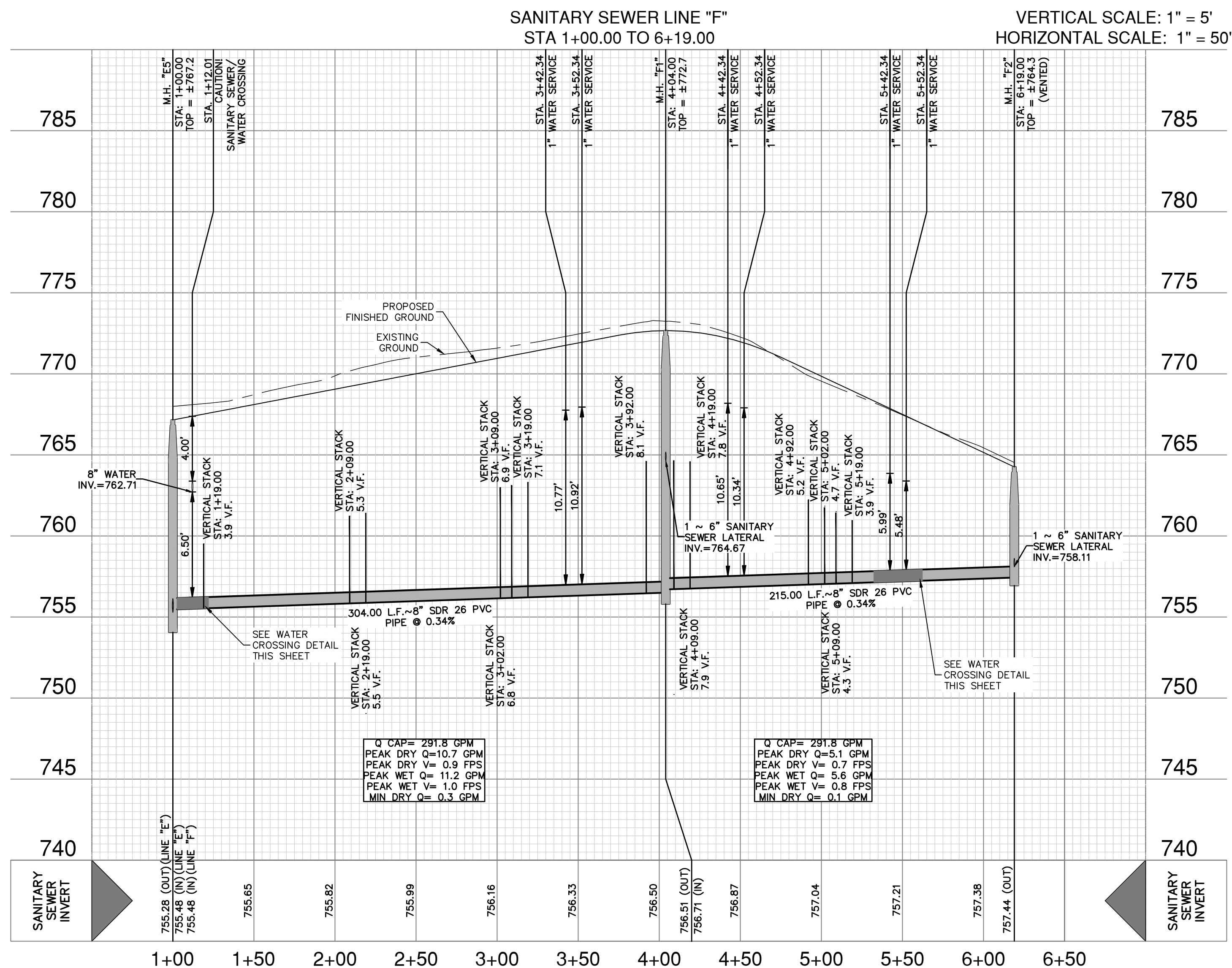
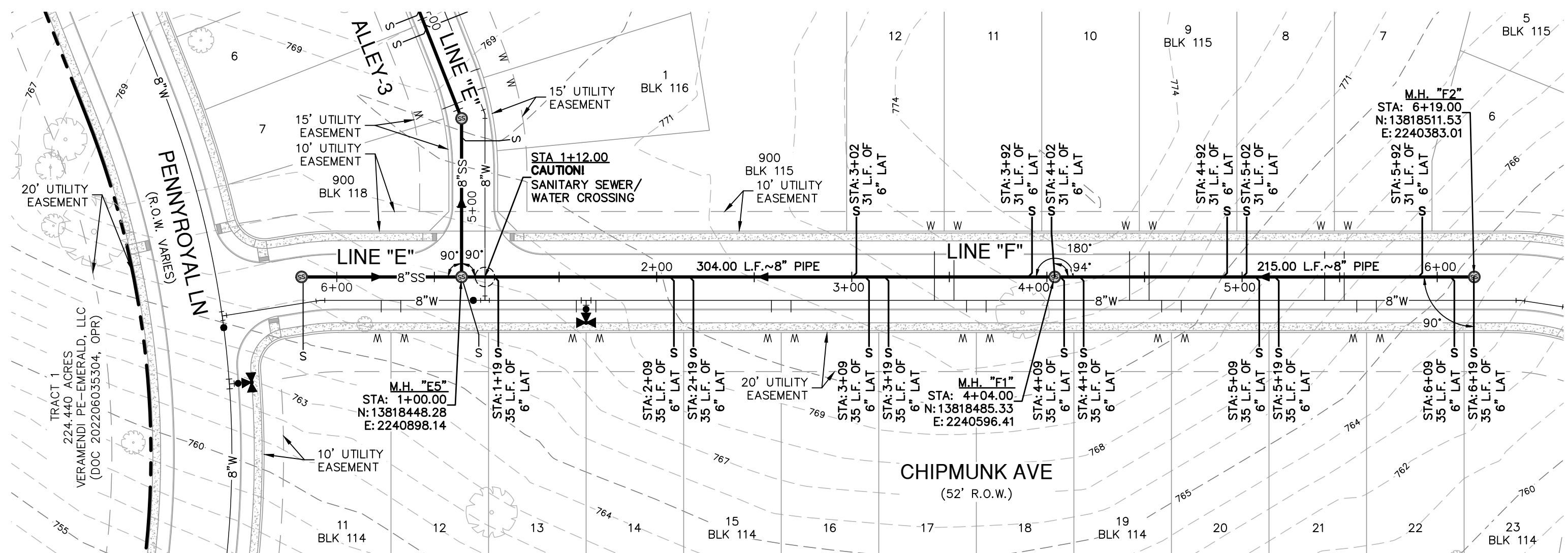
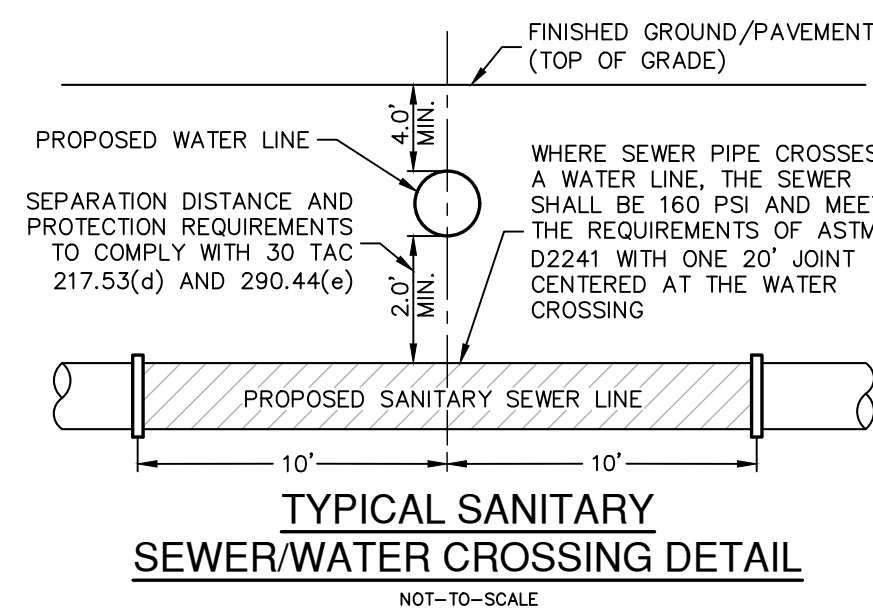
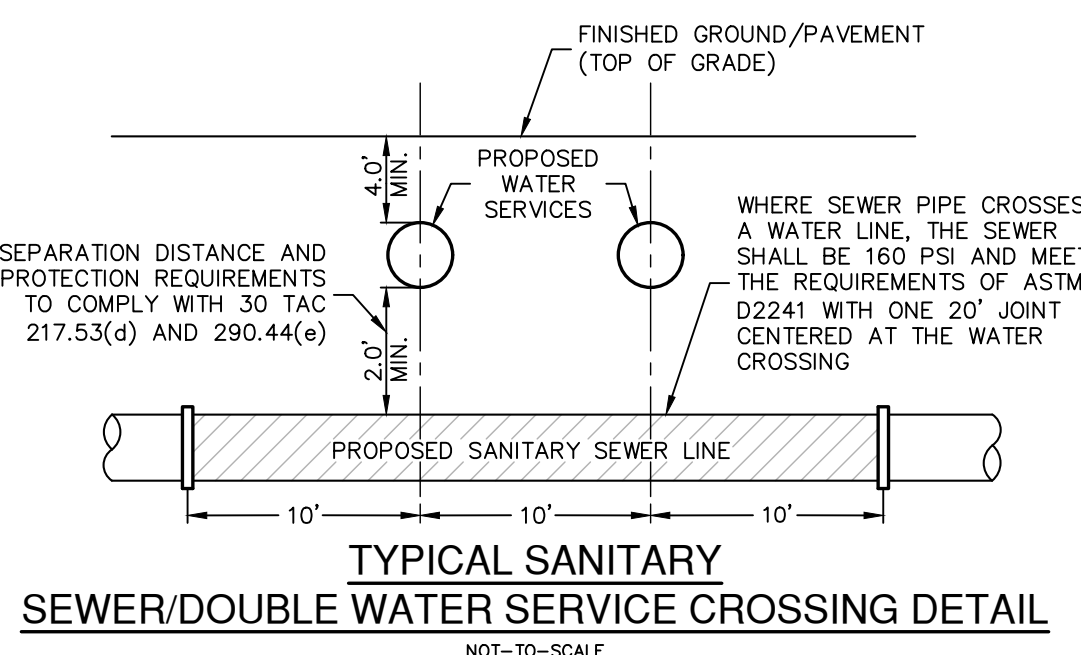

**SEWER LEGEND**

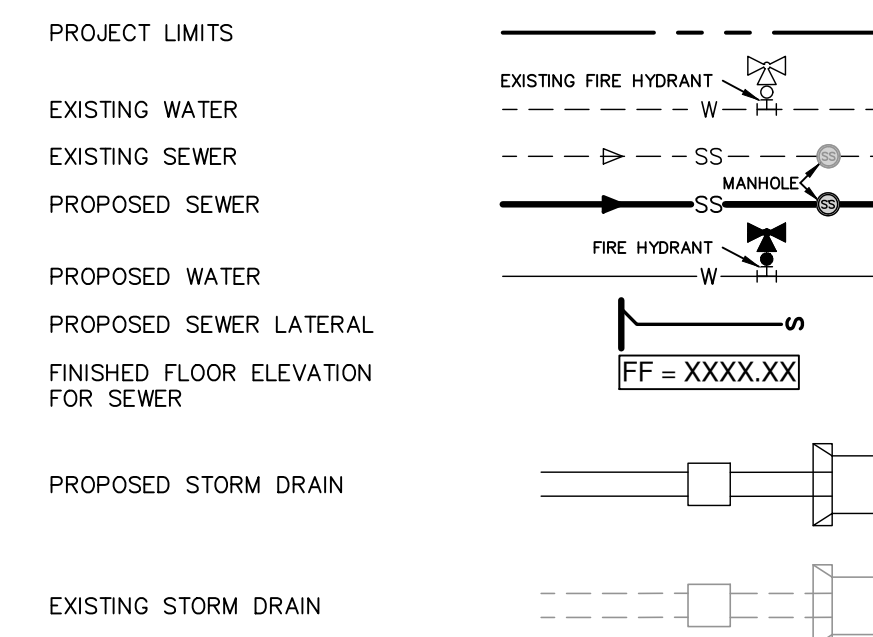

**NOTES**

- SEWER PIPE WHERE WATER LINE CROSSES SHALL BE 160 P.S.I. AND MEET THE REQUIREMENTS OF ASTM D2241 WITH ONE 20' JOINT CENTERED AT WATER MAIN.
- NO VERTICAL STACKS ALLOWED FOR ANY LOTS UNLESS OTHERWISE SPECIFIED BY THE ENGINEER.
- WHEN HORIZONTAL DISTANCE BETWEEN SEWER PIPES AND WATER MAIN IS LESS THAN 9 FOOT SEPARATION, SEWER MAIN SHALL BE INSTALLED WITH 150 PSI (MIN) PRESSURE PIPE AND FITTINGS IN ACCORDANCE WITH NBU'S WATER CONNECTION POLICY IN THE VICINITY OF WATER MAINS. (SEE SEWER NOTES SHEET C5.30)
- CONTRACTOR SHALL ENSURE THAT MANHOLES OUTSIDE OF PAVED AREAS ARE SET WITH TOP ELEVATIONS 2' ABOVE FINISHED GRADE WITH CONCRETE RING ENCASUREMENT. CONTRACTOR SHALL ENSURE THAT MANHOLES IN PAVED AREAS ARE SET TO MATCH TOP OF FINISHED GRADE.
- ALL SEWER PIPES SHALL BE 8" PVC (SDR 26), UNLESS OTHERWISE NOTED.
- CONTRACTOR IS TO VERIFY EXISTING INVERT OF SANITARY SEWER MAIN AND ALERT ENGINEER IMMEDIATELY OF ANY DIFFERENCE FROM INVERT SHOWN ON PLANS.
- CONTRACTOR SHALL PROTECT ALL EXISTING FENCES. ANY FENCE DAMAGED BY THE CONTRACTOR SHALL BE REPAIRED BY THE CONTRACTOR AT HIS EXPENSE.
- THE CONTRACTOR WILL BE RESPONSIBLE FOR DETERMINING EXACT LOCATION OF ALL UTILITIES AND DRAINAGE STRUCTURES WHETHER SHOWN ON THE PLANS OR NOT. THE CONTRACTOR SHALL UNCOVER EXISTING UTILITIES PRIOR TO CONSTRUCTION TO VERIFY SIZE, GRADE, AND LOCATION. THE CONTRACTOR SHALL NOTIFY THE ENGINEER IMMEDIATELY OF ANY DEVIATIONS FROM PLANS PRIOR TO BEGINNING CONSTRUCTION. ANY DAMAGE TO EXISTING UTILITIES, WHETHER SHOWN ON THE PLANS OR NOT, SHALL BE THE CONTRACTOR'S RESPONSIBILITY TO REPAIR, AT HIS EXPENSE.
- SEE THIS SHEET FOR TYPICAL SANITARY SEWER/WATER CROSSING DETAIL.
- IF A CONFLICT EXISTS BETWEEN THE VARIOUS SUBMITTED DOCUMENTS (ENGINEERING CALCULATIONS, PROJECTED SPECIFICATIONS, PROJECTED PLANS, ADDENDUMS, ETC.), THE FOLLOWING DOCUMENTS TAKE PRECEDENCE: SPECIFICATIONS GOVERN OVER PLANS, SPECIAL CONDITIONS GOVERN OVER SPECIFICATIONS AND PLANS. ADDENDUMS TAKE PRECEDENCE OVER ALL.
- LAST 20 L.F. OF 8" STUB-OUT SHALL BE CONSTRUCTED OF P.V.C. SDR 26 (160 P.S.I.) PRESSURE PIPE.
- ALL SEWER PIPE LATERALS SHALL BE SDR 26 (CLASS 160) PVC PIPE AND SHALL HAVE A MINIMUM SLOPE OF 2%.
- WASTEWATER LATERALS SHALL BE LAID WITH A MINIMUM OF 36 INCHES OF COVER.
- NEW MANHOLES MUST BE CONSTRUCTED OF OR LINED WITH A CORROSION RESISTANT MATERIAL. WHERE NEW CONSTRUCTION CONNECTS TO AN EXISTING MANHOLE THAT IS NOT CONSTRUCTED OF A CORROSION RESISTANT MATERIAL, THE EXISTING MANHOLE MUST BE LINED WITH OR REPLACED WITH A CORROSION RESISTANT MATERIAL.
- 48" MANHOLES ARE REQUIRED FOR ALL MAINS UP TO 18" IN DIAMETER.

**NOTE:**  
FOR PAVEMENT DESIGN SECTION SEE GEOTECHNICAL ENGINEERING REPORT.

**FLOODPLAIN NOTE**

- NO PORTION OF ANY LOT ON THIS PROJECT IS WITHIN AN INDICATED SPECIAL FLOOD HAZARD ZONE ACCORDING TO THE FEMA FIRM MAP NO. 48187C0095F EFFECTIVE DATE 9/2/2009.

**CAUTION!!**

CONTRACTOR SHALL BE REQUIRED TO LOCATE ALL PUBLIC OR PRIVATE UTILITIES INCLUDING BUT NOT LIMITING TO: WATER, SEWER, TELEPHONE AND FIBER OPTIC LINES, SITE LIGHTING ELECTRIC, SECONDARY ELECTRIC, PRIMARY ELECTRICAL, DUCTBANKS, LANDSCAPE IRRIGATION FACILITIES, AND GAS LINES. ANY UTILITY CONFLICTS THAT ARISE SHOULD BE COMMUNICATED TO THE ENGINEER IMMEDIATELY AND PRIOR TO CONSTRUCTION. THE CONTRACTOR SHALL CONTACT "TEXAS 811" A MINIMUM OF 48 HOURS PRIOR TO THE START OF CONSTRUCTION. ANY DAMAGE TO EXISTING UTILITIES SHALL BE THE SOLE RESPONSIBILITY OF THE CONTRACTOR AND THE REPAIR SHALL BE AT CONTRACTOR'S SOLE EXPENSE WHETHER THE UTILITY IS SHOWN ON THESE PLANS OR NOT.

**TRENCH EXCAVATION SAFETY PROTECTION:**

CONTRACTOR AND/OR CONTRACTOR'S INDEPENDENTLY RETAINED EMPLOYEE OR STRUCTURAL DESIGN/ GEOTECHNICAL/ SAFETY/EQUIPMENT CONSULTANT, IF ANY, SHALL REVIEW THESE PLANS AND ANY AVAILABLE GEOTECHNICAL INFORMATION AND THE ANTICIPATED INSTALLATION SITES WITHIN THE PROJECT WORK AREA IN ORDER TO IMPLEMENT CONTRACTOR'S TRENCH EXCAVATION SAFETY PROTECTION SYSTEMS, PROGRAMS AND /OR PROCEDURES FOR THE PROJECT DESCRIBED IN THE CONTRACT DOCUMENTS. THE CONTRACTOR'S IMPLEMENTATION OF THESE SYSTEMS, PROGRAMS AND/OR PROCEDURES SHALL PROVIDE FOR ADEQUATE TRENCH EXCAVATION SAFETY PROTECTION THAT COMPLY WITH AS A MINIMUM, OSHA STANDARDS FOR TRENCH EXCAVATIONS. SPECIFICALLY, CONTRACTOR AND/OR CONTRACTOR'S INDEPENDENTLY RETAINED EMPLOYEE OR SAFETY CONSULTANT SHALL IMPLEMENT A TRENCH SAFETY PROGRAM IN ACCORDANCE WITH OSHA STANDARDS GOVERNING THE PRESENCE AND ACTIVITIES OF INDIVIDUALS WORKING IN AND AROUND TRENCH EXCAVATION.

DATE: \_\_\_\_\_

NO. REVISION: \_\_\_\_\_

11-20-2023

Jocelyn Perez  
Professional Engineer

**PAPE-DAWSON ENGINEERS**

1672 INDEPENDENCE DR, STE 102 | NEW BRAUNFELS, TX 78132 | 800.632.5693  
TEXAS ENGINEERING FIRM #470 | TEXAS SURVEYING FIRM #1008900

**VERAMENDI PRECINCT 18 UNIT 1**  
NEW BRAUNFELS, TEXAS

**SANITARY SEWER LINE F - PLAN & PROFILE**  
STA 1+00.00 TO 6+19.00

JOB NO. 30001-66

DATE 07-03-2023

DESIGNER GDL

CHECKED [initials] DRAWN BH

SHEET C5.15

**FOR PERMIT**



**CITY OF NEW BRAUNFELS NOTES**

- NO VALVES, HYDRANTS, ETC. SHALL BE CONSTRUCTED WITHIN CURBS, SIDEWALKS, OR DRIVEWAYS.
- ALL UTILITIES TO BE CONSTRUCTED PRIOR TO STREETS.
- THIS PROJECT INCLUDES UTILITY INSTALLATIONS GREATER THAN 5- FEET IN DEPTH. DEEP TRENCHES POSE COMPACTION TESTING AND CONSTRUCTION CHALLENGES AND CITY METHODS FOR TESTING AND COMPACTION MAY NOT BE ACHIEVABLE. A UTILITY COMPACTION PLAN WILL BE REQUIRED AND MUST BE SUBMITTED FOR APPROVAL TO CITY PRIOR TO UTILITY INSTALLATION.
- UTILITY TRENCH COMPACTION - ALL UTILITY TRENCH COMPACTION TESTS WITHIN THE STREET PAVEMENT/SIDEWALK SECTION SHALL BE THE RESPONSIBILITY OF THE DEVELOPER'S GEOTECHNICAL ENGINEER. FILL MATERIAL SHALL BE PLACED IN UNIFORM LAYERS NOT TO EXCEED TWELVE INCHES (12") LOOSE. DETERMINE THE MAXIMUM LIFT THICKNESS BASED ON THE ABILITY OF THE COMPACTION OPERATION AND EQUIPMENT USED TO MEET THE REQUIRED DENSITY. EACH LAYER OF MATERIAL SHALL BE COMPACTED TO A MINIMUM 95% DENSITY AND TESTED FOR DENSITY AND MOISTURE IN ACCORDANCE WITH TEST METHODS TEX-113-E, TEX-114-E, TEX-115-E. THE NUMBER AND LOCATION OF REQUIRED TESTS SHALL BE DETERMINED BY THE GEOTECHNICAL ENGINEER AND APPROVED BY THE CITY OF NEW BRAUNFELS STREET INSPECTOR. AT A MINIMUM, TESTS SHALL BE TAKEN EVERY 200 LF FOR EACH LIFT AND EVERY OTHER SERVICE LINE. UPON COMPLETION OF TESTING THE GEOTECHNICAL ENGINEER SHALL PROVIDE THE CITY OF NEW BRAUNFELS STREET INSPECTOR WITH ALL TESTING DOCUMENTATION AND A CERTIFICATION STATING THAT THE PLACEMENT OF FILL MATERIAL HAS BEEN COMPLETED IN ACCORDANCE WITH THE PLANS. ADDITIONAL DENSITY TESTS MAY BE REQUESTED BY THE CITY OF NEW BRAUNFELS STREET INSPECTOR.

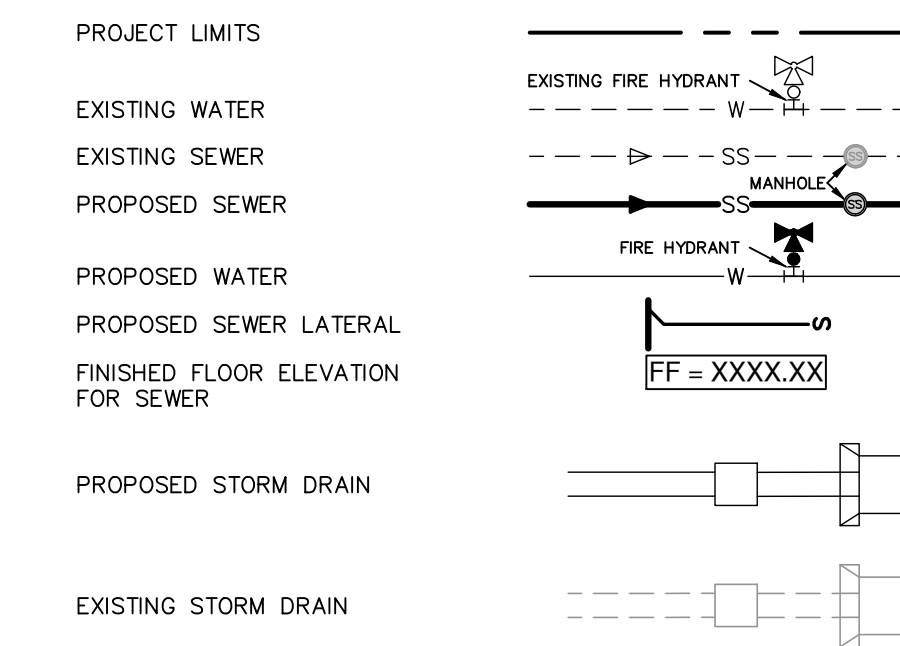
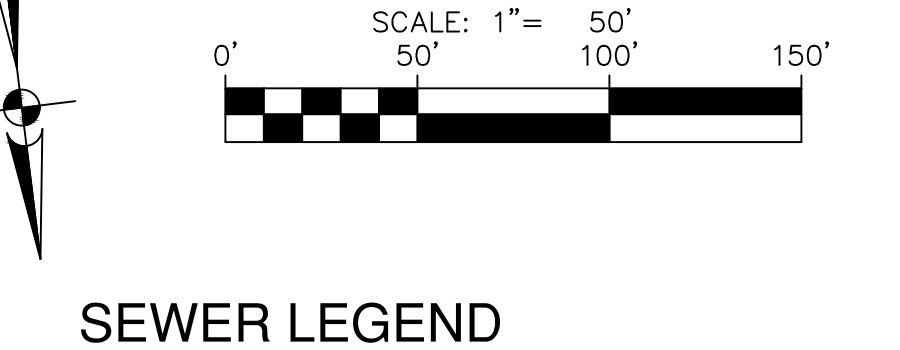
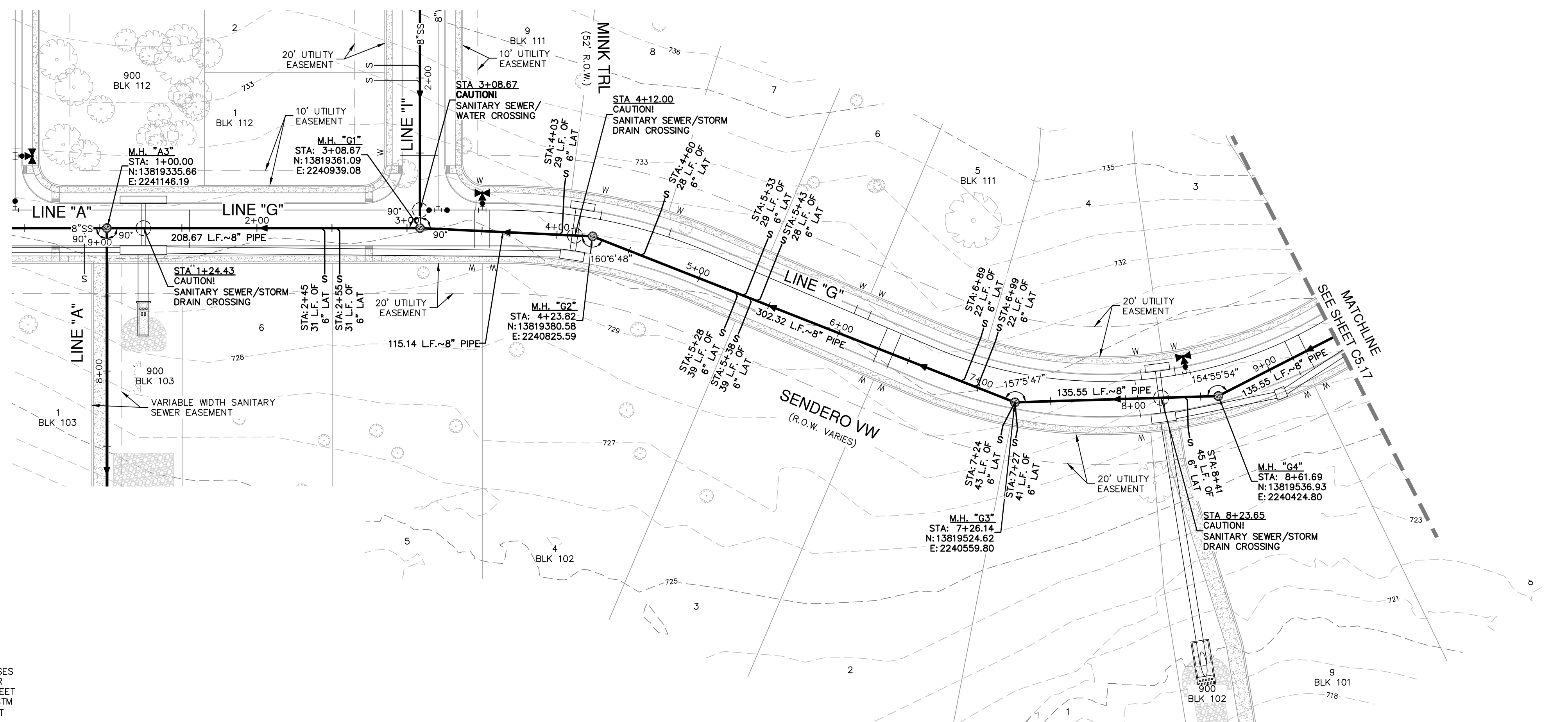
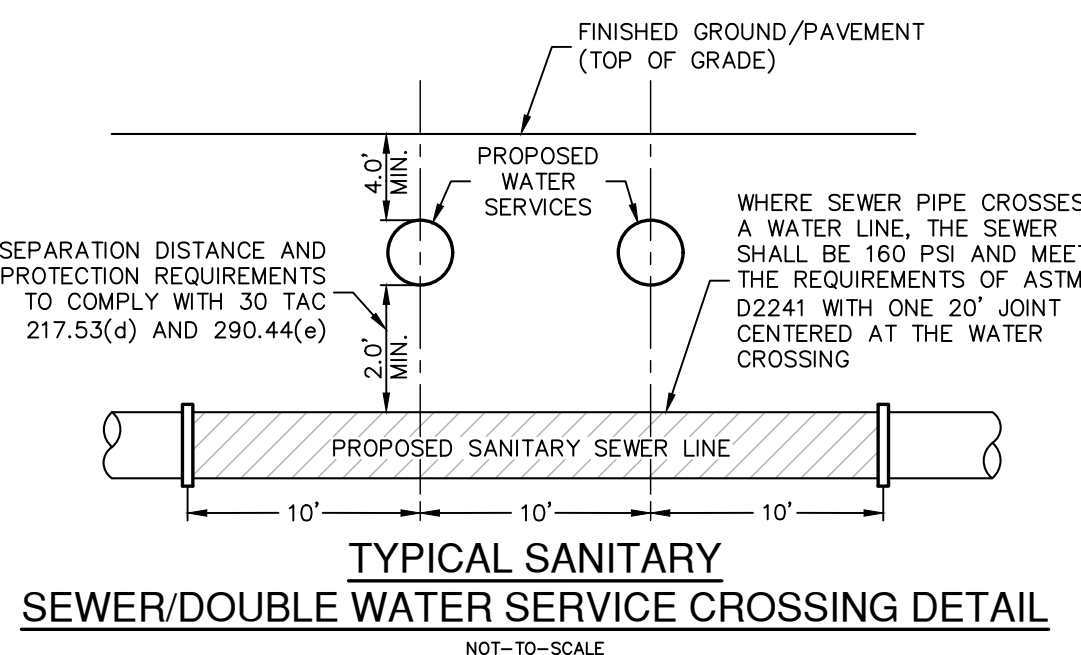
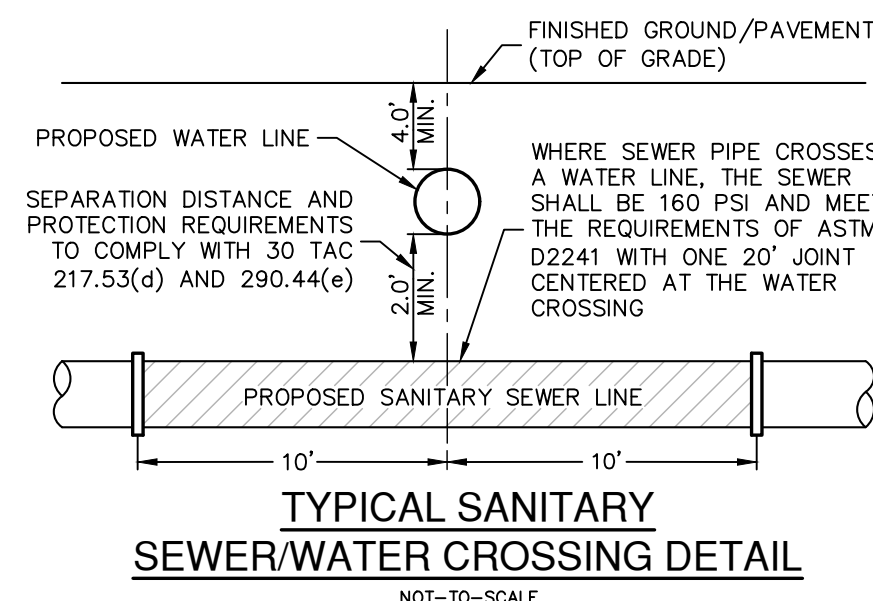

- NOTES**
- SEWER PIPE WHERE WATER LINE CROSSES SHALL BE 160 P.S.I. AND MEET THE REQUIREMENTS OF ASTM D2241 WITH ONE 20" JOINT CENTERED AT WATER MAIN.
  - NO VERTICAL STACKS ALLOWED FOR ANY LOTS UNLESS OTHERWISE SPECIFIED BY THE ENGINEER.
  - WHEN HORIZONTAL DISTANCE BETWEEN SEWER PIPES AND WATER MAIN IS LESS THAN 9 FOOT SEPARATION, SEWER MAIN SHALL BE INSTALLED WITH 150 PSI (MIN) PRESSURE PIPE AND FITTINGS IN ACCORDANCE WITH NBU'S WATER CONNECTION POLICY IN THE VICINITY OF WATER MAINS. (SEE SEWER NOTES SHEET C5.30)
  - CONTRACTOR SHALL ENSURE THAT MANHOLES OUTSIDE OF PAVED AREAS ARE SET WITH TOP ELEVATIONS 2" ABOVE FINISHED GRADE WITH CONCRETE RING ENGAGEMENT. CONTRACTOR SHALL ENSURE THAT MANHOLES IN PAVED AREAS ARE SET TO MATCH TOP OF FINISHED GRADE.
  - ALL SEWER PIPES SHALL BE 8" PVC (SDR 26), UNLESS OTHERWISE NOTED.
  - CONTRACTOR IS TO VERIFY EXISTING INVERT OF SANITARY SEWER MAIN AND ALERT ENGINEER IMMEDIATELY OF ANY DIFFERENCE FROM INVERT SHOWN ON PLANS.
  - CONTRACTOR SHALL PROTECT ALL EXISTING FENCES. ANY FENCE DAMAGED BY THE CONTRACTOR SHALL BE REPAIRED BY THE CONTRACTOR AT THEIR EXPENSE.
  - THE CONTRACTOR WILL BE RESPONSIBLE FOR DETERMINING EXACT LOCATION OF ALL UTILITIES AND DRAINAGE STRUCTURES WHETHER SHOWN ON THE PLANS OR NOT. THE CONTRACTOR SHALL UNCOVER EXISTING UTILITIES PRIOR TO CONSTRUCTION TO VERIFY SIZE, GRADE, AND LOCATION. THE CONTRACTOR SHALL NOTIFY THE ENGINEER IMMEDIATELY OF ANY DEVIATIONS FROM PLANS PRIOR TO BEGINNING CONSTRUCTION. ANY DAMAGE TO EXISTING UTILITIES, WHETHER SHOWN ON THE PLANS OR NOT, SHALL BE THE CONTRACTOR'S RESPONSIBILITY TO REPAIR, AT HIS EXPENSE.
  - SEE THIS SHEET FOR TYPICAL SANITARY SEWER/WATER CROSSING DETAIL.
  - IF A CONFLICT EXISTS BETWEEN THE VARIOUS SUBMITTED DOCUMENTS (ENGINEERING CALCULATIONS, PROJECTED SPECIFICATIONS, PROJECTED PLANS, ADDENDUMS, ETC.), THE FOLLOWING DOCUMENTS TAKE PRECEDENCE: SPECIFICATIONS GOVERN OVER PLANS, SPECIAL CONDITIONS GOVERN OVER SPECIFICATIONS AND PLANS. ADDENDUMS TAKE PRECEDENCE OVER ALL.
  - LAST 20 LF. OF 8" STUB-OUT SHALL BE CONSTRUCTED OF P.V.C. SDR 26 (160 P.S.I.) PRESSURE PIPE.
  - ALL SEWER PIPE LATERALS SHALL BE SDR 26 (CLASS 160) PVC PIPE AND SHALL HAVE A MINIMUM SLOPE OF 2%.
  - WASTEWATER LATERALS SHALL BE LAID WITH A MINIMUM OF 36 INCHES OF COVER.
  - NEW MANHOLES MUST BE CONSTRUCTED OF OR LINED WITH A CORROSION RESISTANT MATERIAL WHERE NEW CONSTRUCTION CONNECTS TO AN EXISTING MANHOLE THAT IS NOT CONSTRUCTED OF A CORROSION RESISTANT MATERIAL. THE EXISTING MANHOLE MUST BE LINED WITH OR REPLACED WITH A CORROSION RESISTANT MATERIAL.
  - 48" MANHOLES ARE REQUIRED FOR ALL MAINS UP TO 18" IN DIAMETER.

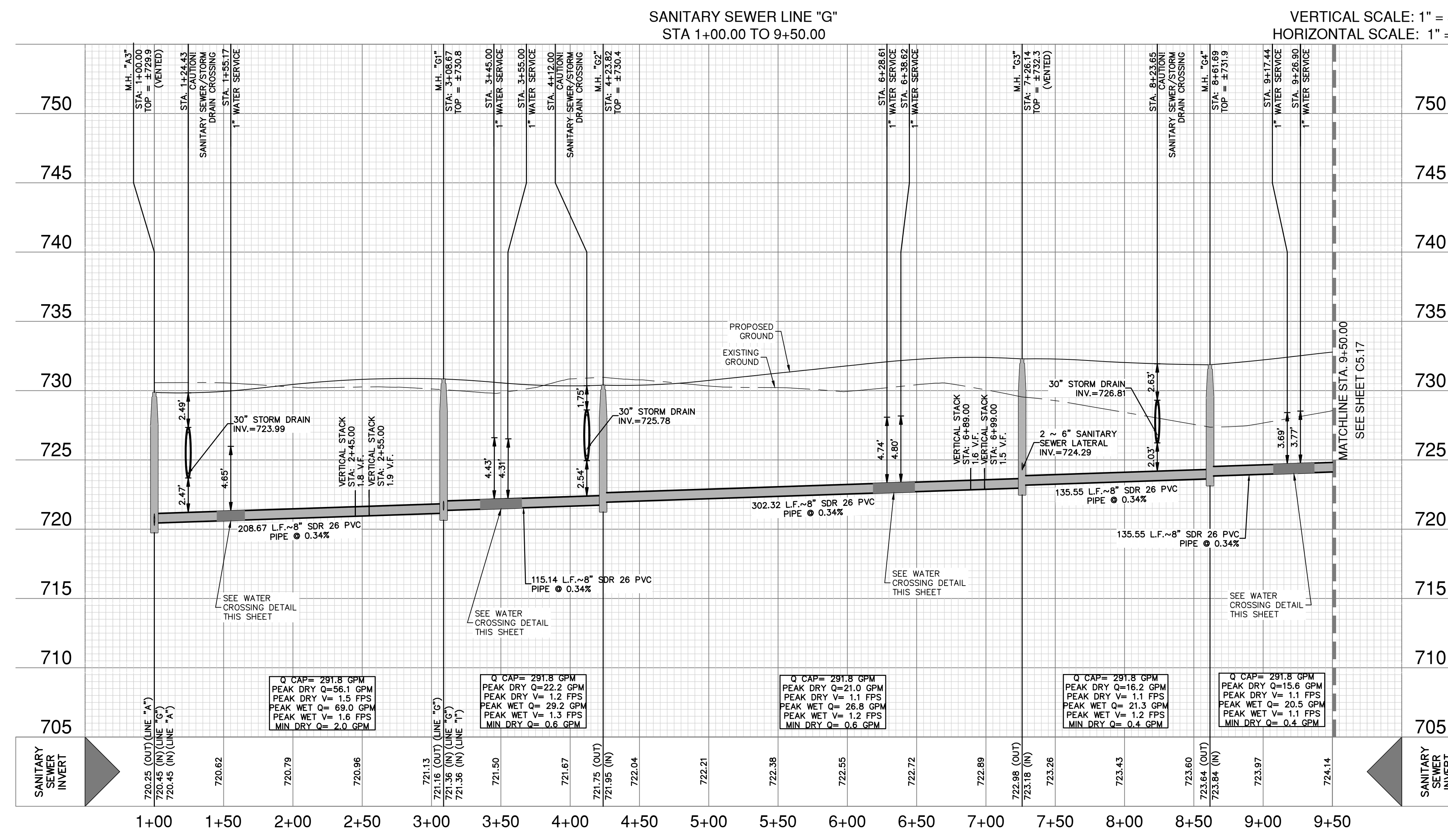

- FLOODPLAIN NOTE**
- NO PORTION OF ANY LOT ON THIS PROJECT IS WITHIN AN INDICATED SPECIAL FLOOD HAZARD ZONE ACCORDING TO THE FEMA FIRM MAP NO. 48187C0095F EFFECTIVE DATE 9/2/2009.
- CAUTION!!**
- CONTRACTOR SHALL BE REQUIRED TO LOCATE ALL PUBLIC OR PRIVATE UTILITIES INCLUDING BUT NOT LIMITING TO: WATER, SEWER, TELEPHONE AND FIBER OPTIC LINES, SITE LIGHTING ELECTRIC, SECONDARY ELECTRIC, PRIMARY ELECTRICAL DUCTBANKS, LANDSCAPE IRRIGATION FACILITIES, AND GAS LINES. ANY UTILITY CONFLICTS THAT ARISE SHOULD BE COMMUNICATED TO THE ENGINEER IMMEDIATELY AND PRIOR TO CONSTRUCTION. THE CONTRACTOR SHALL CONTACT "TEXAS 811" A MINIMUM OF 48 HOURS PRIOR TO THE START OF CONSTRUCTION. ANY DAMAGE TO EXISTING UTILITIES SHALL BE THE SOLE RESPONSIBILITY OF THE CONTRACTOR AND THE REPAIR SHALL BE AT CONTRACTOR'S SOLE EXPENSE WHETHER THE UTILITY IS SHOWN ON THESE PLANS OR NOT.
- TRENCH EXCAVATION SAFETY PROTECTION:**
- CONTRACTOR AND/OR CONTRACTOR'S INDEPENDENTLY RETAINED EMPLOYEE OR STRUCTURAL DESIGN/ GEOTECHNICAL/ SAFETY/EQUIPMENT CONSULTANT, IF ANY, SHALL REVIEW THESE PLANS AND ANY AVAILABLE GEOTECHNICAL INFORMATION AND THE ANTICIPATED INSTALLATION SITES WITHIN THE PROJECT WORK AREA IN ORDER TO IMPLEMENT CONTRACTOR'S TRENCH EXCAVATION SAFETY PROTECTION SYSTEMS, PROGRAMS AND /OR PROCEDURES FOR THE PROJECT DESCRIBED IN THE CONTRACT DOCUMENTS. THE CONTRACTOR'S IMPLEMENTATION OF THESE SYSTEMS, PROGRAMS AND/OR PROCEDURES SHALL PROVIDE FOR ADEQUATE TRENCH EXCAVATION SAFETY PROTECTION THAT COMPLY WITH AS A MINIMUM, OSHA STANDARDS FOR TRENCH EXCAVATIONS. SPECIFICALLY, CONTRACTOR AND/OR CONTRACTOR'S INDEPENDENTLY RETAINED EMPLOYEE OR SAFETY CONSULTANT SHALL IMPLEMENT A TRENCH SAFETY PROGRAM IN ACCORDANCE WITH OSHA STANDARDS GOVERNING THE PRESENCE AND ACTIVITIES OF INDIVIDUALS WORKING IN AND AROUND TRENCH EXCAVATION.

DATE: \_\_\_\_\_

NO. REVISION: \_\_\_\_\_

11-20-2023

Jocelyn Perez  
Professional Engineer  
98367

**PAPE-DAWSON ENGINEERS**

1672 INDEPENDENCE DR. STE 102 | NEW BRAUNFELS, TX 78132 | 800.632.5693  
TEXAS SURVEYING FIRM #1008800

**VERAMENDI PRECINCT 18 UNIT 1**  
NEW BRAUNFELS, TEXAS

**SANITARY SEWER LINE G - PLAN & PROFILE**  
STA 1+00.00 TO 9+50.00

JOB NO. 30001-66  
DATE 07-03-2023  
DESIGNER GDL  
CHECKED GDL DRAWN BH  
SHEET C5.16

Date: Nov 20, 2023, 1:59pm User ID: Dlynch  
File: P:\3001\01\66\Design\Chil\SSG-30001-66.dwg

THIS DOCUMENT HAS BEEN PRODUCED FROM MATERIAL THAT WAS STORED AND/OR TRANSMITTED ELECTRONICALLY AND MAY HAVE BEEN INADVERTENTLY ALTERED. RELY ONLY ON FINAL HARDCOPY MATERIALS BEARING THE CONSULTANT'S ORIGINAL SIGNATURE AND SEAL. AERIAL IMAGERY PROVIDED BY GOOGLE/UNLESS OTHERWISE NOTED. Imagery © 2016, Aerial Imagery Provided by Google/Unles otherwise noted. Imagery © 2016, Aerial Imagery Provided by Google/Unles otherwise noted. Imagery © 2016, Aerial Imagery Provided by Google/Unles otherwise noted. Imagery © 2016, Aerial Imagery Provided by Google/Unles otherwise noted.

FOR PERMIT



**CITY OF NEW BRAUNFELS NOTES**

- NO VALVES, HYDRANTS, ETC. SHALL BE CONSTRUCTED WITHIN CURBS, SIDEWALKS, OR DRIVEWAYS.
- ALL UTILITIES TO BE CONSTRUCTED PRIOR TO STREETS.
- THIS PROJECT INCLUDES UTILITY INSTALLATIONS GREATER THAN 5- FEET IN DEPTH. DEEP TRENCHES POSE COMPACTION TESTING AND CONSTRUCTION CHALLENGES AND CITY METHODS FOR TESTING AND COMPACTION MAY NOT BE ACHIEVABLE. A UTILITY COMPACTION PLAN WILL BE REQUIRED AND MUST BE SUBMITTED FOR APPROVAL TO CITY PRIOR TO UTILITY INSTALLATION.
- UTILITY TRENCH COMPACTION - ALL UTILITY TRENCH COMPACTION TESTS WITHIN THE STREET PAVEMENT/SIDEWALK SECTION SHALL BE THE RESPONSIBILITY OF THE DEVELOPER'S GEOTECHNICAL ENGINEER. FILL MATERIAL SHALL BE PLACED IN UNIFORM LAYERS NOT TO EXCEED TWELVE INCHES (12") LOOSE. DETERMINE THE MAXIMUM LIFT THICKNESS BASED ON THE ABILITY OF THE COMPACTION OPERATION AND EQUIPMENT USED TO MEET THE REQUIRED DENSITY. EACH LAYER OF MATERIAL SHALL BE COMPACTED TO A MINIMUM 95% DENSITY AND TESTED FOR DENSITY AND MOISTURE IN ACCORDANCE WITH TEST METHODS TEX-113-E, TEX-114-E, TEX-115-E. THE NUMBER AND LOCATION OF REQUIRED TESTS SHALL BE DETERMINED BY THE GEOTECHNICAL ENGINEER AND APPROVED BY THE CITY OF NEW BRAUNFELS STREET INSPECTOR. AT A MINIMUM, TESTS SHALL BE TAKEN EVERY 200 LF FOR EACH LIFT AND EVERY OTHER SERVICE LINE. UPON COMPLETION OF TESTING THE GEOTECHNICAL ENGINEER SHALL PROVIDE THE CITY OF NEW BRAUNFELS STREET INSPECTOR WITH ALL TESTING DOCUMENTATION AND A CERTIFICATION STATING THAT THE PLACEMENT OF FILL MATERIAL HAS BEEN COMPLETED IN ACCORDANCE WITH THE PLANS. ADDITIONAL DENSITY TESTS MAY BE REQUESTED BY THE CITY OF NEW BRAUNFELS STREET INSPECTOR.

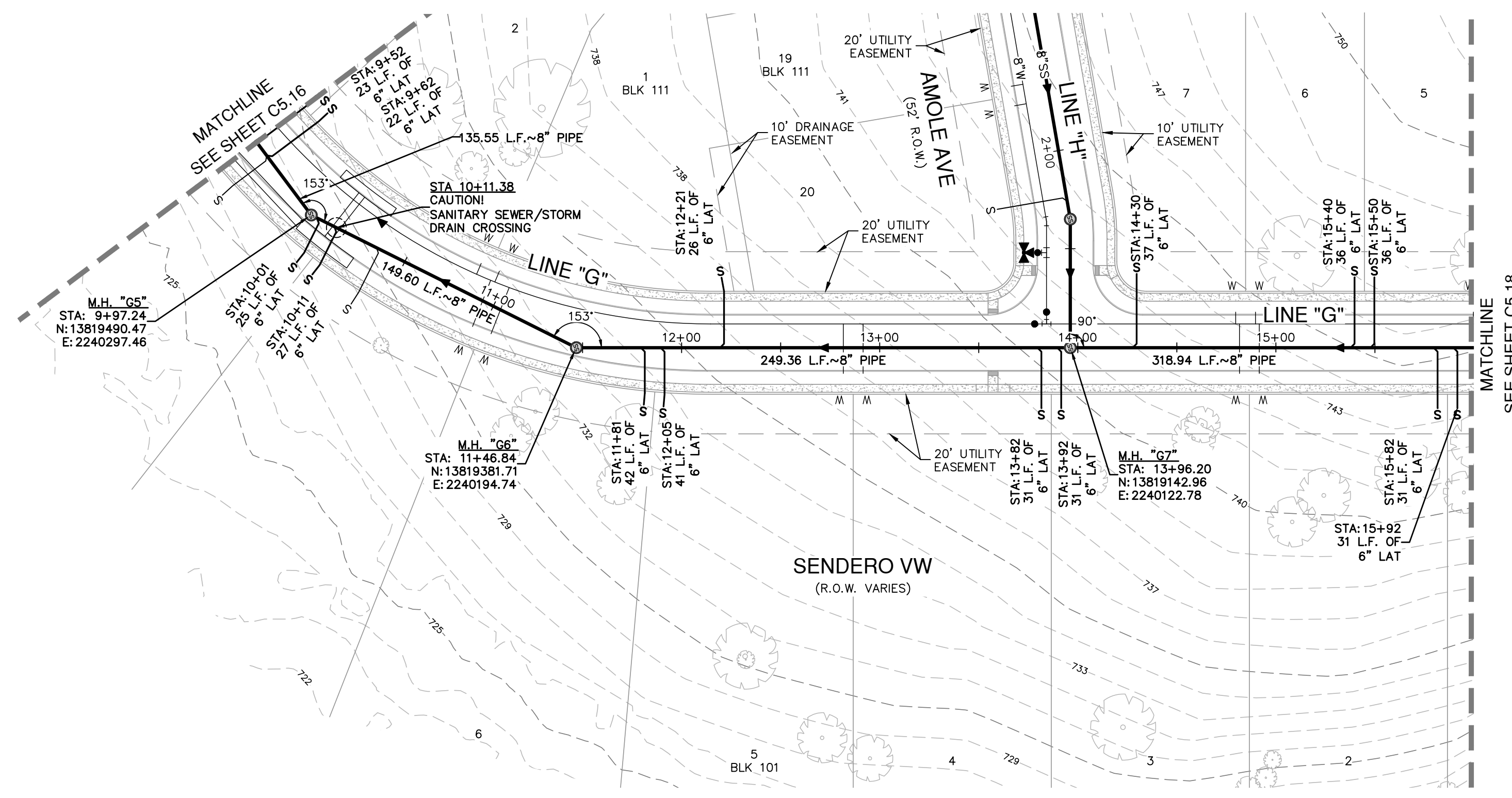
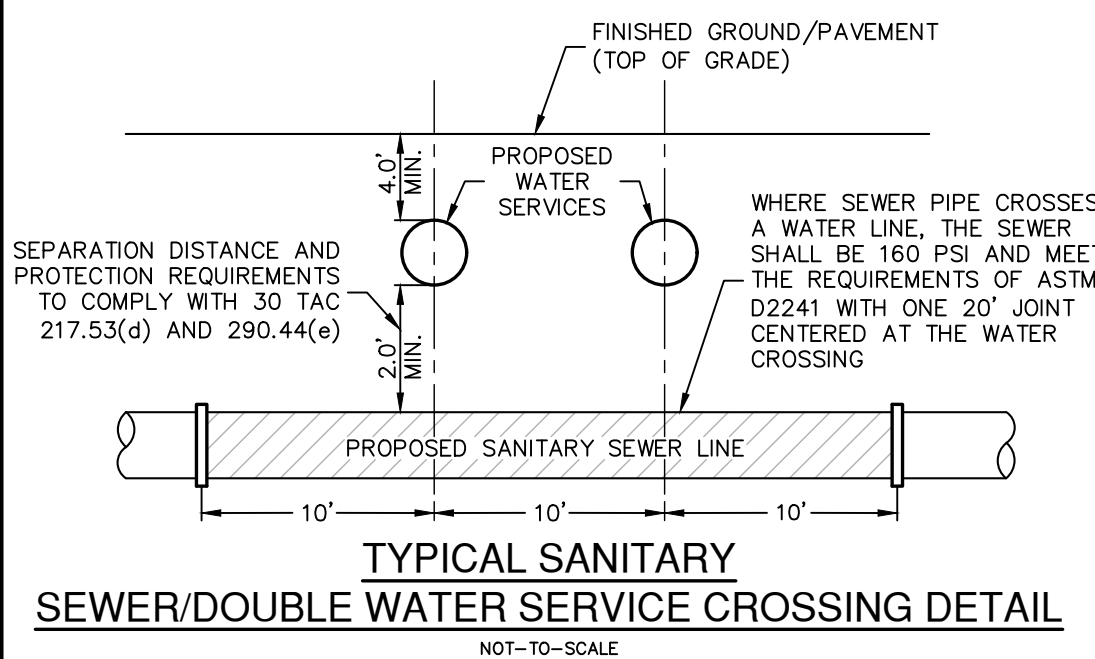
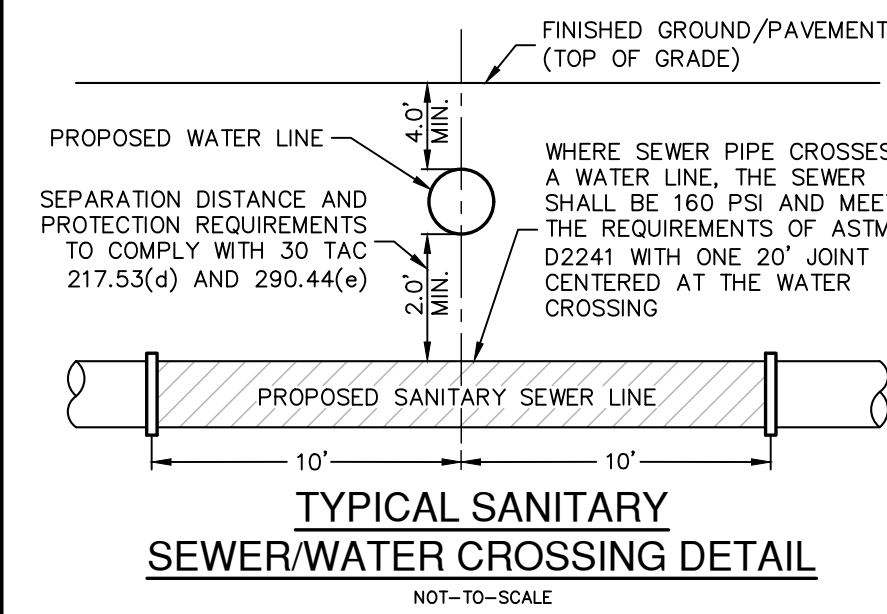

**SANITARY SEWER LINE "G"**  
STA 9+50.00 TO 16+00.00  
VERTICAL SCALE: 1" = 5'  
HORIZONTAL SCALE: 1" = 50'

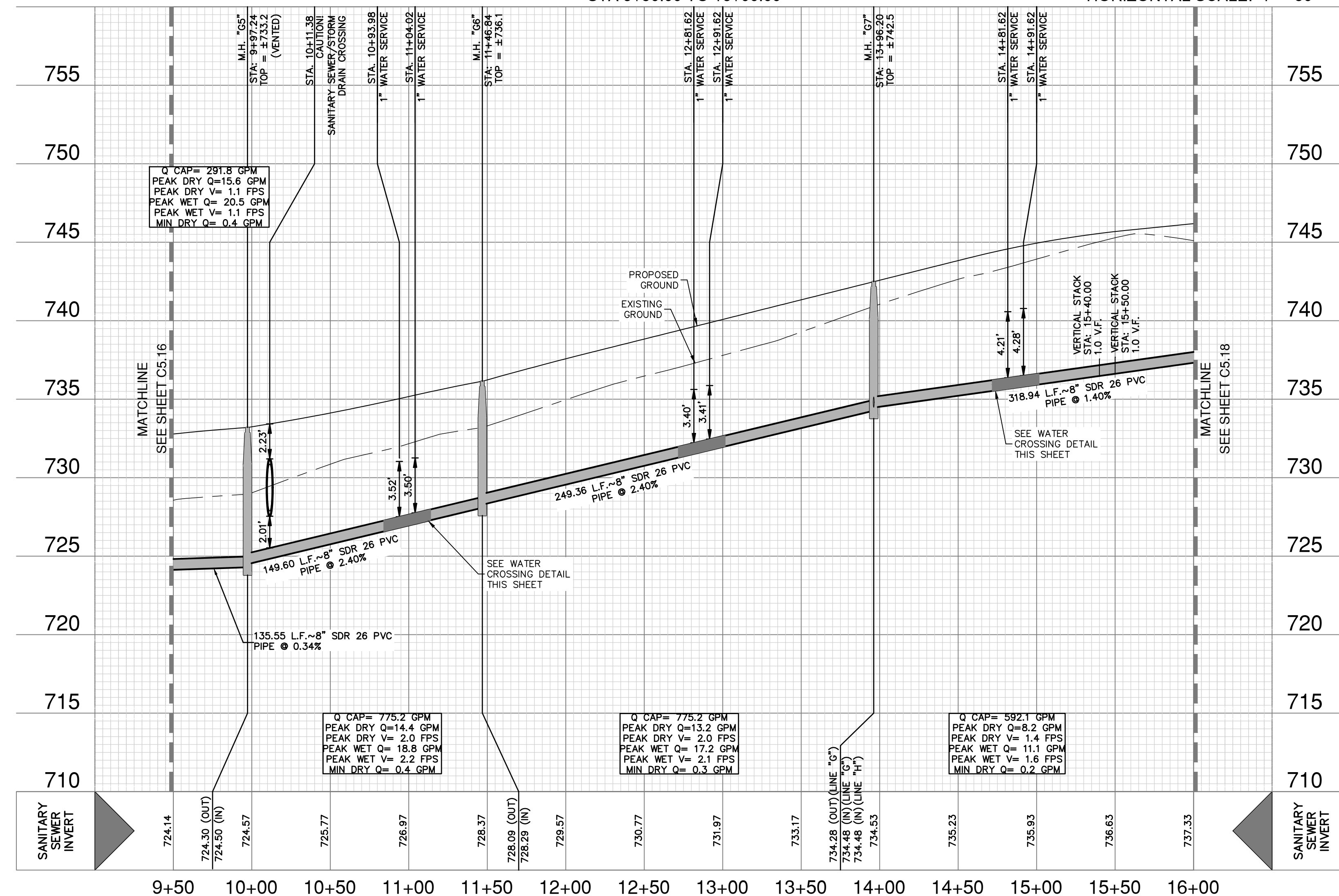

**SEWER LEGEND**

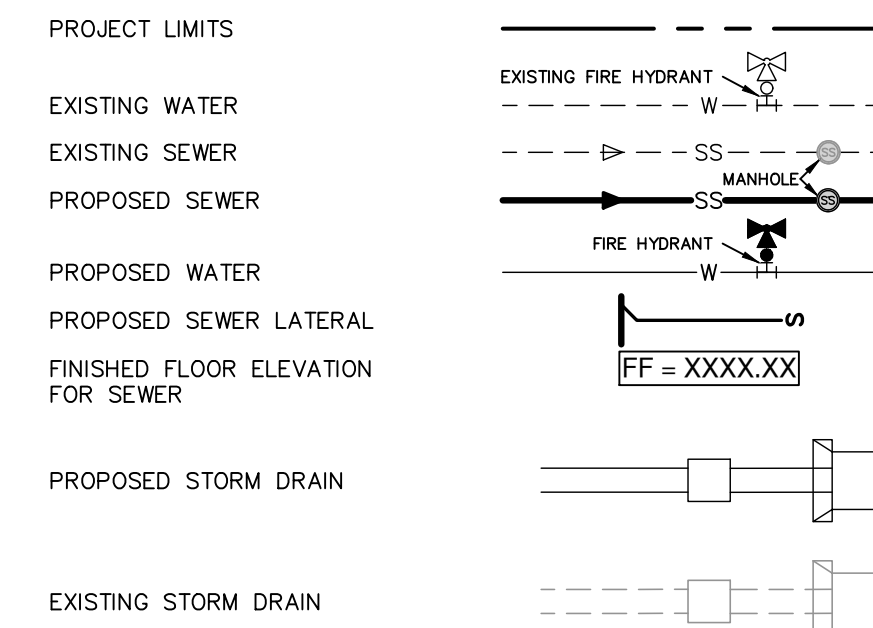

**NOTES**

- SEWER PIPE WHERE WATER LINE CROSSES SHALL BE 160 P.S.I. AND MEET THE REQUIREMENTS OF ASTM D2241 WITH ONE 20' JOINT CENTERED AT WATER MAIN.
- NO VERTICAL STACKS ALLOWED FOR ANY LOTS UNLESS OTHERWISE SPECIFIED BY THE ENGINEER.
- WHEN HORIZONTAL DISTANCE BETWEEN SEWER PIPES AND WATER MAIN IS LESS THAN 9 FEET OF SEPARATION, SEWER MAIN SHALL BE INSTALLED WITH 150 PSI (MIN) PRESSURE PIPE AND FITTINGS IN ACCORDANCE WITH NBU'S WATER CONNECTION POLICY IN THE VICINITY OF WATER MAINS. (SEE SEWER NOTES SHEET C5.30)
- CONTRACTOR SHALL ENSURE THAT MANHOLES OUTSIDE OF PAVED AREAS ARE SET WITH TOP ELEVATIONS 2" ABOVE FINISHED GRADE WITH CONCRETE RING ENCASUREMENT. CONTRACTOR SHALL ENSURE THAT MANHOLES IN PAVED AREAS ARE SET TO MATCH TOP OF FINISHED GRADE.
- ALL SEWER PIPES SHALL BE 8" PVC (SDR 26), UNLESS OTHERWISE NOTED.
- CONTRACTOR IS TO VERIFY EXISTING INVERT OF SANITARY SEWER MAIN AND ALERT ENGINEER IMMEDIATELY OF ANY DIFFERENCE FROM INVERT SHOWN ON PLANS.
- CONTRACTOR SHALL PROTECT ALL EXISTING FENCES. ANY FENCE DAMAGED BY THE CONTRACTOR SHALL BE REPAIRED BY THE CONTRACTOR AT THEIR EXPENSE.
- THE CONTRACTOR SHALL BE RESPONSIBLE FOR DETERMINING EXACT LOCATION OF ALL UTILITIES AND DRAINAGE STRUCTURES WHETHER SHOWN ON THE PLANS OR NOT. THE CONTRACTOR SHALL UNCOVER EXISTING UTILITIES PRIOR TO CONSTRUCTION TO VERIFY SIZE, GRADE, AND LOCATION. THE CONTRACTOR SHALL NOTIFY THE ENGINEER IMMEDIATELY OF ANY DEVIATIONS FROM PLANS PRIOR TO BEGINNING CONSTRUCTION. ANY DAMAGE TO EXISTING UTILITIES, WHETHER SHOWN ON THE PLANS OR NOT, SHALL BE THE CONTRACTOR'S RESPONSIBILITY TO REPAIR, AT HIS EXPENSE.
- SEE THIS SHEET FOR TYPICAL SANITARY SEWER/WATER CROSSING DETAIL.
- IF A CONFLICT EXISTS BETWEEN THE VARIOUS SUBMITTED DOCUMENTS (ENGINEERING CALCULATIONS, PROJECTED SPECIFICATIONS, PROJECTED PLANS, ADDENDUMS, ETC.), THE FOLLOWING DOCUMENTS TAKE PRECEDENCE: SPECIFICATIONS GOVERN OVER PLANS, SPECIAL CONDITIONS GOVERN OVER SPECIFICATIONS AND PLANS. ADDENDUMS TAKE PRECEDENCE OVER ALL.
- LAST 20 L.F. OF 8" STUB-OUT SHALL BE CONSTRUCTED OF P.V.C. SDR 26 (160 P.S.I.) PRESSURE PIPE.
- ALL SEWER PIPE LATERALS SHALL BE SDR 26 (CLASS 160) PVC PIPE AND SHALL HAVE A MINIMUM SLOPE OF 2%.
- WASTEWATER LATERALS SHALL BE LAID WITH A MINIMUM OF 36 INCHES OF COVER.
- NEW MANHOLES MUST BE CONSTRUCTED OF OR LINED WITH A CORROSION RESISTANT MATERIAL WHERE NEW CONSTRUCTION CONNECTS TO AN EXISTING MANHOLE THAT IS NOT CONSTRUCTED OF A CORROSION RESISTANT MATERIAL. THE EXISTING MANHOLE MUST BE LINED WITH OR REPLACED WITH A CORROSION RESISTANT MATERIAL.
- 48" MANHOLES ARE REQUIRED FOR ALL MAINS UP TO 18" IN DIAMETER.

**NOTE:**  
FOR PAVEMENT DESIGN SECTION SEE GEOTECHNICAL ENGINEERING REPORT.

**FLOODPLAIN NOTE**

- NO PORTION OF ANY LOT ON THIS PROJECT IS WITHIN AN INDICATED SPECIAL FLOOD HAZARD ZONE ACCORDING TO THE FEMA FIRM MAP NO. 48187C0095F EFFECTIVE DATE 9/2/2009.

**CAUTION!!**

CONTRACTOR SHALL BE REQUIRED TO LOCATE ALL PUBLIC OR PRIVATE UTILITIES INCLUDING BUT NOT LIMITING TO: WATER, SEWER, TELEPHONE AND FIBER OPTIC LINES, SITE LIGHTING ELECTRIC, SECONDARY ELECTRIC, PRIMARY ELECTRICAL, DUCTS, IRRIGATION FACILITIES, AND GAS LINES. ANY UTILITY CONFLICTS THAT ARISE SHOULD BE COMMUNICATED TO THE ENGINEER IMMEDIATELY AND PRIOR TO CONSTRUCTION. THE CONTRACTOR SHALL CONTACT "TEXAS 811" A MINIMUM OF 48 HOURS PRIOR TO THE START OF CONSTRUCTION. ANY DAMAGE TO EXISTING UTILITIES SHALL BE THE SOLE RESPONSIBILITY OF THE CONTRACTOR AND THE REPAIR SHALL BE AT CONTRACTOR'S SOLE EXPENSE WHETHER THE UTILITY IS SHOWN ON THESE PLANS OR NOT.

**TRENCH EXCAVATION SAFETY PROTECTION:**

CONTRACTOR AND/OR CONTRACTOR'S INDEPENDENTLY RETAINED EMPLOYEE OR STRUCTURAL DESIGN/ GEOTECHNICAL/ SAFETY/EQUIPMENT CONSULTANT, IF ANY, SHALL REVIEW THESE PLANS AND ANY AVAILABLE GEOTECHNICAL INFORMATION AND THE ANTICIPATED INSTALLATION SITES WITHIN THE PROJECT WORK AREA IN ORDER TO IMPLEMENT CONTRACTOR'S TRENCH EXCAVATION SAFETY PROTECTION SYSTEMS, PROGRAMS AND /OR PROCEDURES FOR THE PROJECT DESCRIBED IN THE CONTRACT DOCUMENTS. THE CONTRACTOR'S IMPLEMENTATION OF THESE SYSTEMS, PROGRAMS AND/OR PROCEDURES SHALL PROVIDE FOR ADEQUATE TRENCH EXCAVATION SAFETY PROTECTION THAT COMPLY WITH AS A MINIMUM, OSHA STANDARDS FOR TRENCH EXCAVATIONS. SPECIFICALLY, CONTRACTOR AND/OR CONTRACTOR'S INDEPENDENTLY RETAINED EMPLOYEE OR SAFETY CONSULTANT SHALL IMPLEMENT A TRENCH SAFETY PROGRAM IN ACCORDANCE WITH OSHA STANDARDS GOVERNING THE PRESENCE AND ACTIVITIES OF INDIVIDUALS WORKING IN AND AROUND TRENCH EXCAVATION.

DATE	
NO.	REVISION
11-20-2023	

**PAPE-DAWSON ENGINEERS**  
1672 INTERMEDIC DR, STE 102 | NEW BRAUNFELS, TX 78121 | 800.632.5693  
TEXAS ENGINEERING FIRM #470 | TEXAS SURVEYING FIRM #1008800

**VERAMENDI PRECINCT 18 UNIT 1**  
NEW BRAUNFELS, TEXAS  
**SANITARY SEWER LINE G - PLAN & PROFILE**  
STA 9+50.00 TO 16+00.00

JOB NO.	30001-66
DATE	07-03-2023
DESIGNER	GDL
CHECKED	BY
SHEET	C5.17

**FOR PERMIT**



**CITY OF NEW BRAUNFELS NOTES**

- NO VALVES, HYDRANTS, ETC. SHALL BE CONSTRUCTED WITHIN CURBS, SIDEWALKS, OR DRIVEWAYS.
- ALL UTILITIES TO BE CONSTRUCTED PRIOR TO STREETS.
- THIS PROJECT INCLUDES UTILITY INSTALLATIONS GREATER THAN 5- FEET IN DEPTH. DEEP TRENCHES POSE COMPACTION TESTING AND CONSTRUCTION CHALLENGES AND CITY METHODS FOR TESTING AND COMPACTION MAY NOT BE ACHIEVABLE. A UTILITY COMPACTION PLAN WILL BE REQUIRED AND MUST BE SUBMITTED FOR APPROVAL TO CITY PRIOR TO UTILITY INSTALLATION.
- UTILITY TRENCH COMPACTION - ALL UTILITY TRENCH COMPACTION TESTS WITHIN THE STREET PAVEMENT/SIDEWALK SECTION SHALL BE THE RESPONSIBILITY OF THE DEVELOPER'S GEOTECHNICAL ENGINEER. FILL MATERIAL SHALL BE PLACED IN UNIFORM LAYERS NOT TO EXCEED TWELVE INCHES (12") THICK. DETERMINE THE MAXIMUM LIFT THICKNESS BASED ON THE ABILITY OF THE COMPACTION OPERATION AND EQUIPMENT USED TO MEET THE REQUIRED DENSITY. EACH LAYER OF MATERIAL SHALL BE COMPACTED TO A MINIMUM 95% DENSITY AND TESTED FOR DENSITY AND MOISTURE IN ACCORDANCE WITH TEST METHODS TEX-113-E, TEX-114-E, TEX-115-E. THE NUMBER AND LOCATION OF REQUIRED TESTS SHALL BE DETERMINED BY THE GEOTECHNICAL ENGINEER AND APPROVED BY THE CITY OF NEW BRAUNFELS STREET INSPECTOR. AT A MINIMUM, TESTS SHALL BE TAKEN EVERY 200 LF FOR EACH LIFT AND EVERY OTHER SERVICE LINE. UPON COMPLETION OF TESTING THE GEOTECHNICAL ENGINEER SHALL PROVIDE THE CITY OF NEW BRAUNFELS STREET INSPECTOR WITH ALL TESTING DOCUMENTATION AND A CERTIFICATION STATING THAT THE PLACEMENT OF FILL MATERIAL HAS BEEN COMPLETED IN ACCORDANCE WITH THE PLANS. ADDITIONAL DENSITY TESTS MAY BE REQUESTED BY THE CITY OF NEW BRAUNFELS INSPECTOR.

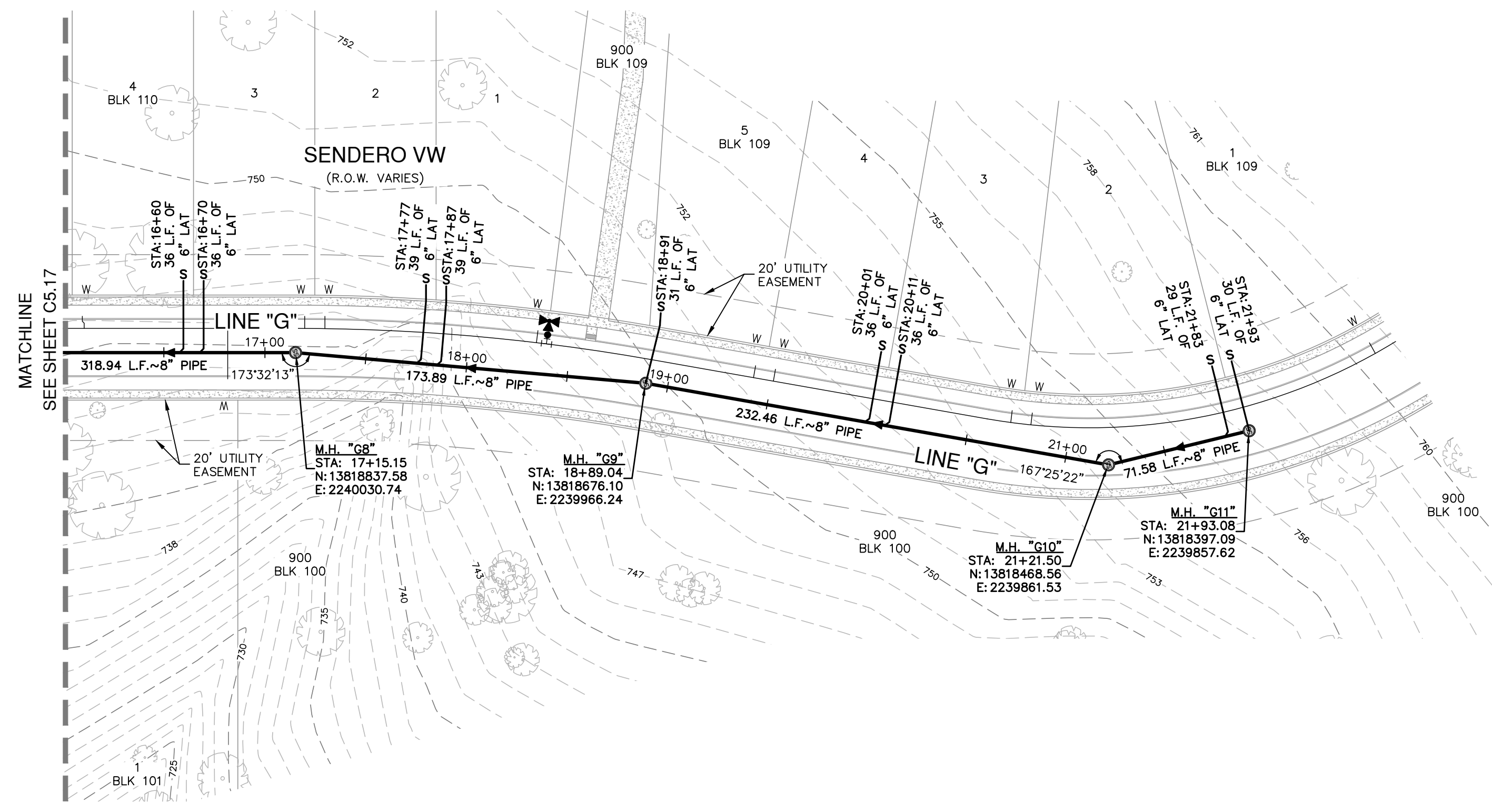
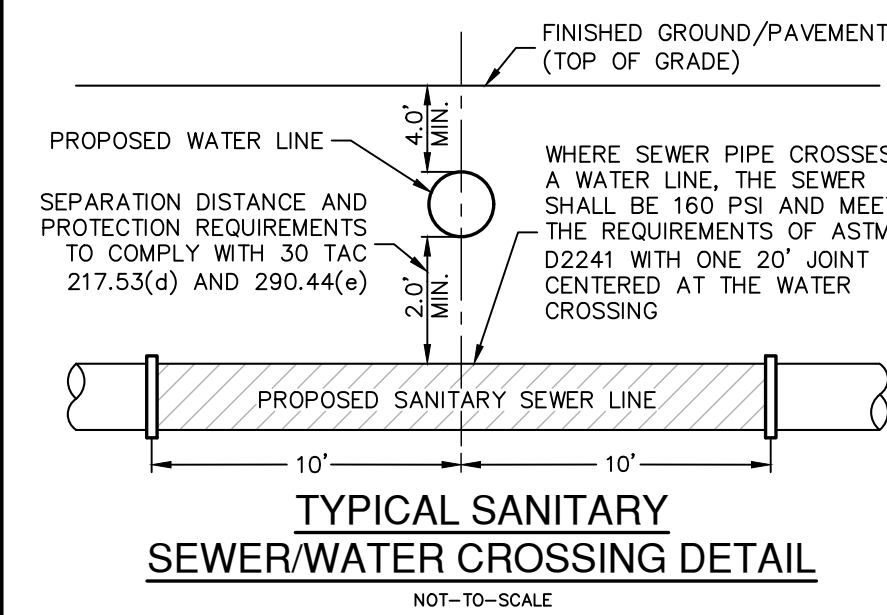
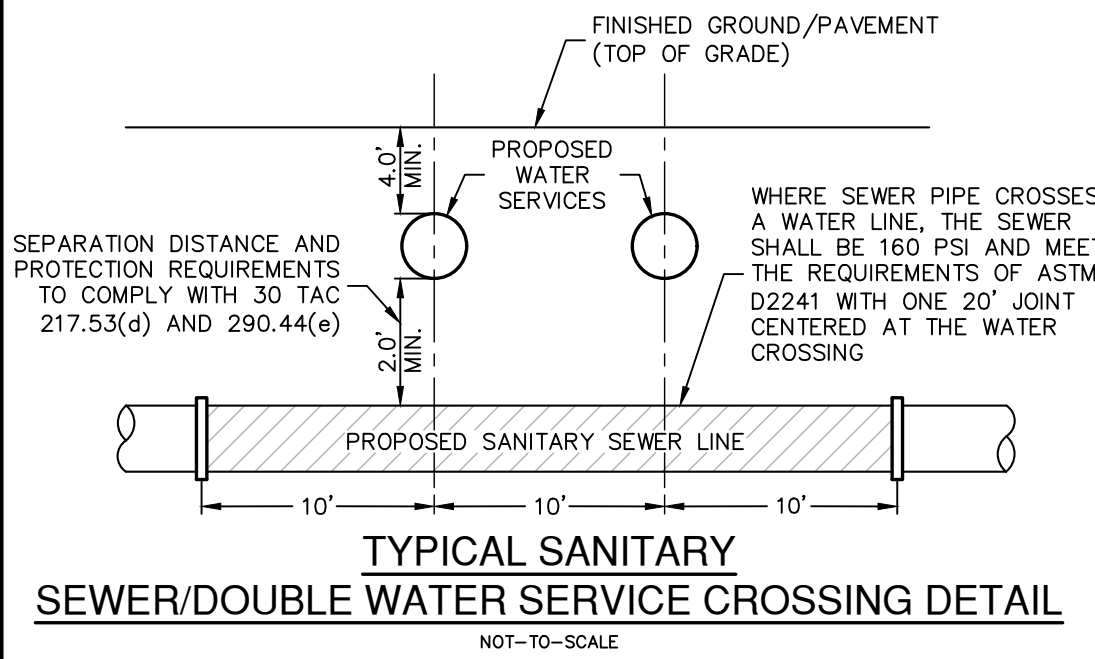

**SANITARY SEWER LINE "G"**  
STA 16+00.00 TO 21+30.25  
VERTICAL SCALE: 1" = 5'  
HORIZONTAL SCALE: 1" = 50'

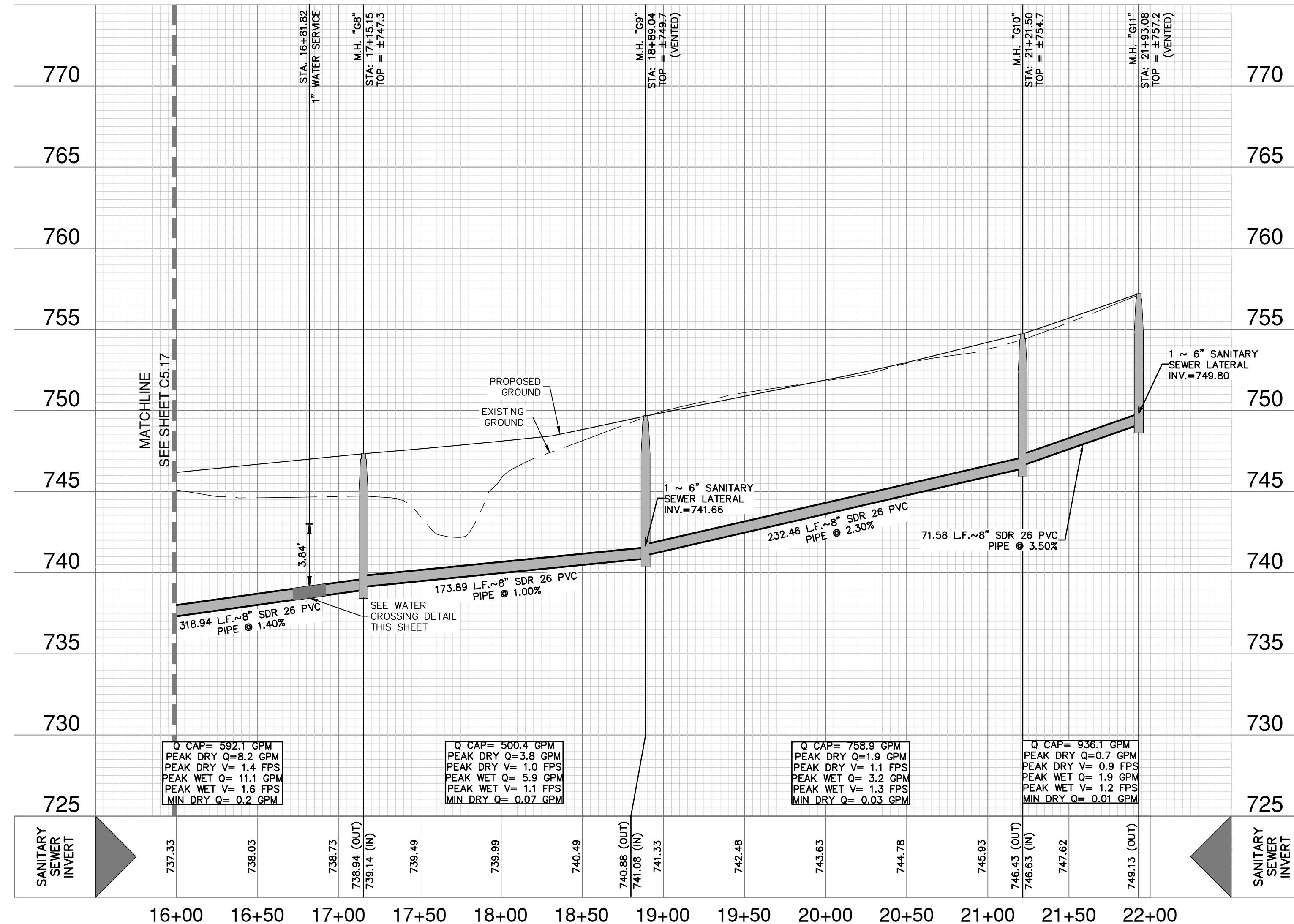

**SEWER LEGEND**

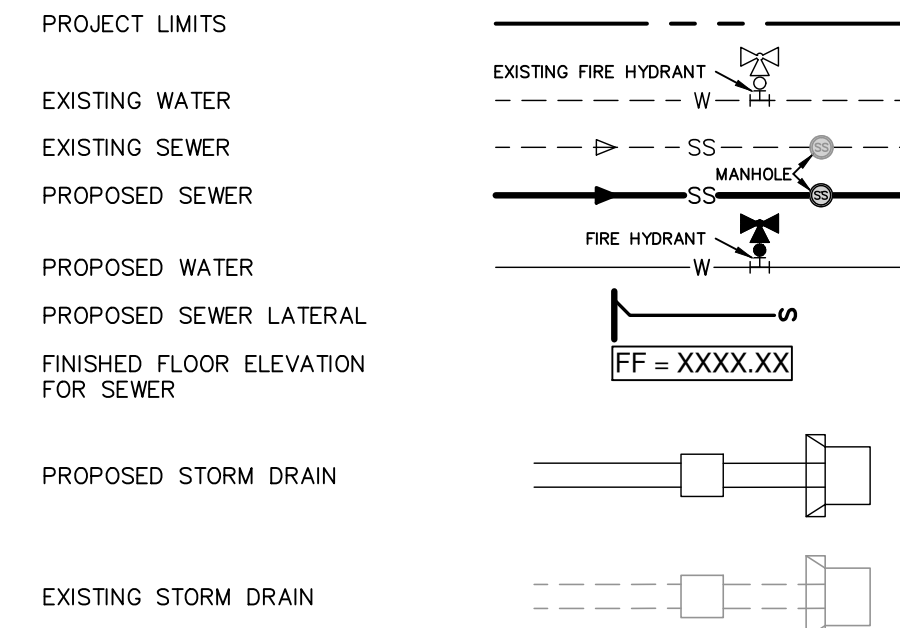

**NOTES**

- SEWER PIPE WHERE WATER LINE CROSSES SHALL BE 160 P.S.I. AND MEET THE REQUIREMENTS OF ASTM D2241 WITH ONE 20' JOINT CENTERED AT WATER MAIN.
- NO VERTICAL STACKS ALLOWED FOR ANY LOTS UNLESS OTHERWISE SPECIFIED BY THE ENGINEER.
- WHEN HORIZONTAL DISTANCE BETWEEN SEWER PIPES AND WATER MAIN IS LESS THAN 9 FOOT SEPARATION, SEWER MAIN SHALL BE INSTALLED WITH 150 PSI (MIN) PRESSURE PIPE AND FITTINGS IN ACCORDANCE WITH NBU'S WATER CONNECTION POLICY IN THE VICINITY OF WATER MAINS. (SEE SEWER NOTES SHEET C5.30)
- CONTRACTOR SHALL ENSURE THAT MANHOLES OUTSIDE OF PAVED AREAS ARE SET WITH TOP ELEVATIONS 2" ABOVE FINISHED GRADE WITH CONCRETE RING ENCASUREMENT. CONTRACTOR SHALL ENSURE THAT MANHOLES IN PAVED AREAS ARE SET TO MATCH TOP OF FINISHED GRADE.
- ALL SEWER PIPES SHALL BE 8" PVC (SDR 26), UNLESS OTHERWISE NOTED.
- CONTRACTOR IS TO VERIFY EXISTING INVERT OF SANITARY SEWER MAIN AND ALERT ENGINEER IMMEDIATELY OF ANY DIFFERENCE FROM INVERT SHOWN ON PLANS.
- CONTRACTOR SHALL PROTECT ALL EXISTING FENCES. ANY FENCE DAMAGED BY THE CONTRACTOR SHALL BE REPAIRED BY THE CONTRACTOR AT THEIR EXPENSE.
- THE CONTRACTOR WILL BE RESPONSIBLE FOR DETERMINING EXACT LOCATION OF ALL UTILITIES AND DRAINAGE STRUCTURES WHETHER SHOWN ON THE PLANS OR NOT. THE CONTRACTOR SHALL UNCOVER EXISTING UTILITIES PRIOR TO CONSTRUCTION TO VERIFY SIZE, GRADE, AND LOCATION. THE CONTRACTOR SHALL NOTIFY THE ENGINEER IMMEDIATELY OF ANY DEVIATIONS FROM PLANS PRIOR TO BEGINNING CONSTRUCTION. ANY DAMAGE TO EXISTING UTILITIES, WHETHER SHOWN ON THE PLANS OR NOT, SHALL BE THE CONTRACTOR'S RESPONSIBILITY TO REPAIR, AT HIS EXPENSE.
- SEE THIS SHEET FOR TYPICAL SANITARY SEWER/WATER CROSSING DETAIL.
- IF A CONFLICT EXISTS BETWEEN THE VARIOUS SUBMITTED DOCUMENTS (ENGINEERING CALCULATIONS, PROJECTED SPECIFICATIONS, PROJECTED PLANS, ADDENDUMS, ETC.), THE FOLLOWING DOCUMENTS TAKE PRECEDENCE: SPECIFICATIONS GOVERN OVER PLANS, SPECIAL CONDITIONS GOVERN OVER SPECIFICATIONS AND PLANS. ADDENDUMS TAKE PRECEDENCE OVER ALL.
- LAST 20 LF. OF 8" STUB-OUT SHALL BE CONSTRUCTED OF P.V.C. SDR 26 (160 P.S.I.) PRESSURE PIPE.
- ALL SEWER PIPE LATERALS SHALL BE SDR 26 (CLASS 160) PVC PIPE AND SHALL HAVE A MINIMUM SLOPE OF 2%.
- WASTEWATER LATERALS SHALL BE LAID WITH A MINIMUM OF 36 INCHES OF COVER.
- NEW MANHOLES MUST BE CONSTRUCTED OF OR LINED WITH A CORROSION RESISTANT MATERIAL WHERE NEW CONSTRUCTION CONNECTS TO AN EXISTING MANHOLE THAT IS NOT CONSTRUCTED OF A CORROSION RESISTANT MATERIAL. THE EXISTING MANHOLE MUST BE LINED WITH OR REPLACED WITH A CORROSION RESISTANT MATERIAL.
- 48" MANHOLES ARE REQUIRED FOR ALL MAINS UP TO 18" IN DIAMETER.

**NOTE:**  
FOR PAVEMENT DESIGN SECTION SEE GEOTECHNICAL ENGINEERING REPORT.

**FLOODPLAIN NOTE**

- NO PORTION OF ANY LOT ON THIS PROJECT IS WITHIN AN INDICATED SPECIAL FLOOD HAZARD ZONE ACCORDING TO THE FEMA FIRM MAP NO. 48187C0095F EFFECTIVE DATE 9/2/2009.

**CAUTION!!**

CONTRACTOR SHALL BE REQUIRED TO LOCATE ALL PUBLIC OR PRIVATE UTILITIES INCLUDING BUT NOT LIMITING TO: WATER, SEWER, TELEPHONE AND FIBER OPTIC LINES, SITE LIGHTING ELECTRIC, SECONDARY ELECTRIC, PRIMARY ELECTRICAL DUCTBANKS, LANDSCAPE IRRIGATION FACILITIES, AND GAS LINES. ANY UTILITY CONFLICTS THAT ARISE SHOULD BE COMMUNICATED TO THE ENGINEER IMMEDIATELY AND PRIOR TO CONSTRUCTION. THE CONTRACTOR SHALL CONTACT "TEXAS 811" A MINIMUM OF 48 HOURS PRIOR TO THE START OF CONSTRUCTION. ANY DAMAGE TO EXISTING UTILITIES SHALL BE THE SOLE RESPONSIBILITY OF THE CONTRACTOR AND THE REPAIR SHALL BE AT CONTRACTOR'S SOLE EXPENSE WHETHER THE UTILITY IS SHOWN ON THESE PLANS OR NOT.

**TRENCH EXCAVATION SAFETY PROTECTION:**

CONTRACTOR AND/OR CONTRACTOR'S INDEPENDENTLY RETAINED EMPLOYEE OR STRUCTURAL DESIGN/ GEOTECHNICAL/ SAFETY/EQUIPMENT CONSULTANT, IF ANY, SHALL REVIEW THESE PLANS AND ANY AVAILABLE GEOTECHNICAL INFORMATION AND THE ANTICIPATED INSTALLATION SITES WITHIN THE PROJECT WORK AREA IN ORDER TO IMPLEMENT CONTRACTOR'S TRENCH EXCAVATION SAFETY PROTECTION SYSTEMS, PROGRAMS AND /OR PROCEDURES FOR THE PROJECT DESCRIBED IN THE CONTRACT DOCUMENTS. THE CONTRACTOR'S IMPLEMENTATION OF THESE SYSTEMS, PROGRAMS AND/OR PROCEDURES SHALL PROVIDE FOR ADEQUATE TRENCH EXCAVATION SAFETY PROTECTION THAT COMPLY WITH AS A MINIMUM, OSHA STANDARDS FOR TRENCH EXCAVATIONS. SPECIFICALLY, CONTRACTOR AND/OR CONTRACTOR'S INDEPENDENTLY RETAINED EMPLOYEE OR SAFETY CONSULTANT SHALL IMPLEMENT A TRENCH SAFETY PROGRAM IN ACCORDANCE WITH OSHA STANDARDS GOVERNING THE PRESENCE AND ACTIVITIES OF INDIVIDUALS WORKING IN AND AROUND TRENCH EXCAVATION.

DATE: \_\_\_\_\_  
NO. REVISION: \_\_\_\_\_  
11-20-2023  
JOCELYN PEREZ  
98367  
PROFESSIONAL ENGINEER  
Texas  
Pape-Dawson Engineers

**PAPE-DAWSON ENGINEERS**  
1672 INDEPENDENCE DR, STE 102 | NEW BRAUNFELS, TX 78132 | 800.632.5683  
TEXAS SURVEYING FIRM #1008800

**VERAMENDI PRECINCT 18 UNIT 1**  
NEW BRAUNFELS, TEXAS  
**SANITARY SEWER LINE G - PLAN & PROFILE**  
STA 16+00.00 TO 21+30.25

JOB NO. 30001-66  
DATE 07-03-2023  
DESIGNER GDL  
CHECKED GDL  
DRAWN BH  
SHEET C5.18

**FOR PERMIT**

Date: Nov 20, 2023, 2:00pm User ID: D:\mch  
File: P:\3001\01\66\Design\Chal\SSG-30001-66.dwg

THIS DOCUMENT HAS BEEN PRODUCED FROM MATERIAL THAT WAS STORED AND/OR TRANSMITTED ELECTRONICALLY AND MAY HAVE BEEN INADVERTENTLY ALTERED. RELY ONLY ON FINAL HARDCOPY MATERIALS BEARING THE CONSULTANT'S ORIGINAL SIGNATURE AND SEAL. AERIAL IMAGERY PROVIDED BY GOOGLE/UNLESS OTHERWISE NOTED. Imagery © 2016, CAPOCO, Digital Globe, Texas Orthology Program, USDA Farm Service Agency.



**CITY OF NEW BRAUNFELS NOTES**

- NO VALVES, HYDRANTS, ETC. SHALL BE CONSTRUCTED WITHIN CURBS, SIDEWALKS, OR DRIVEWAYS.
- ALL UTILITIES TO BE CONSTRUCTED PRIOR TO STREETS.
- THIS PROJECT INCLUDES UTILITY INSTALLATIONS GREATER THAN 5- FEET IN DEPTH. DEEP TRENCHES POSE COMPACTION TESTING AND CONSTRUCTION CHALLENGES AND CITY METHODS FOR TESTING AND COMPACTION MAY NOT BE ACHIEVABLE. A UTILITY COMPACTION PLAN WILL BE REQUIRED AND MUST BE SUBMITTED FOR APPROVAL TO CITY PRIOR TO UTILITY INSTALLATION.
- UTILITY TRENCH COMPACTION - ALL UTILITY TRENCH COMPACTION TESTS WITHIN THE STREET PAVEMENT/SIDEWALK SECTION SHALL BE THE RESPONSIBILITY OF THE DEVELOPER'S GEOTECHNICAL ENGINEER. FILL MATERIAL SHALL BE PLACED IN UNIFORM LAYERS NOT TO EXCEED TWELVE INCHES (12") LOOSE. DETERMINE THE MAXIMUM LIFT THICKNESS BASED ON THE ABILITY OF THE COMPACTION OPERATION AND EQUIPMENT USED TO MEET THE REQUIRED DENSITY. EACH LAYER OF MATERIAL SHALL BE COMPACTED TO A MINIMUM 95% DENSITY AND TESTED FOR DENSITY AND MOISTURE IN ACCORDANCE WITH TEST METHODS TEX-113-E, TEX-114-E, TEX-115-E. THE NUMBER AND LOCATION OF REQUIRED TESTS SHALL BE DETERMINED BY THE GEOTECHNICAL ENGINEER AND APPROVED BY THE CITY OF NEW BRAUNFELS STREET INSPECTOR. AT A MINIMUM, TESTS SHALL BE TAKEN EVERY 200 LF FOR EACH LIFT AND EVERY OTHER SERVICE LINE. UPON COMPLETION OF TESTING THE GEOTECHNICAL ENGINEER SHALL PROVIDE THE CITY OF NEW BRAUNFELS STREET INSPECTOR WITH ALL TESTING DOCUMENTATION AND A CERTIFICATION STATING THAT THE PLACEMENT OF FILL MATERIAL HAS BEEN COMPLETED IN ACCORDANCE WITH THE PLANS. ADDITIONAL DENSITY TESTS MAY BE REQUESTED BY THE CITY OF NEW BRAUNFELS STREET INSPECTOR.

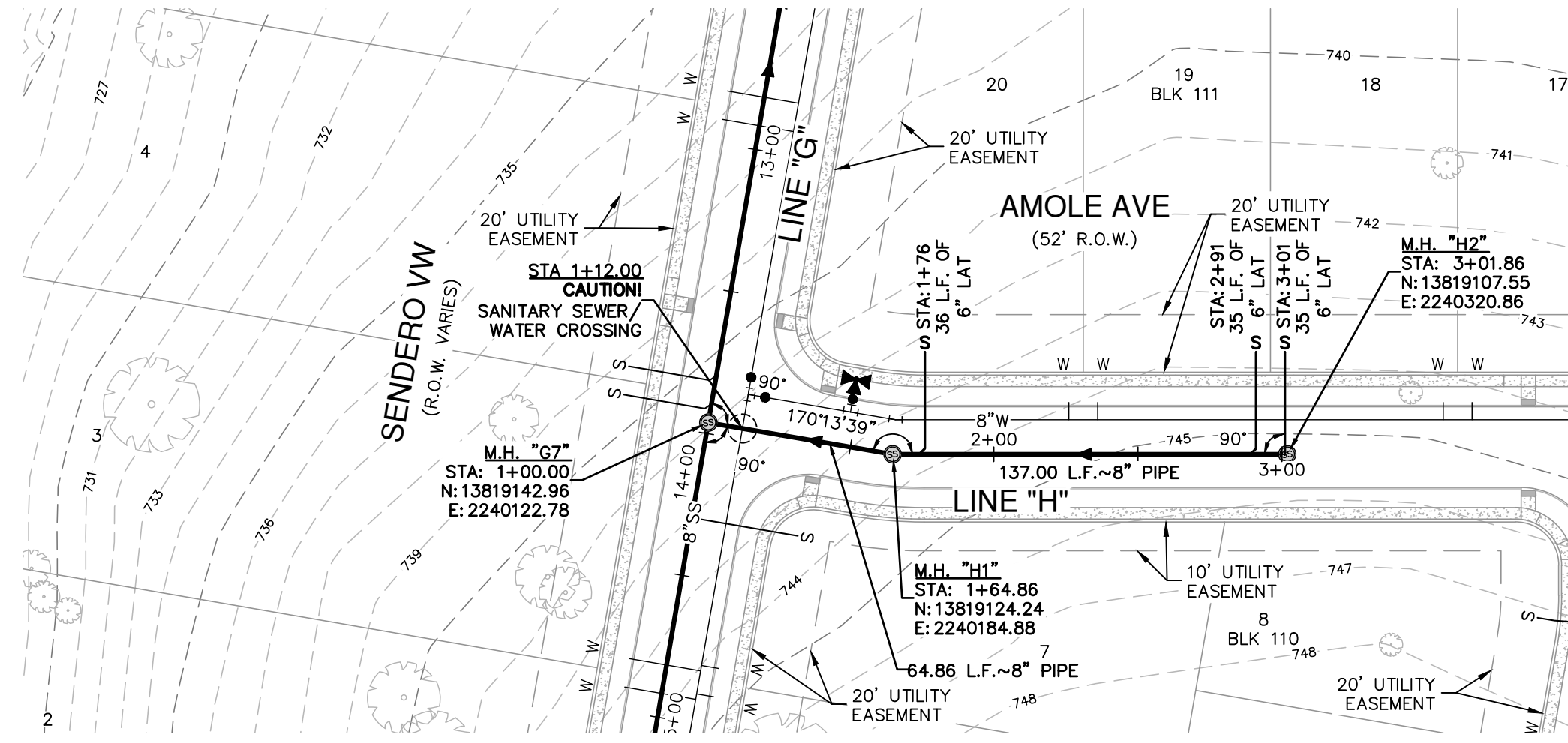
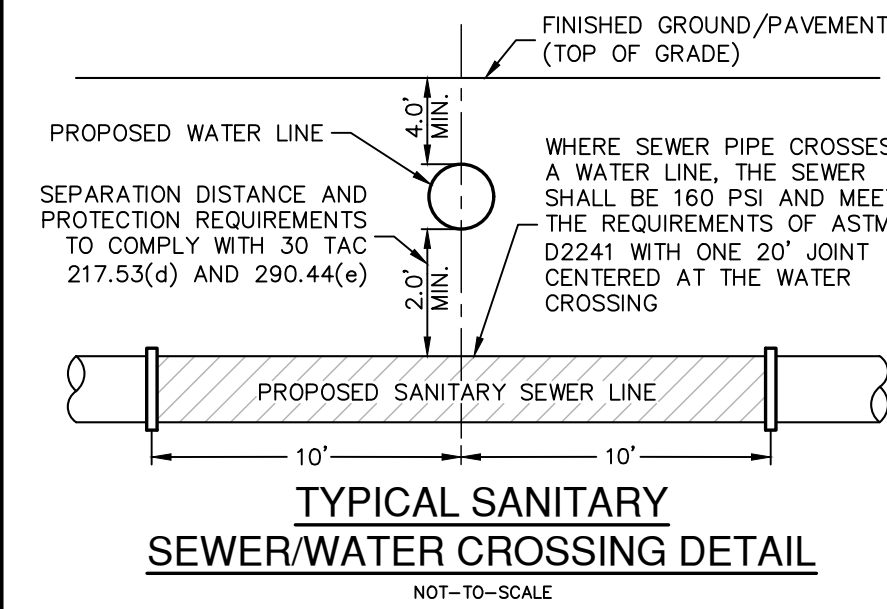

**SANITARY SEWER LINE "H"**  
STA. 1+00.00 TO 3+01.86  
VERTICAL SCALE: 1" = 5'  
HORIZONTAL SCALE: 1" = 50'

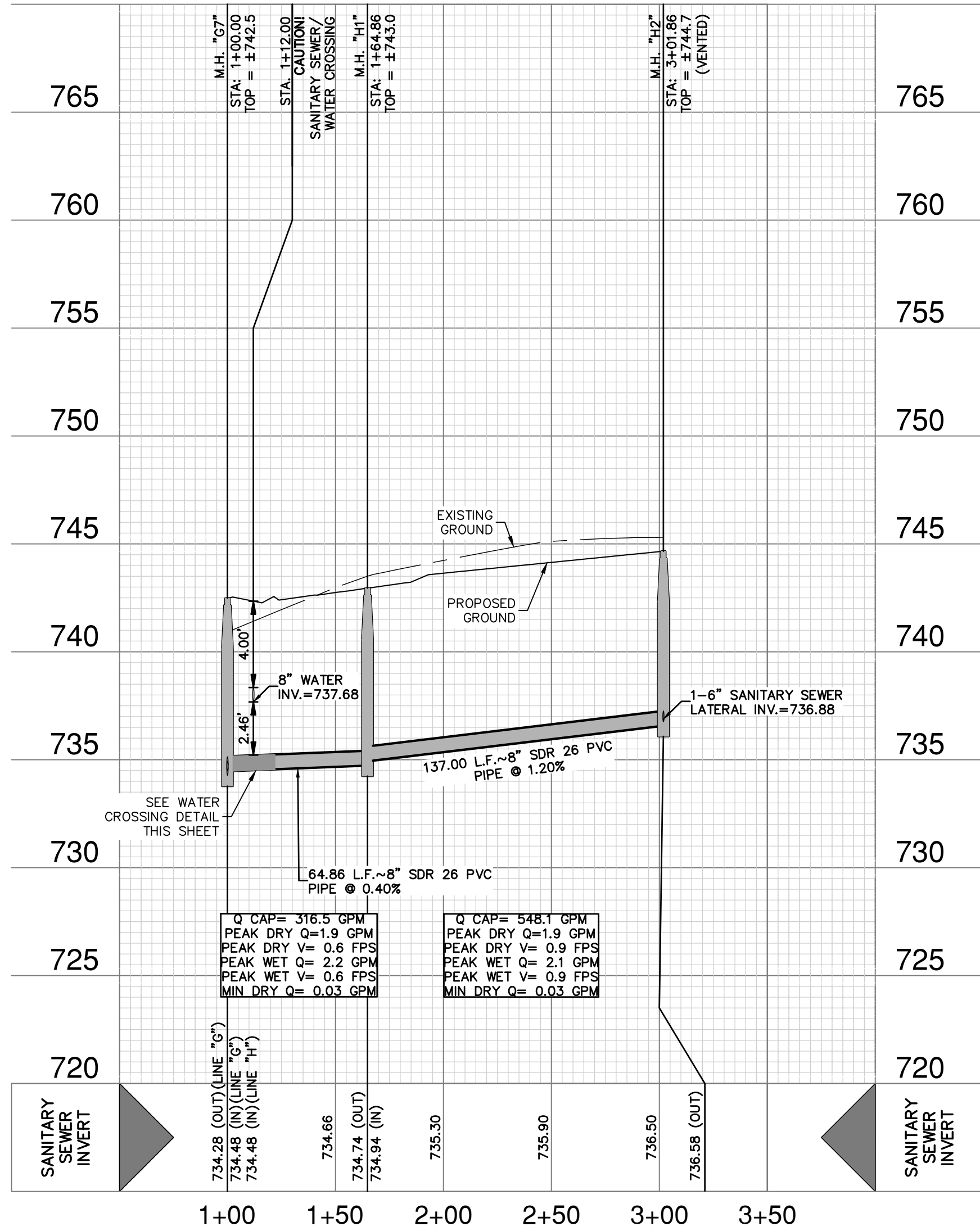

**SEWER LEGEND**

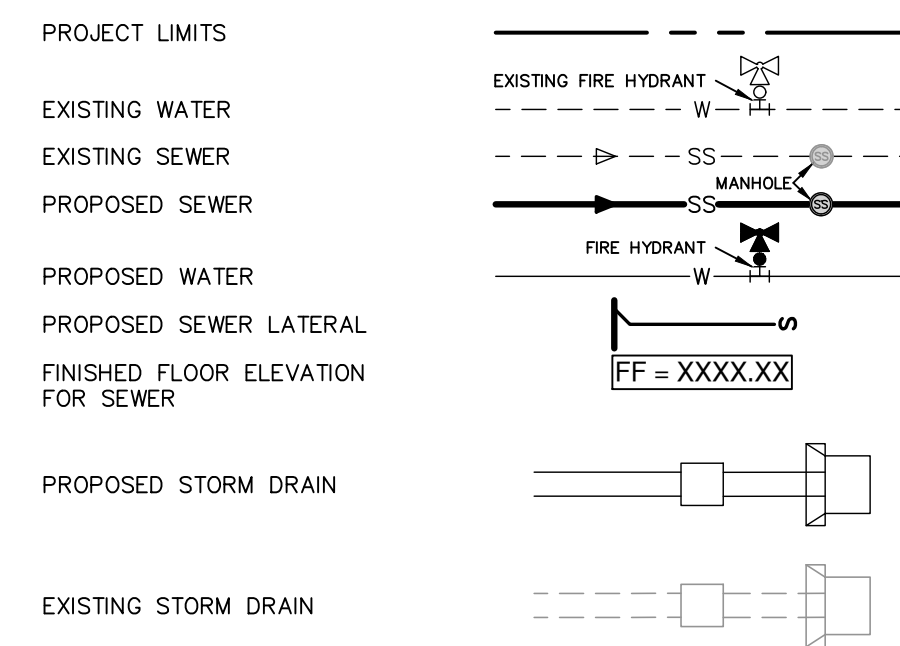

**NOTES**

- SEWER PIPE WHERE WATER LINE CROSSES SHALL BE 160 P.S.I. AND MEET THE REQUIREMENTS OF ASTM D2241 WITH ONE 20' JOINT CENTERED AT WATER MAIN.
- NO VERTICAL STACKS ALLOWED FOR ANY LOTS UNLESS OTHERWISE SPECIFIED BY THE ENGINEER.
- WHEN HORIZONTAL DISTANCE BETWEEN SEWER PIPES AND WATER MAIN IS LESS THAN 9 FOOT OF SEPARATION, SEWER MAIN SHALL BE INSTALLED WITH 150 PSI (MIN) PRESSURE PIPE AND FITTINGS IN ACCORDANCE WITH NBU'S WATER CONNECTION POLICY IN THE VICINITY OF WATER MAINS. (SEE SEWER NOTES SHEET C5.30)
- CONTRACTOR SHALL ENSURE THAT MANHOLES OUTSIDE OF PAVED AREAS ARE SET WITH TOP ELEVATIONS 2" ABOVE FINISHED GRADE WITH CONCRETE RING ENCASUREMENT. CONTRACTOR SHALL ENSURE THAT MANHOLES IN PAVED AREAS ARE SET TO MATCH TOP OF FINISHED GRADE.
- ALL SEWER PIPES SHALL BE 8" PVC (SDR 26), UNLESS OTHERWISE NOTED.
- CONTRACTOR IS TO VERIFY EXISTING INVERT OF SANITARY SEWER MAIN AND ALERT ENGINEER IMMEDIATELY OF ANY DIFFERENCE FROM INVERT SHOWN ON PLANS.
- CONTRACTOR SHALL PROTECT ALL EXISTING FENCES. ANY FENCE DAMAGED BY THE CONTRACTOR SHALL BE REPAIRED BY THE CONTRACTOR AT THEIR EXPENSE.
- THE CONTRACTOR WILL BE RESPONSIBLE FOR DETERMINING EXACT LOCATION OF ALL UTILITIES AND DRAINAGE STRUCTURES WHETHER SHOWN ON THE PLANS OR NOT. THE CONTRACTOR SHALL UNCOVER EXISTING UTILITIES PRIOR TO CONSTRUCTION TO VERIFY SIZE, GRADE, AND LOCATION. THE CONTRACTOR SHALL NOTIFY THE ENGINEER IMMEDIATELY OF ANY DEVIATIONS FROM PLANS PRIOR TO BEGINNING CONSTRUCTION. ANY DAMAGE TO EXISTING UTILITIES, WHETHER SHOWN ON THE PLANS OR NOT, SHALL BE THE CONTRACTOR'S RESPONSIBILITY TO REPAIR, AT HIS EXPENSE.
- SEE THIS SHEET FOR TYPICAL SANITARY SEWER/WATER CROSSING DETAIL.
- IF A CONFLICT EXISTS BETWEEN THE VARIOUS SUBMITTED DOCUMENTS (ENGINEERING CALCULATIONS, PROJECTED SPECIFICATIONS, PROJECTED PLANS, ADDENDUMS, ETC.), THE FOLLOWING DOCUMENTS TAKE PRECEDENCE: SPECIFICATIONS GOVERN OVER PLANS, SPECIAL CONDITIONS GOVERN OVER SPECIFICATIONS AND PLANS. ADDENDUMS TAKE PRECEDENCE OVER ALL.
- LAST 20 LF. OF 8" STUB-OUT SHALL BE CONSTRUCTED OF P.V.C. SDR 26 (160 P.S.I.) PRESSURE PIPE.
- ALL SEWER PIPE LATERALS SHALL BE SDR 26 (CLASS 160) PVC PIPE AND SHALL HAVE A MINIMUM SLOPE OF 2%.
- WASTEWATER LATERALS SHALL BE LAID WITH A MINIMUM OF 36 INCHES OF COVER.
- NEW MANHOLES MUST BE CONSTRUCTED OF OR LINED WITH A CORROSION RESISTANT MATERIAL. WHERE NEW CONSTRUCTION CONNECTS TO AN EXISTING MANHOLE THAT IS NOT CONSTRUCTED OF A CORROSION RESISTANT MATERIAL, THE EXISTING MANHOLE MUST BE LINED WITH OR REPLACED WITH A CORROSION RESISTANT MATERIAL.
- 48" MANHOLES ARE REQUIRED FOR ALL MAINS UP TO 18" IN DIAMETER.

**NOTE:**  
FOR PAVEMENT DESIGN SECTION SEE GEOTECHNICAL ENGINEERING REPORT.

**FLOODPLAIN NOTE**

- NO PORTION OF ANY LOT ON THIS PROJECT IS WITHIN AN INDICATED SPECIAL FLOOD HAZARD ZONE ACCORDING TO THE FEMA FIRM MAP NO. 48187C0095F EFFECTIVE DATE 9/2/2009.

**CAUTION!!**

CONTRACTOR SHALL BE REQUIRED TO LOCATE ALL PUBLIC OR PRIVATE UTILITIES INCLUDING BUT NOT LIMITING TO: WATER, SEWER, TELEPHONE AND FIBER OPTIC LINES, SITE LIGHTING ELECTRIC, SECONDARY ELECTRIC, PRIMARY ELECTRICAL, DUCT/IRRIAGATION FACILITIES, AND GAS LINES. ANY UTILITY CONFLICTS THAT ARISE SHOULD BE COMMUNICATED TO THE ENGINEER IMMEDIATELY AND PRIOR TO CONSTRUCTION. THE CONTRACTOR SHALL CONTACT "TEXAS 811" A MINIMUM OF 48 HOURS PRIOR TO THE START OF CONSTRUCTION. ANY DAMAGE TO EXISTING UTILITIES SHALL BE THE SOLE RESPONSIBILITY OF THE CONTRACTOR AND THE REPAIR SHALL BE AT CONTRACTOR'S SOLE EXPENSE WHETHER THE UTILITY IS SHOWN ON THESE PLANS OR NOT.

**TRENCH EXCAVATION SAFETY PROTECTION:**

CONTRACTOR AND/OR CONTRACTOR'S INDEPENDENTLY RETAINED EMPLOYEE OR STRUCTURAL DESIGN/ GEOTECHNICAL/ SAFETY/EQUIPMENT CONSULTANT, IF ANY, SHALL REVIEW THESE PLANS AND ANY AVAILABLE GEOTECHNICAL INFORMATION AND THE ANTICIPATED INSTALLATION SITES WITHIN THE PROJECT WORK AREA IN ORDER TO IMPLEMENT CONTRACTOR'S TRENCH EXCAVATION SAFETY PROTECTION SYSTEMS, PROGRAMS AND /OR PROCEDURES FOR THE PROJECT DESCRIBED IN THE CONTRACT DOCUMENTS. THE CONTRACTOR'S IMPLEMENTATION OF THESE SYSTEMS, PROGRAMS AND/OR PROCEDURES SHALL PROVIDE FOR ADEQUATE TRENCH EXCAVATION SAFETY PROTECTION THAT COMPLY WITH AS A MINIMUM, OSHA STANDARDS FOR TRENCH EXCAVATIONS. SPECIFICALLY, CONTRACTOR AND/OR CONTRACTOR'S INDEPENDENTLY RETAINED EMPLOYEE OR SAFETY CONSULTANT SHALL IMPLEMENT A TRENCH SAFETY PROGRAM IN ACCORDANCE WITH OSHA STANDARDS GOVERNING THE PRESENCE AND ACTIVITIES OF INDIVIDUALS WORKING IN AND AROUND TRENCH EXCAVATION.

DATE: \_\_\_\_\_

NO. REVISION: \_\_\_\_\_

11-20-2023

Jocelyn Perez  
Professional Engineer  
98367

**PAPE-DAWSON ENGINEERS**

1672 INDEPENDENCE DR, STE 102 | NEW BRAUNFELS, TX 78132 | 800.632.5693  
TEXAS ENGINEERING FIRM #470 | TEXAS SURVEYING FIRM #1008800

**VERAMENDI PRECINCT 18 UNIT 1**  
NEW BRAUNFELS, TEXAS

**SANITARY SEWER LINE H - PLAN & PROFILE**  
STA. 1+00.00 TO 3+01.86

PLAT NO. \_\_\_\_\_

JOB NO. 30001-66

DATE 07-03-2023

DESIGNER GDL

CHECKED [initials] DRAWN BH

SHEET C5.19

**FOR PERMIT**



**CITY OF NEW BRAUNFELS NOTES**

- NO VALVES, HYDRANTS, ETC. SHALL BE CONSTRUCTED WITHIN CURBS, SIDEWALKS, OR DRIVEWAYS.
- ALL UTILITIES TO BE CONSTRUCTED PRIOR TO STREETS.
- THIS PROJECT INCLUDES UTILITY INSTALLATIONS GREATER THAN 5- FEET IN DEPTH. DEEP TRENCHES POSE COMPACTION TESTING AND CONSTRUCTION CHALLENGES AND CITY METHODS FOR TESTING AND COMPACTION MAY NOT BE ACHIEVABLE. A UTILITY COMPACTION PLAN WILL BE REQUIRED AND MUST BE SUBMITTED FOR APPROVAL TO CITY PRIOR TO UTILITY INSTALLATION.
- UTILITY TRENCH COMPACTION - ALL UTILITY TRENCH COMPACTION TESTS WITHIN THE STREET PAVEMENT/SIDEWALK SECTION SHALL BE THE RESPONSIBILITY OF THE DEVELOPER'S GEOTECHNICAL ENGINEER. FILL MATERIAL SHALL BE PLACED IN UNIFORM LAYERS NOT TO EXCEED TWELVE INCHES (12") LOOSE. DETERMINE THE MAXIMUM LIFT THICKNESS BASED ON THE ABILITY OF THE COMPACTION OPERATION AND EQUIPMENT USED TO MEET THE REQUIRED DENSITY. EACH LAYER OF MATERIAL SHALL BE COMPACTED TO A MINIMUM 95% DENSITY AND TESTED FOR DENSITY AND MOISTURE IN ACCORDANCE WITH TEST METHODS TEX-113-E, TEX-114-E, TEX-115-E, E. THE NUMBER AND LOCATION OF REQUIRED TESTS SHALL BE DETERMINED BY THE GEOTECHNICAL ENGINEER AND APPROVED BY THE CITY OF NEW BRAUNFELS STREET INSPECTOR. AT A MINIMUM, TESTS SHALL BE TAKEN EVERY 200 LF FOR EACH LIFT AND EVERY OTHER SERVICE LINE. UPON COMPLETION OF TESTING THE GEOTECHNICAL ENGINEER SHALL PROVIDE THE CITY OF NEW BRAUNFELS STREET INSPECTOR WITH ALL TESTING DOCUMENTATION AND A CERTIFICATION STATING THAT THE PLACEMENT OF FILL MATERIAL HAS BEEN COMPLETED IN ACCORDANCE WITH THE PLANS. ADDITIONAL DENSITY TESTS MAY BE REQUESTED BY THE CITY OF NEW BRAUNFELS STREET INSPECTOR.

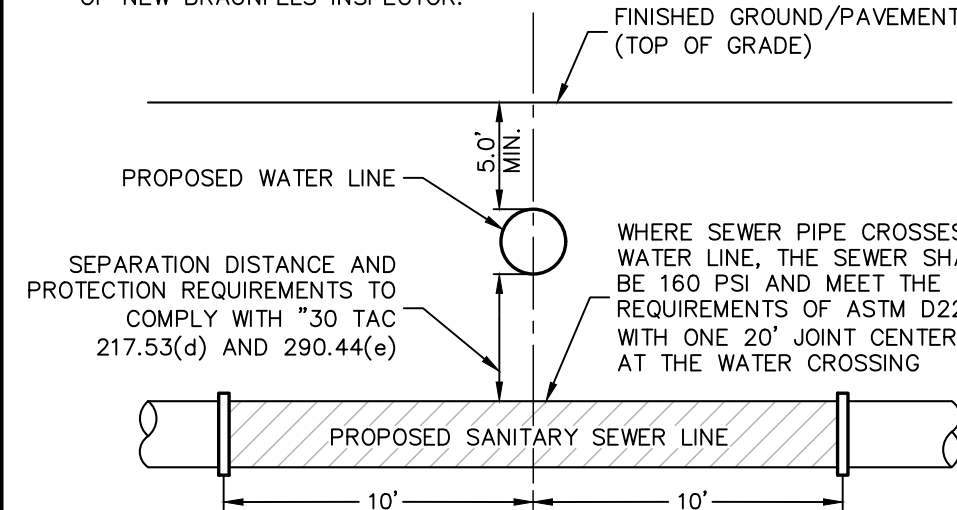

**TYPICAL SANITARY SEWER/WATER CROSSING DETAIL**  
NOT TO SCALE

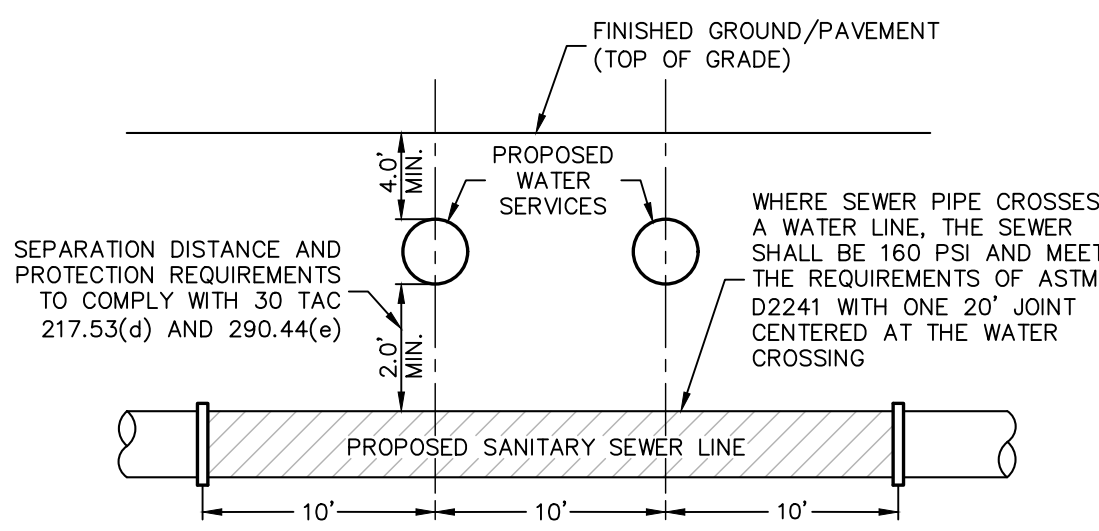

**TYPICAL SANITARY SEWER/DOUBLE WATER SERVICE CROSSING DETAIL**  
NOT TO SCALE

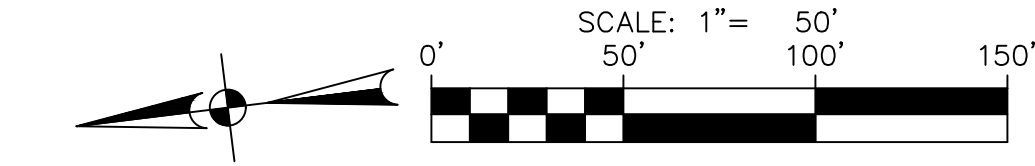

**SEWER LEGEND**

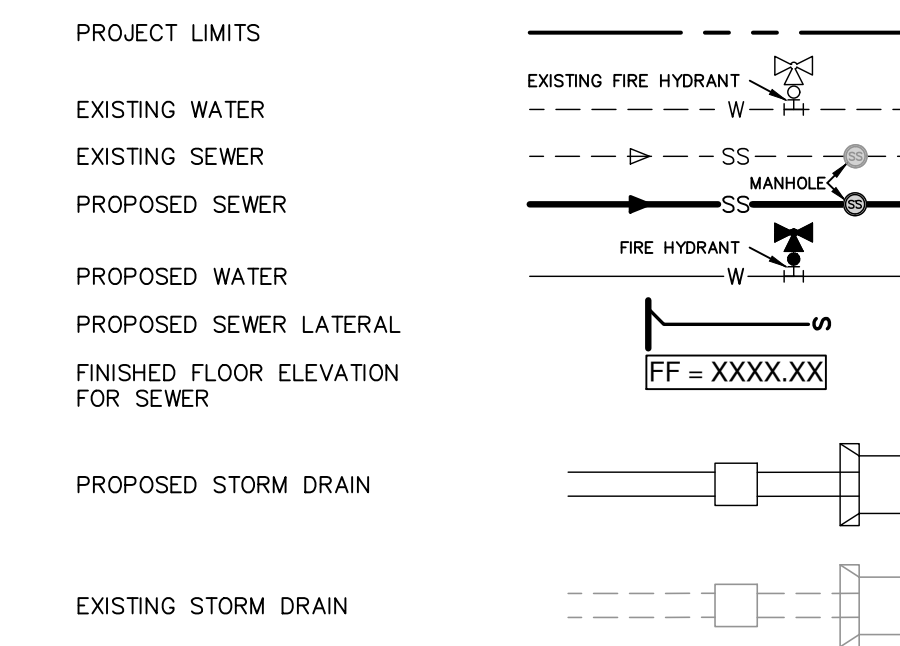

**NOTES**

- SEWER PIPE WHERE WATER LINE CROSSES SHALL BE 160 P.S.I. AND MEET THE REQUIREMENTS OF ASTM D2241 WITH ONE 20' JOINT CENTERED AT WATER MAIN.
- NO VERTICAL STACKS ALLOWED FOR ANY LOTS UNLESS OTHERWISE SPECIFIED BY THE ENGINEER.
- WHEN HORIZONTAL DISTANCE BETWEEN SEWER PIPES AND WATER MAIN IS LESS THAN 9 FOOT SEPARATION, SEWER MAIN SHALL BE INSTALLED WITH 150 PSI (MIN) PRESSURE PIPE AND FITTINGS IN ACCORDANCE WITH NBU'S WATER CONNECTION POLICY IN THE VICINITY OF WATER MAINS. (SEE SEWER NOTES SHEET C5.30)
- CONTRACTOR SHALL ENSURE THAT MANHOLES OUTSIDE OF PAVED AREAS ARE SET WITH TOP ELEVATIONS 2' ABOVE FINISHED GRADE WITH CONCRETE RING ENGAGEMENT. CONTRACTOR SHALL ENSURE THAT MANHOLES IN PAVED AREAS ARE SET TO MATCH TOP OF FINISHED GRADE.
- ALL SEWER PIPES SHALL BE 8" PVC (SDR 26), UNLESS OTHERWISE NOTED.
- CONTRACTOR IS TO VERIFY EXISTING INVERT OF SANITARY SEWER MAIN AND ALERT ENGINEER IMMEDIATELY OF ANY DIFFERENCE FROM INVERT SHOWN ON PLANS.
- CONTRACTOR SHALL PROTECT ALL EXISTING FENCES. ANY FENCE DAMAGED BY THE CONTRACTOR SHALL BE REPAIRED BY THE CONTRACTOR AT THEIR EXPENSE.
- THE CONTRACTOR WILL BE RESPONSIBLE FOR DETERMINING EXACT LOCATION OF ALL UTILITIES AND DRAINAGE STRUCTURES WHETHER SHOWN ON THE PLANS OR NOT. THE CONTRACTOR SHALL UNCOVER EXISTING UTILITIES PRIOR TO CONSTRUCTION TO VERIFY SIZE, GRADE, AND LOCATION. THE CONTRACTOR SHALL NOTIFY THE ENGINEER IMMEDIATELY OF ANY DEVIATIONS FROM PLANS PRIOR TO BEGINNING CONSTRUCTION. ANY DAMAGE TO EXISTING UTILITIES, WHETHER SHOWN ON THE PLANS OR NOT, SHALL BE THE CONTRACTOR'S RESPONSIBILITY TO REPAIR, AT HIS EXPENSE.
- SEE THIS SHEET FOR TYPICAL SANITARY SEWER/WATER CROSSING DETAIL.
- IF A CONFLICT EXISTS BETWEEN THE VARIOUS SUBMITTED DOCUMENTS (ENGINEERING CALCULATIONS, PROJECTED SPECIFICATIONS, PROJECTED PLANS, ADDENDUMS, ETC.), THE FOLLOWING DOCUMENTS TAKE PRECEDENCE: SPECIFICATIONS GOVERN OVER PLANS, SPECIAL CONDITIONS GOVERN OVER SPECIFICATIONS AND PLANS. ADDENDUMS TAKE PRECEDENCE OVER ALL.
- LAST 20 LF. OF 8" STUB-OUT SHALL BE CONSTRUCTED OF P.V.C. SDR 26 (160 P.S.I.) PRESSURE PIPE.
- ALL SEWER PIPE LATERALS SHALL BE SDR 26 (CLASS 160) PVC PIPE AND SHALL HAVE A MINIMUM SLOPE OF 2%.
- WASTEWATER LATERALS SHALL BE LAID WITH A MINIMUM OF 36 INCHES OF COVER.
- NEW MANHOLES MUST BE CONSTRUCTED OF OR LINED WITH A CORROSION RESISTANT MATERIAL WHERE NEW CONSTRUCTION CONNECTS TO AN EXISTING MANHOLE THAT IS NOT CONSTRUCTED OF A CORROSION RESISTANT MATERIAL. THE EXISTING MANHOLE MUST BE LINED WITH OR REPLACED WITH A CORROSION RESISTANT MATERIAL.
- 48" MANHOLES ARE REQUIRED FOR ALL MAINS UP TO 18" IN DIAMETER.

**FLOODPLAIN NOTE**

- NO PORTION OF ANY LOT ON THIS PROJECT IS WITHIN AN INDICATED SPECIAL FLOOD HAZARD ZONE ACCORDING TO THE FEMA FIRM MAP NO. 48187C0095F EFFECTIVE DATE 9/2/2009.

**CAUTION!!**

CONTRACTOR SHALL BE REQUIRED TO LOCATE ALL PUBLIC OR PRIVATE UTILITIES INCLUDING BUT NOT LIMITING TO: WATER, SEWER, TELEPHONE AND FIBER OPTIC LINES, SITE LIGHTING ELECTRIC, SECONDARY ELECTRIC, PRIMARY ELECTRICAL, DUCTBANKS, IRRIGATION FACILITIES, AND GAS LINES. ANY UTILITY CONFLICTS THAT ARISE SHOULD BE COMMUNICATED TO THE ENGINEER IMMEDIATELY AND PRIOR TO CONSTRUCTION. THE CONTRACTOR SHALL CONTACT "TEXAS 811" A MINIMUM OF 48 HOURS PRIOR TO THE START OF CONSTRUCTION. ANY DAMAGE TO EXISTING UTILITIES SHALL BE THE SOLE RESPONSIBILITY OF THE CONTRACTOR AND THE REPAIR SHALL BE AT CONTRACTOR'S SOLE EXPENSE WHETHER THE UTILITY IS SHOWN ON THESE PLANS OR NOT.

**TRENCH EXCAVATION SAFETY PROTECTION:**

CONTRACTOR AND/OR CONTRACTOR'S INDEPENDENTLY RETAINED EMPLOYEE OR STRUCTURAL DESIGN/ GEOTECHNICAL/ SAFETY/EQUIPMENT CONSULTANT, IF ANY, SHALL REVIEW THESE PLANS AND ANY AVAILABLE GEOTECHNICAL INFORMATION AND THE ANTICIPATED INSTALLATION SITES WITHIN THE PROJECT WORK AREA IN ORDER TO IMPLEMENT CONTRACTOR'S TRENCH EXCAVATION SAFETY PROTECTION SYSTEMS, PROGRAMS AND /OR PROCEDURES FOR THE PROJECT DESCRIBED IN THE CONTRACT DOCUMENTS. THE CONTRACTOR'S IMPLEMENTATION OF THESE SYSTEMS, PROGRAMS AND/OR PROCEDURES SHALL PROVIDE FOR ADEQUATE TRENCH EXCAVATION SAFETY PROTECTION THAT COMPLY WITH AS A MINIMUM, OSHA STANDARDS FOR TRENCH EXCAVATIONS. SPECIFICALLY, CONTRACTOR AND/OR CONTRACTOR'S INDEPENDENTLY RETAINED EMPLOYEE OR SAFETY CONSULTANT SHALL IMPLEMENT A TRENCH SAFETY PROGRAM IN ACCORDANCE WITH OSHA STANDARDS GOVERNING THE PRESENCE AND ACTIVITIES OF INDIVIDUALS WORKING IN AND AROUND TRENCH EXCAVATION.

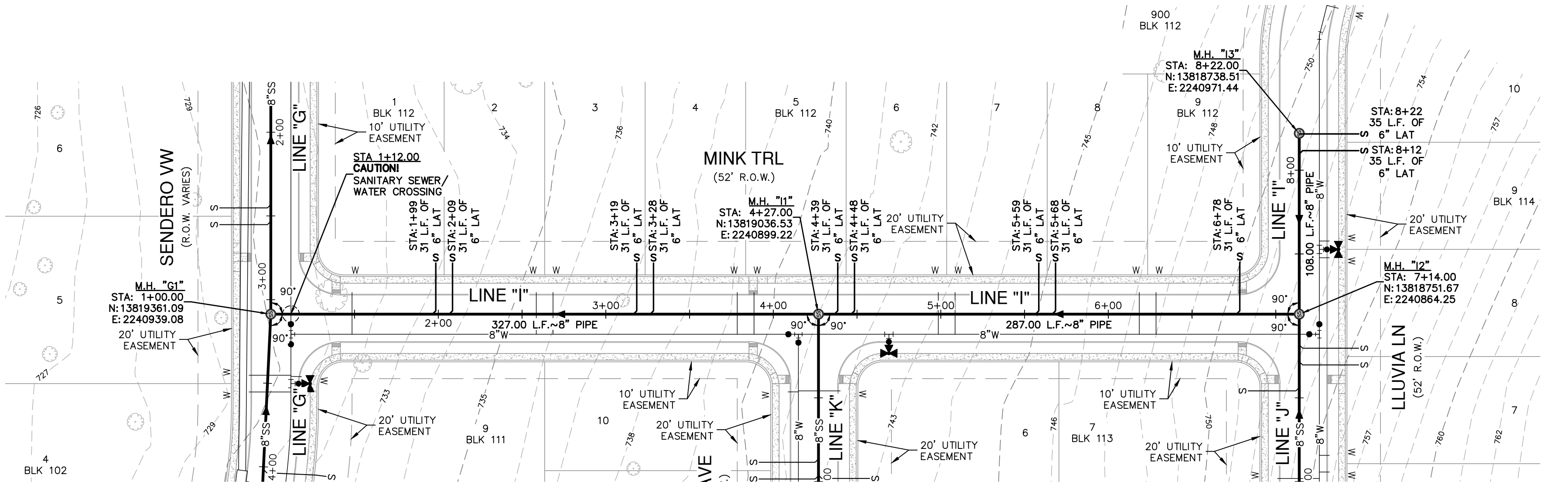

**SANITARY SEWER LINE "I"**  
STA 1+00.00 TO 8+22.00

**VERTICAL SCALE: 1" = 5'**  
**HORIZONTAL SCALE: 1" = 50'**

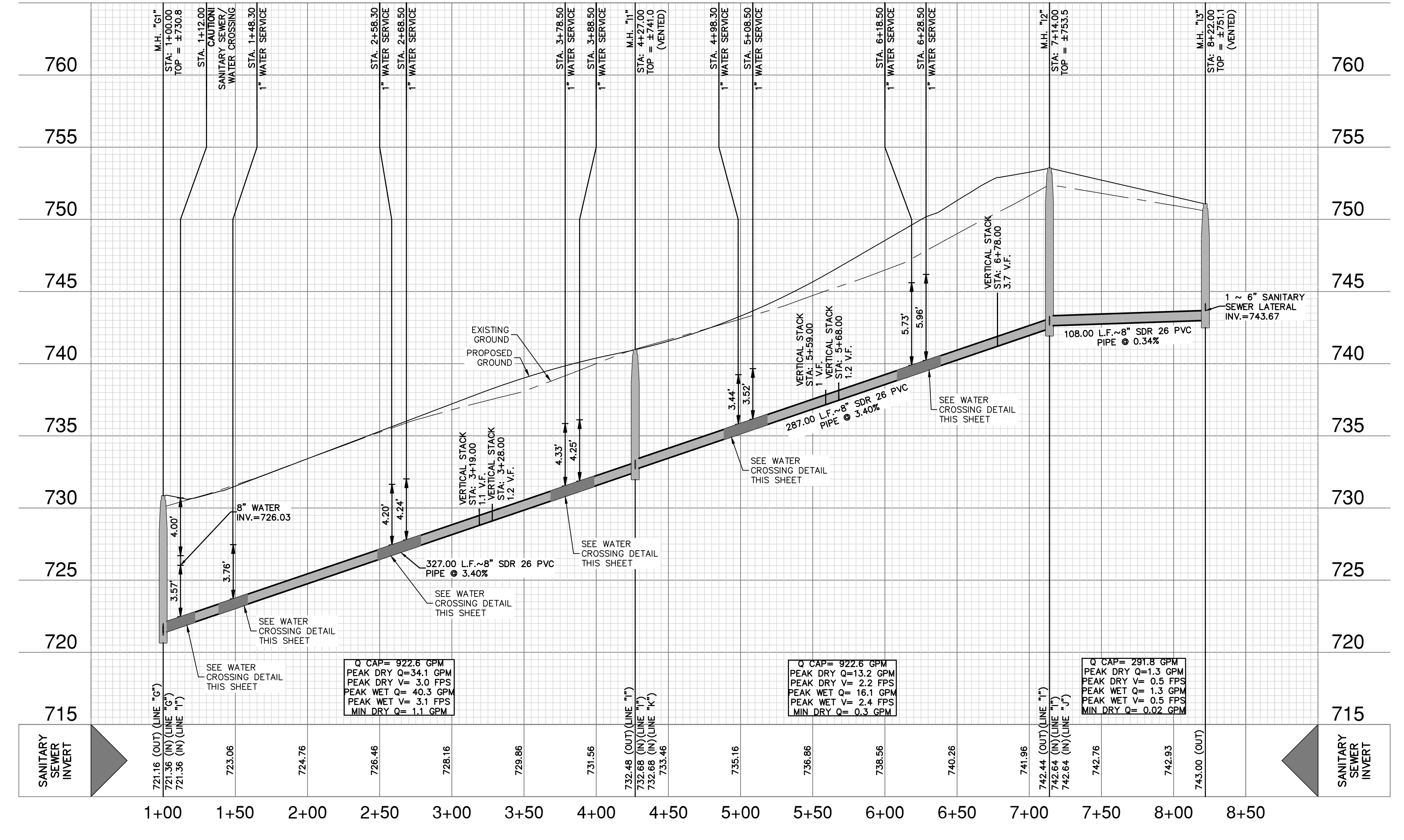

Station	Sanitary Sewer Invert	Water Service Invert	Notes
1+00	721.16 (OUT) (LINE "G")	721.38 (IN) (LINE "G")	M.H. "G1" STA: 1+00.00 TOP = 719.09
1+50	723.06	724.76	CAUTION SANITARY SEWER/WATER CROSSING STA. 1+12.00
2+00	726.46	728.16	327.00 LF ~ 8" SDR 26 PVC PIPE @ 3.40%
2+50	728.16	733.46	M.H. "H1" STA: 4+27.00 TOP = 741.0 (VENTED)
3+00	728.16	733.46	327.00 LF ~ 8" SDR 26 PVC PIPE @ 3.40%
3+50	728.16	733.46	M.H. "I1" STA: 6+18.50 TOP = 735.5
4+00	728.16	733.46	287.00 LF ~ 8" SDR 26 PVC PIPE @ 3.40%
4+50	728.16	733.46	M.H. "J1" STA: 7+14.00 TOP = 743.67
5+00	728.16	733.46	108.00 LF ~ 8" SDR 26 PVC PIPE @ 0.34%
5+50	728.16	733.46	M.H. "K1" STA: 8+22.00 TOP = 743.67
6+00	728.16	733.46	
6+50	728.16	733.46	
7+00	728.16	733.46	
7+50	728.16	733.46	
8+00	728.16	733.46	
8+50	728.16	733.46	

Date: Nov 20, 2023, 2:02pm User ID: D:\mch File: P:\3001\01\66\Design\Chal\SS1-30001-66.dwg

THIS DOCUMENT HAS BEEN PRODUCED FROM MATERIAL THAT WAS STORED AND/OR TRANSMITTED ELECTRONICALLY AND MAY HAVE BEEN INADVERTENTLY ALTERED. RELY ONLY ON FINAL HARDCOPY MATERIALS BEARING THE CONSULTANT'S ORIGINAL SIGNATURE AND SEAL. AERIAL IMAGERY PROVIDED BY GOOGLE/UNLESS OTHERWISE NOTED. Imagery © 2016, CAPOCO/2digi Global, Texas Orthographic Program, USDA Farm Service Agency.

DATE: \_\_\_\_\_  
NO. REVISION: \_\_\_\_\_

Jocelyn Perez  
Professional Engineer  
No. 98367  
State of Texas

**PAPE-DAWSON ENGINEERS**  
1672 INDEPENDENCE DR, STE 102 | NEW BRAUNFELS, TX 78132 | 800.692.5693  
TEXAS SURVEYING FIRM #1008800

**VERAMENDI PRECINCT 18 UNIT 1**  
NEW BRAUNFELS, TEXAS

**SANITARY SEWER LINE I - PLAN & PROFILE**  
STA 1+00.00 TO 8+22.00

JOB NO. 30001-66  
DATE 07-03-2023  
DESIGNER GDL  
CHECKED GDL DRAWN BH  
SHEET C5.20

**FOR PERMIT**



**CITY OF NEW BRAUNFELS NOTES**

- NO VALVES, HYDRANTS, ETC. SHALL BE CONSTRUCTED WITHIN CURBS, SIDEWALKS, OR DRIVEWAYS.
- ALL UTILITIES TO BE CONSTRUCTED PRIOR TO STREETS.
- THIS PROJECT INCLUDES UTILITY INSTALLATIONS GREATER THAN 5- FEET IN DEPTH. DEEP TRENCHES POSE COMPACTION TESTING AND CONSTRUCTION CHALLENGES AND CITY METHODS FOR TESTING AND COMPACTION MAY NOT BE ACHIEVABLE. A UTILITY COMPACTION PLAN WILL BE REQUIRED AND MUST BE SUBMITTED FOR APPROVAL TO CITY PRIOR TO UTILITY INSTALLATION.
- UTILITY TRENCH COMPACTION - ALL UTILITY TRENCH COMPACTION TESTS WITHIN THE STREET PAVEMENT/SIDEWALK SECTION SHALL BE THE RESPONSIBILITY OF THE DEVELOPER'S GEOTECHNICAL ENGINEER. FILL MATERIAL SHALL BE PLACED IN UNIFORM LAYERS NOT TO EXCEED TWELVE INCHES (12") LOOSE. DETERMINE THE MAXIMUM LIFT THICKNESS BASED ON THE ABILITY OF THE COMPACTION OPERATION AND EQUIPMENT USED TO MEET THE REQUIRED DENSITY. EACH LAYER OF MATERIAL SHALL BE COMPACTED TO A MINIMUM 95% DENSITY AND TESTED FOR DENSITY AND MOISTURE IN ACCORDANCE WITH TEST METHODS TEX-113-E, TEX-114-E, TEX-115-E. THE NUMBER AND LOCATION OF REQUIRED TESTS SHALL BE DETERMINED BY THE GEOTECHNICAL ENGINEER AND APPROVED BY THE CITY OF NEW BRAUNFELS STREET INSPECTOR. AT A MINIMUM, TESTS SHALL BE TAKEN EVERY 200 LF FOR EACH LIFT AND EVERY OTHER SERVICE LINE. UPON COMPLETION OF TESTING THE GEOTECHNICAL ENGINEER SHALL PROVIDE THE CITY OF NEW BRAUNFELS STREET INSPECTOR WITH ALL TESTING DOCUMENTATION AND A CERTIFICATION STATING THAT THE PLACEMENT OF FILL MATERIAL HAS BEEN COMPLETED IN ACCORDANCE WITH THE PLANS. ADDITIONAL DENSITY TESTS MAY BE REQUESTED BY THE CITY OF NEW BRAUNFELS INSPECTOR.

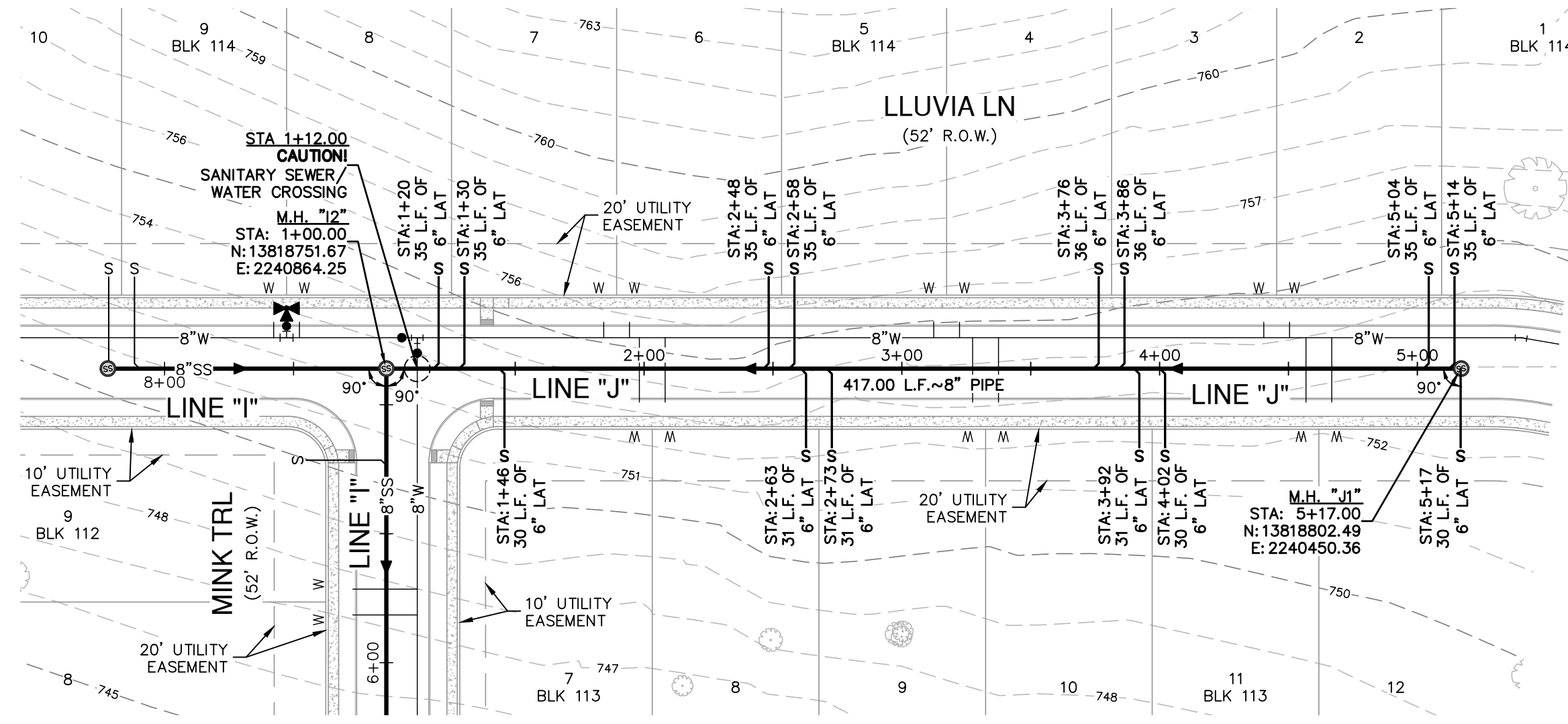
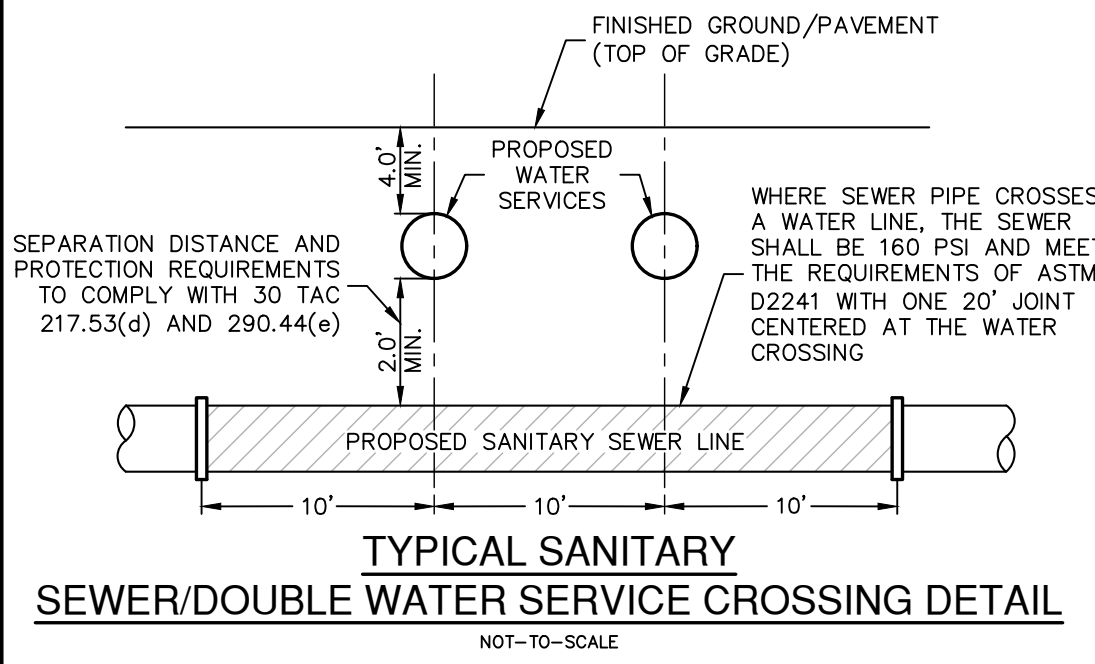

**SANITARY SEWER LINE "J"**  
STA 1+00.00 TO 5+17.00

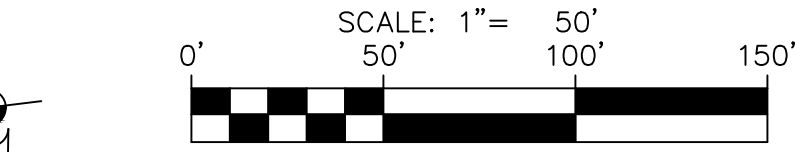
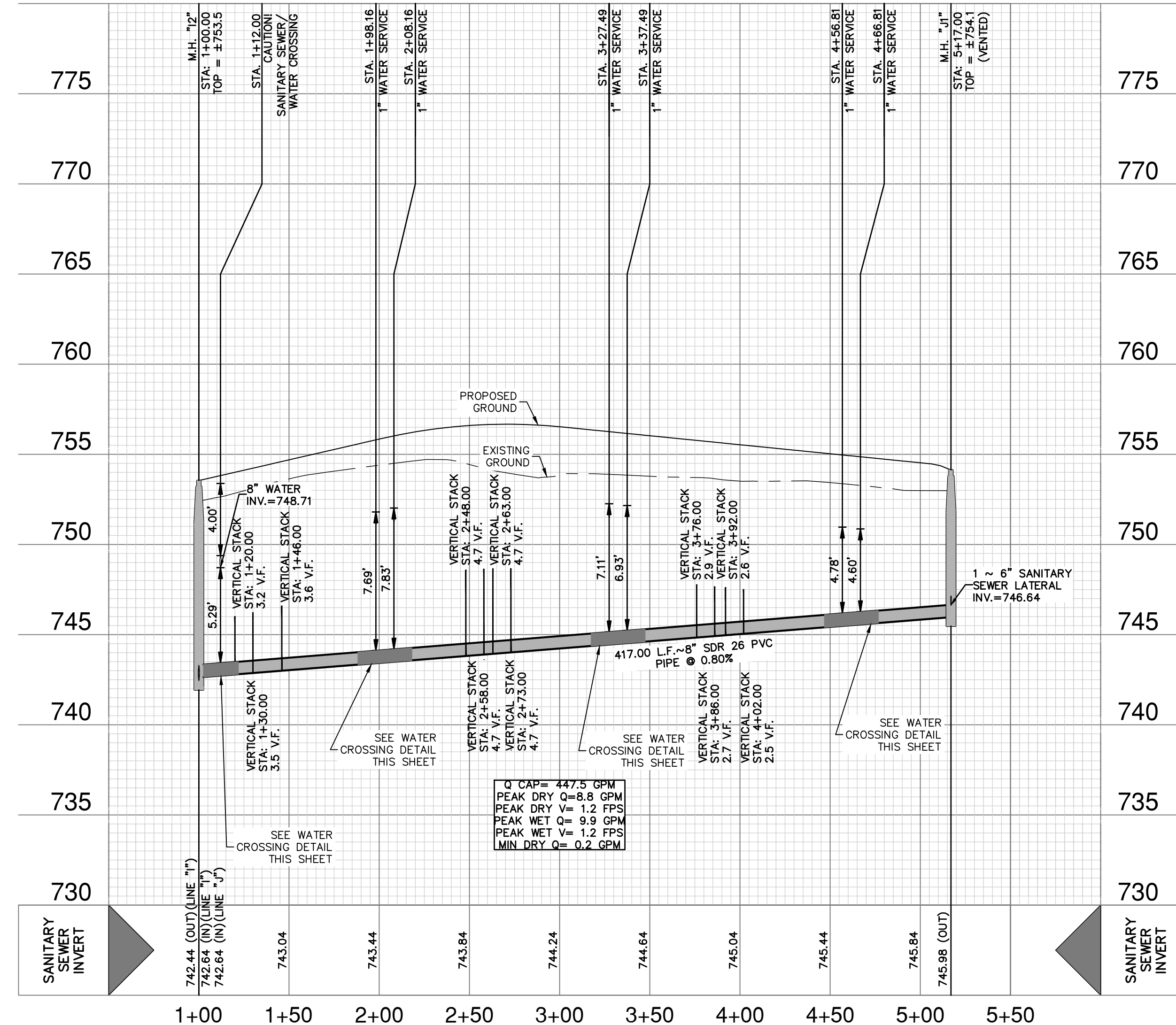

**SEWER LEGEND**

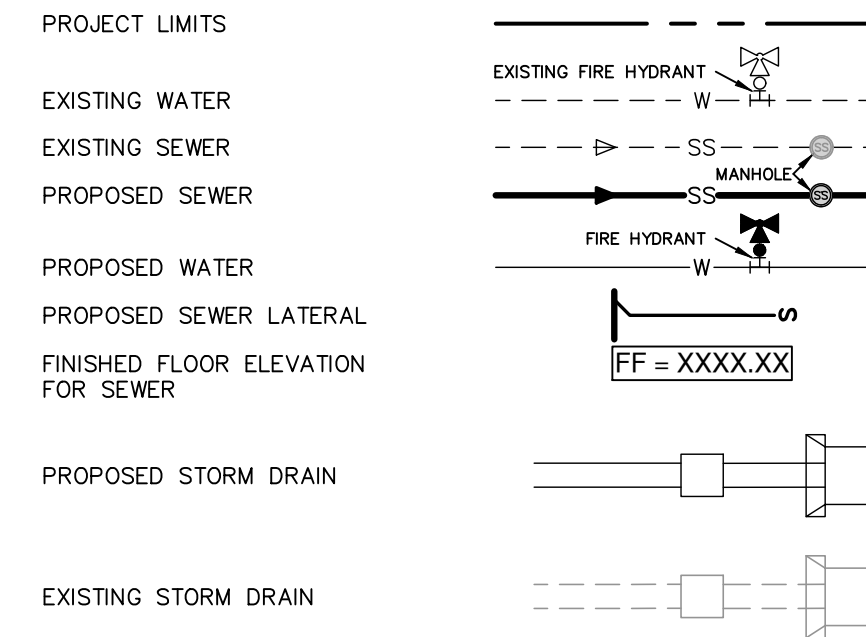

**NOTES**

- SEWER PIPE WHERE WATER LINE CROSSES SHALL BE 160 P.S.I. AND MEET THE REQUIREMENTS OF ASTM D2241 WITH ONE 20' JOINT CENTERED AT WATER MAIN.
- NO VERTICAL STACKS ALLOWED FOR ANY LOTS UNLESS OTHERWISE SPECIFIED BY THE ENGINEER.
- WHEN HORIZONTAL DISTANCE BETWEEN SEWER PIPES AND WATER MAIN IS LESS THAN 9 FOOT OF SEPARATION, SEWER MAIN SHALL BE INSTALLED WITH 150 PSI (MIN) PRESSURE PIPE AND FITTINGS IN ACCORDANCE WITH NBU'S WATER CONNECTION POLICY IN THE VICINITY OF WATER MAINS. (SEE SEWER NOTES SHEET C5.30)
- CONTRACTOR SHALL ENSURE THAT MANHOLES OUTSIDE OF PAVED AREAS ARE SET WITH TOP ELEVATIONS 2" ABOVE FINISHED GRADE WITH CONCRETE RING ENCASUREMENT. CONTRACTOR SHALL ENSURE THAT MANHOLES IN PAVED AREAS ARE SET TO MATCH TOP OF FINISHED GRADE.
- ALL SEWER PIPES SHALL BE 8" PVC (SDR 26), UNLESS OTHERWISE NOTED.
- CONTRACTOR IS TO VERIFY EXISTING INVERT OF SANITARY SEWER MAIN AND ALERT ENGINEER IMMEDIATELY OF ANY DIFFERENCE FROM INVERT SHOWN ON PLANS.
- CONTRACTOR SHALL PROTECT ALL EXISTING FENCES. ANY FENCE DAMAGED BY THE CONTRACTOR SHALL BE REPAIRED BY THE CONTRACTOR AT THEIR EXPENSE.
- THE CONTRACTOR WILL BE RESPONSIBLE FOR DETERMINING EXACT LOCATION OF ALL UTILITIES AND DRAINAGE STRUCTURES WHETHER SHOWN ON THE PLANS OR NOT. THE CONTRACTOR SHALL UNCOVER EXISTING UTILITIES PRIOR TO CONSTRUCTION TO VERIFY SIZE, GRADE, AND LOCATION. THE CONTRACTOR SHALL NOTIFY THE ENGINEER IMMEDIATELY OF ANY DEVIATIONS FROM PLANS PRIOR TO BEGINNING CONSTRUCTION. ANY DAMAGE TO EXISTING UTILITIES, WHETHER SHOWN ON THE PLANS OR NOT, SHALL BE THE CONTRACTOR'S RESPONSIBILITY TO REPAIR, AT HIS EXPENSE.
- SEE THIS SHEET FOR TYPICAL SANITARY SEWER/WATER CROSSING DETAIL.
- IF A CONFLICT EXISTS BETWEEN THE VARIOUS SUBMITTED DOCUMENTS (ENGINEERING CALCULATIONS, PROJECTED SPECIFICATIONS, PROJECTED PLANS, ADDENDUMS, ETC.), THE FOLLOWING DOCUMENTS TAKE PRECEDENCE: SPECIFICATIONS GOVERN OVER PLANS, SPECIAL CONDITIONS GOVERN OVER SPECIFICATIONS AND PLANS. ADDENDUMS TAKE PRECEDENCE OVER ALL.
- LAST 20 L.F. OF 8" STUB-OUT SHALL BE CONSTRUCTED OF P.V.C. SDR 26 (160 P.S.I.) PRESSURE PIPE.
- ALL SEWER PIPE LATERALS SHALL BE SDR 26 (CLASS 160) PVC PIPE AND SHALL HAVE A MINIMUM SLOPE OF 2%.
- WASTEWATER LATERALS SHALL BE LAID WITH A MINIMUM OF 36 INCHES OF COVER.
- NEW MANHOLES MUST BE CONSTRUCTED OF OR LINED WITH A CORROSION RESISTANT MATERIAL. WHERE NEW CONSTRUCTION CONNECTS TO AN EXISTING MANHOLE THAT IS NOT CONSTRUCTED OF A CORROSION RESISTANT MATERIAL, THE EXISTING MANHOLE MUST BE LINED WITH OR REPLACED WITH A CORROSION RESISTANT MATERIAL.
- 48" MANHOLES ARE REQUIRED FOR ALL MAINS UP TO 18" IN DIAMETER.

**NOTE:**  
FOR PAVEMENT DESIGN SECTION SEE GEOTECHNICAL ENGINEERING REPORT.

**FLOODPLAIN NOTE**

- NO PORTION OF ANY LOT ON THIS PROJECT IS WITHIN AN INDICATED SPECIAL FLOOD HAZARD ZONE ACCORDING TO THE FEMA FIRM MAP NO. 48187C0095F EFFECTIVE DATE 9/2/2009.

**CAUTION!!**

CONTRACTOR SHALL BE REQUIRED TO LOCATE ALL PUBLIC OR PRIVATE UTILITIES INCLUDING BUT NOT LIMITING TO: WATER, SEWER, TELEPHONE AND FIBER OPTIC LINES, SITE LIGHTING ELECTRIC, SECONDARY ELECTRIC, PRIMARY ELECTRICAL, DUCTIVE IRRIGATION FACILITIES, AND GAS LINES. ANY UTILITY CONFLICTS THAT ARISE SHOULD BE COMMUNICATED TO THE ENGINEER IMMEDIATELY AND PRIOR TO CONSTRUCTION. THE CONTRACTOR SHALL CONTACT "TEXAS 811" A MINIMUM OF 48 HOURS PRIOR TO THE START OF CONSTRUCTION. ANY DAMAGE TO EXISTING UTILITIES SHALL BE THE SOLE RESPONSIBILITY OF THE CONTRACTOR AND THE REPAIR SHALL BE AT CONTRACTOR'S SOLE EXPENSE WHETHER THE UTILITY IS SHOWN ON THESE PLANS OR NOT.

**TRENCH EXCAVATION SAFETY PROTECTION:**

CONTRACTOR AND/OR CONTRACTOR'S INDEPENDENTLY RETAINED EMPLOYEE OR STRUCTURAL DESIGN/ GEOTECHNICAL/ SAFETY/EQUIPMENT CONSULTANT, IF ANY, SHALL REVIEW THESE PLANS AND ANY AVAILABLE GEOTECHNICAL INFORMATION AND THE ANTICIPATED INSTALLATION SITES WITHIN THE PROJECT WORK AREA IN ORDER TO IMPLEMENT CONTRACTOR'S TRENCH EXCAVATION SAFETY PROTECTION SYSTEMS, PROGRAMS AND /OR PROCEDURES FOR THE PROJECT DESCRIBED IN THE CONTRACT DOCUMENTS. THE CONTRACTOR'S IMPLEMENTATION OF THESE SYSTEMS, PROGRAMS AND/OR PROCEDURES SHALL PROVIDE FOR ADEQUATE TRENCH EXCAVATION SAFETY PROTECTION THAT COMPLY WITH AS A MINIMUM, OSHA STANDARDS FOR TRENCH EXCAVATIONS. SPECIFICALLY, CONTRACTOR AND/OR CONTRACTOR'S INDEPENDENTLY RETAINED EMPLOYEE OR SAFETY CONSULTANT SHALL IMPLEMENT A TRENCH SAFETY PROGRAM IN ACCORDANCE WITH OSHA STANDARDS GOVERNING THE PRESENCE AND ACTIVITIES OF INDIVIDUALS WORKING IN AND AROUND TRENCH EXCAVATION.

DATE	
NO.	REVISION



**PAPE-DAWSON ENGINEERS**  
1672 INDEPENDENCE DR, STE 102 | NEW BRAUNFELS, TX 78132 | 800.632.5683  
TEXAS ENGINEERING FIRM #470 | TEXAS SURVEYING FIRM #1008800

**VERAMENDI PRECINCT 18 UNIT 1**  
NEW BRAUNFELS, TEXAS  
**SANITARY SEWER LINE J - PLAN & PROFILE**  
STA 1+00.00 TO 5+17.00

PLAT NO.	
JOB NO.	30001-66
DATE	07-03-2023
DESIGNER	GDL
CHECKED	✓ DRAWN BH
SHEET	C5.21

**FOR PERMIT**



**CITY OF NEW BRAUNFELS NOTES**

- NO VALVES, HYDRANTS, ETC. SHALL BE CONSTRUCTED WITHIN CURBS, SIDEWALKS, OR DRIVEWAYS.
- ALL UTILITIES TO BE CONSTRUCTED PRIOR TO STREETS.
- THIS PROJECT INCLUDES UTILITY INSTALLATIONS GREATER THAN 5- FEET IN DEPTH. DEEP TRENCHES POSE COMPACTION TESTING AND CONSTRUCTION CHALLENGES AND CITY METHODS FOR TESTING AND COMPACTION MAY NOT BE ACHIEVABLE. A UTILITY COMPACTION PLAN WILL BE REQUIRED AND MUST BE SUBMITTED FOR APPROVAL TO CITY PRIOR TO UTILITY INSTALLATION.
- UTILITY TRENCH COMPACTION - ALL UTILITY TRENCH COMPACTION TESTS WITHIN THE STREET PAVEMENT/SIDEWALK SECTION SHALL BE THE RESPONSIBILITY OF THE DEVELOPER'S GEOTECHNICAL ENGINEER. FILL MATERIAL SHALL BE PLACED IN UNIFORM LAYERS NOT TO EXCEED TWELVE INCHES (12") LOOSE. DETERMINE THE MAXIMUM LIFT THICKNESS BASED ON THE ABILITY OF THE COMPACTION OPERATION AND EQUIPMENT USED TO MEET THE REQUIRED DENSITY. EACH LAYER OF MATERIAL SHALL BE COMPACTED TO A MINIMUM 95% DENSITY AND TESTED FOR DENSITY AND MOISTURE IN ACCORDANCE WITH TEST METHODS TEX-113-E, TEX-114-E, TEX-115-E. THE NUMBER AND LOCATION OF REQUIRED TESTS SHALL BE DETERMINED BY THE GEOTECHNICAL ENGINEER AND APPROVED BY THE CITY OF NEW BRAUNFELS STREET INSPECTOR. AT A MINIMUM, TESTS SHALL BE TAKEN EVERY 200 LF FOR EACH LIFT AND EVERY OTHER SERVICE LINE. UPON COMPLETION OF TESTING THE GEOTECHNICAL ENGINEER SHALL PROVIDE THE CITY OF NEW BRAUNFELS STREET INSPECTOR WITH ALL TESTING DOCUMENTATION AND A CERTIFICATION STATING THAT THE PLACEMENT OF FILL MATERIAL HAS BEEN COMPLETED IN ACCORDANCE WITH THE PLANS. ADDITIONAL DENSITY TESTS MAY BE REQUESTED BY THE CITY OF NEW BRAUNFELS INSPECTOR.

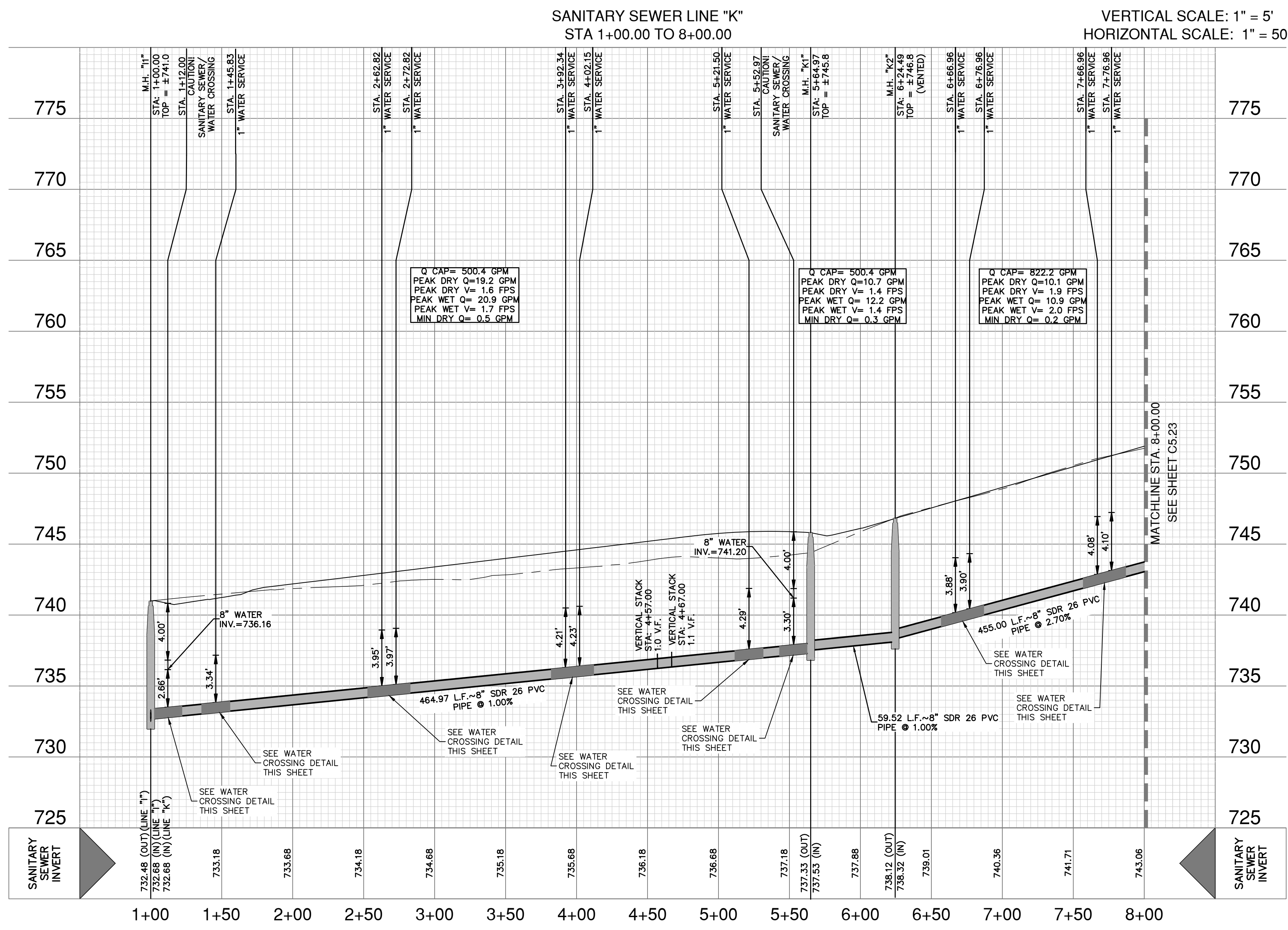
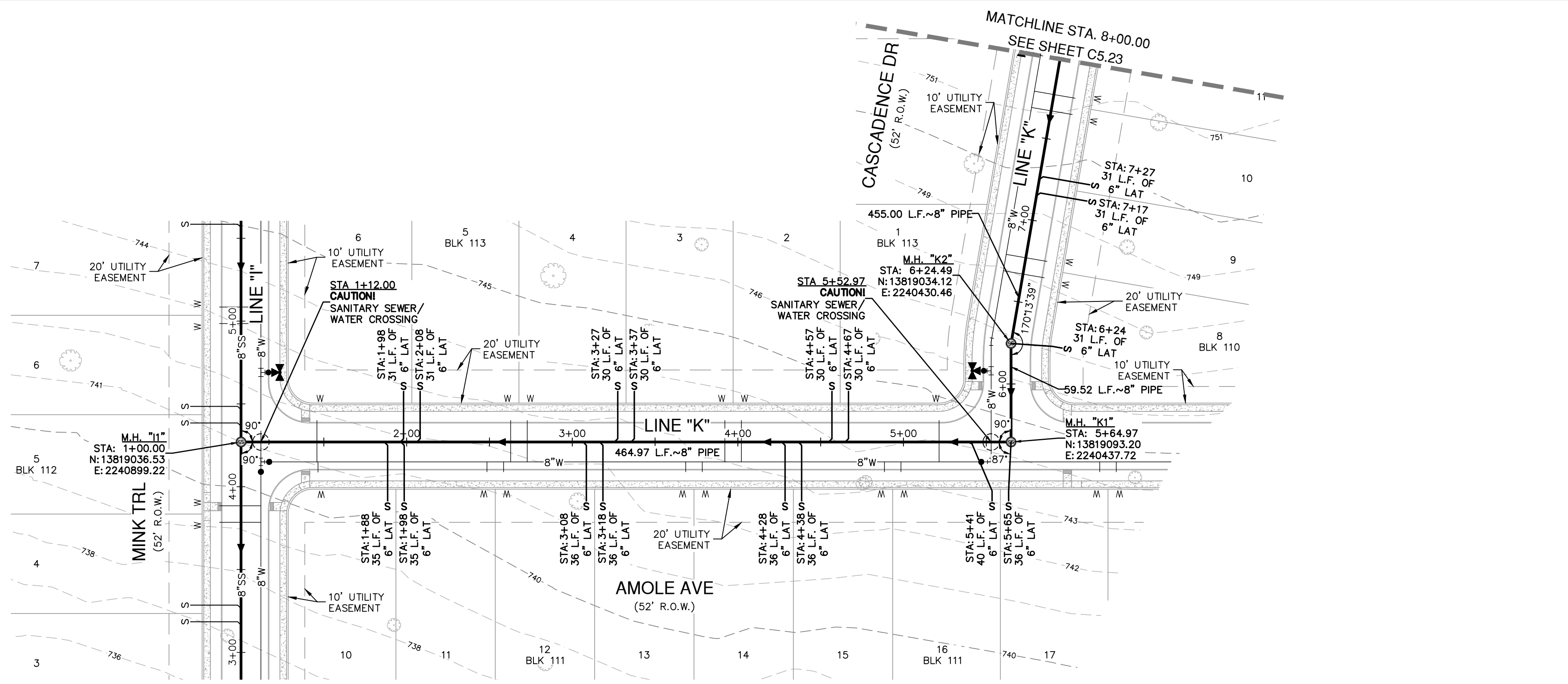
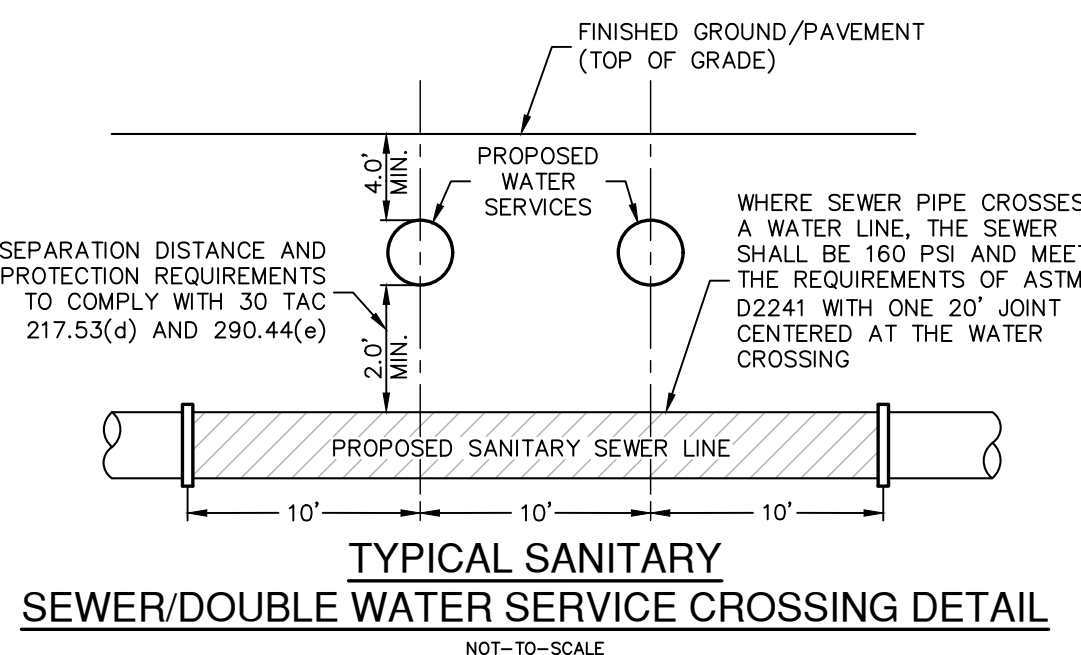
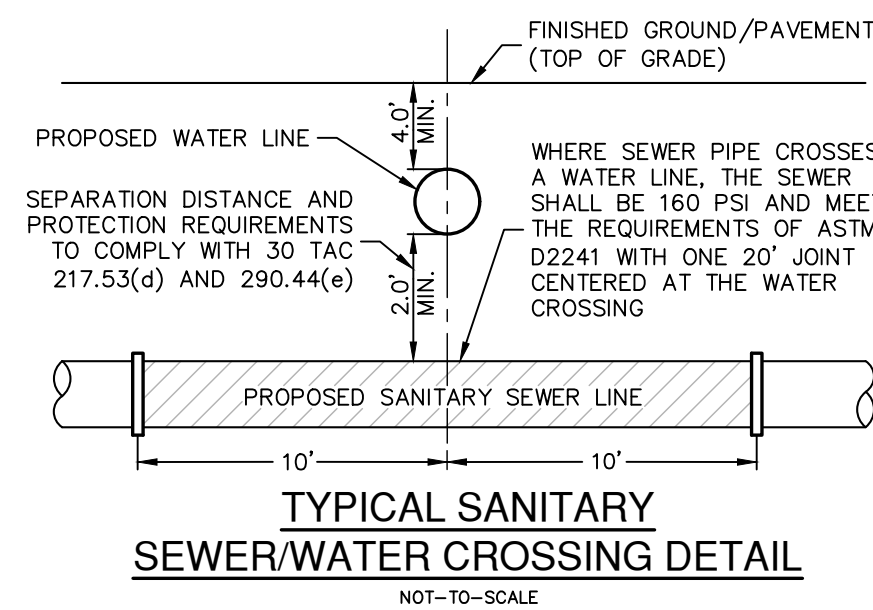

**SEWER LEGEND**

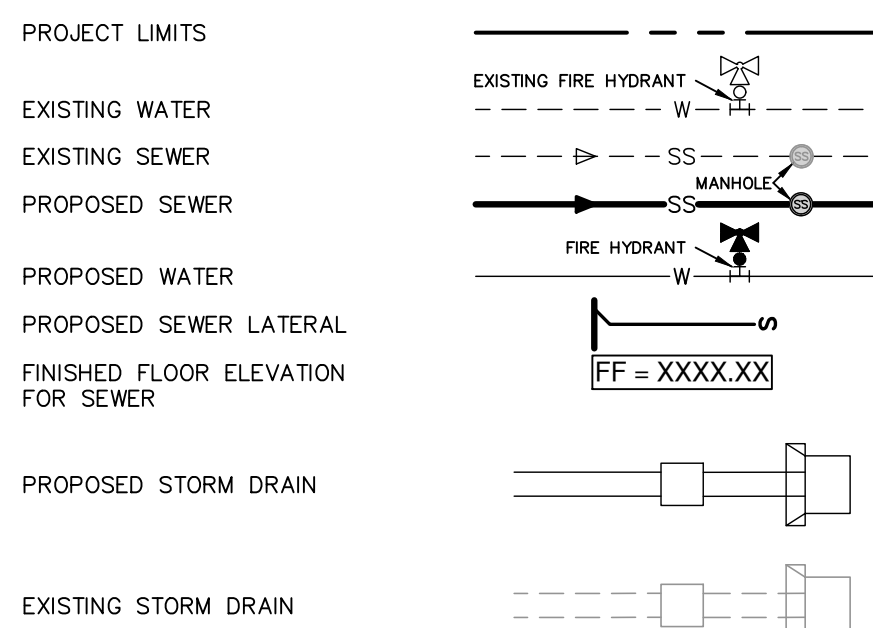

**NOTES**

- SEWER PIPE WHERE WATER LINE CROSSES SHALL BE 160 P.S.I. AND MEET THE REQUIREMENTS OF ASTM D2241 WITH ONE 20' JOINT CENTERED AT WATER MAIN.
- NO VERTICAL STACKS ALLOWED FOR ANY LOTS UNLESS OTHERWISE SPECIFIED BY THE ENGINEER.
- WHEN HORIZONTAL DISTANCE BETWEEN SEWER PIPES AND WATER MAIN IS LESS THAN 9 FOOT OF SEPARATION, SEWER MAIN SHALL BE INSTALLED WITH 150 PSI (MIN) PRESSURE PIPE AND FITTINGS IN ACCORDANCE WITH NBU'S WATER CONNECTION POLICY IN THE VICINITY OF WATER MAINS. (SEE SEWER NOTES SHEET C5.30)
- CONTRACTOR SHALL ENSURE THAT MANHOLES OUTSIDE OF PAVED AREAS ARE SET WITH TOP ELEVATIONS 2' ABOVE FINISHED GRADE WITH CONCRETE RING ENGAGEMENT. CONTRACTOR SHALL ENSURE THAT MANHOLES IN PAVED AREAS ARE SET TO MATCH TOP OF FINISHED GRADE.
- ALL SEWER PIPES SHALL BE 8" PVC (SDR 26), UNLESS OTHERWISE NOTED.
- CONTRACTOR IS TO VERIFY EXISTING INVERT OF SANITARY SEWER MAIN AND ALERT ENGINEER IMMEDIATELY OF ANY DIFFERENCE FROM INVERT SHOWN ON PLANS.
- CONTRACTOR SHALL PROTECT ALL EXISTING FENCES. ANY FENCE DAMAGED BY THE CONTRACTOR SHALL BE REPAIRED BY THE CONTRACTOR AT THEIR EXPENSE.
- THE CONTRACTOR WILL BE RESPONSIBLE FOR DETERMINING EXACT LOCATION OF ALL UTILITIES AND DRAINAGE STRUCTURES WHETHER SHOWN ON THE PLANS OR NOT. THE CONTRACTOR SHALL UNCOVER EXISTING UTILITIES PRIOR TO CONSTRUCTION TO VERIFY SIZE, GRADE, AND LOCATION. THE CONTRACTOR SHALL NOTIFY THE ENGINEER IMMEDIATELY OF ANY DEVIATIONS FROM PLANS PRIOR TO BEGINNING CONSTRUCTION. ANY DAMAGE TO EXISTING UTILITIES, WHETHER SHOWN ON THE PLANS OR NOT, SHALL BE THE CONTRACTOR'S RESPONSIBILITY TO REPAIR, AT HIS EXPENSE.
- SEE THIS SHEET FOR TYPICAL SANITARY SEWER/WATER CROSSING DETAIL.
- IF A CONFLICT EXISTS BETWEEN THE VARIOUS SUBMITTED DOCUMENTS (ENGINEERING CALCULATIONS, PROJECTED SPECIFICATIONS, PROJECTED PLANS, ADDENDUMS, ETC.), THE FOLLOWING DOCUMENTS TAKE PRECEDENCE: SPECIFICATIONS GOVERN OVER PLANS, SPECIAL CONDITIONS GOVERN OVER SPECIFICATIONS AND PLANS. ADDENDUMS TAKE PRECEDENCE OVER ALL.
- LAST 20 L.F. OF 8" STUB-OUT SHALL BE CONSTRUCTED OF P.V.C. SDR 26 (160 P.S.I.) PRESSURE PIPE.
- ALL SEWER PIPE LATERALS SHALL BE SDR 26 (CLASS 160) PVC PIPE AND SHALL HAVE A MINIMUM SLOPE OF 2%.
- WASTEWATER LATERALS SHALL BE LAID WITH A MINIMUM OF 36 INCHES OF COVER.
- NEW MANHOLES MUST BE CONSTRUCTED OF OR LINED WITH A CORROSION RESISTANT MATERIAL. WHERE NEW CONSTRUCTION CONNECTS TO AN EXISTING MANHOLE THAT IS NOT CONSTRUCTED OF A CORROSION RESISTANT MATERIAL, THE EXISTING MANHOLE MUST BE LINED WITH OR REPLACED WITH A CORROSION RESISTANT MATERIAL.
- 48" MANHOLES ARE REQUIRED FOR ALL MAINS UP TO 18" IN DIAMETER.

**FLOODPLAIN NOTE**

- NO PORTION OF ANY LOT ON THIS PROJECT IS WITHIN AN INDICATED SPECIAL FLOOD HAZARD ZONE ACCORDING TO THE FEMA FIRM MAP NO. 48187C0095F EFFECTIVE DATE 9/2/2009.

**CAUTION!!**

CONTRACTOR SHALL BE REQUIRED TO LOCATE ALL PUBLIC OR PRIVATE UTILITIES INCLUDING BUT NOT LIMITING TO: WATER, SEWER, TELEPHONE AND FIBER OPTIC LINES, SITE LIGHTING ELECTRIC, SECONDARY ELECTRIC, PRIMARY ELECTRICAL, DUCTBANKS, LANDSCAPE IRRIGATION FACILITIES, AND GAS LINES. ANY UTILITY CONFLICTS THAT ARISE SHOULD BE COMMUNICATED TO THE ENGINEER IMMEDIATELY AND PRIOR TO CONSTRUCTION. THE CONTRACTOR SHALL CONTACT "TEXAS 811" A MINIMUM OF 48 HOURS PRIOR TO THE START OF CONSTRUCTION. ANY DAMAGE TO EXISTING UTILITIES SHALL BE THE SOLE RESPONSIBILITY OF THE CONTRACTOR AND THE REPAIR SHALL BE AT CONTRACTOR'S SOLE EXPENSE WHETHER THE UTILITY IS SHOWN ON THESE PLANS OR NOT.

**TRENCH EXCAVATION SAFETY PROTECTION:**

CONTRACTOR AND/OR CONTRACTOR'S INDEPENDENTLY RETAINED EMPLOYEE OR STRUCTURAL DESIGN/ GEOTECHNICAL/ SAFETY/EQUIPMENT CONSULTANT, IF ANY, SHALL REVIEW THESE PLANS AND ANY AVAILABLE GEOTECHNICAL INFORMATION AND THE ANTICIPATED INSTALLATION SITES WITHIN THE PROJECT WORK AREA IN ORDER TO IMPLEMENT CONTRACTOR'S TRENCH EXCAVATION SAFETY PROTECTION SYSTEMS, PROGRAMS AND /OR PROCEDURES FOR THE PROJECT DESCRIBED IN THE CONTRACT DOCUMENTS. THE CONTRACTOR'S IMPLEMENTATION OF THESE SYSTEMS, PROGRAMS AND/OR PROCEDURES SHALL PROVIDE FOR ADEQUATE TRENCH EXCAVATION SAFETY PROTECTION THAT COMPLY WITH AS A MINIMUM, OSHA STANDARDS FOR TRENCH EXCAVATIONS. SPECIFICALLY, CONTRACTOR AND/OR CONTRACTOR'S INDEPENDENTLY RETAINED EMPLOYEE OR SAFETY CONSULTANT SHALL IMPLEMENT A TRENCH SAFETY PROGRAM IN ACCORDANCE WITH OSHA STANDARDS GOVERNING THE PRESENCE AND ACTIVITIES OF INDIVIDUALS WORKING IN AND AROUND TRENCH EXCAVATION.

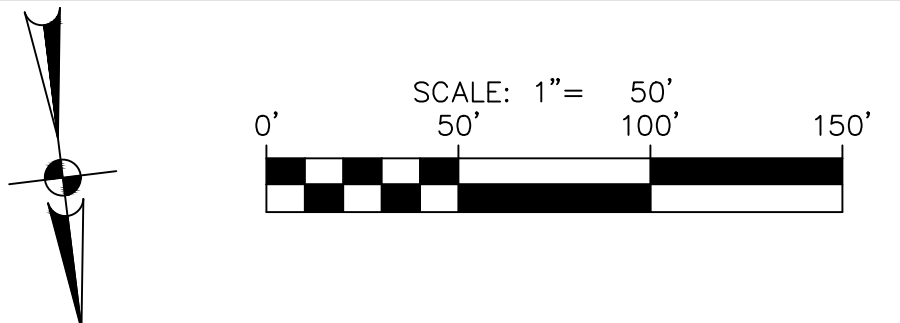

DATE: \_\_\_\_\_

NO. REVISION: \_\_\_\_\_

11-20-2023

JOCelyn PEREZ  
98367  
PROFESSIONAL ENGINEER

*Jocelyn Perez*

**PAPE-DAWSON ENGINEERS**

1672 INDEPENDENCE DR, STE 102 | NEW BRAUNFELS, TX 78132 | 800.632.5693  
TEXAS ENGINEERING FIRM #479 | TEXAS SURVEYING FIRM #1008800

**VERAMENDI PRECINCT 18 UNIT 1**  
NEW BRAUNFELS, TEXAS

**SANITARY SEWER LINE K - PLAN & PROFILE**  
STA 1+00.00 TO 8+00.00

JOB NO. 30001-66  
DATE 07-03-2023  
DESIGNER GDL  
CHECKED GDL DRAWN BH  
SHEET C5.22

FOR PERMIT



**CITY OF NEW BRAUNFELS NOTES**

- NO VALVES, HYDRANTS, ETC. SHALL BE CONSTRUCTED WITHIN CURBS, SIDEWALKS, OR DRIVEWAYS.
- ALL UTILITIES TO BE CONSTRUCTED PRIOR TO STREETS.
- THIS PROJECT INCLUDES UTILITY INSTALLATIONS GREATER THAN 5- FEET IN DEPTH. DEEP TRENCHES POSE COMPACTION TESTING AND CONSTRUCTION CHALLENGES AND CITY METHODS FOR TESTING AND COMPACTION MAY NOT BE ACHIEVABLE. A UTILITY COMPACTION PLAN WILL BE REQUIRED AND MUST BE SUBMITTED FOR APPROVAL TO CITY PRIOR TO UTILITY INSTALLATION.
- UTILITY TRENCH COMPACTION - ALL UTILITY TRENCH COMPACTION TESTS WITHIN THE STREET PAVEMENT/SIDEWALK SECTION SHALL BE THE RESPONSIBILITY OF THE DEVELOPER'S GEOTECHNICAL ENGINEER. FILL MATERIAL SHALL BE PLACED IN UNIFORM LAYERS NOT TO EXCEED TWELVE INCHES (12") LOOSE. DETERMINE THE MAXIMUM LIFT THICKNESS BASED ON THE ABILITY OF THE COMPACTION OPERATION AND EQUIPMENT USED TO MEET THE REQUIRED DENSITY. EACH LAYER OF MATERIAL SHALL BE COMPACTED TO A MINIMUM 95% DENSITY AND TESTED FOR DENSITY AND MOISTURE IN ACCORDANCE WITH TEST METHODS TEX-113-E, TEX-114-E, TEX-115-E. THE NUMBER AND LOCATION OF REQUIRED TESTS SHALL BE DETERMINED BY THE GEOTECHNICAL ENGINEER AND APPROVED BY THE CITY OF NEW BRAUNFELS STREET INSPECTOR. AT A MINIMUM, TESTS SHALL BE TAKEN EVERY 200 LF FOR EACH LIFT AND EVERY OTHER SERVICE LINE. UPON COMPLETION OF TESTING THE GEOTECHNICAL ENGINEER SHALL PROVIDE THE CITY OF NEW BRAUNFELS STREET INSPECTOR WITH ALL TESTING DOCUMENTATION AND A CERTIFICATION STATING THAT THE PLACEMENT OF FILL MATERIAL HAS BEEN COMPLETED IN ACCORDANCE WITH THE PLANS. ADDITIONAL DENSITY TESTS MAY BE REQUESTED BY THE CITY OF NEW BRAUNFELS INSPECTOR.

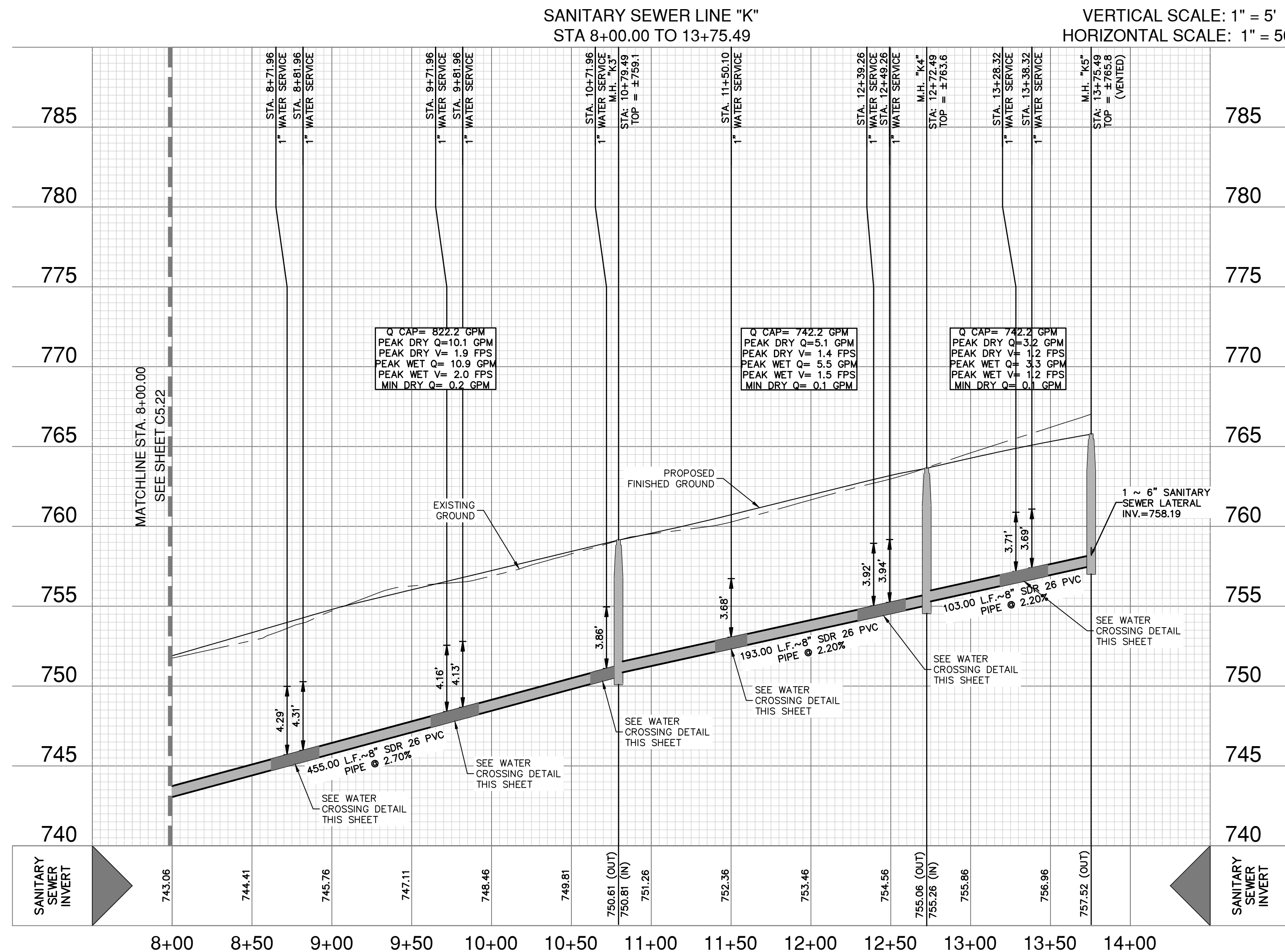
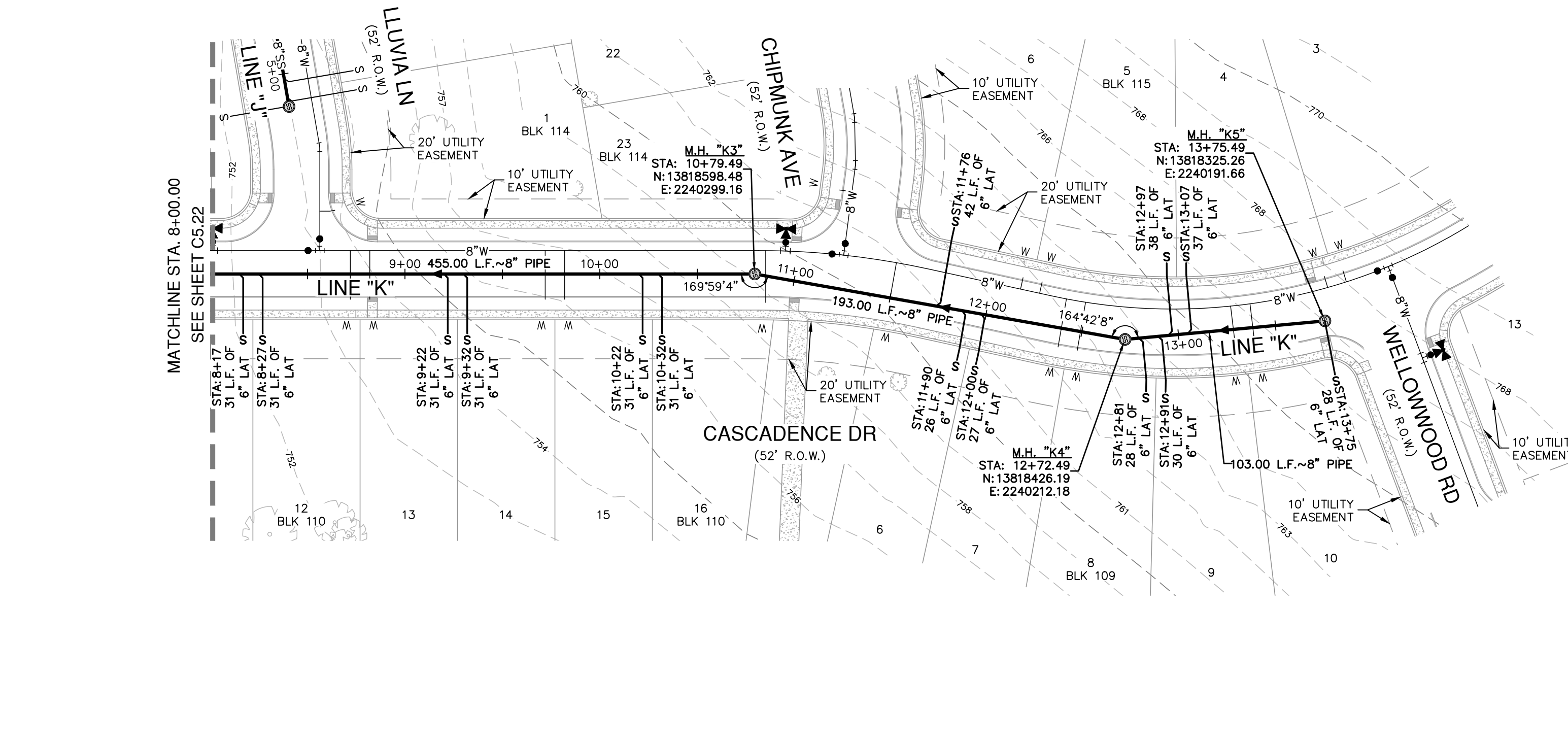
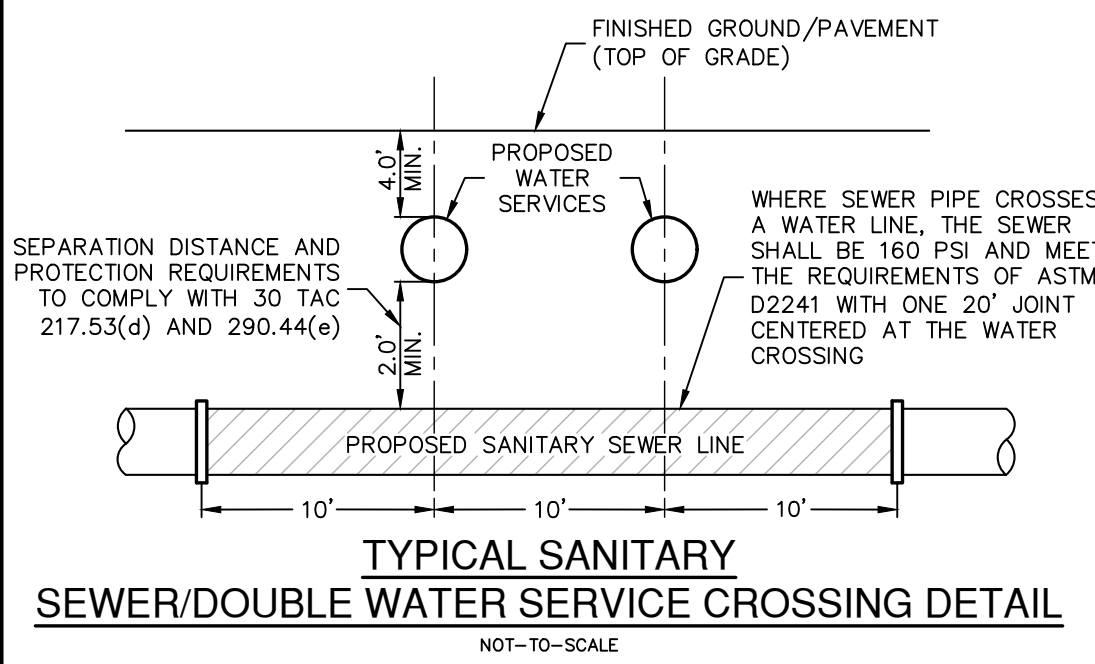
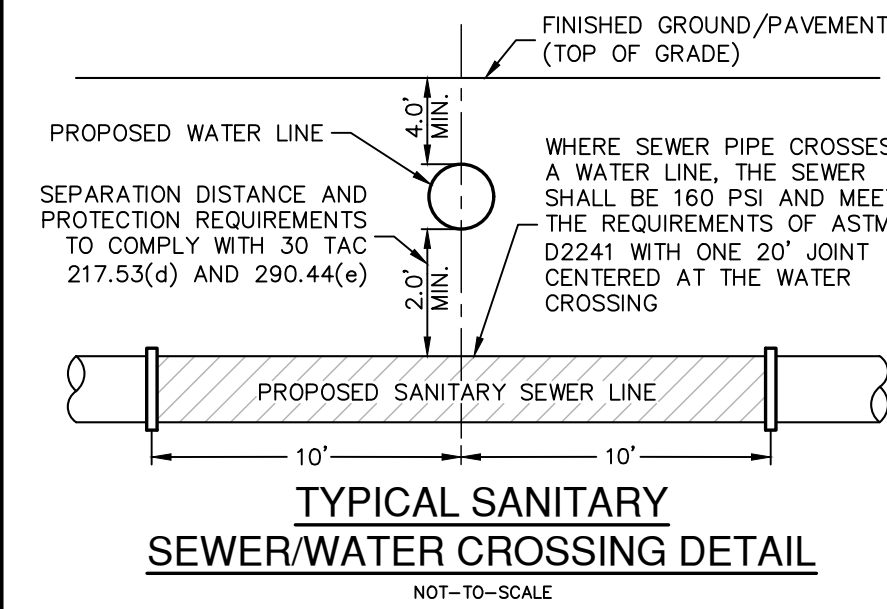

**SEWER LEGEND**

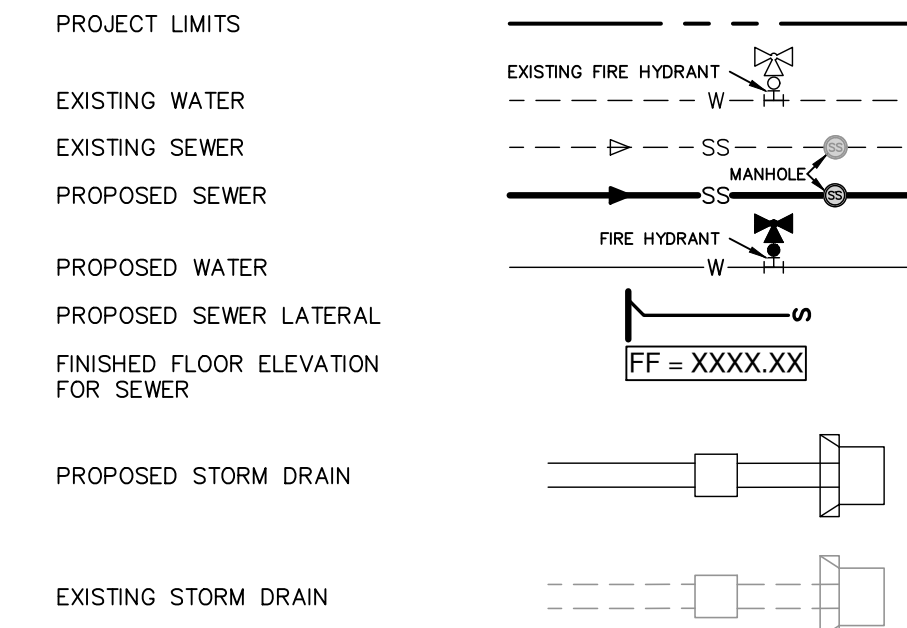

**NOTES**

- SEWER PIPE WHERE WATER LINE CROSSES SHALL BE 160 P.S.I. AND MEET THE REQUIREMENTS OF ASTM D2241 WITH ONE 20' JOINT CENTERED AT WATER MAIN.
- NO VERTICAL STACKS ALLOWED FOR ANY LOTS UNLESS OTHERWISE SPECIFIED BY THE ENGINEER.
- WHEN HORIZONTAL DISTANCE BETWEEN SEWER PIPES AND WATER MAIN IS LESS THAN 9 FOOT SEPARATION, SEWER MAIN SHALL BE INSTALLED WITH 150 PSI (MIN) PRESSURE PIPE AND FITTINGS IN ACCORDANCE WITH NBU'S WATER CONNECTION POLICY IN THE VICINITY OF WATER MAINS. (SEE SEWER NOTES SHEET C5.30)
- CONTRACTOR SHALL ENSURE THAT MANHOLES OUTSIDE OF PAVED AREAS ARE SET WITH TOP ELEVATIONS 2" ABOVE FINISHED GRADE WITH CONCRETE RING ENCASUREMENT. CONTRACTOR SHALL ENSURE THAT MANHOLES IN PAVED AREAS ARE SET TO MATCH TOP OF FINISHED GRADE.
- ALL SEWER PIPES SHALL BE 8" PVC (SDR 26), UNLESS OTHERWISE NOTED.
- CONTRACTOR IS TO VERIFY EXISTING INVERT OF SANITARY SEWER MAIN AND ALERT ENGINEER IMMEDIATELY OF ANY DIFFERENCE FROM INVERT SHOWN ON PLANS.
- CONTRACTOR SHALL PROTECT ALL EXISTING FENCES. ANY FENCE DAMAGED BY THE CONTRACTOR SHALL BE REPAIRED BY THE CONTRACTOR AT THEIR EXPENSE.
- THE CONTRACTOR WILL BE RESPONSIBLE FOR DETERMINING EXACT LOCATION OF ALL UTILITIES AND DRAINAGE STRUCTURES WHETHER SHOWN ON THE PLANS OR NOT. THE CONTRACTOR SHALL UNCOVER EXISTING UTILITIES PRIOR TO CONSTRUCTION TO VERIFY SIZE, GRADE, AND LOCATION. THE CONTRACTOR SHALL NOTIFY THE ENGINEER IMMEDIATELY OF ANY DEVIATIONS FROM PLANS PRIOR TO BEGINNING CONSTRUCTION. ANY DAMAGE TO EXISTING UTILITIES, WHETHER SHOWN ON THE PLANS OR NOT, SHALL BE THE CONTRACTOR'S RESPONSIBILITY TO REPAIR, AT HIS EXPENSE.
- SEE THIS SHEET FOR TYPICAL SANITARY SEWER/WATER CROSSING DETAIL.
- IF A CONFLICT EXISTS BETWEEN THE VARIOUS SUBMITTED DOCUMENTS (ENGINEERING CALCULATIONS, PROJECTED SPECIFICATIONS, PROJECTED PLANS, ADDENDUMS, ETC.), THE FOLLOWING DOCUMENTS TAKE PRECEDENCE: SPECIFICATIONS GOVERN OVER PLANS, SPECIAL CONDITIONS GOVERN OVER SPECIFICATIONS AND PLANS. ADDENDUMS TAKE PRECEDENCE OVER ALL.
- LAST 20 LF. OF 8" STUB-OUT SHALL BE CONSTRUCTED OF P.V.C. SDR 26 (160 P.S.I.) PRESSURE PIPE.
- ALL SEWER PIPE LATERALS SHALL BE SDR 26 (CLASS 160) PVC PIPE AND SHALL HAVE A MINIMUM SLOPE OF 2%.
- WASTEWATER LATERALS SHALL BE LAID WITH A MINIMUM OF 36 INCHES OF COVER.
- NEW MANHOLES MUST BE CONSTRUCTED OF OR LINED WITH A CORROSION RESISTANT MATERIAL. WHERE NEW CONSTRUCTION CONNECTS TO AN EXISTING MANHOLE THAT IS NOT CONSTRUCTED OF A CORROSION RESISTANT MATERIAL, THE EXISTING MANHOLE MUST BE LINED WITH OR REPLACED WITH A CORROSION RESISTANT MATERIAL.
- 48" MANHOLES ARE REQUIRED FOR ALL MAINS UP TO 18" IN DIAMETER.

**NOTE:**  
FOR PAVEMENT DESIGN SECTION SEE GEOTECHNICAL ENGINEERING REPORT.

**FLOODPLAIN NOTE**

- NO PORTION OF ANY LOT ON THIS PROJECT IS WITHIN AN INDICATED SPECIAL FLOOD HAZARD ZONE ACCORDING TO THE FEMA FIRM MAP NO. 48187C0095F EFFECTIVE DATE 9/2/2009.

**CAUTION!!**

CONTRACTOR SHALL BE REQUIRED TO LOCATE ALL PUBLIC OR PRIVATE UTILITIES INCLUDING BUT NOT LIMITING TO: WATER, SEWER, TELEPHONE AND FIBER OPTIC LINES, SITE LIGHTING ELECTRIC, SECONDARY ELECTRIC, PRIMARY ELECTRICAL DUCTS, IRRIGATION FACILITIES, AND GAS LINES. ANY UTILITY CONFLICTS THAT ARISE SHOULD BE COMMUNICATED TO THE ENGINEER IMMEDIATELY AND PRIOR TO CONSTRUCTION. THE CONTRACTOR SHALL CONTACT "TEXAS 811" A MINIMUM OF 48 HOURS PRIOR TO THE START OF CONSTRUCTION. ANY DAMAGE TO EXISTING UTILITIES SHALL BE THE SOLE RESPONSIBILITY OF THE CONTRACTOR AND THE REPAIR SHALL BE AT CONTRACTOR'S SOLE EXPENSE WHETHER THE UTILITY IS SHOWN ON THESE PLANS OR NOT.

**TRENCH EXCAVATION SAFETY PROTECTION:**

CONTRACTOR AND/OR CONTRACTOR'S INDEPENDENTLY RETAINED EMPLOYEE OR STRUCTURAL DESIGN/ GEOTECHNICAL/ SAFETY/EQUIPMENT CONSULTANT, IF ANY, SHALL REVIEW THESE PLANS AND ANY AVAILABLE GEOTECHNICAL INFORMATION AND THE ANTICIPATED INSTALLATION SITES WITHIN THE PROJECT WORK AREA IN ORDER TO IMPLEMENT CONTRACTOR'S TRENCH EXCAVATION SAFETY PROTECTION SYSTEMS, PROGRAMS AND /OR PROCEDURES FOR THE PROJECT DESCRIBED IN THE CONTRACT DOCUMENTS. THE CONTRACTOR'S IMPLEMENTATION OF THESE SYSTEMS, PROGRAMS AND/OR PROCEDURES SHALL PROVIDE FOR ADEQUATE TRENCH EXCAVATION SAFETY PROTECTION THAT COMPLY WITH AS A MINIMUM, OSHA STANDARDS FOR TRENCH EXCAVATIONS. SPECIFICALLY, CONTRACTOR AND/OR CONTRACTOR'S INDEPENDENTLY RETAINED EMPLOYEE OR SAFETY CONSULTANT SHALL IMPLEMENT A TRENCH SAFETY PROGRAM IN ACCORDANCE WITH OSHA STANDARDS GOVERNING THE PRESENCE AND ACTIVITIES OF INDIVIDUALS WORKING IN AND AROUND TRENCH EXCAVATION.

DATE: \_\_\_\_\_

NO. REVISION: \_\_\_\_\_

11-20-2023

STATE OF TEXAS  
JOCELYN PEREZ  
98367  
PROFESSIONAL ENGINEER

*J. Perez*

**PAPE-DAWSON ENGINEERS**

1672 INDEPENDENCE DR, STE 102 | NEW BRAUNFELS, TX 78132 | 800.632.5693  
TEXAS ENGINEERING FIRM #470 | TEXAS SURVEYING FIRM #1008800

**VERAMENDI PRECINCT 18 UNIT 1**  
NEW BRAUNFELS, TEXAS

**SANITARY SEWER LINE K - PLAN & PROFILE**  
STA 8+00.00 TO 13+75.49

JOB NO. 30001-66  
DATE 07-03-2023  
DESIGNER GDL  
CHECKED [initials] DRAWN BH  
SHEET C5.23

**FOR PERMIT**











**Texas Commission on Environmental Quality  
Organized Sewage Collection System  
General Construction Notes**

**Edwards Aquifer Protection Program Construction Notes – Legal Disclaimer**

The following listed "construction notes" are intended to be advisory in nature only and do not constitute an approval or conditional approval by the Executive Director, nor do they constitute a comprehensive listing of rules or conditions to be followed during construction. Further actions may be required to achieve compliance with TCEQ regulations found in Title 30, Texas Administrative Code, Chapters 213 and 217, as well as local ordinances and regulations providing for the protection of water quality. Additionally, nothing contained in the following listed "construction notes" restricts the powers of the Executive Director, the commission or any other governmental entity to prevent, correct, or curtail activities that result or may result in pollution of the Edwards Aquifer or hydrologically connected surface waters. The holder of any Edwards Aquifer Protection Plan containing "construction notes" is still responsible for compliance with Title 30, Texas Administrative Code, Chapters 213 or any other applicable TCEQ regulation, as well as all conditions of an Edwards Aquifer Protection Plan through all phases of plan implementation. Failure to comply with any condition of the Executive Director's approval, whether or not in contradiction of any "construction notes," is a violation of TCEQ regulations and any violation is subject to administrative rules, orders, and penalties as provided under Title 30, Texas Administrative Code § 213.10 relating to Enforcement. Such violations may also be subject to civil penalties and injunction. The following listed "construction notes" in no way represent an approval exception by the Executive Director to any part of Title 30 Texas Administrative Code, Chapters 213 and 217, or any other TCEQ applicable regulation.

- This Organized Sewage Collection System (SCS) must be constructed in accordance with 30 Texas Administrative Code (TAC) §213.5(c), the Texas Commission on Environmental Quality's (TCEQ) Edwards Aquifer Rules and any local government standard specifications.
- All contractors conducting regulated activities associated with this proposed regulated project must be provided with copies of the SCS plan and the TCEQ letter indicating the specific conditions of its approval. During the course of these regulated activities, the contractors must be required to keep on-site copies of the plan and the approval letter.
- A written notice of construction must be submitted to the presiding TCEQ regional office at least 48 hours prior to the start of any regulated activities. This notice must include:
  - the name of the approved project;
  - the activity start date; and
  - the contact information of the prime contractor.
- Any modification to the activities described in the referenced SCS application following the date of approval may require the submission of an SCS application to modify this approval, including the payment of appropriate fees and all information necessary for its review and approval.
- Prior to beginning any construction activity, all temporary erosion and sedimentation (E&S) control measures must be properly installed and maintained in accordance with the manufacturers specifications. These controls must remain in place until the disturbed areas have been permanently stabilized.
- If any sensitive features are discovered during the wastewater line trenching activities, all regulated activities near the sensitive feature must be suspended immediately. The applicant must immediately notify the appropriate regional office of the TCEQ of the feature discovered. A geologist's assessment of the location and extent of the feature discovered must be reported to the appropriate regional office in writing and the applicant must submit a plan for ensuring the structural integrity of the sewer line or for modifying the proposed collection system alignment around the feature. The regulated activities near the sensitive feature may not proceed until the

TCEQ-0598 (Rev. July 15, 2015) Page 1 of 6

executive director has reviewed and approved the methods proposed to protect the sensitive feature and the Edwards Aquifer from any potentially adverse impacts to water quality while maintaining the structural integrity of the line.

- Sewer lines located within or crossing the 5-year floodplain of a drainage way will be protected from inundation and stream velocities which could cause erosion and scouring of backfill. The trench must be capped with concrete to prevent scouring of backfill, or the sewer lines must be encased in concrete. All concrete shall have a minimum thickness of 6 inches.
- Blasting procedures for protection of existing sewer lines and other utilities will be in accordance with the National Fire Protection Association criteria. Sand is not allowed as bedding or backfill in trenches that have been blasted. If any existing sewer lines are damaged, the lines must be repaired and retested.
- All manholes constructed or rehabilitated on this project must have watertight size on size resilient connectors allowing for differential settlement. If manholes are constructed within the 100-year floodplain, the cover must have a gasket and be bolted to the ring. Where gasketed manhole covers are required for more than three manholes in sequence or for more than 1500 feet, alternate means of venting will be provided. Bricks are not an acceptable construction material for any portion of the manhole.
 

The diameter of the manholes must be a minimum of four feet and the manhole for entry must have a minimum clear opening diameter of 30 inches. These dimensions and other details showing compliance with the commission's rules concerning manholes and sewer line/manhole inverts described in 30 TAC §217.55 are included on Plan Sheet C4.10.

It is suggested that entrance into manholes in excess of four feet deep be accomplished by means of a portable ladder. The inclusion of steps in a manhole is prohibited.

- Where water lines and new sewer line are installed with a separation distance closer than nine feet (i.e., water lines crossing wastewater lines, water lines paralleling wastewater lines, or water lines next to manholes) the installation must meet the requirements of 30 TAC §217.53(d) (Pipe Design) and 30 TAC §290.44(e) (Water Distribution).

Where sewers line deviate from straight alignment and uniform grade all curvature of sewer pipe must be achieved by the following procedure which is recommended by the pipe manufacturer:

If pipe flexure is proposed, the following method of preventing deflection of the joint must be used:

Specific care must be taken to ensure that the joint is placed in the center of the trench and properly bedded in accordance with 30 TAC §217.54.

- New sewage collection system lines must be constructed with stub outs for the connection of anticipated extensions. The location of such stub outs must be marked on the ground such that their location can be easily determined at the time of connection of the extensions. Such stub outs must be manufactured vyes or tees that are compatible in size and material with both the sewer line and the extension. At the time of original construction, new stub-outs must be constructed sufficiently to extend beyond the end of the street pavement. All stub-outs must be sealed with a manufactured cap to prevent leakage. Extensions that were not anticipated at the time of original construction or that are to be connected to an existing sewer line not furnished with stub outs must be connected using a manufactured saddle and in accordance with accepted plumbing techniques.

TCEQ-0598 (Rev. July 15, 2015) Page 2 of 6

If no stub-out is present an alternate method of joining laterals is shown in the detail on Plan Sheet \_\_\_ of \_\_\_. (For potential future laterals).

The private service lateral stub-outs must be installed as shown on the plan and profile sheets on Plan Sheet \_\_\_ of \_\_\_, and marked after backfilling as shown in the detail on Plan Sheet \_\_\_ of \_\_\_.

- Trenching, bedding and backfill must conform with 30 TAC §217.54. The bedding and backfill for flexible pipe must comply with the standards of ASTM D-2321, Classes IA, IB, II or III. Rigid pipe bedding must comply with the requirements of ASTM C 12 (ANSI A 106.2) classes A, B or C.
- Sewer lines must be tested from manhole to manhole. When a new sewer line is connected to an existing stub or clean-out, it must be tested from existing manhole to new manhole. If a stub or clean-out is used at the end of the proposed sewer line, no private service attachments may be connected between the last manhole and the cleanout unless it can be certified as conforming with the provisions of 30 TAC §213.5(c)(3)(E).

- All sewer lines must be tested in accordance with 30 TAC §217.57. The engineer must retain copies of all test results which must be made available to the executive director upon request. The engineer must certify in writing that all wastewater lines have passed all required testing to the appropriate regional office within 30 days of test completion and prior to use of the new collection system. Testing method will be:
  - For a collection system pipe that will transport wastewater by gravity flow, the design must specify an infiltration and exfiltration test or a low-pressure air test. A test must conform to the following requirements:
    - Low Pressure Air Test.**
      - A low pressure air test must follow the procedures described in American Society For Testing And Materials (ASTM) C-828, ASTM C-924, or ASTM F-1417 or other procedure approved by the executive director, except as to testing times as required in Table C.3 in subparagraph (C) of this paragraph or Equation C.3 in subparagraph (B)(i) of this paragraph.
      - For sections of collection system pipe less than 36 inch average inside diameter, the following procedure must apply, unless a pipe is to be tested as required by paragraph (2) of this subsection.
        - A pipe must be pressurized to 3.5 pounds per square inch (psi) greater than the pressure exerted by groundwater above the pipe.
        - Once the pressure is stabilized, the minimum time allowable for the pressure to drop from 3.5 psi gauge to 2.5 psi gauge is computed from the following equation:

$$T = \frac{0.085 \times D \times K}{Q}$$

Where:

T = time for pressure to drop 1.0 pound per square inch gauge in seconds

K = 0.000419 X D X L, but not less than 1.0

D = average inside pipe diameter in inches

L = length of line of same size being tested, in feet

Q = rate of loss, 0.0015 cubic feet per minute per square foot internal surface

- Since a K value of less than 1.0 may not be used, the minimum testing time for each pipe diameter is shown in the following Table C.3:

TCEQ-0598 (Rev. July 15, 2015) Page 3 of 6

Pipe Diameter (inches)	Minimum Time (seconds)	Maximum Length for Minimum Time (feet)	Time for Longer Length (seconds/foot)
6	340	398	0.855
8	454	298	1.520
10	567	239	2.374
12	680	199	3.419
15	850	159	5.342
18	1020	133	7.693
21	1190	114	10.471
24	1360	100	13.676
27	1530	88	17.309
30	1700	80	21.369
33	1870	72	25.856

- An owner may stop a test if no pressure loss has occurred during the first 25% of the calculated testing time.
  - If any pressure loss or leakage has occurred during the first 25% of a testing period, then the test must continue for the entire test duration as outlined above or until failure.
  - Wastewater collection system pipes with a 27 inch or larger average inside diameter may be air tested at each joint instead of following the procedure outlined in this section.
  - A testing procedure for pipe with an inside diameter greater than 33 inches must be approved by the executive director.
- Infiltration/Exfiltration Test.**
    - The total exfiltration, as determined by a hydrostatic head test, must not exceed 50 gallons per inch of diameter per mile of pipe per 24 hours at a minimum test head of 2.0 feet above the crown of a pipe at an upstream manhole.
    - An owner shall use an infiltration test in lieu of an exfiltration test when pipes are installed below the groundwater level.
    - The total exfiltration, as determined by a hydrostatic head test, must not exceed 50 gallons per inch diameter per mile of pipe per 24 hours at a minimum test head of two feet above the crown of a pipe at an upstream manhole, or at least two feet above existing groundwater level, whichever is greater.
    - For construction within a 25-year flood plain, the infiltration or exfiltration must not exceed 10 gallons per inch diameter per mile of pipe per 24 hours at the same minimum test head as in subparagraph (C) of this paragraph.
    - If the quantity of infiltration or exfiltration exceeds the maximum quantity specified, an owner shall undertake remedial action in order to reduce

TCEQ-0598 (Rev. July 15, 2015) Page 4 of 6

the infiltration or exfiltration to an amount within the limits specified. An owner shall retest a pipe following a remediation action.

- If a gravity collection pipe is composed of flexible pipe, deflection testing is also required. The following procedures must be followed:
  - For a collection pipe with inside diameter less than 27 inches, deflection measurement requires a rigid mandrel.
    - Mandrel Sizing.**
      - A rigid mandrel must have an outside diameter (OD) not less than 95% of the base inside diameter (ID) or average ID of a pipe, as specified in the appropriate standard by the ASTMs, American Water Works Association, UNI-BELL, or American National Standards Institute, or any related appendix.
      - If a mandrel sizing diameter is not specified in the appropriate standard, the mandrel must have an OD equal to 95% of the ID of a pipe. In this case, the ID of the pipe, for the purpose of determining the OD of the mandrel, must equal be the average outside diameter minus two minimum wall thicknesses for OD controlled pipe and the average inside diameter for ID controlled pipe.
    - All dimensions must meet the appropriate standard.
  - Mandrel Design.**
    - A rigid mandrel must be constructed of a metal or a rigid plastic material that can withstand 200 psi without being deformed.
    - A mandrel must have nine or more odd number of runners or legs.
    - A barrel section length must equal at least 75% of the inside diameter of a pipe.
    - Each size mandrel must use a separate proving ring.
  - Method Options.**
    - An adjustable or flexible mandrel is prohibited.
    - A test may not use television inspection as a substitute for a deflection test.
    - If requested, the executive director may approve the use of a deflectometer or a mandrel with removable legs or runners on a case-by-case basis.
  - For a gravity collection system pipe with an inside diameter 27 inches and greater, other test methods may be used to determine vertical deflection.
    - A deflection test method must be accurate to within plus or minus 0.2% deflection.
    - An owner shall not conduct a deflection test until at least 30 days after the final backfill.
    - Gravity collection system pipe deflection must not exceed five percent (5%).
    - If a pipe section fails a deflection test, an owner shall correct the problem and conduct a second test after the final backfill has been in place at least 30 days.

- All manholes must be tested to meet or exceed the requirements of 30 TAC §217.58.
  - All manholes must pass a leakage test.
  - An owner shall test each manhole (after assembly and backfilling) for leakage, separate and independent of the collection system pipes, by hydrostatic exfiltration testing, vacuum testing, or other method approved by the executive director.
  - Hydrostatic Testing.
    - The maximum leakage for hydrostatic testing or any alternative test methods is 0.025 gallons per foot diameter per foot of manhole depth per hour.
    - To perform a hydrostatic exfiltration test, an owner shall seal all wastewater pipes coming into a manhole with an internal pipe plug, fill the manhole with water, and maintain the test for at least one hour.
    - A test for concrete manholes may use a 24-hour wetting period before testing to allow saturation of the concrete.

TCEQ-0598 (Rev. July 15, 2015) Page 5 of 6

- Vacuum Testing.**
  - To perform a vacuum test, an owner shall plug all lift holes and exterior joints with a non-shrink grout and plug all pipes entering a manhole.
  - No grout must be placed in horizontal pipes before testing.
  - Stub-outs, manhole boots, and pipe plugs must be secured to prevent movement while a vacuum is drawn.
  - An owner shall use a minimum 60 inch/lb torque wrench to tighten the external clamps that secure a test cover to the top of a manhole.
  - A test head must be placed at the inside of the top of a cone section, and the seal inflated in accordance with the manufacturer's recommendations.
  - There must be a vacuum of 10 inches of mercury inside a manhole to perform a valid test.
  - A test does not begin until after the vacuum pump is off.
  - A manhole passes the test if after 2.0 minutes and with all valves closed, the vacuum is at least 9.0 inches of mercury.

- All private service laterals must be inspected and certified in accordance with 30 TAC §213.5(c)(3)(I). After installation of, and, prior to covering and connecting a private service lateral to an existing organized sewage collection system, a Texas Licensed Professional Engineer, Texas Registered Sanitarian, or appropriate city inspector must visually inspect the private service lateral and the connection to the sewage collection system, and certify that it is constructed in conformity with the applicable provisions of this section. The owner of the collection system must maintain such certifications for five years and forward copies to the appropriate regional office upon request. Connections may only be made to an approved sewage collection system.

Austin Regional Office 12100 Park 35 Circle, Building A Austin, Texas 78753-1808 Phone (512) 339-2929 Fax (512) 339-3795	San Antonio Regional Office 14250 Judson Road San Antonio, Texas 78233-4480 Phone (210) 490-3096 Fax (210) 545-4329
--	---

**THESE GENERAL CONSTRUCTION NOTES MUST BE INCLUDED ON THE CONSTRUCTION PLANS PROVIDED TO THE CONTRACTOR AND ALL SUBCONTRACTORS.**

TCEQ-0598 (Rev. July 15, 2015) Page 6 of 6

**WASTEWATER NOTES:**

- The contractor shall maintain service to existing wastewater system at all times during construction.
- A minimum of 8" wastewater pipe and fittings (P.V.C. SDR-26, ASTM, D-3034, D-3212, F-477) are required on new installation.
- All residential wastewater service laterals shall be extended to the property line and a cleanout shall be installed at the property line. Services to lots will extend four (4) feet past the underground electric conduit if electric is installed in the front easement. All sewer cleanouts that lead to NBU mains shall be installed with a protective vitreous and pivoting marker pole during time of construction.
- Pipe bedding of wastewater lines shall be manufactured sand or pea gravel as per NBU specifications.
- Secondary backfill of wastewater lines shall generally consist of materials removed from the trench and shall be free from brush, debris and trash, no rocks or stones having any dimension larger than 6 inches at the largest dimension.
- All wastewater pipes shall have compression or mechanical joints as per 30 TAC §217.53 (c) (2).
- For wastewater lines less than 24" in diameter, select initial backfill material shall be placed in two lifts.
  - The first lift shall be spread uniformly and simultaneously on each side and under the shoulders of the pipe to the mid point or spring line of the pipe.
  - The second lift shall be placed to a depth as shown on the pipe backfill detail. For pipes larger than 24", 12" maximum lifts shall be used.
- All manholes must be water tight, either monolithic, cast-in-place concrete structures or prefabricated manholes specifically approved by NBU. The manholes shall have water-tight risers and covers. Wherever they are within the 100 year floodplain, the manhole covers shall be bolted. Every third manhole in sequence shall have an alternate means of venting. 30 TAC §213.5 (c) (3) (A) and 30 TAC §217.55 (e).
- All manholes shall be constructed so that the top of the ring is two inches (2") above surrounding ground except when located in paved area. In paved areas, the manhole ring shall be flush with pavement.
- All new manholes, unless approved by NBU Engineering, are to have covers with 32" openings.
- Wastewater pipe connections to pre-cast manholes will be compression joints or mechanical "boot type" joint as approved by NBU.
- Wastewater lines shall be tested from manhole to manhole.
- In areas where a new wastewater manhole is to be constructed over an existing wastewater system, it shall be the contractor's responsibility to test existing manholes before construction. After the proposed manhole(s) has been built, the contractor shall re-test the existing system to the satisfaction of the construction inspector. (no separate pay item).
- Where the minimum 9 foot separation distance between wastewater lines and water lines / mains cannot be maintained, the installation of wastewater lines shall be in strict accordance with TCEQ. The wastewater line shall be constructed of ductile iron, ductile iron or PVC meeting the ASTM specification for both pipes and joints of 150 psi and shall be in accordance with 30 TAC §217.53 (d) (3) (A) (i).
- No testing will be performed prior to 30 days from complete installation of the wastewater lines. The following sequence will be strictly adhered to:
  - Pull mandrel
  - Perform Air test
  - Cleaning of any debris
  - Flushing of system
  - TV inspection (within 72 hours of flushing)
- A minimum of 3 feet of cover is to be maintained over the wastewater main and laterals at subgrade, otherwise concrete encasement will be required.
- Wastewater main connections made directly to existing manholes will require successful testing of the manhole in accordance with NBU Construction & Construction Policy Manual.
- TCEQ and EPA require erosion and sedimentation control for construction of wastewater collection systems. Developer or authorized representative shall provide erosion and sedimentation control as notes on the project's plan and profile sheets. All temporary erosion and sedimentation controls shall be removed by the Contractor at final acceptance of the project by NBU Water Systems.
- All manholes not within paved streets shall have locking concrete collar to secure ring and cover to manhole cone per NBU Detail drawing #329.
- All manholes over the Edwards Aquifer Recharge Zone shall have locking concrete collar to secure ring and cover to manhole cone per NBU detail drawing #329.

Appendix/Appendix B Approved 12/9/03, Rev 3/1/20 Page 2 of 2

**CITY OF NEW BRAUNFELS UTILITY NOTES**

- NO VALVES, HYDRANTS, ETC. SHALL BE CONSTRUCTED WITHIN CURBS, SIDEWALKS, OR DRIVEWAYS.
- ALL UTILITIES TO BE CONSTRUCTED PRIOR TO STREETS.
- THIS PROJECT INCLUDES UTILITY INSTALLATIONS GREATER THAN 5-FEET IN DEPTH. DEEP TRENCHES POSE COMPACTION TESTING AND CONSTRUCTION CHALLENGES AND CITY METHODS FOR TESTING AND COMPACTION MAY NOT BE ACHIEVABLE. A UTILITY COMPACTION PLAN WILL BE REQUIRED AND MUST BE SUBMITTED FOR APPROVAL TO CITY PRIOR TO UTILITY INSTALLATION.
- UTILITY TRENCH COMPACTION – ALL UTILITY TRENCH COMPACTION TESTS WITHIN THE STREET PAVEMENT/SIDEWALK SECTION SHALL BE THE RESPONSIBILITY OF THE DEVELOPER'S GEOTECHNICAL ENGINEER. FILL MATERIAL SHALL BE PLACED IN UNIFORM LAYERS NOT TO EXCEED TWELVE INCHES (12") LOOSE. DETERMINE THE MAXIMUM LIFT THICKNESS BASED ON THE ABILITY OF THE COMPACTING OPERATION AND EQUIPMENT USED TO MEET THE REQUIRED DENSITY. EACH LAYER OF MATERIAL SHALL BE COMPACTED TO A MINIMUM 95% DENSITY AND TESTED FOR DENSITY AND MOISTURE IN ACCORDANCE WITH TEST METHODS TEX-113-E, TEX-114-E, TEX-115-E. THE NUMBER AND LOCATION OF REQUIRED TESTS SHALL BE DETERMINED BY THE GEOTECHNICAL ENGINEER AND APPROVED BY THE CITY OF NEW BRAUNFELS STREET INSPECTOR. AT A MINIMUM, TESTS SHALL BE TAKEN EVERY 200 LF FOR EACH LIFT AND EVERY OTHER SERVICE LINE. UPON COMPLETION OF TESTING THE GEOTECHNICAL ENGINEER SHALL PROVIDE THE CITY OF NEW BRAUNFELS STREET INSPECTOR WITH ALL TESTING DOCUMENTATION AND A CERTIFICATION STATING THAT THE PLACEMENT OF FILL MATERIAL HAS BEEN COMPLETED IN ACCORDANCE WITH THE PLANS. ADDITIONAL DENSITY TESTS MAY BE REQUESTED BY THE CITY OF NEW BRAUNFELS INSPECTOR.

**NBU WATER CONNECTION POLICY GENERAL NOTES**

- ALL MATERIALS AND CONSTRUCTION PROCEDURES WITHIN THE SCOPE OF THE PROJECT SHALL BE APPROVED BY NEW BRAUNFELS UTILITIES AND COMPLY WITH THE CURRENT NEW BRAUNFELS UTILITIES WATER SYSTEMS CONNECTION/CONSTRUCTION POLICIES WATER SYSTEMS.
- CONTRACTOR SHALL NOT PROCEED WITH ANY PIPE INSTALLATION WORK UNTIL THEY OBTAIN A COPY OF THE PLANS FROM THE CONSULTANT OR ENGINEER AND NOTIFY NBU WATER SYSTEMS ENGINEERING AT 830-608-8971 WITH AT LEAST THREE (3) WORKING DAYS PRIOR TO THE START OF WORK COMPLETED BY THE CONTRACTOR, WHICH HAS NOT RECEIVED A NOTICE TO PROCEED WITH NEW BRAUNFELS UTILITIES WATER SYSTEMS ENGINEERING WILL BE SUBJECT TO REMOVAL AND REPLACEMENT BY AND AT THE EXPENSE OF THE CONTRACTOR.
- THE DEVELOPER DEDICATES THE WATER / WASTEWATER MAINS UPON COMPLETION BY THE DEVELOPER AND ACCEPTANCE BY THE NEW BRAUNFELS UTILITIES WATER SYSTEM. NBU WILL OWN AND MAINTAIN SAID WATER / WASTEWATER MAINS WHICH ARE LOCATED WITHIN SAID PARTICULAR SUBDIVISION. (AS APPLICABLE).
- CONTRACTOR AGREES TO ASSUME SOLE AND COMPLETE RESPONSIBILITY FOR JOB SITE CONDITIONS DURING THE CONSTRUCTION OF THE PROJECT, INCLUDING SAFETY OF ALL PERSONS AND PROPERTY. THIS REQUIREMENT SHALL APPLY CONTINUOUSLY AND NOT BE LIMITED TO NORMAL WORKING HOURS. THE CONTRACTOR SHALL DEFEND, INDEMNIFY AND HOLD THE OWNERS AND THE ENGINEER AND HIS EMPLOYEES, PARTNERS OFFICERS, DIRECTORS, OR CONSULTANTS HARMLESS FROM ANY AND ALL LIABILITY, REAL OR LEGAL, IN CONNECTION WITH THE PERFORMANCE OF THE WORK ON THE PROJECT, EXCEPTING FROM LIABILITY ARISING FROM SOLE NEGLIGENCE OF THE OWNER OR ENGINEER, ENGINEERS DIRECTORS, OFFICERS, EMPLOYEES, OR CONSULTANTS.
- CONTRACTOR AND / OR CONTRACTOR'S INDEPENDENTLY RETAINED EMPLOYEE OR SAFETY CONSULTANT SHALL IMPLEMENT A TRENCH SAFETY PROGRAM IN ACCORDANCE WITH OSHA STANDARDS GOVERNING THE PRESENCE AND ACTIVITIES OF INDIVIDUALS WORKING IN AND AROUND TRENCH EXCAVATION.
- CONTRACTOR SHALL BE RESPONSIBLE FOR RESTORING TO ITS ORIGINAL OR BETTER CONDITION, ANY DAMAGES DONE TO EXISTING FENCES, CURBS, STREETS, DRIVEWAYS, LANDSCAPING AND STRUCTURES, AND EXISTING UTILITIES (NOT ADJUSTED ON PLANS). COST OF RESTORATIONS, IF ANY, SHALL BE THE CONTRACTOR'S ENTIRE EXPENSE.
- THE CONTRACTOR SHALL AVOID CUTTING ROOTS LARGER THAN ONE INCH IN DIAMETER WHEN EXCAVATING NEAR EXISTING TREES. EXCAVATION IN VICINITY OF TREES SHALL PROCEED WITH CAUTION.
- CONTRACTOR SHALL OBTAIN ALL PERMITS AND LICENSES, PAY ALL CHARGES, FEES AND TAXES AND GIVE ALL NOTICES NECESSARY AND INCIDENTAL TO THE DUE AND LAWFUL PROSECUTION OF THE WORK.
- NO EXTRA PAYMENT SHALL BE ALLOWED FOR WORK CALLED FOR ON THE PLANS BUT NOT INCLUDED ON THE BID SCHEDULE. THIS INCIDENT WORK WILL BE REQUIRED AND SHALL BE INCLUDED UNDER THE PAY ITEM TO WHICH IT RELATES.
- CONTRACTOR IS RESPONSIBLE FOR REMOVAL OF ALL WASTE MATERIALS UPON PROJECT COMPLETION. THE CONTRACTOR SHALL NOT PERMANENTLY PLACE ANY WASTE MATERIALS IN THE 100-YEAR FLOOD PLAIN WITHOUT FIRST OBTAINING AN APPROVED FLOOD PLAN DEVELOPMENT PERMIT.
- THE CONTRACTOR SHALL NOT PLACE ANY MATERIALS ON THE RECHARGE ZONE OF THE EDWARDS AQUIFER WITHOUT AN APPROVED WATER POLLUTION ABATEMENT PLAN FROM THE TCEQ 31 TAC 313.4 AND 31 TAC 313.9.
- BARRICADES AND WARNING SIGNS SHALL CONFORM TO THE TEXAS MANUAL ON UNIFORM TRAFFIC CONTROL DEVICES AND SHALL BE LOCATED TO PROVIDE MAXIMUM PROTECTION TO THE PUBLIC AS WELL AS CONSTRUCTION PERSONNEL AND EQUIPMENT WHILE PROVIDING CONTINUOUS TRAFFIC FLOW AT ALL TIMES DURING CONSTRUCTION. THE CONTRACTOR IS RESPONSIBLE FOR MAINTAINING ALL DEVICES DURING CONSTRUCTION.
- CONTRACTOR IS REQUIRED TO VERIFY PROJECT ELEVATIONS. THE TERM "MATCH EXISTING" SHALL BE UNDERSTOOD TO SIGNIFY BOTH HORIZONTAL AND VERTICAL ALIGNMENT.
- THE LOCATION OF UTILITIES, EITHER UNDERGROUND OR OVERHEAD, SHOWN WITHIN THE RIGHT OF WAY ARE APPROXIMATE AND SHALL BE VERIFIED BY THE CONTRACTOR BEFORE BEGINNING CONSTRUCTION OPERATIONS.
- OSHA REGULATIONS PROHIBIT OPERATIONS THAT WILL BRING PERSONS OR EQUIPMENT WITHIN 10 FEET OF AN ENERGIZED LINE. WHERE WORKMEN AND/OR EQUIPMENT HAVE TO WORK CLOSE TO AN ENERGIZED ELECTRICAL LINE, THE CONTRACTOR SHALL NOTIFY THE ELECTRICAL POWER COMPANY INVOLVED AND MAKE WHATEVER ADJUSTMENTS NECESSARY TO ENSURE THE SAFETY OF THOSE WORKMEN.
- IT SHALL BE THE CONTRACTOR'S RESPONSIBILITY TO LOCATE UTILITY SERVICE LINES AS REQUIRED FOR CONSTRUCTION. UTILITY COMPANIES ARE ALSO PREVIOUSLY MENTIONED IN UTILITY COMPANY NOTIFICATION.
- DUE TO FEDERAL REGULATIONS TITLE 49, PART 192 (B), GAS COMPANIES MUST MAINTAIN ACCESS TO GAS VALVES AT ALL TIMES. THE CONTRACTOR MUST PROTECT AND WORK AROUND ANY GAS VALVES THAT ARE IN THE PROJECT AREA.
- THE CONTRACTOR IS FULLY RESPONSIBLE FOR THE TRAFFIC CONTROL AND SHALL BE RESPONSIBLE FOR FURNISHING ALL TRAFFIC CONTROL DEVICES AND FLAGGERS. THE CONSTRUCTION METHODS SHALL BE CONDUCTED TO PROVIDE THE LEAST POSSIBLE INTERFERENCE TO TRAFFIC SO AS TO PERMIT THE CONTINUOUS MOVEMENT OF THE TRAFFIC IN ONE DIRECTION AT ALL TIMES. THE CONTRACTOR SHALL CLEAN UP AND REMOVE FROM THE WORK AREA ANY LOOSE MATERIAL RESULTING FROM CONTRACT OPERATIONS AT THE END OF EACH WORKDAY.
- PRIOR TO ORDERING MATERIALS TO BE USED IN CONSTRUCTION, CONTRACTOR SHALL PROVIDE THE ENGINEER WITH FOUR (4) COPIES OF THE SOURCE, TYPE, GRADATION, MATERIAL SPECIFICATION DATA AND / OR SHOP DRAWINGS, AS APPLICABLE, TO SATISFY THE REQUIREMENTS OF THE FOLLOWING ITEMS AND ALL MATERIAL ITEMS REFERRED TO IN THESE LISTED ITEMS:
  - WATER MAINS AND SERVICES
  - SEWER MAINS AND SERVICES
- NO METER BOXES TO BE SET IN DRIVEWAYS. ANY METER BOXES SET IN DRIVEWAYS WILL BE RELOCATED AT CONTRACTOR'S AND/OR DEVELOPER'S EXPENSE.
- WHERE THE MINIMUM 9 FOOT SEPARATION DISTANCE BETWEEN SEWER LINES AND WATER LINES / MAINS CANNOT BE MAINTAINED, THE INSTALLATION OF SEWER LINES SHALL BE IN STRICT ACCORDANCE WITH TCEQ.
- CONTRACTOR AND/OR CONTRACTOR'S INDEPENDENTLY RETAINED EMPLOYEE OR STRUCTURAL DESIGN/GEOTECHNICAL/SAFETY/EQUIPMENT CONSULTANT, IF ANY, SHALL REVIEW THESE PLANS AND AVAILABLE GEOTECHNICAL INFORMATION AND THE ANTICIPATED INSTALLATION SITE(S) WITHIN THE PROJECT WORK AREA IN ORDER TO IMPLEMENT CONTRACTOR'S TRENCH EXCAVATION SAFETY PROTECTION SYSTEMS, PROGRAMS AND/OR PROCEDURES. THE CONTRACTOR'S IMPLEMENTATION OF THE SYSTEMS, PROGRAMS AND/OR PROCEDURES SHALL PROVIDE FOR ADEQUATE TRENCH EXCAVATION SAFETY PROTECTION THAT COMPLIES WITH AS A MINIMUM, OSHA STANDARDS FOR TRENCH EXCAVATIONS. SPECIFICALLY, CONTRACTOR AND/OR CONTRACTOR'S INDEPENDENTLY RETAINED EMPLOYEE OR SAFETY CONSULTANT SHALL IMPLEMENT A TRENCH SAFETY PROGRAM IN ACCORDANCE WITH OSHA STANDARDS GOVERNING THE PRESENCE AND ACTIVITIES OF INDIVIDUALS WORKING IN AND AROUND TRENCH EXCAVATION.
- UTILITY TRENCH COMPACTION WITH STREET R.O.W.

- ALL UTILITY TRENCH COMPACTION TEST WITHIN THE STREET PAVEMENT SECTION SHALL BE THE RESPONSIBILITY OF THE DEVELOPER'S GEO-TECHNICAL ENGINEER.
- FILL MATERIAL SHALL BE PLACED IN UNIFORM LAYERS NOT TO EXCEED TWELVE INCHES (12") LOOSE.
- EACH LAYER OF MATERIAL SHALL BE COMPACTED AS SPECIFIED AND TESTED FOR DENSITY AND MOISTURE IN ACCORDANCE WITH TEXT METHODS TEX-113-E, TEX-114-E, TEX-115-E.
- THE NUMBER AND LOCATION OF REQUIRED TESTS SHALL BE DETERMINED BY THE GEO-TECHNICAL ENGINEER AND APPROVED BY THE CITY OF NEW BRAUNFELS STREET INSPECTOR.
- UPON COMPLETION OF TESTING THE GEO-TECHNICAL ENGINEER SHALL PROVIDE THE CITY OF NEW BRAUNFELS STREET INSPECTOR WITH ALL TESTING DOCUMENTATION AND A CERTIFICATION STATING THAT THE PLACEMENT OF FILL MATERIAL HAS BEEN COMPLETED IN ACCORDANCE WITH THE PLANS.

DATE: \_\_\_\_\_

NO. \_\_\_\_\_

REVISION: \_\_\_\_\_

6-28-2023

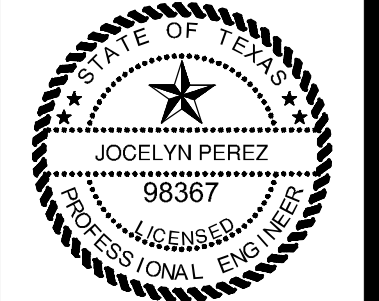

Jocelyn Perez  
Professional Engineer

**PAPE-DAWSON ENGINEERS**

1672 INTERPURCHASE DR. STE 102 | NEW BRAUNFELS, TX 78132 | 800.632.5693  
TEXAS ENGINEERING FIRM #479 | TEXAS SURVEYING FIRM #1008890

**VERAMENDI PRECINCT 18 UNIT 1**

**NEW BRAUNFELS, TEXAS**

**SANITARY SEWER NOTES**

PLAT NO.	
JOB NO.	30001-66
DATE	07-03-2023
DESIGNER	GDL
CHECKED	GL
DRAWN	BH
SHEET	C5.40

**FOR PERMIT**

Date: Jun 28, 2023, 4:23pm User ID: corcher  
File: P:\3001\01\GE\Design\Civil\SSNT-30001-66.dwg



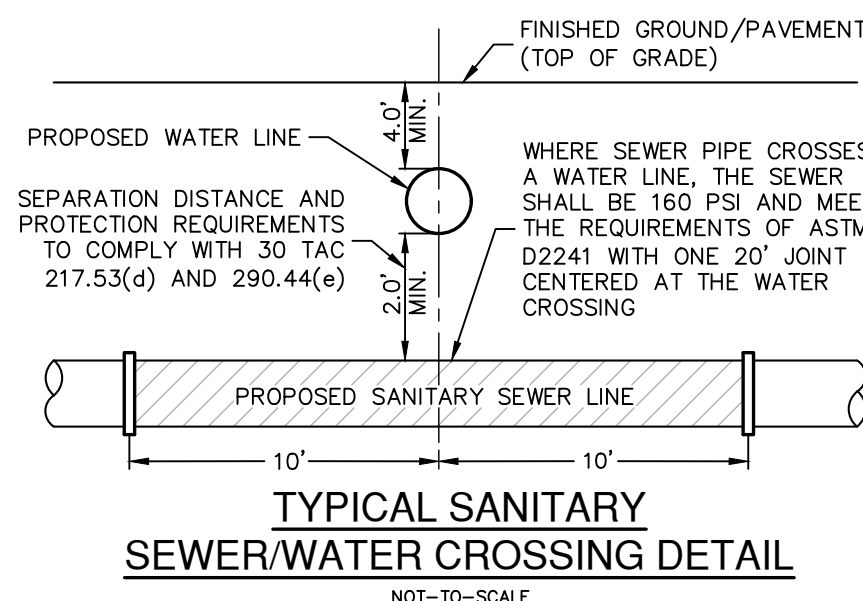

WASTEWATER (NBU JOB NO. WW-226996)		
ITEM	UNIT	QUANTITY
8" SANITARY SEWER PIPE	LF	11,445
LUES	EA	215
6" WASTEWATER SERVICE	EA	215
48" MANHOLES	EA	62

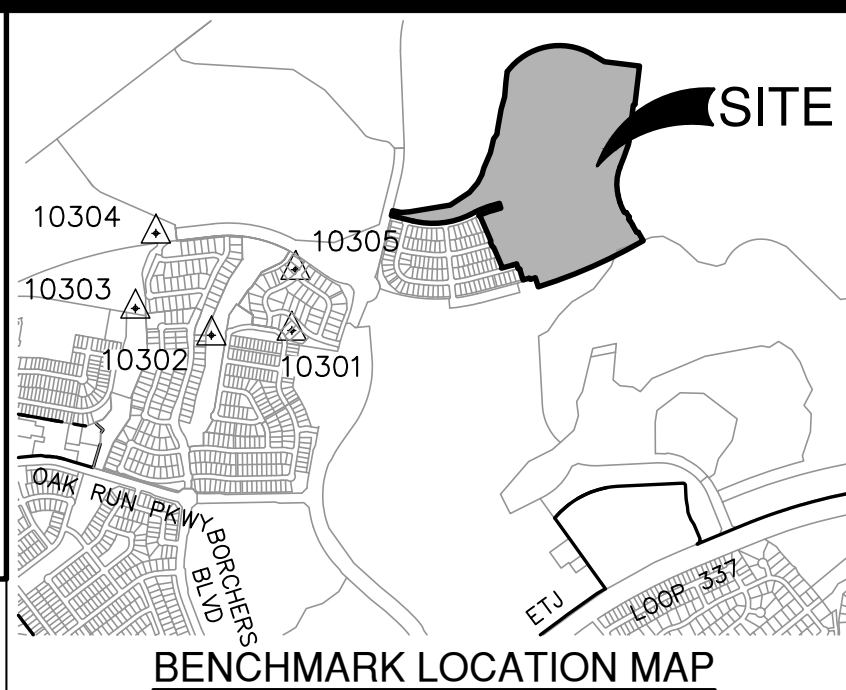
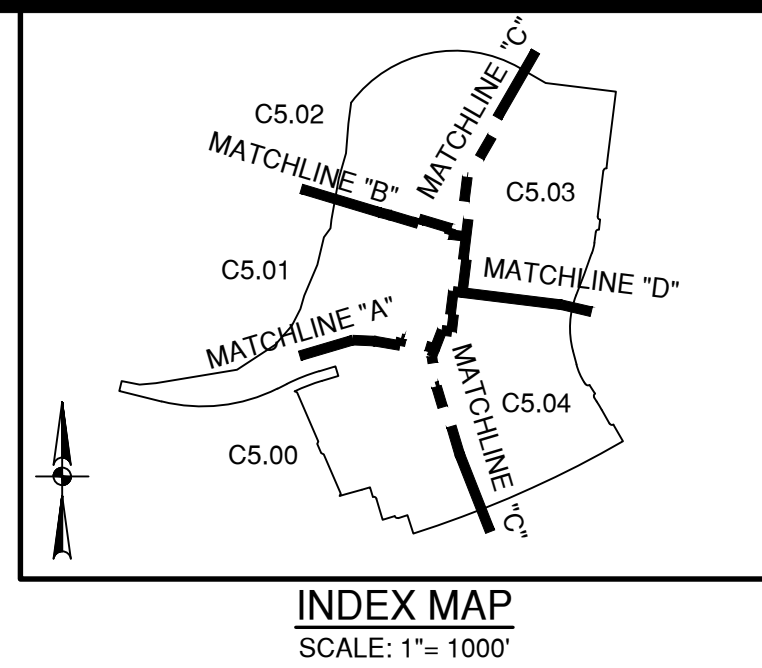

BENCHMARKS				
HORIZONTAL AND VERTICAL CONTROL POINTS				
Point #	Northing	Easting	Elevation	Full Description
10300	13819253.76	2237967.00	787.38	SET I.R. REDCAP (TRAV)
10301	13816937.43	2237678.90	782.13	SET I.R. REDCAP (TRAV)
10302	13816887.26	2236841.89	758.22	SET I.R. REDCAP (TRAV)
10303	1381766.65	2236500.01	763.76	SET MAG NAL (TRAV)
10304	13817949.35	2236263.15	751.35	SET MAG NAL (TRAV)
10305	13817569.78	2237177.86	753.14	SET MAG NAL (TRAV)

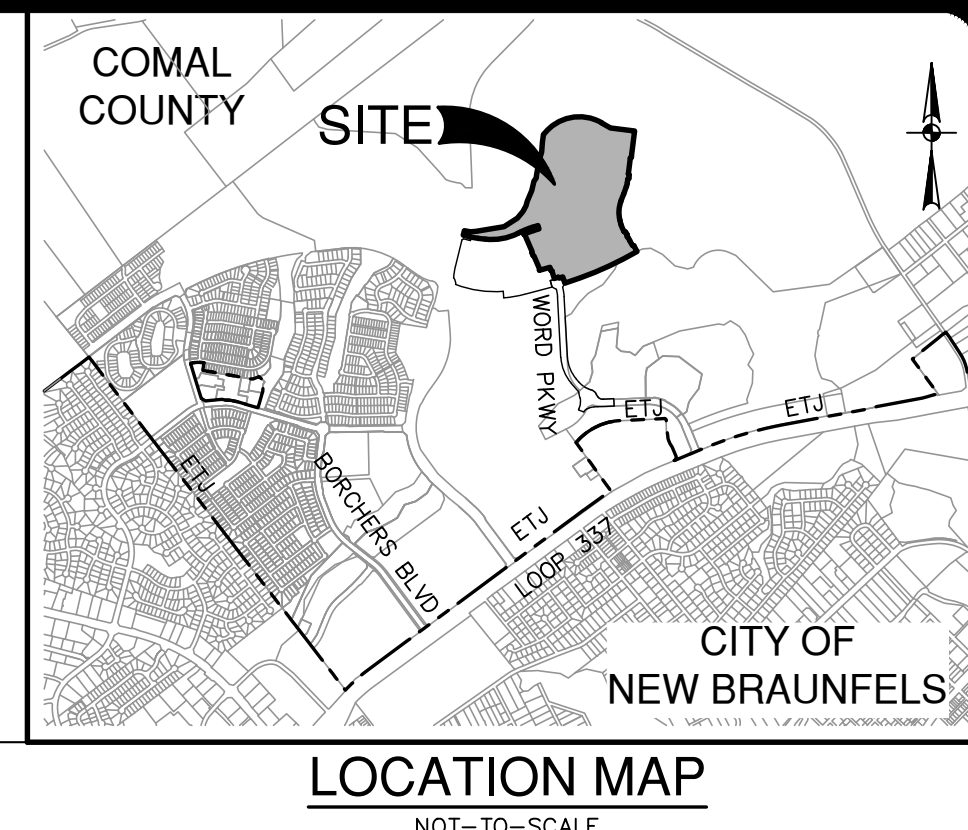

DATE	NO.	REVISION

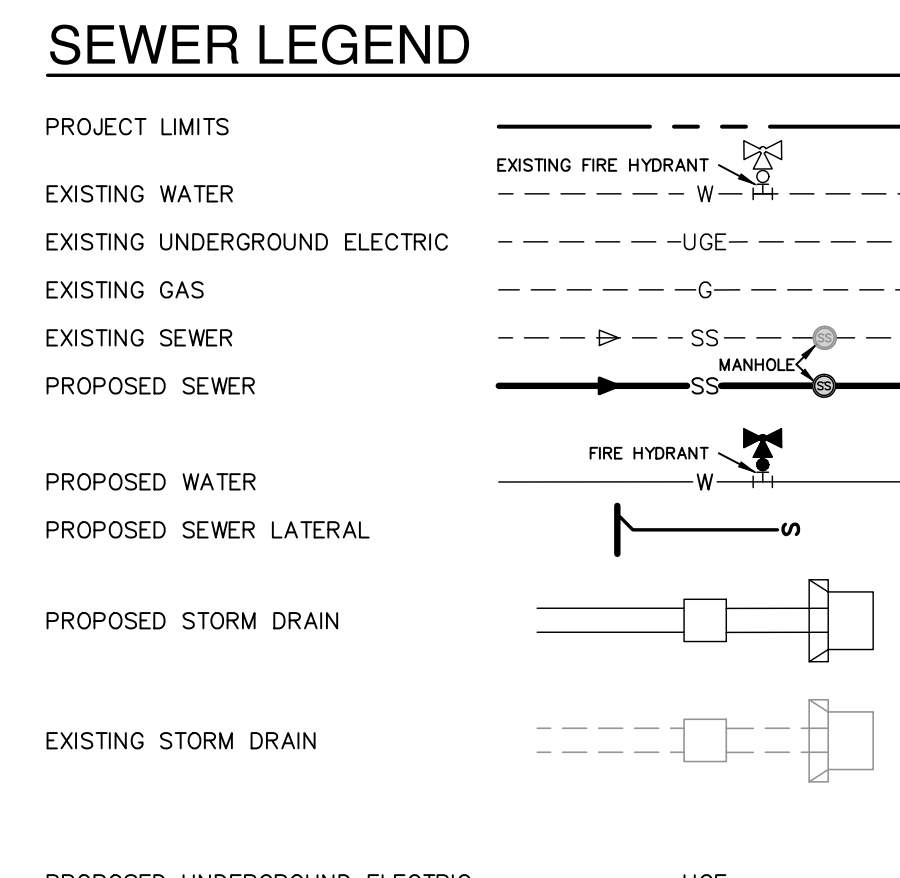
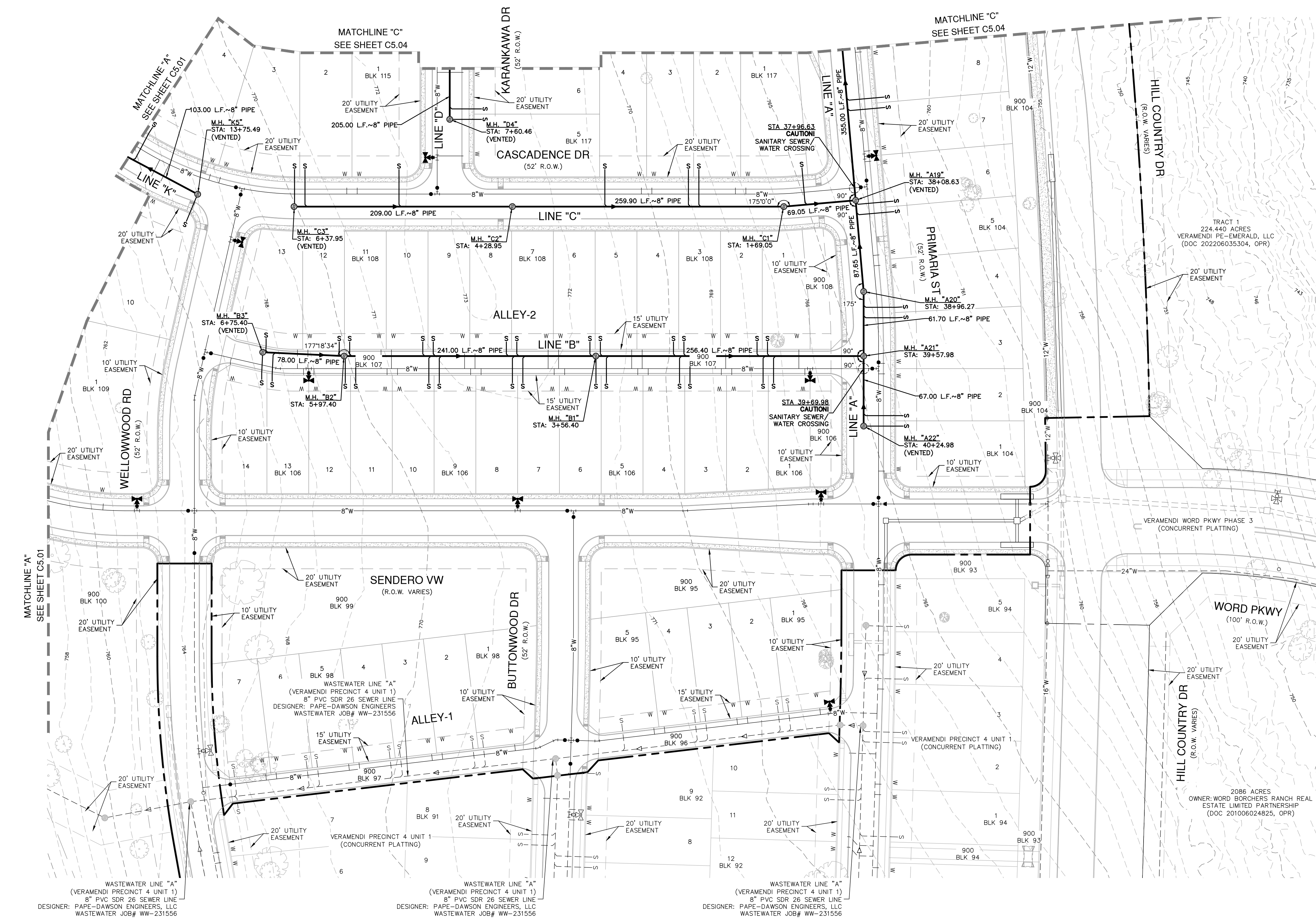
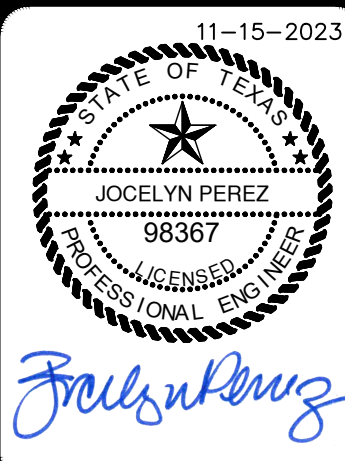

**FLOODPLAIN NOTE**  
 1. NO PORTION OF ANY LOT ON THIS PROJECT IS WITHIN AN INDICATED SPECIAL FLOOD HAZARD ZONE ACCORDING TO THE FEMA FIRM MAP NO. 48091C0435F EFFECTIVE DATE 9/2/2009.

**CITY OF NEW BRAUNFELS NOTES**  
 1. NO VALVES, HYDRANTS, ETC. SHALL BE CONSTRUCTED WITHIN CURBS, SIDEWALKS, OR DRIVEWAYS.  
 2. ALL UTILITIES TO BE CONSTRUCTED PRIOR TO STREETS.  
 3. THIS PROJECT INCLUDES UTILITY INSTALLATIONS GREATER THAN 5- FEET IN DEPTH. DEEP TRENCHES POSE COMPACTION TESTING AND CONSTRUCTION CHALLENGES AND CITY METHODS FOR TESTING AND COMPACTION MAY NOT BE ACHIEVABLE. A UTILITY COMPACTION PLAN WILL BE REQUIRED AND MUST BE SUBMITTED FOR APPROVAL TO CITY PRIOR TO UTILITY INSTALLATION.  
 4. UTILITY TRENCH COMPACTION - ALL UTILITY TRENCH COMPACTION TESTS WITHIN THE STREET PAVEMENT/SIDEWALK SECTION SHALL BE THE RESPONSIBILITY OF THE DEVELOPER'S GEOTECHNICAL ENGINEER. FILL MATERIAL SHALL BE PLACED IN UNIFORM LAYERS NOT TO EXCEED TWELVE INCHES (12") THICK. DETERMINE THE MAXIMUM LIFT THICKNESS BASED ON THE ABILITY OF THE COMPACTION OPERATION AND EQUIPMENT USED TO MEET THE REQUIRED DENSITY. EACH LAYER OF MATERIAL SHALL BE COMPACTED TO A MINIMUM 95% DENSITY AND TESTED FOR DENSITY AND MOISTURE IN ACCORDANCE WITH TEST METHODS TEX-113-E, TEX-114-E, TEX-115-E. THE NUMBER AND LOCATION OF REQUIRED TESTS SHALL BE DETERMINED BY THE GEOTECHNICAL ENGINEER AND APPROVED BY THE CITY OF NEW BRAUNFELS STREET INSPECTOR. AT A MINIMUM, TESTS SHALL BE TAKEN EVERY 200 LF FOR EACH LIFT AND EVERY OTHER SERVICE LINE. UPON COMPLETION OF TESTING THE GEOTECHNICAL ENGINEER SHALL PROVIDE THE CITY OF NEW BRAUNFELS STREET INSPECTOR WITH ALL TESTING DOCUMENTATION AND A CERTIFICATION STATING THAT THE PLACEMENT OF FILL MATERIAL HAS BEEN COMPLETED IN ACCORDANCE WITH THE PLANS. ADDITIONAL DENSITY TESTS MAY BE REQUESTED BY THE CITY OF NEW BRAUNFELS INSPECTOR.

**CAUTION!!**  
 CONTRACTOR SHALL BE REQUIRED TO LOCATE ALL PUBLIC OR PRIVATE UTILITIES INCLUDING BUT NOT LIMITING TO: WATER, SEWER, TELEPHONE AND FIBER OPTIC LINES, SITE LIGHTING ELECTRIC, SECONDARY ELECTRIC, PRIMARY ELECTRICAL, DUCTS, IRRIGATION FACILITIES, AND GAS LINES. ANY UTILITY CONFLICTS THAT ARISE SHOULD BE COMMUNICATED TO THE ENGINEER IMMEDIATELY AND PRIOR TO CONSTRUCTION. THE CONTRACTOR SHALL CONTACT "TEXAS 811" A MINIMUM OF 48 HOURS PRIOR TO THE START OF CONSTRUCTION. ANY DAMAGE TO EXISTING UTILITIES SHALL BE THE SOLE RESPONSIBILITY OF THE CONTRACTOR AND THE REPAIR SHALL BE AT CONTRACTOR'S SOLE EXPENSE WHETHER THE UTILITY IS SHOWN ON THESE PLANS OR NOT.

**TRENCH EXCAVATION SAFETY PROTECTION:**  
 CONTRACTOR AND/OR CONTRACTOR'S INDEPENDENTLY RETAINED EMPLOYEE OR STRUCTURAL DESIGN/ GEOTECHNICAL/ SAFETY/EQUIPMENT CONSULTANT, IF ANY, SHALL REVIEW THESE PLANS AND ANY AVAILABLE GEOTECHNICAL INFORMATION AND THE ANTICIPATED INSTALLATION SITES WITHIN THE PROJECT WORK AREA IN ORDER TO IMPLEMENT CONTRACTOR'S TRENCH EXCAVATION SAFETY PROTECTION SYSTEMS, PROGRAMS AND /OR PROCEDURES FOR THE PROJECT DESCRIBED IN THE CONTRACT DOCUMENTS. THE CONTRACTOR'S IMPLEMENTATION OF THESE SYSTEMS, PROGRAMS AND/OR PROCEDURES SHALL PROVIDE FOR ADEQUATE TRENCH EXCAVATION SAFETY PROTECTION THAT COMPLY WITH AS A MINIMUM, OSHA STANDARDS FOR TRENCH EXCAVATIONS. SPECIFICALLY, CONTRACTOR AND/OR CONTRACTOR'S INDEPENDENTLY RETAINED EMPLOYEE OR SAFETY CONSULTANT SHALL IMPLEMENT A TRENCH SAFETY PROGRAM IN ACCORDANCE WITH OSHA STANDARDS GOVERNING THE PRESENCE AND ACTIVITIES OF INDIVIDUALS WORKING IN AND AROUND TRENCH EXCAVATION.

**PAPE-DAWSON ENGINEERS**  
 1672 INDEPENDENCE DR, STE 102 | NEW BRAUNFELS, TX 78132 | 800.632.5693  
 TEXAS ENGINEERING FIRM #470 | TEXAS SURVEYING FIRM #1008800

**VERAMENDI PRECINCT 18 UNIT 1**  
 NEW BRAUNFELS, TEXAS  
 OVERALL SANITARY SEWER PLAN

PLAT NO.	
JOB NO.	30001-66
DATE	07-03-2023
DESIGNER	GDL
CHECKED	✓ DRAWN BH
SHEET	C5.00

FOR PERMIT



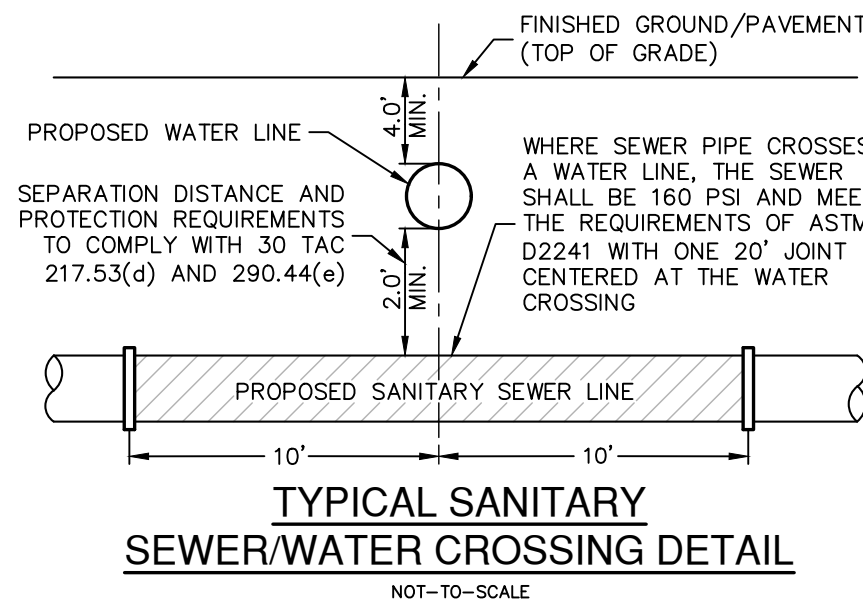

WASTEWATER (NBU JOB NO. WW-226996)		
ITEM	UNIT	QUANTITY
8" SANITARY SEWER PIPE	LF	11,445
LUES	EA	215
6" WASTEWATER SERVICE	EA	215
48" MANHOLES	EA	62

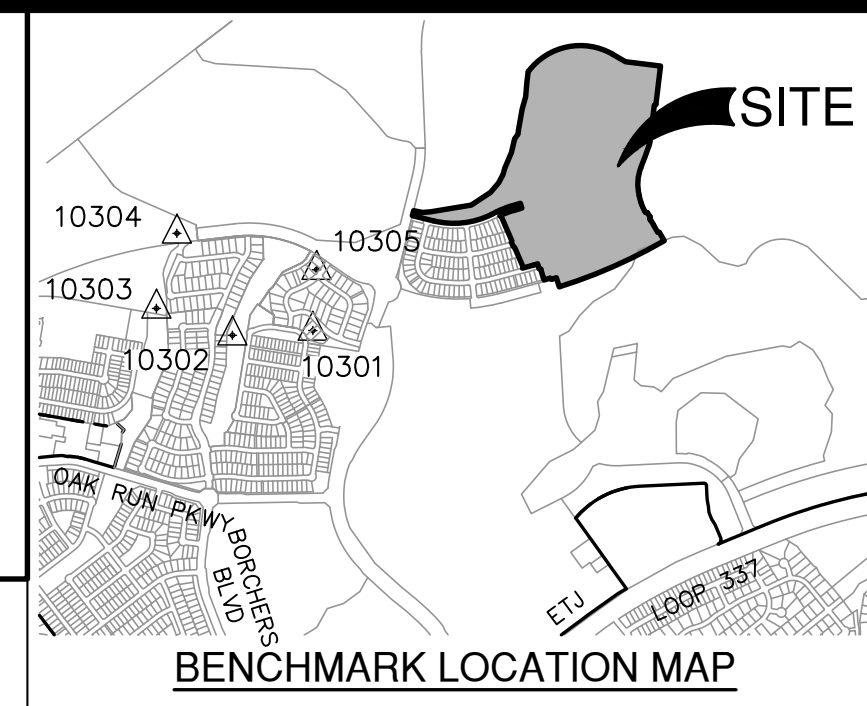
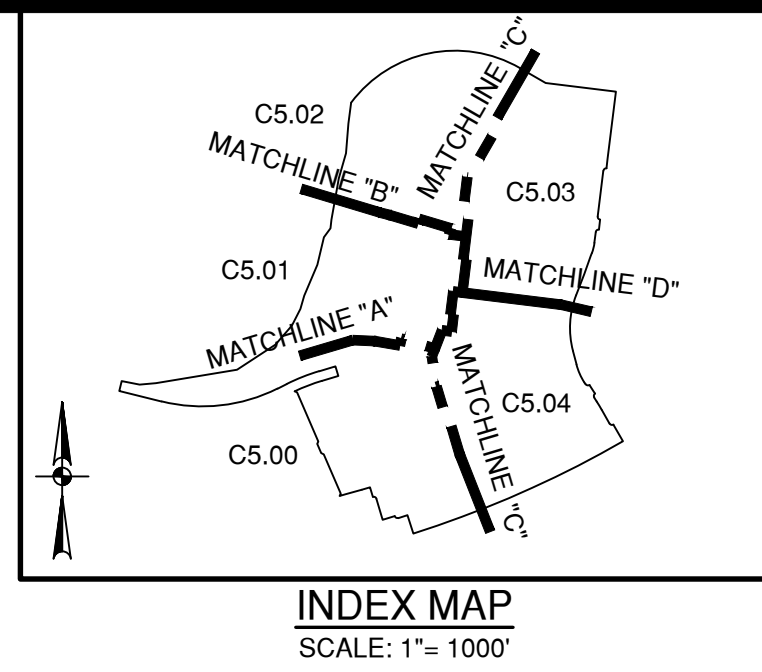

BENCHMARKS				
HORIZONTAL AND VERTICAL CONTROL POINTS				
Point #	Northing	Easting	Elevation	Full Description
10300	13819253.76	2237967.00	787.38	SET I.R. REDCAP (TRAV)
10301	13816937.43	2237678.90	782.13	SET I.R. REDCAP (TRAV)
10302	13816887.26	2236841.89	758.22	SET I.R. REDCAP (TRAV)
10303	13817166.65	2236050.01	763.76	SET MAG NAIL (TRAV)
10304	13817949.35	2236263.15	751.35	SET MAG NAIL (TRAV)
10305	13817569.78	2237177.86	753.14	SET MAG NAIL (TRAV)

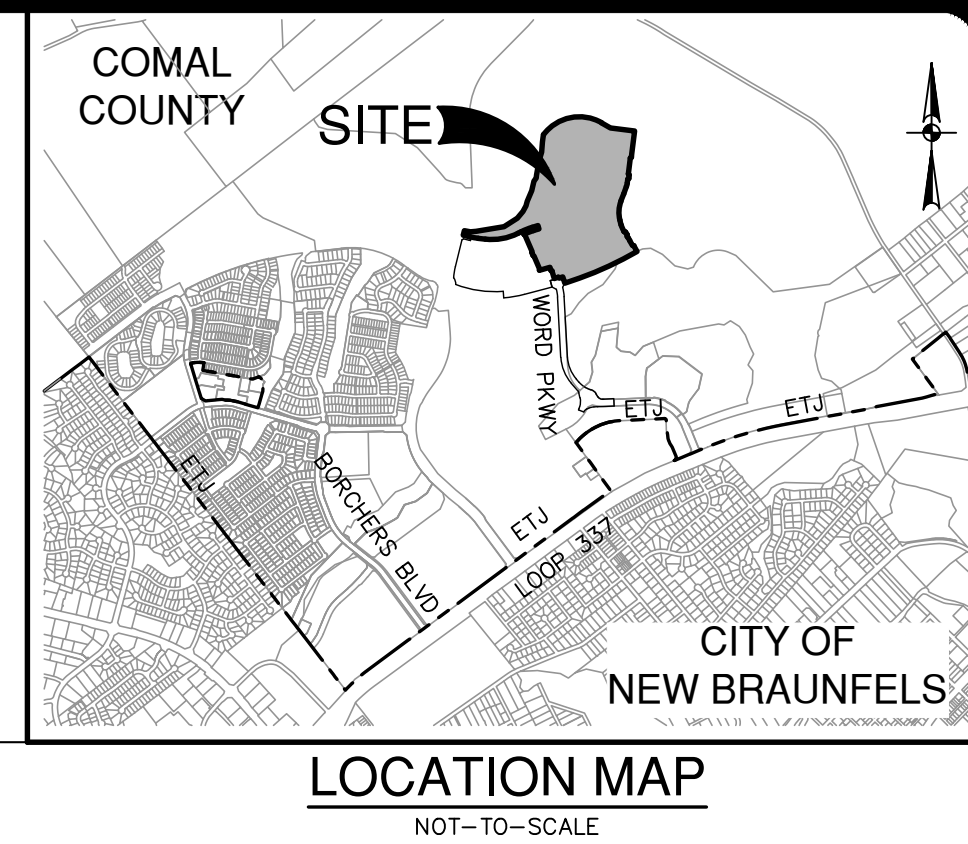

**SEWER LEGEND**

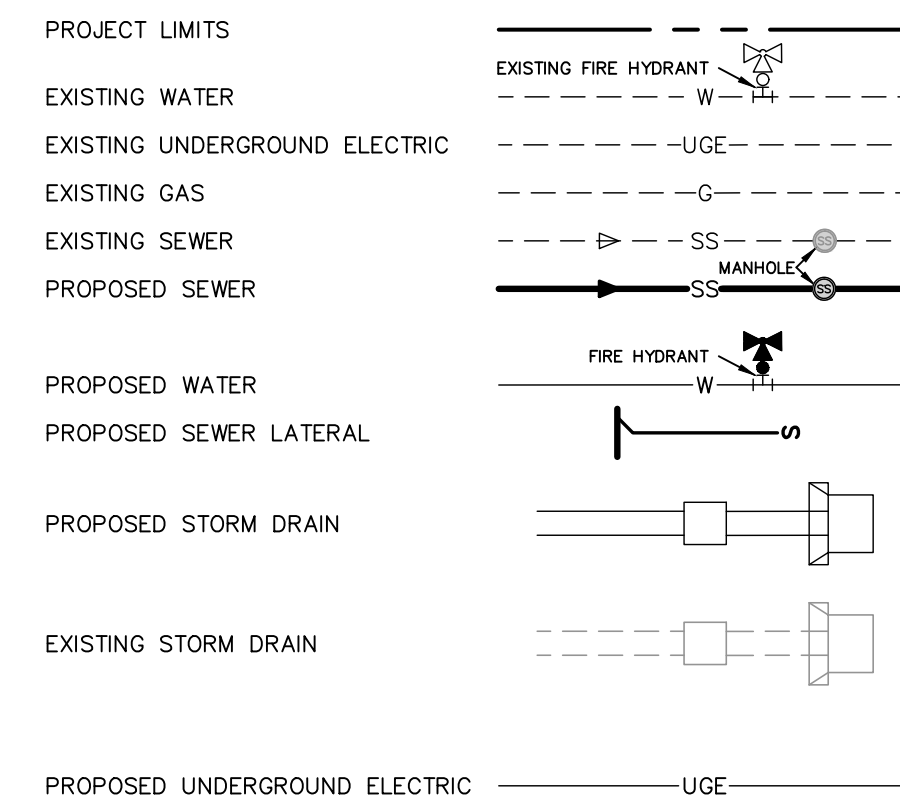

**FLOODPLAIN NOTE**

- NO PORTION OF ANY LOT ON THIS PROJECT IS WITHIN AN INDICATED SPECIAL FLOOD HAZARD ZONE ACCORDING TO THE FEMA FIRM MAP NO. 48091C0435F EFFECTIVE DATE 9/2/2009.

**CITY OF NEW BRAUNFELS NOTES**

- NO VALVES, HYDRANTS, ETC. SHALL BE CONSTRUCTED WITHIN CURBS, SIDEWALKS, OR DRIVEWAYS.
- ALL UTILITIES TO BE CONSTRUCTED PRIOR TO STREETS.
- THIS PROJECT INCLUDES UTILITY INSTALLATIONS GREATER THAN 5- FEET IN DEPTH. DEEP TRENCHES POSE COMPACTION TESTING AND CONSTRUCTION CHALLENGES AND CITY METHODS FOR TESTING AND COMPACTION MAY NOT BE ACHIEVABLE. A UTILITY COMPACTION PLAN WILL BE REQUIRED AND MUST BE SUBMITTED FOR APPROVAL TO CITY PRIOR TO UTILITY INSTALLATION.
- UTILITY TRENCH COMPACTION - ALL UTILITY TRENCH COMPACTION TESTS WITHIN THE STREET PAVEMENT/SIDEWALK SECTION SHALL BE THE RESPONSIBILITY OF THE DEVELOPER'S/GEOTECHNICAL ENGINEER. FILL MATERIAL SHALL BE PLACED IN UNIFORM LAYERS NOT TO EXCEED TWELVE INCHES (12") THICK. DETERMINE THE MAXIMUM LIFT THICKNESS BASED ON THE ABILITY OF THE COMPACTION OPERATION AND EQUIPMENT USED TO MEET THE REQUIRED DENSITY. EACH LAYER OF MATERIAL SHALL BE COMPACTED TO A MINIMUM 95% DENSITY AND TESTED FOR DENSITY AND MOISTURE IN ACCORDANCE WITH TEST METHODS TEX-113-E, TEX-114-E, TEX-115-E. THE NUMBER AND LOCATION OF REQUIRED TESTS SHALL BE DETERMINED BY THE GEOTECHNICAL ENGINEER AND APPROVED BY THE CITY OF NEW BRAUNFELS STREET INSPECTOR. AT A MINIMUM, TESTS SHALL BE TAKEN EVERY 200 LF FOR EACH LIFT AND EVERY OTHER SERVICE LINE. UPON COMPLETION OF TESTING THE GEOTECHNICAL ENGINEER SHALL PROVIDE THE CITY OF NEW BRAUNFELS STREET INSPECTOR WITH ALL TESTING DOCUMENTATION AND A CERTIFICATION STATING THAT THE PLACEMENT OF FILL MATERIAL HAS BEEN COMPLETED IN ACCORDANCE WITH THE PLANS. ADDITIONAL DENSITY TESTS MAY BE REQUESTED BY THE CITY OF NEW BRAUNFELS INSPECTOR.

**CAUTION!!**

CONTRACTOR SHALL BE REQUIRED TO LOCATE ALL PUBLIC OR PRIVATE UTILITIES INCLUDING BUT NOT LIMITING TO: WATER, SEWER, TELEPHONE AND FIBER OPTIC LINES, SITE LIGHTING ELECTRIC, SECONDARY ELECTRIC, PRIMARY ELECTRICAL DUCTWORK, LANDSCAPE IRRIGATION FACILITIES, AND GAS LINES. ANY UTILITY CONFLICTS THAT ARISE SHOULD BE COMMUNICATED TO THE ENGINEER IMMEDIATELY AND PRIOR TO CONSTRUCTION. THE CONTRACTOR SHALL CONTACT "TEXAS 811" A MINIMUM OF 48 HOURS PRIOR TO THE START OF CONSTRUCTION. ANY DAMAGE TO EXISTING UTILITIES SHALL BE THE SOLE RESPONSIBILITY OF THE CONTRACTOR AND THE REPAIR SHALL BE AT CONTRACTOR'S SOLE EXPENSE WHETHER THE UTILITY IS SHOWN ON THESE PLANS OR NOT.

**TRENCH EXCAVATION SAFETY PROTECTION:**

CONTRACTOR AND/OR CONTRACTOR'S INDEPENDENTLY RETAINED EMPLOYEE OR STRUCTURAL DESIGN/ GEOTECHNICAL/ SAFETY/EQUIPMENT CONSULTANT, IF ANY, SHALL REVIEW THESE PLANS AND ANY AVAILABLE GEOTECHNICAL INFORMATION AND THE ANTICIPATED INSTALLATION SITES WITHIN THE PROJECT WORK AREA IN ORDER TO IMPLEMENT CONTRACTOR'S TRENCH EXCAVATION SAFETY PROTECTION SYSTEMS, PROGRAMS AND /OR PROCEDURES FOR THE PROJECT DESCRIBED IN THE CONTRACT DOCUMENTS. THE CONTRACTOR'S IMPLEMENTATION OF THESE SYSTEMS, PROGRAMS AND/OR PROCEDURES SHALL PROVIDE FOR ADEQUATE TRENCH EXCAVATION SAFETY PROTECTION THAT COMPLY WITH AS A MINIMUM, OSHA STANDARDS FOR TRENCH EXCAVATIONS. SPECIFICALLY, CONTRACTOR AND/OR CONTRACTOR'S INDEPENDENTLY RETAINED EMPLOYEE OR SAFETY CONSULTANT SHALL IMPLEMENT A TRENCH SAFETY PROGRAM IN ACCORDANCE WITH OSHA STANDARDS GOVERNING THE PRESENCE AND ACTIVITIES OF INDIVIDUALS WORKING IN AND AROUND TRENCH EXCAVATION.

DATE: \_\_\_\_\_  
 NO. REVISION: \_\_\_\_\_

**PAPE-DAWSON ENGINEERS**  
 1672 INDEPENDENCE DR, STE 102 | NEW BRAUNFELS, TX 78132 | 800.632.5633  
 TEXAS ENGINEERING FIRM #470 | TEXAS SURVEYING FIRM #1008800

**VERAMENDI PRECINCT 18 UNIT 1**  
 NEW BRAUNFELS, TEXAS  
 OVERALL SANITARY SEWER PLAN

PLAT NO.	
JOB NO.	30001-66
DATE	07-03-2023
DESIGNER	GDL
CHECKED	✓ DRAWN BH
SHEET	C5.01

FOR PERMIT



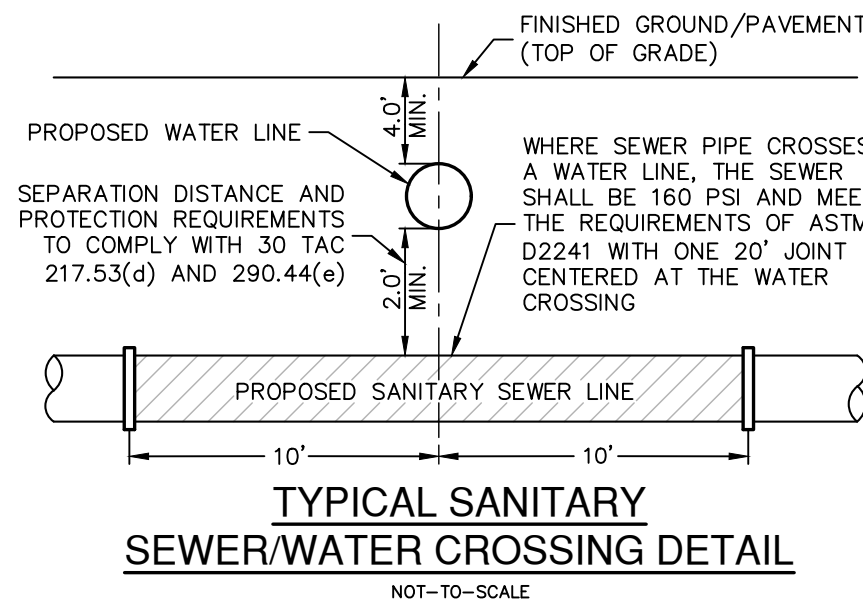

WASTEWATER (NBU JOB NO. WW-226996)		
ITEM	UNIT	QUANTITY
8" SANITARY SEWER PIPE	LF	11,445
LUES	EA	215
6" WASTEWATER SERVICE	EA	215
48" MANHOLES	EA	62

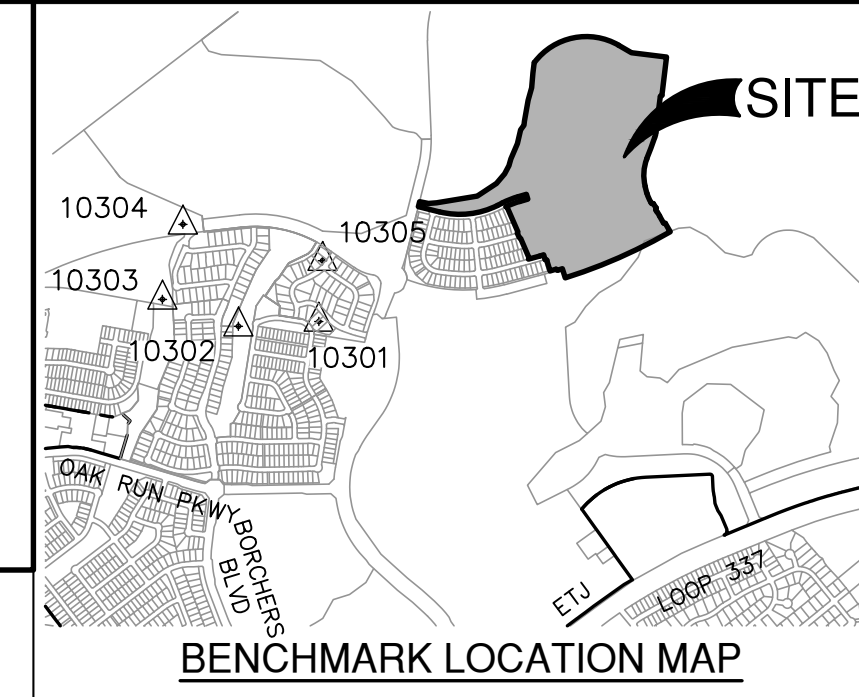
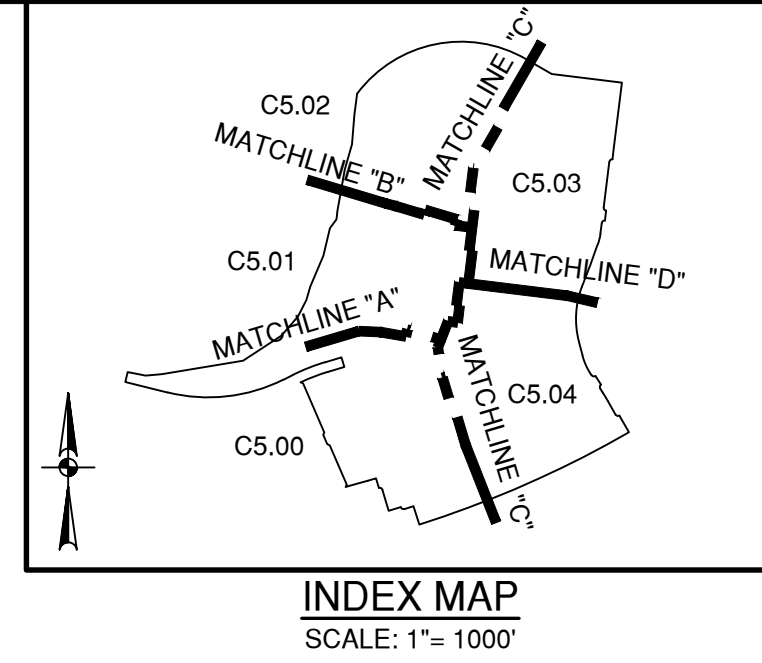

BENCHMARKS			
HORIZONTAL AND VERTICAL CONTROL POINTS			
Point #	Northing	Easting	Full Description
10300	13819253.76	2237967.00	SET I.R. REDCAP (TRAV)
10301	13816937.43	2237678.90	SET I.R. REDCAP (TRAV)
10302	13816887.26	2236841.89	SET I.R. REDCAP (TRAV)
10303	1381766.65	2236050.01	SET MAG NAIL (TRAV)
10304	13817949.35	2236263.15	SET MAG NAIL (TRAV)
10305	13817569.78	223717.86	SET MAG NAIL (TRAV)

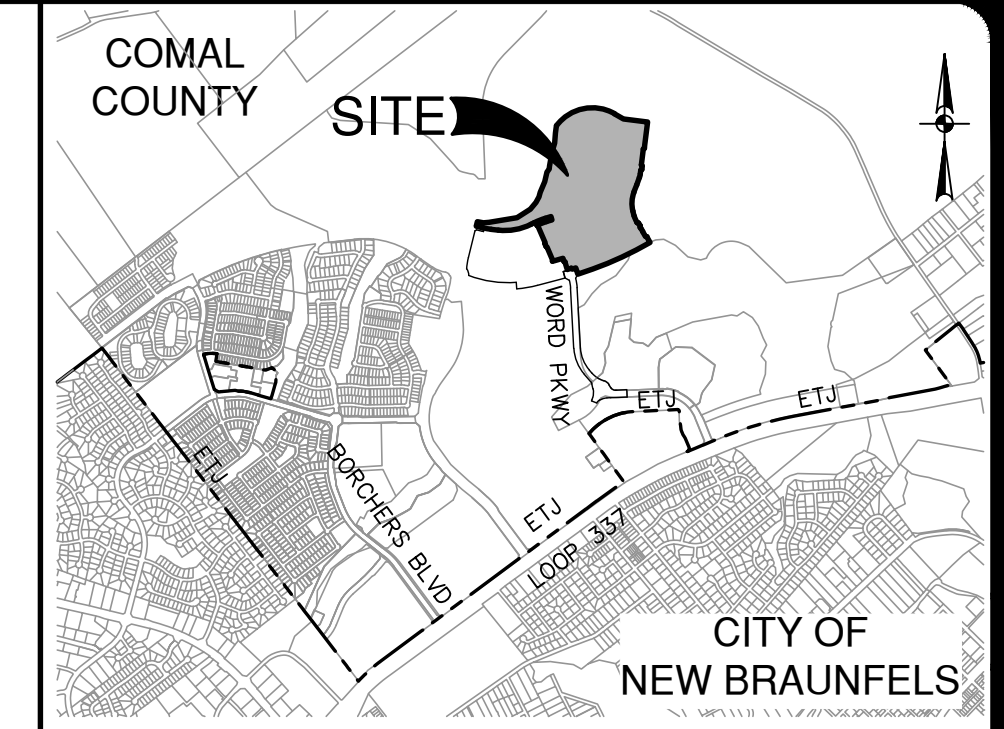

DATE: \_\_\_\_\_

NO. REVISION: \_\_\_\_\_

11-20-2023

STATE OF TEXAS  
 JOCELYN PEREZ  
 98367  
 PROFESSIONAL ENGINEER

*J. Pape-Dawson*

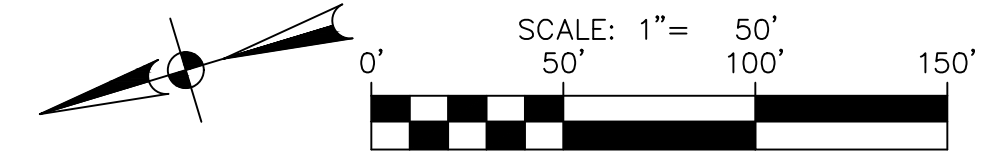

### SEWER LEGEND

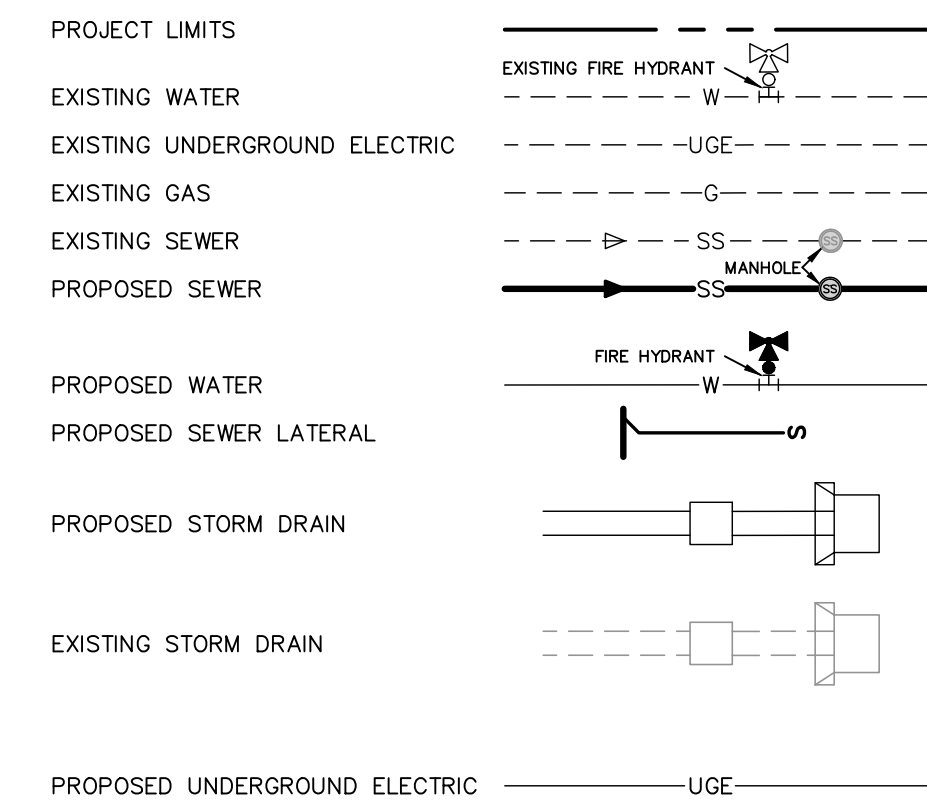

### FLOODPLAIN NOTE

1. NO PORTION OF ANY LOT ON THIS PROJECT IS WITHIN AN INDICATED SPECIAL FLOOD HAZARD ZONE ACCORDING TO THE FEMA FIRM MAP NO. 48091C0435F EFFECTIVE DATE 9/2/2009.

### CITY OF NEW BRAUNFELS NOTES

- NO VALVES, HYDRANTS, ETC. SHALL BE CONSTRUCTED WITHIN CURBS, SIDEWALKS, OR DRIVEWAYS.
- ALL UTILITIES TO BE CONSTRUCTED PRIOR TO STREETS.
- THIS PROJECT INCLUDES UTILITY INSTALLATIONS GREATER THAN 5- FEET IN DEPTH. DEEP TRENCHES POSE COMPACTION TESTING AND CONSTRUCTION CHALLENGES AND CITY METHODS FOR TESTING AND COMPACTION MAY NOT BE ACHIEVABLE. A UTILITY COMPACTION PLAN WILL BE REQUIRED AND MUST BE SUBMITTED FOR APPROVAL TO CITY PRIOR TO UTILITY INSTALLATION.
- UTILITY TRENCH COMPACTION - ALL UTILITY TRENCH COMPACTION TESTS WITHIN THE STREET PAVEMENT/SIDEWALK SECTION SHALL BE THE RESPONSIBILITY OF THE DEVELOPER'S GEOTECHNICAL ENGINEER. FILL MATERIAL SHALL BE PLACED IN UNIFORM LAYERS NOT TO EXCEED TWELVE INCHES (12") THICK. DETERMINE THE MAXIMUM LIFT THICKNESS BASED ON THE ABILITY OF THE COMPACTION OPERATION AND EQUIPMENT USED TO MEET THE REQUIRED DENSITY. EACH LAYER OF MATERIAL SHALL BE COMPACTED TO A MINIMUM 95% DENSITY AND TESTED FOR DENSITY AND MOISTURE IN ACCORDANCE WITH TEST METHODS TEX-113-E, TEX-114-E, TEX-115-E. THE NUMBER AND LOCATION OF REQUIRED TESTS SHALL BE DETERMINED BY THE GEOTECHNICAL ENGINEER AND APPROVED BY THE CITY OF NEW BRAUNFELS STREET INSPECTOR. AT A MINIMUM, TESTS SHALL BE TAKEN EVERY 200 LF FOR EACH LIFT AND EVERY OTHER SERVICE LINE. UPON COMPLETION OF TESTING THE GEOTECHNICAL ENGINEER SHALL PROVIDE THE CITY OF NEW BRAUNFELS STREET INSPECTOR WITH ALL TESTING DOCUMENTATION AND A CERTIFICATION STATING THAT THE PLACEMENT OF FILL MATERIAL HAS BEEN COMPLETED IN ACCORDANCE WITH THE PLANS. ADDITIONAL DENSITY TESTS MAY BE REQUESTED BY THE CITY OF NEW BRAUNFELS INSPECTOR.

### CAUTION!!

CONTRACTOR SHALL BE REQUIRED TO LOCATE ALL PUBLIC OR PRIVATE UTILITIES INCLUDING BUT NOT LIMITING TO: WATER, SEWER, TELEPHONE AND FIBER OPTIC LINES, SITE LIGHTING ELECTRIC, SECONDARY ELECTRIC, PRIMARY ELECTRICAL DUCTBANKS, LANDSCAPE IRRIGATION FACILITIES, AND GAS LINES. ANY UTILITY CONFLICTS THAT ARISE SHOULD BE COMMUNICATED TO THE ENGINEER IMMEDIATELY AND PRIOR TO CONSTRUCTION. THE CONTRACTOR SHALL CONTACT "TEXAS 811" A MINIMUM OF 48 HOURS PRIOR TO THE START OF CONSTRUCTION. ANY DAMAGE TO EXISTING UTILITIES SHALL BE THE SOLE RESPONSIBILITY OF THE CONTRACTOR AND THE REPAIR SHALL BE AT CONTRACTOR'S SOLE EXPENSE WHETHER THE UTILITY IS SHOWN ON THESE PLANS OR NOT.

### TRENCH EXCAVATION SAFETY PROTECTION:

CONTRACTOR AND/OR CONTRACTOR'S INDEPENDENTLY RETAINED EMPLOYEE OR STRUCTURAL DESIGN/ GEOTECHNICAL/ SAFETY/EQUIPMENT CONSULTANT, IF ANY, SHALL REVIEW THESE PLANS AND ANY AVAILABLE GEOTECHNICAL INFORMATION AND THE ANTICIPATED INSTALLATION SITES WITHIN THE PROJECT WORK AREA IN ORDER TO IMPLEMENT CONTRACTOR'S TRENCH EXCAVATION SAFETY PROTECTION SYSTEMS, PROGRAMS AND /OR PROCEDURES FOR THE PROJECT DESCRIBED IN THE CONTRACT DOCUMENTS. THE CONTRACTOR'S IMPLEMENTATION OF THESE SYSTEMS, PROGRAMS AND/OR PROCEDURES SHALL PROVIDE FOR ADEQUATE TRENCH EXCAVATION SAFETY PROTECTION THAT COMPLY WITH AS A MINIMUM, OSHA STANDARDS FOR TRENCH EXCAVATIONS. SPECIFICALLY, CONTRACTOR AND/OR CONTRACTOR'S INDEPENDENTLY RETAINED EMPLOYEE OR SAFETY CONSULTANT SHALL IMPLEMENT A TRENCH SAFETY PROGRAM IN ACCORDANCE WITH OSHA STANDARDS GOVERNING THE PRESENCE AND ACTIVITIES OF INDIVIDUALS WORKING IN AND AROUND TRENCH EXCAVATION.

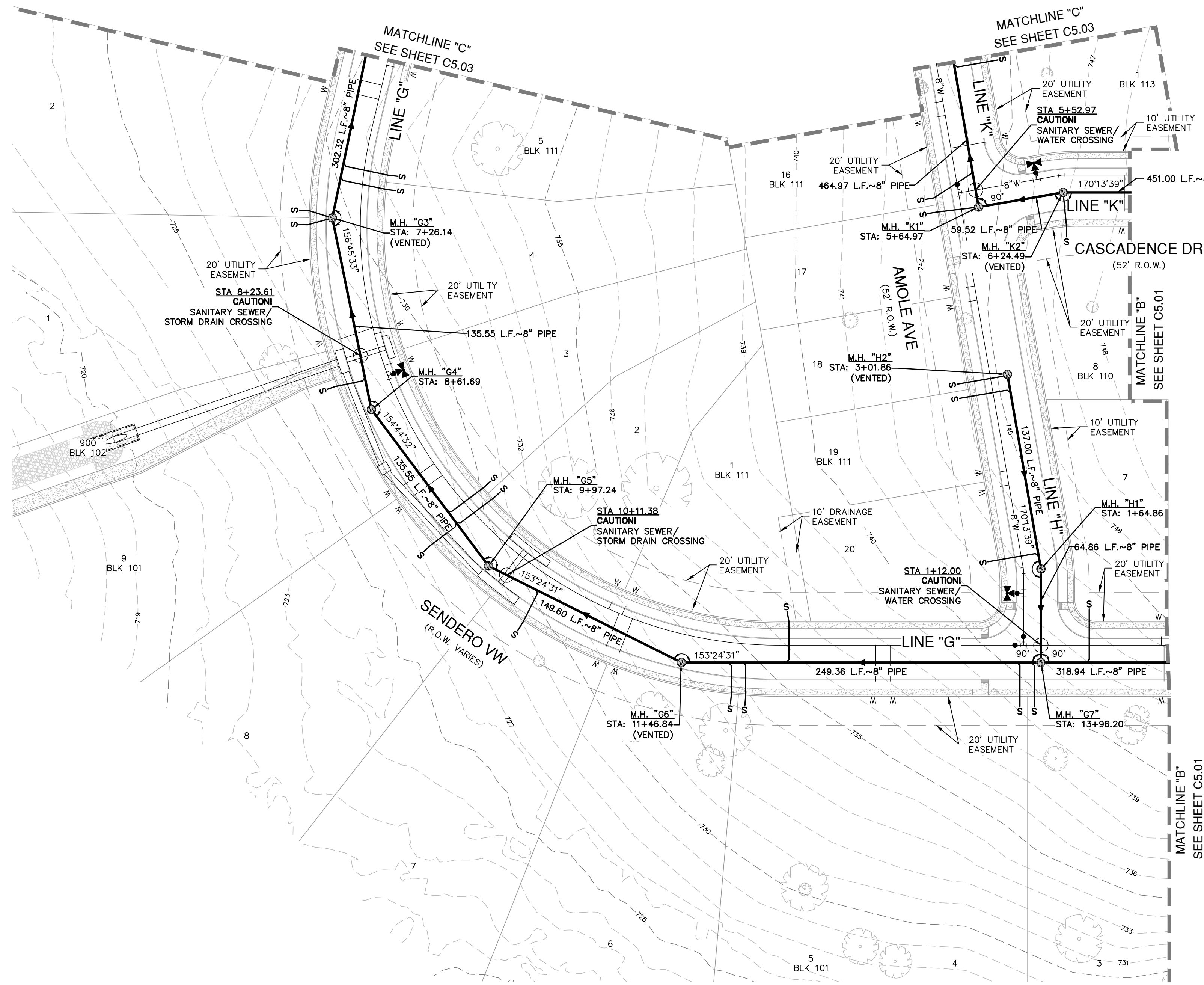

VERAMENDI PRECINCT 18 UNIT 1  
 NEW BRAUNFELS, TEXAS  
 OVERALL SANITARY SEWER PLAN

PLAT NO.	
JOB NO.	30001-66
DATE	07-03-2023
DESIGNER	GDL
CHECKED	✓ DRAWN BH
SHEET	C5.02

FOR PERMIT